

RPD 552

High-Power FM/AM/CD Receiver with Detachable Face

Autoradio AM/FM à Lecteur CD de Forte Puissance et à Face Amovible

Receptor FM/AM/Reproductor de CD de Alta Potencia y con Panel Extraíble

Rádio FM/AM/CD de Alta Potência

com Face Removível

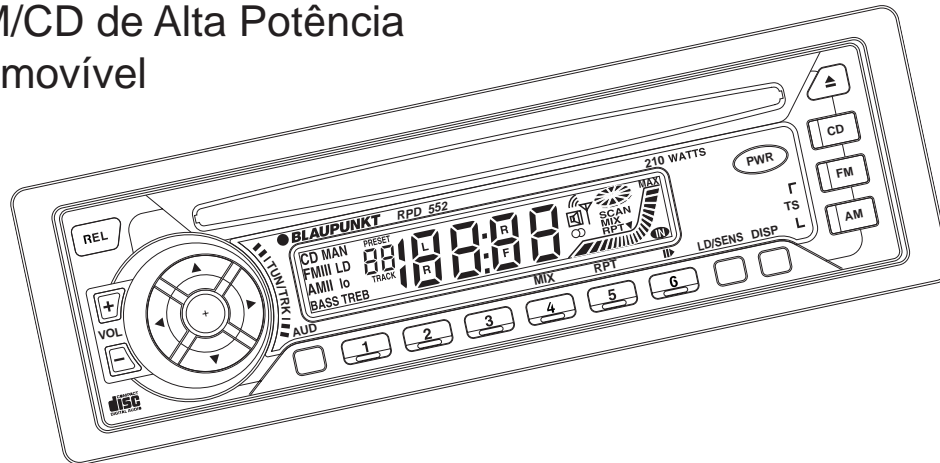

Robert Bosch Corporation
Sales Group —
Blaupunkt Division
2800 South 25th Avenue,
Broadview, Illinois 60155

 **BLAUPUNKT**[®]
Bosch Group

FCC WARNING

This equipment has been tested and found to comply with the limits for a Class B device, pursuant to Part 15 of the FCC Rules. These limits are designed to provide reasonable protection against harmful interference in a residential installation. This equipment generates, uses, and can radiate radio frequency energy, and, if not installed and used in accordance with instructions, may cause harmful interference with radio communications. However, there is no guarantee that radio interference will not occur in particular installation. If this equipment does cause harmful interference to radio or television reception, which can be determined by turning the equipment off and on, the user is encouraged to consult the dealer or an experienced radio/TV technician for help. You are cautioned that any changes or modifications not expressly approved in this manual could void your authority to operate this equipment.

Features

- Detachable front panel
- Built-in power amplifier
(max. output : 52.5W × 4ch)
- Digital 12-hour quartz clock
- FM/AM PLL synthesizer tuner
- 30 Station preset memory
- Auto Store / Scan tuning
- 2-ch preamp output

Precautions

- Carefully read this manual before using the unit. If you encounter any problems that are not covered in this manual, please consult the dealer where you purchased the unit or the dealer nearest to you.
- Avoid installing the unit where it would be subject to high temperatures, such as in direct sunlight or a hot air stream from the heater, or where it would be subject to dust, dirt, or excessive vibration.
- Do not turn on the unit if the temperature inside the car is very high. Always cool down the unit before usage. Parking your car in direct sunlight will result in a temperature rise.
- If the unit does not turn on, check the connections first. Then check whether the fuse at the back of the unit is blown.
- This unit has been designed specifically for playback of compact discs bearing the  mark. Other discs cannot be played.
- Do not use non-conventional discs such as heart-shaped, octagonal discs, etc. The player could be damaged.

Handling Compact Discs

- Be careful when removing a compact disc after the playback is completed because the disc may be extremely hot.
- Do not expose compact discs to direct sunlight or any direct heat source.
- Check all compact discs before playing, and discard cracked, scratched or warped discs.
- Wipe dirty or damp discs outward from the center with a soft cloth.
- Do not use any solvent such as commercially available cleaners, antistatic spray, or thinner to clean the compact discs.

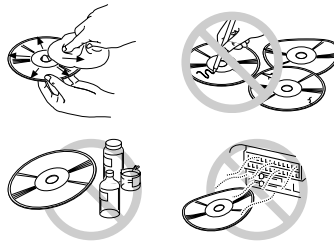

Handling the Front Panel

Attaching the Front Panel

Place the right hand side of the front panel so that the parts (A) of the front panel are engaged with the parts (B) of the unit as shown below. Then push the left hand side of the front panel until it is securely locked.

Detaching the Front Panel

Remove the CD from the unit, if any, and turn off the power of the unit.

Press the (REL) to unlock the front panel from the unit. Grasp the front panel as shown below and remove it from the unit.

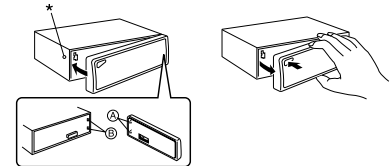

Security

To avoid theft or loss of the front panel, you can deactivate the release button (REL) by installing the locking screw provided.

1. Unscrew the bolt marked * at the left front side of the unit. (See diagram above)
2. Attach the front panel.
3. Select a locking screw from the mounting hardware (See page 6) and screw it into the same hole to fasten the front panel.

Notes

- Do not press hard on the front panel when affixing it to the unit. No more than light to moderate pressure should be needed.
- Make sure there is no dust or dirt on the electrical terminals on the back of the front panel as this could cause intermittent operation or other malfunctions.

Identification of Controls

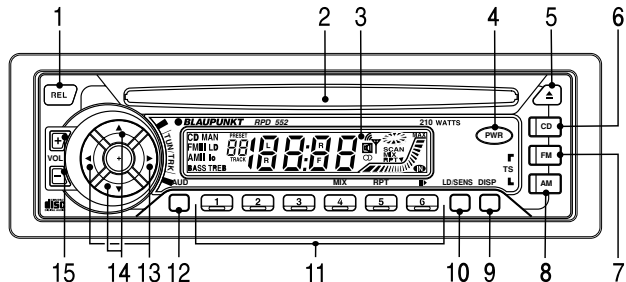

- 1 REL button**
Releases the detachable front panel.
- 2 CD insertion slot**
Insert the CD here.
- 3 LCD Display window**
- 4 PWR button**
Turns the power of the unit on. Mute on/off during power on.
Press for more than 2 seconds to turn off.
- 5 Eject ▲ button**
Ejects the CD.
- 6 CD button**
Switches the CD playback mode.
- 7 FM button**
Selects the FM Band & FM Travel store.
- 8 AM button**
Selects the AM Band & AM Travel store.
- 9 DISP button**
Display selector. Clock adjustment.
- 10 LD/SENS button**
Switches the reception sensitivity between local and distance.
Loudness on/off.
- 11 PRESET MEMORY button**
During radio reception :
① - ⑥ ; For Preset memory
During CD mode :
④/MIX ; For Mix play
⑤/RPT ; For Repeat play
⑥/P ; For Pause
- 12 AUD button**
Audio control selector; Bass, Treble, Balance, Fader & Mute level.
Mute level is selectable.
- 13 ◀ / ▶ button**
Used to tune in to the desired station.
Adjusts the bass/treble/balance.
- 14 ▲ / ▼ button**
Scan/Prescan tuning. Scan play in CD mode.
Adjusts the bass/treble/fader.
- 15 VOL + / - button**
Adjusts the volume and mute level.
Mute is adjustable from 0 to -80.

General Operations

Power On/Off

Turning on the power

Press the **(PWR)** to turn on the unit.

Turning off the power

Press the **(PWR)** for more than 2 seconds.

Setting the Clock

The clock uses a 12-hour display system.

1. Turn the ignition key to the ON position.
2. Press the **(PWR)** to turn on the unit.
3. Press the **(DISP)** and hold 2 seconds to start. Use the following buttons to set the clock. (The blinking section can be adjusted.)
 - (▲) / (▼)** : Adjust the Hour and minute
 - (◀)** : To activate Hour blink
 - (▶)** : To activate Minute blink
4. Press the **(DISP)** to activate the clock.

Ignition-off Clock Call

The display will illuminate showing the time and then automatically shut off after 5 seconds. Briefly press the **(DISP)** while the ignition switch is in the "OFF" position to activate.

Display Selector

Each time the **(DISP)** is pressed, the display window will change as shown below;

- **Radio mode**
Frequency and Clock.
- **CD mode**
Elapsed track time and clock.

Volume Level Control

Press the **(VOL +/-)** to adjust the volume level.

- (+)** : Volume up
- (-)** : Volume down.

You can check the volume level visually with the indicators in the display window.



Muting the Sound

Briefly press **(PWR)** while the receiver is on. While muting the sound, the MUTE indicator **(M)** on the display is blinking. To restore the previous volume level, press **(PWR)** again.

Loudness Effect

When listening to music at low volume levels, this feature will boost the extremes of the bass and treble ranges to compensate for the negative characteristics of human hearing.

Press the **(LD/SENS)**. The "LD" indicator appears in the display window. Pressing this button again will cancel this feature.

Adjusting the Sound Characteristics

1. Press the **(AUD)** to select the desired adjustment mode. BASS → TREBLE → BALANCE & FADER → Mute level
2. Press the following buttons to adjust the selected item. Make the adjustment within 5 seconds after selecting. After 5 seconds, the display window will revert to previous indication.

	Adjustment Range			
BASS	(◀) (▼)	BASS -7	BASS 7	(▲) (▶)
TREBLE	(◀) (▼)	TREB -7	TREB 7	(▲) (▶)
BALANCE	(◀)	L 9 (Full left)	R 9 (Full right)	(▶)
FADER	(▲)	F 9 (Full front)	R 9 (Full rear)	(▼)
MUTE LEVEL	(▼)	(-80)	(-0)	(▲)

You can check the each level visually with the indicators in the display window.

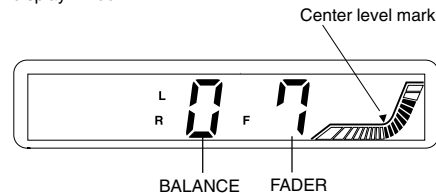

Seek Tuning

1. Press the **AM** or **FM** to select the desired band.
FM I → FM II → FM III
or
AM I → AM II
2. Press the **◀** or **▶** to tune in stations. Seek tuning automatically stops at a broadcasted frequency. When tuning to FM stereo broadcasting stations, the "◐" stereo indicator will light up in the display window.

Manual Tuning

1. Press the **AM** or **FM** to select the desired band.
2. Press the **◀** or **▶** and hold for more than 0.5 second to activate the manual tuning mode. Press again to tune in to stations.
After 4 seconds duration of completing Manual Tuning, the tuning control will revert to the Seek Tuning mode.

Scan Tuning

1. Press the **AM** or **FM** to select the desired radio band.
2. Press the **▲**.
The unit will scan the selected radio band for stations. Press the **▲** again to stop Scan Tuning and remain on this selected frequency.

Tips

When tuned in to broadcasting stations, the antenna indicator  on the display window is lit.

Preset Scan Tuning

1. Press the **AM** or **FM** to select the desired radio band.
2. Press the **▼**.
The unit will scan preset memory for the 12 stations from the AM I/AM II band or the 18 stations from the FM I or FM II and FM III bands. The unit will stop at each preset station for 8 seconds, before continuing to the next preset station.
Press the **▼** again to stop Preset Scan Tuning and remain this on the selected frequency.

Memorizing Stations Automatically (Travel Store)

1. Press the **AM** or **FM** to select the desired band.
2. Hold the **AM** or **FM** pressed for longer than 2 seconds.
Up to 6 stations with strong signals will be automatically stored in preset memory for the selected band.

Note

This function is available for FM III and AM II.

Memorizing Only the Desired Stations

A total of 30 stations (18 for the FM I, FM II and FM III, 12 for AM I and AM II) can be stored in preset memory.

1. Press the **AM** or **FM** to select the desired radio band.
2. Press the **◀** or **▶** to tune in stations.
3. Press and hold the desired preset memory button **1** - **6** for about 2 seconds until the frequency indicator flashes twice.
The number of the pressed preset memory button appears on the display window.

Note

If/when you store another station on the same preset number button, the previously stored station is replaced with new one.

Receiving the Memorized Stations

1. Press the **AM** or **FM** to select the desired radio band.
2. Press the **1** - **6** momentarily.

Local/Distant (LO/DX) Selection

This feature is used to select the strength of the signals at which the radio will stop during Seek Tuning.

Press the **LD/SENS** for more than 2 seconds to select the Local setting and only the strongest (local) stations will be received. The "lo" indicator appears in the display window. Pressing again for 2 seconds will select the Distant setting and the radio will stop at a wider range of signals, including weaker more distant stations. The "lo" indicator will go out on the display window.
The "Distant" setting is the recommended default mode of reception.

CD Operations

Playing the CD player

Loading Discs

Insert the disc into the CD insertion slot with the labeled side facing up.

“**IN**” indicator will light up in the display window and playback begins automatically.

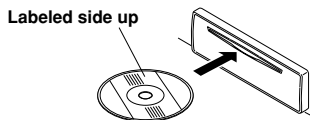

■ NEVER Insert 3-inch CD's.

This unit is designed for playback of standard 5-inch CD's only. Do not attempt to use 3-inch CD singles in this unit, either with or without an adaptor, as damage to the player and/or disc may occur.

Tip/FYI

During playback of a CD, the pie-shaped indicator  spins.

Listening to a disc that is already loaded

Press the **CD** to select the CD mode.
Playback begins automatically.

Pausing Playback

Press the **STOP**.
To resume playback, press the **STOP** again.

Stopping Playback

Press the **AM** or **FM** to select the radio reception.

Ejecting Discs

Press the **EJECT** to eject the disc.

Note

The unit will turn-on automatically when a CD is inserted if the ignition switch is "ON".

Playing a CD in various modes

Track Search

Press the **LEFT** or **RIGHT** during CD mode. Track numbers appear in the display window.

- RIGHT** : Playback starts from the beginning of the next track.
- LEFT** : Playback starts from the beginning of the current track.
Press again to play the previous track.

Cue / Review

Press and hold the **LEFT** or **RIGHT** during CD mode.
Release when you have found the desired point.

- RIGHT** : To search forward.
- LEFT** : To search backward.

Scan Play

Press the **SCAN** during CD mode.
The "SCAN" indicator appears in the display window. This will play the first 10 seconds of all the tracks on the disc.
Press the **SCAN** again to cancel this feature.

Repeat Play

Press the **SRPT** during CD mode.
The "RPT" indicator appears in the display window and the current track is played repeatedly.
Press the **SRPT** again to cancel this feature.

MIX Play

Press the **4MIX** during CD mode.
All the tracks on the current disc are played in random order.
Press the **4MIX** again to cancel this feature.

Supplied Mounting Hardware

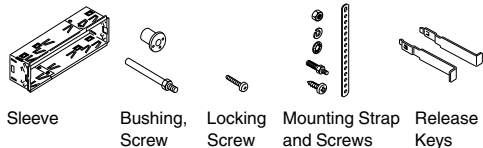

Precautions

- Be sure to remove/detach the front panel before you start installing the unit.
- Choose the mounting location carefully so that the unit will not interfere with the normal driving operations of the driver.
- Use only the supplied mounting hardware for a safe and secure installation.
- Handle the sleeve carefully to avoid injuring your fingers.
- When mounting the unit in a car, keep the unit as level as possible. If the unit must be mounted at an angle, due to the design of the vehicle, make sure that the unit does not tilt upward by more than 30°.

Mounting Example

Installation in the dashboard.

1. Install the sleeve in the dashboard.

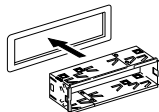

2. Select and bend the appropriate tabs to hold the sleeve firmly in place.

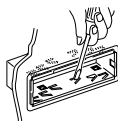

Mounting Strap Use *

3. Attaching the Mounting Strap to the underside of the dashboard, using screw. Attach the back of the unit to the Mounting Strap using the support stem bolt and hardware.

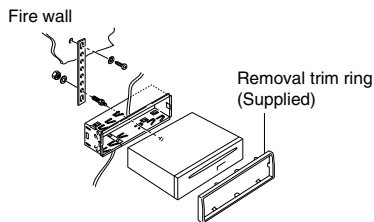

Bushing Use *

3. As shown in the figure below, securely fasten the screw, which has been inserted into the bushing, at the rear of the unit.

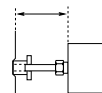
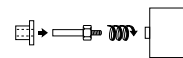
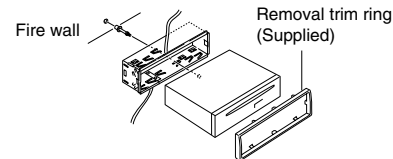

The distance to the fire wall varies due to the type of the car. Be sure to secure the unit by properly inserting the bushing.



Caution

Insufficient fastening of the screw may cause some CD's to skip.

* Warning

Failure to properly install the Mounting Strap or rear support Bushing is a major cause of CD skipping. Without these securing devices, the chassis of the CD receiver is able to move up & down whenever the road has imperfections and CD skipping results.

Note

Some Japanese/Asian vehicles such as TOYOTA & NISSAN do not require use of the sleeve and trim ring assembly. To secure the replacement radio use the O.E.M. brackets and mounting screws. These brackets will align with the threaded screw holes found on each side of the new radio.

Connections

Warning

- To prevent short circuit, remove the key from the ignition and disconnect the battery's (-) terminal.
- This unit is designed for negative ground 12 V DC operation only. You can not use it for 24 V or other types of car batteries.

Connection procedure

Caution

- DO NOT connect any speaker wires to the metal body or chassis of the vehicle.
- DO NOT connect the speaker common (-) wires to each other.
- Connect each speaker wire directly to each speaker terminal.
- All speaker common (-) wires must remain floating.
i.e. No Common Connections or connections to vehicle grd \perp .
- Connect each pair of speaker leads only to a single speaker (or speaker system) that has an impedance of least 4 ohms, as well as 50-watt power-handling capability.
- Do not connect speaker leads to any inputs on external amplifiers. This will cause damage to the internal amplifier of this unit.

- 1 Make sure the car's ignition key has been removed.
- 2 Disconnect the negative (-) terminal of the car's battery.
- 3 Connect the wiring harness wires in the following order : Ground wire (Black), +12V Constant Power Supply (Yellow), +12V Accessory/Switched (Red) and Power Antenna/Amplifier Turn On (Blue), and tape each so they do not come in contact with each other.
- 4 Connect the speaker wires of the wiring harness.
- 5 Connect the car's antenna terminal to the antenna socket of the unit.
- 6 Connect the detachable wire harness to the unit.
- 7 Reconnect the negative (-) terminal of the car's battery.
- 8 Start the car's engine.
- 9 Make sure the unit operates properly.

Connection procedure

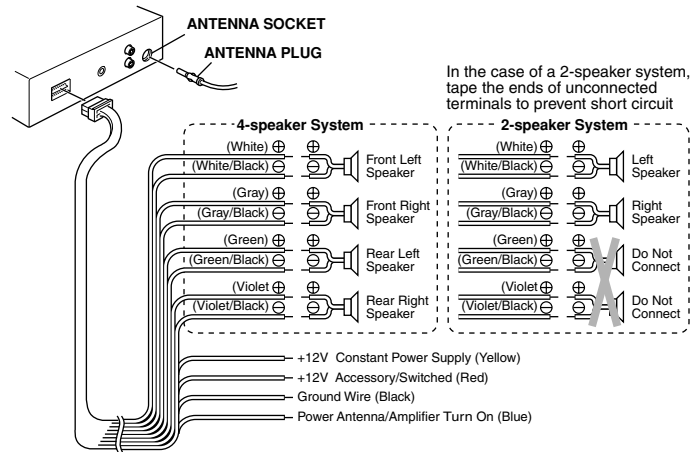

Preamp Out/Line Out Connections

- Since this unit has Line Level Outputs, you can use an amplifier to upgrade your vehicle stereo system.

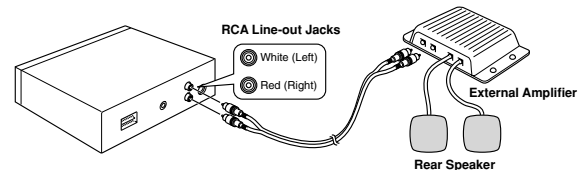

RCA Line-out Jacks (For Rear Speakers)

- Connect a patch cable (not supplied) from the White (left rear channel) and Red (right rear channel) RCA line output jacks of the unit to the line input terminals of the external amplifier.

Replacing the Fuse

If the fuse is blown, check the power connection first and then replace the fuse. If the fuse blows again under normal conditions, the unit may be defective.

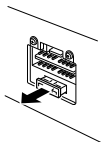

Back of the unit

Warning

Use only a fuse with the specified amperage (10 A).

Use of another type of fuse can result in a fire or unit damage.

Cleaning the Connectors

If the connectors of the unit and the front panel are contaminated, malfunctions may occur.

Detach the front panel and clean the connectors with an alcohol dampened cotton swab as shown below.

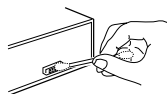

Main unit

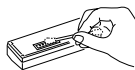

Back of the front panel

Returning to the Initial Settings

When the reset button is pressed, the microcomputer of the unit returns to the initial settings. If the display window is not properly shown or the unit malfunctions, press the reset button with the point of a sharp object such as a ball-point pen.

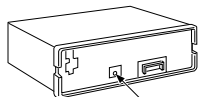

Reset button

Removing the Unit

Use the supplied release keys when you need to remove the unit from the car.

Insert them into the unit as shown below. This will unlock the unit from the sleeve, allowing for removal of the unit.

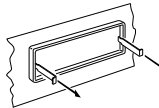
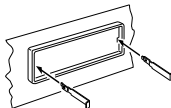

Notes

- Handle the release keys carefully to avoid injuring your fingers.
- Keep the release keys in a safe place for future use.

Troubleshooting Guide

The following check will assist in the correction of most problems which you may encounter with your unit. Before going through the check list below, refer back to the connection and operating procedures.

General

Trouble	Cause/Solution
<ul style="list-style-type: none"> Memorized stations and correct time are erased. The fuse has blown. Radio works when the ignition key is in the ON, ACC and OFF positions. 	Leads are not matched correctly with the car's accessory power connector. Check wiring for short circuits.
<ul style="list-style-type: none"> No power is being supplied to the unit. 	The car doesn't have an ACC position.
<ul style="list-style-type: none"> The power is continuously supplied to the unit. 	

Radio reception

Trouble	Cause/Solution
Preset stations are not receivable.	The broadcast signal is too weak.
Seek tuning is not possible.	The broadcast signal is too weak. → Use manual tuning.
Travel Store feature does not complete storing of six stations	Not enough broadcast frequencies are receivable.

Also make sure that antenna is connected, extended and dry inside.

If the above mentioned solutions do not help to improve the situation, consult your nearest **Blaupunkt** dealer or in the United States call 1-800-266-2528 for technical assistance, parts and service. Call 1-800-950-2528 for dealer referral or to request product brochure.

CD Player Troubleshooting

When problems occur with CD playback, an error message appears in the display window. Refer to the table below to identify the problem, then take the suggested corrective action. If the error persists, contact your nearest **Blaupunkt** dealer.

Message	Possible cause	Recommended action
E-01	Dirty disc. Scratched disc. Up-side-down.	Clean the disc. Replace the disc. Check the disc.
E-02	Focus error.	Try ejecting and re-inserting under normal temperature conditions.
E-03	Data and focus error.	Under normal temperature conditions, eject and insert clean, undamaged disc properly.
E-04	Mechanical problem.	Eject and re-insert.

Specifications

GENERAL

Dimensions	: Approx. 178 mm × 50 mm × 155 mm (W × H × D)
Power requirements	: 12 volts DC car battery (negative ground)
Output Power	: 52.5 watts × 4 channels
Output Wiring	: Floating-ground type designed for 2 or 4 speaker use. RCA low-level outputs (2 channels).
Output Impedance	: Compatible with 4-8 ohm speakers.
Low - Level Output	: 2V.

TUNER

Tuning Range	: AM : 530 - 1, 710 kHz (10 kHz step) FM : 87.5 - 107.9 MHz (200 kHz step)
Sensitivity	: AM : 20 μV FM : 1.5 μV
FM Stereo Separation	: 30 dB

CD PLAYER

Frequency Response	: 20 - 20,000 Hz
S/N Ratio	: 98 dB
Wow & Flutter	: Below the measurable limit

Free Manuals Download Website

<http://myh66.com>

<http://usermanuals.us>

<http://www.somanuals.com>

<http://www.4manuals.cc>

<http://www.manual-lib.com>

<http://www.404manual.com>

<http://www.luxmanual.com>

<http://aubethermostatmanual.com>

Golf course search by state

<http://golfingnear.com>

Email search by domain

<http://emailbydomain.com>

Auto manuals search

<http://auto.somanuals.com>

TV manuals search

<http://tv.somanuals.com>