

**BLOOMFIELD INDUSTRIES**

2 ERIK CIRCLE, P. O. Box 280  
Verdi, NV 89439  
telephone: 775-689-5700  
fax: 888-492-2783  
www.wellsbloomfield.com

**OWNERS MANUAL  
for**

**SS2 - SERIES  
DUAL SATELLITE  
COFFEE BREWERS  
with  
ELECTRONIC  
PROGRAMMABLE  
CONTROL  
and  
INTERNALLY HEATED  
SATELLITE SERVERS**

**MODELS:**

**9520 9520FB  
9521 9521FB**

**Includes:**

**Installation  
Operation  
Use & Care  
Servicing Instructions**

*Model 9520 Dual Satellite Brewer  
with optional  
3901 Drip Tray*

PRINTED IN UNITED STATES OF AMERICA

**NOTE:** For your protection, please note that equipment in this shipment was carefully inspected and packaged by skilled personnel before leaving the factory. Upon acceptance of this shipment, the transportation company assumes full responsibility for its safe delivery.

**IF SHIPMENT ARRIVES DAMAGED:**

1. **VISIBLE LOSS OR DAMAGE:** Be certain that any visible loss or damage is noted on the freight bill

## TABLE OF CONTENTS

WARRANTY STATEMENT	xi
SPECIFICATIONS	1
FEATURES & OPERATING CONTROLS	2
PRECAUTIONS & GENERAL INFORMATION	4
AGENCY APPROVAL INFORMATION	4
INSTALLATION	5
OPERATING INSTRUCTIONS	7
CLEANING INSTRUCTIONS	10
PROGRAMMING INSTRUCTIONS	12
TROUBLESHOOTING SUGGESTIONS	17
SERVICING INSTRUCTIONS	18
EXPLODED VIEWS / PARTS LISTS	20
WIRING DIAGRAM	24

Thank You for purchasing this Bloomfield Industries appliance.

Proper installation, professional operation and consistent maintenance of this appliance will ensure that it gives you the very best performance and a long, economical service life.

This manual contains the information needed to properly install this appliance, and to use, care for and maintain or repair the appliance in a manner which will ensure its optimum performance.

## SPECIFICATIONS

MODEL	VOLTS	WATTS	AMPS	POWER CORD
9520 9520FB	120/208 VAC 50/60 Hz 1ø	5655W	27A	not provided
9521 9521FB	120/240 VAC 50/60 Hz 1ø	6680W	28A	not provided

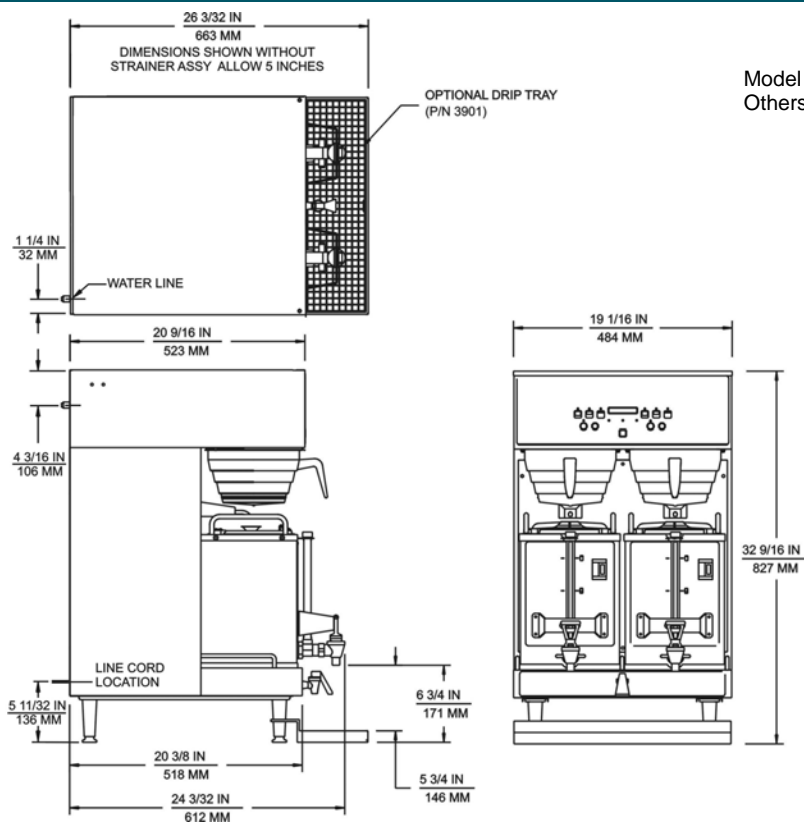

Model 9520FB shown  
Others are similar

672 74345 Owners Manual Dual Satellite 9520/9521



## FEATURES AND OPERATING CONTROLS (continued)

### Brewer

Adjustable Legs	Allows brewer to be leveled. Also allow clearance for cleaning underneath brewer.
Brewing Controls	Start or stop brew and select brew volume. Right and left section are independent. Also, used to program brewer in programming mode.
Connector	Connects to satellite. Allows satellite heater to be energized. Allows brewer to sense that a satellite is in place.
Digital Readout	Displays information pertaining to brew cycle and status. Displays programming information in programming mode.
Bypass Nozzle	Dilution water flows into satellite from here.
Hot Water Faucet	Hot water dispensed here. Mounted in base on FB models.
Nameplate	Lists manufacturer, model and serial number. Also lists voltage and wattage rating of brewer.
Power Key	Controls brewer <i>ON MODE</i> and <i>OFF MODE</i> .
Power Switch	Located on lower right rear of brewer. Turns main power to brewer <i>ON</i> or <i>OFF</i> .

### Brew Chamber

Brew Chamber	Holds coffee grounds during brew cycle.
Wire Rack	Holds paper filter and coffee grounds in proper position in brew chamber.

### Satellite

Brew-Thru Lid	Allows entry of brewed coffee and dilution water into satellite. Minimizes splashing in the event satellite is tipped.
Connector	Connects to brewer. Allows heater to be energized. Allows brewer to sense that a satellite is in place.
Handles	Allow the satellite to be safely carried.
Nameplate	Lists manufacturer, model and serial number. Also lists voltage and wattage rating of satellite.
Serving Faucet	Fresh coffee dispensed from satellite here.
Sight Glass	Check the level of coffee remaining here.

### Drip Tray (optional)

Optional drip tray catches drips and spills from serving faucet. Easily removed for cleaning.

## GENERAL INFORMATION AND PRECAUTIONS



### **WARNING:** **Electric** **Shock hazard**

All servicing requiring access to non-insulated electrical components must be performed by a factory authorized technician.

DO NOT open any access panel which requires the use of tools. Failure to follow this warning can result in severe electrical shock.

This appliance is intended for use in commercial establishments only.

This appliance is intended to brew hot beverage, specifically coffee, for human consumption. No other use is recommended or authorized by the manufacturer or its agents.

Operators of this appliance must be familiar with the appliance use, limitations and associated restrictions. Operating instructions must be read and understood by all persons using or installing this appliance.

Cleanliness of this appliance is essential to good sanitation. Read and follow all included cleaning instructions and schedules to ensure the safety of the food product.

Surfaces of the brewer, brew basket and satellite can be hot to the touch, and may cause burns on contact.

Disconnect the brewer from electrical power before performing any maintenance or servicing.



### **CAUTION:** **Burn Hazard**

Surfaces of this brewer can be hot and can cause burns on contact.

DO NOT submerge satellites in water.

DO NOT splash or pour water over, onto or into any controls, control panel or wiring.

Any procedure which requires the use of tools must be performed by a qualified technician.

This manual is considered to be a permanent part of the appliance. This manual and all supplied instructions, diagrams, schematics, parts breakdown illustrations, notices and labels must remain with the appliance if it is sold or moved to another location.

This appliance is made in the USA. Unless otherwise noted, this appliance has American sizes on all hardware.

## AGENCY APPROVAL INFORMATION



E9253



E9253



STD 4

This dual satellite brewing system is  listed under E9253

and  listed under E9253.

This dual satellite brewing system meets NSF Standard 4 only when installed and maintained per the instructions in this manual.

## INSTALLATION INSTRUCTIONS

### INSTALL LEGS

The brewer is provided with adjustable legs and rubber feet. Be sure the legs are securely screwed into the base of the brewer, and that the rubber feet are properly installed.

### LEVEL THE UNIT

The adjustable legs allow the brewer to be leveled. Set the brewer in its ultimate operating location and check for level with a spirit level. Adjust the brewer for level from front-to-rear, and from side-to-side. Be sure all four feet rest firmly on the counter.

### PLUMBER'S INSTALLATION INSTRUCTIONS

#### IMPORTANT:

This equipment must be installed in accordance with the Basic Plumbing Code of the Building Officials and Code Administrators International (BOCA), and the Food Service Sanitation Manual of the Food and Drug Administration (FDA). Also, this equipment installation must comply with all local codes and ordinances.

Brewer must be installed on a water line with a full-flow pressure between 20 psi and 90 psi.

**NOTE:** If water pressure varies greatly, or exceeds 90 psi at any time, a water pressure regulator must be installed. Plumbing installer must supply the regulator.

Brewer must be connected to a potable water supply. Bloomfield recommends not less than 1/4" copper tubing for installations of 12' or less, and not less than 3/8" copper tubing for installations exceeding 12'. Brewer must be connected to a COLD water line.

**NOTE:** DO NOT use a saddle tap for this water line connection.

A shut-off valve must be installed between the main water supply and the brewer. Plumbing installer must supply the shut-off valve. A 1/4-turn ball valve is recommended.

Bloomfield recommends the use of a water strainer to help prevent deposits in the brewing system.

Flush the water line before connecting to the brewer.

### ELECTRICIAN'S INSTALLATION INSTRUCTIONS

Brewer requires a dedicated single-phase circuit:

Model 9520      120/208 Volt AC, 50/60 Hz 3-Wire + gnd  
5655 Watts 30 Amps

Model 9521      120/240 Volt AC, 50/60 Hz 3-Wire + gnd  
6156 Watts 30 Amps

#### NOTE:

To enable the installer to make a quality installation and to minimize installation time, these tests and suggestions should be completed before the actual installation is begun.



**CAUTION:**  
Hazard from  
Unstable Equipment

Rubber feet must be installed on each leg of the brewer. Legs must be adjusted so that all four feet rest firmly on the counter. Failure to properly install the feet can result in movement of the brewer, which can cause personal injury and/or damage to the brewer.

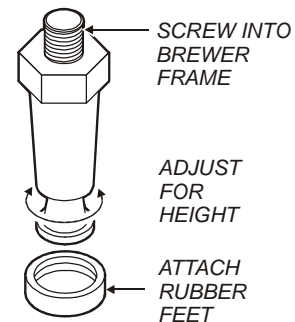

Fig. 2 Adjustable Legs



**CAUTION:**  
Electric Shock  
Hazard

Brewer must be properly grounded to a reliable earth ground to prevent possible shock hazard. Do not assume a plumbing line will provide such a ground. Electrical shock may cause serious injury.

## INSTALLATION INSTRUCTIONS (continued)

### IMPORTANT:

Initial set-up must be performed by a qualified installer or qualified service technician. Improper set-up will damage the brewer and void the warranty.

### DO NOT CONNECT POWER TO BREWER WITH SATELLITES IN PLACE.

**NOTE:** If "NO WATER SENSED" error message is displayed:

- \* Disconnect brewer from electrical power.
- \* Review Plumber's Installation Instructions
- \* Check inlet solenoid for debris and verify proper operation

**NOTE:** Brewer will not operate unless a satellite is properly positioned on the brewer.

### INITIAL SET-UP INSTRUCTIONS

Plumber's and Electrician's installation procedures must be completed before proceeding with the set-up.

Be sure all electrical connections are secure, and that all plumbing connections are secure and leak-proof.

#### 1. CHECK BREWER FOR PROPER CONFIGURATION

Make sure spray disk gaskets are in place INSIDE of spray heads.

Make sure spray disks are properly installed.

Check hot water faucet for proper operation and leaks.

#### 2. START BREWER OPERATION

With the satellite servers removed, press the POWER SWITCH to ON.

When power is first applied to the brewer, the display will read "BLOOMFIELD" briefly, and a "beep" will sound.

Press the POWER key on the front panel. The inlet valve will energize and the tank will begin filling. The display will read "Filling..." Fill time for the tank is approximately 13 minutes. If water is not sensed at the water level probe within 20 minutes, the brewer will shut down and the display will read "NO WATER SENSED" error message.

When tank has filled, TANK HEAT LED will glow and display will read "Heating..."

Slide satellites into position. Make sure satellites are properly aligned and the SATELLITE LEDs are lit.

Allow 30 minutes for initial water heat-up. Time will vary with incoming water temperature. When the tank water is up to the Precise Temperature for Brewing™, the TANK HEAT LED will turn off.

#### 3. FINAL CHECKS

After initial heat-up and before brewing, draw water from the hot water faucet until the inlet solenoid actuates. This will prevent volume differences to the initial brew caused by water expansion.

Verify brew water temperature. It should be 198°F ±5°F.

Check and adjust water delivery volumes.

Disconnect brewer from electrical power. Inside top of the brewer for leaks. Reassemble brewer and reconnect power.



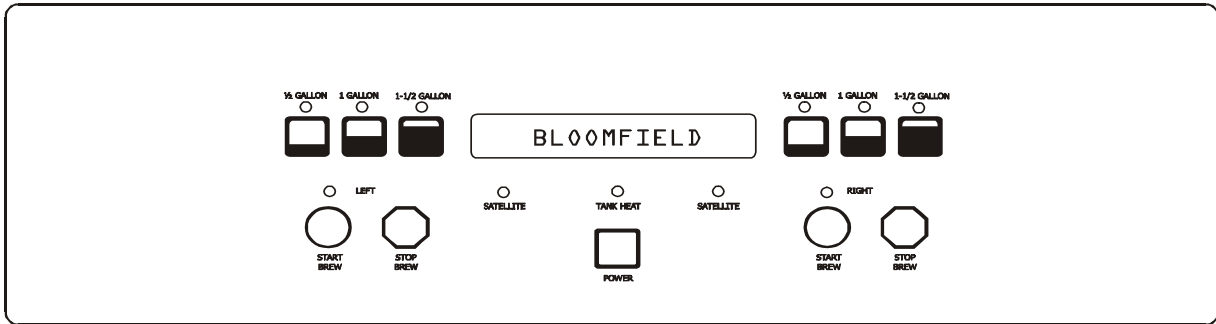

Fig. 3 Control Panel

**GETTING STARTED**

Check the brewer and satellites:

Check that the brewer is clean and the drip tray (if used) is empty.

Check that the satellites are empty and clean with lids properly installed.

Check the spray heads:

Remove the brew chambers. Check the spray heads. Verify that the spray disks are clean and properly installed. Verify that the gaskets are properly installed inside the spray heads.

Check the brew chambers:

Check that the brew chamber is clean.

Check that the wire basket is properly installed in the brew chamber.

**DAILY START-UP**

Press **POWER KEY** to enter *ON* mode:

Brewer water tank will begin filling. The message FILLING will be displayed.

When the tank is full, **TANK HEAT** LED will glow, and the message HEATING is displayed indicating that the tank heater is *ON*.

When the tank is filled and up to temperature, time and date are displayed. The brewer is ready to operate.

**NOTE:**

If water is not sensed at the water level sensor within 20 minutes:

Heater will be disabled  
Error message NO WATER SENSED will be displayed

672 74345 Owners Manual Dual Satellite 9520/9521

## OPERATING INSTRUCTIONS (continued)

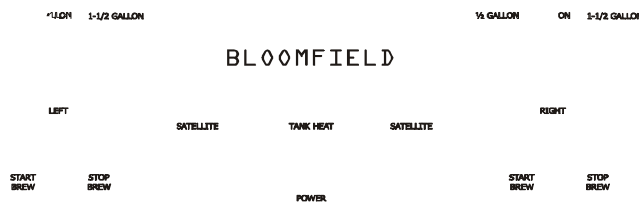

Fig. 4 Operating Controls

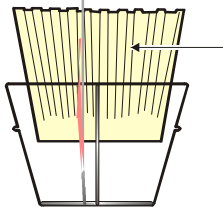

Fig. 5 Brew Basket



### CAUTION: Burn Hazard

Basket and contents are hot to the touch and may cause burns on contact.



## BREWING COFFEE

Prepare the Brew Baskets:

Make sure the wire rack is properly installed in each brew chamber.

Insert one (1) Bloomfield paper filter into each brew chamber. Make sure the filter is properly supported by the wire rack.

Add a measured amount of grounds to each brew basket. Gently shake the basket to level the grounds.

Slide one brew chamber under each brew head.

Insert Satellites:

Slide one satellite under each brew chamber until it is fully seated.

When the satellite is properly installed, SATELLITE LED for left or right side will glow.

Select Brew Volume:

Press either the **1/2 GALLON**, **1 GALLON** or **1-1/2 GALLON** key. The corresponding LED will glow.

Start the Brew:

Press either the right or left **START BREW** key. The LED for the selected side will glow.

**NOTE:** The brew can be cancelled at any time by pressing the **BREW STOP** key.

At the end of the brew, the brewer will beep. When the **TANK HEAT** LED goes out, the brewer is ready to run another brew cycle.

Empty the Brew Basket:

Discard the grounds and the paper filter. Rinse the brew chamber under clear water.

## OPERATING INSTRUCTIONS (continued)

### WATER FLOW

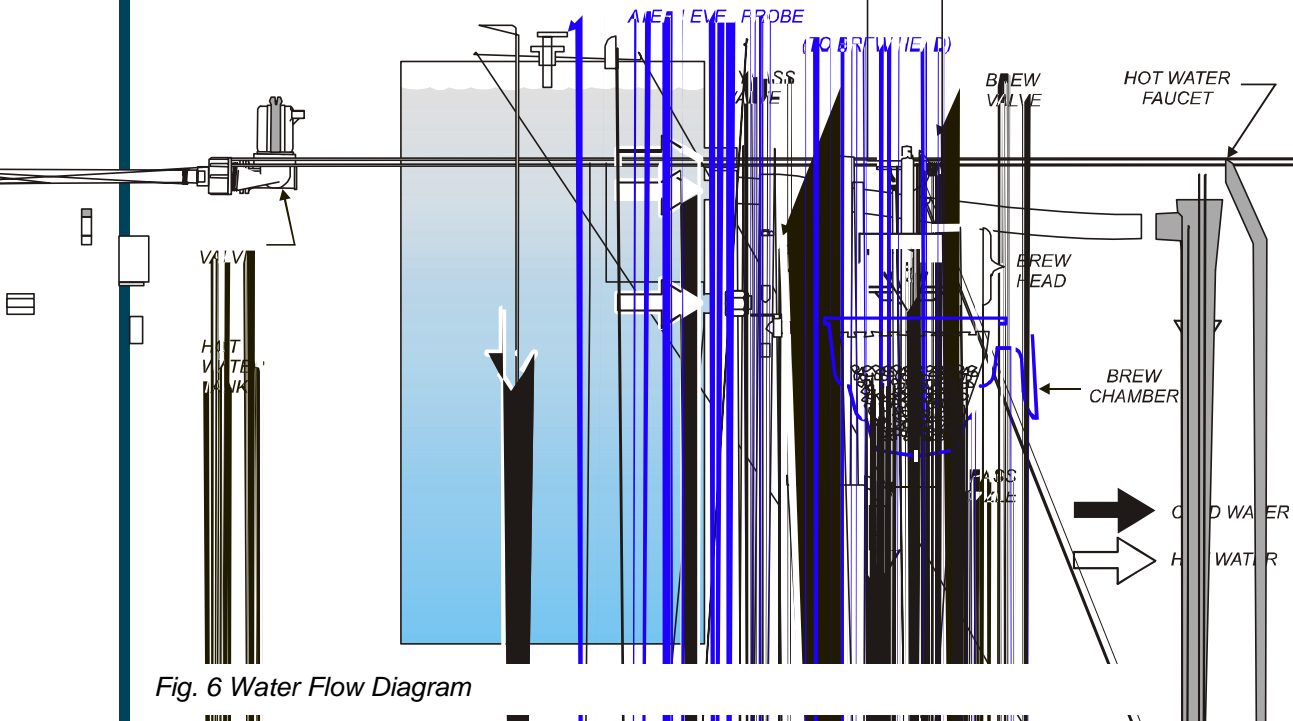

Fig. 6 Water Flow Diagram

#### INLET

The INLET VALVE is controlled by a signal from the CONTROL BOARD. If the WATER LEVEL PROBE does not detect water, the inlet solenoid is opened until water is again sensed.

#### BREW

The BREW VALVE fed by gravity from the hot water tank, and is controlled by a signal from the CONTROL BOARD. The brew valve is opened for a length of time as determined from programmed values. The brew valve discharged through the BREW HEAD. Each half of the brewer is independently controlled.

#### BYPASS

The BYPASS VALVE fed by gravity from the hot water tank via a standpipe, and is controlled by a signal from the CONTROL BOARD. The bypass valve is opened for a length of time as determined from programmed values. The bypass valve discharges through the BYPASS NOZZLE into the satellite server. Each half of the brewer is independently controlled.

#### HOT WATER FAUCET

The HOT WATER FAUCET is fed by gravity from the hot water tank. The faucet is spring-loaded closed and manually opened.

The SS-2 Brewer has two independent brewer systems sharing a common hot water tank.

The hot water faucet is fed by the hot water tank, but is otherwise independent of the brewing systems.

#### NOTE:

Use of the hot water faucet during a brew cycle will not change the delivered volume. However, excessive use of the faucet during brew may lower the brew water temperature.

## CLEANING INSTRUCTIONS



### **CAUTION:** Burn Hazard

Brewing and serving temperatures of coffee are extremely hot. Hot coffee will cause serious skin burns.

### **PROCEDURE: Clean Coffee Brewer**

**PRECAUTIONS:** Press POWER key to OFF.  
Allow brewer to cool.

**FREQUENCY:** Daily

**TOOLS:** Mild Detergent, Clean Soft Cloth or Sponge  
Bristle Brush



### **WARNING:** Electric Shock Hazard

DO NOT immerse or submerge satellites. Fluid may saturate the insulation and short-circuit the receptacle connectors. Electric shock may cause injury and property damage.

### **IMPORTANT:**

DO NOT use steel wool, sharp objects, or caustic, abrasive or chlorinated cleansers to clean the brewer, brew baskets or satellites.

1. Press POWER key to OFF. Allow brewer to cool.
2. Remove satellites.
3. Remove and empty brew baskets.
4. Remove spray disks and gaskets from spray heads
5. Wipe inside of spray head and area around spray head with a soft clean cloth or sponge moistened with clean water.
6. Wash spray disks in a sink using warm water and a mild detergent. A bristle brush may be used to clear clogged spray holes. Rinse spray disks with clean water and allow to air dry.
7. Wash brew baskets in a sink using warm water and a mild detergent. A bristle brush may be used to clean around the wire rack. Rinse with clean water and allow to air dry. Be sure wire racks are properly installed.
8. Remove and drain the drip tray. Rinse in a sink under warm running water. Allow to air dry, then reinstall on brewer.
9. Wipe exterior of brewer and satellites with a soft clean cloth or sponge moistened with clean water.
10. Reinstall gaskets INSIDE brew heads, then reinstall spray disks.
11. Reinstall brew chambers.
12. Reinstall satellites.

Procedure is complete

**PROCEDURE: Clean Satellite**

PRECAUTIONS: Drain Satellite before Cleaning

FREQUENCY: Twice Weekly

TOOLS: Sight Glass Brush, Sanitizer  
Soft Clean Cloth, Bucket

1. Remove and drain satellites.
2. Place 1 packet of Sanitizer into 2-1/2 gallons of warm tap water. Pour approximately 1 gallon of sanitizer solution into each satellite. Allow to stand for 2 minutes.
3. Remove the shield cap (large vent) on top of the sight glass.  
  
NOTE: It is not necessary to remove the sight glass unless it is broken and replacement is required.
4. Run the sight glass brush up and down through the sight glass at least 10 times.
5. Reinstall and tighten the shield cap.
6. Drain sanitizer solution from satellite into the bucket.
7. Disassemble faucet. Brush clean with sanitizer solution. Reassemble faucet.
8. Install satellite on brewer.
9. Rinse satellites: With an empty brew chamber in place, press the BREW key and run 1 full cycle into each satellite.
10. Drain water from satellites.

Procedure is complete



**CAUTION:  
Burn Hazard**

Brewing and serving temperatures of coffee are extremely hot. Hot coffee will cause serious skin burns.



**WARNING:  
Electric Shock Hazard**

DO NOT immerse or submerge satellites. Fluid may saturate the insulation and short-circuit the receptacle connectors. Electric shock may cause injury and property damage.

**IMPORTANT:**

DO NOT use steel wool, sharp objects, or caustic, abrasive or chlorinated cleansers to clean the satellites.



Fig. 7 Function Keys

**NOTE:**

Time is held in memory by a battery-backed. Clock should only be necessary for daylight/saving time, when the brewer is moved to a different time zone.

For advanced programming features and instructions, refer to PROGRAMMING MANUAL p/n 74346.

This brewer can be programmed with a personal computer. Please contact your Sales Representative for details.

**MENU SETTINGS**

**OFF Mode Program:**

- Press POWER key to enter OFF mode.
- Press and hold 3rd & 6th keys for 3 seconds
- Advance thru menus by pressing the 1st key
- Advance thru items by pressing the 3rd key
- To exit, press 2nd key

**ON Mode Settings:**

- Press POWER key to enter ON mode
- Press 3rd & 4th keys at the same time

**Check Tank Temperature:**

- Press POWER key to enter ON mode
- Press 3rd & 6th keys at the same time

## FEATURES

1. **Energizing the Brewer:** Turn the brewer on by pressing the *POWER* key. The brewer will start to fill the tank with the message on the screen “**filling...**”. With the proper water supply the tank should be filled in about 2½ minutes. Once

### PRECISE BREWING TEMPERATURE™:

The brew cycle will not start until the water in the tank is at the proper temperature.

If START BREW key is pressed and held for 3 seconds during “**Brew Wait**” the brew will proceed immediately.

### **Note: the following safety features prevent multiple unattended brews:**

When the BREW LED is on or flashing, repeated pressing of the START BREW switch will be ignored, (there will be a beep each time it is pressed).

A Brew will only be activated or put in Brew Wait when the BREW LED is off.

Only one brew can be stored in “Brew Wait” at a time.

## PROGRAMMING (continued)

### OFF – Normal Operation (Automatic Timer):

When the brewer is OFF, press the POWER key: 2 beeps will be heard and the brewer will be turned OFF, indicated by all LEDs being off.

When the brewer is ON, press the POWER key: 2 beeps will be heard, all lights will flash once, and the POWER LED will glow.

**NOTE:** The HEAT LED will glow when the water temperature is too low when the brewer is turned ON.

### Temperature:

The Brewmaster Automatic Timer can be turned ON at least

There is a program for Saturday

Automatic On mode, press the POWER key.

programmable automatic timer the next time normal



**7. Automatic Start-Up in Previous Mode:**

If the Satellite Brewer automatic timer is OFF (the factory setting) and power is disconnected, the brewer will start up when power is restored, in the mode it had been in prior to the power disconnection. If the Satellite Brewer has the timer setting ON and power is disconnected, the brewer will start up in the mode that it should be in at the time the power is restored.

**8. Brew Volume:**

The Brewer can have up to 3 different brew volumes on each side. When a volume other than the standard, or first brew volume, is selected, the Brewer will complete that volume and then automatically reset to the standard, or first brew volume.

To view, press the individual volume key. The brew volume will be displayed on the screen for 3 seconds. If there is no brew volume for a specific key, the screen will read "**no volume prog**", (i.e. no volume programmed).

**9. Clock**

**Time – Battery Backup.** The Satellite Brewer has a battery backup system which will maintain the proper time during power failures, or when the brewer is unplugged (even for very prolonged periods of time). Normally there will not be a need to set the time except for Daylight Saving Time changes, or moving the brewer to different time zones.

- 10. Changing Day and Time:** To change time, in the OFF mode, press the **2nd key** twice followed by the **1st key** twice to access the time change mode. In the time change mode the screen will read "**Day:**" followed by the current day setting. Use the **6th key** to advance the day, or the **5th key** to reverse.

When day has been properly set, press the **3rd key**. The screen will now read "**Time:**" with the set time on the screen, the *hour and am or pm* flashing. Use the **6th key** to advance the hour, or the **5th key** to reverse, making sure that the am or pm is correct.

When the hour and am/pm is correctly set, press the **3rd key**, and the screen will read "**Time:**" with the set time on the screen, *minutes* flashing. As previously, use the **5th or 6th keys** to adjust the minutes, and press the **3rd key** when complete. The Brewer will return to the off mode. (Changing time can also be done in the regular programming mode.)

**Brew Volume**

The 1st key is the Standard Brew Volume.

When a brew volume other than standard brew volume is selected, the Brewer will complete that brew then return to the standard brew volume automatically.

## PROGRAMMING (continued)

The factory programming has the After Hours™ mode turned OFF.

While in the After Hours mode, the POWER LED will flash continuously.

Keypadlock™ deters unauthorized operation of the brewer. This feature is OFF in the standard factory settings.

- 12. After Hours™:** The After Hours™ can be programmed to come on from 1 to 6 hours after the last brew. When the Brewer goes into the After Hours™ mode, the water in the tank will be allowed to drop from the normal brewing temperature and will reheat less frequently – this feature saves energy and extend component life. When a START BREW key is pressed the Brewer automatically reverts back to normal operation, heating the water to the Precise Temperature for Brewing™ (PTB™), before starting the brew. (The POWER LED will be on continuously and the BREW LED will flash until the correct water temperature is reached.)
- 13. Pulse or Pre-Infusion Volume Options:** If a particular brew volume has utilized the pulse or pre-infusion option, that volume will be displayed with an asterisk (\*) after the volume. As an example “Volume#2\*” would indicate that the second programmed brew volume has utilized the pulse or pre-infusion program options.
- 14. Keypadlock™:** If the Keypadlock™ feature is activated, there will be no response by the brewer when the keys are pressed (except for the beep after a key is pressed). To temporarily “unlock” the keypad, press and hold the **2nd key** for 6 seconds. A beep will sound, indicating the keypad is temporarily “unlocked”, — a brew can be initiated, etc. The keypad will remain unlocked until the brew is completed, then automatically return to keypadlock™ mode. If a brew is not initiated 60 seconds after “unlocking”, the system will time out and return to the “locked” position.
- 15. View Filter Statistics:** To view filter statistics, from the OFF mode, press and hold the **6th key**, and touch the **3rd key** to view Total Water Volume (TotalVol.) Touch the **3rd key** again to view the filter life (FltrLife:). The percentage of the filter that has been used will be displayed.

TROUBLESHOOTING SUGGESTIONS		
DESCRIPTION OF PROBLEM	POSSIBLE CAUSE	SUGGESTED REMEDY
No lights or heat	Unit not plugged in or circuit breaker tripped	Restore electric power
	Power switch OFF	Turn power switch ON
No heat	Hi-limit safety tripped	Allow brewer to cool, verify water level, reset hi-limit
Brewer overflows	Water level probe corroded	Clean water level probe
	Poor ground connection	Verify ground connection
	Dirt in inlet valve or valve damaged	Replace inlet valve
	Brew valve damaged	Replace brew valve
Brew chamber overflows	Too many paper filters or wrong filter used.	Use one genuine Bloomfield paper filter per brew
	Chamber discharge hole plugged	Clean brew chamber
	Improper programming	Correct programming
Heats slow	Connected to wrong voltage	Verify supply voltage
	Scale build-up on heating elements	De-lime hot water tank
	Damaged heating element	Replace element
Slow to fill	Insufficient water pressure	Brewer must be operated on a dedicated water line. Other equipment on line may be robbing water volume.
	Plugged water line strainer	Clean strainer
Satellite does not heat	Not properly seated	Seat satellite in receptacle
	Fuse blown	Correct problem, replace fuse
	Damaged satellite receptacle or wiring	Determine/repair damage to satellite
	Damaged brewer receptacle	Repair/replace receptacle
Satellite shorts out	Wet insulation	Disassemble satellite, allow to dry completely before reassembly
Poor coffee quality	Improper programming	Correct programming
	<p>Also:            Keep brewer and servers clean.            Install a taste and odor filter in water supply, and replace cartridges regularly.            Use a quality coffee with a consistent roast. Use proper grind and amount of coffee per brew.</p>	

## SERVICING INSTRUCTIONS



### CAUTION - CHEMICAL BURN HAZARD

Deliming chemicals are caustic. Wear appropriate protective gloves and goggles during this procedure.

Never siphon deliming chemicals or solutions by mouth.

This operation should only be performed by qualified and experienced service personnel.

---

**IMPORTANT:** DO NOT spill, splash or pour water or deliming solution into or over any internal component other than the inside of the water tank.

---

**IMPORTANT:** DO NOT allow any internal components to come into contact with the deliming solution. Take care to keep all internal components dry.

**NOTE:** Repeat steps 4 and 7 as required to remove all build-up.

### PROCEDURE: Delime the Water Tank

**PRECAUTIONS:** Disconnect brewer from electric power. Allow brewer to cool.

**FREQUENCY:** As required (Brewer slow to heat)

**TOOLS:** Deliming Solution  
Protective Gloves, Goggles & Apron  
Mild Detergent, Clean Soft Cloth or Sponge  
Bristle Brush, Bottle Brush  
Large Sink (or other appropriate work area)

- 
1. Disconnect brewer from the electrical supply.
  2. Remove the brewer top panel, then remove the tank lid assembly. Do not disconnect the tank assembly at this time.
  3. Siphon all water from the hot water tank.
  4. Mix 10 gallons of deliming solution according to the manufacturer's directions. Carefully pour the deliming solution into the water tank. Lower the lid assembly back onto the tank. Allow to sit for 30 minutes, or as directed by the chemical manufacturer.
  5. At end of soaking period, reconnect brewer to electrical power. Install the brew chamber without filter paper or grounds. Place an empty satellite under the brew chamber. Force a 1-1/2 gallon brew:
    - a. Press the 1-1/2 gallon key
    - b. Press the brew key, then press and hold the brew key until a brew is initiated.Empty the satellite and repeat for the other side.
  6. Disconnect brewer from electrical power and allow to cool.
  7. Remove lid assembly from tank.
    - a. Using a stiff bristle brush, scrub internal components to remove lime and calcium build-up.
    - b. Thoroughly rinse internal components of lid assembly with clear water.
    - c. Store lid assembly in a safe location.
  8. Using a stiff bristle brush, scrub exposed portions of the heating element and the inside surfaces of the tank to remove lime and calcium build-up.
  9. Siphon all solution from the tank.

## SERVICING INSTRUCTIONS (continued)

10. Reinstall tank lid assembly into hot water tank. Make sure the lid gasket is properly in place, then reinstall the hold-down clamps.
11. Remove spray disks and gaskets. Rinse both brew heads with clean water. Using a stiff brush, scrub spray disk to remove any lime or calcium build-up. Reinstall gaskets and spray disks.
13. Reconnect brewer to electrical supply .
14. Install the brew chamber without filter paper or grounds.
15. Place an empty satellite under the brew chamber. Run at least five 1-1/2 gallon brew cycles and discard all water generated at the end of each cycle. Repeat for the other side.
16. Rinse satellite with clean water. Reinstall one empty satellite under each brew chamber.

**NOTE:** Normally, silicone hoses do not need to be delimed. Should deliming hoses become necessary, Bloomfield recommends replacing the hoses.

Brewer is ready to use.

# EXPLODED VIEW CABINET AND EXTERIOR COMPONENTS

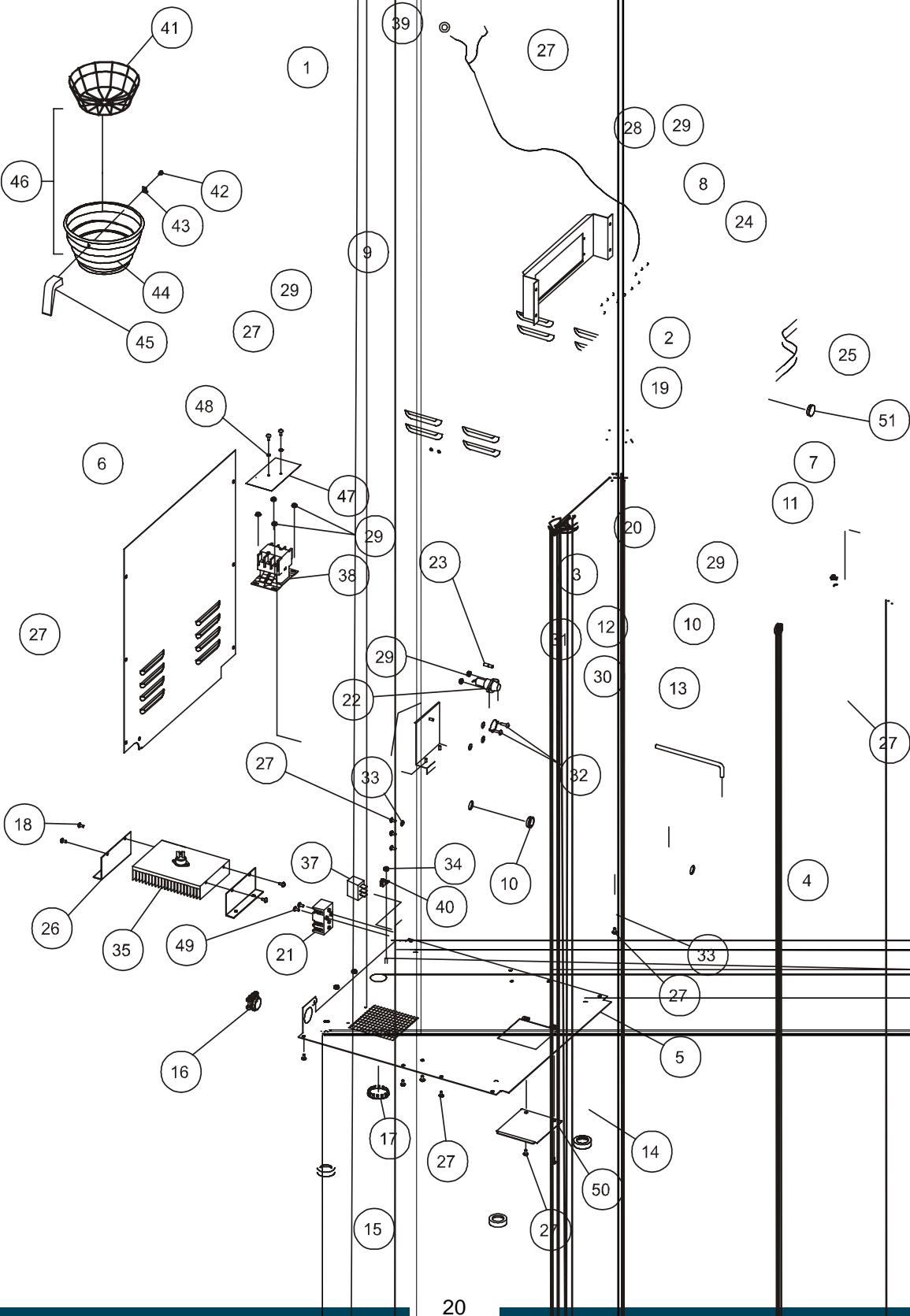

672 74345 Owners Manual Dual Satellite 9520/9521

## PARTS LIST - CABINET AND EXTERIOR COMPONENTS

ITEM	SERVICE #	DESCRIPTION	QTY.
1		COVER TOP HOUSING SS2	1
2		TOP HOUSING WLD ASSY SS2	1
3		BODY WLD ASSY SS2	1
4		BASE WLD ASSY SDS-2	1
5		BTM PLATE WLD ASSY	1
6		PANEL BACK SS2	1
7		PANEL FRONT SS2	1
8		BRACKET CONTROL BOARD MTG SS2	1
9		BRACKET TANK SUPPORT TOP SS2	2
10	8543-69	BUSHING SHORTY HEYCO	3
11	82738	SPOUT ASSY	2
12	83046	CONNECTOR WIRED ASSY SDS-2	2
13	83077	HANDLE GUIDE "L"	3
14	83098	LEG 4 IN FLANGE PLASTIC BLK	4
15	83107	FEET RUBBER BLACK	4
16	500102	STRAIN RELIEF	1
17	57512	PLUG HOLE 1 3/8	1
18		SCREW, PAN, NI #8-32 X 1/4	4
19	8543-42 82215	GASKET SPRAY HEAD GASKET SPRAY HEAD 1.5 ID	2
20	82727	DISC SPRAY HEAD EMBOSSED	2
21	50310	KIT, TERM BLOCK 3 POLE	1
22	8875-68	FUSE HOLDER	1
23	8875-69	FUSE 5A	1
24	84323	POWER & CONTROL BOARD ASSY	1
25	85239	OVERLAY CONTROL PANEL Ss2	1
26		BRACKET HEAT SINK SS2	2
27	7200-6X	SCREW PAN PH SS 8-32 X 5/16	56
28	68748	SCREW PAN 4-40 X 3/8 BLK	4
29	8942-92	NUT KEP 8-32 SS	25
30	51243	SCREW 8-32 X 7/8	4
31	83362	SPACER 8-32 X 1/4	4
32	7506-39	SCREW PAN 8-32 X 1/2	2
33		WASHER #8 EXT SEMS	6
34	55313	NUT HEX SS 10-32	1
35	83392	HEAT SINK & TRIAC ASSY	1
36			
37	82936	SWITCH ON-OFF	1
38	57780	CONTACTOR 3P 240V 40A	1
39	83552	WIRE ASSY WATER LVL PROBE SS2	1
40		LUG GROUND SOLDERLESS 6-14G	1
41	8706-9	RACK WIRE BREW CHAMBER	2
42	8707-3	SCREW BREW CHAMBER	2
43	8812-73	CLIP WIRE RACK	2
44	83101	CHAMBER BREW	2
45	8707-2	HANDLE BREW CHAMBER	2
46	83100	BREW CHAMBER ASSY	2
47	83885	DRIP SHIELD, CONTACTOR	1
48		WASHER, FLAT #4 .312 O.D.	2
49	8705-65	SCREW PAN #6-32 X 7/8 SS	2
50	8572-34	DOOR ACCESS	1
51	85235	PLUG BUTTON (9520FB/9521FB)	1

672 74345 Owners Manual Dual Satellite 9520/9521

# EXPLODED VIEW INTERIOR COMPONENTS

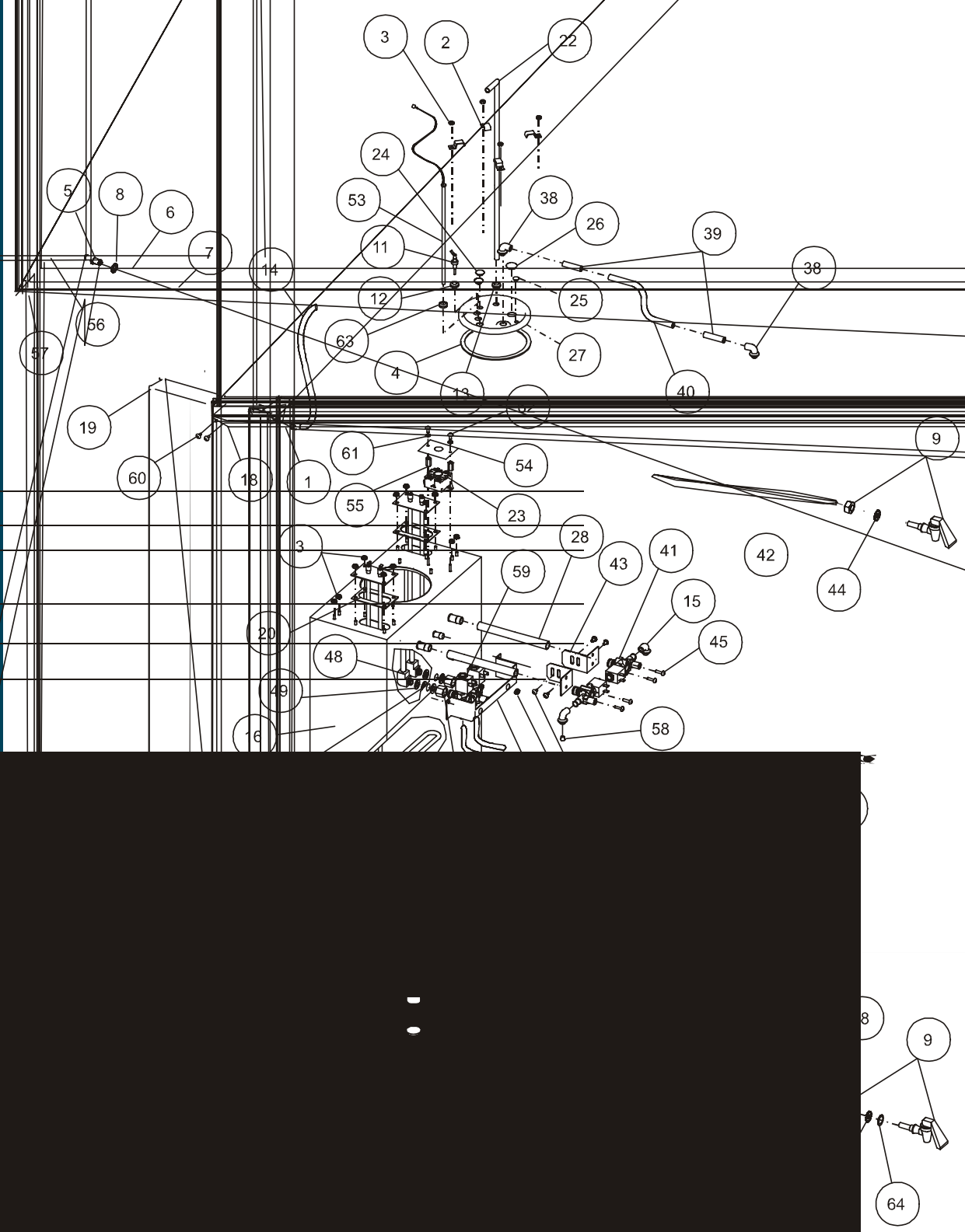





# WIRING DIAGRAM

MODELS	VOLTS	WATTS	HZ
9521	120/240	6680	50/60
9520	120/208	5655	50/60

PART NO. 73953 ISSUE (B) FCN-12498

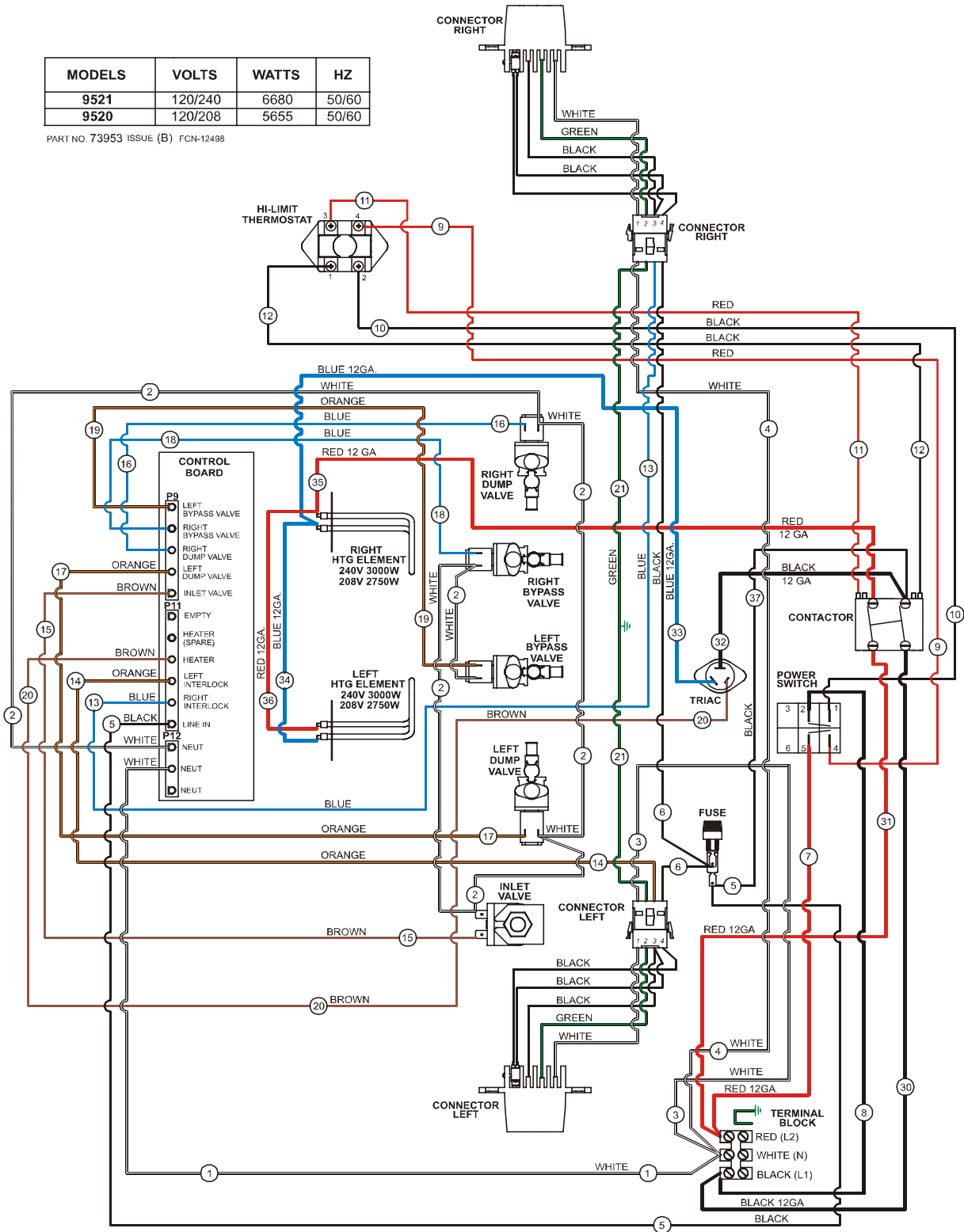

672 74345 Owners Manual Dual Satellite 9520/9521

# SATELLITE ASSEMBLY 9340 120V

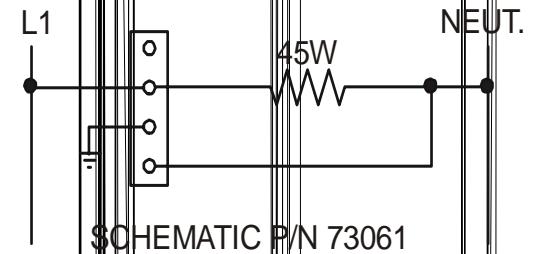
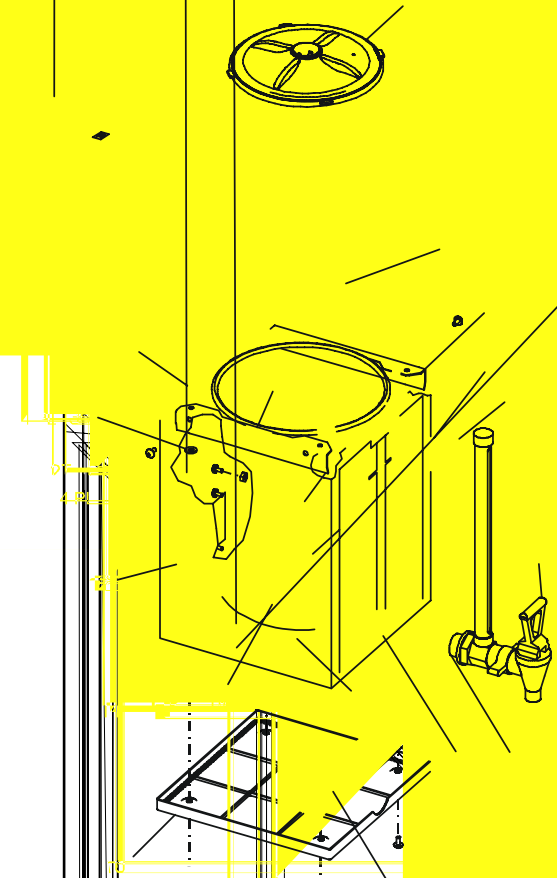

MODEL	VOLTS	WATTS
9340	120	45

8	83057	TOP COVER, SATELLITE	1
9	83092	FRAME, DECAF (PART OF #9)	1
10	83112	DOOR, DECAF	1
10.01	83112	FAUCET w/SIGHT GLASS, 10"	1
10.02	8600-17	SHIELD CAP	1
10.03	8700-25 J	CAP WASHER	1
10.03	8705-11 C	SIGHT GLASS	1
10.04	8600-20	SHIELD ASSY	1
10.05	8705-11 B	BASE WASHER	1
10.06	8705-11 A	SHIELD BASE	1
10.08	8600-26	C-RING	1
10.09	8600-27	WING NUT	1
10.10	8700-25 L	SEAT CUP	1
10.20	8705-11 D	SHANK ASSY	1
12	84326	HANDLE GUARD, FAUCET	1
13	83172	RECEPTICAL, WIRED ASSY	1
14	83114	ELEMENT HEATER, 45W	1
15	83117	TANK INSULATION	1
16	83057	BASE, POLYPROPYLENE	1
17		PLATE STIFFENER	1
18		WELDMENT, SATELLITE BODY	1
19		TANK SUB ASSY w/FITTINGS	1
20		TAPE, GLASS CLOTH	.33
21		THREADLOCK, RED	A/R
22	8705-26	SEAL, DRAIN FITTING	2
23		TAPE, TEFLON	1.74
24		LABEL, SATELLITE	1
25		SCREW, PAN PHL 8-32x1/2"	4
26		STIFFENER BRACKET, RIGHT	1
27		SCREW, TRS PHL SS 10-32x3/8"	4
28	8705-33	O-RING	1
30		WASHER #10	4
33	8942-92	NUT, KEP SS 8-32	3
34	83132	LABEL, CAUTION "DO NOT IMMERSE..."	1

672 74345 Owners Manual Dual Satellite 9520/9521

Bloomfield Industries proudly supplies Office of  
Commercial Equipment Search Association

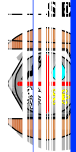

Bloomfield  
Division of

In US and C

Telephone:

Fax:

Fax:

website: www.com

(US only)

PRINTED IN UNITED STATES OF AMERICA

## Free Manuals Download Website

<http://myh66.com>

<http://usermanuals.us>

<http://www.somanuals.com>

<http://www.4manuals.cc>

<http://www.manual-lib.com>

<http://www.404manual.com>

<http://www.luxmanual.com>

<http://aubethermostatmanual.com>

Golf course search by state

<http://golfingnear.com>

Email search by domain

<http://emailbydomain.com>

Auto manuals search

<http://auto.somanuals.com>

TV manuals search

<http://tv.somanuals.com>