





BASS1000 *12" Amplified Subwoofer
with Passive Radiator*

**Congratulations on your
purchase of a  BASS1000
Amplified Subwoofer.**

It has been designed, engineered
and manufactured to bring you
the highest level of performance
and quality, and will afford you
years of listening pleasure.

Thank you for making a 
your choice for car audio
entertainment!

USER'S MANUAL

page	CONTENTS
2	Introduction
2	What is included?
2	Features
3	General precautions
4	Protection circuitry
4	Installation precautions
4	Fuses
4	Mounting the subwoofer
4	Connecting the subwoofer
6	Front panel controls and features
8	Input wiring
9	Power connections
9	Remote level control connection
10	Troubleshooting
11	Specifications

Introduction

With the BASS1000, we are introducing a rugged enclosed powered subwoofer. Great looking and capable of slamming out powerful bass, this system offers you a quick and easy way to add a high-powered subwoofer system to your audio system.

The integrated amplifier in the BASS1000 features a low pass crossover, and a control for adjusting the input sensitivity from 0.2V to 6V.

Both high level (speaker level) and low level (RCA type) inputs are present, making this a universal solution for use with any head unit or other input source.

For further flexibility in the use of a subwoofer, a variable bass boost control has been included. You can control the subwoofer level with the remote level control module.

What is included?

When first unpacking your new amplified subwoofer, please check first that the package contains all of the items below. If something is missing, contact the store where you purchased the product.

- **BASS1000 amplified subwoofer**
- **Remote subwoofer level control**
- **Remote subwoofer control cable**
- **High level input harness/wire**
- **Mounting hardware**

Features

Your new BASS1000 Powered Subwoofer features the following:

- **MOSFET PWM (Pulse Width Modulated) Power Supply**
- **Thermal, overload and speaker short protection**
- **Soft turn-on circuit**
- **Remote turn-on/turn-off circuit**
- **Variable input gain control**
- **Variable low pass crossover**
- **Variable bass boost (0 to +18dB)**
- **Variable phase shift (0 to 180°)**
- **Nickel plated RCA low level and high level inputs**
- **LED power/ protection indicator**
- **Remote subwoofer level control**

General precautions

Before installing and using your new BOSS amplified subwoofer, please become familiar with all the information contained in this manual.

Please keep this manual in a safe place for future reference.

- Do not open or attempt to repair this unit yourself. Dangerous high voltages are present which may result in electric shock. Refer any repairs to a qualified service technician.
- To avoid risk of electronic shock or damage to the unit, do not permit any of this equipment to become damp or wet from water or drinks. If this does occur, immediately unplug the power wires and send the product to your local dealer or service center as soon as possible.
- If there is smoke or any peculiar odor present during use or if there is damage to any of the component enclosures, immediately unplug the power cord and send the product to your local dealer or service center as soon as possible .

SHOCK HAZARD! Do not open the case of this product. There are dangerous voltages present within the unit. There are no user-serviceable parts within the unit.

Protection Circuitry

The built-in amplifier incorporates special protection circuitry which will disable the amplifier if any of the following should occur:

- Input overload
- Short circuit
- Extremely high temperatures

If any of these conditions is detected, the amplifier will go into a self-preservation mode, and the PROTECT LED on the control panel will glow in RED color.

What should I do if the POWER STATUS LED turns RED?

If you observe that the POWER STATUS LED IS RED, please check the system carefully to determine what has caused the protection circuit to engage.

To reset the amplified subwoofer when it is in PROTECT mode, turn the power off to the system (usually by turning off the head unit or other signal source which feeds the amplifier) and then turn it on again.

If the internal amplifier has shut down due to thermal overload, you should first allow it to cool down before restarting.

If the shut down was due to either an input overload or a short circuit, be sure to correct these conditions before attempting to power up the subwoofer again.

Installation precautions

Before you drill or cut any holes, investigate your car's layout very carefully. Take special care when you work near the gas tank, fuel lines, hydraulic lines and electrical wiring.

Never operate the subwoofer when it is unmounted. Attach all audio system components securely within the amplifier to prevent damage, especially in an accident.

Do not mount this product so that wire connections are unprotected, in a pinched condition, in contact with any metal surfaces in your vehicle, or likely to be damaged by nearby objects.

Before making or breaking power connections in your system, disconnect the vehicle battery. Confirm that your head unit or other equipment is turned off while connecting the input jacks and speaker terminals.

If you need to replace the power fuse, replace it only with a fuse identical to that supplied with the product. Using a fuse of a different type or rating may result in damage to your audio system or your amplifier which is not covered by the manufacturer's warranty.

Fuses

Power fuses protect both the amplifier and the electrical system of your car from fault conditions. If you must replace a fuse in your BASS1000 powered subwoofer, use a fuse of exactly the same type and rating. Using a different type or rating of fuse may result in damage to your amp or vehicle or cause a fire.

Mounting the subwoofer

1. Find a suitable location in the vehicle in which to mount the amplifier. Since the subwoofer is a large, heavy enclosure, it is highly recommended that you mount it in the trunk compartment of your vehicle.

2. Make sure there is sufficient air circulation around the intended mounting location.

3. Mark the location for the mounting hole screws by positioning the cabinet where you wish to install it. Use heavy duty bolts to secure it. After you tightened it down, try to shake it or move it. Then tighten the screws again.

Connecting the subwoofer

Before doing any wiring, look through this manual and identify the diagrams to follow for power, input and speaker connections for your particular installation. Be sure you understand all the connections before you proceed.

1. Connect the ground terminal to the closest point on the chassis of the vehicle. Keep this ground wire to less than 39" (100 cm) in length. Use 8 gauge (or heavier) wire.

2. Connect the remote terminal to the remote output of the head unit using 16 gauge (or heavier) wire.

3. Connect an empty fuse holder within 18" (45 cm) of the car battery, and run 8 gauge (or heavier) cable from this fuse to the amplifier location.

4. Check that the fuse holder is empty. Then connect the fuse holder to the "BATT+" connection on the amplifier.

6. Connect all line inputs and outputs (if used) using high-quality cables. Connect all speakers, following the diagrams in this manual. Be sure to observe proper polarity to avoid audio phase problems.

7. Insert fuse(s) into the battery fuse holder(s).

8. Recheck all connections before powering up the subwoofer.

9. Set all level controls to minimum position, and set all crossover controls/switches to the desired frequency points.

10. Power up the head unit and the subwoofer. Then set the volume control on the head unit to about 3/4 volume, and adjust the subwoofer's input level controls to just below the level of distortion.

11. Further fine tuning of the various controls may be necessary to obtain best results.

Don't misuse the level control!

Do not mistake the input level control for a volume control! It is designed ONLY to match the output level of your audio source to the input level of your subwoofer.

Do not adjust this input level to maximum unless your input level requires it.

Ignoring these instructions will result in an input overload to the amplifier in the subwoofer, and excessive audio distortion. It can also cause the protection circuit to engage.

Controls and features

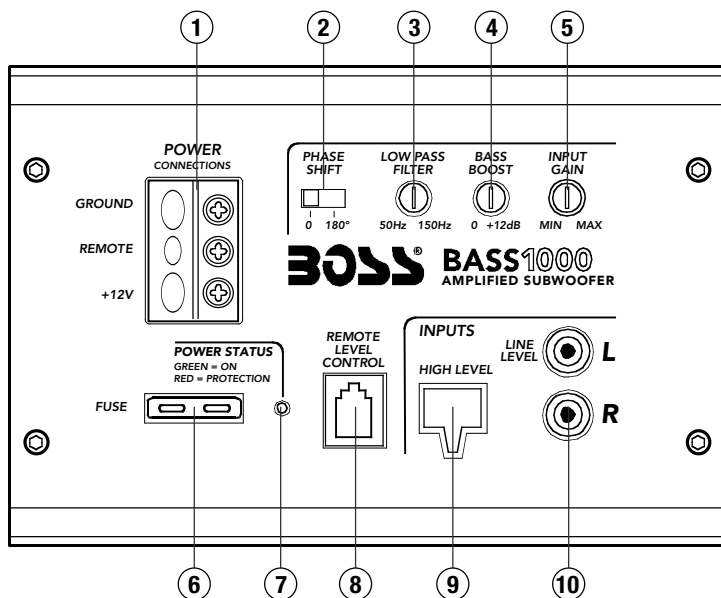

1 POWER TERMINALS

2 PHASE SHIFT

Use this switch to help compensate for time alignment problems in the system. Such problems usually result from having the subwoofer at a different distance from the listener than the other speakers in the system.

3 LOW PASS FILTER

This control permits you define the frequency range you want the subwoofer amplifier to receive. The subwoofer will reproduce all sound BELOW the frequency you set.

If the rest of your system is weak on the mids, you may wish to set this control relatively high. If the midrange is well covered by the rest of your system, you will probably want the subwoofer to only receive lower frequency signal.

4 BASS BOOST

The bass boost feature will increase the sound level in the bass frequencies.

5 INPUT GAIN CONTROL

After you have installed your system, turn this control to minimum

Turn the head unit on (and the subwoofer will turn on via the remote connection). Turn the head unit volume to about 2/3 full level.

Slowly turn up the subwoofer input gain control until you hear a small amount of distortion. Then reduce the level until the distortion is completely gone. Leave the control at this setting.

6 FUSE

The fuse in the upper socket is the fuse which provides protection for the circuitry. The fuse is rated at 25A. Do not use a fuse with a different value and NEVER replace the fuse with a wire or coin.

7 POWER STATUS LED
This bi-color LED glows green when power is on and no problems are present. If one of the protection circuits comes on, it will change to red.

8 REMOTE LEVEL CONTROL PORT
Attach the included remote level control to control the volume level of the subwoofer independently.

9 HIGH LEVEL (speaker level) INPUTS
If your head unit does not have RCA outputs, you can use the speaker outputs for the audio source for the BASS1000. Use the supplied cable and wire harness and connect the outputs properly as shown in the connection diagram in this manual.

10 LOW LEVEL RCA INPUTS
Low level inputs are the recommended way to introduce the audio signal to the subwoofer if RCA outputs are present on your head unit or other signal source (such as a sound processor).

Low Level Input Wiring

Low-level (RCA) input wiring is preferred for best audio performance. Most trunk or hatchback installations will require a 15-20 foot RCA cable, while pickup trucks and under-seat installations will require a 6-12 foot RCA cable. Always use a high-quality cable.

NOTE: Do not connect BOTH the high level and low level inputs from your receiver to your amplifier at the same time!

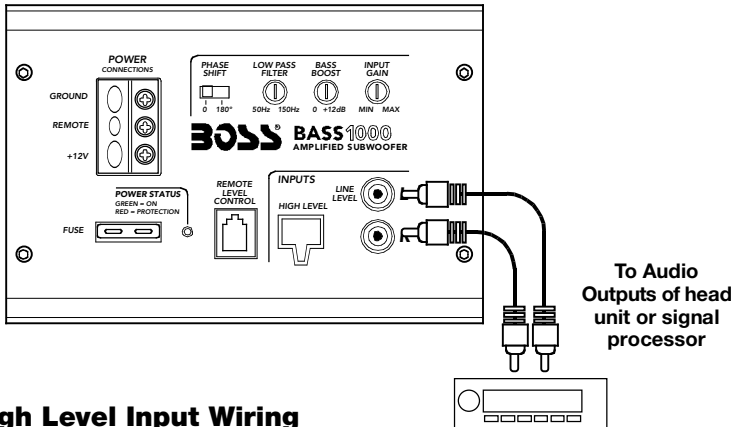

High Level Input Wiring

The high level input(s) should only be used when your receiver lacks RCA outputs. If the RCA outputs are not present, connect the speaker outputs from the receiver to the high level input connector of the amplifier. Be sure to observe polarity to avoid audio phase problems.

NOTE: Do not connect BOTH the high level and low level inputs from your receiver to your amplifier at the same time!

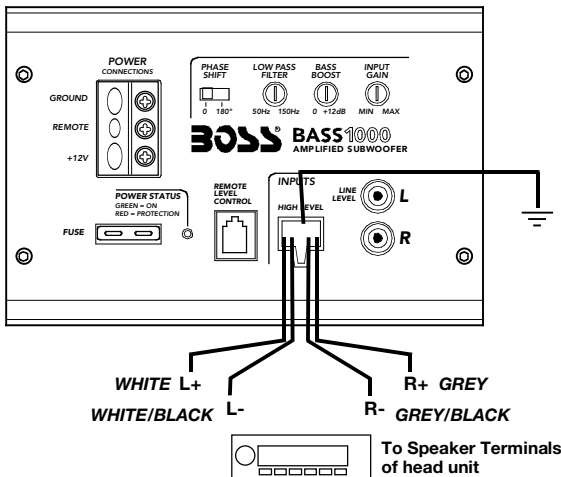

Power Connections

Connect the ground terminal to the closest point on the chassis of the vehicle. Keep this ground wire to less than 39" (100 cm) in length. Use 8 gauge (or heavier) wire.

Connect the remote terminal to the remote output of the head unit using 16 gauge (or heavier) wire.

Connect an empty fuse holder within 18" (45 cm) of the car battery, and run 8 gauge (or heavier) cable from this fuse to the amplifier location. Then connect the fuse holder to the "BATT+" connection on the subwoofer rear panel.

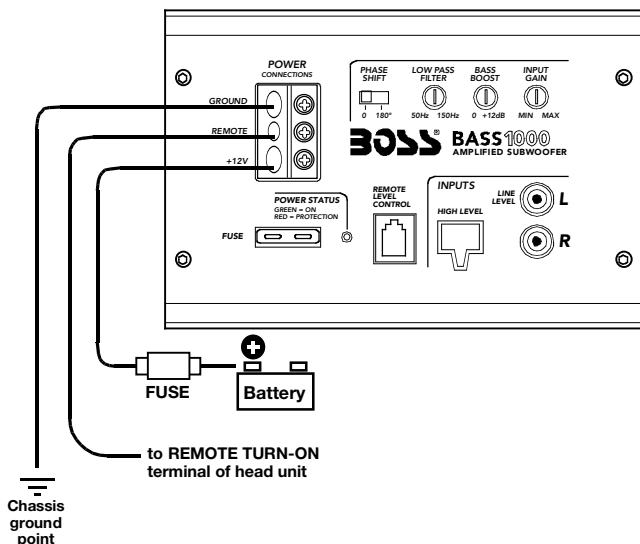

Remote Level Control Connection

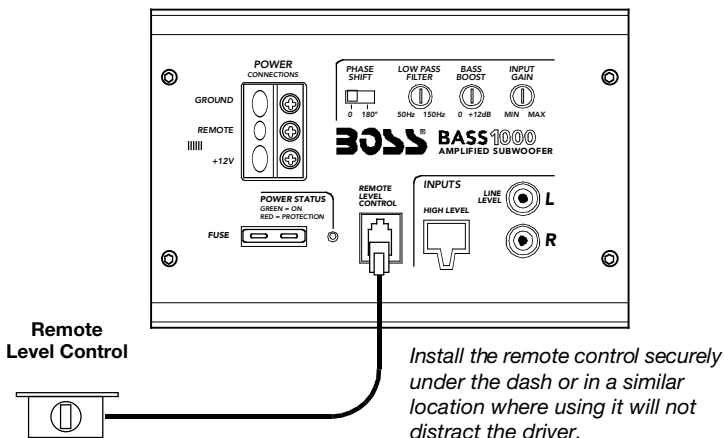

Troubleshooting

If you experience operation or performance problems with this product, compare your installation with the electrical wiring diagram on the previous pages. If problems persist, read the following troubleshooting tips which may help eliminate the problems.

SYMPTOM	POSSIBLE REMEDY
Amplifier will not power up.	<p>Check to make sure you have a good ground connection.</p> <p>Check that the Remote Input (Turn-On) has at least 3VDC.</p> <p>Check that there is battery power on the (+) terminal.</p> <p>Check that there is at least 12v.</p> <p>Check all fuses, replace if necessary.</p> <p>Make sure that the Protection LED is not illuminated. If it is lit, shut off the amplifier briefly, and then repower it.</p>
Protection LED comes on when amplifier is powered up.	<p>Check for short circuits on speaker leads.</p> <p>Turn down the volume control on the head unit to prevent overdriving.</p> <p>Remove speaker leads, and reset the amplifier. If the Protection LED still comes on, then the amplifier is faulty and needs servicing.</p>
No output.	<p>Check that all fuses are OK.</p> <p>Check that unit is properly grounded.</p> <p>Check that the Remote Input (Turn-On) has at least 3VDC.</p> <p>Check that the RCA audio cables are plugged into the proper inputs.</p> <p>Check all speaker wiring.</p>
Low output.	<p>Reset the Level Control.</p> <p>Check the Crossover Control settings.</p>
High hiss in the sound.	<p>Disconnect all RCA inputs to the power sub's control panel. If the hiss disappears, then plug in the component driving the amplifier and unplug its inputs. If the hiss disappears at this point, go on until the faulty/noisy component is found.</p> <p>It is best to set the amplifier's input level control as low as possible. The best subjective signal-to-noise ratio is achieved in this manner. Try to set the head unit as high as possible (without distortion) and the amp input level as low as possible.</p>
Squealing noise is present.	<p>Check for improperly grounded RCA interconnects.</p>
Distorted sound.	<p>Check that the Input Level Control is set to match the signal level of the head unit. Always try to set the Input Level as low as possible.</p> <p>Check that all crossover frequencies are properly set.</p> <p>Check for short circuits on the speaker leads.</p>
Amplifier gets very hot.	<p>Check that the minimum speaker impedance for the amp model is correct.</p> <p>Check that there is good air circulation around the amp. In some applications, it may be necessary to add an external cooling fan.</p>
Engine noise (static type)	<p>This is usually caused by poor quality RCA cables, which can pick up radiated noise. Use only the best quality cables, and route them away from power cables.</p>
Engine noise (alternator whine)	<p>Check that the RCA grounds are not shorted to the vehicle chassis.</p> <p>Check that the head unit is properly grounded.</p>

Specifications



MODEL	<i>12" Amplified Subwoofer</i> BASS1000
Maximum power	1000W
RMS power	500W
THD	<0.4%
Signal-to-noise ratio	>90dB
Frequency response	20Hz - 150Hz
Input sensitivity, high level	110mV
Input sensitivity, low level	0.5V
Low pass filter	50Hz -150Hz
Bass Boost	0 to +12dB
Fuse rating	25A
Dimensions	14.2" x 14.2" x 12.2"

All specifications subject to change without notice.

Notes



Free Manuals Download Website

<http://myh66.com>

<http://usermanuals.us>

<http://www.somanuals.com>

<http://www.4manuals.cc>

<http://www.manual-lib.com>

<http://www.404manual.com>

<http://www.luxmanual.com>

<http://aubethermostatmanual.com>

Golf course search by state

<http://golfingnear.com>

Email search by domain

<http://emailbydomain.com>

Auto manuals search

<http://auto.somanuals.com>

TV manuals search

<http://tv.somanuals.com>