



CX150 *Two Channel
High Power Car Audio
Amplifier*

CX350 *Four Channel
High Power Car Audio
Amplifier*

**Congratulations on your
purchase of a 
CHAOS EXXTREME Amplifier.**

It has been designed, engineered and manufactured to bring you the highest level of performance and quality, and will afford you years of listening pleasure.

Thank you for making 
your choice for car audio
entertainment!

USER'S MANUAL

<i>page</i>	CONTENTS
2	Introduction
2	What is included?
3	Features
3	About 2 Ohm operation
4	General precautions
4	Installation precautions
5	Mounting the amplifier
6	Connecting the amplifier
7	Low level input wiring
8	High level input wiring
9	Power and Speaker wiring
10	Troubleshooting
11	Specifications

Introduction

With the **BOSS** AUDIO SYSTEMS CHAOS EXXTREME amplifier series, we are introducing introducing two new models, both designed in the USA. This new series includes a 2-channel and a 4-channel amplifier.

These CHAOS EXXTREME models feature a low pass crossover (one for each channel on the CX350), and both high level and RCA low level inputs on the front panel. Input level can be precisely controlled by variable input gain controls.

These features help you integrate the amp into your system regardless of the nature of your input source.

What is included?

When first unpacking your new amplifier, please check first that the package contains all of the items below. If something is missing, contact the store where you purchased the player.

- **CHAOS EXXTREME amplifier**
- **High input cable with connector**
- **Four (4) mounting screws**

Features

Your new CHAOS EXXTREME amplifier features the following:

- **2 Ohm stable stereo operation with output power increase**
- **Thermal and speaker short protection**
- **Soft turn-on circuit**
- **Remote turn-on/turn-off circuit**
- **Variable input gain control**
- **Nickel-plated RCA low level and high level inputs**
- **LED power and protection indicators**
- **Silver anodized heatsink**

About 2 Ohm operation

Your CHAOS EXXTREME amplifier has been designed to operate efficiently at loads down to 2 Ohms. This means that you can install four 8 Ohm speakers per channel, *when using parallel wiring.*

Increasing the number of woofers per channel at low frequencies (below 100Hz) produces an acoustic coupling effect. This acoustic coupling effect increases your power output by about 3dB per speaker, or the equivalent of an additional 10W per speaker.

When operating at 2 Ohms, the amplifiers will increase their output power by approximately 50%. *The current draw will also increase by about the same amount, so be sure you have enough current to run the amplifiers into a 2 Ohm load.*

If you lack adequate current, your music reproduction will be distorted.

General precautions

Before installing and using your new BOSS amplifier, please become familiar with all the information contained in this manual.

Please keep this manual in a safe place for future reference.

- Do not open or attempt to repair this unit yourself. Dangerous high voltages are present which may result in electric shock. Refer any repairs to a qualified service technician.
- To avoid risk of electronic shock or damage to the amplifier, do not permit any of this equipment to become damp or wet from water or drinks. If this does occur, immediately unplug the power wires and send the amplifier to your local dealer or service center as soon as possible.
- If there is smoke or any peculiar odor present during use or if there is damage to any of the component enclosures, immediately unplug the power cord and send the amplifier to your local dealer or service center as soon as possible .

Installation precautions

Before you drill or cut any holes, investigate your car's layout very carefully. Take special care when you work near the gas tank, fuel lines, hydraulic lines and electrical wiring.

Never operate the amplifier when it is unmounted. Attach all audio system components securely to prevent damage, especially in an accident.

Before making or breaking power connections in your system, disconnect the vehicle battery. Confirm that your head unit or other equipment is turned off while connecting the input jacks and speaker terminals.

If you need to replace the power fuse, replace it only with a fuse identical to that supplied with the amplifier. Using a fuse of a different type or rating may result in damage to your audio system or your amplifier which is not covered by the manufacturer's warranty.

SHOCK HAZARD! Do not open the case of this product. There are dangerous voltages present within the unit. There are no user-serviceable parts within the unit.

Mounting the amplifier

1. Find a suitable location in the vehicle in which to mount the amplifier.
2. Make sure there is sufficient air circulation around the intended mounting location.
3. Mark the location for the mounting hole screws by positioning the amplifier where you wish to install it. Use a scribe or mounting screw, inserted through each of the amp's mounting holes, to mark the mounting surface. If the mounting surface is carpeted, measure the hole centers and mark with a felt tip pen.
4. Drill pilot holes in the mounting surface for the mounting screws. Place the amplifier in position, and attach the amplifier to the mounting surface securely using screws.

Connecting the amplifier

Before doing any wiring, look through this manual and identify the diagrams to follow for power, input and speaker connections for your particular installation. Be sure you understand all the connections before you proceed.

1. Connect the power ground terminal to the closest point on the chassis of the car. Keep this ground wire to less than 39" (100 cm) in length. Use 8 gauge (or heavier) wire.
2. Connect the remote terminal to the remote output of the head unit using 16 gauge (or heavier) wire.
3. Connect an empty fuse holder within 18" (45 cm) of the car battery, and run 8 gauge (or heavier) cable from this fuse to the amplifier location.
4. Check that the fuse holder is empty. Then connect the fuse holder to the "BATT+" connection on the amplifier.
5. If multiple amplifiers are being used in your system, either:
 - Run a separate pair of cables from the battery and a chassis ground point to each amplifier. Each (+) cable must have its own inline fuse.
 - or-
 - Run a #4 cable from the fuse holder at the battery to a distribution block at or near the amplifier's location. Then run separate cables from the amplifier to this distribution block and to independent chassis ground points.
6. Connect all line inputs and outputs (if used) using high-quality cables. Connect all speakers, following the diagrams in this manual. Be sure to observe proper polarity to avoid audio phase problems.

7. Insert fuse(s) into the battery fuse holder(s).
8. Recheck all connections before powering up the amplifier.
9. Set all level controls to minimum position, and set all crossover controls/switches to the desired frequency points.
10. Power up the head unit and the amplifier. Then set the volume control on the head unit to about 3/4 volume, and adjust the amplifier's input level control(s) to just below the level of distortion.
11. Further fine tuning of the various controls may be necessary to obtain best results.

Don't misuse the level control!

Do not mistake the input level control for a volume control! It is designed ONLY to match the output level of your audio source to the input level of your amplifier.

Do not adjust this input level to maximum unless your input level requires it.

Ignoring these instructions will result in an input overload to the amplifier, and excessive audio distortion. It can also cause the protection circuit to engage.

Low Level Input Wiring

Low-level (RCA) input wiring is preferred for best audio performance. Always use a high-quality RCA cable for best audio performance.

NOTE: Do not connect **BOTH** the high level and low level inputs from your receiver to your amplifier at the same time!

2-Channel Amplifier CX150

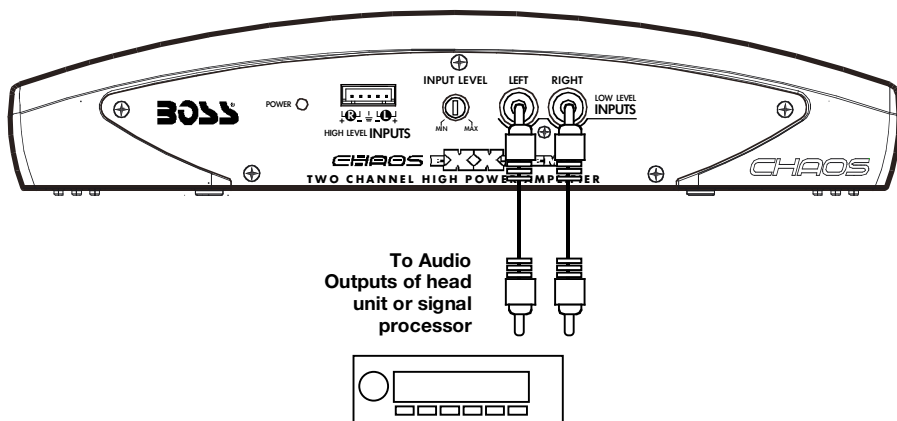

4-Channel Amplifier CX350

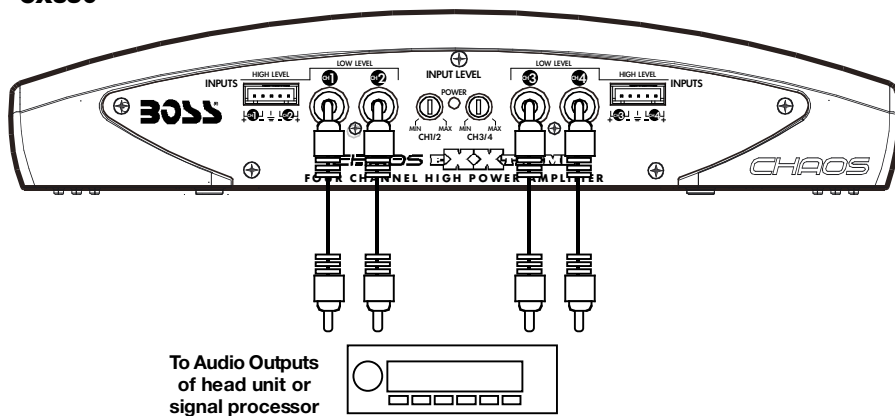

High Level Input Wiring, cont.

The high level input(s) should only be used when your head unit lacks RCA outputs. If the RCA outputs are not present, connect the speaker outputs from the receiver to the high level input connector of the amplifier. Be sure to observe polarity to avoid audio phase problems.

NOTE: Do not connect BOTH the high level and low level inputs from your receiver to your amplifier at the same time!

2-Channel Amplifier CX150

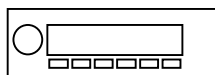
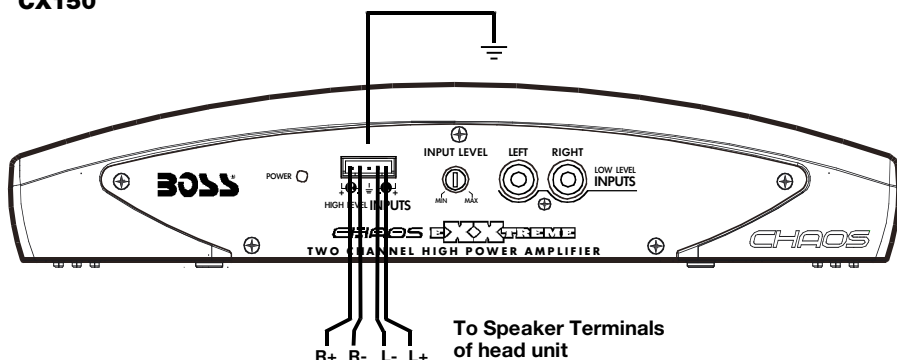

4-Channel Amplifier CX350

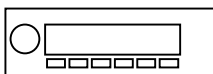
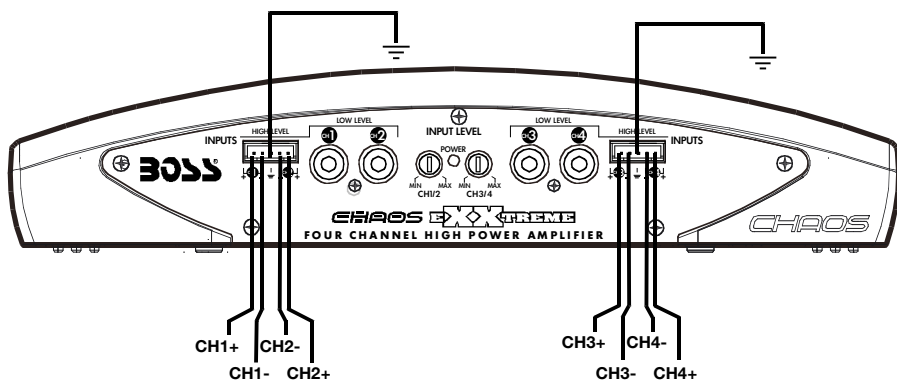

Power and Speaker Wiring

2-Channel Amplifier CX150

Two Channel Mode

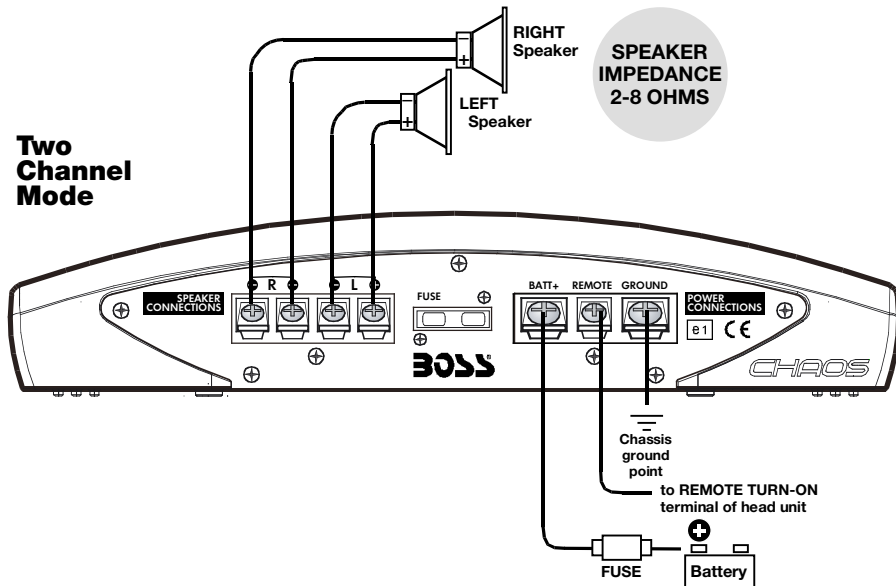

Four Channel Mode

4-Channel Amplifier CX350

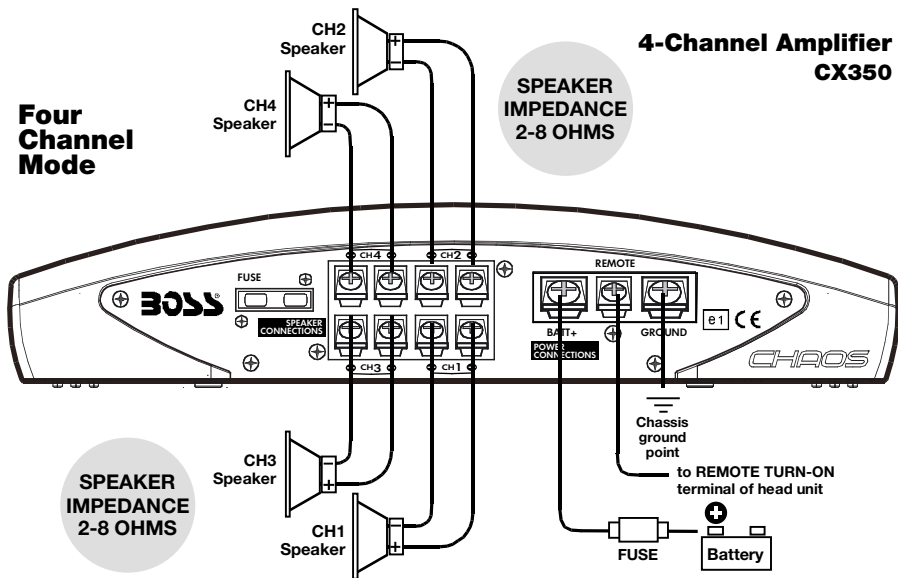

Troubleshooting

If you experience operation or performance problems with this product, compare your installation with the electrical wiring diagram on the previous pages. If problems persist, read the following troubleshooting tips which may help eliminate the problems.

SYMPTOM	POSSIBLE REMEDY
Amplifier will not power up.	<p>Check to make sure you have a good ground connection.</p> <p>Check that the Remote Input (Turn-On) has at least 3VDC.</p> <p>Check that there is battery power on the (+) terminal.</p> <p>Check that there is at least 12v.</p> <p>Check all fuses, replace if necessary.</p> <p>Make sure that the Protection LED is not illuminated. If it is lit, shut off the amplifier briefly, and then repower it.</p>
Protection LED comes on when amplifier is powered up.	<p>Check for short circuits on speaker leads.</p> <p>Turn down the volume control on the head unit to prevent overdriving.</p> <p>Remove speaker leads, and reset the amplifier. If the Protection LED still comes on, then the amplifier is faulty and needs servicing.</p>
No output.	<p>Check that all fuses are OK.</p> <p>Check that amplifier is properly grounded.</p> <p>Check that the Remote Input (Turn-On) has at least 3VDC.</p> <p>Check that the RCA audio cables are plugged into the proper inputs.</p> <p>Check all speaker wiring.</p>
Low output.	<p>Reset the Level Control.</p> <p>Check the Crossover Control settings.</p>
Audio present in only one channel.	<p>Check the RCA interconnect cables.</p> <p>Check all speaker wiring.</p>
High hiss in the speakers.	<p>Disconnect all RCA inputs to the amplifiers. If the hiss disappears, then plug in the component driving the amplifier and unplug its inputs. If the hiss disappears at this point, go on until the faulty/noisy component is found.</p> <p>It is best to set the amplifier's input level control as low as possible. The best subjective signal-to-noise ratio is achieved in this manner. Try to set the head unit as high as possible (without distortion) and the amp input level as low as possible.</p>
Squealing noise from speakers.	<p>Check for improperly grounded RCA interconnects.</p>
Distorted sound.	<p>Check that the Input Level Control is set to match the signal level of the head unit. Always try to set the Input Level as low as possible.</p> <p>Check that all crossover frequencies are properly set.</p> <p>Check for short circuits on the speaker leads.</p>
Amplifier gets very hot.	<p>Check that the minimum speaker impedance for the amp model is correct.</p> <p>Check that there is good air circulation around the amp. In some applications, it may be necessary to add an external cooling fan.</p>
Engine noise (static type)	<p>This is usually caused by poor quality RCA cables, which can pick up radiated noise. Use only the best quality cables, and route them away from power cables.</p>
Engine noise (alternator whine)	<p>Check that speaker leads are not shorted to the vehicle chassis.</p> <p>Check that the RCA grounds are not shorted to the vehicle chassis.</p> <p>Check that the head unit is properly grounded.</p>

Specifications



MODEL	<i>Two Channel Car Audio Amplifier</i>	<i>Four Channel Car Audio Amplifier</i>
	CX150	CX350
RMS POWER into 4 Ohms	50W x 2	50W x 4
MAX POWER into 2 Ohms	100W X 2	100W X 4
Min. speaker impedance	2 Ohms	2 Ohms
THD	0.01%	0.01%
Frequency response	12Hz-22kHz	12Hz-22kHz
Signal-to-noise ratio	90dB	90dB
Channel separation	60dB	60dB
Fuse rating	7.5A x 1	15A x 1
Dimensions: (9-7/8" x 2-3/16" x ...)	6-1/8"	7-3/4"

All specifications subject to change without notice.

Notes



Free Manuals Download Website

<http://myh66.com>

<http://usermanuals.us>

<http://www.somanuals.com>

<http://www.4manuals.cc>

<http://www.manual-lib.com>

<http://www.404manual.com>

<http://www.luxmanual.com>

<http://aubethermostatmanual.com>

Golf course search by state

<http://golfingnear.com>

Email search by domain

<http://emailbydomain.com>

Auto manuals search

<http://auto.somanuals.com>

TV manuals search

<http://tv.somanuals.com>