

User's Manual

BV9350

**IN-DASH DOUBLE-DIN
DVD/MP3/CD RECEIVER
WITH 6.2-INCH WIDESCREEN
TOUCHSCREEN TFT MONITOR
WITH USB AND SD MEMORY CARD PORTS
AND FRONT PANEL AUX INPUT**

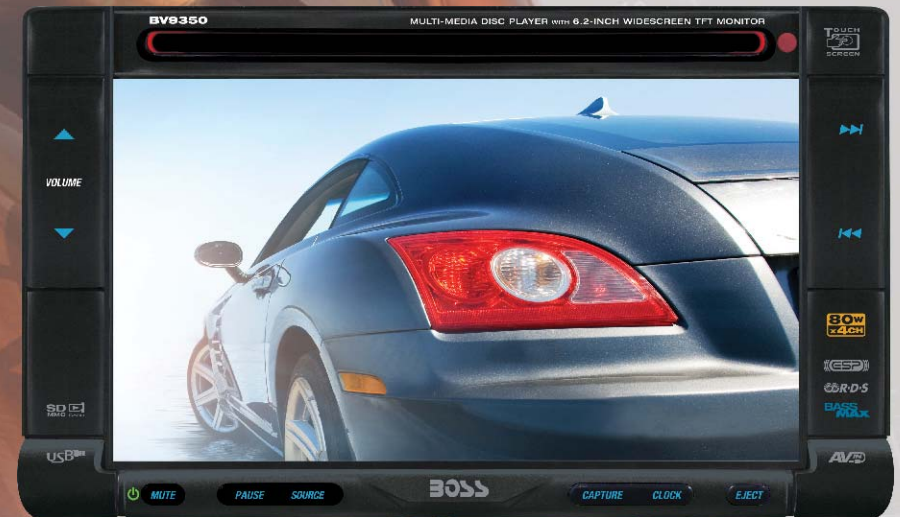

BV9350

**IN-DASH DOUBLE-DIN
DVD/MP3/CD RECEIVER
WITH 6.2-INCH WIDESCREEN
TOUCHSCREEN TFT MONITOR
WITH USB AND SD MEMORY CARD PORTS
AND FRONT PANEL AUX INPUT**

01.2010

tech support: www.bossaudio.com/support



10 R - 02 1011

BOSS Audio Systems • 3451 Lunar Court • Oxnard, CA 93030

www.bossaudio.com

800.999.1236

BOSS[®]
AUDIO SYSTEMS

BOSS[®]
AUDIO SYSTEMS

Warnings

▶ When Driving

Keep the volume level low enough to where it allows you to be aware of the road and traffic conditions.

▲ CAUTION

In some countries, it's unlawful to operate a vehicle while video is displayed in the driver's viewing area. Please always switch the unit's display to "Font Type Display" mode by pressing the DISP button while driving.

For safety reason, the driver should only enjoy / watch the video while the car is in parking mode.

▶ When Car Washing

Do not expose the product to water or excessive moisture. This could cause electrical shorts, fire or other damage.

▲ CAUTION

In order to avoid any accident, the driver must not watch video while driving. This unit is designed to not allow watching video while driving. Park your car in a safe place and engage the 'parking brake' before watching video.

▶ When Parked

Parking in direct sunlight can produce very high temperatures inside your vehicle. Give the interior a chance to cool down before starting playback.

▶ Use the Proper Power Supply

This product is designed to operate with a 12 volt DC, negative ground battery system (the regular system in a North American car).

▶ Protect the Disc Mechanism

Avoid inserting any foreign objects into the slot of this player. Failure to follow this may cause malfunction or permanent damage due to the precise mechanism of this unit.

▲ CAUTION

THIS MOBILE DVD PLAYER IS A CLASS I LASER PRODUCT. THIS UNIT USES A VISIBLE/INVISIBLE LASER BEAM WHICH COULD CAUSE HAZARDOUS RADIATION IF EXPOSED DIRECTLY. BE SURE TO OPERATE THE MOBILE DVD PLAYER CORRECTLY AS INSTRUCTED.

USE OF CONTROLS OR ADJUSTMENTS OR PERFORMANCE OR PROCEDURES OTHER THAN THOSE SPECIFIED HEREIN MAY RESULT IN HAZARDOUS RADIATION EXPOSURE.

DO NOT OPEN COVERS AND DO NOT REPAIR BY YOURSELF PLEASE REFER SERVICING TO A QUALIFIED TECHNICIAN.

NOTE:

1. TO REDUCE THE RISK OF FIRE OR ELECTRIC SHOCK, DO NOT EXPOSE THIS EQUIPMENT TO RAIN OR MOISTURE.
2. TO REDUCE THE RISK OF FIRE OR ELECTRIC SHOCK, AND ANNOYING INTERFERENCE, USE ONLY THE RECOMMENDED ACCESSORIES.
3. THIS DEVICE IS INTENDED FOR CONTINUOUS OPERATION.

This product incorporates copyright protection technology that is protected by method claims of certain U.S. Patents and other intellectual property rights owned by Macrovision Corporation and other rights owners. Use of this copyright protection technology must be authorized by Macrovision Corporation, and is intended for home and other limited viewing uses only unless otherwise authorized by Macrovision Corporation. Reverse engineering or disassembly is prohibited.

Installation

⚠ INSTALLATION CAUTION

1. Before finally installing the unit, connect the wiring temporarily and make sure it is all connected up properly and the unit and system work properly.
2. Use only the parts included with the unit to ensure proper installation. The use of unauthorized parts can cause malfunctions.
3. Consult with your nearest dealer if installation requires the drilling of holes or other modifications of the vehicle.
4. Install the unit where it does not get in the driver's way and cannot injure the passenger if there is a sudden stop, like an emergency stop.
5. If installation angle exceeds 30° from horizontal, the unit might not give its optimum performance.

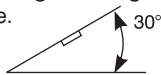

6. Avoid installing the unit where it would be subject to high temperature, such as from direct sunlight, or from hot air, from heater, or where it would be subject to dust dirt or excessive vibration.
7. Be sure to remove the front panel before installing the unit.

➤ Installation with the half sleeve

After inserting the half sleeve into the dashboard, select the appropriate tab according to the thickness of the dashboard material and bend them inwards to secure the holder in place.

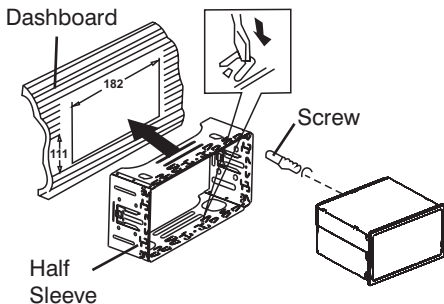

Attach the trim ring

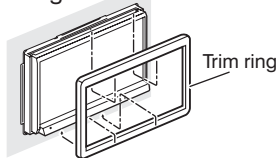

➤ Installation using the screw holes on the side of the unit

Select a position where the screw holes of the bracket and the screw holes of the main unit become aligned (are fitted) and tighten the screws at 2 places on each side.

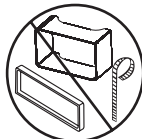
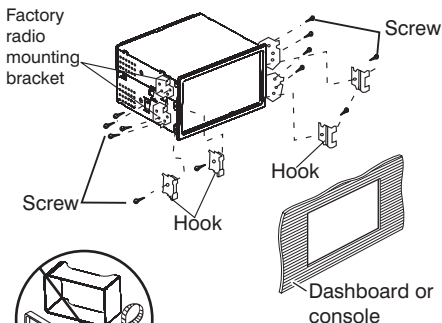
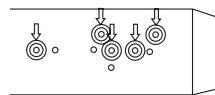

Note: The outer trim ring, and half-sleeve are not used for this installation.

Note: The mounting box, metal half sleeve, hook & screws are not included in the packnig.

➤ RESETTING THE UNIT

After releasing the front panel, use a stick or any non-metallic object to press & hold the reset button for five seconds to reset the unit.

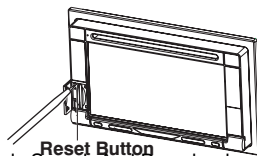

Connecting the System

Wiring Diagram - Power / Speakers

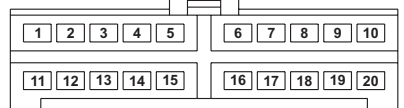
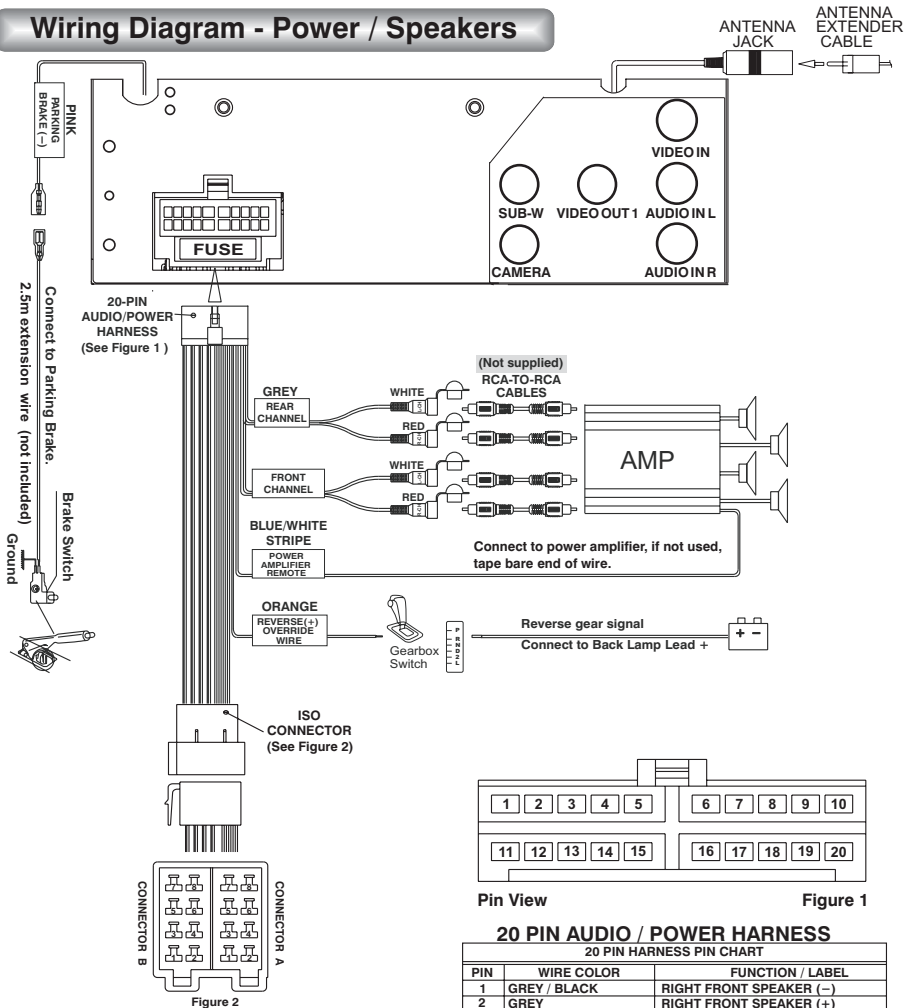

Pin View Figure 1

20 PIN AUDIO / POWER HARNESS

20 PIN HARNESS PIN CHART		
PIN	WIRE COLOR	FUNCTION / LABEL
1	GREY / BLACK	RIGHT FRONT SPEAKER (-)
2	GREY	RIGHT FRONT SPEAKER (+)
3	VIOLET	RIGHT REAR SPEAKER (+)
4	VIOLET/BLACK	RIGHT REAR SPEAKER (-)
5		
6	GREEN	LEFT REAR SPEAKER (+)
7	GREEN / BLACK	LEFT REAR SPEAKER (-)
8	RED	IGNITION (ACC)
9	BLACK	REAR PRE-AMPLIFIER LINE OUT COMMON
10	RED	RIGHT REAR PRE-AMPLIFIER LINE OUT
11	WHITE	LEFT FRONT SPEAKER (+)
12	WHITE / BLACK	LEFT FRONT SPEAKER (-)
13	BLUE/WHITE	POWER AMPLIFIER REMOTE (+)
14	BLUE	POWER ANTENNA
15	YELLOW	BATTERY (+)
16	BLACK	CHASSIS GROUND
17	WHITE	LEFT FRONT PRE-AMPLIFIER LINE OUT
18	RED	RIGHT FRONT PRE-AMPLIFIER LINE OUT
19	BLACK	FRONT PRE-AMPLIFIER LINE OUT COMMON
20	WHITE	LEFT REAR PRE-AMPLIFIER LINE OUT



ISO CONNECTOR 4 PIN + 8 PIN FEMALE WITH MALE TERMINAL

ISO CONNECTOR WIRING CHART		
PIN	WIRE COLOR	FUNCTION / LABEL
A4	YELLOW	BATTERY(+)
A5	BLUE	POWER ANTENNA
A7	RED	IGNITION(ACC)
A8	BLACK	GROUND
B1	VIOLET	RIGHT REAR SPEAKER (+)
B2	VIOLET / BLACK	RIGHT REAR SPEAKER (-)
B3	GREY	RIGHT FRONT SPEAKER (+)
B4	GREY / BLACK	RIGHT FRONT SPEAKER (-)
B5	WHITE	LEFT FRONT SPEAKER (+)
B6	WHITE / BLACK	LEFT FRONT SPEAKER (-)
B7	GREEN	LEFT REAR SPEAKER (+)
B8	GREEN / BLACK	LEFT REAR SPEAKER (-)

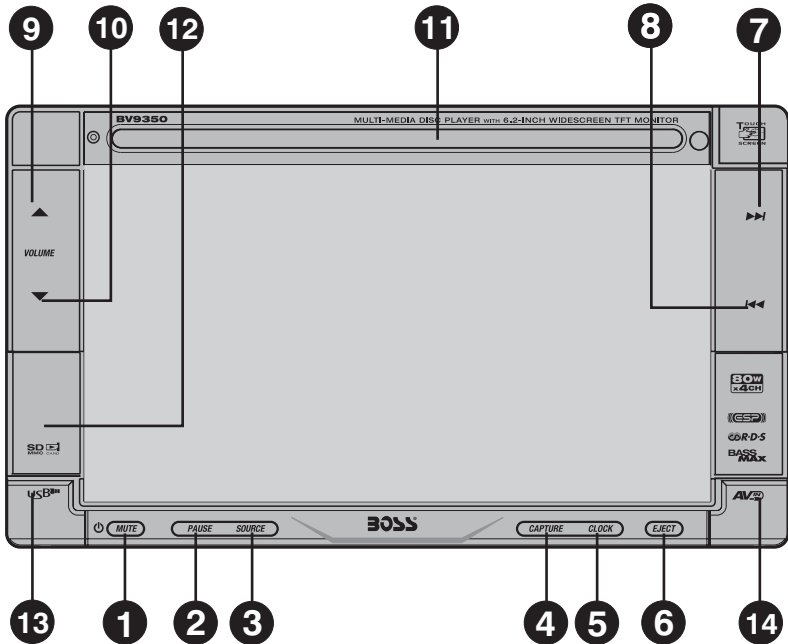

Name Of Buttons and Theirs Functions

Source Unit



No.	Item	Decriptions
1	 (MUTE)	Press this button to turn the mute On / Off.
1	PWR (POWER)	Press this button or any other button on the front panel to turn the unit on. Hold & press this button again to turn the unit off.
2	 (PLAY/PAUSE)	Press this button to Pause / resume Play the music under Media player mode.
3	SOURCE	Press this button to select different source playback mode: TUNER/DISC/USB/SD CARD/BT AUDIO/AV IN MODE
4	CAPTURE	During video/image playback, press this button can capture images and store them (up to 10 images) to set as wallpaper. You can also capture an image from an auxiliary video device, if connected.
5	CLOCK	Press this button to enter into the Clock mode, press this button again then return previous mode.

Name Of Buttons and Theirs Functions

6	 (EJECT)	Press this button to eject the Disc.
7		Under the tuner mode, press this button access Auto Seek mode. Under the media player mode, press this button to skip backward of the previous chapter.
8		Under the tuner mode, press this button access Auto Seek mode. Under the media player mode, press this button to skip forward of the next chapter.
9	VOLUME +	Press this button to increase the volume.
10	VOLUME -	Press this button to decrease the volume.
11	DISC SLOT	Insert the disc into CD slot. The CD will begin to play.
12	SD CRAD SLOT (The SD Card slot behind the SD Card door.)	This unit can support playback MP3/WMA/JPEG/MPEG4/DIVX format which are stored on the SD Card.
13	USB SLOT (The USB slot behind the USB door.)	This unit can support playback MP3/WMA/JPEG/MPEG4/DIVX format which are stored on the USB memory stick.
14	AUX IN JACK (The AUX IN slot behind the AUX IN door.)	This unit is allowed to connect with external Audio/Video system such like Digital Camera or Game Console. User can connect the external A/V system thru the A/V in jack on front panel.





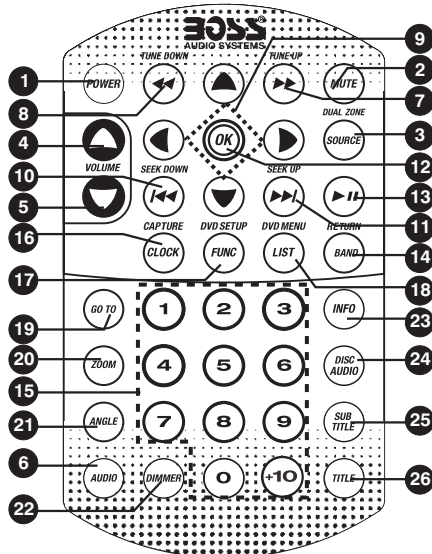













Name Of Buttons and Theirs Functions

Remote Control



No.	Button	Item	Decriptions
1		POWER ON OFF	When the unit is power on, long press this button to turn Off the unit. Once the unit power off, press this button to turn On the unit.
2		MUTE	Press this button to turn the mute On / Off.
3		SOURCE 2 ZONE MODE	Press this button to enter into the SOURCE mode. Long press this button to enter into the Bluetooth transfer mode. Once the Dual zone turns on, press this button to change Front zone or Rear zone.
4		VOLUME +	Press this button to increase the volume.
5		VOLUME -	Press this button to decrease the volume.
6		AUDIO	Press this button to enter into the AUDIO mode.
7			Under the tuner mode, press this button to access the Manual Seek mode. Under the media player mode, press this button fast forward through the music under media player mode.
8			Under the tuner mode, press this button to access the Manual Seek mode. Under the media player mode, press this button fast backward through the music under media player mode.

Name Of Buttons and Theirs Functions

9		UP/DOWN LEFT/RIGHT	Use these buttons to move cursor up/down/left/right.
10		◀◀	Under the tuner mode, press this button access Auto Seek mode. Under the media player mode, press this button to skip backward of the previous chapter.
11		▶▶	Under the tuner mode, press this button access Auto Seek mode. Under the media player mode, press this button to skip forward of the next chapter.
12		ENTER	Use this button to confirm the selection.
13		PLAY/PAUSE	Press this button to Pause / resume Play the music under media player mode.
14		BAND	Press this button to return previous menu. Under the tuner mode, press this button to access the BAND mode.
		ESC	Press this button to quick return previous menu or playback mode.
15		NUMERIC BUTTONS	When playback the media use for track or file number direct access and use when function need numeric selection or input.
		CLOCK	Press this button to enter into the Clock mode.
16		CAPTURE	During video/image playback, press this button can capture images and store them to set as wallpaper.
		FUNCTION	Press this button to enter into the function mode.
17		F	
18		LIST	Under tuner mode,press this button to Show The List of stored station. Under the Media playback mode, press this button to list the searching of Tracks or Files on the Media playback mode. Under the DVD/MP4 mode, press this button to list the searching of DVD Root Menu or Files on the playback mode. Under the VCD mode, press this button to turn On/Off thePCB function.
		GOTO	Under the DVD mode, press this button to pop up the search Menu.
19		GOTO	
20		ZOOM	When playback the DVD, press this button repeatedly increases the magnification level.
21		ANGLE	Under DVD mode, press this button while playing a scene recorded with multiple angles to change the angle.
22		DIMMER	Press this button adjust the screen brightness.
23		INFO	Press this button to viewing the information.
24		DISC AUDIO	Under DVD mode, press this button during playback to change the audio language.
25		SUBTITLE	Under DVD mode, press this button during playback to turn on/off subtitles and change the subtitles.
26		TITLE	Under DVD mode, press this button to bring up the Title Menu.

General Operations

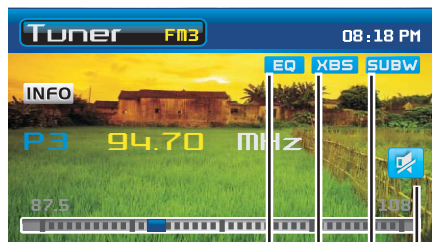
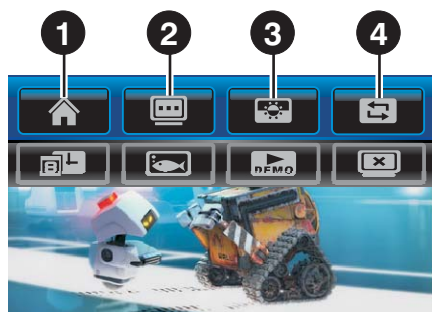

5 6 7 8

SOURCE

Under the SOURCE menu, the below options are available for selection:

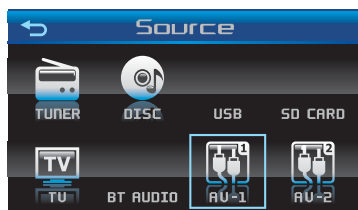

NOTE

Please note not all the Optional Source / feature is available with each unit.

POWER OFF

Tap  button to power off the unit, and the below display will be shown on TFT:



1 HOME MENU

Tap  button on the display enter into the Home Menu, and there have SETUP, SOURCE, OFF options for selection.





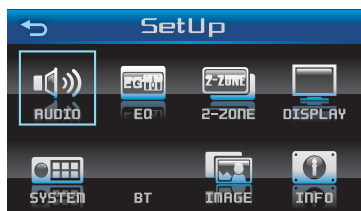

SETUP

Under the SETUP menu, the below options are available for selection:



2 MOTION PICTURES DISPLAY MODE

The units have 4 different types of motion pictures that can be displayed on TFT under playback Mode. Tap  button on display to repeatedly can switch between the 4 difference modes.

- Tap  button is Clock & Date display mode
- Tap  button is Virtual Aqua display mode
- Tap  button is DEMO mode

General Operations

TIPS

DEMO display mode demonstrates the major highlight functions that are available on this unit.

- Tap  button is Monitor Off mode

TIPS

To turn back on, touch anywhere on the display or press any button on the front panel.

NOTE

Tapping  button switches thru each of the three different Motion Picture modes. The TFT screen will have around 1-2 seconds 'BLANK' screen (dark screen). This is normal because during these 1-2 seconds BLANK screen it is re-loading the next motion pictures.

3 TFT BACKLIGHT DIMMER CONTROL

User can adjust the TFT backlight on the screen. Tap  button on display to adjust the Dimmer level between High / Mid / Low.

4 GALLERY DISPLAY MODE

Tap  button to preview the captured images which stored in My Image, and set it to wallpaper.

TIPS

For details operation of My Gallery, please refer to page of **Wallpaper Setting**.

5 PRESET EQ MODE

Tap  button to quickly enter into the EQ menu select different types.

6 iX-BASS

Tap  button to quickly enter into the iX-Bass function.

7 SUBWOOFER

Tap  button to quickly enter into the Subwoofer function.

8 MUTE BUTTON

Tap  button to mute on the audio volume, Tap this button again to restore volume to the previous setting.

SetUp Menu Operations

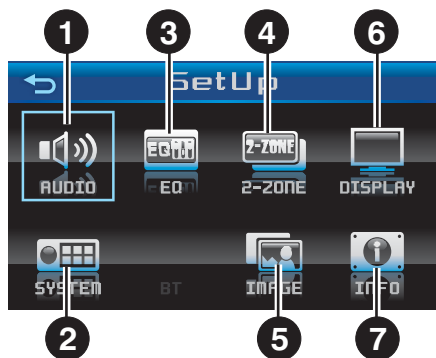

Middle

1. Level: adjust the Middle level from -06 to +06.
2. C.Freq: adjust the Middle Range center frequency as 500Hz, 1KHz, 1.5KHz, or 2.5KHz.
3. Mid.q: adjust the desired Middle Quality Factor to 1N, 2N, 1W or 2W.

Balance

To adjust the Balance between the right and left speakers from R12 to L12. Balance Center for this unit is Balance C00.

Fader

To adjust the Fader between the front and rear speakers from R12 to F12. Fader Center for this unit is Fader C00.

1 AUDIO MENU

Tap  button to access into the Audio Menu. The below audio setting can be select:

iX-Bass

1. Level: adjust the iX-BASS level from Low, Middle or High.
2. P.FREQ: adjust the iX-BASS peak frequency as 400Hz, 800Hz or 2.4KHz.

Sub-W

1. Level: adjust the Subwoofer lever from 00 to 12.
2. LPF: adjust the Low pass filter (LPF) as Flat, 80Hz, 120Hz or 160Hz.

Bass

1. Level: adjust the Bass level from -06 to +06.
2. C.Freq: adjust the Bass center frequency as 60Hz, 80Hz, 100Hz, or 200Hz.
3. Bass-q : adjust the Bass Quality Factor as 1N, 2N, 1W or 2W.

Treble

1. Level: adjust the Treble level from -06 to +06.
2. C.Freq: adjust the Treble center frequency (C.FREQ) as 10KHz, 12.5KHz, 15KHz, or 17.5KHz

Treble

1. Level: adjust the Treble level from -06 to +06.
2. C.Freq: adjust the Treble center frequency (C.FREQ) as 10KHz, 12.5KHz, 15KHz, or 17.5KHz

2 SYSTEM MENU

Tap  button to access into the System Menu. The below system menu setting can be select:

Date Set

Press the Volume Up / Down or Touch screen  &  buttons to adjust the Date / Month / Year.



Clock Set

Press the Volume Up / Down or Touch screen  &  buttons to adjust the Hour / Minute / AM/PM.

Beep Tone

To adjust the Beep Tone On / Off. The beep tone feature allows the selection of an audible beep tone to be heard each time a audible is pressed on the face of the radio. "BEEP TONE ON" is the default display.

Program Volume

This option allows the adjustment of the volume level of the radio will automatically assume when the unit turn on. To program a specific turn on volume level. Touch screen  &  buttons to select "VOLUME LEVEL" level from 00 to 46.

Setup Menu Operations

3 PRESET EQ SETTING



Tap  button to access into the EQ Menu. Under the Preset EQ Setting, there are the below 8 different types of preset equalizer available for user selection.



Default

This option allows the user to change the background screen from wallpaper to factory default screen.

NOTE

If you don't like the pre-loaded pictures, you can press  button to select Erase Current or Erase All.

Free Memory

This feature allows the user to check the remaining memory capacity of images for capture.

TIPS

This unit max can capture 10 images and pre-store into My Image.

4 2-Zone



Tap  button to access into the 2-Zone menu.

1. If Front Zone is selected, press the volume Up / Down to navigate through different modes: Tuner > BT are available for selection of the Front Zone or AV output.
2. If Rear Zone is selected, press the volume Up / Down to navigate through different modes: Tuner > Disc > Card > BT > AV-1 > AV-2 are available for selection of the Rear Zone or AV output.

5 Image Setting



Tap  button to access into the Image Setting Menu. In this menu user can select his/her favor image use as wallpaper on the playback mode. There is two sources of image for selection:

My Gallery

This unit contains 10 pre-loaded images. User can select these 10 pre-loaded images set as wallpaper on the playback mode.

My Image

This unit allows the user to self-capture from VIDEO or JPEG picture. User can select these 10 pre-loaded pictures set as Wallpaper.

6 Display Setting



Tap  button to access into the Display Setting menu, and there are have below options for selection:

Standby

Under "Ignition On But Power Off" condition, this unit have the following different types of Standby display for selection:

- Standby Off: To turn off the unit.
- Clock: To display the Clock on TFT.
- Aquarium: To display the Virtual Aqua Screen on TFT.
- Demo: To automatically demo this unit's major features.

Dimmer

To adjust the TFT Backlight level between High / Mid / Low.

SetUp Menu Operations

Calibration

Tap  button on the Display Setting menu screen to start the Calibration setting.

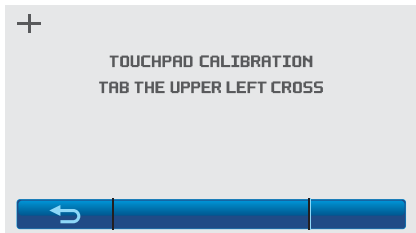

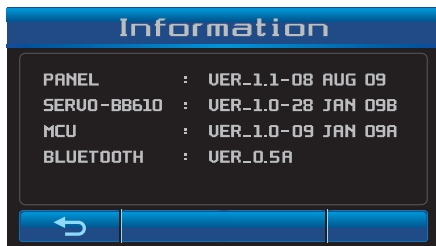

7 Information

Touch screen  button to view this unit system software version.

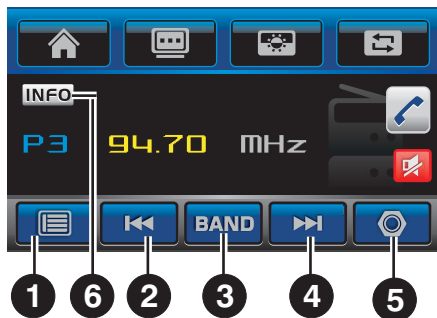

Tuner Operation





Under the SOURCE menu, tap  button access into the Tuner playback mode.

1 LIST MENU

Tap  button access into the Store List to select the desired station to Recall.

2 & 4 TUNING UP/DOWN

Tap   buttons to access the Auto Seek mode. Long tap these buttons to access the Manual Seek mode.

3 BAND

Tap  button to change between FM bands and or AM(MW) bands.

5 FUNCTION MENU

Tap  button access into the Function Menu, and there have below functions are allow to operation:

Manual Store

Use this function to saved the current frequency to memory station.

Auto Store

After Auto Store saves (all) 6 stations, it will automatically enter present scan one time.

Local Seek

This feature is used to designate the strength of the signals at which the radio will stop during automatic tuning. "Distance" is the default, allowing the radio to stop at a broader range of signals. To set the unit to select only strong local stations during automatic tuning, tap  bar to select the local ON/OFF.

Tuner Area

This option allows the selection of the frequency spacing which is most appropriate for the status the unit is in, U.S.A, EUROPE.

● AF On/Off

Tap  bar to change AF in On or Off mode.

● TA On/Off

Tap  bar to change TA in On or Off mode.

● PTY Seek

Tap  button access into the PTY list to select the desired PTY mode. There have below programs type for selection:

MUSIC GROUP	SPEECH GROUP
POP , ROCK	NEWS, AFFAIRS, INFO
EASY, LIGHT	SPORT EDUCATE, DRAMA
CLASSICS, OTHER	CULTURE, SCIENCE, VARIED
JAZZ, COUNTRY	WEATHER, FINANC, CHILDREN
NATION , OLDIES	SOCIAL, RELIGION, PHONE IN
FOLK , TEST ALARM	TRAVEL, LEISURE, DOCUMENT

NOTE

AF, TA & PTY only appearing in the function list, after changed the Tuner Area to "Europe".

6 RDS INFORMATION

Tap  button to view the RDS information of the unit.

Media Player Operations (Disc/USB/SD Card)

This unit can play various video/audio formats stored into Disc / USB or SD Card on Media Player.

The following chart helps you to check if a disc is supported by this unit, as well as what functions are available for a given disc type.

Disc format
Digital Versatile Discs (DVDs)
Video CDs (VCDs)
Digital Versatile Discs Recordable (DVD+/-R)
Digital Versatile Discs Rewritable (DVD+/-RW)
Compact Discs (CDs)
CD Recordable (CD-R)
CD Rewritable (CD-RW)

Audio Format

Playback CD-DA and MP3 or WMA digital music file on CD-ROM or DVD-ROM or USB or Memory Card.

Note of MP3 and WMA:

Support Maximum 2000 files

Maximum 30 characters display

Supported Sampling frequencies; 32kHz, 44.1kHz, 48kHz.

Supported Bit-Rates: 64-256 kbps variable bit rate

Video Format

Playback IMAGE JPEG, DVD Video, MPEG4 . on CD-ROM or DVD-ROM or USB or Memory Card.

Noted of MPEG4

Supported decoding MPEG-4 video defined by ISO 14496-2 Standard:

1. Simple Profile (SP) and
2. Advance Simple Profile (ASP)

Supported file format: MP4 and .M4a (audio only)

Unsupported Discs

8 cm Disc
CDV, CDI, CDG,
LD
DVD RAM

Note on Region Code

DVD players and DVD Video discs have their own Region Code numbers. This unit can play the disc of all region code numbers.



Disc Maintenance

Before playing, wipe the disc using a clean cloth, working from the center hole towards the outside edge.

Never use benzene, thinners, cleaning fluids or anti-static liquids or any other solvent.



NOTE

A disc may become somewhat scratched (although not enough to make it unusable) depending on you handle it and conditions in the usage environment. Note these scratches are not an indication of any problem with the player.

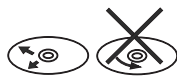

Wipe the disc surface from the center to the edge.

Media Player Operations (Disc/USB/SD Card)

Get into the SOURCE menu to select Disc, USB, SD Card Media Player playback mode.

General Operation



Repeat

- ONE: play the current track repeatedly.
- FOLDER: play all track sin the current folder repeatedly.
- OFF: Repeat Off to cancel all the Repeat function.



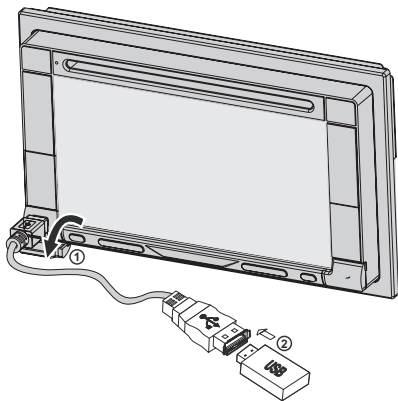

Random

During the disc playback, select Random "On" to play all tracks on a Disc in Random order, select Random "Off" will stop the Random play.



Insert the USB Stick



1 LIST MENU

Tap  button to view the songs list and tap   buttons to select the desired song, then tap  button start to play.

2 & 4 TRACK SELECT

Tap   buttons to move to the next track on the Disc, The selected track number will appear on the display. Press and hold the these buttons for more than one second to fast forward or fast rewind through the media. Disc play when the button is released.

3 PLAY / PAUSE BUTTON

Tap  button to suspend music play. Tap this button again to resume music play.

5 FUNCTION MENU

Tap  button access into the Function Menu, and there are have below options for selection:

CAUTION

This unit does not support any portable Hard disk / drive.

WARNING

Before remove the USB stick from the front panel. Always remember to switch off the unit's power or switch to other mode then remove out the USB Stick. Never try to remove the USB Stick while playing music file on the USB stick. It may damage the USB Stick and may cause permanent damage to the unit will caused the unit system lock up.

Media Player Operations (Disc/USB/SD Card)

Insert the SD Card

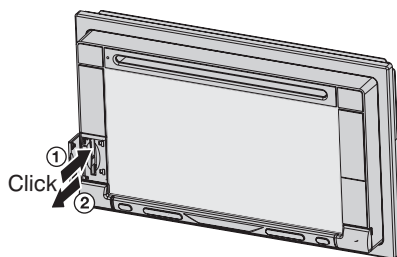
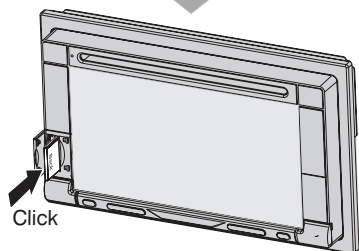
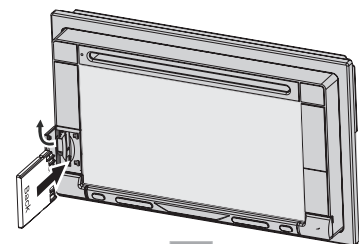

Mode Change to SD Card

After a SD Card was inserted into the main unit card slot. The unit will automatically start playing the files contained on the SD Card.

NOTE

If no SD Card is inserted into the main unit card slot, the unit will return to previous mode.

DVD Operations

Once a DVD disc is inserted into the unit, the unit will automatically start the playback from the beginning of the disc.

NOTE

If the DVD menu appears, touch the display in the desired place to show the controls for item selection.



Touch ◀/▶/▲/▼ to move the cursor, then touch **OK** to confirm.

Playing DVD Disc



1 LIST MENU

Tap **DVD CONTROL** button to open the DVD control menu, which contains the following:

DVD AUDIO

For DVD, the Audio language can be change if the Disc is record with multilingual tracks. Touch **DVD AUDIO** to select the Audio language / format.

SUBTITLE

Touch **SUB TITLE** button to turn on / off the Subtitle language and to change the Subtitles.

ANGLE

Touch **ANGLE** button while playing a scene recorded with multiple angles to change the angle.

TOP MENU

Touch **TOP MENU** button to bring up the Top Menu on the DVD.

NOTE

Some of the above features may not be available, depending on the type of disc.

MENU

Touch **MENU** button to bring up the Menu on the Disc.

2 & 4 TRACK SELECT

1. Touch **⏮** **⏭** these buttons to skip forward to the beginning of the next or previous chapter.
2. Long touch **⏮** **⏭** these buttons to fast forward or fast rewind through the Disc. Touch these buttons again to resume normal playback.

3 PLAY / PAUSE BUTTON

1. Tap **⏸** button to pause playback.
2. Tap **⏸** button again to resume normal playback.
3. Long tap **⏸** button is forward to the next picture in the video (DVD and VCD only.)

5 FUNCTION MENU

Tap  button access into the Function Menu, and there are have below options for selection:

Repeat

- Repeat "CH" to repeat playback the current the chapter.
- Repeat "Title" to repeat playback the current title.
- Repeat " Off " to cancel all the Repeat function.





Disc Audio

During playback to change the audio language (DVD/Divx only).

Video Setting

Top  button access into the Video Setting mode, the below Setup menu will appear:



	Change the Bright level from 01 to 10.
	Change the Contrast level from 01 to 10.
	Change the Color level from 01 to 10.
	Reset to default setting
	Close the Setting menu

DVD Setup

Under the DVD Setup mode, there are have below options for selection:

- **Aspect Ratio:** Selecting the TV Aspect setting allows the user to select the aspect ratio of the TV (DVD and VCD only). The following options are available:

4:3 = Aspect ratio of TV is 4:3.

16:9=Aspect ratio of TV is 16:9. Both wide screen and 4:3 contents will fill the entire screen.

- **TV Signal:** The Video setting allows the user to select the TV standard (DVD and VCD only). The following options are available:

NTSC = TV is NTSC. PAL content is played at NTSC resolution and frame rate (factory default).

PAL = TV is PAL. NTSC content is played at PAL resolution and frame rate.

AUTO = If the content is PAL, the output is PAL. If the content is NTSC, the output is NTSC.

Default

Setting the Default on will reset all options of Media function setting to factory defaults setting.

6 INFORMATION

Tap  button to view the Disc information of the unit.

7 VIDEO SETUP

Tap  button to quickly enter into the video setup mode.

MPEG4 Operations

The unit is support playback MPEG4 files , Tap  button enter into the Disc List to select the Movie mode to light up the MPEG4 playback.

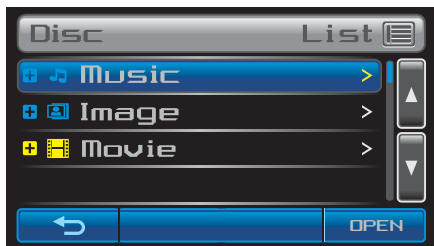

The details operation is exactly the same as Media Playback operation. The following are special functions pertaining to the playback of File:

- Central European = Include Albanian, Croat, Czech, Dutch, English, German, Hungarian, Irish, Polish, Romanian, Slovak, Slovene and Sorbian.
- Cyrillic = Include Bulgarian, Belorussian, English, Macedonian, Moldavian, Russian, Serbian and Ukrainian.

NOTE

User can tap  button into the MPEG4 Function to select the MPEG4 Subtitle.

Mpeg Subtitle



Mpeg Subtitle setting is used for choosing the language domain, (only for MPEG4). After select one language domain (alphabet), when playback a MPEG4 with external subtitle, the subtitle display will use this language alphabet. if you find the displaying subtitle " alphabet " are not correct. please make sure to select the correct external subtitle language domain. The following language domains are available:

- Western European = Albanian, Breton, Catalan, Danish, Dutch, English, Faroese, Finnish, French, Gaelic, German, Icelandic, Irish, Italian, Norwegian, Portuguese, Spanish and Swedish.
- Turkish = Include Albanian, Danish, Dutch, English, Finnish, French, Gaelic, German, Italian, Kurdish (Latin), Norwegian, Portuguese, Spanish, Swedish and Turkish.

Dual Zone Operation

This unit is equipped with the most advanced "Dual Zone" feature. This function is useful if the user would like to select different modes of the Audio and Video output source for Front and Rear Speakers and TFT Screens. For example, user can select to listen to Tuner music for front speakers and rear speaker for DVD movie.

▶ To Switch On Dual Zone Mode

1. "Off" is the default setting.
2. Under SETUP menu, tap  button access into the Dual Zone mode, and then tap  select to 2-Zone on.

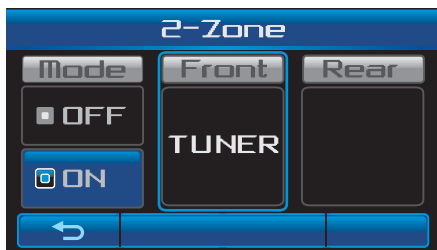

▶ The Available Playback Mode

1. Front Zone: Tuner and BT modes are available select for playback on Front Zone.
2. Rear Zone: Tuner, Media (Disc/USB/SD), AV modes are available select for playback Rear Zone.

NOTE

AV-1 & AV 2 are considered as the same mode/source in the DUAL ZONE function. So if either the Front or Rear Source is set to AV-1 or AV-2 mode, The other ZONE is not allowed to select the AV-2 or AV-1 Mode eg: If F-Zone is selected "AV-1", then R-Zone is not allow to have "AV-2".

▶ To Operates Function of Front / Rear Sources



1. The Front Panel & Remote control, is defaulted to control the FRONT source's function/operation.

2. When DUAL ZONE is turned "On", the Source button is used to change Front source & Rear source. Press the Source button repeatedly to change between Front and Rear.
3. The TFT screen will display the Rear Source mode. User can to make the desired operation on the Rear Source's function on the Front Panel or Remote Control.
4. The TFT screen will automatically switch back to the Front Source after 10 seconds. And the Front Panel buttons and Remote now is resumed to operate for Front Source's function again.

▶ The Default Setting When Dual Zone is "On"

1. The default source / mode for Front ZONE is Tuner & for Rear ZONE is "DVD".
2. The default Volume level is "12" for both Front & Rear ZONE audio output. (or the Volume Level set as VOL PGM Level set in the Menu).
3. The TFT screen is defaulted to display the Front Mode.
4. When Dual Zone is "On", some of the AUDIO FUNCTION, EQ FUNCTION and SOURCE WILL NOT BE FUNCTIONAL.

▶ To Switch Off Dual Zone Mode

- Under SETUP menu, tap  button access into the Dual Zone mode, and tap  button select to 2-Zone off.

▶ The Default Setting When Dual Zone Is In "off" Mode

The default audio output reverts to what the user selected for the FRONT Zone source when DUAL ZONE IS "OFF". For example: When the DUAL Zone is "ON", user has selected DVD for Front ZONE & Tuner for Rear ZONE. Once DUAL ZONE is turned "OFF", Audio Output for all 4 speakers becomes "DVD" mode.

AV-In Mode

Select the AV Mode

You can connect up to 2 optional devices, tap  button on display to enter into the AV mode.

AV - 1 = Front panel AV in
AV - 2 = RCA back of unit

▶ AV -1

This unit is allowed to connect with external Audio/Video system such like Digital Camera or Game Console. User can connect the external A/V system thru the A/V in jack on front panel.

▶ AV-2

Connect the external signal to the RCA line in jack located at the rear of the unit, then press  button to select AV -2.

TIPS

The below " No Video Signal " will show on the TFT as remind if there is no any external AV System input.



Tips

Be sure to connect Parking Brake connection lead. (please see more details on " Wiring Diagram.")

NOTE

If watch moving video from Disc or AV In source but Parking Brake is **NOT PROPERLY CONNECTED**, the video signal will be blocked by the system and the below display will be show on TFT:



About The Reverse Wire For Back Up Camera System

If user connected a back up camera system to this unit, the vehicle is in reverse Gear (Back Up mode), the front in-dash TFT display will automatically switch to Back Up Camera Video signal regardless whatever mode is currently displayed on the front in-dash TFT.

Tips

Be sure to connect Reverse wire properly. (please see more details on " Wiring Diagram.")

About the Parking Wire

⚠ CAUTION

In order to avoid any accident, the driver must not watch video while driving. This unit is designed to not allow watching video while driving. Park your car in a safe place and engage the parking brake before watching video.

NOTE

The Video Blocking system under Parking Brake **NOT ENGAGED** only control this unit's display, This system will not affect the Video Output thru the rear RCA Video Output.

Wallpaper Setting

Setting the Background Screen (Wallpaper)

This unit allows the user to change the background screen on the playback mode. This function is called wallpaper change. User can select the desired image on the below operation to set as wallpaper.

How To Select The Image



Under Setup menu, tap  button access into the Image Setting mode, the below TWO location are available for images selection:

► My Gallery

There is total 10 factory default images for the user to select as wallpaper.

TIPS

For details operation, please refer to SETUP MENU_MY GALLERY.

► My Image

This stores all images captured by user on this unit.

TIPS

For details operation, please refer to SETUP MENU_MY IMAGE.

Capturing Images for Wallpaper

This unit allows user during video or images playback, user can capture images and store them (up to 10 images) to set as wallpaper. User also can capture an image from an Auxiliary video device if connected.

How To Capturing Images

1. Start playing the disc, USB stick, SD card or auxiliary video device.

2. Hold press the CAPTURE button for more than 3 seconds when the desired scene or image appear on the TFT screen.
3. The confirmation display will appear to confirm the image is stored in to MY IMAGE.

TIPS

Those captured images will store in the SETUP_MY IMAGE. For details please refer to SETUP MENU_MY IMAGE.

How To Setting The Captured Images As Wallpaper

The captured images can be set as wallpaper on the playback mode.

TIPS

For details setting of wallpaper, please refer to SETUP MENU_MY IMAGE.

NOTE

- Do not turn off the unit while storing the image.
- Stored image may differ from the original aspect ratio due to compression or elongation.

Specifications

TFT Screen Section

Screen Size: 6.1" (Measured Diagonally)
Screen Type: TFT Liquid Crystal Display active matrix
Resolution: 480 x 234

DVD / CD Section

Compatible Disc/Format	See "Disc Note" for more details description
Signal to Noise Ratio	≥ 90 dB
Dynamic Range	≥ 90 dB
Frequency Response	20Hz to 20KHz +/-3dB
Channel Separation	2 Channel (Stereo) > 60dB @1kHz

Video Section

Color System	NTSC / PAL
Video Output	Composite 1.0 Vp-p (+/- 0.2) 75 - ohm
Video Input	Composite 1.0 Vp-p (+/- 0.2) 75 - ohm

Audio Section

Max Output Power	8 0W x 4 channels
Load Impedance (speakers)	4 ohms
Digital Output	900mV
Line out level / load	400mV / 10k ohm load
Line out Impedance	200 ohm

Auxiliary Input Section

Frequency response	20Hz to 20KHz -3dB
Input Maximum Voltage	1200 mV
Input Impedance	4.7k ohm

Radio Section

FM	
Frequency Range	87.5-108.0 MHz (50 kHz Space) 87.5-107.9 MHz (200 kHz Space)
Usable Sensitivity	≤ 15dB at S/N 30 dB
Stereo Separation	25 dB at 1KHz
S/N Ratio	50 dB

AM or MW

Frequency Range	522-1620 Khz (9 kHz Space) 530-1720 (10 kHz Space)
Usable Sensitivity	≤ 40dB at S/N 20dB
S/N Ratio	40 dB

General

Operating Voltage	DC 11 -14.4V
Grounding System	Negative Ground
Fuse:	15-Amp Mini ATM Type
Operating Temperature:	0° C to 50° C
Unit Mounting Angle	< 30°

Troubleshooting

Before going through the check list, check wiring connection. If any of the problems persist after check list has been made, consult your nearest service dealer.

Symptom	Cause	Solution
No power	The car ignition is not on.	If the power supply is properly connected to the car accessory terminal, switch the ignition key to "ACC"
	The fuse is blown.	Replace the fuse.
Disc cannot be loaded or ejected	Presence of CD disc inside the player.	Remove the disc in the player, then put a new one.
	Inserting the disc in reverse direction.	Insert the compact disc with the label facing upward.
	Compact disc is extremely dirty or defective disc.	Clean the disc or try to play a new one.
	Temperature inside the car is too high.	Cool off or until the ambient temperature returns to normal.
	Condensation.	Leave the player to off for an hour or so, then try again.
No sound	Volume is in minimum.	Adjust volume to a desired level.
	Wiring is not properly connected.	Check wiring connection.
The operation keys do not work	The built-in microcomputer is not operating properly due to noise.	Press the RESET button. Front panel is not properly fixed into its place
Sound skips.	The installation angle is more than 30 degrees.	Adjust the installation angle to less than 30 degrees.
	The disc is extremely dirt or defective disc.	Clean the compact disc. Then try to play a new one.
The radio does not work. The radio station automatic selection does not work.	The antenna cable is not connected.	Insert the antenna cable firmly.
	The signals are too weak.	Select a station manually.
ERROR	Mechanism Error	Press the eject button to correct the problem. If the error code does not disappear, consult your nearest service dealer.
Disc Error	Maybe disc dirty / disc scratched /disc upside down.	Replace the disc.



If at any time in the future you should need to dispose of this product, please noted that: Waste electrical products should not be disposed of with household waste. Please recycle where facilities exist. Check with your local Authority or retailer for recycling advice. (Waste Electrical and Electronic Equipment Directive).

Free Manuals Download Website

<http://myh66.com>

<http://usermanuals.us>

<http://www.somanuals.com>

<http://www.4manuals.cc>

<http://www.manual-lib.com>

<http://www.404manual.com>

<http://www.luxmanual.com>

<http://aubethermostatmanual.com>

Golf course search by state

<http://golfingnear.com>

Email search by domain

<http://emailbydomain.com>

Auto manuals search

<http://auto.somanuals.com>

TV manuals search

<http://tv.somanuals.com>