

# BV9982U

**IN-DASH DVD/MP3/CD AM/FM  
RECEIVER WITH MOTORIZED  
FLIP-OUT 7" (178mm)  
WIDESCREEN TOUCHSCREEN  
DIGITAL TFT MONITOR  
WITH DUAL (FRONT AND REAR) USB PORTS,  
SD MEMORY CARD PORT AND  
FRONT PANEL AV INPUT**



## BV9982U

**IN-DASH DVD/MP3/CD AM/FM RECEIVER  
WITH MOTORIZED FLIP-OUT 7" (178mm)  
WIDESCREEN TOUCHSCREEN  
DIGITAL TFT MONITOR  
WITH DUAL (FRONT AND REAR) USB PORTS, SD MEMORY CARD  
PORT AND FRONT PANEL AV INPUT**

09.2011



iPod® is a trademark of Apple, Inc.  
registered in the U.S. and other countries.

**tech support: [www.bossaudio.com/support](http://www.bossaudio.com/support)**

**BOSS®**  
AUDIO SYSTEMS

BOSS Audio Systems  
3451 Lunar Court • Oxnard, CA 93030

[www.bossaudio.com](http://www.bossaudio.com)

**800.999.1236**

**BOSS®**  
AUDIO SYSTEMS

BOSS Audio Systems is not affiliated with Apple, Inc.

Downloaded from [www.manuals.com](http://www.manuals.com). All Manuals Search And Download.

## PRECAUTION

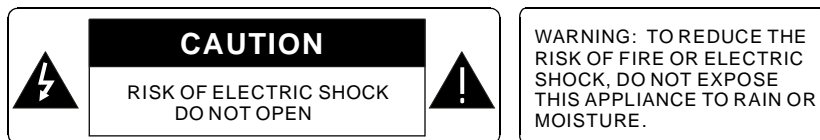

CAUTION: TO REDUCE THE RISK OF ELECTRIC SHOCK, DO NOT REMOVE COVER (OR BACK). NO USER SERVICEABLE PARTS INSIDE. REFER SERVICING TO QUALIFIED SERVICE PERSONNEL.

 The lightning flash with arrowhead symbol, within an equilateral triangle, is intended to alert the user to the presence of uninsulated dangerous voltage within the products enclosure that may be of sufficient magnitude to constitute a risk of electric shock to persons.

 The exclamation point within an equilateral triangle is intended to alert user to the presence of important operating and maintenance (servicing) instructions in the literature accompanying the appliance.

### CLASS 1 LASER PRODUCT

Laser product symbol: located on the rear panel of the unit, indicate this player is a class laser product, only use weak laser and no hazardous radiation outside of the unit.

1. Read through this instruction manual before installation and use.
2. Do not touch the power plug with wet hand.
3. Switch off the main power when the unit is not in use. (Disconnect the power plug from the power outlet when you do not intend to use the unit for a prolonged period of time.) Before moving the unit, remove the disc from the unit/ tray first.
4. Do not open the cover or touch any of the components exposed out of the unit, only for qualified technicians.
5. Do not expose the unit under direct sunlight or nearby objects that radiate heat to avoid damage the unit.
6. Do not place the unit in moist and humid conditions, which effect the pick-up of the unit lead to out of work.
7. Place the unit on a flat surface and ventilative condition. Please ensure the ventilation holes are not covered to avoid overheating and malfunction.
8. Clear the panel and case with soft dry cloth only, do not apply any kind of thinner, alcohol or sprays.
9. The apparatus shall not be exposed to dripping or splashing and that no objects filled with liquids, such as vases, shall be placed on the apparatus .

## Contents

1. Before Operation.....	3
1.1 Glossary.....	3
1.2 Precautions.....	3
1.3 Maintenance and Cleaning of Discs.....	4
1.4 Battery Information of the Remote Control.....	4
1.5 Remote Control Description.....	5
1.6 Locations and Names of Controls on or in the Unit.....	6
1.7 Wires Connection Description.....	7
1.8 Unit Installation.....	8
2. Common Operation.....	9
3. Radio Operation.....	10
4. Disc, USB and MMC/SD Card Operation.....	12
4.1 Load/unload Disc, USB or Card.....	12
4.2 Pause Playback.....	14
4.3 Stop Playback.....	14
4.4 Select Chapter/Track with the UP/DN or the >> / << Buttons.....	14
4.5 Select Chapter/Track with the Number Buttons.....	14
4.6 Select Chapter/Track with the Root/PBC Menu.....	14
4.7 Playback with Speed.....	15
4.8 Playback with Slow Speed.....	15
4.9 Display Still Frame Step by Step.....	16
4.10 Playback Repeatedly.....	16
4.10.1 One/All Repeat.....	16
4.10.2 A-B Repeat.....	16
4.11 Playback in Scan Mode.....	17
4.12 Playback from a specified Chapter/Track or a Specified Time.....	17
4.13 Playback in Random.....	17
4.14 Playback in Different View-Angle.....	17
4.15 Playback in Zoom Mode.....	17
4.16 Change the Caption Language.....	18
4.17 Change the Audio Language.....	18
4.18 Look over the Playback Status.....	18
4.19 Program Playback.....	19
4.20 Playback IMAGE files.....	19
4.21 Playback MP4 files.....	20
4.22 ESP and ID3 Function.....	20
4.23 DVD System Menu Setup Operation.....	20
* Parental Control.....	24
* Region Code.....	25
5. Trouble Shooting.....	26
6. Specification.....	27

## 1. Before Operation

### 1.1 Glossary

#### PBC (playback control)

It is a kind of signal(menu) recorded in the disc with SVCD or VCD2.0 format used for the playback control. For the discs containing PBC, It can playback interactive software with the menu displayed on monitor screen. If the disc contain still images, it can playback high definition of still images.

#### Title

Generally, the title is the important part of DVD disc. for example, the theme part of movie is title 1, the part described how to make movie is title 2, the cast is title 3, etc. Every title contain a serial number that is easy to look up.

#### Chapter

A title can be divided into several blocks, so that every block can be operated as a unit, the unit is called chapter. The chapter contain a unit at least.

#### Track

It is the biggest component of VCD. Generally, every song of the disc is a track.

### 1.2 Precautions

#### **Safety**

1. Power Source: The unit should be connected to power supply only of the type described in the operating instructions or as marked on the unit.
2. The unit is designed for negative terminal of the battery which is connected to the vehicle metal. Please confirm it before installation.
3. Do not allow the speaker wires to be shorted together when the unit is switched on. Otherwise it may overload or burn out the power amplifier.
4. Do not install the detachable panel before connecting the wire.

#### **Environment**

1. Do not use this unit near water and moisture.
2. If moisture forms inside the Lens, it may not operate properly. To correct this problem, wait until the moisture is evaporated.
3. If the car interior is extremely hot, do not use the player until the car has been cool off .

## 6. Specification

### General Specification

Power Supply Requirement.....	DC 12V
Maximum Power Output.....	4 x 85W(measured at DC 14.4 V)
Dimensions(w x h x d).....	7"W x 2"H x 6.3"D

### DVD Deck Specification

Format.....	DVD/VCD/JPEG/MP4/MP3/WMA/CD
Video System.....	NTSC
Audio System.....	24 bit/96KHz
Loading System.....	Auto Loading
Mounting Angle.....	0 to +/-30

### Video Specification

Video Type.....	16:9 and 4:3
Video Output level.....	Composite: $1.0 \pm 0.2$ Vp-p
	Load impedance: 75 ohms
Horizontal Resolution.....	500

### Audio Specification

Audio Output(Analog audio).....	$2.0^{+0} - 1.0$ Vrms
Frequency Response.....	20Hz ~ 20KHz(at 1KHz 0 dB)
S/N Ratio(Audio).....	$\geq 90$ dB(at 1KHz 0 dB)
Separation.....	50dB

### Radio Specification

FM Section	
Frequency range.....	87.5MHz - 107.9MHz(US) 87.5MHz - 108.0MHz(EU)
Usable sensitivity.....	3uV
I.F Frequency.....	10.7MHz

### AM Section

Frequency.....	530KHz - 1710KHz(US) 522KHz - 1620KHz(EU)
----------------	--

## 1.3 Maintenance and Cleaning of Discs

### Disc Maintenance

1. To keep the disc clean, handle the disc by its edge, do not touch the disc surface of the play side.
2. Do not stick paper or tape on the disc. If there is anything on the disc surface, wipe it up with a soft cloth before using.
3. Do not expose the disc to direct sunlight, or nearby heat sources such as caliduct, or leave it in a car parked in direct sunlight where there can be a considerable rise in temperature.
4. Put the disc inside disc case to keep temperature after finishing playback.

### Disc Cleaning

1. Before playing, wipe the disc with a clean cloth. wipe the disc outwards from the disc center.
2. Do not use petrol, thinner. Commercial cleaner or anti-static spray to wipe disc.

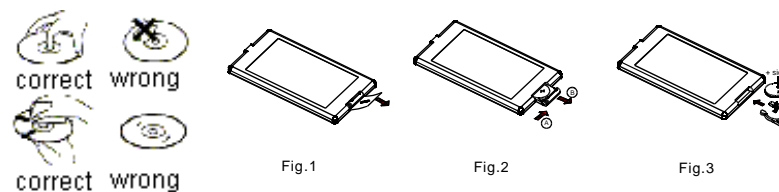

## 1.4 Battery Information of the Remote Control

### Replace Battery in the Remote Control:

1. Before using the remote control for the first time, pull the insulating sheet out of the remote control as the direction indicated by the arrow. (see fig.1)
2. Press the movable block hold as the direction indicated by the A arrow (See fig.2), then pull the battery holder out of the remote control as the direction indicated by the B arrow(see fig.2).
3. Replace the old battery by a new battery with (+) polarity side upward. (See fig.3).
4. Insert the battery holder to the original position in remote control. (See fig.3).

### Note about the Battery of the Remote Control:

1. Improper use of battery may cause overheating or explosion.
2. Battery leakage may cause damage to the remote control(Battery Life: 6 months with normal use in normal room temperature).
3. Do not short the battery.
4. Do not throw the battery into the fire.
5. To avoid the risk of accident, keep the battery out of reach of children.

## 1.5 The Remote Control Description

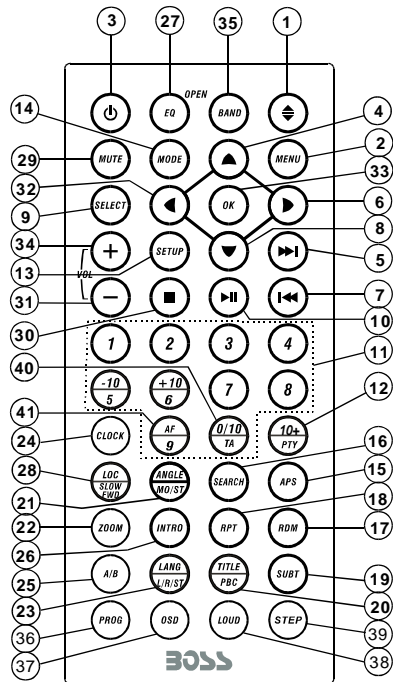

16. SEARCH BUTTON

17. RDM BUTTON

18. RPT BUTTON

19. SUBTITLE BUTTON

20. TITLE/PBC BUTTON

21. ANGLE/ST BUTTON

22. ZOOM BUTTON

23. AUDIO BUTTON

24. CLK BUTTON

25. A-B BUTTON

26. INT BUTTON

27. EQ/OPEN BUTTON

28. LOC/SLOW-FWD BUTTON

1. TILT BUTTON

2. MENU BUTTON

3. POWER BUTTON

4. ^ BUTTON

5. >>| BUTTON

6. > BUTTON

7. |<< BUTTON

8. v BUTTON

9. SEL BUTTON

10. PLAY/PAUSE BUTTON

11. NUMBER(0~10,+10  
-10) BUTTONS

12. 10+/PTY BUTTON

13. SETUP BUTTON

14. MODE BUTTON

15. APS BUTTON

29. MUTE BUTTON

30. STOP BUTTON

31. VOLUME- BUTTON

32. < BUTTON

33. OK BUTTON

34. VOLUME+ BUTTON

35. BAND BUTTON

36. PROG BUTTON

37. OSD BUTTON

38. LOUD BUTTON

39. STEP BUTTON

40. TA BUTTON

41. AF BUTTON

## 5. Trouble Shooting

Please read the user's manual carefully before using the DVD player. If you have any troubles in using this player, try to solve the problems by the suggestions mentioned below. If you can not remove the trouble after using all the suggestions, please contact the company or the technical service center authorized by us. For the sake of your safety, please do not open the cover and repair the player by yourself, if that, it may cause electric shock.

### NO PICTURE, SOUND AND INDICATION

- \* Ensure that the power switch is on.
- \* Ensure that the power cord is not damaged or the fuse is not blown.
- \* Ensure that the power plug is connected to the inlet tightly.

### NO SOUND BUT HAVE PICTURE

- \* Ensure that the player's audio output has a good connection with amplifier's audio input.
- \* Check whether the audio connector is damaged.
- \* Check whether you have turned down the volume.
- \* Ensure that you have set the right AUDIO setup of the player.
- \* Ensure that the audio is not under muted.

### NO PICTURE BUT HAVE SOUND

- \* Ensure that the player's video output has a good connection with monitor's video input.
- \* Ensure that you have turned your monitor to the AV input channel connecting to your player.
- \* Check whether the video connector is damaged.
- \* Ensure that you have set the right VIDEO settings of the player.

### BLACK AND WHITE PICTURE OR SCREEN ROLLING

- \* Ensure that you have set the right TV SYSTEM (e.g. PAL, NTSC) setting.

### FLAWS OF PICTURE OR SOUND

- \* Check whether the setting of AUDIO is right.
- \* Check whether the disc is scratched or stained.
- \* Check whether the AV connector and the output terminal is stained.
- \* Check whether there is condensation inside the Lens. If so, leave the player off for an hour or so, then try again.
- \* Check whether the installation angle is less than 30° .

### DISPLAY NO DISC OR BAD DISC

- \* Ensure that you have put the disc in the unit.
- \* Check whether the disc is put in the reverse side.
- \* Check whether the disc is distorted.
- \* Check whether the disc is stained or scratched badly.
- \* Ensure that the disc format is compatible to the player.
- \* Ensure that the temperature inside the car is not too high. If so, cool off till the ambient temperature returns to normal.
- \* Replace another disc to insert it into the disc compartment.

### REMOTE CONTROL IS INSENSITIVE OR DOES NOT WORK

- \* Check the batteries of remote control and make sure that they are powerful and have good conductivity.
- \* Direct the remote control to the IR sensor of the player.
- \* Check whether there are some obstacles between the remote control and IR sensor.

### SOME FUNCTION BUTTONS DO NOT WORK

- \* Turn off the power, then turn on again.
- \* Reset the unit to zero, then turn on again.
- \* Remove the front panel from the unit, then install it again and then turn on again.

### THE RADIO DOES NOT WORK

- \* Check whether the antenna cable is connected firmly. Or manually tune for a station.

\* Region Code

Q: Why does the unit display REGION ERROR after inserting disc into disc compartment ?

A: Because the DVD player and disc has respective region code. If the region codes of them do not match with each other, the DVD player can not play the disc.

Appendix: The region code of DVD:

The Motion Picture Association of America (MPAA) divided the world into 6 regions, and gave every region a code, namely region code. The region codes and the countries or areas represented by the region codes as follows:

Region 1: America, Canada, East-Pacific Inlands;

Region 2: Japan, West Europe, North Europe, Egypt, South Africa, Middle East;

Region 3: South-east Asian countries include Taiwan, Hong Kong, South Korea, Thailand, indonesia, etc.;

Region 4: Australia, New Zealand, Central South America, South Pacific Inlands;

Region 5: Russia, Mongolia, Indian Peninsula, Middle Asia, East Europe, North Korea, North Africa, North-west Asia etc.;

Region 6: China mainland.

1.6 The Locations and Names of Controls on or in the unit

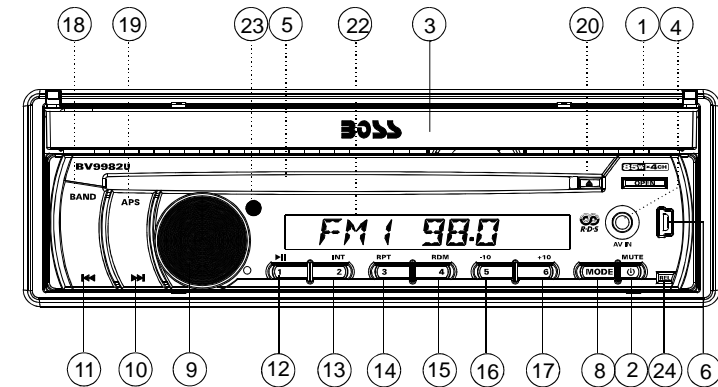

Front Panel

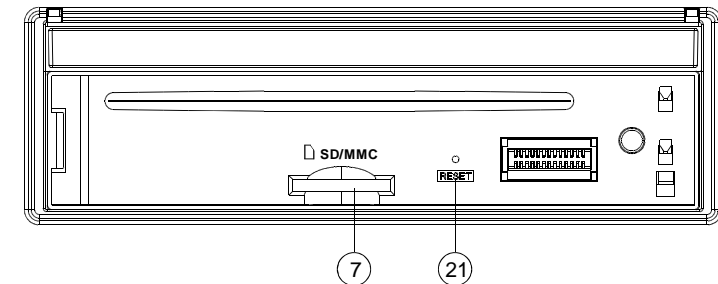

The Front Facet after removing the front panel

- |                         |                      |
|-------------------------|----------------------|
| 1. OPEN button          | 13. INT/2 button     |
| 2. POWER/MUTE button    | 14. RPT/3 button     |
| 3. Monitor              | 15. RDM/4 button     |
| 4. AV IN socket         | 16. - 10 / 5 button  |
| 5. Disc Slot            | 17. + 10 / 6 button  |
| 6. USB Jack             | 18. BAND button      |
| 7. SD/MMC Card Slot     | 19. APS button       |
| 8. MODE button          | 20. EJECT button     |
| 9. VOL knob             | 21. RESET button     |
| 10. >>  button          | 22. Small LCD Screen |
| 11.  << button          | 23. IR Remote Sensor |
| 12. PLAY/PAUSE/1 button | 24. REL button       |

## 1.7 Wires Connection Description

### The Description of the Wires Connection

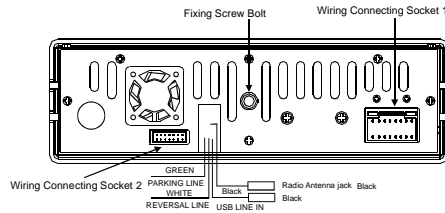

1. Parking wire must be connected. And the parking brake must be engaged in order for the monitor to work.
2. Use the clip end of the Ground Wire provided by manufacturer to connect Mounting Screw, using the other end of the Ground Wire to connect the negative pole of the power source. Otherwise, the video on screen maybe flashes.

### The Description of the Wiring Diagram for Socket 1

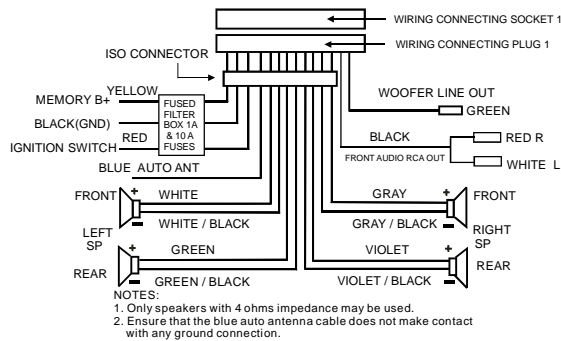

### The Description of the Wiring Diagram for Socket 2

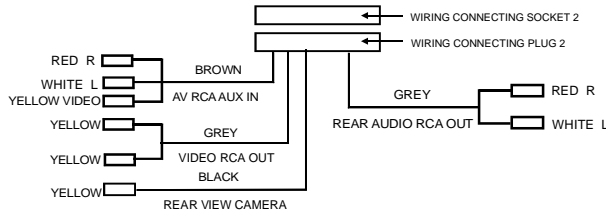

### Description of Connecting the Parking Brake Line to the Parking Brake System Built in the Car

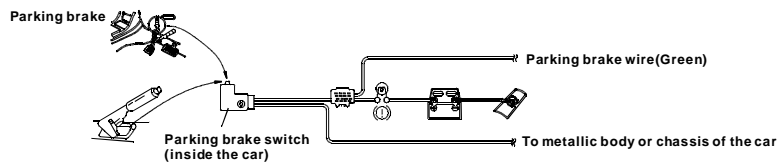

NOTE: after connecting the Parking Line, the video on the small monitor of the front panel will be display only after br aking the car.

### \* Parental Control

Q: Why after inserting DVD disc in the disc slot, a dialogue window appears that asks to input a 4 digits password ?

A: This is because the movie you are playing is rated with the Parental Control, and the current rating level of DVD player is lower than the current disc. You must change the Parent Control setting to higher rating level.

### ! NOTE

\* For the factory preset password of the DVD player, please refer to the relative content of PASSWORD setup menu for details.

### Parental Control

The Parental Control function of a DVD player can control the playback of movie rated level in a disc. You can set the DVD player to be a certain rating level with SETUP MENU on screen. If the rating level in the disc is higher than one set in the DVD player, the DVD player can not playback the disc. The rating level setup can be protected by the password. Therein, if you select Unlock item, the Parental Control function will be invalid, and all level DVD rating will be played.

The disc movie can be designed as that the DVD player will playback the different version of content of a same movie according to the different rating level set by Parental Control. Depending on the DVD feature of seamless switching described above, the scenes that are not fitting for children will be cleared or replaced by the other fitting scene automatically.

All rating levels of Parental Control are as follows:

- Unlock
- 1 Kid Safe
- 2 G
- 3 PG
- 4 PG 13
- 5 PG R
- 6 R
- 7 NC 17
- 8 Adult



**HUE**

It is for adjusting the hue of the video output.

**SATURATION**

It is for adjusting the saturation of the video output.

**SHARPNESS**

It is for adjusting the sharpness of the video output.

**4.23.5 SPEAKER SETUP****DOWNMIX**

It is for selecting your desired sound effect when there is not central speaker and sub-woofer. There are 3 mode: LT/RT, STEREO, VSS.

LT/RT: When playing a disc with PRO LOGIC stereo effect, choose the item, so it will output audio signal with vivid theatre effect.

STEREO: If you choose this item, when outputting audio signal with 5.1 channels, it will output the left and right channels of signal ; when outputting audio signal with 2 channels, it will output the common 2 channels of stereo signal.

VSS: If you choose this item, when playing a disc recorded with 5.1 channels, the main channel speakers can output audio signal with VSS effect.

**4.23.6 DIGITAL SETUP****OP MODE**

It is for selecting audio output mode

LINE OUT: It can compress the audio signal. So the volume level is lower.

RF REMOD: It can make the volume level higher.

**DYNAMIC RANGE**

After selecting the compression mode of LINE OUT, set the item, so you can adjust the linear compression ratio. If you set it to be FULL, the Peak-to-Peak value of the audio signal is the minimum; if you set it to be OFF, the Peak-to-Peak value is the maximum.

**DUAL MONO**

It is for selecting a desired audio output mode for the left and right ways of signal.

It is mainly for Karaoke of Ac3. There are 4 modes in all as follows:

STEREO, MONO L, MONO R, MIX MONO.

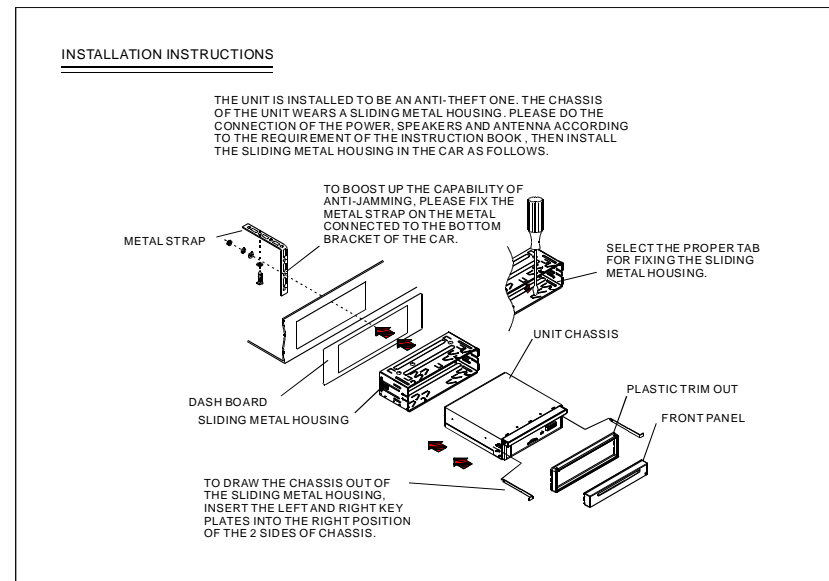
**1.8 UNIT INSTALLATION**

## 2. Common Operation

- To turn on/off the unit  
In power off mode, short press any buttons except REL to turn on the unit.  
In power on mode, long press the POWER button on the front panel or short press the POWER button on the remote control to turn off the unit.
- To slide the monitor of the Car Audio System out of the chassis  
Shortly press the OPEN button on the front panel or long press the OPEN button on the remote control can slide the monitor of the Car Audio System out of the chassis or slide it into the chassis.

- To select function mode  
Press the MODE button to select RADIO, DISC (After inserting a disc), USB (After inserting a USB storage), SD/MMC CARD (After inserting a SD/MMC card) or AUX mode.



During playback, tapping the  icon after popping up Keyboard interface can pop up Mode Menu as right image. then tap one icon in it to select your desired mode.

Note: This unit has front and rear USB. Only one will work at a time.

- To adjust sound level  
Rotate the VOL knob on the front panel or press and hold the + or - button on the remote control will adjust the volume level.
- To mute sound  
Press the MUTE button on the remote control to turn on/off MUTE mode.  
Pressing the POWER button on the front panel shortly also can turn on/off MUTE mode.
- To display clock time  
Press the CLK button to display clock time on the small monitor of the front panel.  
After sliding the monitor into the chassis, pressing the CLK button can display clock time on the small LCD.
- To select a desired EQ mode  
Press the EQ button on the remote control to select one of the preset music equalizer curves: POP, ROCK, CLAS, FLAT. The sound effect will be changed.
- To turn on/off LOUD mode  
Press the LOUD button on the remote to turn on/off LOUD mode.  
When turning on LOUD mode, it will enhance bass level immediately when bass is not enough.
- To reset the player  
When the monitor, the small LCD display or some buttons are not working or sound is distorted, press the REL button and detach the front panel from the main unit, then press the RESET button to reset the program to factory default.

### 4.23.2 LANGUAGE SETUP



#### OSD LANGUAGE

This item is for selecting the language of the SYSTEM MENU and all operating prompt interface displayed during playback.

#### AUDIO LANG

This item is for selecting a audio language.

#### SUBTITLE LANG

This item is for selecting a subtitle language.

#### MENU LANG

This item is for selecting a disc menu language.

### 4.23.3 AUDIO SETUP



#### AUDIO OUT

There is only ANALOG mode, i.e. SPDIF/OFF, not optional.

#### KEY

It is for selecting your desired basic music tone (from low to high).

### 4.23.4 VIDEO SETUP



#### BRIGHTNESS

It is for adjusting the brightness of the video output.

#### CONTRAST

It is for adjusting the contrast of the video output.

2. There are 6 setup pages in all for the System Menu. Press the > or < button to select an desired setup page.
3. Press the ^ or v button to select an setup item in the selected setup page.
4. Press the > button to enter the setup item. Then press the v or ^ button to select a desired mode of the setup item, finally press the OK button to confirm it.

- \* Press the < button to return to the upper level.
  - \* Press the SETUP button again or use the direction buttons to highlight the item of the EXIT SETUP and then press the OK button to exit the System Menu.
- For the DVD System Menu, there are 6 setup pages in all. They display as follows:

#### 4.23.1 SYSTEM SETUP

##### TV TYPE

The setup item is for matching TV screen size.

4:3 PS: Choose the item when connecting a TV set with 4:3 screen. When playing the pictures with 16:9 size, the left and right parts of the video will be cut out, and display in full screen.

4:3 LB: Choose the item when connecting a TV set with 4:3 screen. When playing the pictures with 16:9 size, the top and bottom parts of the TV screen will be turned into a black square respectively.

16:9: Choose the item when connecting a TV set with 16:9 wide screen.



##### PASSWORD

This setup item is for locking or unlocking the rating level of the Parental Control. The defaulted state is locked. The defaulted password is 0000.

You can set a new password that you like: Select the PASSWORD item and then press the > button to enter it, then input the password mentioned above, and then press the OK button to unlock the setting of the rating level of the Parental Control. Press the > button to enter it again, then input a new password that you like and then press the OK button to make it effective. Before the other persons see the Manual, you should get the password in mind and cut out the part of PASSWORD in the Manual.

##### RATING

The item is for setting a new rating level of the Parental Control.

1. Select the PASSWORD item and then press the > button to enter it, then input the password mentioned above, and then press the OK button to unlock the setting of the rating level of the Parental Control.
2. Select the RATING item and then press the > button to enter it, then use the direction buttons to select your desired rating level, then press the OK button to confirm.
3. Select the PASSWORD item again and then press the > button to enter it, then input the password, and then press the OK button to lock the new setting of the rating level of the Parental Control.

##### DEFAULT

This item is for making all setup items change back to original status.

#### 11. To do setup

To do setup, tap the  icon in the Main Menu to turn to SETUP interface as right. In the interface, select one of GENERAL, TIME, AUDIO, VIDEO, RADIO, CALIBRATE by tapping them, then set them by tapping some icons on the right side accordingly.





GENERAL SETUP

#### 3. Radio Operation

##### 1. Enter RADIO mode

When you use MODE button or Mode Menu to enter RADIO mode, it will display RADIO interface as right.

In RADIO interface, tapping the  icon can enter Mode Menu; during playback, press and hold the mode button can turn on or off TFT display; tapping the  icon can turn to frequency interface as right; the other icons are same as ones in the unit panel or in the Remote Control.



RADIO interface

In menu set interface, you can adjust MUTE, APS, EQ, TA, AF, PTY as right.

##### 2. BAND BUTTON

In RADIO mode, press the BAND button on the remote control to select your desired radio band of FM1, FM2, FM3, AM1 and AM2, and the word means which band is selected will be displayed on the small monitor of the front panel.



AUDIO & VIDEO SETUP interface

##### 3. TUNE/SEEK UP/DOWN BUTTONS

In RADIO mode:

- 1) Press and hold the >>|<< button to automatically search up/down for an available station from current frequency.
  - 2) Briefly press the >>|<< button to manually search up or down with step by step for your desired station from the current frequency.
- ##### 4. APS BUTTON
- In RADIO mode:
- 1) When pressing and holding the APS button, the radio searches from the lowest frequency and checks the signal strength level until 1 cycle search is finished. And then the 6 strongest stations are preset to the corresponding preset number memory bank. The AS operation is implemented in the each bank of the selected band. When the AS operation is finished, it will scan each preset station for 5 seconds in FM or AM band from M1 as briefly pressing APS button. After finishing a circle of scanning, it will resume broadcasting on the M1. (It can store 3x6 stations for FM and 2x6 stations for AM in all)
  - 2) When briefly pressing the APS button, the radio will scan each preset station for 5 seconds in FM or AM band from M1. After finishing a circle of scanning, it will resume broadcasting on the M1.
- NOTE: In FM band, FM1, FM2, FM3 is checked one at a time; In AM band, AM1, AM2 is checked one at a time.

## 5. PRESET STATION [ 1-6 ] BUTTONS

In RADIO mode:

- 1) To memorize the current frequency on the current band, press and hold any one of the six preset buttons (1-6) on remote control or rotate number knob and long press it .
- 2) To recall the preset memory on the current band, press one of the preset buttons [1-6] on remote control or rotate number knob and press it .

## 6. STEREO/MONO BUTTON

Press the ST button on the remote control to select the STEREO or MONO sound mode for FM band.

## 7. LOC BUTTON

- 1) In RADIO mode, when the signals of the distant radio stations are very weak and the receiving effect is bad during tuning, check whether there is the word LOC on LCD. If there is the word LOC on LCD, press this button to turn off the LOC function, then tune again for the distance radio station;
- 2) In RADIO mode, when the signals of the local radio stations are too strong this causes interference to the receiving effect during tuning, press this button to turn on the LOC function to display the word LOC on LCD, then tune again for the local radio station.

## 8. PTY (PROGRAM TYPE) BUTTON

Press the PTY button briefly to select one of the following modes:

PTY MUSIC group- - PTY SPEECH group -- OFF

When PTY group is on, press the VOL+ or VOL- button on the remote control or rotate the VOL knob on the front panel to select one of PTY programs as follows:

<-->NEWS<-->AFFAIRS<-->INFO<-->SPORT<-->EDUCATE<-->DRAMA  
 <-->CULTURE<-->SCIENCE<-->VARIED<-->WEATHER<-->FINANCE  
 <-->CHILDREN<-->SOCIAL<-->RELIGION<-->PHONE IN<-->TRAVEL  
 <-->LEISURE<-->DOCUMENT<-->PTY NONE<-->POP M<-->ROCK M  
 <-->EASY M<-->LIGHT M<-->CLASSICS<-->OTHER M<-->JAZZ  
 <-->COUNTRY<-->NATION M<-->OLDIES<-->FOLK M<-->

When PTY group is on, pressing the 6 number buttons also can select one of PTY programs as above.

After selecting one of the PTY programs, it will display SEEK PTY and automatically search for the station of the PTY program. If the station of the PTY program does not exist, it will display PTY NONE and then return back to the normal station.

## 9. AF [ALTERNATIVE FREQUENCIES] BUTTON

When pressing the AF button briefly, the AF switching mode is selected and the AF switching mode is displayed by AF segment in display.

Segment off: AF switching mode off.

Segment on: AF switching mode on, and has RDS information.

Segment flashing: AF switching mode on, but RDS information is not received yet.

When you select the IMAGE file sort icon, press the ^ or > button to select the first IMAGE file, then press the v button to select the desired IMAGE file, finally press the OK or PLAY/PAUSE button to display the image in full screen from the selected IMAGE file.

3. During IMAGE playback, press one of the >/</^/v buttons to change the angle of viewing picture that is displaying as follows:  
 >: 90 deg cw; <: 90deg ccw; ^: UP<-->DOWN; v: LEFT<-->RIGHT  
 During IMAGE playback, press the PROG button to change the mode of refresh picture.  
 During IMAGE playback, press the STOP button to stop playing and return to the root menu.

\* During IMAGE playback, the following buttons are not available: SLOW-FWD, SUBTITLE, TITLE, ANGLE, AUDIO, RDM, INT and A-B.

\* In IMAGE mode, the other operations are same as ones in MP3/WMA mode.

### 4.21 Playback MP4 files

1. The root menu is displayed on TV when beginning to switch on MP4 mode, then it will automatically play the first file.  
 During playback, press the STOP button to stop playing and return to the root menu.
2. When displaying the root menu, press the direction buttons to select your desired FOLDER ,file or file sort icon, then press the OK or PLAY button to open the FOLDER, open the files of the file sort icon or play the selected file.  
 When displaying the root menu, you can also use the number buttons to select the serial number of the file and play the file.

\* The ANGLE, PROG, RDM, INT and TITLE/PBC button are not valid.

\* The other functions are same as ones in DVD mode; but the RPT function is same as one in MP3/WMA mode.

### 4.22 ESP and ID3 Function

There is ESP function for all formats of discs.

In MP3/WMA mode, during playback, the information of the file name, folder name, song s title, artist and album will be scrolling on the LCD display. As long as the current playing MP3 music contains relevant ID3 tag information in version 1.0/2.0 format, the 3 items underlined above will be scrolling on the LCD display; otherwise, they will not.

### 4.23 The DVD System Menu Setup Operation

1. Press the SETUP button on the remote control to access the DVD System Menu on the monitor.

#### 4.19 Program Playback

It allows you to enter the order in which you want some chapters/tracks in DVD/VCD/MP3/WMA/CD to play.

- 1 During playback, press the PROG button to enter a program interface as follows:

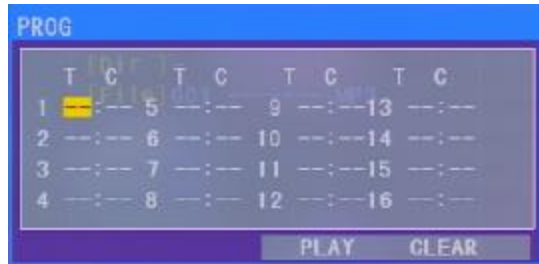

- 2 Use the direction buttons to move cursor onto the desired place for inputting the sequence number.
  - 3 Use the number button to input desired sequence number of title/chapter/track with desired sequence.
  - 4 Use the direction button to move cursor onto Play item, then press the OK button to play the programmed titles/chapters/tracks in programmed order; only pressing the PLAY button also can play the programmed titles/chapters/tracks in programmed order.
- \* To exit program playback, firstly press the STOP button, then press the PLAY button to enter sequence playback; or press the PROG button twice again.
  - \* To remove the all programmed sequence numbers, move the cursor onto Clear item, then press the OK button.
  - \* To change the programmed sequence, move the cursor onto the item you want to change, input the desired sequence number.
  - \* During VCD playback, if it is in PBC ON mode, at the same time of entering the state of program playback, it turns off PBC mode.

#### 4.20 Playback IMAGE files

1. The root menu is displayed on the monitor when beginning to switch on IMAGE mode. .  
In the root menu, the left file sort icon is for MP3/WMA file; the middle file sort icon is for IMAGE file; the right file sort icon is for VIDEO file. If one of these 3 file sort does not exist, you can not move cursor onto the file sort icon.
2. When displaying the root menu, press the direction buttons to select your desired FOLDER, file or file sort icon, then press the OK or PLAY button to open the FOLDER, or play the selected file, or play only this sort of file.  
When displaying the root menu, you can also use the number buttons to select the serial number of the file and play the file.

When the AF switching mode is selected, the radio checks the signal strength of the AF all the time. The interval of checking time of each AFs depends on the signal strength of the current station, from a few minute for the strong station to a few seconds for the weak station. Every time when a new AF is stronger than the current station, it switches over to that frequency for very short time, and the NEW FREQUENCY is displayed for 1-2 second. Because the mute time of the AF switching or the checking time is very short, it is almost inaudible in case of normal program. (When AF flashes on the monitor, it will search for the stronger RDS station. If AF and TP flash on the monitor, it can only search for the traffic announcement station).

In FM mode, when AF is on, SEEK, (SCAN), AUTO-MEMORY functions can only receive and save the RDS program.

#### 10. TA [TRAFFIC ANNOUNCEMENT] BUTTON

Press the TA button briefly to turn on TA search mode.

When traffic announcement is transmitted:

- 1). If the unit is in Disc Play mode, it will switch to radio mode temporarily.
  - 2). Temporarily switches over to an station with traffic announcement, and TA, TP will be displayed on the monitor.
- \* TA interruption function:  
The current traffic announcement is cancelled by pressing TA button briefly.
  - \* When TA is on, SEEK, (SCAN), AUTO MEMORY functions can be received or saved only when traffic program identification code has been received.

#### 4. Disc and USB Operation

##### 4.1 Load/unload disc or USB





To play files in a disc or card, press the EJECT button to slide down the monitor. Then insert the disc or card into the disc slot or SD/MMC Card slot.

To unload the disc or card, press the STOP button twice to stop playback, then press the EJECT button to slide down the monitor and eject disc in the disc slot and then remove the disc; or push the card firstly and pull it out of the card slot.

To play files in an USB, insert the USB into the USB jack connecting to the Rear cabinet.

To unload the USB, press the STOP button twice and then remove the USB.

In USB or CARD mode, select your desired as right.

Remark: the  icon is for audio files; the  icon is for video files; the  icon is for image files. Tap the  icon to turn to main menu, tap the  icon to turn to previous setting.



USB/CARD INTERFACE

 : Tap it can pause playback

 : Tap it can stop playback .

 : Tapping one of them can switch on between the speed levels of fast backward or forward. (Except image mode.)

 : Tapping one of them can select next or previous chapter/track.

 : Tap it to turn volume up and down.

 : Tap it to turn the selecting page up and down.

 : Tap it to select INT play mode(Except image mode.)

 : During VCD playback, tap it can select the audio ST/MONO .

 : Same as the MENU button on the remote control.

 : Same as the TITLE button on the remote control.

 : Same as the REPEAT button on the remote control.

 : Same as the SUBTITLE button on the remote control.

 : Tap it to select the track from 1-9 and then select OK to play your selecting.

 : During playback, press the ZOOM button and then tap one of them are same as the direction buttons on the Remote Control. (Except music & image mode.); During playback, press one of them to change the playback angle. (Only for image mode.)

 : Same as the ZOOM button on the Remote Control.

 : Same as the RDM button on the Remote Control.

 : During DVD playback, tap the icon to change the playback angle.



Root interface for MUSIC



Keyboard interface-1



Keyboard interface-2



Keyboard interface-3

Note: This unit has front and rear USB. Only one will work at a time.

ZOOMx2,ZOOMx3,ZOOMx4,ZOOMx1/2,ZOOMx1/3,ZOOMx1/4,ZOOM OFF.  
Press one of the ^/v/>/< buttons to select the area you want to enlarge.

#### 4.16 Change the Caption Language

When playing DVD , press the SUBTITLE button repeatedly to select the language of the caption or turn off the caption.(depend on the media used.)

When playing VCD/MP3/WMA/CD , the button is not available.

#### 4.17 Change the Audio Language

1. When playing DVD , press the AUDIO button repeatedly on the IR remote control to select the desired language type. (depend on the media used)
2. When playing VCD , press the AUDIO button repeatedly to select the sound mode of the MONO L, MONO R, MIX MONO and Stereo, no language function.
3. When playing CD/WMA/MP3 , the AUDIO button is disabled.

#### 4.18 Look over the Playback Status

1. When playing DVD , press the OSD button repeatedly on the remote control to turn on/off the playback status. When it is on, it will display the information such as: the serial number of the playing title, the serial number of the playing chapter, the elapsed time of the playing chapter, the remained time of the playing chapter, the elapsed time of the playing title, the remained time of the playing title, etc.
2. When playing VCD/CD , press the OSD button repeatedly on the remote control to turn on/off the playback status. When it is on, it will display the information such as: the serial number of the playing track, the elapsed time of the playing track, the remained time of the playing track, the elapsed time of the disc, the remained time of the disc.
3. When playing MP3/WMA , press the OSD button repeatedly on the remote control to turn on/off the playback status. When it is on, it will display the information such as: the serial number of the playing track, the elapsed time of the playing track, the remained time of the playing track.

#### 4.11 Playback in Scan Mode

1. When playing VCD(PBC OFF)/CD , press the INT button to play the previous 15 seconds part of each track on the disc. Press the INT button again to resume normal playback.
2. When playing DVD/MP3/WMA , the INT button is not available.

#### 4.12 Playback from a specified chapter/track or a specified time

1. When playing DVD , press the SEARCH button to display a interface and highlight the title item, then use the number buttons to input the serial number of the title; use the direction buttons to highlight the chapter item, then use the number buttons to input the serial number of the chapter; you can still use the direction buttons to highlight the time item, then use the number buttons to input the desired time to start playback; finally press the OK or PLAY button to play the selected chapter or play from the selected time.
2. When playing VCD/MP3/WMA/CD , press the SEARCH button to display a interface and highlight the track item, then use the number buttons to input the serial number of the track; you can still use the direction buttons to highlight the time item, then use the number buttons to input the desired time to start playback; finally press the OK or PLAY button to play the selected track or play from the selected time.

#### 4.13 Playback in Random

When playing DVD/VCD(PBC OFF)/MP3/WMA/CD , press the RDM button to switch between RANDOM (ON)/RANDOM OFF. When in RANDOM (ON) mode, it will play in random.

#### 4.14 Playback in Different View-Angle

1. When playing VCD/MP3/WMA/CD , the VIEW-ANGLE button on the IR remote control is not available.
2. When playing DVD , press the VIEW-ANGLE button repeatedly on the IR remote control to view in different angle.(This function is only for the DVD media with ANGLE function)

#### 4.15 Playback in Zoom Mode

In video/image mode, during playback, press the ZOOM button continuously to enlarge a certain area of the images on the screen with these multiples:

#### 4.2 Pause Playback

When playing DVD/VCD/CD/MP3/WMA , press the PAUSE button on IR remote control to pause the playback, press the PLAY button to resume normal playback.

#### 4.3 Stop Playback

When playing DVD/VCD/MP3/WMA/CD , press the STOP button once to pause the playback, then press the PLAY button to resume the normal playback; press the STOP button twice to full stop the playback, then press the PLAY button to start playing from the beginning of the first chapter/track.

#### 4.4 Select Chapter/Track with the >>| or |<< Button

Press the >>| or |<< button during playback to select the next or previous chapter/track to playback.

Note: Press the >>| or |<< button multiple times to advance multiple chapters/tracks forward or backward.

#### 4.5 Select Chapter/Track with the Number Buttons

When playing DVD/VCD(PBC OFF)/MP3/WMA/CD , press one of the 1~9 and the 0/10 number buttons to directly select and play the 1st to 10th track /chapter (the 0/10 button is used as the 10 button).

If you want to play the track/chapter larger than 10, use the 10+, 1~9 and 0/10 button. Example 1: to play the 13th track/chapter, first press the 10+ button once, then press the 3 button. Example 2: to play the 34th track/chapter, first press the 10+ button 3 times, then press the 4 button. (The 0/10 button is used as the 0 button)

Note: long pressing the +10 or -10 button can play the next 10th or previous 10th chapter/track(only for MP3/WMA).

#### 4.6 Select Chapter/Track with the Root/PBC Menu (If the disc includes the root/PBC menu)

When playing DVD

1. Press the TITLE button on the remote control to display the title list.

2. Press the direction buttons to select your desired title, and then press the OK or PLAY button to open the root menu of the selected title.
3. Press the direction buttons to select your desired chapter, finally press the OK or PLAY button to play the selected chapter.

During playback, pressing the MENU button can directly display the root menu of the title that is playing.

#### In VCD mode

1. When starting to turn on the PBC function, it will play from the beginning of the disc till it display the PBC menu on the screen if the disc include the PBC menu.
2. Press the number buttons to select your desired track to play.

#### In MP3/WMA mode

1. The root menu is displayed on the monitor screen all the time (and the TITLE or MENU button is not available).
2. Press the direction buttons to select your desired FOLDER, then press the OK or PLAY button to open the FOLDER, and then press the direction buttons to select your desired file, finally press the OK button to play the selected file.

In CD mode, the TITLE, PBC, MENU buttons are disabled.

#### 4.7 Playback with Speed

During normal playback, consecutive pressing of the >>| or << button will fast forward or rewind at the following speeds: x2, x4, x8, x20, normal.

During this operation, press the PLAY button to resume normal playback.

#### 4.8 Playback with Slow Speed

During playback, press the SLOW\_FWD button to execute the Slow Forward function.

With each consecutive pressing of the SLOW\_FWD button, the playback speed decreases. The speed levels in Slow Forward as follows: x1/2, x1/3, x1/4, x1/5, x1/6, x1/7, normal.

During slow forward, press the PLAY button to resume normal playback. This function is only for video.

#### 4.9 Display still frame step by step

If the unit is currently playing video, press the STEP button consecutively to display still frame step by step. Press the PLAY button to resume normal playback.

#### 4.10 Playback Repeatedly

##### 4.10.1 ONE/ALL Repeat

1. In the mode of DVD playback:  
Press the RPT button to select REP CHAPTER, REP TITLE, REP ALL or REP OFF.
2. In the mode of VCD(PBC OFF)/CD playback:  
press the RPT button to select REP ONE, REP ALL or OFF.

When it is in the state of PBC ON, during VCD disc playing, the RPT button are not available.

3. In the mode of MP3/WMA playback:  
Press the RPT button to select REP ONE, REP DIR, REP ALL or OFF.

##### 4.10.2 A-B Repeat

Press the **A-B** button if you want to repeat a specific segment on a disc that you define:

1. Press the **A-B** button at a point (A) where you want it to be the start point of the repeat segment. Press the **A-B** button again at a point (B) where you want it to be the terminal point of the repeat segment. Then it will play the segment repeatedly.
2. To cancel the A-B repeat mode and resume normal playback, press the **A-B** button for the third time.

Note:

During VCD/MP3/WMA/CD playback, points A and B must be within the same track.

During DVD playback, points A and B can be selected from different chapters.



## Free Manuals Download Website

<http://myh66.com>

<http://usermanuals.us>

<http://www.somanuals.com>

<http://www.4manuals.cc>

<http://www.manual-lib.com>

<http://www.404manual.com>

<http://www.luxmanual.com>

<http://aubethermostatmanual.com>

Golf course search by state

<http://golfingnear.com>

Email search by domain

<http://emailbydomain.com>

Auto manuals search

<http://auto.somanuals.com>

TV manuals search

<http://tv.somanuals.com>