

ME-20

GUITAR MULTIPLE EFFECTS

Owner's Manual

Thank you, and congratulations on your choice of BOSS ME-20 Guitar Multiple Effects. Before using this unit, carefully read the sections entitled: "USING THE UNIT SAFELY" and "IMPORTANT NOTES".

These sections provide important information concerning the proper operation of the unit. Additionally, in order to feel assured that you have gained a good grasp of every feature provided by your new unit, this manual should be read in its entirety. The manual should be saved and kept on hand as a convenient reference.

Main Features

● Simple Operation—Works Like a Compact Pedal Effects

All you need to do to get the sound you want is to select an effect, then tweak it using the knobs—basically, this is the same simple, intuitive operation offered by compact pedal effects.

● OD/DS Solo Function

Give distortion sounds an intense boost and clarity simply and easily with the press of a single button. You can also switch the effect with the pedal, a convenient feature for live performances.

● EZ EDIT for Quick Sound Creation

EZ EDIT is a feature that allows you to creating sounds quickly and easily. You can adjust a combination of effect parameters with just a single knob.

● Memory Function

Up to thirty of the sounds you create can be stored in the ME-20's User memory. In "Memory mode," you can use the pedals to instantly select a stored sound.

● AUX IN Jack

Thanks to this feature, it's simple to play along with CD and MP3 players and other equipment.

● Battery Powered Operation

The ME-20 runs on battery power (six AA dry cells), allowing you to use it anywhere you play. You can also use the optional AC adaptor, giving you two ways to power the ME-20, so you can play for extended periods during live performances.

Copyright © 2007 BOSS CORPORATION

All rights reserved. No part of this publication may be reproduced in any form without the written permission of BOSS CORPORATION.

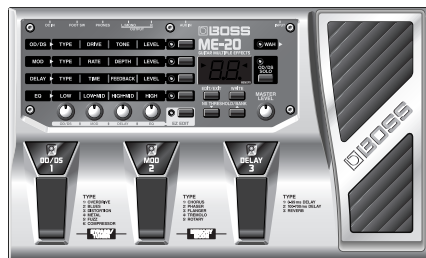

USING THE UNIT SAFELY

INSTRUCTIONS FOR THE PREVENTION OF FIRE, ELECTRIC SHOCK, OR INJURY TO PERSONS

About ⚠ WARNING and ⚠ CAUTION Notices

⚠ WARNING	Used for instructions intended to alert the user to the risk of death or severe injury should the unit be used improperly.
⚠ CAUTION	Used for instructions intended to alert the user to the risk of injury or material damage should the unit be used improperly. * Material damage refers to damage or other adverse effects caused with respect to the home and all its furnishings, as well to domestic animals or pets.

About the Symbols

	The ⚠ symbol alerts the user to important instructions or warnings. The specific meaning of the symbol is determined by the design contained within the triangle. In the case of the symbol at left, it is used for general cautions, warnings, or alerts to danger.
	The ⚡ symbol alerts the user to items that must never be carried out (are forbidden). The specific thing that must not be done is indicated by the design contained within the circle. In the case of the symbol at left, it means that the unit must never be disassembled.
	The ⚡ symbol alerts the user to things that must be carried out. The specific thing that must be done is indicated by the design contained within the circle. In the case of the symbol at left, it means that the power-cord plug must be unplugged from the outlet.

ALWAYS OBSERVE THE FOLLOWING







⚠ WARNING

- Before using this unit, make sure to read the instructions below, and the Owner's Manual.
- Do not open (or modify in any way) the unit or its AC adaptor.
- Do not attempt to repair the unit, or replace parts within it (except when this manual provides specific instructions directing you to do so). Refer all servicing to your retailer, the nearest Roland Service Center, or an authorized Roland distributor, as listed on the "Information" page.
- Never use or store the unit in places that are:
 - Subject to temperature extremes (e.g., direct sunlight in an enclosed vehicle, near a heating duct, on top of heat-generating equipment); or are
 - Damp (e.g., baths, washrooms, on wet floors); or are
 - Humid; or are
 - Exposed to rain; or are
 - Dusty; or are
 - Subject to high levels of vibration.
- Protect the unit from strong impact. (Do not drop it!)
- In households with small children, an adult should provide supervision until the child is capable of following all the rules essential for the safe operation of the unit.



⚠ WARNING

- Make sure you always have the unit placed so it is level and sure to remain stable. Never place it on stands that could wobble, or on inclined surfaces.
- Use only the specified AC adaptor (PSA series), and make sure the line voltage at the installation matches the input voltage specified on the AC adaptor's body. Other AC adaptors may use a different polarity, or be designed for a different voltage, so their use could result in damage, malfunction, or electric shock.
- Do not excessively twist or bend the power cord, nor place heavy objects on it. Doing so can damage the cord, producing severed elements and short circuits. Damaged cords are fire and shock hazards!
- This unit, either alone or in combination with an amplifier and headphones or speakers, may be capable of producing sound levels that could cause permanent hearing loss. Do not operate for a long period of time at a high volume level, or at a level that is uncomfortable. If you experience any hearing loss or ringing in the ears, you should immediately stop using the unit, and consult an audiologist.
- Do not force the unit's power-supply cord to share an outlet with an unreasonable number of other devices. Be especially careful when using extension cords—the total power used by all devices you have connected to the extension cord's outlet must never exceed the power rating (watts/amperes) for the extension cord. Excessive loads can cause the insulation on the cord to heat up and eventually melt through.











WARNING

- Do not allow any objects (e.g., flammable material, coins, pins); or liquids of any kind (water, soft drinks, etc.) to penetrate the unit. 

- Immediately turn the power off, remove the AC adaptor from the outlet, and request servicing by your retailer, the nearest Roland Service Center, or an authorized Roland distributor, as listed on the "Information" page when: 
 - The AC adaptor or the power-supply cord has been damaged; or
 - If smoke or unusual odor occurs
 - Objects have fallen into, or liquid has been spilled onto the unit; or
 - The unit has been exposed to rain (or otherwise has become wet); or
 - The unit does not appear to operate normally or exhibits a marked change in performance.
- Before using the unit in a foreign country, consult with your retailer, the nearest Roland Service Center, or an authorized Roland distributor, as listed on the "Information" page. 
- Batteries must never be recharged, heated, taken apart, or thrown into fire or water. 

CAUTION

- The unit and the AC adaptor should be located so their location or position does not interfere with their proper ventilation. 
- Always grasp only the output plug or the body of the AC adaptor when plugging into, or unplugging from, this unit or an outlet. 
- At regular intervals, you should unplug the AC adaptor and clean it by using a dry cloth to wipe all dust and other accumulations away from its prongs. Also, disconnect the power plug from the power outlet whenever the unit is to remain unused for an extended period of time. Any accumulation of dust between the power plug and the power outlet can result in poor insulation and lead to fire. 

CAUTION

- Try to prevent cords and cables from becoming entangled. Also, all cords and cables should be placed so they are out of the reach of children. 
- Never climb on top of, nor place heavy objects on the unit. 
- Never handle the AC adaptor body, or its output plugs, with wet hands when plugging into, or unplugging from, an outlet or this unit. 
- Before moving the unit, disconnect the AC adaptor and all cords coming from external devices. 
- Before cleaning the unit, turn off the power and unplug the AC adaptor from the outlet (p. 12). 
- Whenever you suspect the possibility of lightning in your area, disconnect the AC adaptor from the outlet. 
- If used improperly, batteries may explode or leak and cause damage or injury. In the interest of safety, please read and observe the following precautions (p. 11). 

 - Carefully follow the installation instructions for batteries, and make sure you observe the correct polarity. 
 - Avoid using new batteries together with used ones. In addition, avoid mixing different types of batteries.
 - Remove the batteries whenever the unit is to remain unused for an extended period of time.
 - If a battery has leaked, use a soft piece of cloth or paper towel to wipe all remnants of the discharge from the battery compartment. Then install new batteries. To avoid inflammation of the skin, make sure that none of the battery discharge gets onto your hands or skin. Exercise the utmost caution so that none of the discharge gets near your eyes. Immediately rinse the affected area with running water if any of the discharge has entered the eyes.
 - Never keep batteries together with metallic objects such as ballpoint pens, necklaces, hairpins, etc.
- Used batteries must be disposed of in compliance with whatever regulations for their safe disposal that may be observed in the region in which you live. 

IMPORTANT NOTES

In addition to the items listed under "USING THE UNIT SAFELY" on page 2–3, please read and observe the following:

Power Supply: Use of Batteries

- Do not connect this unit to same electrical outlet that is being used by an electrical appliance that is controlled by an inverter (such as a refrigerator, washing machine, microwave oven, or air conditioner), or that contains a motor. Depending on the way in which the electrical appliance is used, power supply noise may cause this unit to malfunction or may produce audible noise. If it is not practical to use a separate electrical outlet, connect a power supply noise filter between this unit and the electrical outlet.
- The AC adaptor will begin to generate heat after long hours of consecutive use. This is normal, and is not a cause for concern.
- The use of an AC adaptor is recommended as the unit's power consumption is relatively high. For battery operation, we recommend the use of alkaline batteries.
- Batteries should always be installed or replaced before connecting any other devices. This way, you can prevent malfunction and/or damage to speakers or other devices.
- Batteries are supplied with the unit. The life of these batteries may be limited, however, since their primary purpose was to enable testing.
- Before connecting this unit to other devices, turn off the power to all units. This will help prevent malfunctions and/or damage to speakers or other devices.

Placement

- Using the unit near power amplifiers (or other equipment containing large power transformers) may induce hum. To alleviate the problem, change the orientation of this unit, or move it farther away from the source of interference.
- This device may interfere with radio and television reception. Do not use this device in the vicinity of such receivers.
- Noise may be produced if wireless communications devices, such as cell phones, are operated in the vicinity of this unit. Such noise could occur when receiving or initiating a call, or while conversing. Should you experience such problems, you should relocate such wireless devices so they are at a greater distance from this unit, or switch them off.

- When moved from one location to another where the temperature and/or humidity is very different, water droplets (condensation) may form inside the unit. Damage or malfunction may result if you attempt to use the unit in this condition. Therefore, before using the unit, you must allow it to stand for several hours, until the condensation has completely evaporated.
- Depending on the material and temperature of the surface on which you place the unit, its rubber feet may discolor or mar the surface. You can place a piece of felt or cloth under the rubber feet to prevent this from happening. If you do so, please make sure that the unit will not slip or move accidentally.

Maintenance

- For everyday cleaning wipe the unit with a soft, dry cloth or one that has been slightly dampened with water. To remove stubborn dirt, use a cloth impregnated with a mild, non-abrasive detergent. Afterwards, be sure to wipe the unit thoroughly with a soft, dry cloth.
- Never use benzene, thinners, alcohol or solvents of any kind, to avoid the possibility of discoloration and/or deformation.

Repairs and Data

- Please be aware that all data contained in the unit's memory may be lost when the unit is sent for repairs. Important data should always be written down on paper (when possible). During repairs, due care is taken to avoid the loss of data. However, in certain cases (such as when circuitry related to memory itself is out of order), we regret that it may not be possible to restore the data, and BOSS/Roland assumes no liability concerning such loss of data.

Additional Precautions

- Please be aware that the contents of memory can be irretrievably lost as a result of a malfunction, or the improper operation of the unit. To protect yourself against the risk of losing important data, we recommend that you periodically written down a important data onto paper.
- Unfortunately, it may be impossible to restore the contents of data that was stored in the unit's memory once it has been lost. BOSS/Roland Corporation assumes no liability concerning such loss of data.

- Use a reasonable amount of care when using the unit's buttons, sliders, or other controls; and when using its jacks and connectors. Rough handling can lead to malfunctions.
- When connecting / disconnecting all cables, grasp the connector itself—never pull on the cable. This way you will avoid causing shorts, or damage to the cable's internal elements.
- To avoid disturbing your neighbors, try to keep the unit's volume at reasonable levels. You may prefer to use headphones, so you do not need to be concerned about those around you (especially when it is late at night).
- When you need to transport the unit, package it in the box (including padding) that it came in, if possible. Otherwise, you will need to use equivalent packaging materials.
- Some connection cables contain resistors. Do not use cables that incorporate resistors for connecting to this unit. The use of such cables can cause the sound level to be extremely low, or impossible to hear. For information on cable specifications, contact the manufacturer of the cable.

Printing Conventions and icons in This Manual

Text or numerals enclosed in square brackets []	Indicate buttons. [WRITE] WRITE button
NOTE	Indicates information that you should be aware of when using the ME-20.
MEMO	Indicates supplementary information about an operation.
TIP	Indicates information about a convenient operation.
 (p.**)	Indicates a reference page.

Contents

Main Features	1	Saving and Calling Up Tones (Memory Mode)	23
IMPORTANT NOTES	4	Manual Mode and Memory Mode	23
Names of Things and What They Do	7	Switching Between Manual and Memory Mode.....	23
Front Panel.....	7	Patches and Banks.....	23
Rear Panel	10	Saving Tones (Write).....	24
Installing Batteries	11	Calling Up and Using Saved Sounds (Patch Change)	25
Connections	12	Switching Numbers.....	25
Turning On the Power	13	Switching Banks.....	25
Turning Off the Power	13	Changing Patch Settings (Patch Edit Mode).....	26
Tuning the Guitar (Bypass/ Tuner)	14	Other Functions	27
Introduction to Effects and Parameters	16	Using Footswitch Pedals	27
About the Effect Connection		Connecting a Footswitch Pedal	27
Sequence	16	Returning the ME-20 to Its Factory Settings (Factory Reset)	29
OD/DS SOLO	16	Adjusting the Expression Pedal ...	30
OD/DS (Overdrive/Distortion).....	17	Patch List	31
MOD (Modulation).....	18	Factory Settings	32
DELAY	19	Blank Chart.....	34
EQ (Equalizer).....	20	Troubleshooting	36
WAH.....	21	Specifications	37
NS (Noise Suppressor)	21	Index	38
THRESHOLD	21		
MASTER LEVEL	21		
Creating Sounds Easily (EZ EDIT).....	22		

Names of Things and What They Do

Front Panel

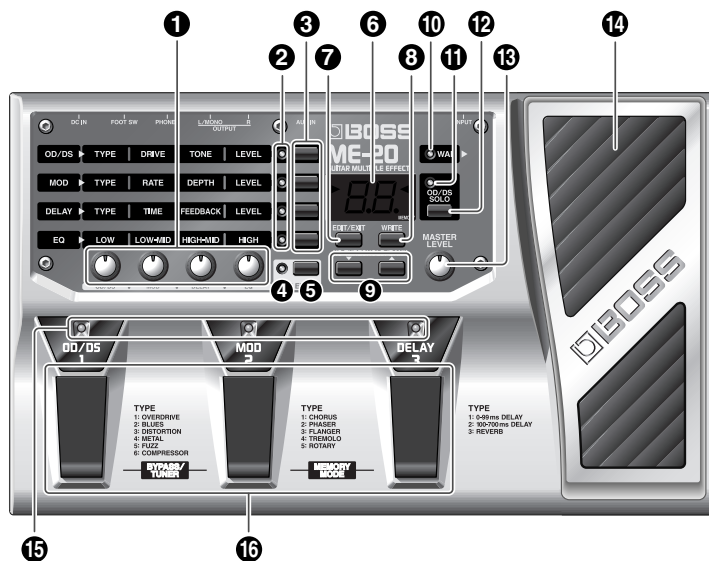

1. Parameter Knobs

These adjust parameters selected with the effect buttons and EZ EDIT button. You can check a parameter's current value by holding down its effect select button and turning the knob (this displays the value without adjusting it).

TIP

You can change how the knobs respond when turned.

1. **Switch to Manual mode (p. 23).**
2. **Hold down the [EDIT/EXIT] button and press Number Pedal 1.**
One of the following appears in the display.
n0: The value changes immediately as the knob is turned (factory setting).
n1: The value changes once the knob is turned past the position corresponding to the currently set value.
3. **Press [▼][▲] to change the value of the setting as desired.**
4. **Press [WRITE]. The setting is saved, and the ME-20 returns to Manual mode.**

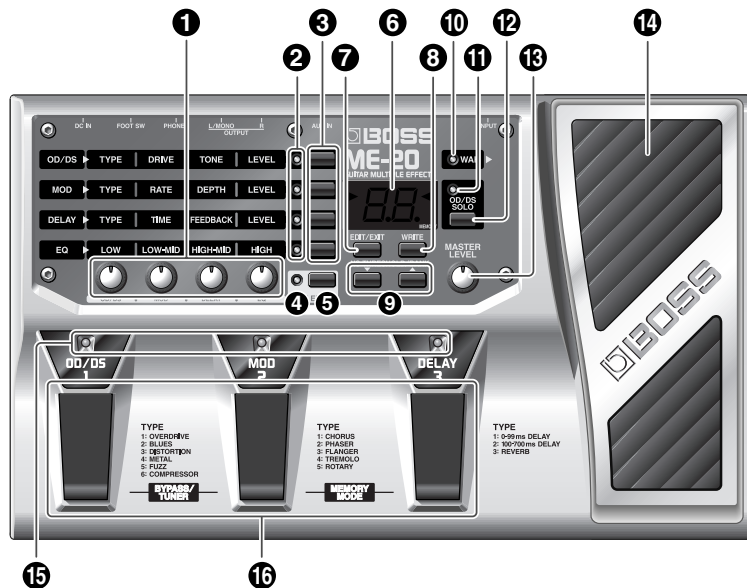

2. Effect Select Indicators

Show effects you can set using the parameter knobs.

3. Effect Select Buttons

Press these buttons to select the effect whose settings you want to change.

4. EZ EDIT Indicator

Shows whether EZ EDIT is on or off.

5. EZ EDIT Button

Press this to use EZ EDIT (p. 22).

6. Display

Shows the values of parameter settings, bank numbers, and other information.

* When the batteries run down, "bt" is indicated in the display. When this occurs, replace with new batteries.

7. EDIT/EXIT Button

Press this to edit patches in Memory mode (or exit editing).

8. WRITE Button

Press this to save the current sound in User memory.

9. ▼/▲ Buttons

Use these to adjust parameters in the various operating modes.

Manual mode: NS THRESHOLD

Memory mode: Bank (NS THRESHOLD when editing patches)

TUNER: Reference pitch

10. WAH Indicator

Shows whether the wah effect is on or off.

11. OD/DS SOLO Indicator

Shows whether the solo sound is on or off.

12. OD/DS SOLO Button

Press this to switch to a sound suited for solos.

Pressing this button automatically switches on overdrive/distortion.

13. MASTER LEVEL Knob

Adjusts the volume of the output.

14. Expression Pedal

Controls the volume level (volume pedal).

Firmly depressing the front end of the pedal switches WAH ON/OFF.

When the wah effect is on, the pedal functions as a wah pedal.

When WAH is on: Functions as a wah pedal.

When WAH is off: Functions as a volume pedal.

NOTE

When operating the expression pedal, be careful not to get your fingers pinched between the movable part and the panel. In places with small children, an adult should provide supervision and guidance until the child is capable of following all the rules essential for the safe operation of the unit.

15. Pedal Indicators

Show whether the corresponding effect is on or off.

In Memory mode, they indicate the current patch number.

16. Effect/Number Pedals

Switch the corresponding effects on and off.

When the ME-20 is in Memory mode, these switch correspondingly numbered patches.

TIP

Holding down the OD/DS pedal for two seconds when in Manual mode switches you to the OD/DS SOLO on/off function. Holding it down for two seconds a second time returns you to the OD/DS on/off function.

Rear Panel

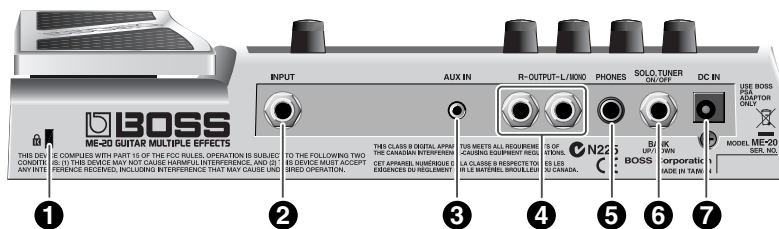

1. SECURITY LOCK ()
<http://www.kensington.com/>

2. INPUT Jack
Connect your guitar here.
** The INPUT jack doubles as a power switch. Inserting a plug into the INPUT jack turns on the power; the power is switched off when the plug is disconnected. Be sure to unplug the cable from this jack when the ME-20 is not in use.*

3. AUX IN Jack
Connect a CD or MP3 player here to practice with sounds from these devices.
** You cannot adjust the volume of the AUX input. Adjust the volume on the connected device.
* Do not use a cable that contains a resistor to connect external devices to the AUX IN jack. Use of such cables may make sounds from connected devices inaudible.
* No effects are applied to the AUX input signal.*

4. OUTPUT L/MONO, R Jacks
Connect an amp or mixer here.

5. PHONES (Headphones) Jack
Connect stereo headphones here.

MEMO

When headphones are connected to the PHONES jack, tonal adjustments are applied so the sound is close to that produced by the guitar amp.

6. FOOT SW (Footswitch) Jack
Connect an optional footswitch (such as the FS-6) here.
The footswitch functions differently in Manual mode and Memory mode.

When in Manual mode: Switches the OD/DS Solo on/off.
Switches the Bypass/Tuner on/off.

When in Memory mode: Bank up, Bank down

7. DC IN (AC Adaptor) Jack
Connect the optional AC adaptor (PSA series) here.

** Use only the specified AC adaptor (PSA series).*

Installing Batteries

Insert the batteries as shown in figure, being careful to orient the batteries correctly.

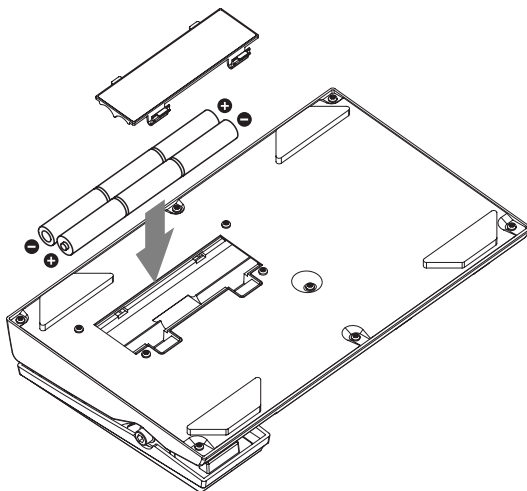

NOTE

- When the batteries run down, “bt” appears in the display. When this occurs, install new batteries.
- When turning the unit over, place some newspapers, magazines, or other suitable material under the four corners or at both ends to prevent damage to the buttons and controls. Also, try to position the unit so no buttons or controls can get damaged.
- When turning the unit over, handle it with care to avoid dropping it or allowing it to fall or tip over.
- Make sure the “+” and “-” ends of the batteries are oriented correctly.
- Use six AA-type dry cells when replacing the batteries.
- Avoid using new and used batteries together or combinations of different types of batteries. Doing so may result in fluid leakage.
- Batteries are supplied with the unit. Since the primary purpose of these batteries is to confirm operation of the unit, their battery life may be limited.

MEMO

Continuous usage time under battery power is about 13 hours with alkaline batteries and about 3.5 hours with manganese batteries. (This may vary according to usage conditions.)

Connections

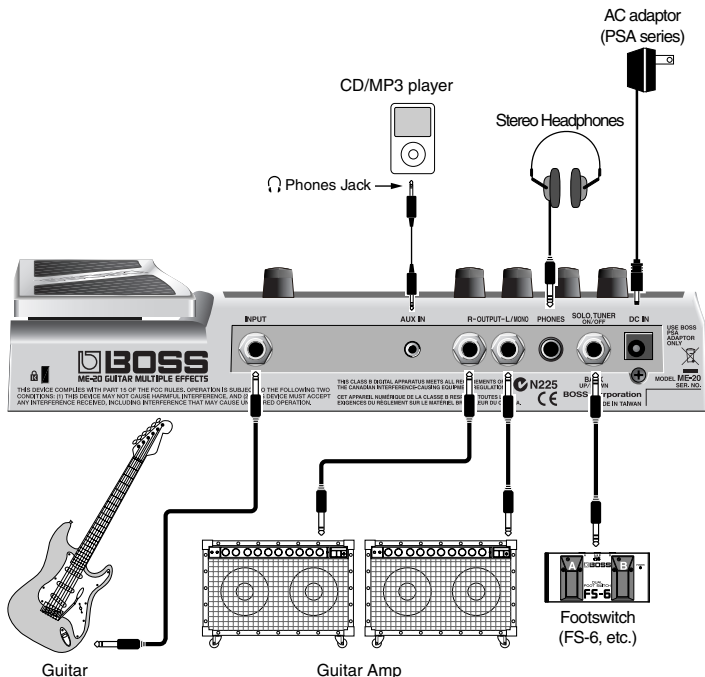

- * When using an AC adaptor, be sure to use only the specified type (PSA series). Using an adaptor other than the specified type may cause malfunction.
- * To prevent malfunction and/or damage to speakers or other devices, always turn down the volume and turn off the power to all devices before making any connections.
- * The INPUT jack doubles as a power switch. Inserting a plug in the INPUT jack turns on the power; the power is switched off when the plug is disconnected. Be sure to unplug the cable from this jack when the ME-20 is not in use.
- * Some connection cables contain resistors. When connection cables with resistors are used, the sound level may be extremely low, or impossible to hear. For information on cable specifications, contact the manufacturer of the cable.
- * When you're using a single guitar amp, connect it to the L/MONO jack.



For more information about connecting a footswitch pedal to the footswitch jack, refer to "Using Footswitch Pedals" (p. 27).

Turn on power to the various devices in the order specified. Turning on devices in the wrong order may cause malfunction and/or damage to speakers and other devices.

Turning On the Power

- 1. Completely turn down the volume on all devices and connect the external devices.**
 - * Don't insert the plug into the INPUT jack yet.
- 2. Insert the plug into the INPUT jack.**
 - * Inserting a plug into the INPUT jack switches on the power.
- 3. Turn on the power to the CD or MP3 player or other input device.**
- 4. Lastly, turn on the power to the guitar amp or other output device.**
- 5. Following this, adjust the volume of each device.**
 - * This unit is equipped with a protection circuit. A brief interval (a few seconds) after power-up is required before the unit will operate normally.

Turning Off the Power

- 1. Completely turn down the volume of all devices.**
- 2. First, turn off the power to the guitar amp and other output devices.**
- 3. Turn off the power to the CD or MP3 player or other input device.**
- 4. Pull out the plug from the INPUT jack.**
 - * Disconnecting the plug from the INPUT jack switches off the power.

TIP

Recommended Settings

Recommended Settings for a Roland JC-120

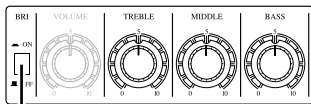

Set to OFF

Recommended Settings for a Combo Amp

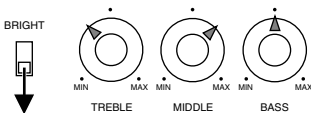

Set to OFF

Recommended Settings for a Stack Amp

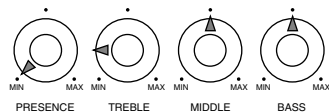

Tuning the Guitar (Bypass/Tuner)

The ME-20 features a built-in chromatic auto-tuner that allows you to tune your guitar easily without changing any of your connections.

Additionally, in Tuner mode, the sound output is the same as the input sound, with no effects applied (bypass). You can use the expression pedal to turn down the volume, making it unnecessary for you to turn down your amp's volume each time you tune.

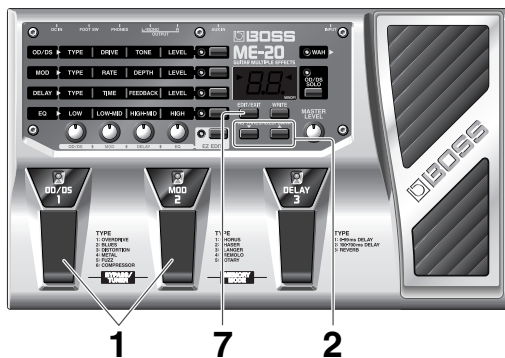

1. Press the Number 1 and 2 pedals simultaneously to switch to Tuner mode.

The tuner appears in the display, and any deviation from the pitch is indicated by the Tuning guide.

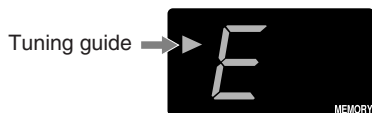

2. If necessary, you can change the reference pitch.

Press [▼] [▲] and the current reference pitch is indicated in the display for a brief length of time.

By continuing with this operation, you can change the reference pitch, in one Hertz units, to any value from 435 Hz to 445 Hz.

The setting is saved automatically, so there is no need to make this setting each time you tune.

* The reference pitch was set to 440 Hz (Display: 40) when the unit was shipped from the factory.

Display	35-45
Pitch (Hz)	435-445

3. Play a single note on the string to be tuned; play the string open.

The name of the note closest to the pitch of the string played appears in the display.

* Use your hand or other means to mute the other strings. You may be unable to tune the string accurately if other strings are vibrating during tuning.

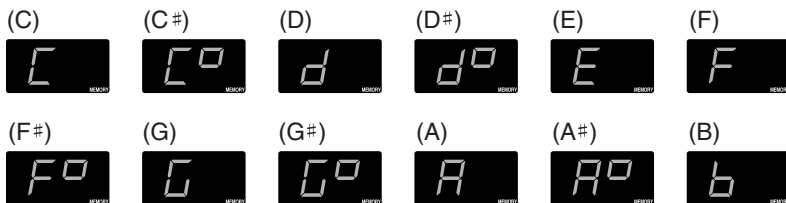

- 4. First do a rough tuning so that the name of the note for the string appears in the display.**
(General Tuning)

7th	6th	5th	4th	3rd	2nd	1st
B	E	A	D	G	B	E

- 5. Tune each string more accurately until both of the tuning guides are lit.**

* *The larger the difference between the pitch of the string you're playing and the correct pitch for the note shown in the display, the faster the tuning guide flashes. As you get closer to the correct pitch, the pace of the tuning guide's flashing slows down.*



Too high



Tuned



Too low

- 6. Repeat Steps 3–5 to tune the other strings.**

* *If you are tuning a guitar that has a vibrato arm, tuning one string may cause other strings to drift. In this case, you should first tune the strings approximately so that the correct note name is displayed, and then re-tune each string.*

TIP

One useful technique that makes tuning less confusing is to start slightly under the target pitch and then tune upwards little by little until the string is in tune.

- 7. Press the Number 1 and 2 pedals simultaneously to return to the previous mode.**
You can also return to the previous mode by pressing [EDIT/EXIT].

Introduction to Effects and Parameters

About the Effect Connection Sequence

The optimal sequence for connecting effects is determined automatically based on the effect settings.

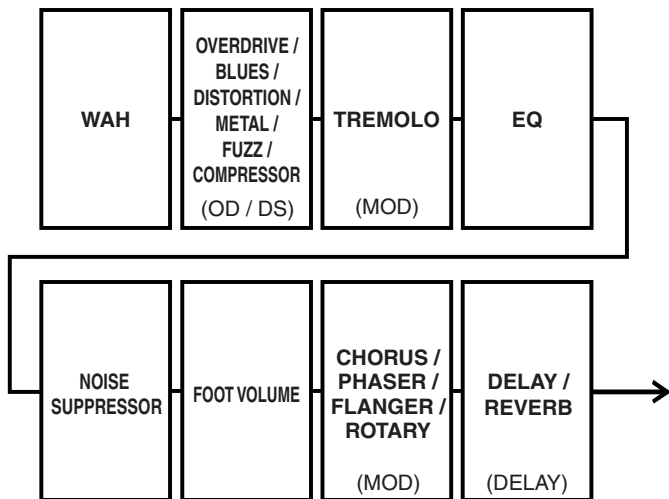

OD/DS SOLO

The OD/DS effect sound is switched to a sound suited for solo performances. Turning on the OD/DS SOLO effect sound makes the OD/DS effect come on as well, even if it was previously off.

TIP

To adjust the amount of OD/DS SOLO effect that's applied when the effect is on, hold down [OD/DS SOLO] while you press [▼] or [▲].

OD/DS (Overdrive/Distortion)

This effect uses distortion to add unique characteristics to a sound and allows you to sustain the sound.

OD/DS Type List

TYPE	Descriptions
1: OVERDRIVE	A sweet, mild distortion like that of a tube amp.
2: BLUES	A unique type of overdrive that brings out the nuances of your picking.
3: DISTORTION	Sharp distortion providing rich sustain.
4: METAL	A powerful, spirited distortion sound.
5: FUZZ	A unique distortion with a rough, intense sound.
6: COMPRESSOR	This effect produces long sustain without distorting the sound. You can also use it as a "limiter" to suppress only the sound peaks and prevent distortion.



OD/DS	TYPE	DRIVE	TONE	LEVEL
Descriptions	1: OVERDRIVE	Adjusts the amount of distortion. Turn to the right (clockwise) to boost the distortion; this also increases the volume.	Adjusts the tone. Turn to the left (counterclockwise) to produce a warmer sound, to the right (clockwise) to produce a brighter sound.	Adjusts the volume level.
	2: BLUES			
	3: DISTORTION			
	4: METAL			
	5: FUZZ			
	6: COMPRESSOR	Adjusts the sustain. Turn to the right (clockwise) to produce a longer sustain. Turning the knob to the left (counterclockwise) creates an effect resembling a limiter.		

MOD (Modulation)

This effect broadens and adds an undulation effect to the sound.

MOD Type List

TYPE	Descriptions
1: CHORUS	This effect adds a subtle wavering to the sound, transforming it into a beautiful sound with breadth and body.
2: PHASER	This creates a sound with a shifting phase, adding a twisting “warp” effect to the sound.
3: FLANGER	This effect adds a subtle type of motion that creates a sound similar to the ascent/descent sounds of a jet plane.
4: TREMOLO	This effect creates a sense of undulation by cyclically changing the volume level.
5: ROTARY	This produces the effect of a rotary speaker.



	MOD	TYPE	RATE	DEPTH	LEVEL
Descriptions	1: CHORUS	Adjusts the period of the wavering cycle. Turning the knob to the right increases the rate.	Adjusts the depth of the wavering sound. Turning the knob to the right increases the depth.	Adjusts the volume of the effect sound.	
	2: PHASER	Adjusts the period of the undulation cycle.	Adjusts the depth of the undulation. Turning the knob to the right increases the depth.	Adjusts the intensity of the unique characteristics.	
	3: FLANGER	Turning the knob to the right increases the rate.	Adjusts the amount of the change in volume. Turning the knob to the right increases the volume.	Adjusts the volume of the effect sound.	
	4: TREMOLO	Adjusts the speed of rotation. Turning the knob to the right increases the rate.	Adjusts the depth of the effect. Turning the knob to the right increases the depth.	Adjusts the volume of the effect sound.	
	5: ROTARY				

DELAY

These are spatial effects that let you to do things like make the sound thicker or create special effects by adding delayed sound or reverb to the input sound.

DELAY Type List

TYPE	Descriptions
1: 0–99 ms DELAY	Delay sound with a delay time from 0 to 99 ms.
2: 100–700 ms DELAY	Delay sound with a delay time from 100 to 700 ms.
3: REVERB	An effect that adds reverberation to the sound.



	DELAY	TYPE	TIME	FEEDBACK	LEVEL
Descriptions	1: 0–99 ms DELAY	The delay time can be set in increments of 1 ms.	Adjusts the number of repeats of the delay sound. Turning the knob to the right increases the number of times the delay is repeated.	Adjusts the volume of the effect sound.	
	2: 100–700 ms DELAY	The delay time can be set in increments of 10 ms. In the display, the value is shown as the number of 10 ms units (10–70).			
	3: REVERB	Adjusts the length (reverb time) of the reverberation.	Adjusts the tone quality of the reverberation. Turning the knob to the right creates a brighter sound.		

EQ (Equalizer)

This effect adjusts the tone quality. Turning the knob to the right (clockwise) boosts the volume in the corresponding frequency range; turning it counterclockwise cuts the volume. Placing all parameter knobs at the center produces a flat response.



EQ	LOW	LOW-MID	HIGH-MID	HIGH
Descriptions	Adjusts the tone quality of the low-frequency range.	Adjusts the tone quality of the low-mid-frequency range.	Adjusts the tone quality of the high-mid-frequency range.	Adjusts the tone quality of the high-frequency range.

WAH

This effect creates a “wah” effect using the pedal controller.

Stepping down on the pedal creates a brighter sound, while releasing the pedal produces a muffled sound.

When the wah effect is on, the pedal functions as a wah pedal.

When WAH is on: Functions as a wah pedal.

When WAH is off: Functions as a volume pedal.

NS (Noise Suppressor)

This effect suppresses noise and hum from the pickups.

THRESHOLD



This adjusts the effect in response to the level of noise. Increase the value when there is a considerable amount of noise. Decrease the value when there isn't that much noise. A value of 0 switches off the noise suppressor.

- * *Setting the value higher than necessary may result in no output of sounds when the guitar volume is low.*
- * *Adjust this value until the decay of the guitar sound is as natural as possible.*

MASTER LEVEL



This adjusts the level of the output from the ME-20.

- * *Raising the MASTER LEVEL knob too much may result in sound distortion.*
- * *When the effects are all off, input and output are at the same levels as when the MASTER LEVEL knob is at the center position.*
- * *The setting of the MASTER LEVEL knob is stored in memory for each patch (p. 23).*

Creating Sounds Easily (EZ EDIT)

EZ EDIT is a feature for creating sounds quickly and easily. You can adjust a combination of effect parameters with just a single knob.

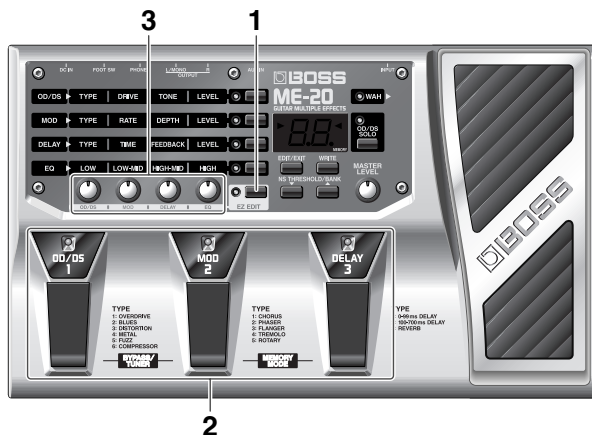

1. Press [EZ EDIT].
2. Press the effect pedal to switch the effect ON/OFF setting.
3. Change the sound by turning the knob for the effect whose settings you want to change.
4. Switch the sounds as needed by repeating Steps 2 and 3.

EZ EDIT Setting List

NO.	OD/DS	MOD	DELAY	EQ
1	OVERDRIVE 1	LIGHT CHORUS	MEDIUM DELAY 1 (360ms)	FLAT
2	OVERDRIVE 2	DEEP CHORUS	SHORT DELAY 1 (160ms)	MID BOOST
3	BLUES 1	SLOW PHASER	DOUBLING	SCOOP
4	BLUES 2	MEDIUM PHASER	MEDIUM DELAY 2 (500ms)	VINTAGE
5	DISTORTION 1	LIGHT FLANGER	LONG DELAY (700ms)	BRIGHT
6	DISTORTION 2	DEEP FLANGER	SHORT DELAY 2 (90ms)	FAT LEAD
7	METAL 1	MEDIUM TREMOLO	RHYTHM DELAY (400ms)	JAZZ
8	METAL 2	FAST TREMOLO	SMALL REVERB	-
9	FUZZ 1	SLOW ROTARY	MEDIUM REVERB	-
10	FUZZ 2	FAST ROTARY	LARGE REVERB	-
11	COMPRESSOR	-	-	-

Saving and Calling Up Tones (Memory Mode)

Manual Mode and Memory Mode

When the power is turned on, the ME-20 starts up in “Manual mode.” In this mode, you can use the pedals to switch effects on or off, and you can manipulate the knobs to directly obtain the sound you want.

The ME-20 also features a “Memory mode,” which you can use in live performances and other situations where you want to be able to switch settings instantly to suit the particular circumstances.

Switching Between Manual and Memory Mode

- When in Manual mode, simultaneously press Number Pedals 2 and 3 to switch to Memory mode. The MEMORY indicator lights.
- When in Memory mode, simultaneously press the Number Pedals 2 and 3 to switch to Manual mode. The MEMORY indicator disappears.

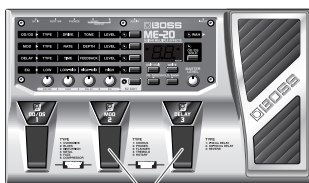

Press simultaneously



Patches and Banks

A collection of sound parameters that can be handled together is called a “patch.”

In Memory mode, you can call up patches to switch the sound instantly.

On the ME-20, you can create up to 30 patches.

These are grouped together into units called “banks.” A single bank contains three patches, which correspond to the respective number pedals.

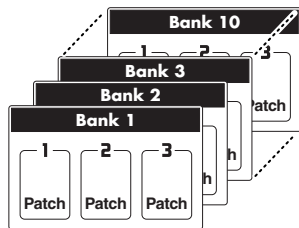

Saving Tones (Write)

The steps you need to follow in order to save the patches you've created using the panel's knobs and pedals in User memory is called the "Write procedure."

You can carry out the Write procedure in both Manual mode and Memory mode.

Carrying out the Write procedure results in the loss of any settings previously existing in the targeted patch location (the save destination).

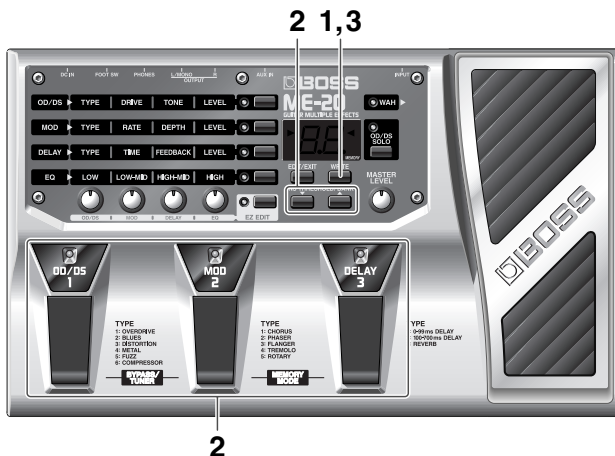

1. Press [WRITE].

The bank shown in the display and the pedal indicator flash to show the currently selected patch bank and number are indicated.

2. Select the save destination.

- Press [▼] [▲] to select the bank.
- Press a number pedal (1–3) to select the number.

* To stop the Write procedure, press [EDIT/EXIT] to return to the previous mode.

3. Press [WRITE] once more.

The sound is stored, and the ME-20 returns to Memory mode.

The display shows the bank, and the pedal indicators show the numbers.

Calling Up and Using Saved Sounds (Patch Change)

To switch patches, use [▼] [▲] and the number pedals (1–3).

- * When you initially switch to Memory mode after turning on the power, Bank 1, Number 1 is always selected.

Switching Numbers

When a number pedal (1) is pressed, the pedal indicator (2) lights up, the patch with that number in the currently selected bank is called up, and the sound is switched instantly.

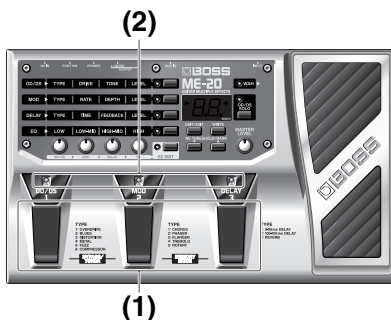

Switching Banks

The bank is switched each time [▼] [▲] (1) is pressed, and the currently selected bank flashes in the display (2); sounds are not yet switched at this point.

- * With the ME-20 in this state, pressing any of the number pedals (3) instantly switches the sound to the sound of the patch assigned to the currently selected bank/number.

You can switch banks with the number pedals.

In Memory mode, if you continue

depressing the number pedal for the currently selected patch for two seconds, the pedal indicator flashes, and the functions of the number pedals change as shown below.

Number Pedal 1: Bank ▼

Number Pedal 2: Bank ▲

Number Pedal 3: Restores original pedal functions

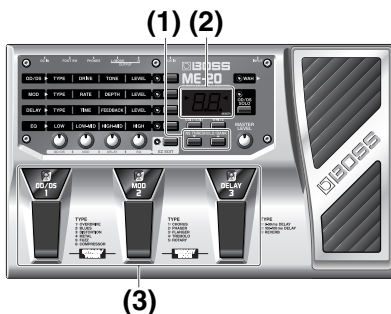

You can switch banks using a footswitch pedal. For more information, refer to "Using Footswitch Pedals" (p. 27).

Changing Patch Settings (Patch Edit Mode)

In Memory mode, switching effects on or off or adjusting NS THRESHOLD is not possible. To make these changes, you put the unit in Patch Edit mode.

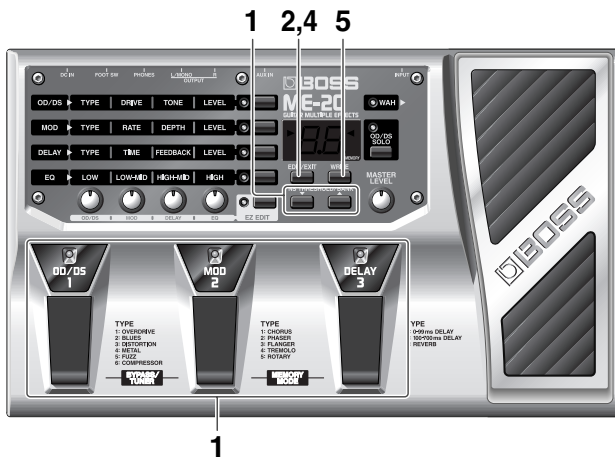

1. Call up to the patch whose settings you want to edit (p. 25).
2. Press [EDIT/EXIT].
“Ed” appears in the display and the MEMORY indicator starts to flash, indicating that the unit is now in Patch Edit mode.
As in Manual mode, with the ME-20 in this state, the number pedals switch the effects on and off, while [▼] [▲] control NS THRESHOLD, allowing you to set all the parameters.
3. Use the knobs, pedals, and buttons to change settings as desired.
4. Press [EDIT/EXIT] to return to Memory mode.
5. If you want to save your new settings, carry out the Write procedure (p. 24).
Changed settings are not saved until the Write procedure is performed. Switching to a different patch before saving a patch causes its changed content to be lost, so the next time the patch is selected, its previous settings are called up.

Other Functions

Using Footswitch Pedals

With an optional footswitch pedal (such as the BOSS FS-5U or FS-6) connected to the ME-20, you can use the footswitch for the following operations.

In Manual mode: Switches the OD/DS SOLO on/off.

Switches the Bypass/Tuner on/off.

In Memory mode: Bank up, Bank down

NOTE

To prevent malfunction and/or damage to speakers or other devices, always turn down the volume and turn off the power to all devices before making any connections.

Disconnecting or connecting plugs during startup may switch OD/DS SOLO or Tuner on or off.

Connecting a Footswitch Pedal

When Connecting an FS-5U



If using an FS-5U switch, set the POLARITY switch as shown in the following.



OD/DS SOLO
On/Off

Bank up

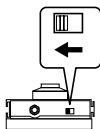

When Connecting Two FS-5Us or an FS-6

* Using a special Roland PCS-31 connection cable (optional), you can connect two FS-5Us.



PCS-31



Bypass/Tuner On/Off Bank down

OD/DS SOLO On/Off Bank up

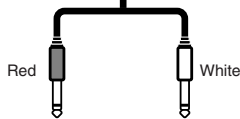

Bypass/Tuner On/Off Bank down

OD/DS SOLO On/Off Bank up

If using an FS-6 switch, set the MODE and POLARITY switches as shown below.

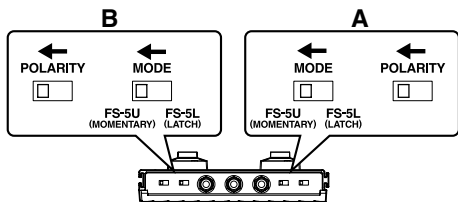

If using an FS-5U switch, set the POLARITY switch as shown in the following.

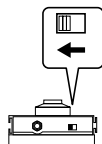

Returning the ME-20 to Its Factory Settings (Factory Reset)

You can restore the settings stored in the ME-20 (User memory, tuner reference pitch, and knob response method (p. 7)) to their original settings when the unit was shipped from the factory. This is referred to as “Factory Reset.”

To perform a Factory Reset, carry out the following steps.

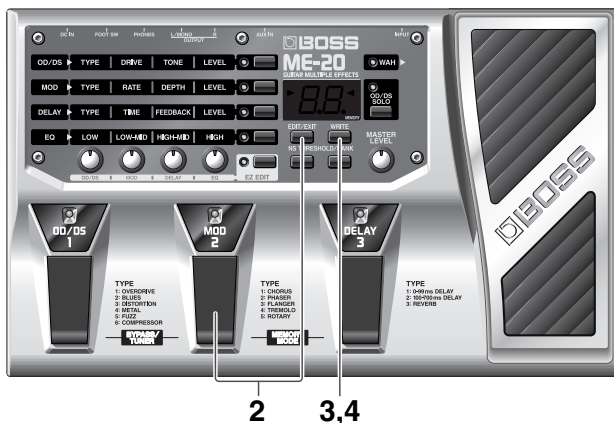

1. Switch to Manual mode (p. 23).
 2. Hold down [EDIT/EXIT] and press Number Pedal 2.
“FA” appears in the display.
 3. Press [WRITE].
The MEMORY indicator flashes and the unit goes into standby.
- * To cancel the Factory Reset, press [EDIT/EXIT] again to return to the original mode.
4. Press [WRITE].
The Factory Reset is carried out.
When the Factory Reset is complete, the display goes dark and the unit returns to Manual mode.

NOTE

Never turn off the power while a Factory Reset is in progress.

Adjusting the Expression Pedal

Although the ME-20's expression pedal has been set for optimal operation at the factory, extended use and certain operating environments can result in the pedal going out of adjustment.

If you encounter problems, such as the expression pedal's ON/OFF switch not functioning or the volume pedal not fully cutting off the sound, you can use the following procedure to readjust the pedal.

NOTE

When operating the expression pedal, be careful not to get your fingers pinched between the movable part and the panel. In places with small children, an adult should provide supervision and guidance until the child is capable of following all the rules essential for the safe operation of the unit.

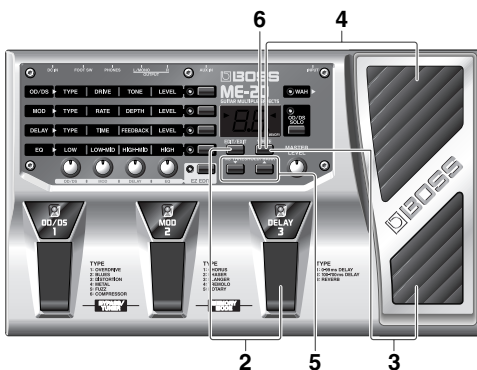

1. **Switch to Manual mode (p. 23).**
2. **Hold down [EDIT/EXIT] and press Number Pedal 3.**
 "Pd" appears in the display and then changes to "UP."
3. **Press the heel of the expression pedal to the base, and then press [WRITE].**
 "dn" appears in the display.
4. **Depress the toe of the expression pedal until it's all the way down, and press [WRITE].**
 "1"-"9" appears in the display.
 * This is set to "5" when shipped from the factory.
5. **Adjust the firmness of the switch action.**
 Press [▼] [▲] to set the value (1-9).
 The lower the value, the less force is needed in pressing the pedal to switch it on and off.
6. **Press [WRITE].**
 The setting is saved in memory and the unit returns to Manual mode.
 * If the display flashes in Steps 2 and 3, depress the pedal again, and then press [WRITE].

Patch List

BANK	NO.	Description
1	1	Rough distortion sound suitable for backing parts.
	2	Texas blues sound with rough distortion.
	3	Metal sound, great for riffs.
2	1	Bright crunch sound that works well for chord rhythms.
	2	Lasting overdrive sound, great for melodies.
	3	'60s fuzz sound.
3	1	Clean sound, good for rhythms.
	2	Clean sound suitable for playing arpeggios.
	3	Distortion sound suitable for solos.
4	1	Bright, clean sound that can also be used with metal styles.
	2	Lightly distorted chorus sound, suitable for arpeggios.
	3	'70s hard rock distortion sound.
5	1	Overdrive sound suitable for solos.
	2	Classic distortion sound.
	3	Metal sound, good for single-note riffs.
6	1	Clean wah sound, works well with rhythms.
	2	Broad distortion sound with chorus.
	3	Sustained fuzz sound, good for solos.
7	1	Phaser sound, works well with rhythms.
	2	Blues sound with powerful distortion, good for solos.
	3	Metal sound, good for solos.
8	1	Flanger sound suitable for arpeggios.
	2	Fat distortion sound, good for single-note riffs.
	3	Distortion sound with powerful phaser effect added.
9	1	Retro tremolo sound.
	2	Distortion sound with heavily twisting flanger effect.
	3	Drive sound with wah.
10	1	Expansive clean sound with chorus and delay.
	2	Rapidly revolving rotary sound.
	3	Deeply distorted wah sound, good for solos.

Factory Settings

BANK	NO.	OD/DS						MOD				
		SOLO	SW	TYPE	DRIVE	ZONE	LEVEL	SW	TYPE	RATE	DEPTH	LEVEL
1	1	OFF	ON	3	25	27	28	OFF	1	25	25	25
	2	OFF	ON	2	26	30	25	OFF	1	25	25	25
	3	OFF	ON	4	25	27	25	OFF	1	25	25	25
2	1	OFF	ON	2	7	25	32	OFF	1	25	25	25
	2	OFF	ON	1	37	25	24	OFF	1	25	25	25
	3	OFF	ON	5	17	31	25	OFF	5	29	23	33
3	1	OFF	ON	6	17	25	26	ON	1	23	40	50
	2	OFF	ON	1	6	31	30	OFF	1	25	25	50
	3	ON	ON	3	20	24	24	OFF	1	25	25	25
4	1	OFF	ON	6	25	25	25	ON	1	37	20	20
	2	OFF	ON	1	11	24	30	ON	1	15	20	19
	3	OFF	ON	3	18	27	28	OFF	1	25	25	25
5	1	ON	ON	1	28	25	23	OFF	1	25	25	25
	2	OFF	ON	3	10	15	36	OFF	1	25	25	25
	3	OFF	ON	4	40	20	24	OFF	1	25	25	25
6	1	OFF	OFF	6	16	25	25	OFF	1	25	25	25
	2	OFF	ON	3	25	25	24	ON	1	22	30	25
	3	ON	ON	5	40	28	20	OFF	1	25	25	25
7	1	OFF	OFF	6	25	25	25	ON	2	12	16	50
	2	ON	ON	2	24	30	23	OFF	1	25	25	25
	3	ON	ON	4	20	23	22	OFF	1	25	25	25
8	1	OFF	ON	2	7	25	30	ON	3	25	25	25
	2	OFF	ON	3	35	28	24	OFF	2	10	17	0
	3	OFF	ON	2	21	20	26	ON	2	37	15	0
9	1	OFF	ON	2	9	26	26	ON	4	30	26	30
	2	OFF	ON	3	30	29	23	ON	3	20	25	10
	3	OFF	ON	2	28	23	26	OFF	2	25	25	25
10	1	OFF	ON	6	27	29	21	ON	1	25	35	50
	2	OFF	ON	1	16	25	25	ON	5	37	16	50
	3	ON	ON	4	7	24	22	OFF	1	25	25	25

* The OD/DS Solo level is set to 25.

DELAY					EQ				WAH	NS	MASTER LEVEL
SW	TYPE	TIME	FEED-BACK	LEVEL	LOW	LOW-MID	HIGH-MID	HIGH	SW	THRESH-OLD	
OFF	2	37	15	20	28	23	23	25	OFF	25	25
OFF	2	11	6	18	21	25	25	25	OFF	15	25
OFF	2	37	15	20	26	25	25	28	OFF	30	25
OFF	2	37	15	20	28	25	29	19	OFF	15	25
OFF	2	37	15	20	25	26	25	30	OFF	24	25
ON	2	11	9	14	23	25	26	33	OFF	15	25
OFF	2	40	6	15	23	20	20	28	OFF	15	25
OFF	2	34	10	15	22	21	24	31	OFF	15	25
ON	2	34	10	15	28	31	24	15	OFF	25	25
ON	2	34	10	29	16	28	16	28	OFF	15	25
OFF	1	77	14	18	25	25	25	25	OFF	15	25
OFF	2	37	15	20	29	27	25	25	OFF	15	25
ON	2	40	10	13	25	25	25	25	OFF	15	25
OFF	3	7	10	15	20	10	30	10	OFF	15	25
OFF	2	37	15	20	27	26	28	25	OFF	35	25
OFF	2	29	10	24	25	25	28	25	ON	15	25
ON	2	41	8	19	25	25	25	25	OFF	15	25
ON	2	25	18	25	30	30	25	20	OFF	25	25
OFF	1	45	10	25	20	26	24	31	OFF	15	25
ON	1	46	11	23	25	25	27	25	OFF	15	25
ON	2	49	9	20	25	28	25	26	OFF	35	25
OFF	2	16	10	15	24	25	25	25	OFF	15	25
OFF	2	29	12	17	26	25	24	25	OFF	25	25
ON	2	16	10	10	27	27	25	28	OFF	15	25
ON	3	18	26	20	25	25	25	25	OFF	15	25
OFF	2	70	20	25	26	28	25	25	OFF	15	25
OFF	2	37	15	20	25	25	25	25	ON	15	25
ON	2	40	14	20	25	26	22	26	OFF	15	25
ON	3	18	15	13	24	25	25	25	OFF	15	25
ON	2	40	20	18	25	27	26	25	ON	35	25

Type List

NO.	OD/DS	MOD	DELAY
1	OVERDRIVE	CHORUS	0-99ms DELAY
2	BLUES	PHASER	100-700ms DELAY
3	DISTORTION	FLANGER	REVERB
4	METAL	TREMOLO	-
5	FUZZ	ROTARY	-
6	COMPRESSOR	-	-

Blank Chart

BANK	NO.	OD/DS						MOD				
		SOLO	SW	TYPE	DRIVE	TONE	LEVEL	SW	TYPE	RATE	DEPTH	LEVEL
1	1											
	2											
	3											
2	1											
	2											
	3											
3	1											
	2											
	3											
4	1											
	2											
	3											
5	1											
	2											
	3											
6	1											
	2											
	3											
7	1											
	2											
	3											
8	1											
	2											
	3											
9	1											
	2											
	3											
10	1											
	2											
	3											

DELAY					EQ				WAH	NS	MASTER LEVEL
SW	TYPE	TIME	FEED- BACK	LEVEL	LOW	LOW- MID	HIGH- MID	HIGH	SW	THRESH- OLD	

Type List

NO.	OD/DS	MOD	DELAY
1	OVERDRIVE	CHORUS	0-99ms DELAY
2	BLUES	PHASER	100-700ms DELAY
3	DISTORTION	FLANGER	REVERB
4	METAL	TREMOLO	-
5	FUZZ	ROTARY	-
6	COMPRESSOR	-	-

Troubleshooting

"bt" Appears in the Display

→ Batteries are run down. Replace with new batteries (p. 11).

Power does not turn on

○ **Is the correct AC adaptor (PSA series; sold separately) properly connected?**

→ Check once more to confirm the adaptor is connected (p. 12).
Never use any AC adaptor other than the adaptor specified.

○ **Has the battery run down?**

→ Replace with new batteries (p. 11).

* *The batteries included with the ME-20 are intended only for confirming that the unit is functional.*

* *This unit consumes a large amount of current, so the use of an AC adaptor is recommended. If using batteries, use alkaline-type batteries.*

* *To reduce battery consumption, be sure to disconnect the plug connected to the INPUT jack whenever the unit is not in use.*

○ **Is the plug properly connected to the INPUT jack?**

→ Check the connection once again (p. 12).

* *The power will not turn on without a plug connected to the INPUT jack.*

No Sound/Volume is Low

○ **Are the other devices properly connected?**

→ Check the connection once again (p. 12).

○ **Can you hear sound through the headphones when headphones are connected?**

→ If you can hear sound, there may be a short in the cable used to connect the amp or other device, or a mistake in an external device's settings. Check the connecting cables and external devices once more.

○ **Could the MASTER LEVEL knob be turned down?**

→ Use the MASTER LEVEL knob to raise the output volume.

○ **Could the levels for OD/DS or EQ be too low?**

→ Use the parameter knobs to raise the levels.

○ **Is the volume turned down?**

→ Check the volume levels on any connected amp or mixer.

Check "LEVEL" and other volume parameters to make sure no volume setting is too low.

○ **Could the level have been lowered with the expression pedal?**

→ When the pedal is set to function as a volume pedal, sounds are not output when the toe of the expression pedal is in the raised position.

○ **Is the ME-20 in Tuner mode?**

→ In Tuner mode, the bypassed sound is output, and the expression pedal functions as a volume pedal. In this case, sounds are not output when the toe of the pedal is in the raised position.

○ **Could you be using a cable with an embedded resistor to connect a CD or MP3 player to the AUX IN jack?**

→ Use of a cable that contains a resistor may make sound from connected devices inaudible.

Patches Cannot Be Switched

○ **Is the ME-20 in Memory mode?**

→ In Memory mode, the display indicates the bank, the pedal indicators show the current patch, and the effect-select indicators light. Conditions other than these mean the ME-20 is in another mode, so patches cannot be changed. First switch the ME-20 to Memory mode, then continue (p. 23).

The Expression Pedal Switch Cannot Be Turned On or Off

The Volume Pedal Cannot Reduce the Volume Completely

○ **Could the expression pedal be out of adjustment?**

→ Although the unit's expression pedal has been set for optimal operation at the factory, extended use and certain operating environments can result in the pedal going out of adjustment.

Adjust the expression pedal (p. 30).

Specifications

ME-20: Guitar Multiple Effects

● AD Conversion

24-bit + AF method (*)

● DA Conversion

24-bit

● Sampling Frequency

44.1 kHz

● Patches

30 (user)

● Nominal Input Level

INPUT: -10 dBu

AUX IN: -18 dBu

● Input Impedance

INPUT: 1 M Ω

AUX IN: 22 k Ω

● Nominal Output Level

-10 dBu

● Output Impedance

2 k Ω

● Display

7 segments, 2 characters LED

● Control

OD/DS/1 Pedal

MOD/2 Pedal

DELAY/3 Pedal

Expression Pedal

● Jacks

INPUT jack (1/4" phone type)

AUX IN jack (Stereo miniature phone type)

OUTPUT jacks L/MONO, R (1/4" phone type)

PHONES jack (Stereo 1/4" phone type)

FOOT SW jack (1/4" TRS phone type)

AC Adaptor jack

● Power Supply

DC 9 V: Dry batteries (R6/LR6 (AA) type) x 6,
AC Adaptor (PSA series: Optional)

● Current Draw

90 mA

* *Expected battery life under continuous use:*

Alkaline: 13 hours, Carbon: 3.5 hours

These figures will vary depending on the actual conditions of use.

● Dimensions

294 (W) x 179 (D) x 54 (H) mm

11-5/8 (W) x 7-1/16 (D) x 2-1/8 (H) inches

Maximum height:

294 (W) x 179 (D) x 74 (H) mm

11-5/8 (W) x 7-1/16 (D) x 2-15/16 (H) inches

● Weight

1.6 kg / 3 lbs 9 oz (including batteries)

● Accessories

Owner's Manual

Dry Batteries (Alkaline: LR6 (AA) type) x 6

Roland Service (Information Sheet)

● Options

AC Adaptor: BOSS PSA series

Footswitch: BOSS FS-6, FS-5U

Connection Cable: PCS-31 (Roland)

(Stereo 1/4" phone plug-1/4" phone plug x 2)

* $0 \text{ dBu} = 0.775 \text{ Vrms}$

* *In the interest of product improvement, the specifications and/or appearance of this unit are subject to change without prior notice.*

(*) *AF method (Adaptive Focus method)*

This is a proprietary method from Roland/BOSS that vastly improves the signal-to-noise (S/N) ratio of the A/D and D/A converters.

Index

Numerics

- 0–99 ms DELAY 19
- 100–700 ms DELAY 19

A

- AUX IN 10

B

- Bank 23, 25
- BLUES 17
- Bypass 14

C

- CHORUS 18
- COMPRESSOR 17

D

- DC IN 10
- DELAY 19
- Display 8
- DISTORTION 17

E

- Effect 16
- Effect Select 8
- Effect/Number Pedal 9
- EQ 20
- Equalizer 20
- EDIT/EXIT 8
- Expression Pedal 9, 30
- EZ EDIT 8, 22

F

- Factory Reset 29
- FLANGER 18
- FOOT SW 10
- Foot Switch Pedal 27
- Footswitch 10
- FUZZ 17

H

- Headphone 10

I

- INPUT 10

M

- Manual mode 9–10, 23, 27
- MASTER LEVEL 9, 21
- Memory mode 9–10, 23, 27
- METAL 17
- MOD 18
- Modulation 18

N

- Noise Suppressor 21
- NS 21

O

- OD/DS 17
- OD/DS SOLO 9, 16
- OUTPUT 10
- OVERDRIVE 17

P

- Parameter 7, 16
- Patch 23
- Patch Change 25
- Patch Edit Mode 26
- Pedal Indicator 9
- PHASER 18
- PHONES 10

R

- REVERB 19
- ROTARY 18

S

- Saving 23–24
- SOLO 16

T

- THRESHOLD 21
- TREMOLO 18
- Tuner 14
- Tuning 14

W

- WAH 9, 21
- Write 8, 24

For EU Countries

- UK** This symbol indicates that in EU countries, this product must be collected separately from household waste, as defined in each region. Products bearing this symbol must not be discarded together with household waste.
- DE** Dieses Symbol bedeutet, dass dieses Produkt in EU-Ländern getrennt vom Hausmüll gesammelt werden muss gemäß den regionalen Bestimmungen. Mit diesem Symbol gekennzeichnete Produkte dürfen nicht zusammen mit dem Hausmüll entsorgt werden.
- FR** Ce symbole indique que dans les pays de l'Union européenne, ce produit doit être collecté séparément des ordures ménagères selon les directives en vigueur dans chacun de ces pays. Les produits portant ce symbole ne doivent pas être mis au rebut avec les ordures ménagères.
- IT** Questo simbolo indica che nei paesi della Comunità europea questo prodotto deve essere smaltito separatamente dai normali rifiuti domestici, secondo la legislazione in vigore in ciascun paese. I prodotti che riportano questo simbolo non devono essere smaltiti insieme ai rifiuti domestici.
Ai sensi dell'art. 13 del D.Lgs. 25 luglio 2005 n. 151.
- ES** Este símbolo indica que en los países de la Unión Europea este producto debe recogerse aparte de los residuos domésticos, tal como está regulado en cada zona. Los productos con este símbolo no se deben depositar con los residuos domésticos.
- PT** Este símbolo indica que nos países da UE, a recolha deste produto deverá ser feita separadamente do lixo doméstico, de acordo com os regulamentos de cada região. Os produtos que apresentem este símbolo não deverão ser eliminados juntamente com o lixo doméstico.
- NL** Dit symbool geeft aan dat in landen van de EU dit product gescheiden van huishoudelijk afval moet worden aangeboden, zoals bepaald per gemeente of regio. Producten die van dit symbool zijn voorzien, mogen niet samen met huishoudelijk afval worden verwijderd.
- DK** Dette symbol angiver, at i EU-lande skal dette produkt opsamles adskilt fra husholdningsaffald, som defineret i hver enkelt region. Produkter med dette symbol må ikke smides ud sammen med husholdningsaffald.
- NO** Dette symbolet indikerer at produktet må behandles som spesialavfall i EU-land, iht. til retningslinjer for den enkelte regionen, og ikke kastes sammen med vanlig husholdningsavfall. Produkter som er merket med dette symbolet, må ikke kastes sammen med vanlig husholdningsavfall.
- SE** Symbolen anger att i EU-länder måste den här produkten kasseras separat från hushållsavfall, i enlighet med varje regions bestämmelser. Produkter med den här symbolen får inte kasseras tillsammans med hushållsavfall.
- FI** Tämä merkintä ilmaisee, että tuote on EU-maissa kerättävä erillään kotitalousjätteistä kunkin alueen voimassa olevien määräysten mukaisesti. Tällä merkinnällä varustettuja tuotteita ei saa hävittää kotitalousjätteiden mukana.
- HU** Ez a szimbólum azt jelenti, hogy az Európai Unióban ezt a terméket a háztartási hulladékért elkülönítve, az adott régióban érvényes szabályozás szerint kell gyűjteni. Az ezzel a szimbólummal ellátott termékeket nem szabad a háztartási hulladék közé dobni.
- PL** Symbol oznacza, że zgodnie z regulacjami w odpowiednim regionie, w krajach UE produktu nie należy wyrzucać z odpadami domowymi. Produktów opatrzonych tym symbolem nie można utylizować razem z odpadami domowymi.
- CZ** Tento symbol udává, že v zemích EU musí být tento výrobek sbírán odděleně od domácího odpadu, jak je určeno pro každý region. Výrobky nesoucí tento symbol se nesmí vyhazovat spolu s domácím odpadem.
- SK** Tento symbol vyjadruje, že v krajinách EÚ sa musí zber tohto produktu vykonávať oddelene od domového odpadu, podľa nariadení platných v konkrétnej krajine. Produkty s týmto symbolom sa nesmú vyhazovať spolu s domovým odpadom.
- EE** See sümbol näitab, et EL-i maades tuleb see toode olemprügist eraldi koguda, nii nagu on igas piirkonnas määratletud. Selle sümboliga märgitud tooteid ei tohi ära visata koos olmeprügiga.
- LT** Šis simbolis rodo, kad ES šalyse šis produktas turi būti surenkamas atskirai nuo buitinių atliekų, kaip nustatyta kiekviename regione. Šiuo simboliu paženklinoti produktai neturi būti išmetami kartu su buitiniėmis atliekomis.
- LV** Šis simbols norāda, ka ES valstīs šo produktu jāievāc atsevišķi no mājsaimniecības atkritumiem, kā noteikts katrā reģionā. Produktus ar šo simbolu nedrīkst izmest kopā ar mājsaimniecības atkritumiem.
- SI** Ta simbol označuje, da je treba proizvod v državah EU zbirati ločeno od gospodinskih odpadkov, tako kot je določeno v vsaki regiji. Proizvoda s tem znakom ni dovoljeno odlagati skupaj z gospodinskimi odpadki.
- GR** Το σύμβολο αυτό υποδηλώνει ότι στις χώρες της Ε.Ε. το συγκεκριμένο προϊόν πρέπει να συλλέγεται χωριστά από τα υπόλοιπα οικιακά απορρίμματα, σύμφωνα με όσα προβλέπονται σε κάθε περιοχή. Τα προϊόντα που φέρουν το συγκεκριμένο σύμβολο δεν πρέπει να απορρίπτονται μαζί με τα οικιακά απορρίμματα.



This product complies with the requirements of European Directive 89/336/EEC.

For EU Countries

For the USA

FEDERAL COMMUNICATIONS COMMISSION RADIO FREQUENCY INTERFERENCE STATEMENT

This equipment has been tested and found to comply with the limits for a Class B digital device, pursuant to Part 15 of the FCC Rules. These limits are designed to provide reasonable protection against harmful interference in a residential installation. This equipment generates, uses, and can radiate radio frequency energy and, if not installed and used in accordance with the instructions, may cause harmful interference to radio communications. However, there is no guarantee that interference will not occur in a particular installation. If this equipment does cause harmful interference to radio or television reception, which can be determined by turning the equipment off and on, the user is encouraged to try to correct the interference by one or more of the following measures:

- Reorient or relocate the receiving antenna.
- Increase the separation between the equipment and receiver.
- Connect the equipment into an outlet on a circuit different from that to which the receiver is connected.
- Consult the dealer or an experienced radio/TV technician for help.

This device complies with Part 15 of the FCC Rules. Operation is subject to the following two conditions:

- (1) This device may not cause harmful interference, and
- (2) This device must accept any interference received, including interference that may cause undesired operation.

Unauthorized changes or modification to this system can void the users authority to operate this equipment.
This equipment requires shielded interface cables in order to meet FCC class B Limit.

For Canada

NOTICE

This Class B digital apparatus meets all requirements of the Canadian Interference-Causing Equipment Regulations.

AVIS

Cet appareil numérique de la classe B respecte toutes les exigences du Règlement sur le matériel brouilleur du Canada.



Free Manuals Download Website

<http://myh66.com>

<http://usermanuals.us>

<http://www.somanuals.com>

<http://www.4manuals.cc>

<http://www.manual-lib.com>

<http://www.404manual.com>

<http://www.luxmanual.com>

<http://aubethermostatmanual.com>

Golf course search by state

<http://golfingnear.com>

Email search by domain

<http://emailbydomain.com>

Auto manuals search

<http://auto.somanuals.com>

TV manuals search

<http://tv.somanuals.com>