







# USING THE UNIT SAFELY

## INSTRUCTIONS FOR THE PREVENTION OF FIRE, ELECTRIC SHOCK, OR INJURY TO PERSONS





about WARNING and CAUTION Notices

 <b>WARNING</b>	Used for instructions intended to alert the user to the risk of death or severe injury should the unit be used improperly.
 <b>CAUTION</b>	Used for instructions intended to alert the user to the risk of injury or material damage should the unit be used improperly. * Material damage refers to damage or other adverse effects caused with respect to the home and all its furnishings, as well to domestic animals or pets.



	The $\Delta$ symbol alerts the user to important instructions or warnings. The specific meaning of the symbol is determined by the design contained within the triangle. In the case of the symbol at left, it is used for general cautions, warnings, or alerts to danger.
	The $\otimes$ symbol alerts the user to items that must never be carried out (are forbidden). The specific thing that must not be done is indicated by the design contained within the circle. In the case of the symbol at left, it means that the unit must never be disassembled.
	The $\bullet$ symbol alerts the user to things that must be carried out. The specific thing that must be done is indicated by the design contained within the circle. In the case of the symbol at left, it means that the power-cord plug must be unplugged from the outlet.

### ALWAYS OBSERVE THE FOLLOWING

#### **WARNING**

- Before using this unit, make sure to read the instructions below, and the Owner's Manual. 
- Do not open (or modify in any way) the unit or its AC adaptor. 
- Do not attempt to repair the unit, or replace parts within it (except when this manual provides specific instructions directing you to do so). Refer all servicing to your retailer, the nearest Roland Service Center, or an authorized Roland distributor, as listed on the "Information" page. 
- Never use or store the unit in places that are:
  - Subject to temperature extremes (e.g., direct sunlight in an enclosed vehicle, near a heating duct, on top of heat-generating equipment); or are 
  - Damp (e.g., baths, washrooms, on wet floors); or are 
  - Humid; or are
  - Exposed to rain; or are
  - Dusty; or are
  - Subject to high levels of vibration.

#### **WARNING**

- Make sure you always have the unit placed so it is level and sure to remain stable. Never place it on stands that could wobble, or on inclined surfaces. 
- Use only the specified AC adaptor (PSA series), and make sure the line voltage at the installation matches the input voltage specified on the AC adaptor's body. Other AC adaptors may use a different polarity, or be designed for a different voltage, so their use could result in damage, malfunction, or electric shock. 
- Do not excessively twist or bend the power cord, nor place heavy objects on it. Doing so can damage the cord, producing severed elements and short circuits. Damaged cords are fire and shock hazards! 

 **WARNING**

- This unit, either alone or in combination with an amplifier and headphones or speakers, may be capable of producing sound levels that could cause permanent hearing loss. Do not operate for a long period of time at a high volume level, or at a level that is uncomfortable. If you experience any hearing loss or ringing in the ears, you should immediately stop using the unit, and consult an audiologist.



- Do not allow any objects (e.g., flammable material, coins, pins); or liquids of any kind (water, soft drinks, etc.) to penetrate the unit.



- Immediately turn the power off, remove the AC adaptor from the outlet, and request servicing by your retailer, the nearest Roland Service Center, or an authorized Roland distributor, as listed on the “Information” page when:



- The AC adaptor or the power-supply cord has been damaged; or
- Objects have fallen into, or liquid has been spilled onto the unit; or
- The unit has been exposed to rain (or otherwise has become wet); or
- The unit does not appear to operate normally or exhibits a marked change in performance.

- In households with small children, an adult should provide supervision until the child is capable of following all the rules essential for the safe operation of the unit.



- Protect the unit from strong impact. (Do not drop it!)



 **WARNING**

- Do not force the unit’s power-supply cord to share an outlet with an unreasonable number of other devices. Be especially careful when using extension cords—the total power used by all devices you have connected to the extension cord’s outlet must never exceed the power rating (watts/ amperes) for the extension cord. Excessive loads can cause the insulation on the cord to heat up and eventually melt through.



- Before using the unit in a foreign country, consult with your retailer, the nearest Roland Service Center, or an authorized Roland distributor, as listed on the “Information” page.



- Batteries must never be recharged, heated, taken apart, or thrown into fire or water.



 **CAUTION**

- The unit and the AC adaptor should be located so their location or position does not interfere with their proper ventilation. 

---

- Always grasp only the plug or the body of the AC adaptor when plugging into, or unplugging from, an outlet or this unit. 

---

- Whenever the unit is to remain unused for an extended period of time, disconnect the AC adaptor. 

---

- Try to prevent cords and cables from becoming entangled. Also, all cords and cables should be placed so they are out of the reach of children. 

---

- Never climb on top of, nor place heavy objects on the unit. 

---

- Never handle the AC adaptor body, or its plugs, with wet hands when plugging into, or unplugging from, an outlet or this unit. 

---

- Before moving the unit, disconnect the AC adaptor and all cords coming from external devices. 



---

- Before cleaning the unit, turn off the power and unplug the AC adaptor from the outlet (p. 14). 

---

- Whenever you suspect the possibility of lightning in your area, disconnect the AC adaptor from the outlet. 

 **CAUTION**

- If used improperly, batteries may explode or leak and cause damage or injury. In the interest of safety, please read and observe the following precautions (p. 16).   
  

- Carefully follow the installation instructions for batteries, and make sure you observe the correct polarity.
- Avoid using new batteries together with used ones. In addition, avoid mixing different types of batteries.
- Remove the batteries whenever the unit is to remain unused for an extended period of time.
- If a battery has leaked, use a soft piece of cloth or paper towel to wipe all remnants of the discharge from the battery compartment. Then install new batteries. To avoid inflammation of the skin, make sure that none of the battery discharge gets onto your hands or skin. Exercise the utmost caution so that none of the discharge gets near your eyes. Immediately rinse the affected area with running water if any of the discharge has entered the eyes.
- Never keep batteries together with metallic objects such as ballpoint pens, necklaces, hairpins, etc.

---

- Used batteries must be disposed of in compliance with whatever regulations for their safe disposal that may be observed in the region in which you live. 

# Main Features

## Plays Bass Parts

The DR-670 plays bass parts that are synchronized with the drum parts. This lets you enjoy backing performances with rhythm patterns using various combinations of drum and bass sounds.

## High-Quality Sound Generator

The DR-670 features high-quality internal instrument sounds, including 256 drum part sounds and sixteen bass part sounds.

This lets you perform in various styles such as Rock, Jazz and Latin.

## Large Screen—Current Pattern Indicated

The large-size custom liquid crystal display makes it extremely easy to read the performance and editing data that's presented on screen. In addition, you can confirm which performance pattern is currently being played just by checking for the dot.

## Dynamic-Response Key Pads

The DR-670 is equipped with dynamics-sensitive key pads, so you can readily obtain changes in volume in response to the force with which you tap them. Use this feature to achieve realistic volume changes when playing rolls.

## Synchronized Performance with Digital Recorders and Sequencers

Using MIDI allows you to synchronize performances with the BR-8 and other digital recorders and with MIDI sequencers.

## Fill-In Function

Each rhythm pattern features a corresponding fill pattern that is perfectly matched to it; these fills can be inserted in the pattern at the press of a single button.

## Foot Switch Control

You can connect two foot switches and use them for foot control of various other operations, such as for starting and stopping performances, adding fills, and more.

## Setting the Tempo with Tap Tempo Function

You can set tempos just by tapping the button at the desired timing.

## DPP Function (Direct Pattern Play)

You can directly select a rhythm pattern number and initiate its playback simply by tapping a key pad.

## TEMPO Dial Situated on Top Panel

The placement of the TEMPO dial right on the DR-670's top panel allows you to make changes to the tempo directly, anytime you want.

## Play Rhythm Patterns and Songs

In addition to 200 different preset rhythm patterns, you can also create another 200 original rhythm patterns of your own.

You can also compose up to 100 songs by connecting these rhythm patterns together.

Enjoy connecting and repeating your songs using the Song Chain and Song Repeat functions.

## Compact Body

The DR-670 is lightweight, compact, and very portable. And since the unit can be powered with batteries, you can use it just about anywhere.

## Easy Operation

You can hold down the [SHIFT] button in combination with other buttons to easily call up commonly used parameters and editing functions. Making changes in settings is also simple with the TEMPO/VALUE dial.

# Contents

<b>Main Features .....</b>	<b>5</b>
<b>IMPORTANT NOTES.....</b>	<b>10</b>
<b>Panel Descriptions .....</b>	<b>12</b>
Front Panel.....	12
Rear Panel .....	14
<b>Quick Start .....</b>	<b>16</b>
Install batteries .....	16
Making Connections.....	17
Turning On the Power .....	18
Turning Off the Power.....	18
Reset to Default Factory Settings (Factory Reset) .....	19
Listen to the Demo Song.....	20
Using the Key Pads to Play Sounds .....	21
Specialized Performance Techniques (Roll).....	22
Adding Character to Performances (Flam).....	23
Playing Different Sounds (Switching Pad Drum Banks).....	24
Playing Bass Sounds.....	25
Performing Rhythm Patterns .....	26
Selecting and Performing Patterns.....	26
Selecting and Performing Patterns (DPP Function) .....	28
Adjusting the Tempo.....	30
Changing the tempo using the Tap Tempo function .....	31
Inserting Fill-Ins.....	32
Using the Foot Switches.....	34
Playing a Pattern Using a Different Sound (Switching Drum Kits).....	36
<b>Chapter 1 Before Composing Rhythm Patterns and Songs.....</b>	<b>38</b>
How the Work Progresses.....	38
About Operational Modes.....	40
Drum Kits and Pad Performances.....	42
Drum Kits.....	42
Pad Performances .....	43
How to View the Scale/Pattern Display .....	44
Pattern Display.....	44
Switching the Instrument .....	44
Scale Display .....	45
Changing the Scale .....	45
Using [SHIFT].....	46
<b>Chapter 2 Playing Patterns (Pattern Play Mode) .....</b>	<b>47</b>
Playing Sounds with the Key Pads .....	47
Selecting a Drum Kit .....	47
Selecting the Drum Bank .....	47
Playing the Bass Sounds.....	47
Changing the Bass Pitch (Fret Shift) .....	48
Playing with Special Performance Techniques .....	48
Playing Rolls.....	48
Playing Flams.....	48
Playing Patterns.....	49

Playing Patterns with the DPP Function.....	49
Adjusting the Tempo.....	50
Adjusting the Tempo with the Tap Tempo Function.....	50
Inserting Fill-Ins.....	50
Adding Fill-Ins While the Pattern is Playing.....	50
Playing a Fill Pattern at the Beginning of the Following Pattern .....	51
Starting Performances from the Fill Pattern .....	51
<b>Chapter 3 Recording and Editing Patterns (Pattern Edit Mode) .....</b>	<b>52</b>
Before You Start Recording.....	52
<1> Select an Unrecorded Pattern.....	53
<2> Select the Beat .....	53
<3> Select the Measures.....	54
<4> Select the Drum Kit.....	54
<5> Set the Quantization .....	55
<6> Record the Basic Pattern .....	55
(6-1A) Do Realtime Recording.....	55
(6-1B) Do Step Recording .....	57
(6-2) Confirm the Recorded Sounds.....	59
<7> Record the Fill Pattern.....	59
(7-1) Select the Fill Pattern.....	59
(7-2A) Do Realtime Recording.....	59
(7-2B) Do Step Recording .....	59
(7-3) Confirm the Fill-In .....	59
Erasing Patterns (Pattern Clear) .....	60
Copying Patterns .....	61
Replacing Drum Kits.....	62
Changing the Key of the Bass Part (Key Transpose).....	62
<b>Chapter 4 Recording and Editing Songs (Song Edit Mode).....</b>	<b>63</b>
Before You Start Recording.....	63
<1> Select an Unrecorded Song.....	64
<2> Select the Tempo (Initial Tempo).....	64
<3A> Do Realtime Recording.....	65
Using the DPP Function in Realtime Recording.....	66
Switching Recorded Patterns.....	66
Starting Realtime Recording Within a Song.....	67
Adding Patterns at the End of a Song.....	67
<3B> Do Step Recording.....	68
Switching Recorded Patterns.....	68
Adding Patterns at the End of a Song.....	68
Adding Patterns In the Song (Insert) .....	69
Deleting Patterns (Delete).....	69
Removing Unneeded Song (Song Clear).....	70
Copying Song.....	70
Connecting Multiple Songs Into One Song (Song Chain).....	71
<b>Chapter 5 Performing Songs (Song Play Mode).....</b>	<b>72</b>
Performing Songs .....	72
Starting a Song From a Point Other Than the Beginning .....	73
Repeating Performances of Songs (Song Repeat) .....	73
Performing Multiple Songs In One Sequence (Song Chain) .....	74

---

Checking the Song Chain Settings .....	74
Creating Performances Combining the Repeat and Chain Functions .....	74
Checking a Song's Initial Tempo .....	74
<b>Chapter 6 Assigning Patterns to the Key Pads (DPP Assign Mode) ..</b>	<b>75</b>
<b>Chapter 7 Customizing Your Setup (Utility Mode) .....</b>	<b>76</b>
Procedure .....	76
Switching the Sounding/Muting of Drum Parts and Bass Parts (Output Part).....	76
Assigning Functions to the Foot Switches .....	77
Changing the Roll Settings (Roll Type) .....	77
Changing the Flam Settings .....	78
Adjusting the Key Pad Sensitivity (Pad Sens) .....	78
Changing the Metronome Settings.....	78
Tuning the Bass Part.....	78
<b>Chapter 8 Creating Your Own Favorite Drum Kits (Drum Kit Edit Mode) ...</b>	<b>79</b>
Before Changing the Settings (Editing) .....	79
Select the Drum Kit to Edit.....	79
Editing Procedure.....	80
Editing the Drum Parts.....	80
Selecting the Sounds Assigned to the Key Pads (Instrument) .....	80
Setting the Volume (Level).....	80
Setting the Pitch (Pitch).....	80
Lengthening and Shortening the Reverberation (Decay) .....	81
Obtaining Tonal Changes Relative to Strike Position (Nuance) .....	81
Setting the Position of the Sound (Pan) .....	81
Determining Whether Or Not Sounds Overlap (Assign Type) .....	82
Editing the Bass Part.....	83
Selecting the Tone (Bass Tone).....	83
Setting the Volume (Level).....	83
Adjusting the Envelope (Attack, Decay, Release).....	83
Positioning the Sound (Pan).....	84
Copying Drum Kits .....	84
<b>Chapter 9</b>	



---

<b>Error Message List .....</b>	<b>92</b>
<b>Troubleshooting .....</b>	<b>94</b>
<b>Operation List .....</b>	<b>95</b>
<b>Parameter List.....</b>	<b>97</b>
<b>Instrument/Bass Tone List .....</b>	<b>99</b>
<b>Preset Drum Kit List .....</b>	<b>102</b>
<b>Preset Pattern List.....</b>	<b>110</b>
<b>MIDI Implementation Chart .....</b>	<b>112</b>
<b>Specifications .....</b>	<b>114</b>
<b>Index .....</b>	<b>115</b>

# IMPORTANT NOTES

In addition to the items listed under “USING THE UNIT SAFELY” on page 2–4, please read and observe the following:

## Power Supply: Use of Batteries

- Do not use this unit on the same power circuit with any device that will generate line noise (such as an electric motor or variable lighting system).
- The AC adaptor will begin to generate heat after long hours of consecutive use. This is normal, and is not a cause for concern.
- The use of an AC adaptor is recommended as the unit’s power consumption is relatively high. Should you prefer to use batteries, please use the alkaline type.
- When installing or replacing batteries, always turn off the power on this unit and disconnect any other devices you may have connected. This way, you can prevent malfunction and/or damage to speakers or other devices.
- Batteries are supplied with the unit. The life of these batteries may be limited, however, since their primary purpose was to enable testing.
- Before connecting this unit to other devices, turn off the power to all units. This will help prevent malfunctions and/or damage to speakers or other devices.

## Placement

- Using the unit near power amplifiers (or other equipment containing large power transformers) may induce hum. To alleviate the problem, change the orientation of this unit; or move it farther away from the source of interference.
- This device may interfere with radio and television reception. Do not use this device in the vicinity of such receivers.
- Do not expose the unit to direct sunlight, place it near devices that radiate heat, leave it inside an enclosed vehicle, or otherwise subject it to temperature extremes. Excessive heat can deform or discolor the unit.
- To avoid possible breakdown, do not use the unit in a wet area, such as an area exposed to rain or other moisture.

## Maintenance

- For everyday cleaning wipe the unit with a soft, dry cloth or one that has been slightly dampened with water. To remove stubborn dirt, use a cloth impregnated with a mild, non-abrasive detergent. Afterwards, be sure to wipe the unit thoroughly with a soft, dry cloth.
- Never use benzene, thinners, alcohol or solvents of any kind, to avoid the possibility of discoloration and/or deformation.

## Repairs and Data

- Please be aware that all data contained in the unit's memory may be lost when the unit is sent for repairs. Important data should always be backed up in another MIDI device (e.g., a sequencer), or written down on paper (when possible). During repairs, due care is taken to avoid the loss of data. However, in certain cases (such as when circuitry related to memory itself is out of order), we regret that it may not be possible to restore the data, and Roland assumes no liability concerning such loss of data.

## Memory Backup

- This unit contains a battery which powers the unit's memory circuits while the main power is off. When this battery becomes weak, the message shown below will appear in the display. Once you see this message, have the battery replaced with a fresh one as soon as possible to avoid the loss of all data in memory. To have the battery replaced, consult with your retailer, the nearest Roland Service Center, or an authorized Roland distributor, as listed on the "Information" page.

**"BAK BATTERY LOW"**

## Additional Precautions

- Please be aware that the contents of memory can be irretrievably lost as a result of a malfunction, or the improper operation of the unit. To protect yourself against the risk of losing important data, we recommend that you periodically save a backup copy of important data you have stored in the unit's memory in another MIDI device (e.g., a sequencer).
- Unfortunately, it may be impossible to restore the contents of data that was stored in the unit's memory once it has been lost. Roland Corporation assumes no liability concerning such loss of data.
- Use a reasonable amount of care when using the unit's buttons, sliders, or other controls; and when using its jacks and connectors. Rough handling can lead to malfunctions.
- Never strike or apply strong pressure to the display.
- When connecting / disconnecting all cables, grasp the connector itself—never pull on the cable. This way you will avoid causing shorts, or damage to the cable's internal elements.
- To avoid disturbing your neighbors, try to keep the unit's volume at reasonable levels. You may prefer to use headphones, so you do not need to be concerned about those around you (especially when it is late at night).
- When you need to transport the unit, package it in the box (including padding) that it came in, if possible. Otherwise, you will need to use equivalent packaging materials.

# Panel Descriptions

## Front Panel

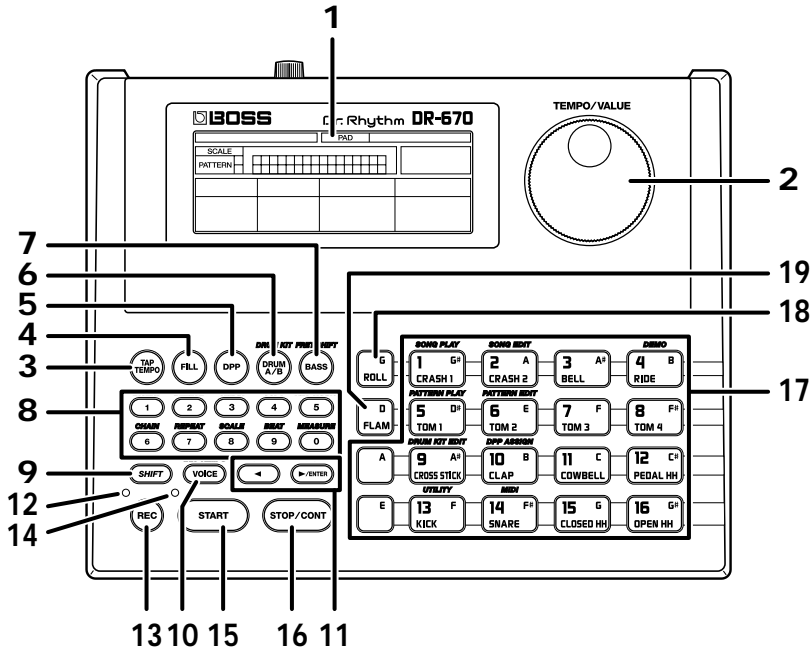

### 1 Display

### 2 TEMPO/VALUE Dial

Selects patterns and songs.

You can set tempos by rotating the dial while holding down the TAP TEMPO button. This is also used during editing to input settings values.

### 3 TAP TEMPO Button

This is tapped in time to input the tempo.

### 4 FILL Button

You can use this to add fill-ins.

### 5 DPP (Direct Pattern Play) Button

Press when using the DPP function (p. 28).

### 6 DRUM A/B Button

Pressing this button allows you to change the drum sound to be played with the key pad. By holding down SHIFT while pressing this button you can switch the drum kit currently being played.

---

## 7 BASS Button

Pressing this button allows you to play bass sounds with the key pad.

By holding down SHIFT while pressing this button you can change the pitch of the bass sound with the key pad.

## 8 Numeric Keys

Used for entering song numbers and pattern numbers.

By holding down SHIFT while pressing the numeric keys, you can access a variety of editing functions and make changes in parameter settings.

## 9 SHIFT Button

Used in conjunction with other buttons.

## 10 VOICE Button

By holding down this button and pressing the key pads, you can confirm tone names and switch tones for performance patterns indicated with the “●” symbol.

## 11 ◀ / ▶/ENTER Button

In Step Recording, this specifies the step number.

During editing, this switches parameters.

## 12 REC (Recording) Indicator

Illuminated while Realtime Recording is in progress; blinks on and off during Step Recording.

## 13 REC (Recording) Button

Press this button when using Realtime Recording.

## 14 Tempo Indicator

Blinks in sync with the tempo of the song.

## 15 START Button

Starts playback.

## 16 STOP/CONT (Continue) Button

Stops playback.

You can also press this to resume playback of the performance from the point where it was previously stopped.

## 17 Key Pad

Plays the drum and bass sounds.

When the DPP function (p. 28) is in use, you can select patterns with the key pad.

## 18 ROLL Pad

When a drum sound is playing, you can perform rolls by holding down the ROLL pad and then pressing another of the pads.

When a bass sound is playing, this is used as an ordinary pad.

## 19 FLAM Pad

When a drum sound is playing, you can perform flams by holding down the FLAM pad and then pressing another of the pads.

When a bass sound is playing, this is used as an ordinary pad.

## Rear Panel

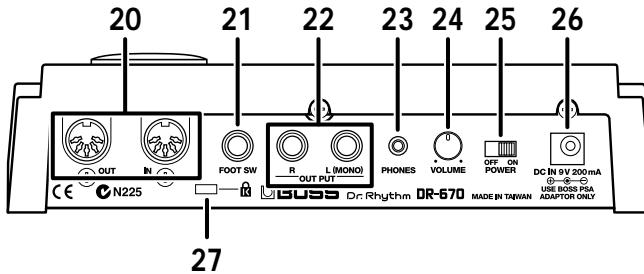

### 20 MIDI Connector IN/OUT

External MIDI devices can be connected to these connectors.

### 21 FOOT SW (Switch) Jack

By connecting a foot switch, you can obtain pedal control over the start and stop of performances, the addition of fills, or other actions.

### 22 OUTPUT Jack R/L (MONO)

Provides output of the audio signals. Connect to your amp, stereo system, or similar equipment.

For monaural output use the L (MONO) jack.

### 23 PHONES (Headphones) Jack

A set of headphones can be connected to this jack.

### 24 VOLUME Knob

Adjusts the volume from the OUTPUT jack and PHONES jack.

### 25 POWER Switch

Switches the power on and off.

### 26 AC Adaptor Jack

You can use a separately sold AC adapter (BOSS PSA series).

### 27 Security Slot (K)

<http://www.kensington.com/>

**Memo ...**

# Quick Start

## Install batteries

---

1

Make sure that the power is turned off.

2

Remove the battery cover on the unit's underside.

- \* When turning the unit upside-down, get a bunch of newspapers or magazines, and place them under the four corners or at both ends to prevent damage to the buttons and controls. Also, you should try to orient the unit so no buttons or controls get damaged.
- \* When turning the unit upside-down, handle with care to avoid dropping it, or allowing it to fall or tip over.

3

Insert six AA batteries in the battery case, taking care to ensure that the positive (+) and negative (-) terminals are not reversed.

- \* We recommend the use of alkaline batteries for extended battery life.
- \* Do not mix new batteries with partially used batteries, and do not mix batteries of differing types.

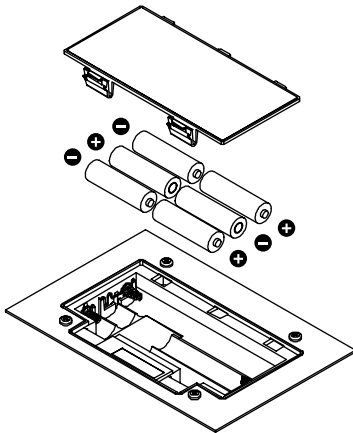

4

Close the battery cover.



When the battery power begins to run low, "DRY BATTERY LOW" appears in the display when the power is turned on. When this occurs, replace with new (six AA) batteries.



# Making Connections

The DR-670 is not equipped with an internal amp or speakers. To hear sound, either connect an amplifier and speakers or use stereo headphones.

Audio cables, MIDI cables, Stereo headphones, and foot switches are not included. You will need to purchase these items from your dealer.

1

**Before you begin making connections, confirm the following.**

- Is the volume level of the DR-670 or connected amp turned all the way down?
- Is the power to the DR-670 or connected amp turned off?

To prevent malfunction and/or damage to speakers or other devices, always turn down the volume, and turn off the power on all devices before making any connections with the DR-670.

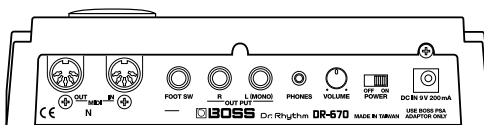

2

**Connect the amp and audio gear as shown in the diagram.**

If necessary, connect headphones and foot switches.

In order to take full advantage of the DR-670's sound we recommend that you play it in stereo.

When using the system in mono, connect to the OUTPUT L (MONO) jack.

- \* For instructions on connecting to the MIDI connectors, refer to p. 85.
- \* For instructions on connecting to the FOOT SW jack, refer to p. 34.

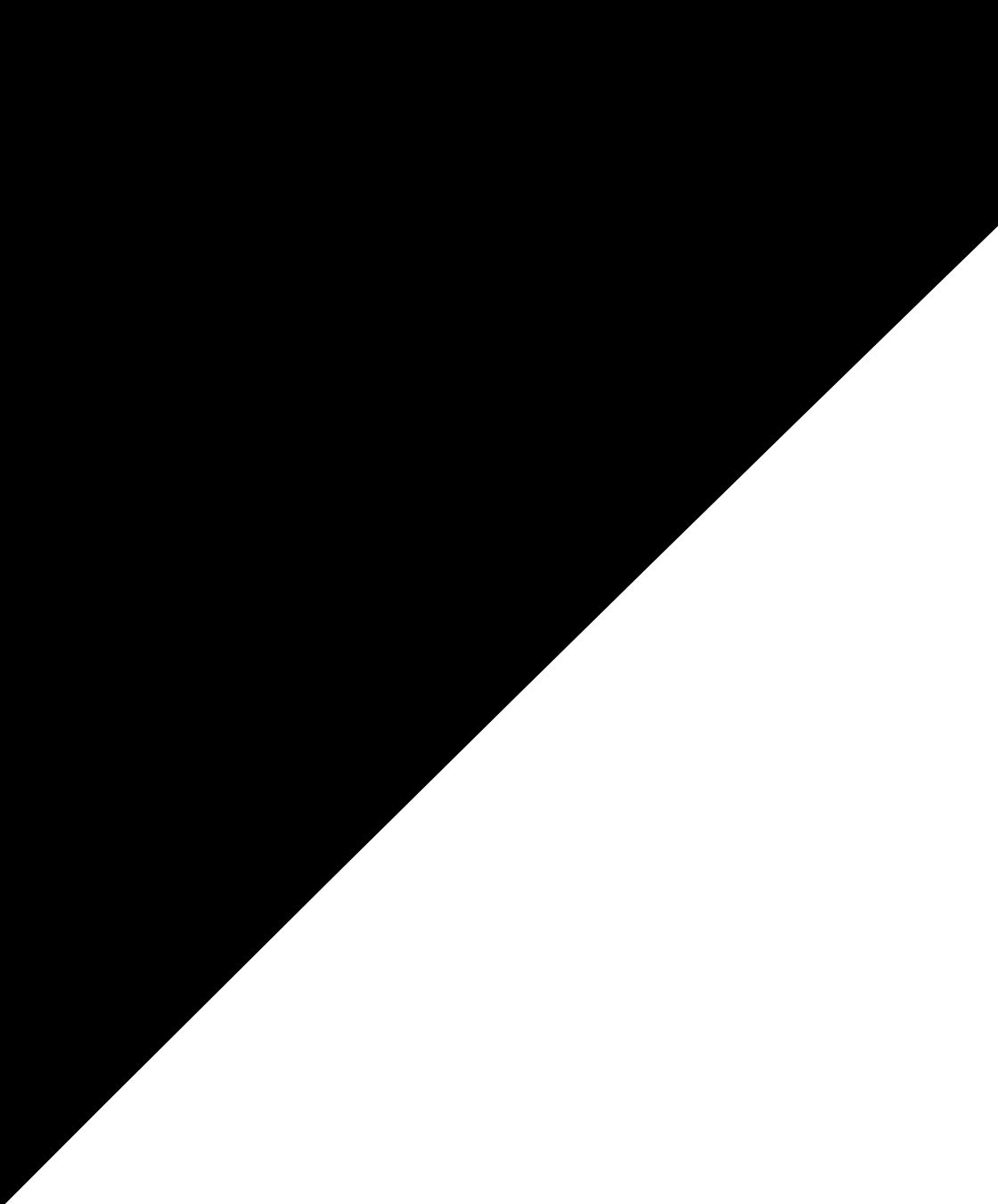

## Reset to Default Factory Settings (Factory Reset)

If changes are made to the settings after purchase of the DR-670, you may be unable to operate the unit as described in the Quick Start manual. If this occurs, then follow the instructions below to restore the unit to the original factory settings (Factory Reset), then proceed to read Quick Start.

When Factory Reset is carried out, all data stored in the DR-670 is returned to the settings in effect when the unit was shipped from the factory. If you already have important data saved in the DR-670, save the data to an external MIDI device (such as a sequencer) using the bulk dump procedure (p. 89), then carry out Factory Reset.

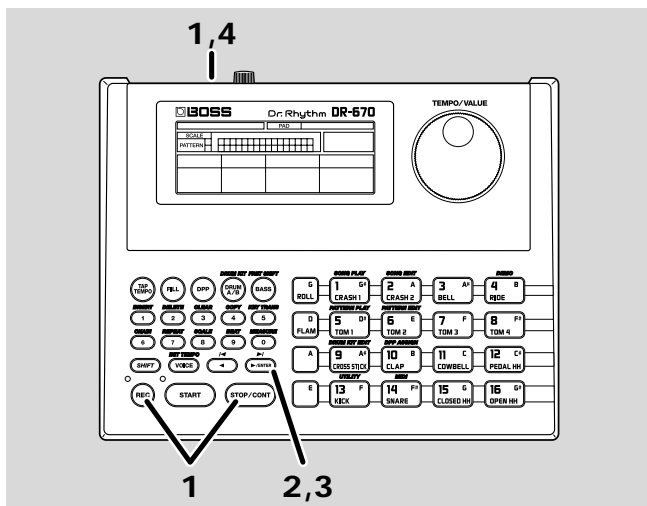

1

While holding down [REC] and [STOP/CONT], turn on the DR-670's power.

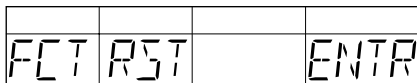

2

Press [▶/ENTER].

Along with an "OK," a message confirming that you want to proceed with Factory Reset is displayed.

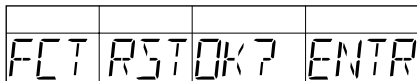

If you want to cancel Factory Reset at this point, just turn off the power.

3

Press [▶/ENTER] once more.

"DONE" appears in the display once the Factory Reset has been completed.

4

Turn off the power.

When the power is turned on again, the settings revert to those in effect when the unit was shipped from the factory.

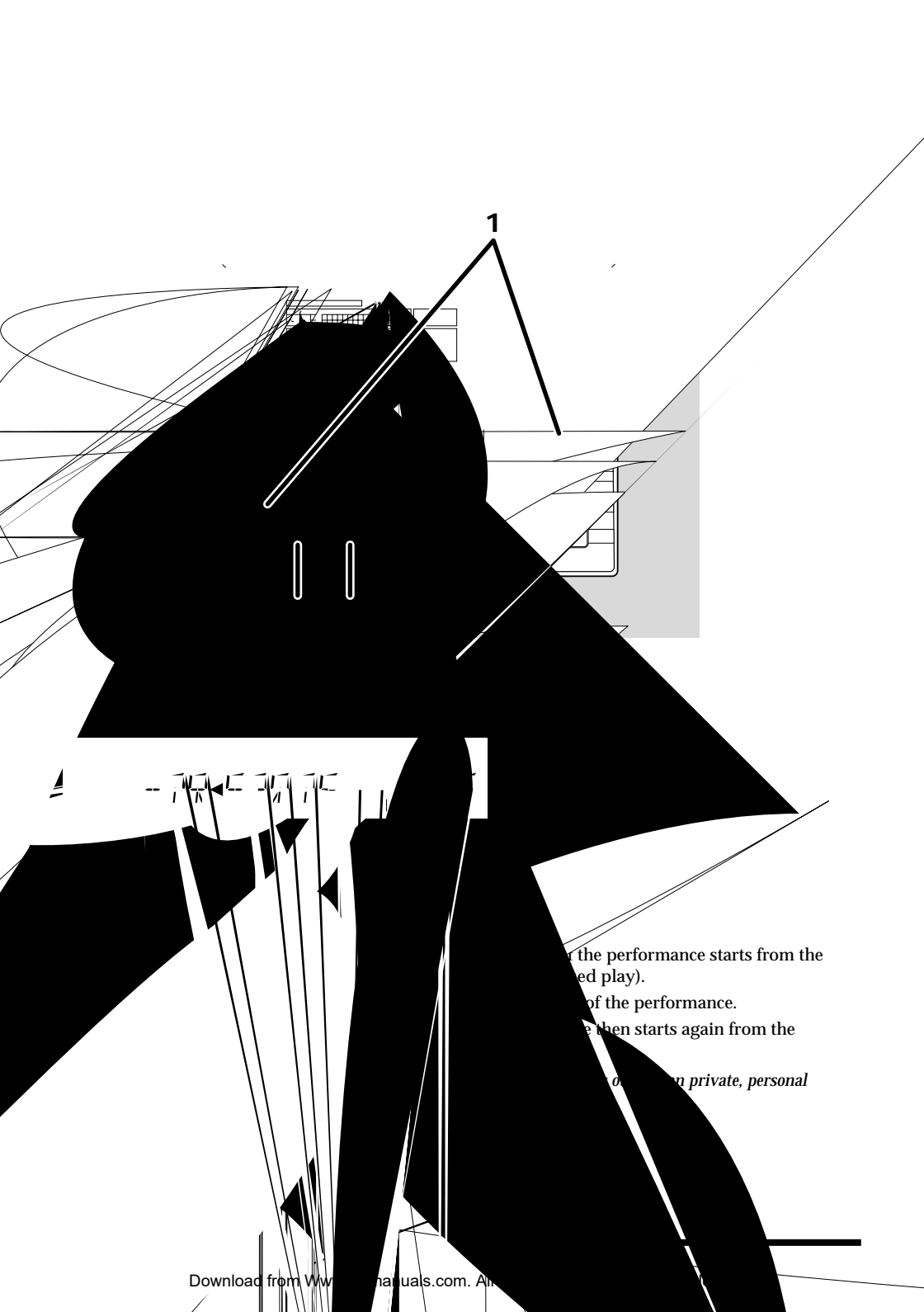

1

of the performance starts from the  
ed play).

of the performance.

then starts again from the

*on private, personal*

# Using the Key Pads to Play Sounds

Let's try playing the DR-670's internal rhythm instrument sounds by tapping the key pads.

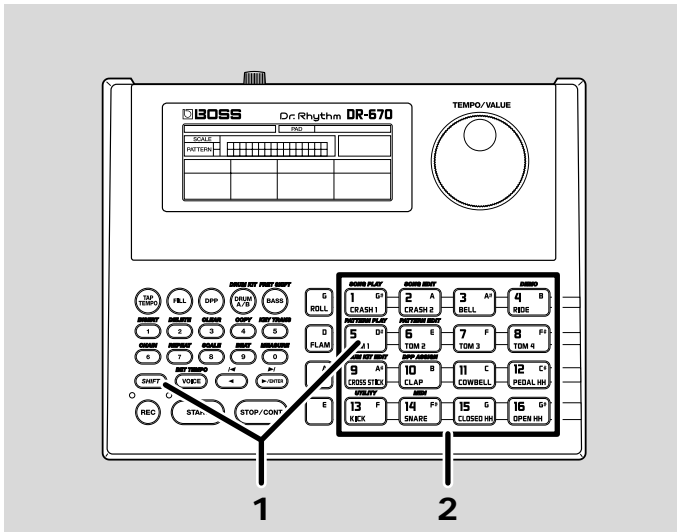

1

Hold down [SHIFT] and press Key Pad 5 (PATTERN PLAY).

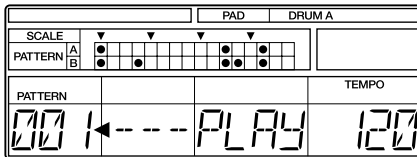

2

Tapping the key pads now plays the instruments assigned to each of the pads.

The key pads feature dynamic response, so the volume and sound change according to the force used to tap them.

## ■ Specialized Performance Techniques (Roll)

A roll is performed by playing the same sound consecutively at the same interval.

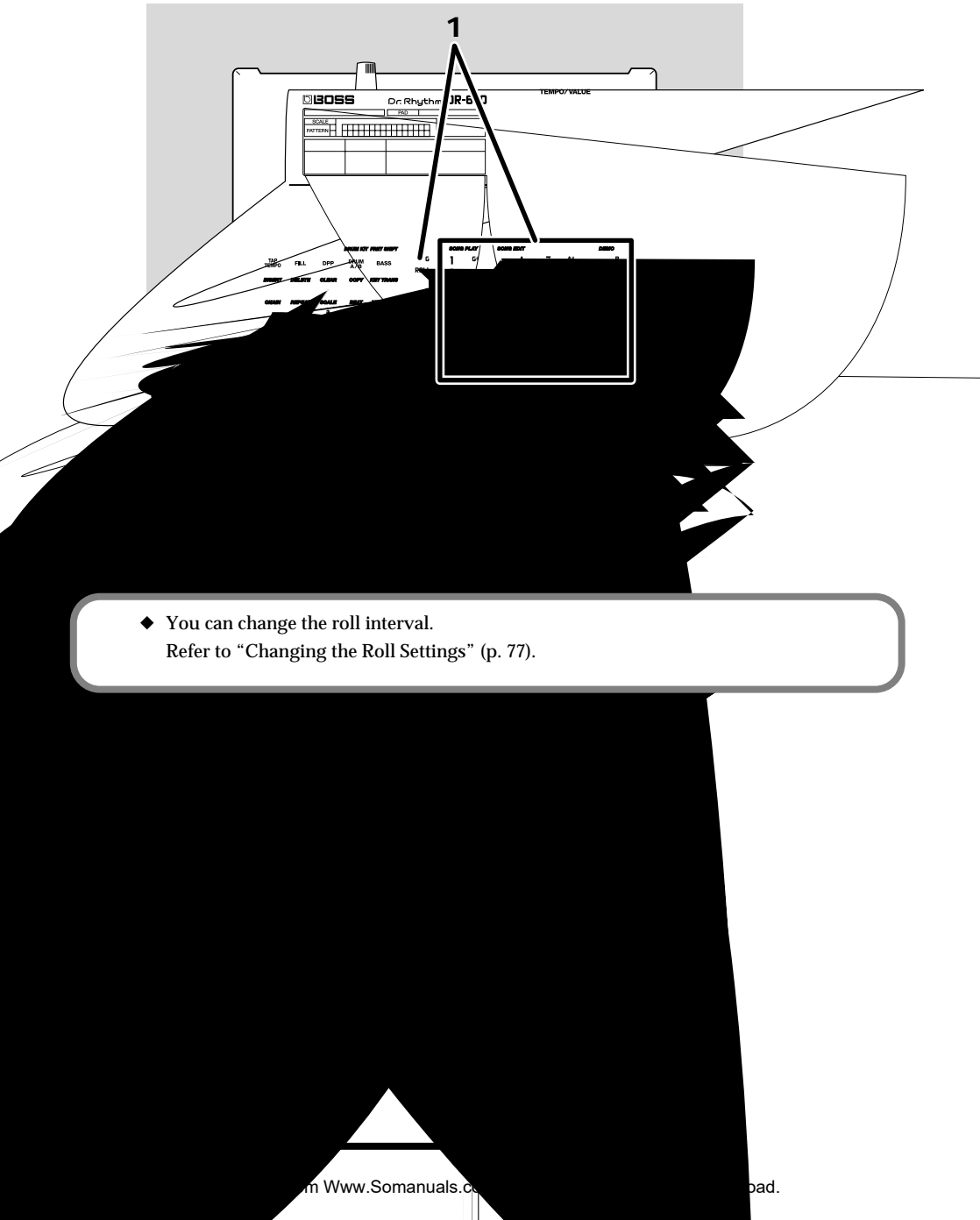

- ◆ You can change the roll interval.  
Refer to “Changing the Roll Settings” (p. 77).

## ■ Adding Character to Performances (Flam)



### What is a Flam?

A flam is produced by striking the snare or other drum simultaneously with the two sticks held in the hands, but with a slight difference in force used in playing each stick.

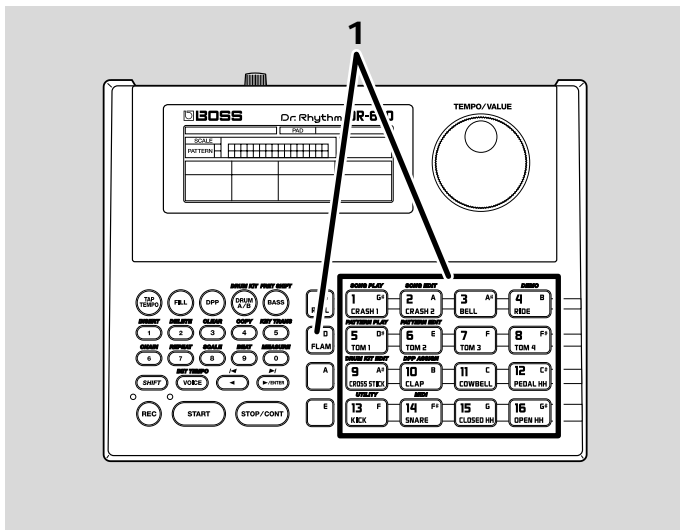

1

While pressing [FLAM], press a key pad.

- ◆ You can change the flam interval and force.  
Refer to “Changing the Flam Settings” (p. 78).

## ■ Playing Different Sounds (Switching Pad Drum Banks)

You can have different instruments sound, even when the same key pad is tapped, by switching the pad's drum bank.

Pad drum banks are collections of drum instrument sounds that are assigned as a single group to the sixteen key pads. There are two drum banks, Bank A and Bank B.

For more detailed information, refer to "Drum Kits and Pad Performances" (p. 42).

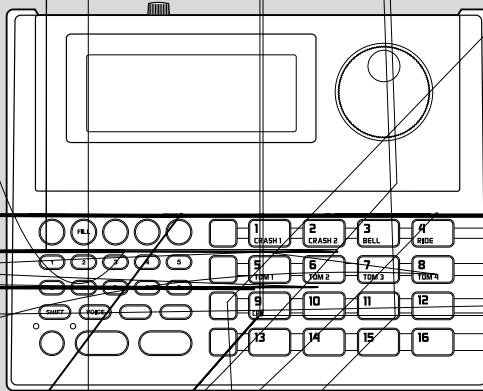

**1**

Press [DRUM A/B].

Each time the button is pressed, A and B alternately switch in the display, indicating the switch between Drum Banks A and B.

When the drum bank is switched, the sounds (the instruments) played by tapping the key pads are also switched.

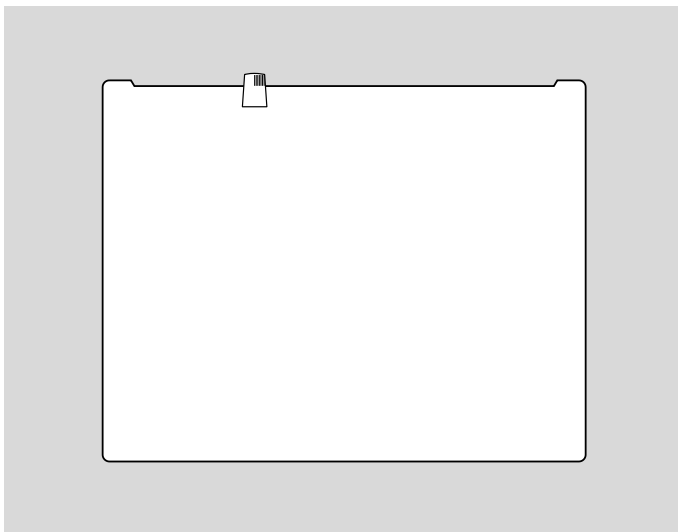

## ■ Playing Bass Sounds

**1**

You can play bass sounds with the key pads by pressing [BASS].

When a key pad is pressed, a bass sound plays at the pitch predetermined for that key pad. The bass sound stops playing when the key pad is released.

Pitches are assigned to the key pads in such a way as to simulate the frets of a bass guitar.

- \* *You cannot play two or more bass sounds simultaneously.*
- \* *Rolls and flams cannot be played when using the key pads to play bass sounds.*



1

Hold down [SHIFT] and press Key Pad 5 (PATTERN PLAY).

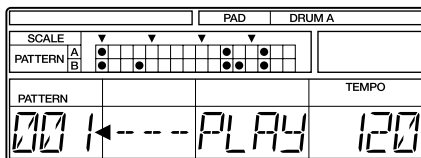

2

Rotate the TEMPO/VALUE dial to select the pattern number.

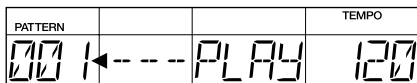

3

Press [START] to begin playback.

The Tempo indicator flashes once each beat.

Turning the TEMPO/VALUE dial while a performance is in progress sets up the pattern number for the next pattern to be played. When the current pattern finishes playing, the next preselected pattern then begins to play.

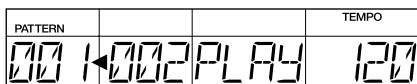

Next pattern to be performed

Pattern being played

4

When [STOP/CONT] is pressed, playback of the performance stops.

Press [START] to begin the performance of the most recently selected pattern.

- ◆ You can select patterns with the numeric keys.  
Refer to "Playing Patterns" (p. 49).

## ■ Selecting and Performing Patterns (DPP Function)

Ordinarily, tapping the key pads plays the instruments assigned to those pads, but with DPP (Direct Pattern Play), you can instead trigger the playback of the patterns that are assigned to the key pads.

With DPP, you can instantly perform desired patterns by tapping the pads.

Here, we suggest that you try using the DPP function to play the patterns that were assigned at the factory to the key pads, and see for yourself how useful this feature is.

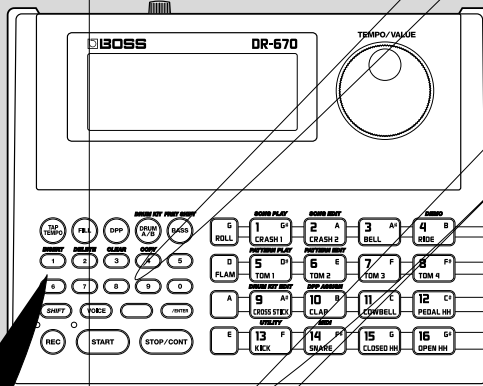

1

Hold down [SHIFT] and press Key Pad 5 (PATTERN PLAY).

2

Press [DPP] to turn the DPP function on.

3

**When you tap the key pad, performance of the assigned pattern begins.**

The Tempo indicator flashes once each beat.

The pattern number for the pattern currently being played appears in the display.

PATTERN		TEMPO	
001	←---	PLAY	120



When you tap a different key pad while the pattern is still being played, the performance of the current pattern stops, and the performance of the pattern assigned to the pad that was tapped then begins.

PATTERN		TEMPO	
001	←002	PLAY	120



Next pattern to be performed

Pattern being played

4

**When [STOP/CONT] is pressed, playback of the performance stops.**

When the key pad is pressed once more, playback of the pattern starts again.

Press [START] to begin the performance of the most recently selected pattern.

5

**To turn off the DPP function, press [DRUM A/B] or [BASS].**

- ◆ For instructions on assigning patterns to the key pads, refer to "Assigning Patterns to the Key Pads" (p. 75).



## ■ Changing the tempo using the Tap Tempo function

You can determine the tempo by the timing with which you press [TAP TEMPO].

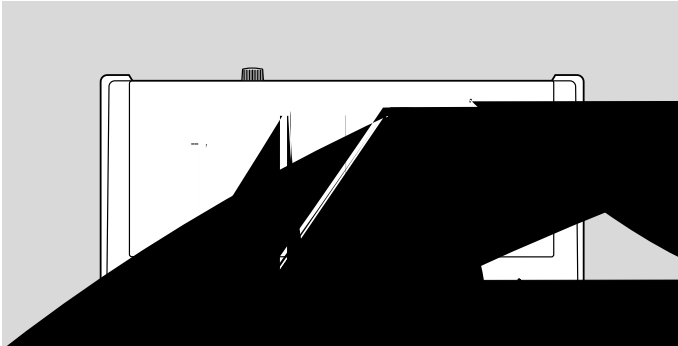

at the desired timing; the tempo  
tapping.

beats per minute.

## ■ Inserting Fill-Ins

With the DR-670, you can add fill-ins to a pattern being played at whatever timing you want.

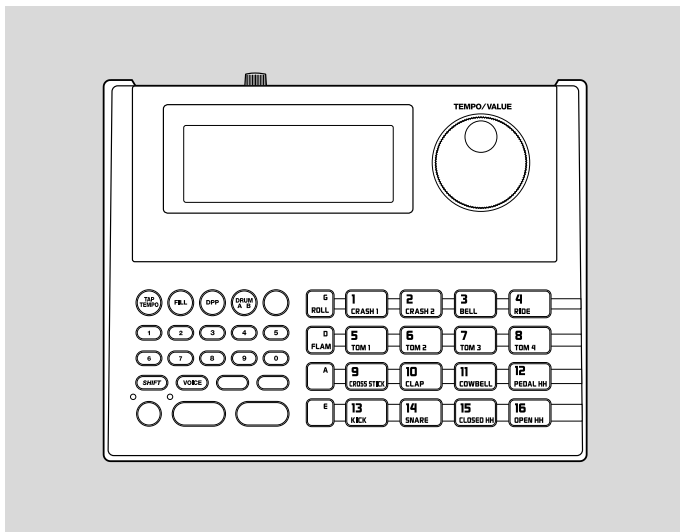



1

Hold down [SHIFT] and press Key Pad 5 (PATTERN PLAY).

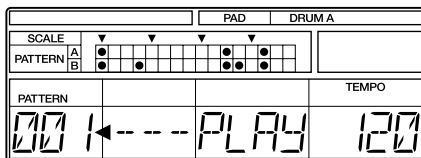

2

Press [START] to start the performance of the pattern.

3

Press [FILL] at the points where you want a fill-in added.  
The fill-in pattern is played instantly after [FILL] is pressed.

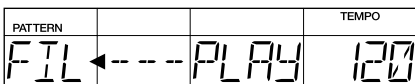

When the fill-in pattern is played to the end, the performance reverts to the original pattern.

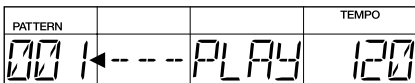

4

Press [STOP/CONT] to stop the performance.

- ◆ By pressing [FILL] during the final beat of a pattern, you can have the fill-in pattern play at the beginning of the next pattern.  
For more details, refer to “Inserting Fill-Ins” (p. 50).

## ■ Using the Foot Switches

You can use up to two foot switches (such as the optional FS-5U) to start and stop performance and insert fill-ins.

- \* *When only one foot switch is connected, the foot switch only starts and stops performances.*
- \* *A special PCS-31 cable (optional) is required when connecting two foot switches.*

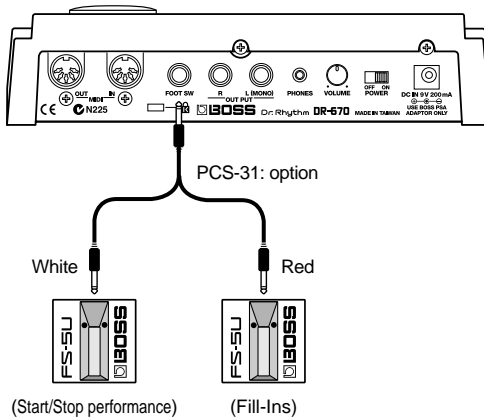

Foot switches connected with plugs that have a white stripe are used for starting and stopping performances; foot switches connected with plugs that have a red stripe are used for fill-ins.

To prevent malfunction and/or damage to speakers or other devices, always turn down the volume, and turn off the power on all devices before connecting a foot switch.

When connecting the foot switch (the optional FS-5U) to the FOOT SW jack, set the polarity switch as shown in the following figure.

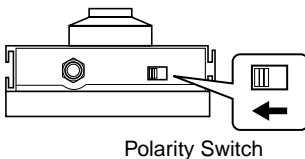

1

Hold down [SHIFT] and press Key Pad 5 (PATTERN PLAY).

2

When the foot switch connected with a plug that has a white stripe is pressed while the performance is stopped, the performance then starts.

PATTERN			TEMPO
001	←-----	PLAY	120

3

Pressing the foot switch connected with a plug that has a red stripe while the performance is in progress inserts a fill-in.

PATTERN			TEMPO
FIL	←-----	PLAY	120

When the fill-in pattern is played to the end, the performance reverts to the original pattern.

4

When the foot switch connected with a plug that has a white stripe is pressed while the performance is in progress, the performance then stops.

- ◆ You can assign functions other than starting/stopping the performance and inserting fill-ins can be assigned to the foot switches.  
Refer to “Assigning Functions to the Foot Switches” (p. 77).

## ■ Playing a Pattern Using a Different Sound (Switching Drum Kits)

Even when using the same pattern, you can change the mood (the performance and the way it is played) of the pattern by altering the instruments from which the pattern is made up. Here, try playing the same pattern with various different instrument, changing drum kits while the performance is in progress.

A drum kit is a collection of 32 drum instruments and one bass tone that is selected as a single set.

The DR-670 features 64 Preset Drum Kits along with 64 additional User Drum Kits whose settings you can change.

For more details, refer to “Drum Kits and Pad Performances” (p. 42).

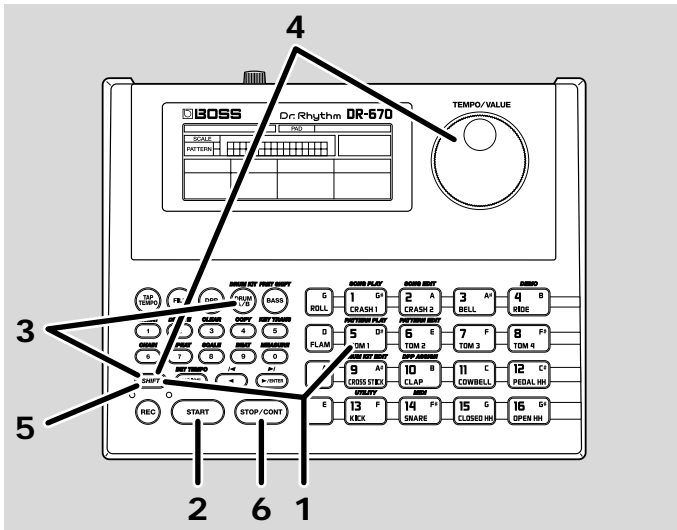

1

Hold down [SHIFT] and press Key Pad 5 (PATTERN PLAY).

2

Press [START] to start the performance of the pattern.

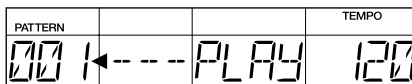

3

Hold down [SHIFT] and press [DRUM A/B] (DRUM KIT).

Keep [SHIFT] held down.

PATTERN		PARAMETER	VALUE
001	←---	KIT	9

4

While continuing to hold down [SHIFT], rotate the TEMPO/VALUE dial to select the drum kit number.

Try switching among the drum kits and listening to the different sounds.

PARAMETER	VALUE
KIT	001



Current drum kit

5

Release [SHIFT].

This completes the selection of the drum kit.

PATTERN			TEMPO
001	←---	PLAY	120

6

Press [STOP/CONT] to stop the performance.

- ◆ For more on the Preset Drum Kits, refer to “Preset Drum Kit List” (p. 102).
- ◆ When you want to make changes to the drum kit settings, refer to “Chapter 8 Creating Your Own Favorite Drum Kits” (p. 79).

## You Can Create Songs

With the DR-670, you can compose and perform songs by arranging sequences of rhythm pattern performances.

For more detailed information, refer to “Chapter 1 Before Composing Rhythm Patterns and Songs” (p. 38) and “Chapter 4 Recording and Editing Songs” (p. 63).

# Chapter 1 Before Composing Rhythm Patterns and Songs

This section provides a summary description of the DR-670.

## How the Work Progresses

The process of creating one song's worth of rhythm patterns can be divided broadly into two steps: creating the patterns, then composing the song.

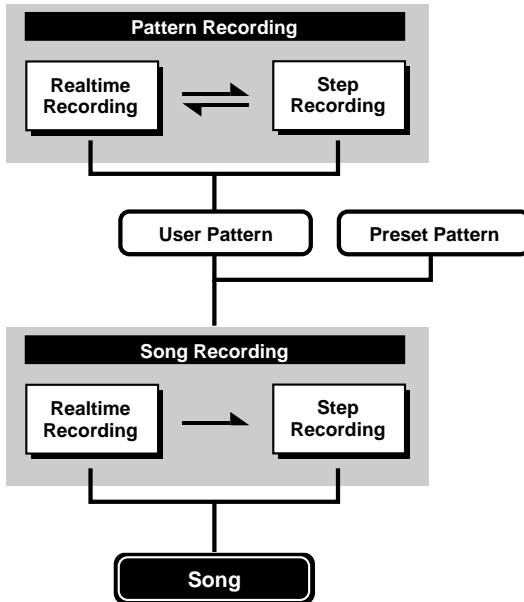

### Composing the Rhythm Patterns

Compose (record) the performance patterns that constitute the sections or parts of the song. You can create up to 200 of your own User Patterns.

There two different recording methods are shown below.

#### Realtime Recording

With this method, the key pads are played in time with a metronome count, with the pattern being recorded just as it is performed. Even if there is a little unevenness in the timing used in tapping the key pads, the Quantize function allows you to record with the timing corrected. (Refer to "Set the Quantization" p. 55)

#### Step Recording

With this recording method, the timing for playing instrument sounds (steps), volume levels, and other aspects of the pattern are specified one by one. This allows patterns to be recorded accurately, even those that are hard to record using Realtime Recording.

You can also record patterns using both Realtime and Step Recording.

After recording the basic pattern using Step Recording, finish creating the Pattern by using Realtime Recording to add sounds in a freer ad-lib style.

---

## Composing the Song

Compose (record) the song by stringing together a sequence of performances using your User Patterns and the 200 Preset Patterns. There are two methods used for recording songs as well.

### Realtime Recording

Here, the song is recorded just by selecting and playing patterns. This allows quick and easy recording of songs.

### Step Recording

With this method, the individual patterns to be played and the points where they are played in the sequence (the parts) are specified one by one. This allows accurate recording of songs, even those that are difficult to record using Realtime Recording and those involving complex combinations of patterns.

## About Operational Modes

The DR-670 features numerous functions for creating patterns and songs and for Editing sounds. These functions are categorized into the following nine different modes.

### Pattern Play mode

(Refer to Chapter 2 Playing Patterns; p. 47)

Used for performing rhythm patterns.

To go into Pattern Play mode, hold down [SHIFT] and press Key Pad 5 (PATTERN PLAY) while the performance is stopped.

The DR-670 will initially be in the Pattern Play mode each time it is powered up.

PATTERN			TEMPO
001	←	---	PLAY 120

### Pattern Edit mode

(Refer to Chapter 3 Recording and Editing Patterns; p. 52)

Used for recording and editing rhythm patterns.

To go into Pattern Edit mode, hold down [SHIFT] and press Key Pad 6 (PATTERN EDIT) while the performance is stopped.

PATTERN EDIT	BEAT - STEP		TEMPO
001	1	EDIT	120

### Song Edit mode

(Refer to Chapter 4 Recording and Editing Songs; p. 63)

Used for recording and editing songs.

To go into Song Edit mode, hold down [SHIFT] and press Key Pad 2 (SONG EDIT) while the performance is stopped.

SONG	EDIT	MEASURE	PATTERN	TEMPO
	1	1	001	120

### Song Play mode

(Refer to Chapter 5 Performing Songs; p. 72)

Used for performing songs.

To go into Song Play mode, hold down [SHIFT] and press Key Pad 1 (SONG PLAY) while the performance is stopped.

SONG	MEASURE	PATTERN	TEMPO
1	1	001	120



## Drum Kit Edit mode

Used for making drum kit settings, assigning sounds to the key pads, and for setting the way sounds are played.

To go into Drum Kit Edit mode, hold down [SHIFT] and press Key Pad 9 (DRUM KIT EDIT) while the performance is stopped.

DRUM KIT EDIT	PAD	PARAMETER	VALUE
9	A13	INST	KC 16

## DPP Assign mode

Used for assigning rhythm patterns to the key pads when the DPP (Direct Pattern Play) function is used.

To go into DPP Assign mode, hold down [SHIFT] and press Key Pad 10 (DPP ASSIGN) while the performance is stopped.

	PAD	PATTERN	
DPP	1	001	

## Utility mode

Used for setting the output part, metronome, foot switches, rolls, flams, pad sensitivity, and master tuning.

To go into Utility mode, hold down [SHIFT] and press Key Pad 13 (UTILITY) while the performance is stopped.

		PARAMETER	VALUE
UTL	OUT	PART	ALL

## MIDI mode

Used for making settings to synchronize performances with the BR-8 or other external MIDI devices. Also used for transmission and reception of the DR-670's internal data with respect to an external MIDI sequencer (Bulk function).

To go into MIDI mode, hold down [SHIFT] and press Key Pad 14 (MIDI) while the performance is stopped.

		PARAMETER	VALUE
MIDI		SYNC	AUTO

## Demo mode

Used for playing the demo songs.

To go into Demo mode, hold down [SHIFT] and press Key Pad 4 (DEMO) while the performance is stopped.

DR-670	DEMO	SONG	
--------	------	------	--

## Drum Kits and Pad Performances

### ■ Drum Kits

The DR-670 includes 256 internal drum sounds (instruments) and sixteen internal bass sounds (bass tones). A “drum kit” is a single set containing 32 of these drum sounds and one of the bass sounds.

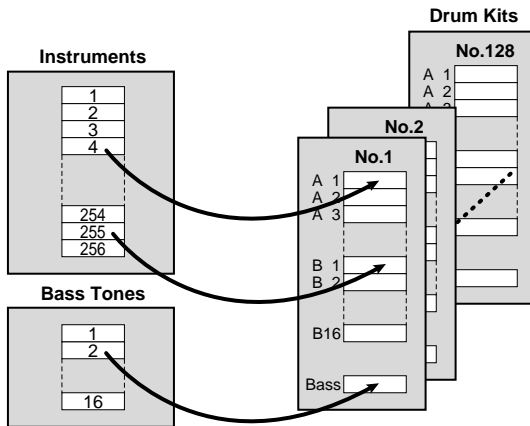

- The DR-670 comes with 64 Preset Drum Kits (Numbers 1–64), and 64 User Drum Kits (Numbers 65–128), whose settings you can change.
- You can modify the sound (change the volume, pitch, and other settings) of instruments assigned to the User Drum Kits, thus enabling you to handle such sounds as new instruments distinct from the internal instruments.
- On the DR-670 you can use only one drum kit when creating any one pattern. You cannot use multiple drum kits simultaneously to make one pattern.
- The number of the drum kit used when creating a pattern is stored within the pattern. As a result, during playback of patterns, a switch is made to the relevant drum kit whenever you switch patterns.

## ■ Pad Performances

Drum sounds are divided into two banks, Drum Bank A and Drum Bank B, each of which contains sixteen sounds, with one of the sixteen sounds each being assigned to a key pad.

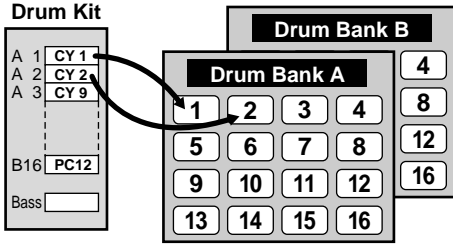

With the DR-670, you can elect to have either Drum Bank A or B, or bass sounds played when the key pads are tapped.

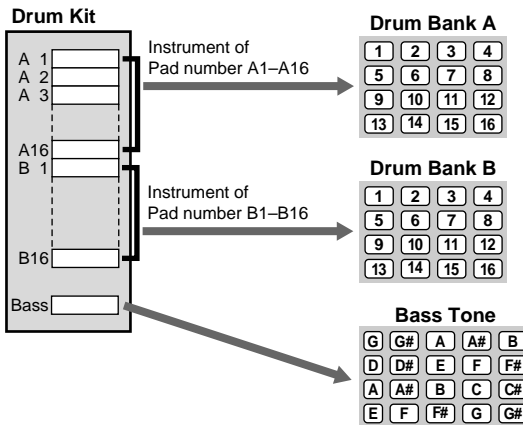

### About Polyphony

The DR-670 features 20-voice polyphony; that is, a maximum of twenty sounds (voices) can be played simultaneously. However, some instruments use two voices each time they sound, so when playing such instruments, the actual number of simultaneous notes may be less than twenty.

To find the number of voices used by each instrument, refer to the “Instrument/Bass Tone List” (p. 99).

# How to View the Scale/Pattern Display

## ■ Pattern Display

The content of any one of the instruments or the bass tone for the currently selected pattern is indicated in the pattern display.

The following shows the relationship between the pattern and what is indicated.

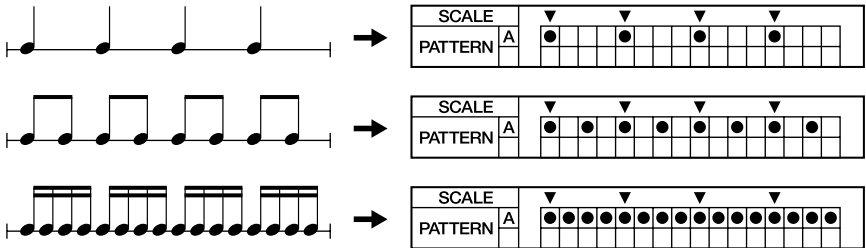

The DR-670 uses patterns that are composed of either one or two measures. When a two-measure pattern is selected, it is indicated as shown below.

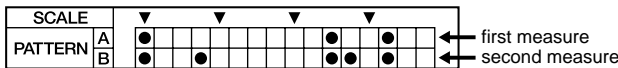

## ■ Switching the Instrument

When you want to display the information for a different instrument, hold down [VOICE] and press the key pad for the instrument whose information you want to display.

\* To switch drum banks, press [DRUM A/B].

The name of the selected instrument appears in the display.

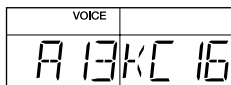

\* To display bass tone information, hold down [VOICE] and press [BASS].

## Scale Display

The “▼” mark in the scale display indicates the timing of the quarter notes.

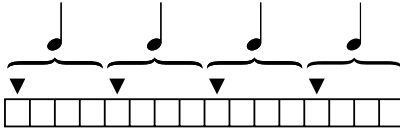

When there are too many beats to allow all of the notes from the beginning to the end of the pattern to be displayed at one time, “▶” appears, indicating that there are steps that are not being displayed.

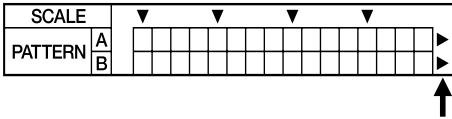

## Changing the Scale

By changing the scale (the length of individual steps = a single square), you can have patterns containing many notes be shown in their entirety, as well as display the content of more complex patterns.

(Example)

BEAT: 4/4

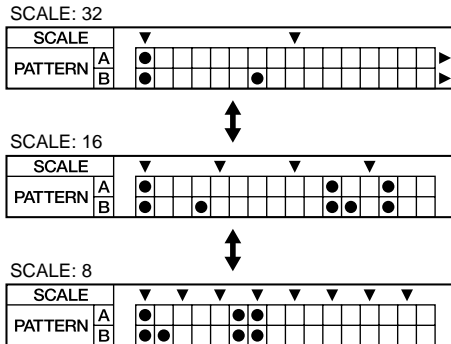

### Operation

1. Hold down [SHIFT] and press [8] (SCALE).
2. While continuing to hold down [SHIFT], turn the TEMPO/VALUE dial to change the scale setting. For example, when set to “16,” the length of a step becomes a sixteenth note. Valid Settings: 32, 16 (triplets), 16, 8 (triplets), 8

PARAMETER	VALUE
SCALE	16

\* Changing the scale settings does not change the performance data.

## Using [SHIFT]

With the DR-670, by holding down [SHIFT] while pressing another button or key pad, you can switch modes and use a variety of convenient functions for editing songs and rhythm patterns.

The text (or symbols) printed above the buttons and key pads on the DR-670's panel indicate the functions selected when [SHIFT] is held down while they are pressed.

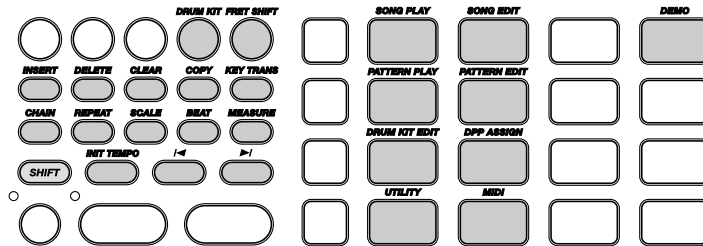

# Chapter 2 Playing Patterns (Pattern Play Mode)

Patterns are played in Pattern Play mode. You can also tap the key pads to play drum sounds and bass sounds.

- ◆ To switch to Pattern Play mode, hold down [SHIFT] while the performance is stopped and press Key Pad 5 (PATTERN PLAY).

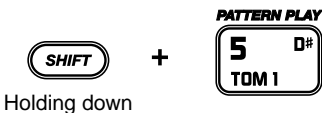

PATTERN			TEMPO
00	←	PLAY	120

## Playing Sounds with the Key Pads

You can tap the key pads to play the sounds of the instruments assigned to them.

The volume and tone of the sound will change depending on how hard you strike a key pad.

**MEMO** The sensitivity of the key pads is adjustable. Refer to “Adjusting the Key Pad Sensitivity” (p. 78).

## Selecting a Drum Kit

1. Hold down [SHIFT] and press [DRUM A/B] (DRUM KIT).
2. Hold down [SHIFT] and rotate the TEMPO/VALUE dial to select a drum kit.

Preset: 1–64

User: 65–128

PATTERN		PARAMETER	VALUE
00	←	KIT	9

3. Once the drum kit has been selected, release your finger from [SHIFT].

You're returned to the Pattern Play Mode screen.



“Preset Drum Kit List” (p. 102)

## Selecting the Drum Bank

You can switch between Drum Banks A and B.

1. Press [DRUM A/B].

This button is pressed to toggle between Banks A and B.

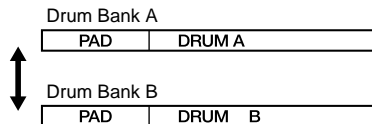

\* You cannot change instruments recorded to patterns by pressing [DRUM A/B].

## Playing the Bass Sounds

Follow the procedure below to play bass sounds.

1. Press [BASS].

PAD	BASS

2. Press a key pad.

The bass sound plays at the predetermined pitches assigned to the key pads.

The bass sound stops when you release the key pad.

Pitches assigned to the key pads correspond to the fret arrangement of the bass guitar.

\* You cannot have more than one bass sound play at a time.

\* You cannot play rolls and flams when playing bass sounds with the key pads.



You can change the difference in the timing of the first and second sticks striking the snare and the relative striking force of each stick (p. 78).



# Playing Patterns

You can select from 200 Preset and 200 User patterns to play.

Patterns 001–200 are Preset patterns, and Patterns 201–400 are User patterns.

\* When the unit left the factory, the User patterns were empty of all data.

## 1. Select the pattern to be played.

Turn the TEMPO/VALUE dial to select the pattern number.

Use the following procedure when selecting the pattern number with the numeric keys.

Press the numeric keys to input the number.

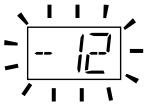

Press [ ▶/ENTER ] to set the pattern number.



\* If you make a mistake in pressing a numeric key, press [ ◀ ] and then reinput with the correct numeric key.

## 2. Press [START] to start the performance.

The tempo indicator flashes on each beat.

- ◆ If a pattern number is entered while the performance of a different pattern is in progress, the pattern with the newly-input number begins after the performance of the pattern currently being played is finished.

PATTERN			TEMPO
001	◀	002	PLAY 120

↑  
Pattern being played

↑  
Next pattern to be performed

## 3. Pressing [STOP/CONT] stops the performance.

When [START] is pressed again, the performance starts from the beginning of the pattern.

# Playing Patterns with the DPP Function

With the DPP (Direct Pattern Play) function, you can play patterns assigned to the key pads (1–16).

## 1. Press [DPP]; “DPP” appears in the display.

PAD	DPP

## 2. Press any of the key pads.

The pattern assigned to the key pad starts to play, with the tempo indicator flashing on each beat.

The pattern number for the pattern being played appears in the display.

PATTERN			TEMPO
001	◀	PLAY	120

- ◆ If a key pad is pressed while the performance of a different pattern is in progress, the pattern assigned to the pressed key pad will begin after the performance of the pattern currently being played has finished.

## 3. Pressing [STOP/CONT] stops the performance.

When a key pad is pressed again, the performance starts from the beginning of the pattern.

When [START] is pressed, the most recently selected pattern starts playing from the beginning.

## 4. To switch the DPP function off, press [DRUM A/B] or [BASS].

## Adjusting the Tempo

1. Hold down [TAP/TEMPO] and rotate the TEMPO/VALUE dial to adjust the tempo.

You can adjust the tempo within the range from 20 to 260.

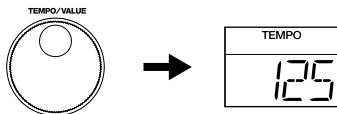

### ■ Adjusting the Tempo with the Tap Tempo Function

You can set the tempo to the interval at which [TAP TEMPO] is pressed.

1. Press [TAP TEMPO] at least three or four times in a steady rhythm.

The tempo is set to the same timing you've just used when tapping [TAP TEMPO].

You can adjust the tempo this way within the range from 20 to 260.

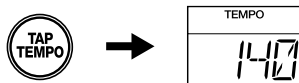

## Inserting Fill-Ins

With the DR-670, you can add fill-in patterns at any point in a pattern while the performance is in progress.

Each pattern features a fill-in prepared for use with that pattern. These fill-in patterns are called "fill patterns," whereas the original pattern on which these are based are called "basic patterns."



You can also create one fill-in pattern for each of the User patterns.

For more details, refer to "Record the Fill Pattern" (p. 59).

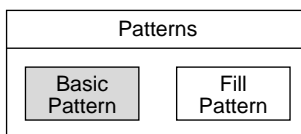

### ■ Adding Fill-Ins While the Pattern is Playing

By pressing [FILL] while the basic pattern is in progress, you can go directly to the performance of the fill pattern and insert the fill-in.

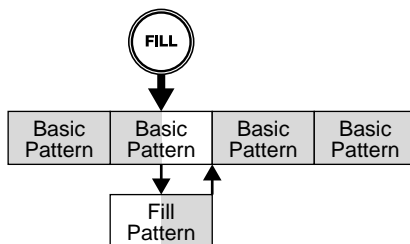

1. Press [START] to start the performance of the pattern.

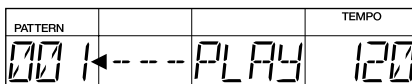

2. Press [FILL] at the time you want to have the fill pattern inserted.

You are moved to the fill pattern the moment [FILL] is pressed.

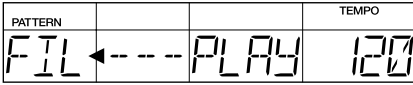

When the fill pattern plays to the end, you are returned to the basic pattern.

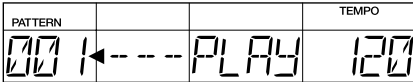

3. Press [STOP/CONT] to stop the performance.

## ■ Playing a Fill Pattern at the Beginning of the Following Pattern

By pressing [FILL] while the final beat of the basic pattern is playing, you can have the fill pattern play at the beginning of the next pattern.

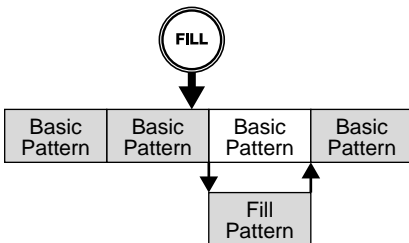

## ■ Starting Performances from the Fill Pattern

When you press [FILL] while performance of the pattern stopped, the fill pattern plays at the moment you press [START], and the performance then goes on to the basic pattern once the fill pattern is finished playing.

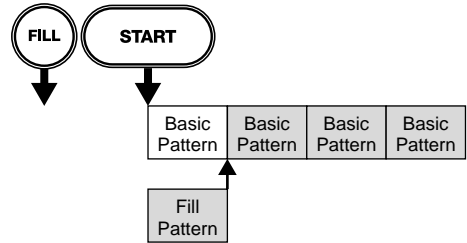

### Using the Foot Switch for Performances

With a foot switch connected, you can then use the foot switch to carry out the [START], [STOP/CONT], and [FILL] operations.

This allows you to use pedal operations to start and stop performances and fill-ins.

- ◆ You can assign functions other than starting and stopping performances and fill-ins.

Refer to “Assigning Functions to the Foot Switches” (p. 77).

# Chapter 3 Recording and Editing Patterns (Pattern Edit Mode)

This section describes the procedures used for recording (Realtime Recording and Step) and editing User patterns.

These operations are carried out in Pattern Edit mode.

- ◆ To switch to Pattern Edit mode, hold Down [SHIFT] while the performance is stopped and press Key Pad 6 (PATTERN EDIT).



PATTERN EDIT	BEAT - STEP		TEMPO
201	1-	EDIT	120

## Before You Start Recording

When creating a new pattern, proceed through the following steps for the recording.

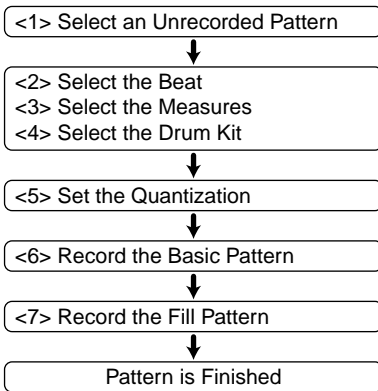

Use the procedures below to record the basic pattern and fill pattern.

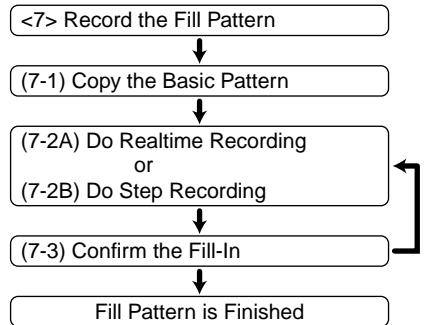
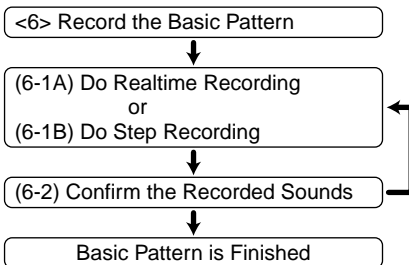

- \* The Beat, Measure, and Drum Kit settings are common to both the basic pattern and the fill pattern.
- \* When you use Realtime Recording or Step Recording to a pattern which has already been recorded, the sounds are layered without the previously recorded sounds being erased.
- \* With the drum part, you cannot record multiple notes from the same pad number at the same step (timing).
- \* Bass parts are monophonic. Even if multiple notes are layered in a recording, only one sound is played.

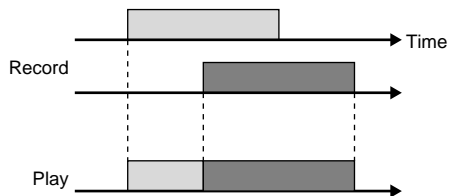

## <1> Select an Unrecorded Pattern

1. With the performance stopped, select a User pattern (201–400).

Turn the TEMPO/VALUE dial to select the pattern number.

\* You can also select the pattern by inputting the pattern number with the numeric keys and pressing [▶/ENTER].

The following appears in the display when an unrecorded pattern (a pattern which contains no data) is selected.

PATTERN EDIT	BEAT -- STEP		TEMPO
201	1--	----	120



You can also use patterns after erasing them.

Refer to “Erasing Patterns (Pattern Clear)” (p. 60).

\* You cannot record or edit the Preset patterns (1–200).

“PRESET” appears in the display if you try to record or edit a Preset pattern.

If you want to record or edit a Preset pattern, first copy the pattern to a User pattern, then proceed with recording or editing.

## <2> Select the Beat

1. Hold down [SHIFT] and press [9] (BEAT).  
\* Continue to hold down [SHIFT].

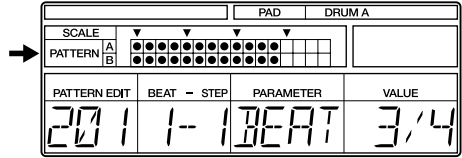

“●” is displayed when the length is one measure.

\* “▶” is indicated to the right of the pattern when the measure is too long to be displayed at once.

To show the entire measure, change the scale setting. For more details, refer to “How to View the Scale/Pattern Display” (p. 44).

2. While still holding down [SHIFT], rotate the TEMPO/VALUE dial to select the beat.  
2/4, 3/4, .... 8/4,  
4/8, 5/8, .... 16/8
3. Release [SHIFT].

## <3> Select the Measures

This setting determines whether a one-measure or two-measure pattern is recorded.

1. Hold down [SHIFT] and press [0] (MEASURE).

\* Continue to hold down [SHIFT].

PARAMETER	VALUE
MEAS	2

2. While still holding down [SHIFT], rotate the TEMPO/VALUE dial to select a one-measure or two-measure pattern.
3. Release [SHIFT].

\* When a two-measure pattern is selected, you cannot set different beats for the first and second measures.



In some recorded data, reducing the number of beats or measures after recording instruments may end up changing the beat length.

Furthermore, once beats or measures have been reduced, you may not be able to restore the original data correctly, even by adding beats or measures again.

Always be sure to confirm settings after making changes.

## <4> Select the Drum Kit

1. Hold down [SHIFT] and press [DRUM A/B] (DRUM KIT).

\* Continue to hold down [SHIFT].

PARAMETER	VALUE
KIT	1

2. While still holding down [SHIFT], rotate the TEMPO/VALUE dial to select a drum kit.
  - 1–64: Preset Drum Kits
  - 65–128: User Drum Kits



For more on the Preset drum kits, refer to “Preset Drum Kit List” (p. 102).

3. Release [SHIFT].

**You can check the beat, measure, and drum kit settings in modes such as the Pattern Play mode and Song Play mode.**

Hold down [SHIFT] and press [9] (BEAT), [0] (MEASURE), or [DRUM A/B] (DRUM KIT).

The values of settings are displayed while [SHIFT] is held down.

## <5> Set the Quantization

Using Quantize in Realtime Recording corrects any timing discrepancies made while tapping the key pads during recording. Normally, this is set to the smallest note unit to be recorded.

To record without the quantization, set this to "OFF." When this is turned off, the key pads are recorded at the exact timing at which they are played.

When using Quantize in Step Recording, you can set how precisely the beat is to be divided.







\* When Quantize is set to "OFF" during Step Recording, one step is set to a 32nd note.

### 1. Hold down [SHIFT] and press [8] (SCALE).

\* Continue to hold down [SHIFT].

PARAMETER	VALUE
QUANTZ	16

### 2. While still holding down [SHIFT], rotate the TEMPO/VALUE dial to set the quantization.

	(no quantize)
	(32nd note)
	(16th note triplets)
	(16th note)
	(8th note triplets)
	(8th note)

### 3. Release [SHIFT].

## <6> Record the Basic Pattern

### ■ (6-1A) Do Realtime Recording Rehearsing

It can be helpful to rehearse your performance before carrying out Realtime Recording.

#### 1. Press [START].

The metronome sound begins, and the tempo indicator flashes in time with the count.

#### 2. Press [DRUM A/B] or [BASS] to select the drum bank or bass part for the instrument to be recorded.

#### 3. Rehearse the performance, tapping the key pads in time with the metronome.

\* Even though you are tapping the key pads, they are not being recorded.

◆ If you want to speed up (or slow down) the metronome tempo, adjust the tempo by holding down [TAP TEMPO] and rotating the TEMPO/VALUE dial.

\* The tempo set here is temporary, and is not recorded to the pattern.

#### 4. When you have finished rehearsing, press [STOP] to stop the metronome.



You can change the metronome volume and beat (count interval). Refer to "Changing the Metronome Settings" (p. 78).

### Recording Using a Foot Switch

With a foot switch connected, you can then use the foot switch to start and stop playback and to start recording.

For more information on setting the functions used with the foot switch, refer to "Assigning Functions to the Foot Switches" (p. 77).

## Realtime Recording of the Drum Part

### 1. Hold down [REC] and press [START].

The REC indicator lights, and the metronome begins playing. The metronome sound begins, and the tempo indicator flashes in time with the count. The BEAT display follows the count.

PATTERN EDIT	BEAT - STEP		TEMPO
201	1	REAL	120

### 2. Press [DRUM A/B] to select the drum bank for the instrument to be recorded.

### 3. Tap the key pad for the instrument being recorded in time with the metronome.

At this time, the force used to tap the key pads is recorded as velocity data.

The recorded performance is repeated.

- ◆ You can check a sound, playing but not recording it, by holding down [VOICE] and pressing the corresponding key pad. The instrument indicated in the pattern display is specified simultaneously.
- ◆ You can record rolls and flams by holding down [ROLL] or [FLAM] while tapping the key pads.
- \* *When playing rolls, even if the roll sound is extremely rapid, it is recorded at the same note division as the Quantize setting for the recording. If you want to record rolls with the precision (Roll Type; p. 77) exactly as set, turn Quantize to "OFF."*
- \* *Sounds may be delayed or omitted in the recording when rapid rolls are played at fast tempos. If this occurs, record at a slower tempo.*
- \* *When playing flams, the flam settings (Flam Interval/Ratio; p. 78) are not recorded. Changing these settings after recording also changes the way the flam sounds.*

### 4. Repeat Steps 2 and 3 as needed.

### 5. Press [STOP] to stop recording.

The REC indicator goes out.

### To Erase Previously Recorded Sounds As You Record

Hold down [SHIFT] and press [2] (DELETE), then while still holding down [SHIFT], press the key pad to which the instrument you want to erase is assigned.

The sounds are erased as long as you hold down [SHIFT] and the key pad.

## Realtime Recording of the Bass Part

### 1. Hold down [REC] and press [START].

The REC indicator lights, and the metronome begins playing. The metronome sound begins, and the tempo indicator flashes in time with the count.

### 2. Press [BASS] to select the bass part.

### 3. Tap the key pad with the name of the instrument to be recorded in time with the metronome.

At this time, the force used to tap the key pads is recorded as velocity, and the length of time starting when you press the key pad until you release it (when the sound stops) is recorded as the note length.

The recorded sounds are repeated.

- ◆ You can check a sound, playing but not recording it, by holding down [VOICE] and pressing the corresponding key pad.
- \* *You cannot play rolls and flams in bass parts.*
- \* *Bass parts are monophonic. Even if multiple notes are layered in a recording, only one sound is played (most recently specified one given priority).*

### 4. Repeat Steps 2 and 3 as needed.

### 5. Press [STOP] to stop recording.

The REC indicator goes out.



### To Erase Previously Recorded Sounds As You Record

Hold down [SHIFT] and press [2] (DELETE), then while still holding down [SHIFT], press one key pad.

All of the sounds, regardless of the pitch, are erased as long as you hold down [SHIFT] and the key pad.

- \* When erasing long note sounds, press the key pad at the point the sound begins to play. Regardless of the length of the note, the entire sound recorded at that time is erased.

## ■ (6-1B) Do Step Recording

### Step Recording of the Drum Part

#### 1. Press [REC].

The REC indicator flashes, and the dot “●” in the Pattern display flashes as well. The flashing dot is for the step being recorded. Either “A” or “B” flashes according to whether the step being recorded is in the first or second measure.

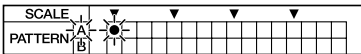

#### 2. Press [DRUM A/B] to select the drum bank for the instrument to be recorded.

#### 3. Press [◀] [▶/ENTER] to specify the step to be recorded.

**MEMO** Holding down [SHIFT] and pressing [◀] lets you jump to the first step. Jump to the final step by holding down [SHIFT] and pressing [▶/ENTER].

#### 4. Tap the key pad for the instrument to be recorded.

At this time, the force used to tap the key pads is recorded as velocity.

The recording automatically advances by one step.

- ◆ You can check a sound, playing but not recording it, by holding down [VOICE] and pressing the corresponding key pad. The

instrument indicated in the pattern display is specified simultaneously.

- ◆ You can record rolls and flams by holding down [ROLL] or [FLAM] while tapping the key pads.
- \* When recording rolls in Step Recording, the roll settings (Roll Type; p. 77) are disabled, and the steps in the interval from the time you press a key pad to the moment you release it are recorded one sound at a time.
- \* When playing flams, the flam settings (Flam Interval/Ratio; p. 78) are not recorded. Changing these settings after recording also changes the way the flam sounds.
- \* You cannot record multiple notes to the same pad number at the same step.

#### 5. Repeat Steps 2 through 4 as needed.

- \* If necessary, change the Quantize settings for recording (p. 55).

#### 6. Press [STOP] to stop recording.

The REC indicator goes out.

- \* Note that pressing [START] during Step Recording (while the REC indicator is lit) switches the DR-670 to Realtime Recording.

### To Erase Previously Recorded Sounds As You Record

- Press [◀] [▶/ENTER] to move to the step to be deleted.
- Hold down [SHIFT] and press [2] (DELETE), then while still holding down [SHIFT], press the key pad to which the instrument you want to erase is assigned.

### Step Recording of the Bass Part

#### 1. Press [REC].

The REC indicator flashes, and the dot “●” in the Pattern display flashes as well. The flashing dot is for the step being recorded.

Either “A” or “B” flashes according to whether the step being recorded is in the first or second measure.

#### 2. Press [BASS] to select the bass part.

- Press [ ◀ ] [ ▶/ENTER ] to specify the step to be recorded.



Holding down [SHIFT] and pressing [ ◀ ] lets you jump to the first step.

- Tap the key pad with the note to be recorded.

At this time, the velocity (the force used to tap the key pad) is also recorded.

The recording automatically advances by one step.



“To Record Long Notes in the Bass Part” (p. 58)

- You can record over a wide range of pitches by using the Fret Shift function (p. 48).
- You can check a sound, playing but not recording it, by holding down [VOICE] and pressing the corresponding key pad.

\* You cannot

\* You cannot

## To Record Long Notes in the Bass Part

- Press [ ◀ ] [ ▶/ENTER ] to specify the steps to be recorded.

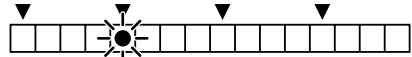

Step at which recording begins

- Hold down the key pad with the note to be recorded.
- Press [ ▶/ENTER ], and continue pressing until the step where you want the sound to stop playing.

Note length

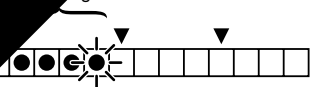

Step at which recording ends

- Release the key pad.  
This sets the length of the note.

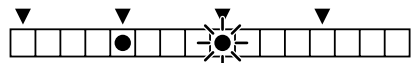

Next step to be recorded

### (Example)

When using Step Recording to record a quarter note starting at the second beat in the pattern, with Quantize set to sixteenth notes



- Press [ ◀ ] [ ▶/ENTER ] to specify the steps to be recorded.

### Erasing Recorded Sounds

Press [ ▶/ENTER ] to move to the step to be deleted.

Hold down [SHIFT] and press [2] (DELETE), then while still holding down [SHIFT], press one key pad.

- When erasing a long bass sound, erase the sound in the step that contains the sound (the step in which the sound begins to play). Regardless of the length of the note, the entire sound is erased.

- b. Tap a key pad, and continue holding it down instead of releasing it.
- c. While continuing to hold down the key pad, press [ ►/ENTER ] to specify Step 2-4.

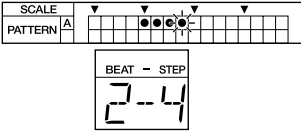

- d. Release the key pad.

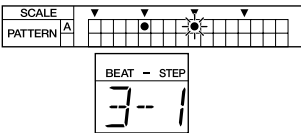

## ■ (6-2) Confirm the Recorded Sounds

1. If recording is in progress, press [STOP] to stop the recording.  
The REC indicator goes out.
2. When you press [START], the recorded pattern is played.
3. Press [STOP] to stop the performance.

## <7> Record the Fill Pattern

\* *The Beat, Measure, and Drum Kit settings are common to both the basic pattern and the fill pattern.*

### ■ (7-1) Select the Fill Pattern

1. With the performance stopped, press [FILL].

If there is no data recorded to that fill pattern, check whether or not the basic pattern has been copied.

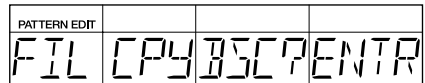

2. When copying, press [ ►/ENTER ].

When recording a new pattern instead of copying, press [ ◀ ].

### ■ (7-2A) Do Realtime Recording

### ■ (7-2B) Do Step Recording

These operations are identical to the recording operations for the basic pattern.

Refer to p. 55-59.

### ■ (7-3) Confirm the Fill-In

When you have finished recording the fill pattern, try using the Fill-In function (p. 50) to check that the performances of the basic pattern and the fill pattern join together smoothly.

\* *To return to recording of basic patterns, either press [FILL] once more, or directly select the pattern by entering the pattern number.*

## Erasing Patterns (Pattern Clear)

You can clear unneeded User patterns.

\* *The Preset patterns (1–200) cannot be cleared.*

**1. With the performance stopped, select the User pattern to be cleared.**

Turn the TEMPO/VALUE dial to select the pattern number.

\* *You can also select the pattern by inputting the pattern number with the numeric keys and pressing [ ►/ENTER ].*

\* *When selecting a fill pattern, press [FILL].*

**2. Hold down [SHIFT] and press [3] (CLEAR).**

\* *Continue to hold down [SHIFT].*

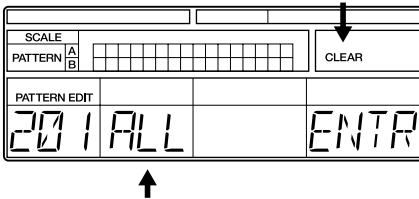

Data to be cleared

**3. While continuing to hold down [SHIFT], rotate the TEMPO/VALUE dial to select the data to be cleared.**

**When Selecting Basic Patterns ([FILL] Not Pressed)**

**ALL:** All pattern data (the beat, measures, drum kit, recorded basic pattern data, recorded fill pattern data)

**BSC:** Basic pattern

**BSC DRUM:** Basic pattern drum part only

**BSC BASS:** Basic pattern bass part only

**When Selecting Fill Patterns ([FILL] Is Pressed)**

**FIL:** Fill pattern

**FIL DRUM:** Fill pattern drum part only

**FIL BASS:** Fill pattern bass part only

**4. If you are sure you want to clear the data, while still holding down [SHIFT], press [ ►/ENTER ].**

Deletion of the User pattern is executed, and when it is finished the display will indicate "DONE."

**5. When the data is all cleared, release [SHIFT].**

\* *To cancel the operation, release [SHIFT].*

\* *If the selected pattern has not been recorded yet (has no data recorded to it), "DATA EMPT" is displayed without the deletion being executed.*

# Copying Patterns

This copies User and Preset patterns to other User patterns.

\* Note that when a pattern is recorded to a copy destination, the data previously occupying the copy destination is discarded.

## 1. With the performance stopped, select the User pattern you want to copy.

Turn the TEMPO/VALUE dial to select the pattern number.

\* You can also select the pattern by inputting the pattern number with the numeric keys and pressing [ ►/ENTER ].

\* When selecting a fill pattern, press [FILL].

## 2. With the performance still stopped, hold down [SHIFT] and press [4] (COPY).

\* Continue to hold down [SHIFT].

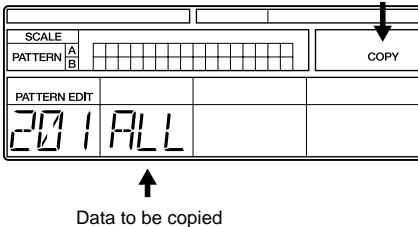

Data to be copied

## 3. While continuing to hold down [SHIFT], rotate the TEMPO/VALUE dial to select the data to be copied.

### When Selecting Basic Patterns ([FILL] Not Pressed)

**ALL:** All pattern data (the beat, measures, drum kit, recorded basic pattern data, recorded fill pattern data)

**BSC:** Basic pattern

**BSC DRUM:** Basic pattern drum part only

**BSC BASS:** Basic pattern bass part only

### When Selecting Fill Patterns ([FILL] Is Pressed)

**FIL:** Fill pattern

**FIL DRUM:** Fill pattern drum part only

**FIL BASS:** Fill pattern bass part only

- When you have finished determining which data is to be copied, then while still holding down [SHIFT], press [ ►/ENTER ]. The display switches to the copy-destination User pattern selection screen.

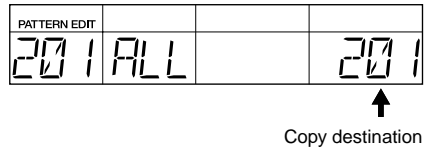

- Hold down [SHIFT] and rotate the TEMPO/VALUE dial to select the copy-destination User pattern.

You can also enter the pattern number with the numeric keys. When the number is entered, press [ ►/ENTER ] to set it.

- When selecting anything other than "ALL" as the data to be copied, you then need to select whether to have the data copied to the basic pattern or the fill pattern.

You can switch between basic and fill patterns by pressing [FILL].



- If you are sure you want to copy the data, hold down [SHIFT] and press [ ►/ENTER ].

The copy of the User pattern is executed, and when it is finished the display will indicate "DONE."

- To cancel the operation, release [SHIFT].

- When the copy is completed, release [SHIFT].

\* When anything other than ALL is selected for copying, the performance data may not play back correctly if the number of beats and measures in the copy source and copy destination differ. Be sure to check it after copying the data.

\* If the selected pattern has not been recorded yet (has no data recorded to it), "DATA EMPT" is displayed without the copying being executed.

## Replacing Drum Kits

You can substitute a drum kit selected in recording with a different drum kit.

\* *You cannot select different drum kits for the basic pattern and the fill pattern.*

### 1. Select the User pattern with the replacement drum kit.

Turn the TEMPO/VALUE dial to select the pattern number.

\* *You can also select the pattern by inputting the pattern number with the numeric keys and pressing [ ►/ENTER ].*

### 2. Hold down [SHIFT] and press [DRUM A/B] (DRUM KIT).

\* *Continue to hold down [SHIFT].*

PARAMETER	VALUE
1/ T T	1

### 3. Still holding down [SHIFT], rotate the TEMPO/VALUE dial to select the drum kit.

You can select from the Preset drum kits (1–64) and the User drum kits (65–128).



“Preset Drum Kit List” (p. 102)

### 4. Release [SHIFT].

## Changing the Key of the Bass Part (Key Transpose)

With the “Key Transpose” function, you can change (transpose) the key of the bass part during playback.

\* *Key Transpose settings are disregarded when recording and playing back patterns in Pattern Edit mode. Confirm that Key Transpose is enabled in Pattern Play mode.*

\* *You cannot select different Key Transpose settings for the basic pattern and the fill pattern.*

### 1. With the performance stopped, select the User pattern with the bass part whose key you want to change.

Turn the TEMPO/VALUE dial to select the pattern number.

\* *You can also select the pattern by inputting the pattern number with the numeric keys and pressing [ ►/ENTER ].*

### 2. Hold down [SHIFT] and press [5] (KEY TRANS).

\* *Continue to hold down [SHIFT].*

PARAMETER	VALUE
KEY	0

### 3. Still holding down [SHIFT], rotate the TEMPO/VALUE dial to select the new key.

Settings range: -12– +12

You can set the transposition in semitone steps up to a  $\pm 1$  octaves up or down.

### 4. Release [SHIFT].

# Chapter 4 Recording and Editing Songs (Song Edit Mode)

This section describes the procedures used for recording (Realtime/Step) and editing User patterns.

These operations are carried out in Song Edit mode.

- You can record up to a maximum of 100 songs.
- You can record up to a maximum of 250 patterns in one song, with a maximum total number of 3,000 patterns for all the songs together.

◆ To switch to Song Edit mode, hold down [SHIFT] while the performance is stopped and press Key Pad 2 (SONG EDIT).



SONG	EDIT	MEASURE	PATTERN	TEMPO
	1		00	120

◆ Select a song to create or edit when in Song Edit mode.

1. With the performance stopped, hold down [SHIFT] and then press Key Pad 2 (SONG EDIT) to switch to Song Edit mode.

\* Continue to hold down [SHIFT].

2. Hold down [SHIFT] and rotate the TEMPO/VALUE dial to select the song.

\* You can also select the song by inputting the number with the numerical keys and pressing [▶/ENTER].

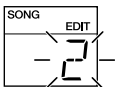

3. Release [SHIFT].



## Before You Start Recording

When creating a new song, proceed through the following steps for the recording.

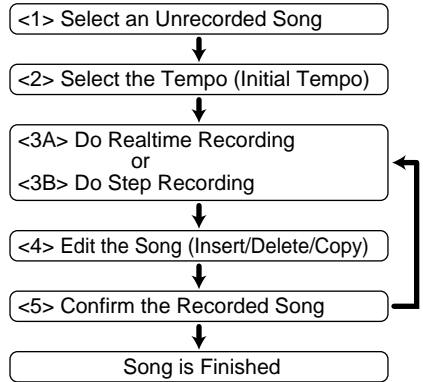

## <1> Select an Unrecorded Song

### 1. Switch to Song Edit mode.

With the performance stopped, press Key Pad 2 (SONG EDIT).

\* Continue to hold down [SHIFT].



Holding down

### 2. Select the song.

Hold down [SHIFT] and rotate the TEMPO/VALUE dial to select the song.

\* You can also select the song by inputting the number with the numerical keys and pressing [▶/ENTER].

The following appears in the display when an unrecorded song (a song which contains no data) is selected.

SONG	MEASURE	PATTERN	TEMPO
EDIT		---	120



### 3. Release [SHIFT].



You can also remove previously recorded songs and use them for recording new songs.

Refer to “Removing Unneeded Songs (Song Clear)” (p. 70).

## <2> Select the Tempo (Initial Tempo)

This sets the initial tempo, the basic tempo used to play the song.

### 1. Hold down [SHIFT] and press [VOICE] (INIT TEMPO).

\* Continue to hold down [SHIFT].

PARAMETER	TEMPO
INIT	120

### 2. While still holding down [SHIFT], rotate the TEMPO/VALUE dial to select the initial tempo.

When set to “OFF,” the song is played at the tempo selected at the time.

### 3. Release [SHIFT].

\* You can check the initial tempo settings in Song Play mode.

Hold down [SHIFT] and press [VOICE] (INIT TEMPO).

The initial tempo settings are displayed while [SHIFT] is held down.



## <3A> Do Realtime Recording

Here, select the pattern and then record it as it is being performed.

\* When recording over a song that has already been recorded, the newly recorded data overwrites the previously recorded data, which is discarded.

### 1. With the performance stopped, select the first pattern to be recorded.

Turn the TEMPO/VALUE dial to select the pattern number.

\* You can also select the pattern by inputting the pattern number with the numeric keys and pressing [ ►/ENTER ].

SONG	MEASURE	PATTERN	TEMPO
EDIT		00	120



◆ When you want to begin the recording with the performance of a fill pattern, press [FILL] after selecting the pattern.

		FILL	
--	--	------	--



### 2. Hold down [REC] and press [START] to start recording.

The first selected pattern simultaneously starts to play.

The tempo indicator flashes on each beat.

\* When a fill pattern is selected, the fill pattern is played until the end, and then the performance returns to the basic pattern.

\* The same pattern continues to be recorded until the next pattern is selected.

### 3. Select the next pattern to be recorded.

Turn the TEMPO/VALUE dial to select the pattern number.

\* You can also select the pattern by inputting the pattern number with the numeric keys and pressing [ ►/ENTER ].

◆ You can record fill patterns by pressing [FILL] during recording.

The fill pattern is played until the end, and then the performance returns to the basic pattern.

In addition, by pressing [FILL] while the final beat of a pattern is being played, you can have the fill pattern recorded from the beginning of the next pattern.

\* Although the fill pattern is played when [FILL] is pressed at the time of recording, the fill pattern is played at the beginning of the pattern during playback.

### 4. Repeat Step 3 as needed to record one song's worth of patterns.

\* When Pattern 250 is reached, the message "PTN FULL" appears, and recording is ended automatically.

### 5. Press [STOP/CONT] to stop the recording.

\* If recording is stopped in a pattern's second measure, the measure number is reduced by one after such stoppage, and that number then becomes the number of the starting measure for the pattern.

### Recording Using a Foot Switch

With a foot switch connected, you can then use the foot switch to carry out the [START], [STOP/CONT], and [FILL] operations.

For more information on setting the functions used with the foot switch, refer to "Assigning Functions to the Foot Switches" (p. 77).

## ■ Using the DPP Function in Realtime Recording

1. Press [DPP]; “DPP” appears in the display.

PAD	DPP
-----	-----

2. With the song stopped, press the key pad to which the first pattern to be recorded is assigned.

3. Hold down [REC] and press [START] to start recording.

The first selected pattern simultaneously starts to play.

The tempo indicator flashes on each beat.

4. Press a key pad to select the next pattern to be recorded.

\* You can also select patterns by rotating the TEMPO/VALUE dial or pressing the numeric keys and [▶/ENTER].

5. Repeat Step 4 as needed.

6. Press [STOP/CONT] to stop the recording.

## ■ Switching Recorded Patterns

\* To switch the pattern in the first measure, select the substitute pattern before carrying out Step 1.

1. Hold down [REC] and press [START] to start Realtime Recording.

The prerecorded pattern starts to play.

The tempo indicator flashes on each beat.

2. When you reach the measure before the one you want to substitute, select the next pattern to be recorded.

Turn the TEMPO/VALUE dial to select the pattern number.

\* You can also select the pattern by inputting the pattern number with the numeric keys and pressing [▶/ENTER].

◆ You cannot select with the key pads when [DPP] is pressed and the DPP function is turned on.

3. When you have finished recording the replacement pattern, press [STOP/CONT] to finish the recording.

\* If no pattern number is entered as the replacement pattern, then the pattern already recorded is played.

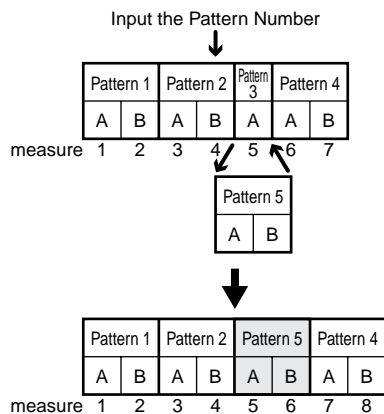

◆ You can replace the pattern being recorded by pressing [FILL] during recording.

After the fill pattern is played to the end, the recording returns to the basic pattern.

\* Although the fill pattern is played when [FILL] is pressed at the time of recording, the fill pattern is played at the beginning of the pattern during playback.

## ■ Starting Realtime Recording Within a Song

You can start Realtime Recording from a point other than the beginning of the song.

This is convenient when you want to insert patterns in lengthy songs.

1. **With the performance stopped, press [ ◀ ] [ ▶/ENTER ] to specify the measure where recording is to begin.**

\* *When recording two-measure patterns, you cannot specify the second measure of each pattern.*

Pattern 1		Pattern 2		Pattern 3	Pattern 4	
A	B	A	B	A	A	B

measure ① 2 ③ 4 ⑤ ⑥ 7

Measures You Can Specify

2. **Hold down [REC] and press [START].**  
Recording begins from the currently selected measure.  
The tempo indicator flashes on each beat.
3. **When you reach the measure before the one you want to substitute, select the next pattern to be recorded.**  
Turn the TEMPO/VALUE dial to select the pattern number.  
\* *You can also select the pattern by inputting the pattern number with the numeric keys and pressing [ ▶/ENTER ].*
4. **When the replacement pattern is recorded, press [STOP/CONT] to end recording.**  
\* *If no pattern number is entered as the replacement pattern, then the pattern already recorded is played.*

## ■ Adding Patterns at the End of a Song

You can start Realtime Recording at the end of a recorded song to add more patterns to the song.

1. **With the performance stopped, hold down [SHIFT] and press [ ▶/ENTER ].**  
This lets you jump to the measure following the last measure of the song.
2. **Select a pattern to add.**  
Turn the TEMPO/VALUE dial to select the pattern number.  
\* *You can also select the pattern by inputting the pattern number with the numeric keys and pressing [ ▶/ENTER ].*
3. **Hold down [REC] and press [START].**  
Recording begins from the measure number following the last measure of the song, while the additional pattern you selected starts to play.  
The tempo indicator flashes on each beat.  
\* *The same pattern continues to be recorded until the next pattern is selected.*
4. **Select the next pattern to be recorded.**
5. **Repeat Step 4 as needed to record additional patterns.**  
\* *When Pattern 250 is reached, the message "PTN FULL" appears, and recording is ended automatically.*
6. **Press [STOP/CONT] to stop the recording.**

## <3B> Do Step Recording

This lets you record the song by specifying patterns one at a time in the order they are to be played.

- 1. With the performance stopped, press [REC].**  
The DR-670 is put in Step Recording mode, and the REC indicator flashes.
- 2. Select a pattern to record.**  
Rotate the TEMPO/VALUE dial to select the pattern.  
When you press [ ►/ENTER ], the pattern is recorded, and the measure number advances automatically.  
*\* When using the numeric keys for input, the pattern is recorded and the measure number advances automatically when you press [ ►/ENTER ] after inputting the number.*  
◆ You cannot select with the key pads when [DPP] is pressed and the DPP function is turned on.  
After pressing a key pad to select a pattern, press [ ►/ENTER ] to set the pattern.  
◆ After selecting the pattern, you can then select the fill pattern by pressing [FILL] and then [ ►/ENTER ].  
*\* During Step Recording, you cannot switch to a fill pattern while a recording of another pattern is in progress.*
- 3. Repeat Step 2 as needed to record one song's worth of patterns.**
- 4. Press [STOP/CONT] to stop the recording.**

When you hold down [SHIFT] and press [START] during Step Recording, the selected pattern is played. This allows you to check the content of patterns to be recorded.

The pattern stops playing when you release [SHIFT].

- \* Pressing [START] without holding down [SHIFT] starts Realtime Recording.*

## ■ Switching Recorded Patterns

- 1. With the performance stopped, press [REC] to start Step Recording.**  
The REC indicator flashes.
- 2. Press [ ◀ ] [ ►/ENTER ] to select the measure with the pattern to be switched.**
- 3. Select the pattern to be switched.**  
Rotate the TEMPO/VALUE dial to select the pattern.  
When you press [ ►/ENTER ], the pattern is recorded, and the measure number advances automatically.  
*\* When using the numeric keys for input, the pattern is recorded and the measure number advances automatically when you press [ ►/ENTER ] after inputting the number.*
- 4. Repeat Step 3 as needed.**
- 5. When you have finished recording the substitute pattern, press [STOP/CONT] to stop the recording.**

## ■ Adding Patterns at the End of a Song

- 1. With the performance stopped, hold down [SHIFT] and press [ ►/ENTER ].**  
This lets you jump to the measure following the last measure of the song.
- 2. Press [REC] to start Step Recording.**  
The REC indicator flashes.
- 3. Select a pattern to add.**  
Rotate the TEMPO/VALUE dial to select the pattern.  
When you press [ ►/ENTER ], the pattern is recorded, and the measure number advances automatically.  
*\* When using the numeric keys for input, the pattern is recorded and the measure number advances automatically when you press [ ►/ENTER ] after inputting the number.*
- 4. Repeat Step 3 as needed.**
- 5. When you have finished recording additional patterns, press [STOP/CONT] to end the recording.**

## Adding Patterns In the Song (Insert)

This operation inserts a pattern at a point within the song.

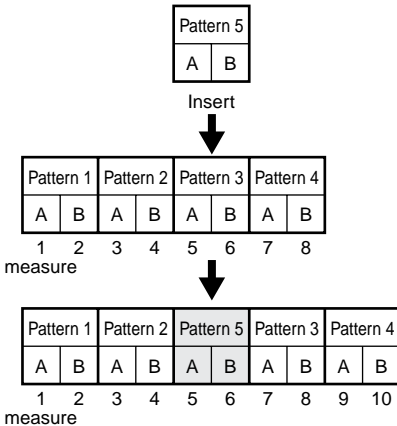

\* When the pattern to be inserted is two measures, you cannot insert only one measure. Furthermore, you cannot insert material between the measures of a two-measure pattern being recorded.

1. With the performance stopped, press [ ◀ ] [ ▶/ENTER ] to specify the measure where the pattern is to be inserted.
2. Hold down [SHIFT] and press [1] (INSERT).

\* Continue to hold down [SHIFT].

3. Select the pattern to insert.

Continue holding down [SHIFT] and rotate the TEMPO/VALUE dial to select the pattern number. Press [ ▶/ENTER ] to set the number.

\* You can also input the pattern number by holding down [SHIFT] and pressing the numeric keys. When you have decided on the pattern, press [ ▶/ENTER ] to set the pattern.

The pattern is inserted, and when it is finished the display will indicate "DONE."

4. When the insertion is finished, release [SHIFT].

\* To cancel the operation, release [SHIFT].

## Deleting Patterns (Delete)

This deletes unneeded patterns from songs.

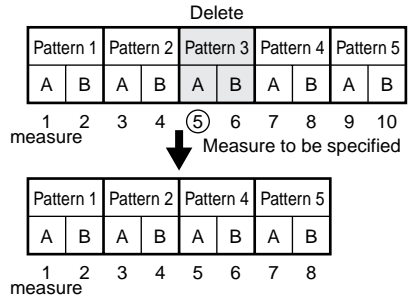

1. With the performance stopped, press [ ◀ ] [ ▶/ENTER ] to specify the measure to be deleted.

2. Hold down [SHIFT] and press [2] (DELETE).

\* Continue to hold down [SHIFT].

3. While continuing to hold down [SHIFT], press [ ▶/ENTER ].

The pattern is deleted, and when it is finished the display will indicate "DONE."

4. When the deletion is finished, release [SHIFT].

\* To cancel the deletion, release [SHIFT].

## Removing Unneeded Song (Song Clear)

This erases content of the currently selected Song.

### 1. Hold down [SHIFT] and press [3] (CLEAR).

\* Continue to hold down [SHIFT].

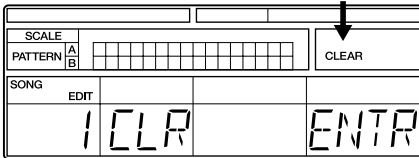

### 2. If you are sure you want to clear the song, while still holding down [SHIFT], press [ ►/ENTER ].

The song is erased, and when it is finished the display will indicate "DONE."

### 3. When the song is cleared, release [SHIFT].

\* If the selected pattern has not been recorded yet (has no data recorded to it), "DATA EMPT" is displayed without the clear being executed. If this occurs, first release [SHIFT] and carry out the procedure again from the beginning.

\* To cancel the operation, release [SHIFT].

## Copying Song

This copies content of the currently selected Song to other Song.

\* Note that when a song is recorded to a copy destination, the data that was in the copy destination is discarded.

### 1. Hold down [SHIFT] and press [4] (COPY).

\* Continue to hold down [SHIFT].

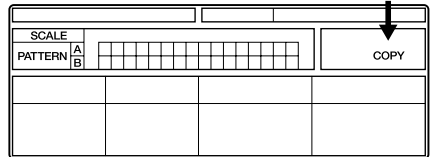

### 2. Select the copy-destination song number.

Hold down [SHIFT] and rotate the TEMPO/VALUE dial to select the song, then press [ ►/ENTER ] to confirm the selection

\* You can also input the song number by pressing the numeric keys, and select the song by pressing [ ►/ENTER ].

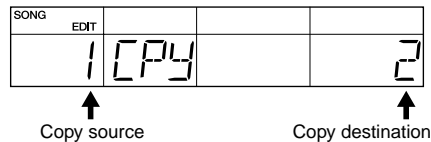

### 3. If you are sure you want to copy the song, hold down [SHIFT] and press [ ►/ENTER ].

The song is copied, and when it is finished the display will indicate "DONE."

### 4. When the copy is completed, release [SHIFT].

\* If the copied song has not been recorded yet (has no data recorded to it), "DATA EMPT" is displayed without the copy being executed. If this occurs, first release [SHIFT] and carry out the procedure again from the beginning.

\* To cancel the operation, release [SHIFT].

## Connecting Multiple Songs Into One Song (Song Chain)

You can have a number of songs performed in one connected sequence. This function is called “Song Chain.”

Each song is assigned the song number of the song that is to follow it—you can chain up to 100 songs this way.

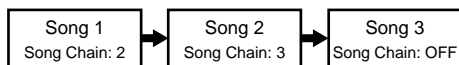

The procedure for making the Song Chain setting for the currently selected song is as follows.

1. Hold down [SHIFT], and press [6] (CHAIN).

\* Continue to hold down [SHIFT].

PARAMETER	VALUE
CHN	OFF

2. Select the next song to be played.

Hold down [SHIFT] and rotate the TEMPO/VALUE dial to select the song number.

\* You can also input the song number by holding down [SHIFT] and pressing the numeric keys, and select the song by pressing [▶/ENTER].

Set to “OFF” at the last song to be played in the sequence.

3. When you have finished making the settings, release [SHIFT].

4. Switch the currently selected song to continue adding to the song chain as needed.

Set the final song to be played in the chain to “OFF.”



### Creating Songs Featuring Tempo Changes

You can use the Song Chain function to create songs that have changes in tempo.

Create songs to be positioned both before and after the tempo change, making the necessary initial tempo settings for each song.

When you use the Song Chain function to connect the performances of the two songs, it allows you to create a performance in which the tempo changes in the middle of the song.

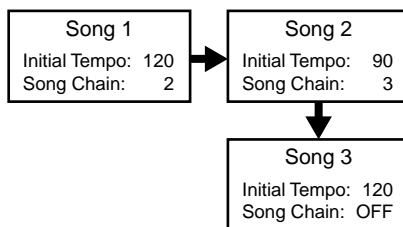

# Chapter 5 Performing Songs (Song Play Mode)

In Song Play mode, you can play the songs that have been created.

- ◆ To switch to Song Play mode, hold down [SHIFT] while the performance is stopped and press Key Pad 1 (SONG PLAY).



## Performing Songs

### 1. Select a song to play.

Turn the TEMPO/VALUE dial to select the song.

- \* You can also input the number by pressing the numeric keys, and select the song by pressing [▶/ENTER].

SONG	MEASURE	PATTERN	TEMPO
1	1	001	120



- \* The following appears in the display if the selected song contains no data.

SONG	MEASURE	PATTERN	TEMPO
1	1	-----	120



### 2. Press [START].

The song is played from the beginning.

The tempo indicator flashes with each beat, and the measure currently being played is displayed.

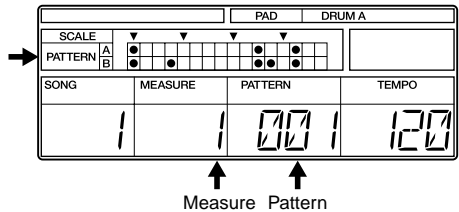

### 3. Press [STOP/CONT] to stop the song.

When you press [STOP/CONT] once again, the song starts playing again from the point where it was stopped.

- \* You can change the tempo settings, even while a song is being played, by holding down [TAP TEMPO] and rotating the TEMPO/VALUE dial or by tapping [TAP TEMPO] in rhythm.



## Starting a Song From a Point Other Than the Beginning

You can start playing a song from a specified measure. This is convenient when you want to start playing a song containing many measures from some point within the song.

1. **With the performance stopped, press [ ◀ ] [ ▶/ENTER ] to specify the starting measure.**

SONG	MEASURE	PATTERN	TEMPO
	1	00	120



- ◆ Hold down [SHIFT] and press [ ◀ ] to jump to the first measure of the song.

When a song is set as part of a chain, you can hold down [SHIFT] and press [ ▶/ENTER ] to jump to the next song.

2. **Press [STOP/CONT].**

The song is played from the specified measure.

## Repeating Performances of Songs (Song Repeat)

You can have songs be played repeatedly. This function is called “Song Repeat.”

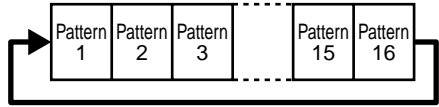

1. **With the performance stopped, hold down [SHIFT] and press [7] (REPEAT).**

\* Continue to hold down [SHIFT].

PARAMETER	VALUE
RPT	OFF

2. **Hold down [SHIFT] and rotate the TEMPO/VALUE dial to set the Song Repeat function to on or off.**

“SONG REPEAT” appears in the display when the Song Repeat function is on.

SONG REPEAT
-------------

3. **Release [SHIFT].**

\* Song Repeat settings are not saved when the power is turned off. The function is always turned off when the DR-670's power is turned off.

## Performing Multiple Songs In One Sequence (Song Chain)

“SONG CHAIN” appears in the display when the currently selected song is specified in “Song Chain” (p. 71).

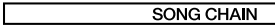

### ■ Checking the Song Chain Settings

You can confirm the Song Chain settings in Song Play mode.

1. **Hold down [SHIFT] and press [6] (CHAIN).**

As you continue to hold down [SHIFT], the following appears in the display.

PARAMETER	VALUE
CHAIN	2



For instructions on making settings for the Song Chain function, refer to “Connecting Multiple Songs Into One Song (Song Chain)” (p. 71).

## Creating Performances Combining the Repeat and Chain Functions

You can repeatedly play performances of multiple songs by setting Song Repeat to “ON” for songs set using the Song Chain function.

Song Repeat: ON

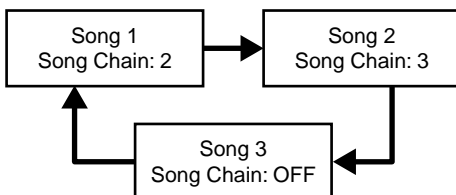

## Checking a Song’s Initial Tempo

You can check the Initial Tempo (p. 64) setting for a song in Song Play mode.

1. **Hold down [SHIFT] and press [VOICE] (INIT TEMPO).**

As you continue to hold down [SHIFT], the following appears in the display.

PARAMETER	TEMPO
INIT T	120



For instructions on making the Initial Tempo settings, refer to “Select the Tempo (Initial Tempo)” (p. 64).

- \* *If you change the tempo settings after selecting a song, the performance is played at the changed tempo when the song is started. If you want to restore the initial tempo, reselect the song.*

### Using a Foot Switch to Play Songs

With a foot switch connected, you can then use the foot switch to carry out the [START] and [STOP/CONT] operations.

For more information on setting the functions used with the foot switch, refer to “Assigning Functions to the Foot Switches” (p. 77).

# Chapter 6 Assigning Patterns to the Key Pads (DPP Assign Mode)

Here, patterns are assigned to the key pads (1–16) for DPP (Direct Pattern Play).

1. **With the performance stopped, hold down [SHIFT] and press Key Pad 10 (DPP ASSIGN).**

The DR-670 switches to DPP Assign mode.

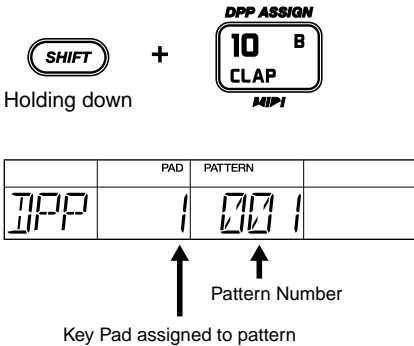

2. **Press a key pad to which you wish to assign a pattern.**
3. **Rotate the TEMPO/VALUE dial to select the pattern.**

\* You can also enter the pattern number with the numeric keys. When the number is entered, press [ ►/ENTER ] to set the number.

\* You cannot assign the fill pattern.

4. **Repeat Steps 2 and 3 as needed.**
5. **Hold down [SHIFT] and press Key Pad 5 (PATTERN PLAY).**

The DR-670 switches to Pattern Play mode.

The DPP function turns on automatically, allowing you to use Direct Pattern Play.

You can also check the DPP Assign settings in Pattern Play mode.

1. **While in Pattern Play mode, press [DPP] to turn on the DPP function.**
2. **Press [VOICE]; the DPP assignment is displayed while [VOICE] is held down.**

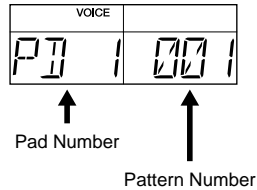

3. **To check another pad, continue to hold down [VOICE] and press the pad you want to check.**

# Chapter 7 Customizing Your Setup (Utility Mode)

You can make the following settings in Utility mode.

- Switch the sounding/muting of drum parts and bass parts (Output Part)
- Assign functions to the foot switches
- Change the roll interval (Roll Type)
- Change the flam settings (Flam Interval, Flam Ratio)
- Adjust the key pad sensitivity (Pad Sens)
- Change the metronome settings (Click Level, Click Beat)
- Tune the bass part (Master Tune)

## Procedure

1. With the performance stopped, hold down [SHIFT] and press Key Pad 13 (UTILITY).  
The DR-670 switches to Utility mode.

		PARAMETER	VALUE
UTL	OUTPART		ALL

2. Press [◀] [▶]/[ENTER] to select the parameter with the settings you want to change.

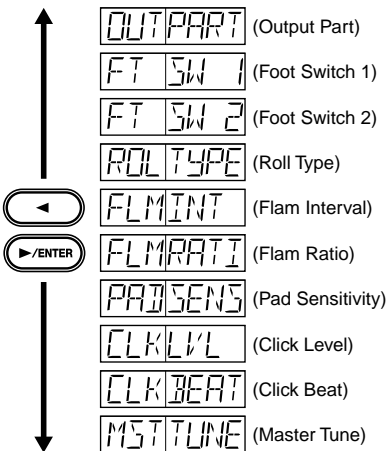

3. Rotate the TEMPO/VALUE dial to change the value of the setting.
4. Repeat Steps 2 and 3 as needed.

## Switching the Sounding/Muting of Drum Parts and Bass Parts (Output Part)

		PARAMETER	VALUE
UTL	OUTPART		ALL

- ALL:** Both the drum part and the bass part are played
- DRUM:** The drum part is played, and the bass part is muted
- BASS:** The bass part is played, and the drum part is muted

\* *Output Part settings are not saved. The function always reverts to "ALL" when the DR-670's power is turned off.*

\* *The Output Part settings are effective only with respect to the playback of patterns. The Output Part settings have no effect on the output when you perform by playing the pads.*

## Assigning Functions to the Foot Switches

Settings for the functions controlled with the foot switches 1 and 2.

Foot Switch 1

		PARAMETER	VALUE
UTL	FT	SW	1START

Foot Switch 2

		PARAMETER	VALUE
UTL	FT	SW	2FILL

### STRT:

Used for starting the pattern or song from the beginning and stopping the pattern or song.

Same operations achieved by pressing [STRT] and [STOP/CONT].

### FILL:

Switches to the fill pattern.

Same operation achieved by pressing [FILL].

### CONT:

Controls Continue Start/Stop.

Same operation achieved by pressing [STOP/CONT].

### RSET:

Resets the song or pattern (jumps to the beginning).

Same operation achieved by holding down [SHIFT] and pressing [◀].

### REC:

Starts Realtime Recording.

Same operation achieved by holding down [REC] and pressing [START].

\* *This is enabled in Pattern Edit mode and Song Edit mode.*

### CHAS:

When the DPP function is off, this function selects the pattern with the number one greater than the currently selected pattern number. If Pattern Number 400 is currently selected, then Pattern Number 1 is the next pattern selected.

When the DPP function is on, this function selects the pad with the number one higher than the currently selected pad. If Pad Number 16 is currently selected, then Pad Number 1 is selected next.

\* *This is enabled in Pattern Play mode and Song Edit mode.*

### PD 1–PD16, PD G, PD D, PD A, PD E:

Performs the same operations achieved by pressing the pads with the specified numbers (1–16, G, D, A, E).

Functions according to the currently selected pad function (DRUM A, DRUM B, BASS, DPP).

## Changing the Roll Settings (Roll Type)

Sets the note length for rolls.

		PARAMETER	VALUE
UTL	ROL	TYPE	16

 (32nd note)

 (16th note triplets)

 (16th note)

 (8th note triplets)

 (8th note)

## Changing the Flam Settings

By changing the flam interval and flam ratio settings, you can change the way the flam sounds.

\* *Changing the flam settings only changes the way flams are played in patterns that have already been recorded.*

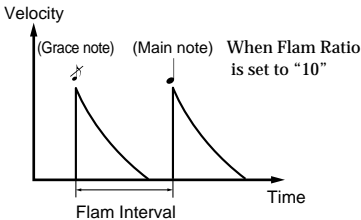

### Flam Interval (0–31)

Sets the difference in time of the two sounds making up the flam. When set to 0, no flam is produced.

		PARAMETER	VALUE
UTL	FLMINT		12

### Flam Ratio (0–10)

Sets the relative force (velocity) of the first and second strikes. No grace note is played when this is set to 0.

		PARAMETER	VALUE
UTL	FLMRATI		5

## Adjusting the Key Pad Sensitivity (Pad Sens)

The lower the value you select, the lower the sensitivity becomes. While this means that strong accents are unobtainable unless the pads are hit with a considerable amount of force, it does make it easier to produce subtle changes. Sensitivity increases as the settings value is raised. Although this lets you add strong accents even if the pads are tapped lightly, it becomes more difficult to get subtle changes.

Valid Settings: 0–10

		PARAMETER	VALUE
UTL	PAISENS		5

## Changing the Metronome Settings

### Click Level (0–15)

Adjusts the volume of the metronome during Realtime Recording of patterns.

		PARAMETER	VALUE
UTL	CLKLVL		15

### Click Beat

Sets the beat of the metronome during Realtime Recording of patterns.

		PARAMETER	VALUE
UTL	CLKBEAT		4

8: 8th note

4: 4th note

## Tuning the Bass Part

Sets the basic pitch for the bass part.

\* *The drum parts (Includes Instruments BS1–BS5) cannot be changed.*

Valid Settings: 438–445

		PARAMETER	VALUE
UTL	MSTTUNE		440

\* *The pitch of the sound being played does not change. This goes into effect from the sound played after the settings are made.*

# Chapter 8 Creating Your Own Favorite Drum Kits (Drum Kit Edit Mode)

In Drum Kit Edit mode, you can select drum and bass instruments, change the way they sound, and make other changes to drum kit settings to create up to 64 original User drum kits.

- ◆ To switch to Drum Kit Edit mode, hold down [SHIFT] while the performance is stopped and press Key Pad 9 (DRUM KIT EDIT).

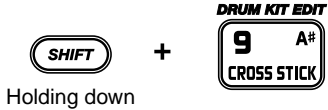

DRUM KIT EDIT	PAD	PARAMETER	VALUE
72	A	INST	KC36

## Before Changing the Settings (Editing)

Use the procedure below to change (edit) the drum kit settings.

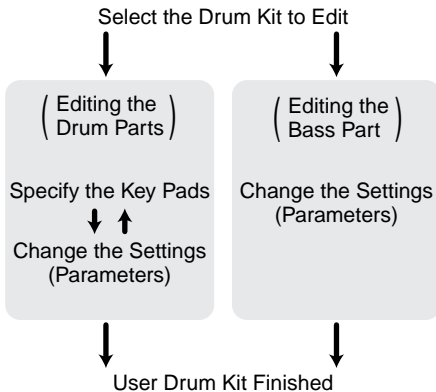

\* When the unit left the factory, the User drum kits (65–128) contained the same settings as the Preset drum kits (1–64).

## ■ Select the Drum Kit to Edit

**You cannot edit the Preset drum kits.**

If you want to base a new kit on a Preset drum kit, you can copy the Preset to a User drum kit first, then edit it to your liking. For instructions on copying drum kits, refer to “Copying Drum Kits” (p. 84).

1. Hold down [SHIFT] and press [DRUM A/B] (DRUM KIT).
  - \* Continue to hold down [SHIFT].
2. While holding down [SHIFT], rotate the TEMPO/VALUE dial to select the drum kit to be edited.
3. Release [SHIFT].

## ■ Editing Procedure

1. If editing a drum part, press [DRUM A/B] then specify Drum Bank A or B. If editing a bass part, press [BASS] to specify the bass part.
2. If editing a drum part, specify the key pad to be edited by pressing that key pad.  
This step is not required if you are editing a bass part.  
*\* You cannot edit individual key pads for the bass part.*
3. Press [◀] [▶]/[ENTER] to specify the setting (parameter) you want to change.

DRUM KIT EDIT	PAD	PARAMETER	VALUE
72	A	INST	36

4. Rotate the TEMPO/VALUE dial to change the value of the setting.
5. Repeat Steps 3 and 4 as needed.  
When editing drum parts, start from Step 2 if you are editing other key pads.

## Editing the Drum Parts

### ■ Selecting the Sounds Assigned to the Key Pads (Instrument)

This selects the instruments to be assigned to the key pads.

For more on the instruments that can be selected, refer to the “Instrument/Bass Tone List” (p. 99).

DRUM KIT EDIT	PAD	PARAMETER	VALUE
72	A	INST	04

*\* You cannot select bass tones for the drum parts.*

### ■ Setting the Volume (Level)

This sets the volume (the level) for each instrument. The velocity when you actually tap the key pads is changed within the level range set here.

**Valid Settings: 0–15**

DRUM KIT EDIT	PAD	PARAMETER	VALUE
72	A	LVL	15

### ■ Setting the Pitch (Pitch)

This sets the pitch of each instrument in units of 10 cents.

**Valid Settings: -1200– +1200**

DRUM KIT EDIT	PAD	PARAMETER	VALUE
72	A	PITCH	0

#### Positive (+) Values:

The pitch is raised as the value increases; an increase of 100 cents raises the pitch a half step (semitone).

**0:** The original pitch is used.

#### Negative (-) Values:

The pitch is lowered as the value increases; an increase of 100 cents lowers the pitch a half step (semitone).

*\* With some instruments, the pitch may not change properly when the value is positive (set to “+”).*



## Lengthening and Shortening the Reverberation (Decay)

This lengthens and shortens the reverberation of the sound (the decay) for each instrument.

**Valid Settings:** -32- +31

DRUM KIT EDIT	PAD	PARAMETER	VALUE
72	A	DECAY	0

**Positive (+) Values:** As the value increases, the decay is lengthened relative to the original decay.

**0:** The original decay time is used.

**Negative (-) Values:** As the value increases, the decay is shortened relative to the original decay.

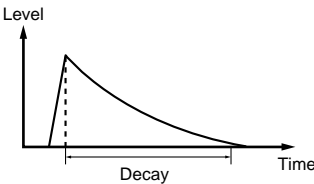

\* With some instruments, it may seem that the amount of change when using a positive setting is slight.

## Obtaining Tonal Changes Relative to Strike Position (Nuance)

When playing percussion, the tone changes depending on where you hit the instrument. For example, when playing a cymbal, the tone around the center differs from the tone at the edge.

With the instruments in the “Instrument/Bass Tone List” (p. 99) that have \* or \*\* added to the name, you can change the Nuance settings, which allow you to obtain tonal changes relative to the position the instrument is struck.

**Settings Values:** -7- +7

DRUM KIT EDIT	PAD	PARAMETER	VALUE
72	A	NUANCE	0

Instruments Appended with an Asterisk (\*)

**Positive (+) Values:** As the value increases, the low frequency components of the sound increase (sound from striking closer to the center).

**0:** Original nuance

**Negative (-) Values:** As the value increases, the low frequency components of the sound decrease (sound from striking the outside part).

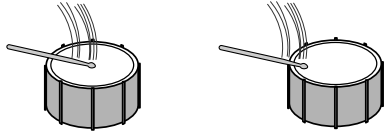

Instruments Appended with a Double Asterisk (\*\*) (Hi-Hat, Ride Cymbal, Etc.)

**Positive (+) Values:** As the value increases, the sound appears to come more from the interior (sound from striking the interior part).

**0:** Original nuance

**Negative (-) Values:** As the value increases, the sound appears to come more from the outside (sound from striking the outside part).



The Nuance settings are disabled on instruments that are not marked with a single or double asterisk (\*, \*\*).

## Setting the Position of the Sound (Pan)

This sets the placement (Pan) of each instrument, with seven degrees of adjustment.

**Settings Values:** L3-CNTR-R3

DRUM KIT EDIT	PAD	PARAMETER	VALUE
P	B	PAN	CNTR



\* The Pan settings of instruments in the “Instrument/Bass Tone List” (p. 99) that are marked with three asterisks (\*\*\*) are disabled.

## ■ Determining Whether Or Not Sounds Overlap (Assign Type)

This sets the way each instrument sounds (the assign type) when one or more instruments continue to be played.

**Settings Values:** POLY, EX1P–EX7P, MONO, EX1M–EX7M

DRUM KIT EDIT	PAD	PARAMETER	VALUE
72	A	10	ASGNPOLY

### POLY

When one instrument continues playing, the new sound overlaps the previously sounded instrument without that earlier instrument's sound being stopped. This is effective with cymbals and other instruments with long decay times.

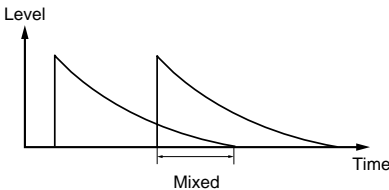

### EX1P (POLY EXC1)–EX7P (POLY EXC7)

The sounds of the same instrument are allowed to overlap, but the sound of another instrument sharing the same number (EX\*M, EX\*P) is not allowed to overlap. This is effective with sounds that normally are not heard at the same time (such as the open and closed hi-hat sounds), but which do produce overlapping sounds when one of them is being sounded consecutively.

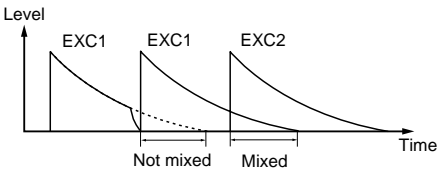
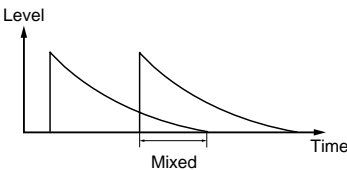

### MONO

When one instrument sound is played consecutively, the previous sound is stopped when a new sound is played.

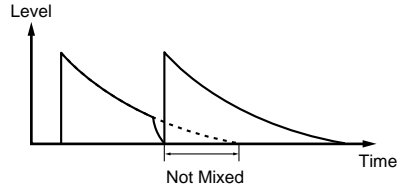

### EX1M (MONO EXC1)–EX7M (MONO EXC7)

The sounds of instruments with the same number (EX\*M, EX\*P) are not layered. Furthermore, instrument sounds with the same number are not layered even when played continuously. This is effective with sounds that normally are not played simultaneously, such as Guiro short and Guiro long sounds.

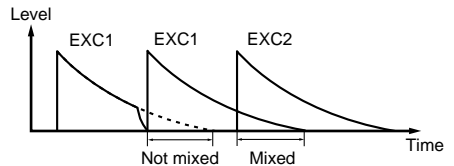
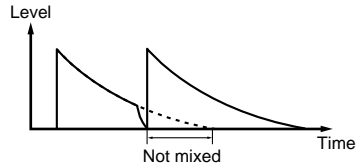

## Editing the Bass Part

### ■ Selecting the Tone (Bass Tone)

This selects the tone for the bass part (the bass tone). For more on the bass tones you can select, refer to the “Instrument/Bass Tone List” (p. 99).

DRUM KIT EDIT	PAD	PARAMETER	VALUE
72	---	TONE	FN62

\* You cannot select drum instruments for use in bass parts.

### ■ Setting the Volume (Level)

This sets the volume (level). The velocity when you actually tap the key pads is changed within the level range set here.

Valid Settings: 0–15

DRUM KIT EDIT	PAD	PARAMETER	VALUE
72	---	LVL	15

### ■ Adjusting the Envelope (Attack, Decay, Release)

This adjusts the envelope of the bass sound.

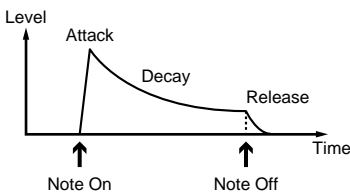

### Sharpness in the Rise of the Sound (Attack)

Valid Settings: 0–15

DRUM KIT EDIT	PAD	PARAMETER	VALUE
72	---	ATCK	0

- 0: Original nuance
- 1–15: The attack gets duller as the value increases.

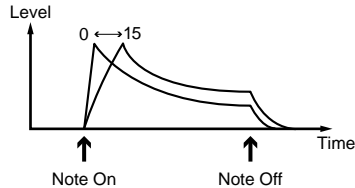

### Decay Time for the Sound (Decay)

Valid Settings: -31– +31

DRUM KIT EDIT	PAD	PARAMETER	VALUE
72	---	DECAY	0

#### Positive (+) Values:

The more the value is increased, the more the decay slows relative to the original decay.

#### 0: Original nuance

#### Negative (-) Values:

The more the value is decreased, the more the decay quickens relative to the original decay.

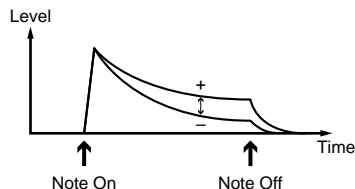

## Decay Time After Note Off (Release)

Valid Settings: -7- +7

DRUM KIT EDIT	PAD	PARAMETER	VALUE
72	---	RELS	0

### Positive (+) Values:

The release gets longer than the original as the value increases.

0: Original nuance

### Negative (-) Values:

The release gets shorter than the original as the value increases.

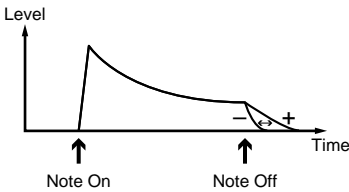

## Positioning the Sound (Pan)

This sets the placement of the sound, with seven degrees of adjustment.

Valid Settings: L3-CNTR-R3

DRUM KIT EDIT	PAD	PARAMETER	VALUE
72	---	PAN	CNTR

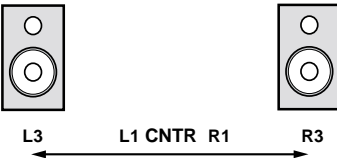

## Copying Drum Kits

This copies the currently selected drum kit to one of the User drum kits (65-128).

\* If the drum kit you want to copy is not the one that is currently selected, first select the drum kit that you do want to copy before continuing.

1. Hold down [SHIFT] and press [4] (COPY).

\* Continue to hold down [SHIFT].

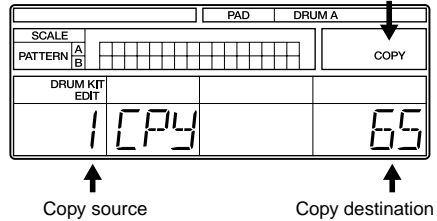

2. While holding down [SHIFT], rotate the TEMPO/VALUE dial to select the copy-destination drum kit.

\* You cannot select 1-64 (the Preset drum kits).

3. If you are sure you want to copy the drum kit, hold down [SHIFT] and press [▶/ENTER].

The drum kit copying process starts.

\* To cancel the operation, release [SHIFT].

4. Once the copy has been completed, release your finger from [SHIFT].

## What is MIDI?

MIDI (Musical Instrument Digital Interface) is a universal standard that allows for the exchange of performance data and other information among electronic musical instruments and computers. Once MIDI cables are used to connect together devices equipped with MIDI connectors, each device can send data to, or receive data from any of the others.

### MIDI Connectors

The DR-670 is equipped with a MIDI IN connector and MIDI OUT connector.

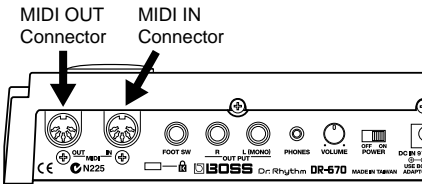

### MIDI IN

Receives data from an external MIDI device. Connect to the MIDI OUT connector on the external MIDI device.

### MIDI OUT

Transmits the DR-670's data. Connect to the MIDI IN connector on the external MIDI device.

- \* Do not connect the MIDI IN connector directly to the own MIDI OUT connector.
- \* When making a looped connection with other MIDI devices, do not set the connected devices to THRU (SOFT THRU). Otherwise, malfunction could result.

### MIDI Implementation Chart

In order to exchange MIDI data, the data transmitted by the MIDI devices must be common to both. The owner's manuals for a MIDI device always includes a MIDI Implementation Chart, which allows you to quickly check the compatibility of that device with other devices. By comparing the MIDI Implementation Charts of each device you are using, you can confirm which kinds of data can be exchanged.

\* A separate publication titled "MIDI Implementation" is also available. It provides complete details concerning the way MIDI has been implemented on this unit. If you should require this publication (such as when you intend to carry out byte-level programming), please contact the nearest Roland Service Center or authorized Roland distributor.

## About MIDI Mode

With the DR-670, you can use MIDI data to do the following.

- Synchronize performances with a digital recorder or MIDI sequencer
- Use an external MIDI device to play the DR-670, and use the DR-670 to play an external MIDI device
- Transmit data from the DR-670 to an external MIDI device and return the transmitted data to the DR-670

In MIDI mode, you can make the necessary parameter settings for handling MIDI data.

You can also transmit data in MIDI mode.

- ◆ To switch to MIDI mode, hold down [SHIFT] while the performance is stopped and press Key Pad 14 (MIDI).

**SHIFT**

Hold

## Synchronizing Performances with a Digital Recorder or MIDI Sequencer (Sync Mode)

You can synchronize the DR-670's performances with digital recorders, MIDI sequencers, rhythm machines, and other such devices.

### Master and Slave

When synchronizing two or more devices, one is made the "master" device and all others "slaves."

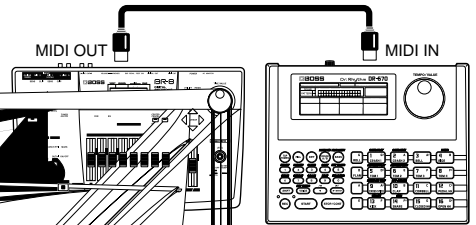

Slave (DR-670)

When a device is started or stopped, a MIDI message is transmitted. The slave device then starts or stops in response to the transmitted MIDI message. The slave device transmits timing (lock) data corresponding to the transmitted MIDI message. The slave device synchronizes their performances to the master device. The transmitted data from the master device includes song numbers (Song Number) and the position of song performances (Song Pointer).

## Data Synchronized with the DR-670

The following MIDI messages are handled during synchronization with the DR-670.

- Start
- Timing Clock
- Continue
- Song Select
- Stop
- Song Position Pointer

\* *Song Select and Song Position Pointer data are not output in Song Edit mode.*

\* *For more information on the MIDI messages handled by the devices you are connecting, refer to the owner's manual for each device.*

## ■ Setting Sync Mode

Select whether the DR-670 is to be the master or slave in Sync mode.

	PARAMETER	VALUE
MTD	SYNC	AUTO

### AUTO:

Master and slave are switched automatically.

While the DR-670 normally functions as the master, when the performance is stopped and a Start message is input from an external MIDI device, the DR-670 automatically switches to slave.

### INT:

The DR-670 functions as the master.

Operating the DR-670 starts and stops performances, and performances play at the tempo set in the DR-670.

### MIDI:

The DR-670 functions as a slave device.

The DR-670 starts and stops according to the messages input from an external MIDI device, and performances are synchronized to the timing clock transmitted by the external MIDI device.

\* *Sync mode settings are not saved. The function is always set to "AUTO" when the DR-670's power is turned off.*

## Tempo Display with the DR-670 as Slave

When the DR-670 is functioning as a slave device, the tempo appears in the display as shown below, and the tempo cannot be controlled from the DR-670.



If no timing clock is being transmitted by the external source when [START] is pressed, then the tempo indicator lights and remains lit, and the start of the performance is put on hold until the timing clock arrives.

\* *You cannot switch modes while the DR-670 is in this state. To switch modes, press [STOP/CONT], then proceed to switch the mode after the tempo indicator has gone out.*

Bank A  
 49 57 53 51  
 50 48 45 41  
 37 39 56 44  
 36 38 42 46

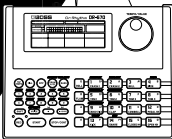

Drum Part

	PARAMETER	VALUE
MIDI	CH DRUM	OFF

Bass Part

	PARAMETER	VALUE
MIDI	CH BASS	OFF



## Transmitting the DR-670's Data to an External MIDI Device/ Returning Transmitted Data to the DR-670

Transmitting the DR-670's data to a MIDI sequencer or another DR-670 is known as "Bulk Dump."

Conversely, returning data saved to a MIDI sequencer back to the DR-670, or receiving data transmitted from another DR-670 is referred to as "Bulk Load."

### ■ Setting the Device ID

Although patterns, drum kits, and other device-specific data are transmitted and received in "Bulk Dump" and "Bulk Load" as "Exclusive messages," the number used by the devices to recognize each other (the Device ID number) must match.

		PARAMETER	VALUE
MIDI	DEV	ID	17

Settings Values: 17–32

### ■ Transmitting the DR-670's Data (Bulk Dump)

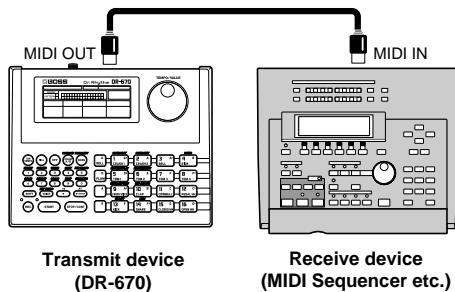

Use the following procedure in MIDI mode when carrying out Bulk Dump.

1. Press [ ◀ ] [ ▶ ] [ ENTER ] to select "TX BULK."

		PARAMETER	VALUE
MIDI	TX	BULK	ALL

2. Rotate the TEMPO/VALUE dial to select the data to be transmitted.

**ALL:** All of the DR-670's data

**SEQ:** Data recorded in the User patterns and songs

**UTIL:** Utility mode, MIDI mode and DPP assign settings data

**KIT:** All of the User drum kits

3. Press [START].

Bulk Dump starts, and the tempo indicator lights up.

After a few moments, the tempo indicator goes out, and the Bulk Dump is completed.

\* If you do inadvertently start Bulk Dump, you can cancel transmission by pressing [STOP/CONT]. Do not use the data from the cancelled operation.

\* When executing Bulk Dump with "ALL" selected, the memory of the receiving device may become filled, and any data following that will not be received.

If this occurs, change the setting for the transmitted data to "SEQ," "UTIL," or "KIT," then execute Bulk Dump.



## Making the DR-670 Settings

On the DR-670, select the song (Song Play mode) or pattern (Pattern Play mode) to use.

\* You can use the DR-670's MIDI settings with the power left on. If you mistakenly make changes to the Sync mode settings (p. 87), set the DR-670 to "AUTO" or "MIDI."

## Performing

When you have finished making the settings, start the performance of the song on the BR-8 from the beginning of the song.

The performance of the DR-670 is synchronized to the song.

## ■ Playing the BR-8's Rhythm Guide Sound as a DR-670 Drum Sound

When playing the BR-8's internal Rhythm Guide sound, you can have the guide sound converted to a DR-670 drum sound.

## Making the BR-8 Settings

Use the following procedure to make the settings for the BR-8.

1. Press [UTILITY].
2. Press CURSOR [◀] [▶] to select the MIDI icon, then press [ENTER].

UTIL:MIDI

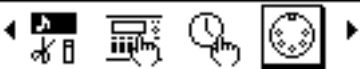

3. Press CURSOR [▼] to move the cursor to "Rhythm MIDI ch.," then rotate the TIME/VALUE dial to select the MIDI channel (1–16). Set this to 10 here.
4. Press [EXIT] enough times to return to the Level Meter screen.

## Making the DR-670 Settings

Use the following procedure to make the settings for the BR-8.

1. Hold down [SHIFT] and press key pad 14 (MIDI).  
The DR-670 switches to MIDI mode.
2. Confirm that you have switched to the Sync mode settings screen, then rotate the TEMPO/VALUE dial to set the Sync mode to "INT."

		PARAMETER	VALUE
MIDI		SYNC	INT



3. Press [▶]/[ENTER] to select "CH DRUM."  
The drum part's MIDI channel selection screen appears in the display.

		PARAMETER	VALUE
MIDI		CH DRUM	OFF

4. Rotate the TEMPO/VALUE dial to set the MIDI channel.  
Set this to 10 here.
5. Hold down [SHIFT] and press key pad 5 (PATTERN PLAY).  
The DR-670 switches to Pattern Play mode.
6. Hold down [SHIFT] and press [DRUM A/B] (DRUM KIT). Then, while continuing to hold down [SHIFT], rotate the TEMPO/VALUE dial to select the drum kit you want to use.
7. Release [SHIFT].

## Performing

When you have finished making the settings, start the performance of the song on the BR-8 from the beginning.

The BR-8's Rhythm Guide pattern is played using a DR-670 sound.

operation or when an operation cannot be executed that are displayed.

		PTN	FULL
--	--	-----	------

The number of patterns recorded in the song exceeded 250.

Press [STOP/CONT].

You cannot record any further to the song currently being edited. To continue, create a new song, then use Song Chain (p. 71).

--	--	--	--

- Copy source and cleared patterns and song data are not being recorded during copying and clearing of the pattern or song.

- Confirm the pattern numbers and song numbers of the copy source, or the data to be cleared.

Battery,

Press [STOP/CONT] to continue using the pattern and song data. Power is turned off.

		STOK	PENTA
--	--	------	-------

Recorded in the DR-670 is corrupted; restoring the data is necessary (this message appears when the power is turned on).

Press [▶/ENTER] to restore the factory settings.

		MEM	FULL
--	--	-----	------

- Memory is full. No more patterns or songs can be recorded.

- Press [STOP/CONT]. To continue recording, first delete unneeded patterns or songs (p. 60, 70).

- A MIDI Active Sensing error has occurred. An abnormality has been detected in the device or cable connected to MIDI IN.

- Check the device or cable connected to MIDI IN.

- Too many MIDI messages were received all at once, and the DR-670 was unable to process all of them.

- Press [STOP/CONT]. Reduce the volume of the MIDI messages being sent by the transmitting device.

ERR		CHECKSUM
-----	--	----------

- MIDI Exclusive messages could not be received correctly.
- Press [STOP/CONT], then try the operation again.

		TIMEOUT
--	--	---------

- Reception of data during Bulk Load was cancelled before the operation was completed.
- Press [STOP/CONT], then try carrying out Bulk Load again.

ERR		TOO BUSY
-----	--	----------

- The system attempted to concurrently process abnormally large amounts of data, but was unable to succeed.
- Press [STOP/CONT]. Make sure that the unit is not being forced to handle an overly large amount of data (in patterns, or received MIDI messages) all at once, and try to reduce the amount of data.

ERR		SYSTEM ?
-----	--	----------

- An unknown error has occurred in the system.
- Immediately stop using the unit, and consult your dealer or nearest Roland Service Center.

# Troubleshooting

If you find the DR-670 is not operating correctly, check the items listed below.

If the DR-670 still does not work properly after you check these points, consult your local Roland Service or your dealer.

## No Sound

- Is the volume turned down (p. 18)?
- Is the output part set to “DRUM” or “BASS” (p. 76)?
- Is the instrument’s level set to “0” (p. 80)?
- Have you selected a pattern or song containing no performance data?

## Sounds Drop Out

- Are you playing too many sounds simultaneously?

The DR-670 has a maximum polyphony of 20 sounds (voices). Some instruments use two voices each time they are played, so using such instruments results in reducing polyphony to fewer than 20 voices.

With some kinds of patterns, you can reduce the number of voices that sound simultaneously by setting the Assign Type to MONO. This would be effective, for example, in a pattern where a lengthy cymbal sound is triggered on every beat.

- Could there be a mistake in the Assign Type settings (p. 82)?

## Can’t Play Rolls/Flams

- Could there be a mistake in the Flam Interval or Flam Ratio settings (p. 78)?
- Are you trying to play a roll or flam with a bass part?

## Performance Does Not Start When [START] Is Pressed

- Is “MIDI” selected in Sync mode (p. 87)?
- Have you selected a pattern or song containing no performance data?

## REC Indicator Does Not Flash When [REC] Is Pressed

# Operation List

## Operations Common to All Modes

Operation	Purpose
[START]	Start/Stop Performances
[STOP/CONT]	Stop Performance/Continue Play
[TAP TEMPO] + [TEMPO/VALUE]	Adjust Tempo
[REC]	Step Recording
[REC] + [START]	Realtime Recording
[TAP TEMPO]	Tap Tempo
[FILL]	Fill-In
[DPP]	Direct Pattern Play On
[DRUM A/B]	Switch Drum Banks A/B
[BASS]	Play Bass Tone with the key pads
[SHIFT] + [DRUM A/B] (DRUM KIT)	Switch Drum Kit
[SHIFT] + [BASS] (FRET SHIFT)	Fret Shift Settings
[VOICE]	Confirm Instrument/Bass Tone
[SHIFT] + [8] (SCALE)	Scale/Quantize Settings
[ ◀ ]	Move/Select Parameter
[ ▶/ENTER ]	Move/Select Parameter/Set Value
[SHIFT] + [ ◀ ]	Jump to Beginning
Key Pad	Pad Performances/Direct Pattern Play
[ROLL] + Key Pad	Play Roll
[FLAM] + Key Pad	Play Flam

## Song Play Mode

Operation	Purpose
[TEMPO/VALUE]	Select Song
Numeric Keys ▶ [ ▶/ENTER ]	Select Song
[SHIFT] + [6] (CHAIN)	Confirm Song Chain Settings
[SHIFT] + [7] (REPEAT)	Song Repeat
[SHIFT] + [VOICE] (INIT TEMPO)	Confirm Initial Tempo

## Song Edit Mode

Operation	Purpose
[SHIFT] + (Key Pad 2 (SONG EDIT) → [TEMPO/VALUE])	Select Song
[SHIFT] + (Key Pad 2 (SONG EDIT) → Numeric Keys → [ ►/ENTER ])	Select Song
[SHIFT] + [6] (CHAIN)	Song Chain
[SHIFT] + [7] (REPEAT)	Song Repeat
[SHIFT] + [VOICE] (INIT TEMPO)	Initial Tempo
[SHIFT] + [1] (INSERT)	Insert Pattern
[SHIFT] + [2] (DELETE)	Delete Pattern
[SHIFT] + [3] (CLEAR)	Clear Song
[SHIFT] + [4] (COPY)	Copy Song
[SHIFT] + [START]	Start Performance

## Pattern Play Mode

Operation	Purpose
[TEMPO/VALUE]	Select Pattern
Numeric Keys → [ ►/ENTER ]	Select Pattern
[SHIFT] + [5] (KEY TRANS)	Confirm Key Transpose Settings
[SHIFT] + [9] (BEAT)	Confirm Beat
[SHIFT] + [0] (MEASURE)	Confirm Measures

## Pattern Edit Mode

Operation	Purpose
[TEMPO/VALUE]	Select Pattern/Change Values
Numeric Keys → [ ►/ENTER ]	Select Pattern
[SHIFT] + [5] (KEY TRANS)	Key Transpose Settings
[SHIFT] + [9] (BEAT)	Beat Settings
[SHIFT] + [0] (MEASURE)	Measure Settings
[SHIFT] + [2] (DELETE)	Delete Instrument
[SHIFT] + [3] (CLEAR)	Clear Pattern
[SHIFT] + [4] (COPY)	Copy Pattern

## DPP Assign Mode

Operation	Purpose
[TEMPO/VALUE]	Select Pattern



# Parameter List

Parameters marked with an asterisk (\*) are not saved. These are reset each time the DR-670's power is turned on.

Parameter	Display	Value	Reset Value
<b>System</b>			
Mode*		SONG PLAY, SONG EDIT, PATTERN PLAY, PATTERN EDIT, DRUM KIT EDIT, DPP ASSIGN, UTILITY, MIDI, DEMO	PATTERN PLAY
Pattern Number*		1–400	1
Song Beat*	RPT	OFF, ON	OFF
Drum Kit	KIT	1–128	9
Pad*		DRUM A, DRUM B, BASSS, DPP	DRUM A
Scale*	SCAL	32, 16 (triplets), 16, 8 (triplets), 8	16
Quantize*	QNTZ	OFF, 32, 16 (triplets), 16, 8 (triplets), 8	16
Fred Shift*	FRET	-5– +16	0
<b>Song</b>			
Song Chain	CHN	OFF, 1–100	OFF
Initial Tempo	INIT	OFF, 20–260	OFF
<b>Pattern</b>			
Beat	BEAT	2/4–8/4, 4/8–16/8	4/4
Measure	MEAS	1, 2	2
Drum Kit	KIT	1–128	
Key Transpose	KEY	-12– +12	0
<b>Drum Kit (Drum Part)</b>			
Instrument	INST	Refer to Instrument List (p. 99)	
Level	LVL	0–15	
Pitch	PTCH	-1200– +1200 (step:10)	
Decay	DCAY	-31– + 31	
Nuance	NUAN	-7– + 7	
Pan	PAN	L3–CNTR–R3	
Assign	ASGN	POLY, EX1P–EX7P, MONO, EX1M–EX7M	
<b>Drum Kit (Bass Part)</b>			
Tone	TONE	Refer to Bass Tone List (p. 101)	
Level	LVL	0–15	
Attack	ATCK	0–15	
Decay	DCAY	-31– +31	
Release	RELS	-7– +7	
Pan	PAN	L3–CNTR–R3	

<b>DPP Assign (Pads 1–16)</b>			
Pattern Number		1–400	
<b>Utility</b>			
Output Part*	OUT PART	ALL, DRUM, BASS	ALL
Foot Switch 1	FT SW 1	STRT, FILL, CONT, RSET, REC, CHAS, PD 1–PD16, PDG, PDD, PDA, PDE	STRT
Foot Switch 2	FT SW 2	STRT, FILL, CONT, REC, RSET, CHAS, PD 1–PD16, PDG, PDD, PDA, PDE	FILL
Roll Type	ROL TYPE	32, 16 (triplets), 16, 8 (triplets), 8	32
Flam Interval	FLM INT	0–31	16
Flam Ratio	FLM RATI	0–10	5
Pad Sensitivity	PAD SENS	0–10	5
Clock Level	CLK LVL	0–15	15
Click Beat*	CLK BEAT	8, 4	4
Master Tune	MST TUNE	438–445	440
<b>MIDI</b>			
Sync Mode*	SYNC	AUTO, INT, MIDI	AUTO
Drum Part MIDI Channel	CH DRUM	1–16, OFF	OFF
Bass Part MIDI Channel	CH BASS	1–16, OFF	OFF
Device ID	DEV ID	17–32	17
Bulk Damp	TX BLK	ALL, SEQ, UTIL, KIT	
Bulk Road	RX BLK		

# Instrument/Bass Tone List

## Instrument

Display	Instrument	Voice
* KC1	attack kick	2
KC2	real dry kick	1
* KC3	dry kick	2
* KC4	dry medium kick	2
* KC5	dry hard kick	2
* KC6	heavy kick	2
* KC7	pillow kick	2
* KC8	vintage kick 1	2
* KC9	vintage kick 2	2
* KC10	jazz kick 1	2
* KC11	jazz kick 2	2
* KC12	maple kick	2
* KC13	maple pillow kick	2
* KC14	maple reverb kick	2
* KC15	real kick	2
* KC16	26" deep kick	2
KC17	medium kick 1	1
* KC18	medium kick 2	2
* KC19	big low kick	2
* KC20	wood beater kick	2
* KC21	hybrid kick 1	2
KC22	hybrid kick 2	1
* KC23	ambient kick	2
KC24	boomer kick	1
KC25	comp kick 1	1
KC26	comp kick 2	1
* KC27	deep kick	2
KC28	reverb kick 1	1
* KC29	reverb kick 2	2
* KC30	room kick	2
* KC31	deep room kick	2
* KC32	mondo reverb kick	2
* KC33	mondo deep kick	2
* KC34	easy kick	2
* KC35	soft acoustic kick	2
* KC36	solid kick	2
* KC37	electronic kick 1	2
* KC38	electronic kick 2	2
* KC39	house kick	2
* KC40	dance kick	2
* KC41	rap kick 1	2
* KC42	rap kick 2	2
KC43	plastic kick	1
* KC44	gubba kick	2
KC45	jungle kick	1
* KC46	TR-808 kick 1	2

Display	Instrument	Voice
* KC47	TR-808 kick 2	2
* KC48	808 electronic kick	2
* KC49	808 boom kick	2
* KC50	TR-909 kick 1	2
KC51	TR-909 kick 2	1
* KC52	909 hard kick	2
* SN1	medium snare soft	2
* SN2	medium snare rim shot	2
* SN3	steel snare hard	2
* SN4	steel snare rim shot	2
* SN5	beech snare soft	2
* SN6	beech snare rim shot	2
* SN7	piccolo snare soft	2
* SN8	piccolo snare Hard	2
* SN9	high piccolo snare	2
* SN10	open rim shot snare	2
* SN11	slam dry snare soft	2
*** SN12	slam dry snare hard	2
*** SN13	slam room snare soft	2
*** SN14	slam room snare hard	2
*** SN15	dry hard snare	2
*** SN16	ring hard snare	2
*** SN17	rock-on snare	2
*** SN18	funk snare	2
SN19	sharp snare	1
*** SN20	warm hard snare	2
SN21	dry fat snare	1
SN22	snappy snare	1
SN23	dry snare soft	1
SN24	dry snare hard	1
*** SN25	wet snare	2
* SN26	L.A.fat snare	2
* SN27	acoustic rim shot snare	2
* SN28	ambient snare	2
* SN29	attack snare	2
* SN30	big shot snare	2
* SN31	hall snare	2
* SN32	hard snare	2
* SN33	light maple snare	2
* SN34	loose snare	2
SN35	natural snare	1
SN36	power snare	1
* SN37	rockin' snare	2
* SN38	rock rim shot snare	2
* SN39	real snare	2
*** SN40	rock snare 1	2

## Instrument/Bass Tone List

Display	Instrument	Voice	Display	Instrument	Voice
* SN41	rock snare 2	2	* TM22	real tom 2	2
* SN42	ring maple snare	2	* TM23	ring tom1	2
SN43	brush roll snare 1	1	* TM24	ring tom2	2
* SN44	brush roll snare 2	2	* TM25	room tom 1	2
* SN45	brush slap snare 1	2	* TM26	room tom 2	2
* SN46	brush slap snare 2	2	* TM27	rock tom 1	2
* SN47	brush slap snare 3	2	* TM28	rock tom 2	2
* SN48	brush swish snare	2	* TM29	electronic tom 1	2
* SN49	reggae snare	2	* TM30	electronic tom 2	2
* SN50	swing snare	2	* TM31	TR-808 tom	2
* SN51	90's snare	2	* TM32	TR-909 tom	2
* SN52	dance snare	2	** HH1	pure closed hi-hat	2
* SN53	dopin' snare	2	** HH2	pure open hi-hat	2
* SN54	house snare	2	** HH3	pedal closed hi-hat	2
* SN55	house dopin' snare	2	** HH4	16" closed hi-hat	2
SN56	jungle tiny snare	1	** HH5	16" half open hi-hat	2
* SN57	electronic snare 1	2	HH6	16" open hi-hat	1
* SN58	electronic snare 2	2	HH7	16" pedal closed hi-hat	1
* SN59	TR-808 snare 1	2	** HH8	pop closed hi-hat	2
SN60	TR-808 snare 2	1	** HH9	pop open hi-hat	2
* SN61	TR-909 snare	2	** HH10	real closed hi-hat	2
STK1	ambient cross stick	1	** HH11	real open hi-hat	2
*** STK2	hall cross stick	2	HH12	brush closed hi-hat	1
STK3	natural cross stick	1	HH13	brush open hi-hat	1
STK4	metal cross stick	1	** HH14	TR-808 closed hi-hat	2
STK5	TR-808 cross stick	1	** HH15	TR-808 open hi-hat	2
STK6	TR-909 cross stick	1	HH16	TR-909 closed hi-hat	1
* TM1	studio tom 1 soft	2	HH17	TR-909 open hi-hat	1
* TM2	studio tom 1 hard	2	HH18	CR-78 closed hi-hat	1
* TM3	studio tom 2 soft	2	HH19	CR-78 open hi-hat	1
* TM4	studio tom 2 hard	2	CY1	crash cymbal 1	1
* TM5	vintage tom 1	2	CY2	crash cymbal 2	1
* TM6	vintage tom 2	2	CY3	crash cymbal 3	1
* TM7	jazz tom 1	2	CY4	soft crash cymbal	1
* TM8	jazz tom 2	2	** CY5	pgy crash cymbal	2
* TM9	fusion tom 1	2	CY6	splash cymbal	1
* TM10	fusion tom 2	2	CY7	chinese cymbal	1
* TM11	bowl tom 1	2	** CY8	ride cymbal 1	2
* TM12	bowl tom 2	2	** CY9	ride cymbal 2	2
* TM13	ambient tom 1	2	** CY10	sizzle ride cymbal	2
* TM14	ambient tom 2	2	** CY11	ride bell cymbal 1	2
* TM15	brush slap tom 1	2	** CY12	ride bell cymbal 2	2
* TM16	brush slap tom 2	2	CY13	brush crash cymbal	1
* TM17	double head tom 1	2	CY14	brush ride cymbal	1
* TM18	double head tom 2	2	CY15	large gong	1
* TM19	light tom 1	2	CY16	TR-808 cymbal	1
* TM20	light tom 2	2	CY17	TR-606 cymbal	1
* TM21	real tom 1	2	** PC1	cowbell	2

Display	Instrument	Voice
PC2	tambourine	1
PC3	sleigh bell	1
PC4	castanet	1
PC5	triangle open	1
PC6	woodblock	1
* PC7	bongo high	2
* PC8	bongo low	2
* PC9	conga high mute	2
* PC10	conga high slap	2
* PC11	conga high open	2
* PC12	conga low open	2
* PC13	timbale high	2
* PC14	timbale low	2
PC15	timbale side	1
* PC16	claves	2
PC17	vibraslap	1
PC18	guiro short	1
PC19	guiro long	1
PC20	maracas	1
PC21	shaker	1
PC22	cabasa	1
PC23	samba whistle short	1
PC24	samba whistle long	1
** PC25	agogo	2
PC26	cuica high	1
PC27	cuica low	1
* PC28	surdo mute	2
* PC29	surdo open	2
** PC30	tabla 1	2
PC31	tabla 2	1
** PC32	tabla 3	2
PC33	real clap	1
PC34	DR-55 claves	1
PC35	CR-78 cowbell	1
PC36	CR-78 metallic beat	1
PC37	CR-78 guiro	1
PC38	CR-78 tambourine	1
PC39	CR-78 maracas	1
* PC40	TR-808 conga	2
PC41	TR-808 claves	1
PC42	TR-808 maracas	1
PC43	TR-808 hand clap	1
PC44	TR-808 cowbell	1
** FX1	scratch 1	2
** FX2	scratch 2	2
** FX3	scratch snare	2
FX4	jungle hat	1
** FX5	high-Q	2

Display	Instrument	Voice
FX6	tape rewind	1
FX7	philly hit	1
FX8	dance shaker	1
** FX9	beam high-Q	2
FX10	metal sweep	1
** FX11	analog bird	2
** FX12	sound effect	2
** FX13	reverse snare	2
** FX14	reverse tom	2
FX15	reverse cymbal	1
*** FX16	kick ambience	2
*** FX17	snare ambience	2
*** FX18	tom ambience	2
*** FX19	long reverb	2
*** FX20	gate reverb	2
* BS1	acoustic bass	2
BS2	fingered bass	1
BS3	slap bass	1
BS4	TB-303 bass	1
BS5	bass glissando	1

## Bass Tone

Display	Instrument	Voice
FNG1	Fingered Bass 1	1
FNG2	Fingered Bass 2	1
MTB	Mute Bass	1
FRLS	Fretless Bass	1
PIC1	Picked Bass 1	1
PIC2	Picked Bass 2	1
ACO1	Acoustic Bass 1	1
ACO2	Acoustic Bass 2	1
SLAP	Slap Bass	1
STCK	Stick	1
MGB	MG Bass Pedal	1
OBB	OB Bass	1
101	101 Bass	1
SLD	Solid Bass	1
PLCK	Pluck Bass	1
SINE	Sine Wave Bass	1

\* The sound will alter depending on the strength you strike the pads or the Nuance setting (p. 81).

\*\* The sound will alter depending on the Nuance setting.

\*\*\* The Pan setting (p. 81) will be ignored.

# Preset Drum Kit List

	No. 1 Standrd	No. 2 Room 1	No. 3 Power 1	No. 4 Elctro1	No. 5 TR808 1	No. 6 Jazz 1	No. 7 Brushes	No. 8 Ambient
<b>Pad No.</b>	<b>Instrument</b>	<b>Instrument</b>	<b>Instrument</b>	<b>Instrument</b>	<b>Instrument</b>	<b>Instrument</b>	<b>Instrument</b>	<b>Instrument</b>
<b>A 1</b>	CY1	CY1	CY1	CY1	CY16	CY4	CY13	CY1
<b>A 2</b>	CY2	CY3	CY2	CY17	CY17	CY2	CY14	CY2
<b>A 3</b>	CY12	CY12	CY12	CY11	CY12	CY11	CY11	CY12
<b>A 4</b>	CY9	CY9	CY9	CY9	CY9	CY10	CY14	CY8
<b>A 5</b>	TM1	TM25	TM13	TM29	TM31	TM7	TM15	TM27
<b>A 6</b>	TM1	TM25	TM13	TM29	TM31	TM7	TM15	TM27
<b>A 7</b>	TM1	TM25	TM13	TM29	TM31	TM8	TM15	TM28
<b>A 8</b>	TM3	TM26	TM14	TM29	TM31	TM8	TM16	TM28
<b>A 9</b>	STK3	STK1	CY7	STK6	STK5	STK3	STK3	STK1
<b>A10</b>	SN1	CY6	CY15	PC43	PC43	SN27	SN45	SN32
<b>A11</b>	PC1	PC1	PC1	SN58	PC44	PC1	SN44	PC1
<b>A12</b>	HH3	HH3	HH7	HH14	HH15	HH3	HH3	HH7
<b>A13</b>	KC4	KC30	KC33	KC37	KC46	KC11	KC10	KC36
<b>A14</b>	SN2	SN37	SN41	SN57	SN59	SN34	SN48	SN29
<b>A15</b>	HH1	HH10	HH5	HH14	HH14	HH1	HH12	HH4
<b>A16</b>	HH2	HH11	HH6	HH15	HH15	HH2	HH13	HH6
<b>B 1</b>	PC22	PC22	PC22	PC22	PC22	PC22	PC22	PC22
<b>B 2</b>	CY7	PC16	PC16	PC16	PC41	PC16	PC16	PC16
<b>B 3</b>	PC20	PC20	PC20	PC20	PC42	PC20	PC20	PC20
<b>B 4</b>	PC17	PC17	PC17	PC17	PC17	PC17	PC17	CY7
<b>B 5</b>	PC25	PC25	PC25	PC25	PC25	PC25	PC25	FX18
<b>B 6</b>	PC25	PC25	PC25	PC25	PC25	PC25	PC25	FX18
<b>B 7</b>	PC18	PC18	PC18	PC18	PC37	PC18	PC18	FX18
<b>B 8</b>	PC19	PC19	PC19	PC19	PC37	PC19	PC19	FX18
<b>B 9</b>	PC7	PC7	PC7	PC7	PC7	PC7	PC7	BS5
<b>B10</b>	PC8	PC8	PC8	PC8	PC8	PC8	PC8	FX17
<b>B11</b>	PC14	PC14	PC14	PC14	PC14	PC14	PC14	PC14
<b>B12</b>	PC13	PC13	PC13	PC13	PC13	PC13	PC13	PC13
<b>B13</b>	PC2	KC27	PC2	PC2	PC38	SN7	KC35	FX16
<b>B14</b>	PC9	PC9	SN30	PC9	PC40	PC9	PC9	FX17
<b>B15</b>	PC11	PC11	PC11	PC11	PC40	PC11	PC11	PC11
<b>B16</b>	PC12	PC12	PC12	PC12	PC40	PC12	PC12	PC12
<b>BASS</b>	FNG1	PIC1	PIC1	OBB	101	ACO1	ACO1	FNG2

	<b>No. 9</b>	<b>No. 10</b>	<b>No. 11</b>	<b>No. 12</b>	<b>No. 13</b>	<b>No. 14</b>	<b>No. 15</b>	<b>No. 16</b>
	Big	Exprsn	Power 2	Loud	Studio	Power 3	TR808 2	TR909
<b>Pad No.</b>	Instrument	Instrument	Instrument	Instrument	Instrument	Instrument	Instrument	Instrument
<b>A 1</b>	CY1	CY1	CY1	CY1	CY1	CY1	CY16	CY17
<b>A 2</b>	CY2	CY2	CY2	CY3	CY2	CY2	HH19	CY16
<b>A 3</b>	CY11	CY11	CY12	CY11	CY12	CY12	CY12	CY12
<b>A 4</b>	CY9	CY9	CY9	CY7	CY9	CY9	CY9	CY9
<b>A 5</b>	TM5	TM2	TM2	TM27	TM2	TM21	TM31	TM32
<b>A 6</b>	TM5	TM2	TM2	TM27	TM2	TM21	TM31	TM32
<b>A 7</b>	TM6	TM2	TM2	TM28	TM2	TM21	TM31	TM32
<b>A 8</b>	TM6	TM4	TM4	TM28	TM4	TM22	TM31	TM32
<b>A 9</b>	STK3	STK1	STK2	STK2	STK3	STK1	STK5	STK6
<b>A10</b>	SN5	SN8	CY7	SN12	SN1	SN30	PC43	SN50
<b>A11</b>	PC1	PC1	PC1	PC1	PC1	PC1	PC44	PC44
<b>A12</b>	HH7	HH3	HH7	HH3	HH7	HH7	HH15	HH17
<b>A13</b>	KC16	KC3	KC28	KC1	KC9	KC18	KC47	KC52
<b>A14</b>	SN6	SN2	SN28	SN20	SN10	SN25	SN60	SN61
<b>A15</b>	HH4	HH1	HH5	HH1	HH4	HH5	HH14	HH16
<b>A16</b>	HH5	HH2	HH6	HH2	HH6	HH6	HH15	HH17
<b>B 1</b>	PC22	CY4	PC22	PC22	PC22	CY1	PC22	PC22
<b>B 2</b>	PC16	CY4	PC16	PC16	CY6	CY2	PC41	PC41
<b>B 3</b>	PC20	CY11	PC20	PC20	CY7	CY12	PC42	PC42
<b>B 4</b>	PC17	CY9	PC17	PC17	CY8	CY7	PC17	PC17
<b>B 5</b>	PC25	TM1	PC25	PC25	PC25	TM13	PC25	PC25
<b>B 6</b>	PC25	TM1	PC25	PC25	PC25	TM13	PC25	PC25
<b>B 7</b>	PC18	TM1	PC18	PC18	PC18	TM13	PC37	PC37
<b>B 8</b>	PC19	TM3	PC19	PC19	PC19	TM14	PC37	PC37
<b>B 9</b>	PC7	STK1	PC7	PC7	KC5	PC7	PC7	PC7
<b>B10</b>	PC8	SN7	PC8	PC8	SN35	PC8	PC8	PC8
<b>B11</b>	PC14	PC1	PC14	PC14	PC14	PC14	PC14	PC14
<b>B12</b>	PC13	HH3	PC13	PC13	PC13	PC13	PC13	PC13
<b>B13</b>	PC2	KC12	KC24	PC2	PC2	PC2	PC38	PC38
<b>B14</b>	PC9	SN1	PC9	PC9	PC9	PC9	PC40	PC40
<b>B15</b>	PC11	HH1	PC11	PC11	PC11	PC11	PC40	PC40
<b>B16</b>	PC12	HH2	PC12	PC12	PC12	PC12	PC40	PC40
<b>BASS</b>	STCK	FNG2	PIC2	PIC1	FNG1	PIC1	MTB	MTB

	<b>No. 17</b>	<b>No. 18</b>	<b>No. 19</b>	<b>No. 20</b>	<b>No. 21</b>	<b>No. 22</b>	<b>No. 23</b>	<b>No. 24</b>
	Dance 1	Rock	Funk 1	Funk 2	HipHop	House	DrumBs	Techno
<b>Pad No.</b>	<b>Instrument</b>	<b>Instrument</b>	<b>Instrument</b>	<b>Instrument</b>	<b>Instrument</b>	<b>Instrument</b>	<b>Instrument</b>	<b>Instrument</b>
<b>A 1</b>	CY3	CY1	CY2	CY2	CY1	CY2	CY2	CY2
<b>A 2</b>	CY3	CY4	CY2	CY5	CY2	CY17	CY17	CY17
<b>A 3</b>	CY12	CY12	CY12	CY11	CY12	CY12	CY12	CY12
<b>A 4</b>	CY9	CY8	CY8	CY8	CY8	CY9	CY9	CY9
<b>A 5</b>	TM2	TM21	TM5	TM21	TM1	TM31	TM32	TM32
<b>A 6</b>	TM2	TM21	TM5	TM21	TM1	TM31	TM32	TM32
<b>A 7</b>	TM2	TM22	TM5	TM21	TM1	TM31	TM32	TM32
<b>A 8</b>	TM2	TM22	TM6	TM22	TM3	TM31	TM32	TM32
<b>A 9</b>	STK1	STK1	STK3	STK1	STK3	STK5	STK5	STK6
<b>A10</b>	PC43	PC43	SN1	SN38	PC33	PC43	PC43	PC43
<b>A11</b>	PC35	PC1	PC1	PC1	PC1	PC44	PC44	PC44
<b>A12</b>	HH14	HH3	HH3	HH3	HH3	HH7	FX4	HH3
<b>A13</b>	KC39	KC26	KC4	KC22	KC4	KC51	KC51	KC51
<b>A14</b>	SN54	SN35	SN6	SN18	SN9	SN61	SN54	SN61
<b>A15</b>	HH18	HH10	HH1	HH10	HH1	HH16	HH18	HH16
<b>A16</b>	HH19	HH13	HH2	HH11	HH2	HH17	HH19	HH17
<b>B 1</b>	PC22	PC22	PC22	PC22	PC22	PC22	PC22	PC22
<b>B 2</b>	PC16	PC16	CY6	CY6	PC16	PC41	PC41	PC41
<b>B 3</b>	PC20	PC20	PC20	PC20	PC20	PC42	PC42	PC42
<b>B 4</b>	PC17	PC17	CY7	CY7	PC17	PC17	CY6	CY6
<b>B 5</b>	PC25	PC25	PC6	PC25	TM29	PC25	FX8	PC36
<b>B 6</b>	PC25	PC25	PC6	PC25	TM29	PC25	FX8	PC36
<b>B 7</b>	PC18	FX9	TM1	PC5	TM29	PC37	PC37	PC37
<b>B 8</b>	PC19	FX1	TM3	PC5	TM29	PC37	PC37	PC37
<b>B 9</b>	PC7	PC7	KC5	KC25	SN52	KC39	PC34	SN60
<b>B10</b>	PC8	PC8	SN5	PC8	CY15	SN60	SN60	PC33
<b>B11</b>	PC14	PC14	PC5	PC14	PC14	HH19	FX15	PC33
<b>B12</b>	PC13	PC13	PC5	PC13	PC13	HH15	KC49	HH19
<b>B13</b>	PC2	PC2	PC2	PC2	PC2	PC38	KC44	PC38
<b>B14</b>	PC9	PC9	PC9	PC9	SN6	PC40	PC40	PC40
<b>B15</b>	PC10	PC10	PC11	PC11	PC11	PC40	PC40	PC40
<b>B16</b>	PC12	PC12	PC12	PC12	PC12	PC40	PC40	PC40
<b>BASS</b>	SLD	PIC2	SLAP	STCK	SLD	SLD	SINE	PLCK



	<b>No. 25</b> Brazil	<b>No. 26</b> India	<b>No. 27</b> Room 2	<b>No. 28</b> Room 3	<b>No. 29</b> Fusion	<b>No. 30</b> Natural	<b>No. 31</b> Ballad	<b>No. 32</b> Groove
<b>Pad No.</b>	Instrument	Instrument	Instrument	Instrument	Instrument	Instrument	Instrument	Instrument
<b>A 1</b>	CY1	CY1	CY1	CY2	CY1	CY1	CY1	CY1
<b>A 2</b>	CY2	CY2	CY2	CY5	CY2	CY2	CY2	CY3
<b>A 3</b>	CY12	CY12	CY12	CY11	CY12	CY11	CY11	CY12
<b>A 4</b>	CY9	CY9	CY9	CY8	CY9	CY8	CY8	CY9
<b>A 5</b>	PC9	PC30	TM13	TM27	TM9	TM21	TM5	TM25
<b>A 6</b>	PC10	PC30	TM13	TM27	TM9	TM21	TM5	TM25
<b>A 7</b>	PC11	PC31	TM14	TM28	TM10	TM22	TM6	TM25
<b>A 8</b>	PC11	PC32	TM14	TM28	TM10	TM22	TM3	TM26
<b>A 9</b>	PC12	STK3	STK2	STK1	STK1	STK3	STK3	STK3
<b>A10</b>	PC16	PC43	PC43	PC43	CY6	SN23	SN2	PC43
<b>A11</b>	PC2	PC1	PC1	PC1	PC1	PC1	PC1	PC1
<b>A12</b>	HH3	HH3	HH3	HH3	HH3	HH3	HH7	HH3
<b>A13</b>	KC10	KC35	KC17	KC31	KC7	KC25	KC16	KC25
<b>A14</b>	SN4	SN27	SN11	SN14	SN3	SN35	SN1	SN26
<b>A15</b>	HH1	HH1	HH1	HH10	HH1	HH1	HH4	HH10
<b>A16</b>	HH2	HH2	HH2	HH11	HH9	HH2	HH6	HH11
<b>B 1</b>	PC22	PC22	PC22	PC22	PC22	PC22	PC22	PC22
<b>B 2</b>	PC22	PC16	PC16	PC16	PC16	PC16	PC16	PC16
<b>B 3</b>	PC20	PC20	PC20	PC20	PC20	PC20	PC20	PC20
<b>B 4</b>	PC17	PC2	PC17	PC17	PC17	CY7	PC17	PC17
<b>B 5</b>	PC25	PC25	PC6	PC25	PC25	PC25	PC25	PC25
<b>B 6</b>	PC25	PC25	PC6	PC25	PC25	PC25	PC25	PC25
<b>B 7</b>	PC18	PC18	PC5	PC18	PC18	PC18	PC18	PC35
<b>B 8</b>	PC19	PC19	PC5	PC19	PC19	PC19	PC19	FX8
<b>B 9</b>	PC7	PC7	PC7	PC7	PC7	KC26	PC7	PC7
<b>B10</b>	PC8	PC8	SN38	PC8	PC8	SN22	PC8	PC8
<b>B11</b>	PC14	PC14	PC14	PC14	PC14	PC14	PC14	PC14
<b>B12</b>	PC13	PC13	PC13	PC13	PC13	PC13	PC13	PC13
<b>B13</b>	PC15	KC5	PC2	PC2	PC2	PC2	PC2	PC2
<b>B14</b>	PC22	PC9	PC9	PC9	PC9	PC9	PC9	PC9
<b>B15</b>	PC1	PC11	PC11	PC11	PC11	PC11	PC11	PC11
<b>B16</b>	PC1	PC12	PC12	PC12	PC12	PC12	PC12	PC12
<b>BASS</b>	FNG2	ACO2	FNG1	PIC2	PIC1	PIC2	FRLS	SLAP

Preset Drum Kit List

	<b>No. 33</b>	<b>No. 34</b>	<b>No. 35</b>	<b>No. 36</b>	<b>No. 37</b>	<b>No. 38</b>	<b>No. 39</b>	<b>No. 40</b>
	Boom	Jazz 2	Afro 1	HvyFunk	Folk	Samba 1	Blues	Gospel
<b>Pad No.</b>	<b>Instrument</b>	<b>Instrument</b>	<b>Instrument</b>	<b>Instrument</b>	<b>Instrument</b>	<b>Instrument</b>	<b>Instrument</b>	<b>Instrument</b>
<b>A 1</b>	CY17	CY4	CY3	CY1	CY4	CY1	CY1	CY1
<b>A 2</b>	CY17	CY2	CY6	CY2	CY13	CY2	CY3	CY2
<b>A 3</b>	CY11	CY11	CY12	CY11	CY12	CY12	CY12	CY12
<b>A 4</b>	CY9	CY10	CY9	CY9	CY14	CY9	CY10	CY9
<b>A 5</b>	TM29	TM17	TM2	TM21	TM19	PC24	TM7	TM17
<b>A 6</b>	TM29	TM17	TM2	TM21	TM19	TM1	TM7	TM17
<b>A 7</b>	TM29	TM18	TM2	TM21	TM19	TM1	TM7	TM17
<b>A 8</b>	TM29	TM18	TM4	TM22	TM20	TM3	TM8	TM18
<b>A 9</b>	STK6	STK3	STK3	STK3	STK3	PC23	STK2	SN23
<b>A10</b>	PC43	SN34	PC26	SN5	SN47	SN1	PC33	PC33
<b>A11</b>	PC1	PC1	PC1	PC1	PC33	PC29	PC2	PC1
<b>A12</b>	HH16	HH3	HH7	HH3	HH3	HH3	HH3	HH3
<b>A13</b>	KC50	KC16	KC39	KC18	KC35	KC5	KC11	KC12
<b>A14</b>	SN55	SN34	SN39	SN6	SN5	SN2	SN15	SN35
<b>A15</b>	HH16	HH1	HH4	HH1	HH1	HH1	HH1	HH1
<b>A16</b>	HH17	HH2	HH6	HH2	HH2	HH2	HH2	HH2
<b>B 1</b>	PC22	PC22	PC20	PC22	PC22	PC22	CY4	PC22
<b>B 2</b>	PC16	PC16	PC16	PC16	PC16	CY7	CY9	CY6
<b>B 3</b>	PC20	PC20	PC20	PC20	PC20	PC20	CY8	CY7
<b>B 4</b>	PC17	PC17	PC19	PC17	PC17	PC17	CY9	CY8
<b>B 5</b>	PC35	PC25	PC25	PC25	PC25	PC25	PC25	PC25
<b>B 6</b>	FX6	PC25	PC25	PC25	PC25	PC25	PC25	PC25
<b>B 7</b>	FX3	PC18	PC15	PC18	PC18	PC26	PC18	PC6
<b>B 8</b>	PC19	PC19	PC19	PC19	PC19	PC27	PC19	PC6
<b>B 9</b>	PC7	PC7	PC7	PC7	PC7	PC5	PC7	PC7
<b>B10</b>	PC8	PC8	PC8	PC8	PC8	PC5	PC8	PC8
<b>B11</b>	PC14	PC14	PC12	PC14	PC14	PC14	PC14	PC14
<b>B12</b>	PC13	PC13	PC12	PC13	PC13	PC13	PC13	PC13
<b>B13</b>	PC2	PC2	PC2	PC2	PC2	PC2	BS5	PC2
<b>B14</b>	PC9	PC9	PC9	PC9	PC9	PC9	SN1	KC5
<b>B15</b>	PC11	PC11	PC11	PC11	PC11	PC11	PC11	PC11
<b>B16</b>	PC12	PC12	PC11	PC12	PC12	PC12	PC12	PC12
<b>BASS</b>	PLCK	ACO2	MTB	STCK	MTB	FING1	ACO2	FNG1

	<b>No. 41</b>	<b>No. 42</b>	<b>No. 43</b>	<b>No. 44</b>	<b>No. 45</b>	<b>No. 46</b>	<b>No. 47</b>	<b>No. 48</b>
	Jazz 3	BigFunk	Samba 2	Reggae	Salsa	Tabla	Elctro2	Vintage
<b>Pad No.</b>	Instrument	Instrument	Instrument	Instrument	Instrument	Instrument	Instrument	Instrument
<b>A 1</b>	CY1	CY1	CY1	CY6	CY1	CY1	CY2	CY1
<b>A 2</b>	CY2	CY7	CY2	CY3	CY3	CY6	CY6	CY2
<b>A 3</b>	CY12	CY12	CY12	CY12	CY12	CY12	CY11	CY11
<b>A 4</b>	CY9	CY9	CY9	CY9	CY9	CY9	CY8	CY8
<b>A 5</b>	TM7	TM21	PC23	TM23	PC10	PC30	TM30	TM11
<b>A 6</b>	TM7	TM21	PC24	TM23	TM17	PC30	TM30	TM11
<b>A 7</b>	TM7	TM21	PC28	TM23	TM17	PC32	TM30	TM12
<b>A 8</b>	TM8	TM22	PC29	TM24	TM18	PC31	TM30	TM12
<b>A 9</b>	STK2	STK2	STK3	STK3	STK3	PC32	STK2	STK2
<b>A10</b>	PC33	PC33	SN1	PC33	PC6	SN1	PC43	SN3
<b>A11</b>	PC2	PC2	PC1	PC1	PC1	PC1	PC1	PC1
<b>A12</b>	HH3	HH3	HH3	HH3	HH3	HH3	HH7	HH3
<b>A13</b>	KC11	KC12	KC12	KC25	KC9	KC22	KC38	KC12
<b>A14</b>	SN2	SN25	SN2	SN49	SN3	SN35	SN58	SN4
<b>A15</b>	HH1	HH10	HH1	HH1	HH1	HH1	HH10	HH1
<b>A16</b>	HH2	HH11	HH2	HH2	HH2	HH2	HH11	HH2
<b>B 1</b>	CY4	CY9	PC22	PC22	PC20	PC22	PC22	PC22
<b>B 2</b>	CY9	CY9	PC16	PC16	PC16	PC16	PC16	PC16
<b>B 3</b>	CY8	CY9	PC20	PC20	PC21	PC20	PC20	PC20
<b>B 4</b>	CY9	CY9	PC17	PC17	PC17	PC17	PC17	CY7
<b>B 5</b>	PC25	PC25	PC25	PC25	PC25	PC25	PC25	PC25
<b>B 6</b>	PC25	PC25	PC25	PC25	PC25	PC25	PC25	PC25
<b>B 7</b>	PC18	PC18	PC26	PC26	PC18	PC18	PC18	PC18
<b>B 8</b>	PC19	PC19	PC27	PC27	PC19	PC19	PC19	PC19
<b>B 9</b>	PC7	PC7	PC7	PC7	PC7	TM1	PC7	PC7
<b>B10</b>	PC8	PC8	PC8	PC8	PC8	TM1	PC8	PC8
<b>B11</b>	PC14	PC14	PC14	PC14	PC14	TM1	PC14	PC14
<b>B12</b>	PC13	PC13	PC13	PC13	PC13	TM3	PC13	PC13
<b>B13</b>	BS5	KC35	PC2	PC2	PC2	STK3	PC2	PC2
<b>B14</b>	SN1	SN15	PC9	PC9	PC9	PC7	PC9	PC9
<b>B15</b>	PC11	PC11	PC11	PC11	PC11	PC8	PC11	PC11
<b>B16</b>	PC12	PC12	PC12	PC12	PC12	PC2	PC12	PC12
<b>BASS</b>	ACO1	STCK	FRLS	MTB	ACO1	ACO2	101	FNG1

Preset Drum Kit List

	<b>No. 49</b>	<b>No. 50</b>	<b>No. 51</b>	<b>No. 52</b>	<b>No. 53</b>	<b>No. 54</b>	<b>No. 55</b>	<b>No. 56</b>
	Ring	Light	Afro 2	Dance 2	Delay	FIngDly	Drm&Prc	SFX
<b>Pad No.</b>	Instrument	Instrument	Instrument	Instrument	Instrument	Instrument	Instrument	Instrument
<b>A 1</b>	CY4	CY4	CY2	CY1	CY1	CY6	CY15	CY2
<b>A 2</b>	CY1	CY1	CY6	CY17	CY2	CY2	CY6	CY1
<b>A 3</b>	CY11	CY11	CY12	CY12	CY12	CY12	CY12	CY11
<b>A 4</b>	CY8	CY9	CY9	CY9	CY9	CY9	CY9	CY9
<b>A 5</b>	TM23	TM19	TM17	TM31	TM27	TM21	TM17	TM13
<b>A 6</b>	TM23	TM19	TM18	TM31	TM27	TM21	TM17	TM13
<b>A 7</b>	TM24	TM20	PC28	TM31	TM28	TM22	TM17	TM13
<b>A 8</b>	TM24	TM20	PC29	TM31	TM28	TM22	TM18	TM14
<b>A 9</b>	STK2	STK3	STK3	STK5	STK2	STK5	STK3	STK1
<b>A10</b>	SN33	SN47	SN4	SN55	SN36	PC43	PC26	SN11
<b>A11</b>	PC1	PC1	PC1	PC44	PC1	PC1	PC1	PC1
<b>A12</b>	HH3	HH3	HH3	FX4	HH3	HH3	HH3	HH7
<b>A13</b>	KC7	KC35	KC26	KC51	KC29	KC40	KC26	KC18
<b>A14</b>	SN42	SN27	SN3	SN56	SN31	SN53	SN9	SN14
<b>A15</b>	HH1	HH10	HH1	HH16	HH10	HH10	HH8	HH5
<b>A16</b>	HH2	HH11	HH2	HH17	HH11	HH11	HH9	HH6
<b>B 1</b>	PC22	PC22	PC22	FX8	PC22	PC22	BS5	FX5
<b>B 2</b>	PC16	PC16	PC16	PC41	PC16	PC16	FX10	FX5
<b>B 3</b>	PC20	PC20	PC20	PC42	PC20	PC20	PC25	FX6
<b>B 4</b>	PC17	PC17	PC17	FX11	PC17	PC17	PC3	FX7
<b>B 5</b>	PC25	PC25	PC5	PC25	PC25	PC25	PC7	FX8
<b>B 6</b>	PC25	PC25	PC5	PC25	PC25	PC25	PC7	FX9
<b>B 7</b>	PC18	PC18	PC25	PC37	PC18	PC18	PC13	FX9
<b>B 8</b>	PC19	PC19	PC25	PC1	PC19	PC19	PC14	FX10
<b>B 9</b>	PC7	PC7	PC7	FX7	PC7	PC7	PC23	FX11
<b>B10</b>	PC8	PC8	PC8	FX9	PC8	PC8	PC43	FX11
<b>B11</b>	PC14	PC14	PC14	KC49	PC14	PC14	FX9	FX19
<b>B12</b>	PC13	PC13	PC13	SN61	PC13	PC13	BS5	FX20
<b>B13</b>	PC2	PC2	PC2	PC2	PC2	PC2	PC30	FX12
<b>B14</b>	PC9	PC9	PC9	FX15	PC9	PC9	PC2	FX13
<b>B15</b>	PC11	PC11	PC11	PC3	PC11	PC11	PC36	FX14
<b>B16</b>	PC12	PC12	PC12	PC38	PC12	PC12	PC19	FX15
<b>BASS</b>	FNG2	MTB	ACO2	SINE	PLCK	FRLS	SLD	MGB

	<b>No. 57</b>	<b>No. 58</b>	<b>No. 59</b>	<b>No. 60</b>	<b>No. 61</b>	<b>No. 62</b>	<b>No. 63</b>	<b>No. 64</b>
	CtryBas	SmbaBas	BluzBas	RockBas	FunkBas	BrshBas	SynBass	AcoBass
<b>Pad No.</b>	<b>Instrument</b>	<b>Instrument</b>	<b>Instrument</b>	<b>Instrument</b>	<b>Instrument</b>	<b>Instrument</b>	<b>Instrument</b>	<b>Instrument</b>
<b>A 1</b>	CY1	CY1	CY1	CY2	CY1	CY13	CY17	CY4
<b>A 2</b>	CY2	CY2	CY3	CY7	CY7	CY4	CY1	CY2
<b>A 3</b>	CY12	CY12	CY12	CY11	CY12	CY12	CY12	CY11
<b>A 4</b>	CY9	CY9	CY10	CY9	CY9	CY14	CY9	CY10
<b>A 5</b>	TM21	TM1	TM7	TM13	TM1	TM15	TM32	TM7
<b>A 6</b>	TM21	TM1	TM7	TM13	TM1	TM15	TM32	TM7
<b>A 7</b>	TM21	TM1	TM7	TM13	TM1	TM15	TM32	TM8
<b>A 8</b>	TM22	TM3	TM8	TM14	TM3	TM16	TM32	TM8
<b>A 9</b>	STK3	STK3	STK3	STK1	STK3	STK3	STK6	STK3
<b>A10</b>	PC33	SN1	SN1	SN11	SN23	SN45	SN50	SN27
<b>A11</b>	PC1	PC1	PC1	PC1	PC1	PC1	PC44	PC1
<b>A12</b>	HH3	HH3	HH3	HH7	HH3	HH3	HH17	HH3
<b>A13</b>	KC12	KC4	KC11	KC18	KC12	KC8	KC52	KC11
<b>A14</b>	SN21	SN2	SN15	SN14	SN25	SN44	SN61	SN34
<b>A15</b>	HH10	HH1	HH1	HH5	HH10	HH1	HH16	HH1
<b>A16</b>	HH11	HH2	HH2	HH6	HH11	HH2	HH17	HH2
<b>B 1</b>	BS1	PC22	BS2	BS3	BS3	BS1	BS4	BS1
<b>B 2</b>	BS1	PC16	BS2	BS3	BS3	BS1	BS4	BS1
<b>B 3</b>	BS1	PC20	BS2	BS3	BS3	BS1	BS4	BS1
<b>B 4</b>	BS1	PC17	BS2	BS3	BS3	BS1	BS4	BS1
<b>B 5</b>	BS1	BS1	BS2	BS3	BS3	BS1	BS4	BS1
<b>B 6</b>	BS1	BS1	BS2	BS3	BS3	BS1	BS4	BS1
<b>B 7</b>	BS1	BS1	BS2	BS3	BS3	BS1	BS4	BS1
<b>B 8</b>	BS1	BS1	BS2	BS3	BS3	BS1	BS4	BS1
<b>B 9</b>	BS1	PC7	BS2	BS3	BS3	BS1	BS4	BS1
<b>B10</b>	BS1	PC8	BS2	BS3	BS3	BS1	BS4	BS1
<b>B11</b>	BS1	PC14	BS2	BS3	BS3	BS1	BS4	BS1
<b>B12</b>	BS1	PC13	BS2	BS3	BS3	BS1	BS4	BS1
<b>B13</b>	BS1	PC2	BS2	BS3	BS3	BS1	BS4	BS1
<b>B14</b>	BS1	PC9	BS2	BS3	BS3	BS1	BS4	BS1
<b>B15</b>	BS1	PC11	BS2	BS3	BS3	BS1	BS4	BS1
<b>B16</b>	BS1	PC12	BS2	BS3	BS3	BS1	BS4	BS1
<b>BASS</b>	FNG1	FNG1	FNG2	PIC1	SLAP	ACO2	OBB	ACO1

# Preset Pattern List

(Recommend)		
No.	Tempo	Pattern
001	136	Hard Rock 1-1
002	136	Hard Rock 1-2
003	120	Hard Rock 2-1
004	120	Hard Rock 2-2
005	120	Hard Rock 3-1
006	120	Hard Rock 3-2
007	120	Hard Rock 4-1
008	120	Hard Rock 4-2
009	160	Hard Rock 5-1
010	160	Hard Rock 5-2
011	162	Hard Rock 6-1
012	162	Hard Rock 6-2
013	110	Hard Rock 7-1
014	110	Hard Rock 7-2
015	120	Heavy Metal 1-1
016	120	Heavy Metal 1-2
017	130	Heavy Metal 2-1
018	130	Heavy Metal 2-2
019	120	Fast Hard Rock 1
020	120	Fast Hard Rock 2
021	100	Punk Bass 1
022	100	Punk Bass 2
023	120	Rock 1-1
024	120	Rock 1-2
025	130	Rock 2-1
026	130	Rock 2-2
027	130	Rock 3-1
028	130	Rock 3-2
029	140	Rock 4-1
030	140	Rock 4-2
031	156	Rock 5-1
032	156	Rock 5-2
033	170	Rock 6-1
034	170	Rock 6-2
035	93	Rock 7-1
036	93	Rock 7-2
037	120	Rock 8-1
038	120	Rock 8-2
039	110	Acoustic Rock 1
040	110	Acoustic Rock 2

(Recommend)		
No.	Tempo	Pattern
041	130	Electronic Rock 1
042	130	Electronic Rock 2
043	90	Rock Bass 1
044	90	Rock Bass 2
045	120	8th Note Feel 1-1
046	120	8th Note Feel 1-2
047	120	8th Note Feel 2-1
048	120	8th Note Feel 2-2
049	120	8th Note Feel 3-1
050	120	8th Note Feel 3-2
051	120	16th Note Feel 1-1
052	120	16th Note Feel 1-2
053	120	16th Note Feel 2-1
054	120	16th Note Feel 2-2
055	130	Shuffle 1
056	130	Shuffle 2
057	120	6/8 Feel 1
058	120	6/8 Feel 2
059	104	Ballade 1-1
060	104	Ballade 1-2
061	120	Ballade 2-1
062	120	Ballade 2-2
063	80	Rockabilly 1
064	80	Rockabilly 2
065	125	Bluegrass 1
066	125	Bluegrass 2
067	120	Country 1-1
068	120	Country 1-2
069	120	Country 2-1
070	120	Country 2-2
071	100	Country Bass 1
072	100	Country Bass 2
073	150	Funk 1-1
074	150	Funk 1-2
075	120	Funk 2-1
076	120	Funk 2-2
077	120	Funk 3-1
078	120	Funk 3-2
079	114	Funk 4-1
080	114	Funk 4-2

(Recommend)		
No.	Tempo	Pattern
081	112	Funk Bass 1
082	112	Funk Bass 2
083	120	Blues 1
084	120	Blues 2
085	120	Medium Blues 1
086	120	Medium Blues 2
087	100	6/8 Blues 1
088	100	6/8 Blues 2
089	114	Soul 1-1
090	114	Soul 1-2
091	125	Soul 2-1
092	125	Soul 2-2
093	90	Soul 3-1
094	90	Soul 3-2
095	120	Gospel 1-1
096	120	Gospel 1-2
097	120	Gospel 2-1
098	120	Gospel 2-2
099	120	Jazz 1-1
100	120	Jazz 1-2
101	132	Jazz 2-1
102	132	Jazz 2-2
103	150	Brush 1
104	150	Brush 2
105	120	Big Band 1
106	120	Big Band 2
107	130	Jazz Waltz 1
108	130	Jazz Waltz 2
109	150	Jazz in Five 1
110	150	Jazz in Five 2
111	120	Fusion 1-1
112	120	Fusion 1-2
113	100	Fusion 2-1
114	100	Fusion 2-2
115	135	Fusion 3-1
116	135	Fusion 3-2
117	110	Fusion 4-1
118	110	Fusion 4-2
119	120	Groove In Six-1
120	120	Groove In Six-2

(Recommend)		
No.	Tempo	Pattern
121	100	Smooth Jazz 1
122	100	Smooth Jazz 2
123	120	Heavy Funk 1
124	120	Heavy Funk 2
125	120	Technical Fusion 1
126	120	Technical Fusion 2
127	98	Hip Hop 1-1
128	98	Hip Hop 1-2
129	122	Hip Hop 2-1
130	122	Hip Hop 2-2
131	95	Hip Hop 3-1
132	95	Hip Hop 3-2
133	115	Hip Hop 4-1
134	115	Hip Hop 4-2
135	160	Drum 'n' Bass 1-1
136	160	Drum 'n' Bass 1-2
137	160	Drum 'n' Bass 2-1
138	160	Drum 'n' Bass 2-2
139	140	Drum 'n' Bass 3-1
140	140	Drum 'n' Bass 3-2
141	130	Techno 1-1
142	130	Techno 1-2
143	140	Techno 2-1
144	140	Techno 2-2
145	130	House 1-1
146	130	House 1-2
147	140	House 2-1
148	140	House 2-2
149	140	Boom 1
150	140	Boom 2
151	110	Disco 1
152	110	Disco 2
153	130	Bossa Nova 1-1
154	130	Bossa Nova 1-2
155	130	Bossa Nova 2-1
156	130	Bossa Nova 2-2
157	120	Samba 1-1
158	120	Samba 1-2
159	120	Samba 2-1
160	120	Samba 2-2

(Recommend)		
No.	Tempo	Pattern
161	140	Samba 3-1
162	140	Samba 3-2
163	115	Samba Bass 1
164	115	Samba Bass 2
165	95	Salsa 1-1
166	95	Salsa 1-2
167	100	Salsa 2-1
168	100	Salsa 2-2
169	110	Mambo 1
170	110	Mambo 2
171	145	Merenge 1
172	145	Merenge 2
173	130	Latin Pop 1-1
174	130	Latin Pop 1-2
175	120	Latin Pop 2-1
176	120	Latin Pop 2-2
177	95	Latin Pop 3-1
178	95	Latin Pop 3-2
179	150	Reggae 1-1
180	150	Reggae 1-2
181	150	Reggae 2-1
182	150	Reggae 2-2
183	150	Reggae 3-1
184	150	Reggae 3-2
185	172	Reggae 4-1
186	172	Reggae 4-2
187	115	Songo 1-1
188	115	Songo 1-2
189	115	Songo 2-1
190	115	Songo 2-2
191	120	Polka 1
192	120	Polka 2
193	135	India 1-1
194	135	India 1-2
195	110	India 2-1
196	110	India 2-2
197	142	Afro 1-1
198	142	Afro 1-2
199	115	Afro 2-1
200	115	Afro 2-2

Dr. Rhythm

Date : May 18, 2001

Model DR-670

## MIDI Implementation Chart

Version : 1.00

Function...	Transmitted	Recognized	Remarks
Basic Channel Changed	1-16 1-16	1-16 1-16	Storable in Memory
Mode Default Messages Altered	Mode 3 X *****	Mode 3 X	
Note Number : True Voice	23-87 *****	23-87	
Velocity Note On Note Off	O X	O X	9n v=1-127
After Touch Key's Channel's	X X	X X	
Pitch Bend	X	X	
Control Change	X	X	



Program Change : True Number	O *****			O	
System Exclusive	O			O	
System : Song Position Common : Song Select : Tune Request	O SYNC=INT *1 O SYNC=INT *1 X	O SYNC=MIDI *2 O SYNC=MIDI *2 X			0-99
System : Clock Real Time : Commands	O SYNC=INT *1 O SYNC=INT *1	O SYNC=MIDI *2 O SYNC=MIDI *2			
Aux : Local On/Off Messages : All Notes Off : Active Sensing : Reset	X X O X	X X O X			
Notes	* 1 Transmitted when Sync Mode is INT or AUTO and unit is functioning as master * 2 Received when Sync Mode is MIDI or AUTO and unit is functioning as slave				

Mode 1 : OMNI ON, POLY  
Mode 3 : OMNI OFF, POLY  
Mode 2 : OMNI ON, MONO  
Mode 4 : OMNI OFF, MONO  
O : Yes  
X : No

# Specifications

## Maximum Polyphony

20 voices

\* *Depending on the instruments and drum kits used, maximum polyphony may be lower.*

## Instruments

Drum: 256

Bass: 16

## Rhythm Patterns

User Patterns: 200

Preset Patterns: 200

## Songs

Songs: 100

Song Length: Maximum 250 patterns for a song

Total Patterns for all songs: approx. 3,000

## Maximum Note Storage

approx. 8,000 notes

## Resolution

Per quarter note: 96

## Tempo

Quarter note: 20-260 bpm

## Recording Method

Realtime / Step

## Pads

20

## Display

Custom LCD

## Connectors

Output Jacks L(MONO)/R

Headphones Jack (stereo miniature phone type)

Foot Switch Jack (stereo 1/4 inch phone type)

MIDI Connectors IN/OUT

AC Adaptor Jack (DC 9 V)

## Power Supply

DC 9V: Dry Battery x 6, AC Adaptor (PSA series)

## Power Consumption

200 mA or less

\* *Expected battery life under continuous use:*

*Carbon: approx. 2.5 hours*

*Alkaline: approx. 6 hours*

*These figures will vary depending on the actual conditions of use.*

## Dimensions

213 (W) x 169 (D) x 53 (H) mm

8-7/16 (w) x 6-11/16 (D) x 2-1/8 (H) inches

## Weight

750 g / 1 lb 11 oz (excluding dry batteries)

## Accessories

Alkaline Dry Battery (LR6 (AA) type) x 6

Owner's Manual

Roland Service (Information sheet)

## Options

AC Adaptor: PSA series

Foot Switch: FS-5U

Foot Switch cable: PCS-31 (Roland)

(1/4 inches Phone Plug (stereo) -  
1/4 inches Phone Plug (mono) x 2)

\* *In the interest of product improvement, the specifications and/or appearance of this unit are subject to change without prior notice.*

# Index

<b>A</b>		
Assign Type .....	82	
Attack .....	83	
<b>B</b>		
Basic Pattern .....	50–51	
Basic Pitch .....	78	
Bass .....	47	
Bass Part .....	56–58, 62, 76, 78	
Bass Tone .....	36, 42, 83	
BEAT .....	53	
Beat .....	52–53	
Bulk Dump .....	89	
Bulk Load .....	89–90	
<b>C</b>		
CHAIN .....	74	
CLEAR .....	60, 70	
Click Beat .....	78	
Click Level .....	78	
Continued Play .....	20	
COPY .....	61, 70, 84	
Copy .....	61, 70, 84	
<b>D</b>		
Decay .....	81, 83	
DELETE .....	56, 69	
Delete .....	69	
DEMO .....	20, 41	
Demo Mode .....	41	
Device ID .....	89	
Direct Pattern Play .....	28, 41, 49, 75	
DPP .....	28, 49, 66, 75	
DPP ASSIGN .....	41, 75	
DPP Assign mode .....	41	
Drum Bank .....	24, 43, 47	
DRUM KIT .....	47	
Drum Kit .....	36, 42, 47, 54, 62, 84	
DRUM KIT EDIT .....	41	
Drum Kit Edit mode .....	41, 79	
Drum Part .....	56–57, 76	
<b>E</b>		
Edit .....	79	
Envelope .....	83	
Erase .....	56–58, 60, 70	
EX1M .....	82	
EX1P .....	82	
<b>F</b>		
Factory Reset .....	19	
Fill Pattern .....	50–51, 59	
Fill-In .....	32, 50	
Flam .....	23, 48, 78	
Flam Interval .....	78	
Flam Ratio .....	78	
Foot Switch .....	51, 55, 65, 74, 77	
Fret Shift .....	48	
<b>I</b>		
Initial Tempo .....	64, 74	
INSERT .....	69	
Insert .....	69	
Instrument .....	21, 24, 42, 80	
<b>K</b>		
Key .....	62	
Key Transpose .....	62	
<b>L</b>		
Level .....	80, 83	
<b>M</b>		
Master .....	86	
MEASURE .....	54	
Measure .....	52, 54	
Metronome .....	55, 78	
MIDI .....	41, 85	
MIDI Channel .....	88	
MIDI IN .....	85	
MIDI Mode .....	41, 86	
MIDI OUT .....	85	
MONO .....	82	
Monophonic .....	52	
<b>N</b>		
Note Messages .....	88	
Nuance .....	81	
<b>O</b>		
Output Part .....	76	
<b>P</b>		
Pad Sens .....	78	
Pan .....	81, 84	
Pattern .....	38, 49	
Pattern Clear .....	60	
Pattern Display .....	44	
PATTERN EDIT .....	40, 52	
Pattern Edit mode .....	40, 52	
Pattern Number .....	27	
PATTERN PLAY .....	21, 27–28, 33, 35–36, 40, 47	
Pattern Play mode .....	40, 47	
PCS-31 .....	34	
Pitch .....	80	

Polarity Switch .....	34
POLY .....	82
Polyphony .....	43
PRESET .....	53
Preset Pattern .....	26, 49
Program Change .....	88

**Q**

Quantize .....	55
----------------	----

**R**

Realtime Recording .....	38–39, 56, 59, 65–66
Rehearse .....	55
Release .....	83–84
REPEAT .....	73
Roll .....	22, 48, 77
Roll Type .....	77

**S**

SCALE .....	45
Scale Display .....	45
Slave .....	86
Song .....	39, 72
Song Chain .....	71, 74
Song Clear .....	70
SONG EDIT .....	40, 63
Song Edit mode .....	40, 63
SONG PLAY .....	40, 72
Song Play mode .....	40, 72
Song Repeat .....	73–74
Step .....	45
Step Recording .....	38–39, 57, 59, 68
Sync Mode .....	86

**T**

Tap Tempo .....	50
Tempo .....	30, 50
Tuning .....	78

**U**

User Pattern .....	26, 49
UTILITY .....	41, 76
Utility Mode .....	41, 76

**Memo ...**

**Memo ...**

## Apparatus containing Lithium batteries

### ADVARSEL!

Lithiumbatteri - Eksplosionsfare ved fejlagtig håndtering.  
Udskiftning må kun ske med batteri af samme fabrikat og type.  
Levér det brugte batteri tilbage til leverandøren.

### ADVARSEL

Eksplosjonsfare ved feilaktig skifte av batteri.  
Benytt samme batteritype eller en tilsvarende type anbefalt av apparatfabrikanten.  
Brukte batterier kasseres i henhold til fabrikantens instruksjoner.

### CAUTION

Danger of explosion if battery is incorrectly replaced.  
Replace only with the same or equivalent type recommended by the manufacturer.  
Discard used batteries according to the manufacturer's instructions.

### VARNING

Explosionsfara vid felaktigt batteribyte.  
Använd samma batterityp eller en ekvivalent typ som rekommenderas av apparattillverkaren.  
Kassera använt batteri enligt fabrikantens instruktion.

### VAROITUS

Paristo voi räjähtää, jos se on virheellisesti asennettu.  
Vaihda paristo ainoastaan laitevalmistajan suosittelemaan tyyppiin. Hävitä käytetty paristo valmistajan ohjeiden mukaisesti.



This product complies with the requirements of European Directive 89/336/EEC.

## FEDERAL COMMUNICATIONS COMMISSION RADIO FREQUENCY INTERFERENCE STATEMENT

This equipment has been tested and found to comply with the limits for a Class B digital device, pursuant to Part 15 of the FCC Rules. These limits are designed to provide reasonable protection against harmful interference in a residential installation. This equipment generates, uses, and can radiate radio frequency energy and, if not installed and used in accordance with the instructions, may cause harmful interference to radio communications. However, there is no guarantee that interference will not occur in a particular installation. If this equipment does cause harmful interference to radio or television reception, which can be determined by turning the equipment off and on, the user is encouraged to try to correct the interference by one or more of the following measures:

- Reorient or relocate the receiving antenna.
- Increase the separation between the equipment and receiver.
- Connect the equipment into an outlet on a circuit different from that to which the receiver is connected.
- Consult the dealer or an experienced radio/TV technician for help.

This device complies with Part 15 of the FCC Rules. Operation is subject to the following two conditions:

- (1) This device may not cause harmful interference, and
- (2) This device must accept any interference received, including interference that may cause undesired operation.

Unauthorized changes or modification to this system can void the users authority to operate this equipment.  
This equipment requires shielded interface cables in order to meet FCC class B Limit.

### NOTICE

This Class B digital apparatus meets all requirements of the Canadian Interference-Causing Equipment Regulations.

### AVIS

Cet appareil numérique de la classe B respecte toutes les exigences du Règlement sur le matériel brouilleur du Canada.





## Free Manuals Download Website

<http://myh66.com>

<http://usermanuals.us>

<http://www.somanuals.com>

<http://www.4manuals.cc>

<http://www.manual-lib.com>

<http://www.404manual.com>

<http://www.luxmanual.com>

<http://aubethermostatmanual.com>

Golf course search by state

<http://golfingnear.com>

Email search by domain

<http://emailbydomain.com>

Auto manuals search

<http://auto.somanuals.com>

TV manuals search

<http://tv.somanuals.com>