



ME-50B BASS MULTIPLE EFFECTS

Owner's Manual

Thank you, and congratulations on your choice of the BOSS ME-50B Bass Multiple Effects.

Before using this unit, carefully read the sections entitled: "USING THE UNIT SAFELY" (page 2-3) and "IMPORTANT NOTES" (page 4).

These sections provide important information concerning the proper operation of the unit. Additionally, in order to feel assured that you have gained a good grasp of every feature provided by your new unit, owner's manual should be read in its entirety. The manual should be saved and kept on hand as a convenient reference.

Main features

Simple Operation—Works Like a Compact Effects Processor

Each effect is controlled with a dedicated knob. Intuitive operation, similar to that of compact effects processors, lets you make changes to tones directly.

High-Quality Sounds Through COSM

With high-quality effects like Compressor/Limiter and Overdrive/Distortion, which make full use of COSM technology, you can perform with a variety of powerful effects, from classic vintage sounds to new and original sounds.

COSM (Composite Object Sound Modeling)

Composite Object Sound Modeling (COSM) is Roland's innovative and powerful sound modeling technology. COSM analyzes the many factors that make up the original sound, such as the electrical and physical characteristics of the original, and then produces a digital model that can reproduce the same sound.

Multi-Function Expression Pedal

The ME-50B is equipped with an expression pedal that gives you control over six different specialized pedal effects. It can also be switched for use as a volume pedal.

Memory Function

You can store up to 24 original tones you have created. You can also use the pedals in "Memory mode" to call up stored tones instantly.

AUX IN Jack

The AUX IN jack makes it easy to practice along with CDs, MDs, and other input.

Battery-Powered Operation

The ME-50B can be powered in two ways, with (6) AA batteries or by using the AC adaptor (optional).

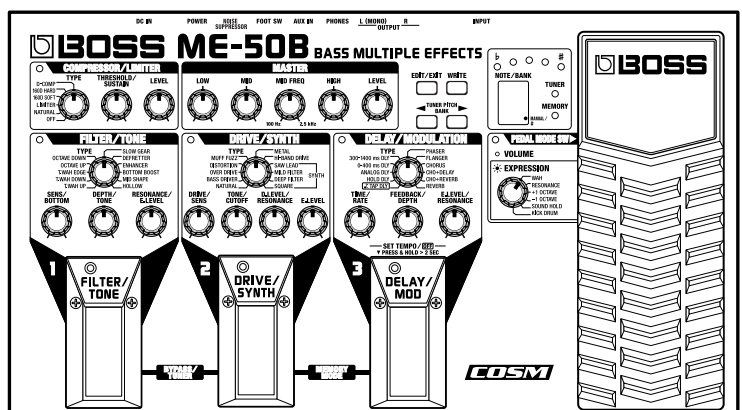

Copyright © 2003 BOSS CORPORATION
All rights reserved. No part of this publication may be reproduced in any form without the written permission of BOSS CORPORATION.









USING THE UNIT SAFELY

INSTRUCTIONS FOR THE PREVENTION OF FIRE, ELECTRIC SHOCK, OR INJURY TO PERSONS

About WARNING and CAUTION Notices







| | |
|--|--|
|  WARNING | Used for instructions intended to alert the user to the risk of death or severe injury should the unit be used improperly. |
|  CAUTION | Used for instructions intended to alert the user to the risk of injury or material damage should the unit be used improperly. * Material damage refers to damage or other adverse effects caused with respect to the home and all its furnishings, as well to domestic animals or pets. |

About the Symbols





| | |
|---|--|
|  | The  symbol alerts the user to important instructions or warnings. The specific meaning of the symbol is determined by the design contained within the triangle. In the case of the symbol at left, it is used for general cautions, warnings, or alerts to danger. |
|  | The  symbol alerts the user to items that must never be carried out (are forbidden). The specific thing that must not be done is indicated by the design contained within the circle. In the case of the symbol at left, it means that the unit must never be disassembled. |
|  | The  symbol alerts the user to things that must be carried out. The specific thing that must be done is indicated by the design contained within the circle. In the case of the symbol at left, it means that the power-cord plug must be unplugged from the outlet. |

ALWAYS OBSERVE THE FOLLOWING







WARNING

- Before using this unit, make sure to read the instructions below, and the Owner's Manual. 
- Do not open (or modify in any way) the unit or its AC adaptor. 
- Do not attempt to repair the unit, or replace parts within it (except when this manual provides specific instructions directing you to do so). Refer all servicing to your retailer, the nearest Roland Service Center, or an authorized Roland distributor, as listed on the "Information" sheet. 
- Never use or store the unit in places that are:
 - Subject to temperature extremes (e.g., direct sunlight in an enclosed vehicle, near a heating duct, on top of heat-generating equipment); or are 
 - Damp (e.g., baths, washrooms, on wet floors); or are 
 - Humid; or are
 - Exposed to rain; or are
 - Dusty; or are
 - Subject to high levels of vibration.
- Make sure you always have the unit placed so it is level and sure to remain stable. Never place it on stands that could wobble, or on inclined surfaces. 
- Use only the specified AC adaptor (PSA series), and make sure the line voltage at the installation matches the input voltage specified on the AC adaptor's body. Other AC adaptors may use a different polarity, or be designed for a different voltage, so their use could result in damage, malfunction, or electric shock. 





WARNING

- Do not excessively twist or bend the power cord, nor place heavy objects on it. Doing so can damage the cord, producing severed elements and short circuits. Damaged cords are fire and shock hazards! 
- This unit, either alone or in combination with an amplifier and headphones or speakers, may be capable of producing sound levels that could cause permanent hearing loss. Do not operate for a long period of time at a high volume level, or at a level that is uncomfortable. If you experience any hearing loss or ringing in the ears, you should immediately stop using the unit, and consult an audiologist. 
- Do not allow any objects (e.g., flammable material, coins, pins); or liquids of any kind (water, soft drinks, etc.) to penetrate the unit. 

- Immediately turn the power off, remove the AC adaptor from the outlet, and request servicing by your retailer, the nearest Roland Service Center, or an authorized Roland distributor, as listed on the "Information" sheet when:
 - The AC adaptor or the power-supply cord has been damaged; or
 - If smoke or unusual odor occurs
 - Objects have fallen into, or liquid has been spilled onto the unit; or
 - The unit has been exposed to rain (or otherwise has become wet); or
 - The unit does not appear to operate normally or exhibits a marked change in performance.







⚠ WARNING

- In households with small children, an adult should provide supervision until the child is capable of following all the rules essential for the safe operation of the unit. 
- Protect the unit from strong impact. (Do not drop it!) 
- Do not force the unit's power-supply cord to share an outlet with an unreasonable number of other devices. Be especially careful when using extension cords—the total power used by all devices you have connected to the extension cord's outlet must never exceed the power rating (watts/amperes) for the extension cord. Excessive loads can cause the insulation on the cord to heat up and eventually melt through. 
- Before using the unit in a foreign country, consult with your retailer, the nearest Roland Service Center, or an authorized Roland distributor, as listed on the "Information" sheet. 
- Batteries must never be recharged, heated, taken apart, or thrown into fire or water. 

⚠ CAUTION

- The unit and the AC adaptor should be located so their location or position does not interfere with their proper ventilation. 
- Always grasp only the output plug or the body of the AC adaptor when plugging into, or unplugging from, this unit or an outlet. 
- At regular intervals, you should unplug the AC adaptor and clean it by using a dry cloth to wipe all dust and other accumulations away from its prongs. Also, disconnect the power plug from the power outlet whenever the unit is to remain unused for an extended period of time. Any accumulation of dust between the power plug and the power outlet can result in poor insulation and lead to fire. 
- Try to prevent cords and cables from becoming entangled. Also, all cords and cables should be placed so they are out of the reach of children. 
- Never climb on top of, nor place heavy objects on the unit. 

⚠ CAUTION

- Never handle the AC adaptor body, or its output plugs, with wet hands when plugging into, or unplugging from, an outlet or this unit. 
- Before moving the unit, disconnect the AC adaptor and all cords coming from external devices. 
- Before cleaning the unit, turn off the power and unplug the AC adaptor from the outlet. 
- Whenever you suspect the possibility of lightning in your area, disconnect the AC adaptor from the outlet. 
- If used improperly, batteries may explode or leak and cause damage or injury. In the interest of safety, please read and observe the following precautions (p. 6). 
 - Carefully follow the installation instructions for batteries, and make sure you observe the correct polarity. 
 - Avoid using new batteries together with used ones. In addition, avoid mixing different types of batteries.
 - Remove the batteries whenever the unit is to remain unused for an extended period of time.
 - If a battery has leaked, use a soft piece of cloth or paper towel to wipe all remnants of the discharge from the battery compartment. Then install new batteries. To avoid inflammation of the skin, make sure that none of the battery discharge gets onto your hands or skin. Exercise the utmost caution so that none of the discharge gets near your eyes. Immediately rinse the affected area with running water if any of the discharge has entered the eyes.
 - Never keep batteries together with metallic objects such as ballpoint pens, necklaces, hairpins, etc.
- Used batteries must be disposed of in compliance with whatever regulations for their safe disposal that may be observed in the region in which you live. 

IMPORTANT NOTES

In addition to the items listed under “USING THE UNIT SAFELY” on page 2–3, please read and observe the following:

Power Supply: Use of Batteries

- Do not connect this unit to same electrical outlet that is being used by an electrical appliance that is controlled by an inverter (such as a refrigerator, washing machine, microwave oven, or air conditioner), or that contains a motor. Depending on the way in which the electrical appliance is used, power supply noise may cause this unit to malfunction or may produce audible noise. If it is not practical to use a separate electrical outlet, connect a power supply noise filter between this unit and the electrical outlet.
- The AC adaptor will begin to generate heat after long hours of consecutive use. This is normal, and is not a cause for concern.
- The use of an AC adaptor is recommended as the unit’s power consumption is relatively high. Should you prefer to use batteries, please use the alkaline type.
- When installing or replacing batteries, always turn off the power on this unit and disconnect any other devices you may have connected. This way, you can prevent malfunction and/or damage to speakers or other devices.
- Batteries are supplied with the unit. The life of these batteries may be limited, however, since their primary purpose was to enable testing.
- Before connecting this unit to other devices, turn off the power to all units. This will help prevent malfunctions and/or damage to speakers or other devices.

Placement

- Using the unit near power amplifiers (or other equipment containing large power transformers) may induce hum. To alleviate the problem, change the orientation of this unit; or move it farther away from the source of interference.
- This device may interfere with radio and television reception. Do not use this device in the vicinity of such receivers.
- Noise may be produced if wireless communications devices, such as cell phones, are operated in the vicinity of this unit. Such noise could occur when receiving or initiating a call, or while conversing. Should you experience such problems, you should relocate such wireless devices so they are at a greater distance from this unit, or switch them off.
- Do not expose the unit to direct sunlight, place it near devices that radiate heat, leave it inside an enclosed vehicle, or otherwise subject it to temperature extremes. Excessive heat can deform or discolor the unit.
- When moved from one location to another where the temperature and/or humidity is very different, water droplets (condensation) may form inside the unit. Damage or malfunction may result if you attempt to use the unit in this condition. Therefore, before using the unit, you must allow it to stand for several hours, until the condensation has completely evaporated.

Maintenance

- For everyday cleaning wipe the unit with a soft, dry cloth or one that has been slightly dampened with water. To remove stubborn dirt, use a cloth impregnated with a mild, non-abrasive detergent. Afterwards, be sure to wipe the unit thoroughly with a soft, dry cloth.
- Never use benzine, thinners, alcohol or solvents of any kind, to avoid the possibility of discoloration and/or deformation.

Repairs and Data

- Please be aware that all data contained in the unit’s memory may be lost when the unit is sent for repairs. Important data should always be written down on paper (when possible). During repairs, due care is taken to avoid the loss of data. However, in certain cases (such as when circuitry related to memory itself is out of order), we regret that it may not be possible to restore the data, and Roland assumes no liability concerning such loss of data.

Additional Precautions

- Please be aware that the contents of memory can be irretrievably lost as a result of a malfunction, or the improper operation of the unit. To protect yourself against the risk of losing important data, we recommend that important data should always be written down on paper.
- Unfortunately, it may be impossible to restore the contents of data that was stored in the unit’s memory once it has been lost. BOSS/Roland Corporation assumes no liability concerning such loss of data.
- Use a reasonable amount of care when using the unit’s buttons, sliders, or other controls; and when using its jacks and connectors. Rough handling can lead to malfunctions.
- Never strike or apply strong pressure to the display.
- When connecting / disconnecting all cables, grasp the connector itself—never pull on the cable. This way you will avoid causing shorts, or damage to the cable’s internal elements.
- To avoid disturbing your neighbors, try to keep the unit’s volume at reasonable levels. You may prefer to use headphones, so you do not need to be concerned about those around you (especially when it is late at night).
- When you need to transport the unit, package it in the box (including padding) that it came in, if possible. Otherwise, you will need to use equivalent packaging materials.
- Use a cable from Roland to make the connection. If using some other make of connection cable, please note the following precautions.
 - Some connection cables contain resistors. Do not use cables that incorporate resistors for connecting to this unit. The use of such cables can cause the sound level to be extremely low, or impossible to hear. For information on cable specifications, contact the manufacturer of the cable.
- Security Slot (K)
<http://www.kensington.com/>
- All product names mentioned in this document are trademarks or registered trademarks of their respective owners.

Contents

| | | | |
|---|-----------|---|-----------|
| USING THE UNIT SAFELY | 2 | Saving and Loading the Created Tones (Memory Mode) | 21 |
| IMPORTANT NOTES | 4 | Switching Between Manual and Memory Mode | 21 |
| Playing Sounds | 6 | About the Patch..... | 21 |
| Installing Batteries | 6 | Write Procedure | 22 |
| Making the Connections..... | 6 | Calling Up and Using Stored Tones (Patch Change) ... | 22 |
| Turning on the Power | 7 | Switching Numbers..... | 22 |
| Adjusting the Volume..... | 7 | Switching Banks..... | 22 |
| Turning Off the Power | 7 | Notes When Using Memory Mode | 23 |
| Using the Effects | 8 | About Tone Changes..... | 23 |
| About the Effect Connection Sequence..... | 8 | About the Tempo Setting..... | 23 |
| COMPRESSOR/LIMITER..... | 9 | About the HOLD DLY | 23 |
| FILTER/TONE..... | 10 | About the ♪.TAP DLY | 23 |
| DRIVE/SYNTH | 12 | Changing the Patch Settings (Patch Edit mode)..... | 24 |
| DELAY/MODULATION..... | 14 | Convenient Functions..... | 25 |
| Using the HOLD DLY Function..... | 16 | Tuning the Bass (Bypass/Tuner) | 25 |
| Using the ♪.TAP DLY Function..... | 16 | Using the Foot Switch | 26 |
| Adding a Delay | | Switching the Compressor/Limiter On and Off | 26 |
| Synchronized to the Performance Tempo..... | 16 | Adding an Effect | |
| Adding a Modulation Effect | | Synchronized to the Performance Tempo..... | 26 |
| Synchronized to the Performance Tempo..... | 17 | Switching Banks..... | 27 |
| Pedal..... | 18 | Practicing Along with CDs and MDs (AUX IN)..... | 27 |
| Using the Pedal as a Volume Pedal | 18 | Appendices | 28 |
| Using the Pedal as an Expression Pedal..... | 18 | Returning the ME-50B | |
| Using the SOUND HOLD Function | 19 | to Its Factory Settings (Factory Reset) | 28 |
| Using the KICK DRUM Function..... | 19 | Adjusting the Expression Pedal | 28 |
| MASTER | 20 | Troubleshooting..... | 29 |
| NOISE SUPPRESSOR | 20 | Specifications | 30 |
| A Note About Bypass | 20 | Patch List..... | 31 |
| | | Factory Settings..... | 32 |
| | | Blank Chart..... | 34 |
| | | Index | 38 |

Conversions Used in This Manual

- Words in square brackets [] indicate panel buttons or knobs.
(Example)
[WRITE]: WRITE button
- (p. **) indicates a reference page.

Playing Sounds

Installing Batteries

* Batteries are supplied with the unit. The life of these batteries may be limited, however, since their primary purpose was to enable testing.

Insert the included batteries as shown in figure, being careful to orient the batteries correctly.

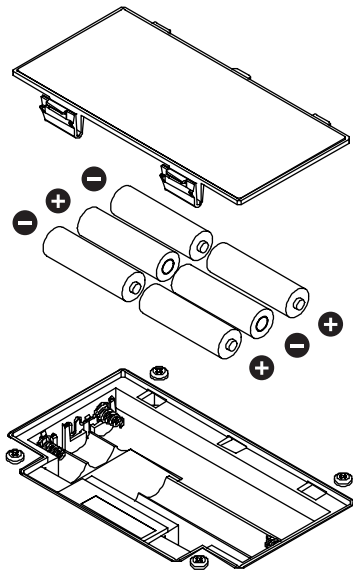

NOTE

- When turning the unit upside-down, get a bunch of newspapers or magazines, and place them under the four corners or at both ends to prevent damage to the buttons and controls. Also, you should try to orient the unit so no buttons or controls get damaged.
- When turning the unit upside-down, handle with care to avoid dropping it, or allowing it to fall or tip over.
- Make sure the "+" and "-" ends of the batteries are oriented correctly.
- A "b" appears in the display when the batteries are nearly worn out. When this occurs, replace with new batteries.
- When replacing the batteries, use six AA type.
- Avoid using new batteries together with used ones. In addition, avoid mixing different types of batteries. Doing so can result in fluid leakage.
- Battery life can vary depending on battery type.

MEMO

Continuous usage time under battery power is about 12 hours with alkaline batteries and about 3.5 hours with carbon batteries.

(This may vary according to usage conditions.)

Making the Connections

The ME-50B is not equipped with any internal amplifier or speakers. To listen to sound with the ME-50B, connect it to a bass amp, stereo headphones, or other such sound equipment.

* To prevent malfunction and/or damage to speakers or other devices, always turn down the volume, and turn off the power on all devices before making any connections.

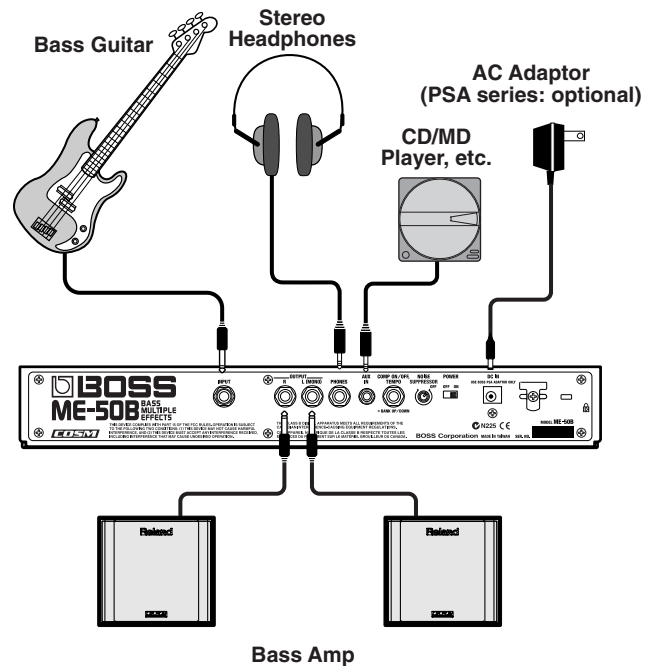

- If there are batteries in the unit while an AC adaptor is being used, normal operation will continue should the line voltage be interrupted (power blackout or power cord disconnection from the ME-50B).
- To prevent the inadvertent disruption of power to your unit (should the plug be pulled out accidentally), and to avoid applying undue stress to the AC adaptor jack, anchor the power cord using the cord hook, as shown in the illustration.

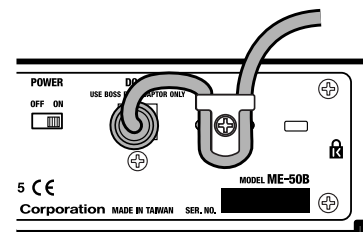

- When outputting monaurally, connect a cable only to the OUTPUT L (MONO) jack.
- Do not use a cable containing a resistor to connect CD or MD players to the AUX IN jack. If a cable incorporating resistance is used, audio from CD and MD players may become inaudible.

Turning on the Power

Once the connections have been completed, turn on power to your various devices in the order specified. By turning on devices in the wrong order, you risk causing malfunction and/or damage to speakers and other devices.

* If using the ME-50B with a CD or MD player, be sure to turn on the power to the connected device first.

1. ME-50B

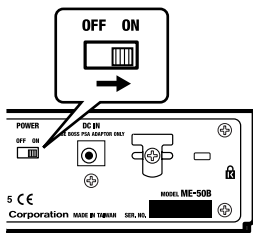

2. Bass Amp /Stereo, Multitrack Recorder, Etc.

* Turn up the volume on amps and other equipment only after all connections are completed and the power for connected devices is turned on.

* This unit is equipped with a protection circuit. A brief interval (several seconds) after power up is required before the unit will operate normally.

Adjusting the Volume

Adjust the ME-50B's volume with the MASTER LEVEL knob.

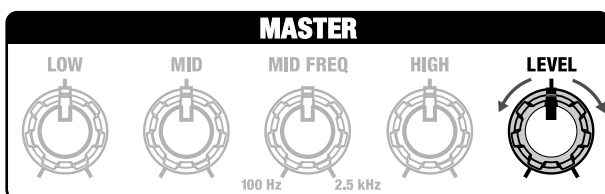

* Raising the MASTER LEVEL knob too much may result in sound distortion.

* When the effects are all off, input and output are at the same levels as when the MASTER LEVEL knob is at the center position.

* The setting of the MASTER LEVEL knob is stored in memory for each patch (p. 21).

If There Is No Sound/If the Volume is Low

- Are connections to other devices correctly made?
Check the connections once more.
- Is the volume turned down?
Check the volume levels on any connected amp or mixer.

- Can you hear sound through the headphones when headphones are connected?

If you can hear sounds, it may be that there is a short in the cable used to connect the amp or other device, or perhaps a mistake in an external device's settings. Check the connecting cables and external devices once more.

- Has the level been lowered with the expression pedal?
Sounds are not output when the toe of the expression pedal is in the raised position while the pedal is set to function as a volume pedal (p. 18).

- Is the ME-50B in Tuner mode (p. 25)?

In Tuner mode, the bypass sound is output, and the expression pedal is used as a volume pedal.

When the expression pedal is used as a volume pedal, sound output falls as you pull the pedal back, raising the front of the pedal (p. 18).

- Is a cable containing a resistor being used to connect a CD or MD player to the AUX IN jack?

Using a cable containing a resistor may prevent sound from CD and MD players from being audible.

Turning Off the Power

1. Turn down the volume of the ME-50B and any connected device.
2. Turn off the power to Bass Amp / Stereo, Multitrack Recorder, etc.
3. Turn the ME-50B's power off.

Using the Effects

NOTE

When the power is turned on, the FILTER/TONE, DRIVE/SYNTH, and DELAY/MODULATION are switched off. Also, the expression pedal will function as volume pedal.

- * When the DELAY/MODULATION TYPE is set to HOLD DLY, the DELAY/MODULATION indicator goes on, the DELAY/MOD pedal's indicator flashes at a fixed interval, indicating recording standby is enabled. (p. 16)

All product names mentioned in this document are trademarks or registered trademarks of their respective owners. Those companies are not affiliated with BOSS and have not licensed or authorized BOSS's ME-50B. Their marks are used solely to identify the equipment whose sound is simulated by BOSS's ME-50B.

About the Effect Connection Sequence

The ME-50B automatically selects the optimum sequence for connecting the effects according to the effect settings.

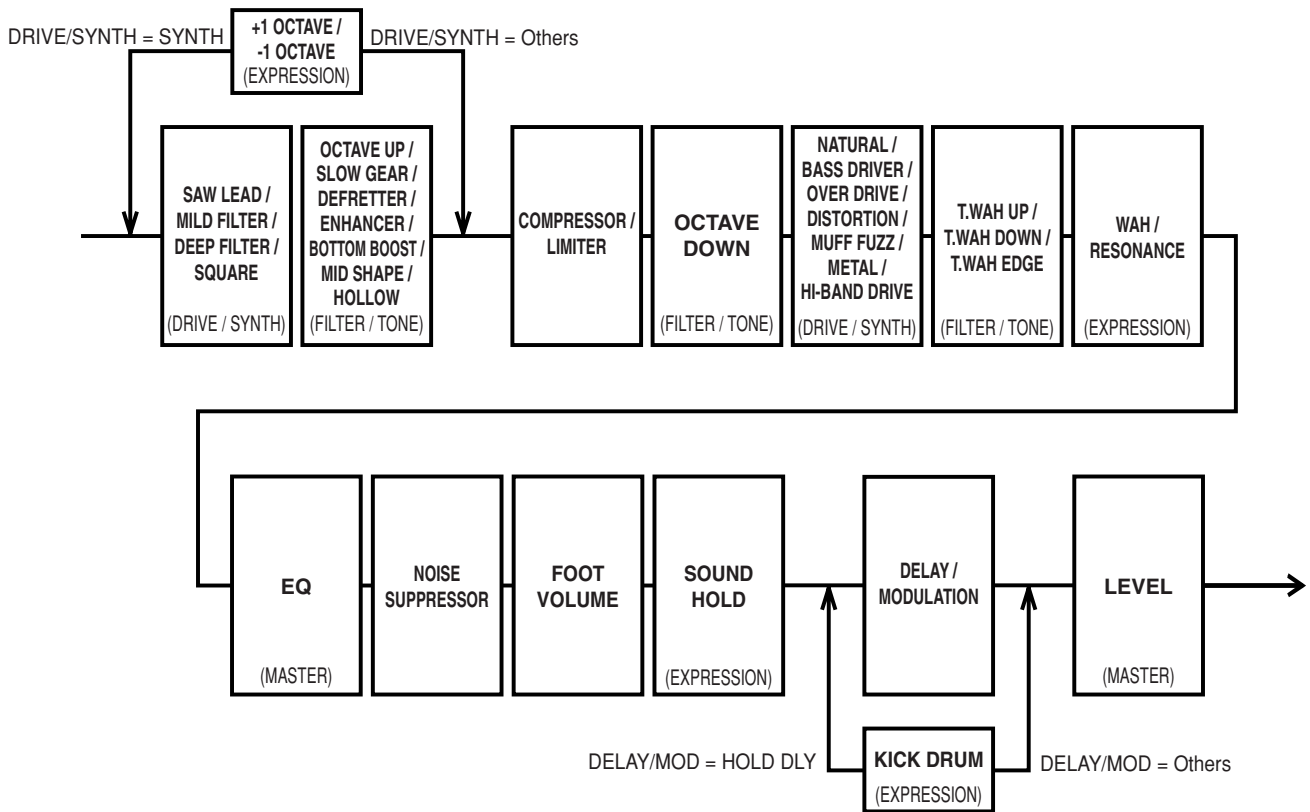

COMPRESSOR/LIMITER

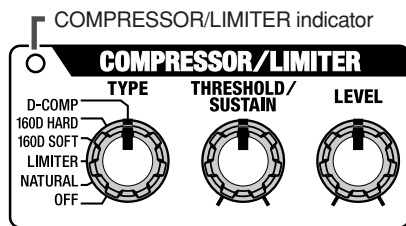

This comprises two effects, one that evens out the volume of the input signals to provide lengthy sustain (compressor), and one that prevents distortion by suppressing only the peaks in the sound (limiter).

TYPE knob

OFF

Turns off the compressor/limiter effect sound is bypassed.

- * The COMPRESSOR/LIMITER indicator goes off when this is set to OFF.

NATURAL

Provides natural-sounding performances with little thinning of the sound, even when pushing the effect. This is especially effective with slapping and hard picking.

LIMITER

Prevents distortion by suppressing the input signal level when it exceeds the set value.

160D SOFT

Models the dbx 160 set to a lower compression ratio.

160D HARD

Models the dbx 160 set to a high compression ratio.

D-COMP

Models the MXR DynaComp.

THRESHOLD/SUSTAIN knob

Adjusts the depth of the effect.

When the TYPE is set to NATURAL, LIMITER, 160D SOFT, or 160D HARD, this functions as the THRESHOLD knob, which sets the level at which the limiter starts to take effect. The more the knob is turned to the left (counterclockwise), the lower the level at which the limiter effect is enabled.

When the TYPE is set to D-COMP, the knob functions as a SUSTAIN control, which adjusts how long sounds are sustained. Turn the knob to the right (clockwise) to get longer sustain times.

LEVEL knob

This adjusts the level when the compressor/limiter is on. Use this to balance the volume level so it is the same when the compressor/limiter is switched on and off.



You can use a foot switch to switch the compressor/limiter on and off. For more detailed information, refer to "Using the Foot Switch" (p. 26).

FILTER/TONE

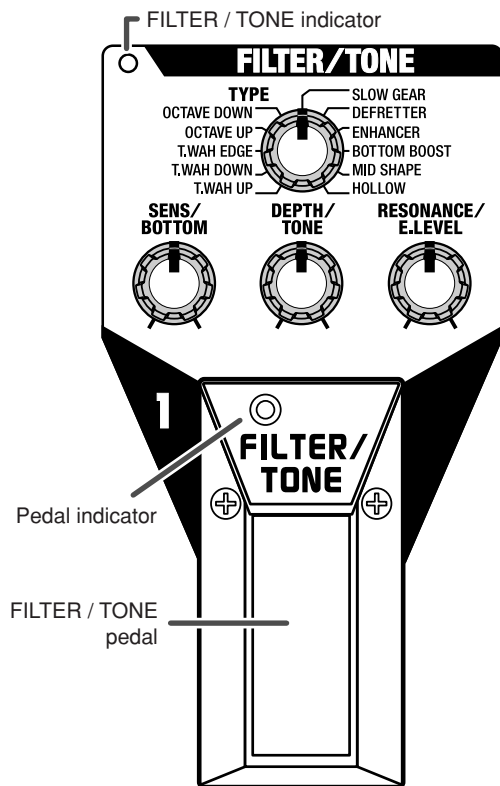

Included here are eleven different effects that alter the particular characteristics of the bass sound itself. You can select and use any one of these effects at a time.

FILTER/TONE pedal

The filter tone is alternately switched on and off each time you press the pedal. The indicator lights up when the effect is on.

TYPE knob

Selects the effect to be used from the eleven different effects that are available.

T.WAH UP/T.WAH DOWN/T.WAH EDGE

This effect alters the wah effect in response to the level at the time the bass is played.

T.WAH UP:

The filter shifts to higher frequencies in response to the input.

T.WAH DOWN:

The filter shifts to lower frequencies in response to the input.

T.WAH EDGE:

Gives a filter with a stronger effect.

SENS/BOTTOM knob

Adjusts the sensitivity when the filter is being altered.

DEPTH/TONE knob

Adjusts the reference frequency for the wah effect.

RESONANCE/E.LEVEL knob

Adjusts the amount of wah effect at frequencies near the reference frequency. Turning the knob to the left widens the range of frequencies in the vicinity of the reference frequency in which the wah effect is to be produced, while turning the knob to the right narrows this range.

OCTAVE UP/OCTAVE DOWN

This effect creates a fatter, thicker sound by adding to the input sound the same sound raised one octave (OCTAVE UP) or lower one octave (OCTAVE DOWN).

* This effect does not function correctly if two or more notes are played simultaneously.

SENS/BOTTOM knob

Adjusts the volume of the direct sound.

DEPTH/TONE knob

Adjusts the tone of the octave sound. Turn the knob to the left for a milder sound or to the right for a sharper sound.

RESONANCE/E.LEVEL knob

Adjusts the volume of the octave sound.

SLOW GEAR

This produces a volume-swell effect (similar to how a violin is played).

SENS/BOTTOM knob

Adjusts the sensitivity of the slow gear effect. As the knob is turned more to the left, there is less response to weaker picking, so the effect is expressed only when strong picking is used.

DEPTH/TONE knob

This adjusts the time needed for the volume to reach its maximum from the moment you begin picking.

RESONANCE/E.LEVEL knob

Adjusts the volume of the effect sound.

DEFRETTER

This effect allows you to use a conventional bass to simulate a fretless bass.

SENS/BOTTOM knob

Adjusts the amount of defretter effect applied in response to the input sound.

DEPTH/TONE knob

Adjusts the tone. Turn the knob to the left for a milder sound, or to the right for a sharper sound.

RESONANCE/E.LEVEL knob

Adjusts the volume of the defretter sound.

ENHANCER

This is an effect that clarifies the contour of the input sound by emphasizing the sound following changes in the input level.

SENS/BOTTOM knob

This adjusts the Enhancer sensitivity. The more the knob is turned to the right, the more softly you can play and still have the effect applied.

DEPTH/TONE knob

Adjusts the frequency at which the enhancer will begin to be applied. The effect is applied at higher frequencies the more the knob is turned to the right.

RESONANCE/E.LEVEL knob

Adjusts the amount of enhanced sound added to the mix.

BOTTOM BOOST/MID SHAPE/HOLLOW

Alters the special characteristics of the bass sound.

BOTTOM BOOST:

Creates a tone with a boosted low end.

MID SHAPE:

Creates a tone with the midrange cut back.

HOLLOW:

Adds body resonance to create a tone resembling that of an acoustic-electric bass.

SENS/BOTTOM knob

Adjusts the tone of the lower range.

DEPTH/TONE knob

Adjusts the tone of the upper range.

RESONANCE/E.LEVEL knob

Adjusts the volume.

DRIVE/SYNTH

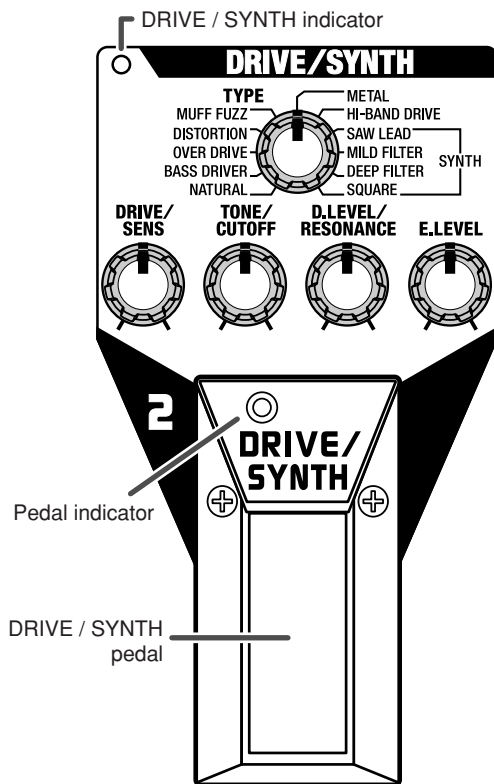

This distorts the sound, or create an effect like that of an analog synth.

DRIVE/SYNTH pedal

The DRIVE/SYNTH is alternately switched on and off each time you press the pedal. The indicator lights up when the effect is on.

TYPE knob

NATURAL

Overdrive that gives a more natural sounding distortion.

BASS DRIVER

Models the TECH21 SANSAMP BASS DRIVER DI.

OVER DRIVE

Models the BOSS ODB-3.

DISTORTION

Distortion tuned especially for use with basses.

MUFF FUZZ

Models the Electro-Harmonix Big Muff π .

METAL

Wild, radical distortion sound.

HI-BAND DRIVE

With this effect, distortion is applied only to the high-frequency sounds, and not to the sounds in the low-frequency range.

SAW LEAD

A saw-wave synth-bass sound with a slight filter motion. Using the effect in combination with the Expression (p. 18) type set to "RESONANCE" makes it even more effective.

MILD FILTER

A saw-wave synth-bass sound with relatively weak filter effect. A motion of the filter changes depending on the strength or the position, when playing the bass.

DEEP FILTER

A saw-wave synth-bass sound with a strong filter effect. A motion of the filter changes depending on the strength or the position, when playing the bass.

SQUARE

A square-wave synth-bass sound. A motion of the filter changes depending on the strength or the position, when playing the bass.

* When SYNTH (SAW LEAD-SQUARE) is selected, this effect does not function correctly if two or more notes are played simultaneously.

DRIVE/SENS knob

When DRIVE (NATURAL-HI-BAND DRIVE) is selected

Adjusts the amount of distortion applied. Turning the knob to the right boosts the distortion and increases the volume.

When SYNTH (SAW LEAD-SQUARE) is selected

Adjusts the amount of filtering applied.

TONE/CUTOFF knob

When (NATURAL-HI-BAND DRIVE) is selected

Adjusts the tone. Turn the knob to the left for a milder sound or to the right for a sharper sound.

When SYNTH (SAW LEAD-SQUARE) is selected

Adjusts the frequency at which the harmonic components of the sound are cut (the cutoff frequency).

D.LEVEL/RESONANCE knob

When (NATURAL-HI-BAND DRIVE) is selected

Adjusts the volume of the direct sound.

- * *Normally this adjusts the sound immediately ahead of its being input to DRIVE/SYNTH, but when OCTAVE UP is selected as the FILTER/TONE type, this adjusts the sound input to the INPUT jack. Thus, only the sounds raised by an octave are distorted, giving an effect that sounds like a guitar playing in unison with the direct bass sound.*

When SYNTH (SAW LEAD-SQUARE) is selected

Adjusts the amount by which the harmonic components near the cutoff frequency are boosted.

E.LEVEL knob

Adjusts the volume.

- * *Noise may creep into the sound if the E.LEVEL knob is turned up too high. Adjust the E.LEVEL knob so the volume level sounds the same whether the effect is switched on or off.*

DELAY/MODULATION

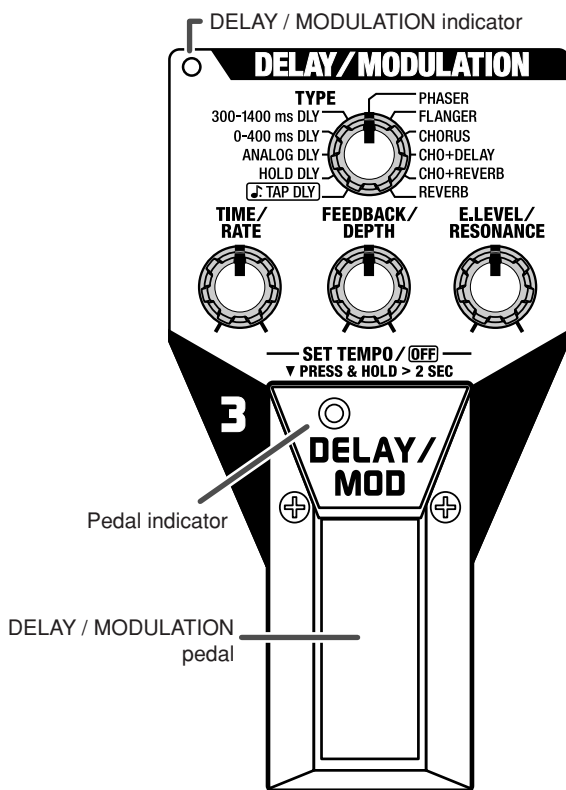

This provides the delay effect, in which the sound is slightly delayed and is fed back to the direct sound, and the modulation effect, which adds a sort of swell to the sound to give it greater breadth.

The ME-50B comes equipped with eleven different delay and modulation effects. You can select and use any one of these effects at a time.

DELAY/MOD pedal

The Delay/Modulation is switched on or off each time you press the pedal. When switched on, the DELAY/MOD indicator and pedal indicator light up.

- * When ♪.TAP DLY is selected, holding down the DELAY/MOD pedal for at least two seconds, causes the effect to turn off.
- * When HOLD DLY is selected, you cannot switch the effect on/off by pressing the pedal.
- * DELAY ON/OFF switches the Delay at the input to provide a more natural effect. For this reason, if the FEEDBACK is turned up when the Delay is turned off, the delay sound will remain briefly.
- * When a setting other than HOLD DLY, CHO + REVERB, or REVERB is selected, you can use the DELAY/MOD pedal to input the tempo, and set the delay time synchronized to the performance tempo.



“ ♪.TAP DLY ” (refer to the following)

“Adding a Delay Synchronized to the Performance Tempo” (p. 16)

“Adding a Modulation Synchronized to the Performance Tempo” (p. 17)

TYPE knob

Selects the effect to be used from the eleven different effects that are available.

♪.TAP DLY

This is a tempo delay that lets you set a dotted eighth note delay time for the performance tempo by pressing the DELAY/MOD pedal in time with the performance tempo.

- * The delay time can be set within the range of 46.5 ms to 1050 ms.



“Using the ♪.TAP DLY Function” (p. 16)

TIME/RATE knob

This has no effect or function.

FEEDBACK/DEPTH knob

Adjusts the amount of feedback (number of repeats). Turning the knob to the right increases the number of times the sound repeats.

E.LEVEL/RESONANCE knob

Adjusts the volume of the delay sound.

HOLD DLY

Up to 2.8 seconds of performance content is recorded, then played back repeatedly. You can also layer this as you perform something else, then record these together (overdub).

You can keep the recorded content playing continuously as backing and produce other special effects.



“Using the HOLD DLY Function” (p. 16)

TIME/RATE knob

This has no effect or function.

FEEDBACK/DEPTH knob

This has no effect or function.

E.LEVEL/RESONANCE knob

Adjusts the volume of the playback sound.

ANALOG DLY/0-400 ms DLY/300-1400 ms DLY**ANALOG DLY:**

This gives a mild analog delay sound. The delay time can be set within the range of 100 ms to 500 ms.

0-400 ms DLY:

Delay sound of 0 to 400 ms delay time.

300-1400 ms DLY:

Delay sound of 300 to 1400 ms delay time.

TIME/RATE knob

Adjusts the delay time.

FEEDBACK/DEPTH knob

Adjusts the amount of feedback (number of repeats). Turning the knob to the right increases the number of times the sound repeats.

E.LEVEL/RESONANCE knob

Adjusts the volume of the delay sound.

PHASER

By adding varied-phase portions to the direct sound, adds a twisting "warp" effect to the sound.

TIME/RATE knob

Adjusts the rate of phaser effect.

FEEDBACK/DEPTH knob

Adjusts the depth of phaser effect.

E.LEVEL/RESONANCE Knob

Adjusts the amount of resonance.

FLANGER

Adds a undulation like that of a jet ascending or descending.

TIME/RATE knob

Adjusts the rate of flanging effect.

FEEDBACK/DEPTH knob

Adjusts the depth of flanging effect.

E.LEVEL/RESONANCE knob

Adjusts the amount of resonance.

CHORUS

This is a stereo chorus effect that adds different chorus sounds to L and R.

TIME/RATE knob

Adjusts the rate of modulation.

FEEDBACK/DEPTH knob

Adjusts the depth of modulation.

E.LEVEL/RESONANCE knob

Adjusts the volume of the chorus sound.

CHO+DELAY

An effect combining chorus and delay.

The delay time can be set within the range of 100 ms to 800 ms.

* *The chorus setting is fixed.*

TIME/RATE knob

Adjusts the delay time.

FEEDBACK/DEPTH knob

Adjusts the amount of feedback (number of repeats). Turning the knob to the right increases the number of times the sound repeats.

E.LEVEL/RESONANCE knob

Adjusts the volume of the delay sound.

CHO+REVERB

An effect combining chorus and reverb.

* *The chorus setting is fixed.*

TIME/RATE knob

Adjusts the reverb time.

FEEDBACK/DEPTH knob

Adjusts the tonal quality of the reverb sound. Turn the knob to the right for a brighter sound.

E.LEVEL/RESONANCE knob

Adjusts the volume of the reverb sound.

REVERB

This effect adds reverberation to the sound.

TIME/RATE knob

Adjusts the reverb time.

FEEDBACK/DEPTH knob

Adjusts the tonal quality of the reverb sound. Turn the knob to the right for a brighter sound.

E.LEVEL/RESONANCE knob

Adjusts the volume of the reverb sound.

Using the HOLD DLY Function

1. Set the TYPE knob to HOLD DLY.
The unit goes into recording standby and the pedal's indicator flashes at a fixed interval.
 - * After switching to HOLD DLY, you cannot perform any operation during the 2.8-second period before the unit switches to recording standby. Wait for at least 2.8 seconds before moving on to the next step.
2. Press the DELAY/MOD pedal to start recording.
Recording starts when you press the DELAY/MOD pedal.
The indicator flashes during recording.
3. Press the DELAY/MOD pedal once again to end recording.
Playback of the recorded content begins simultaneously (the indicator remains lit).
 - * The maximum recording time is 2.8 seconds. If the recording time exceeds 2.8 seconds, the recording stops automatically, and the recorded content is then played back.
 - * An oscillating sound may be audible with extremely short recording times.
4. When layering recordings, repeat Steps 2 and 3.
 - * The recorded content is cleared when the TYPE knob is switched to a different setting or when the power is turned off.
5. Adjust the volume.
Adjust the volume of the playback sound with the E.LEVEL/RESONANCE knob.
6. When returning to the recording standby, hold down the DELAY/MOD pedal for the same length of time as the recording.
The unit returns to recording standby, and the pedal's indicator flashes at a fixed interval.



You can return to the recording standby immediately by using external foot switch. For more detailed information, refer to "Using the Foot Switch" (p. 26).

- * When playback is stopped, the recorded content is erased.
- * To start recording again, wait 2.8 seconds, then carry out step 2.

Using the ♩ .TAP DLY Function

1. Set the TYPE knob to ♩ .TAP DLY.
 - * If the effect is OFF, press the DELAY/MOD pedal to turn it ON.
The pedal indicator flashes in time with the current tempo.
2. Press the DELAY/MOD pedal in timing with the tempo more than two times.
The reference tempo is determined by the time interval between each press of the pedal. The reference tempo is calculated in terms of quarter notes, and the delay time setting is the dotted eighth note as referenced to the reference tempo.
The pedal indicator flashes in time with the tempo.

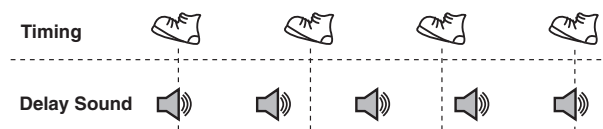

Adding a Delay Synchronized to the Performance Tempo

The delay time can be set according to the tempo input when the TYPE is set to ANALOG DLY, 0-400 ms DLY, 300-1400 ms DLY, or CHO+DELAY.

The delay time can be set within the range of 62 ms to 1400 ms.

You can set this regardless of whether the effect is on or off.

1. Hold down the DELAY/MOD pedal for at least two seconds.
 - If the DELAY/MOD pedal is pressed when the effect is on, the pedal indicator goes out, and the effect is turned off.
 - If the DELAY/MOD pedal is pressed when the effect is off, the pedal indicator turns red, and the effect is turned on.

When you continue to depress the pedal, after two seconds the pedal's indicator starts to flash, and the tempo can then be set with the effect on.
Here, the delay time is indicated by the value set with the TIME/RATE knob.
2. Press the DELAY/MOD pedal in timing with the tempo more than two times.
The delay time is set according to the time interval between each press of the pedal.
The pedal indicator flashes in time with the tempo.
 - * Press the pedal to set the tempo while no bass sound is playing.

3. Hold down the pedal switch for at least two seconds to complete the tempo setting.

The effect goes on, and instead of flashing, the pedal indicator will light.

- * *The tempo may become confused momentarily when you go from Step 2 to Step 3.*
- * *If you move the TIME/RATE knob after finishing this setting, the delay time corresponding to the knob position takes effect.*

Executing Write Procedures (p. 22) After the Tempo Has Been Set

The delay time stored in a Patch (p. 21) is determined as follows.

- If it is within the delay time range that can be set for the type currently selected, it is stored without change.
- If it exceeds the maximum delay time that can be set for the type currently selected, the maximum value for the type is stored.
- If it is less than the minimum delay time that can be set for the type currently selected, the minimum value for the type is stored.

(Example) When TYPE is 0-400 ms

When the delay time for the tempo setting is 600 ms:

Stored as 400 ms.

(Example) When TYPE is 300-1400 ms

When the delay time for the tempo setting is 200 ms:

Stored as 300 ms.

Adding a Modulation Effect Synchronized to the Performance Tempo

When the TYPE is set to PHASER/FLANGER/CHORUS, you can set the tempo so you get an effect that is synchronized to the performance tempo.

- * *The allowable rate cycles for the tempo settings range from 62 ms to 2000 ms.*

1. Hold down the DELAY/MOD pedal for at least two seconds.

- If the DELAY/MOD pedal is pressed when the effect is on, the pedal indicator goes out, and the effect is turned off.
- If the DELAY/MOD pedal is pressed when the effect is off, the pedal indicator turns red, and the effect is turned on.

When you continue to depress the pedal, after two seconds the pedal's indicator starts to flash, and the tempo can then be set with the effect on.

Here, the tempo is indicated by the value set with the TIME/RATE knob.

2. Press the DELAY/MOD pedal in timing with the tempo more than two times.

The tempo is set according to the time interval between each press of the pedal. The pedal indicator flashes in time with the tempo.

Setting the TIME/RATE near the desired tempo beforehand allows you to make faster and more natural tempo settings.

3. Hold down the DELAY/MOD pedal for at least two seconds to complete the tempo setting.

The effect goes on, and instead of flashing, the pedal indicator will light.

- * *If you move the TIME/RATE knob after finishing this setting, the rate corresponding to the knob position takes effect.*



You can use a foot switch to set the DELAY/MODULATION tempo. For more detailed information, refer to "Using the Foot Switch" (p. 26).

A Note About the Quantize Function

When you set tempo using the DELAY/MOD pedal or start recording in HOLD DLY while the KICK DRUM is playing drum beat, the set tempo or the recording time is adjusted automatically by the tempo of the drum beat.

The KICK DRUM sound will also be recorded on the HOLD DLY, so you will not be able to control the KICK DRUM sound with the expression pedal, once you start the playback.)



"Using the KICK DRUM Function" (p. 19)

Pedal

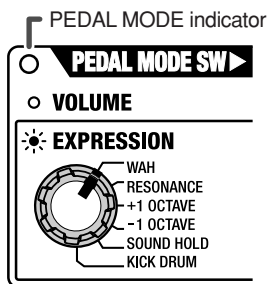

You can make the setting that determines whether the ME-50B's pedal functions as a volume pedal or as an expression pedal. In addition, when using it as an expression pedal, you can use it to control one of the special pedal effects that you select.

Using the Pedal as a Volume Pedal

When using the expression pedal as a volume pedal, press the expression pedal all the way forward and then give it a stronger push, the PEDAL MODE indicator goes off.

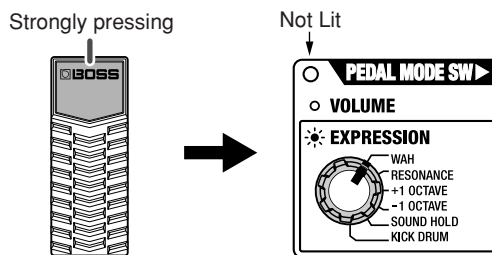

The volume decreases as the pedal's toe is raised, and increases when the pedal is pressed down.

Using the Pedal as an Expression Pedal

When using the pedal as an expression pedal, press the expression pedal all the way forward and then give it a stronger push, the PEDAL MODE indicator lights up.

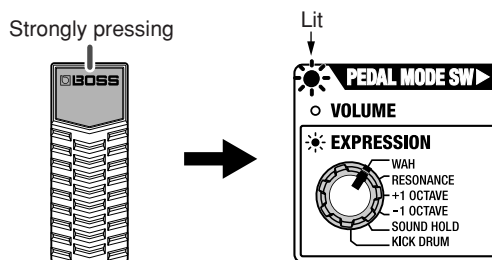

You can select one of the following effects with the expression pedal.

WAH

The effect will function as a pedal wah.

RESONANCE

This completely original effect offers enhancements on the characteristic resonances produced by analog synth filters. Using the effect in combination with the DRIVE/SYNTH TYPE set to "SAW LEAD" or "SQUARE" makes them even more effective.

+1 OCTAVE

Allows the pitch to be raised up to one octave above the original bass sound.

** This effect does not function correctly if two or more notes are played simultaneously.*

-1 OCTAVE

Allows the pitch to be lowered up to one octave below the original bass sound.

** This effect does not function correctly if two or more notes are played simultaneously.*

SOUND HOLD

You can hold the sounds played from the bass. This effect allows you to hold low notes while playing melodies in the upper registers.

** This effect does not function correctly if two or more notes are played simultaneously.*



"Using the SOUND HOLD Function" (p. 19)

KICK DRUM

A kick drum sound is played when you press the pedal. This is a useful feature you can use as a guide rhythm, for example in bass solos, or instead of a metronome during practice.



"Using the KICK DRUM Function" (p. 19)

Using the SOUND HOLD Function

1. Turn the knob to SOUND HOLD.
2. Firmly press down on the front end of the expression pedal so the PEDAL MODE indicator lights up.
3. Bring the expression pedal back all the way to switch to standby mode.
4. Play the bass, then press down on the expression pedal a little.

The note played on the bass is held, and the volume changes in keeping with the degree to which you've depressed the pedal.

- * This effect does not function correctly if two or more notes are played simultaneously.
- * Although you can adjust the volume of held notes with the expression pedal, be careful not to raise the front tip of the pedal too high, as this will cancel the hold.

5. Repeat Steps 3 and 4 to hold a different note.
6. To quit SOUND HOLD, firmly press down on the front end of the expression pedal so the PEDAL MODE indicator light goes out.

Using the KICK DRUM Function

1. Turn the knob to KICK DRUM.

The number for the currently selected tone is shown in the display (two seconds).

You can press BANK [◀] [▶] to switch the tone.

- | | | |
|----|--------------------------|---------------|
| 1: | Tight sound | (low volume) |
| 2: | Tight sound sound | (high volume) |
| 3: | Standard kick drum sound | (low volume) |
| 4: | Standard kick drum sound | (high volume) |
| 5: | Sound with long sustain | (low volume) |
| 6: | Sound with long sustain | (high volume) |

2. Firmly press down on the front end of the expression pedal so the PEDAL MODE indicator lights up.

3. After tilting the expression pedal back, press it fully forward again.

The kick drum sound plays.

- * You can alter the volume level of the drum sound according to how quickly you press the pedal. Press the pedal again quickly to raise the volume; the volume decreases when the pedal is pressed down again slowly.

4. Lift up the expression pedal once, and press it down again.

The kick drum sound is played.

The automatic drum beat starts when you hold the pedal at the fully pressed position, after hitting the kick drum sound twice or more. The tempo of the beat is set by the time distance between the last played kick drum sound, and the one just before.

If you do not need the automatic drum beat, just lift up the pedal.

- * The volume of the rhythm is determined by the speed at which the pedal is pressed the last time.
- * You can set the interval between beats in a range from 240 ms to 2000 ms.
- * Once you start recording in HOLD DLY, you cannot restart the drum beats, or change the tempo. However, you can make the kick drum sound play every time you press down the pedal.

5. If you want to change the tempo or volume, repeat Step 4.

6. To stop playing the beat, pull back the expression pedal so the front end is raised.

7. To quit the KICK DRUM function, firmly press down on the front end of the expression pedal so the PEDAL MODE indicator light goes out.

- * To quit the function while the beat is not being played, first press the expression pedal forward slowly so as not to have the kick drum sound play, then press the front end of the pedal down firmly.

MASTER

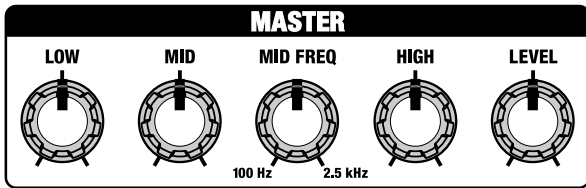

Adjusts the overall tonal quality and volume level.

LOW knob

Adjusts the tone of the lower range. Turning the knob to the right boosts the lower frequencies; turning the knob to the left cuts the lower frequencies.

MID knob

Adjusts the tone of the midrange. Turning the knob to the right boosts the midrange; turning the knob to the left cuts the midrange.

MID FREQ knob

Adjusts the center frequency for the tone set with the MID knob. This frequency can be set in a range from 100 Hz to 2.5 kHz.

HIGH knob

Adjusts the tone of the upper range. Turning the knob to the right boosts the high frequencies; turning the knob to the left cuts the high frequencies.

LEVEL knob

Adjusts the volume.

- * Turning the LEVEL knob up too much may cause the sound to distort.
- * When all effects are switched off and all knobs other than MID FREQ are set to the center position, the input and output levels are identical.

NOISE SUPPRESSOR



This effect reduces the noise and hum picked up by bass pickups. Since it suppresses the noise in synchronization with the envelope of the bass sound (the way in which the bass sound decays over time), it has very little effect on the bass sound, and does not harm the natural character of the sound.

NOISE SUPPRESSOR knob

Adjust this parameter as appropriate for the volume of the noise. If the noise level is high, a higher setting is appropriate. If the noise level is low, a lower setting is appropriate. Adjust this value until the decay of the bass sound is as natural as possible.

- * Turn the knob to OFF when not using the noise suppressor.
- * High settings for the threshold parameter may result in there being no sound when you play with your bass volume turned down.

A Note About Bypass

The ME-50B allows you to switch between the state whereby the effects are applied and the completely dry state, devoid of all effects (bypass).

To learn how to do this, see "Tuning the Bass (Bypass/Tuner)" (p. 25).

Saving and Loading the Created Tones (Memory Mode)

The ME-50B features a "Memory mode" that allows you to store the various settings within the ME-50B itself, and then call up and use the settings.

Switching Between Manual and Memory Mode

The mode in which the tone produced reflects the panel settings just as they are is called "Manual mode." A dot appears in the display when the ME-50B is in Manual mode.

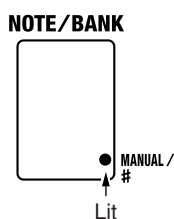

- When switching from Manual mode to Memory mode, press the No. 2 and No. 3 pedals simultaneously; this causes the MEMORY indicator to light up (and the dot in the display disappears).

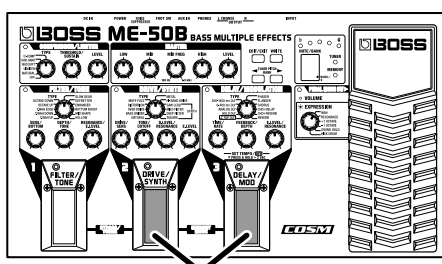

Press simultaneously

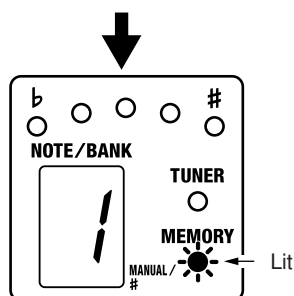

- Pressing the No. 2 and 3 pedals at the same time while in Memory mode switches you to Manual mode.

* Manual mode is the power-up default mode of the ME-50B.

About the Patch

When actually performing on a bass, a variety of tones are required to suit whatever the situation may be. The effects that you may want to have turned on and parameter settings for such effects vary according to the selected tone.

With the ME-50B, you can set these parameters, volume levels, and so on, store a number of the aggregate settings in memory, and use the pedals to switch the stored settings, allowing you to change tones instantly.

Such stored sets of settings are known as "Patches." You can create up to 24 patches.

The 24 patches are divided into eight "banks," each of which contains three patches.

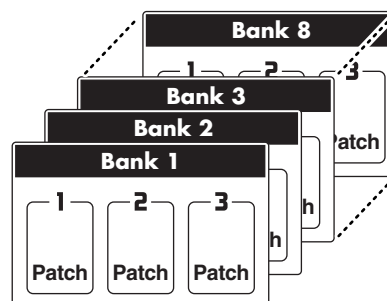

The setting for the NOISE SUPPRESSOR knob, MASTER knobs, and KICK DRUM tone are also stored individually for each patch.

Write Procedure

The "Write procedure" enables you to save the created tone settings using the panel knobs and pedals, MASTER section's knob setting, and expression pedal settings to patches.

- * You can carry out the Write procedure in both Manual mode and Memory mode.
- * If the Write procedure is not carried out, then the tone you have created is erased when the power is turned off or when you switch to a different patch.

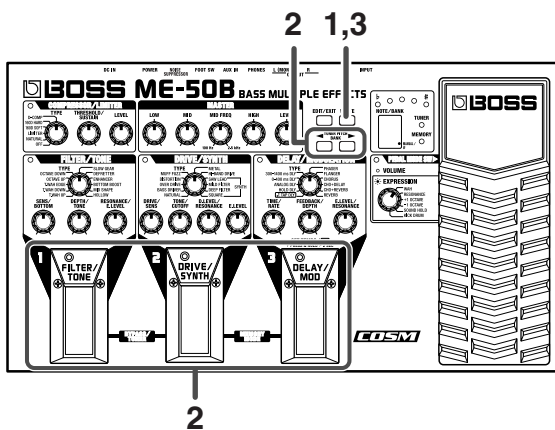

- 1. Press [WRITE].**
The MEMORY indicator flashes. At the same time, the bank indication in the display and the pedal indicator flash, and the currently selected Patch Bank and Number are shown.
- 2. Select the Patch to be used as the save destination.**
 - Press BANK [◀] [▶] to select the bank.
 - Press a number pedal (1-3) to select the number.
 - * To stop the Write procedure, press [EDIT/EXIT], and return to the previous mode.
- 3. Press [WRITE] once more.**
The tone is stored, and Memory mode is then enabled (the MEMORY indicator lights up).
 - * When a Write procedure is performed while the DELAY type is set to "TAP DLY" (p. 14) and DELAY is on, after the operation the indicator for the number pedal where the tone was stored flashes to indicate that you can input the tempo.
 - * When a Write procedure is carried out while the DELAY type is set to "HOLD DLY" (p. 14), after the operation the indicator for the number pedal where the tone was stored flashes at a fixed interval to indicate that recording standby is enabled.



The tone stored in the patch designated as the save destination is erased once the Write procedure is executed.

Calling Up and Using Stored Tones (Patch Change)

To switch patches, use BANK [◀] [▶] and the number pedals (1-3).

- * Bank 1, Number 1 is always selected at first when Memory mode is entered after the power is turned on.

Switching Numbers

When the number pedal (1) is pressed, the number indicator (2) above the pedal lights up, the patch with that number in the currently selected group and bank is called up, and the tone is switched instantly.

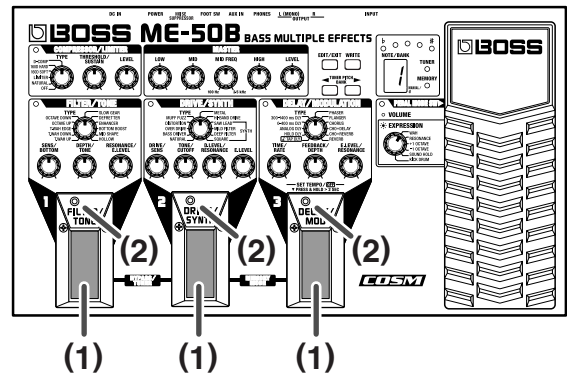

Switching Banks

The bank is switched each time the BANK [◀] [▶] (1) is pressed. The currently selected bank flashes in the Display (2). (At this time, tones are not yet switched.)

- * You can switch among eight banks 1-8.

While in this state, if you press any of the number pedals (3), the tone instantly switches to the sound of the patch at the currently selected bank/number.

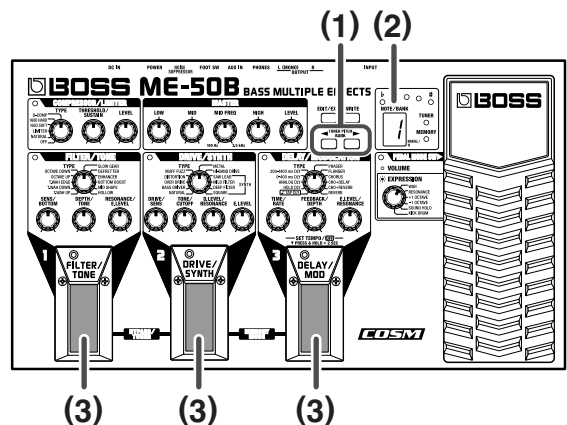

You can use a foot switch to switch the banks. For more detailed information, refer to "Using the Foot Switch" (p. 26).

If the Patch Does Not Change

- Is the ME-50B in Manual mode (p. 21)?
- Is the ME-50B in Patch Edit mode (p. 24)?
- Is the ME-50B in Tuner mode (p. 25)?

Notes When Using Memory Mode

NOTE

- The settings for each patch are called up from internal memory in the Memory mode. Therefore, each knob's position and the patch settings may not match, when the patch is called up.
- In Memory mode, you cannot switch effects on or off using the No. 1, 2, and 3 pedals.

About Tone Changes

By operating the knobs, you can change the tone of a patch while it's called up. Note, however, that the changed tone is only temporary, and will be lost when you switch patches or switch to the Tuner mode (p. 25).

If you want to store it in memory, carry out the Write procedure (p. 22).

- * *If there is a discrepancy between the current knob position and the parameter stored in the patch, the change in the parameter begins at the point when the knob is moved past the position matching the parameter value as stored in the patch.*

About the Tempo Setting

If you hold down the currently selected number pedal for at least two seconds, the pedal indicator flashes, and the ME-50B switches to tempo setting mode, and the number pedal can then be used to input the tempo.

Selecting from the following types while DELAY/MODULATION is on allows you to set the delay time or rate.

- ANALOG DLY
- 0-400 ms DLY
- 300-1400 ms DLY
- PHASER
- FLANGER
- CHORUS
- CHO+DELAY

- * *When DELAY/MODULATION is off, you cannot change to tempo setting mode.*

Note, however, that the tempo setting is only temporary, and will be lost when you switch patches or switch to the Tuner mode (p. 25).

If you want to store it in memory, carry out the Write procedure (p. 22).

About the HOLD DLY

When a Patch that has a TYPE setting of HOLD DLY is called up, the currently selected number pedal's indicator flashes slowly, indicating that the ME-50B is in recording standby. Afterwards, the following conditions are in effect.

- Pressing the currently selected number pedal rapidly: begins recording
- Pressing the currently selected number pedal rapidly during recording: stops recording, starts Loop Playback
- Pressing the currently selected number pedal rapidly during Loop Playback: overdub recording
- Pressing the currently selected number pedal rapidly: stops overdub recording, starts Loop Playback
- Holding down the currently selected number pedal for the same length of time as the recording time: releases the HOLD, switches to recording standby

About the TAP DLY

When DELAY is ON and a Patch that has a TYPE setting of  TAP DLY is called up, the currently selected number pedal's indicator flashes, and you can then set the delay time (p. 16) using tap input.

Changing the Patch Settings (Patch Edit mode)

Use the following procedure when editing the settings of a patch you have called up.



You can use a foot switch to set the DELAY/MODULATION tempo. For more detailed information, refer to “Using the Foot Switch” (p. 26).

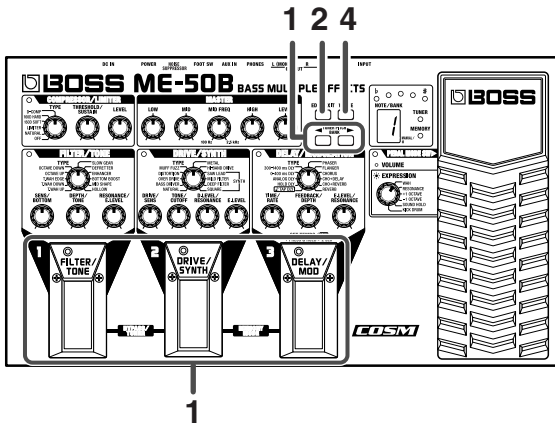

- 1. Switch to the Patch whose settings you want to edit (p. 22).**
- 2. Press [EDIT/EXIT].**

The MEMORY indicator flashes, and editing of the patch settings is enabled (Patch Edit mode).
- 3. Use the knobs and pedals to change the settings.**

When settings are changed, the indicator for the changed effect flashes (except for MASTER and NOISE SUPPRESSOR).

NOTE

- If there is a discrepancy between the current knob position and the parameter stored in the patch, the change in the parameter begins at the point when the knob is moved past the position matching the parameter value as stored in the patch.
- 4. If you want to save the contents of your edit, carry out the Write procedure. (p. 22)**
 - * Pressing [EDIT/EXIT] switches you to Memory mode without saving the settings.
 - * When the unit is not in Patch Edit mode, you cannot switch the following effects on or off, and cannot select the KICK DRUM tones.
 - FILTER/TONE
 - DRIVE/SYNTH
 - DELAY/MODULATION

Convenient Functions

Tuning the Bass (Bypass/Tuner)

The ME-50B features a built-in chromatic auto-tuner, which allows you to tune your bass easily, without any need to change any of your connections.

Additionally, in Tuner mode, the input sound without any effect whatsoever applied (the bypass sound) is output. Since you can use the expression pedal to lower the volume, there is no need for you to turn down your amp volume when you tune.

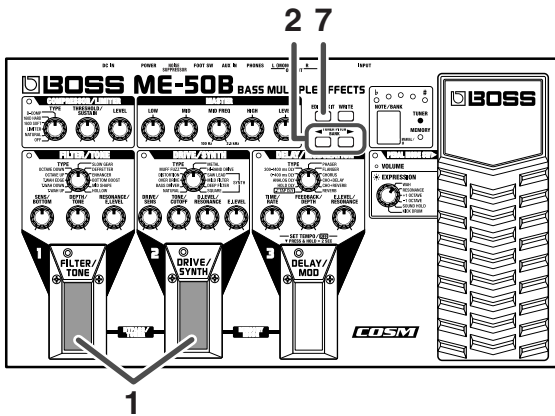

1. Press the number 1 and 2 pedals simultaneously to switch to Tuner mode.

The TUNER indicator lights.

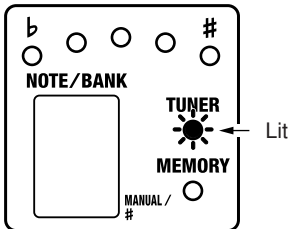

2. Tune to the reference pitch.

You can change the reference pitch by pressing TUNER PITCH [◀] [▶]. The reference pitch can be set in one-Hertz units in the range of 435-445 Hz.

| Display | 5-9 | 0 | 1.-5. (dot flash) |
|------------|---------|-----|----------------------|
| Pitch (Hz) | 435-439 | 440 | 441-445 |

* If changing the reference pitch, always be sure to exit Tuner mode before turning off the power. The new setting is stored upon exiting Tuner mode. If you turn off the power with the ME-50B still in Tuner mode, the changed reference pitch is not saved.

3. Play a single note on the string to be tuned; play the string open.

The name of the note closest to the string that is played appears in the Display.

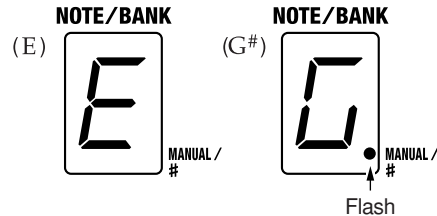

- * The dot (flash) in the lower right of the Display changes to a sharp sign (#).
- * Use your hand or other way to mute the other strings. You may be unable to tune the string accurately if other strings are vibrating during tuning.

4. First do a rough tuning so that the name of the note for the string appears in the display.

(General Tuning)

| Lo-B | 4th | 3rd | 2nd | 1st | Hi-C |
|------|-----|-----|-----|-----|------|
| B | E | A | D | G | C |

5. Tune the instrument even more accurately until the tuning meter's center (green) indicator is lit.

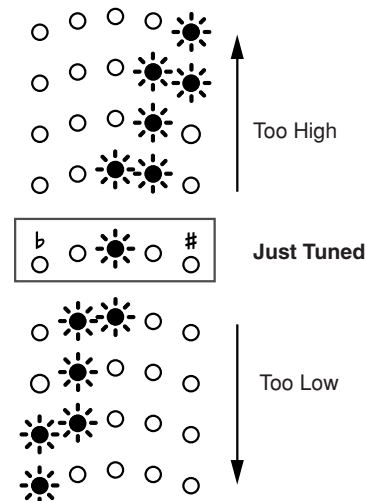

6. Repeat Steps 3-5 to tune the other strings.

HINT

One useful technique that makes tuning less confusing is to start slightly under the target pitch and then tune upwards little by little until the string is in tune.

7. Press [EDIT/EXIT] to return to the previous mode.

You can also return to the previous mode by pressing the number 1 and 2 pedals simultaneously.

Using the Foot Switch

Switching the Compressor/Limiter On and Off

With a foot switch (the optional FS-5U) connected to the FOOT SW jack on the rear panel, you can use the foot switch to switch the compressor/limiter on and off.

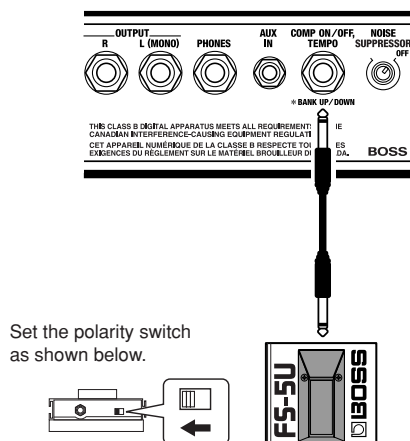

* In Memory mode, the foot switch is used to switch banks. (p. 27)

Adding an Effect Synchronized to the Performance Tempo

By using a special cable (the optional PCS-31), you can connect two foot switches, and use one to switch the compressor/limiter on and off, and the other as a tempo setting pedal.

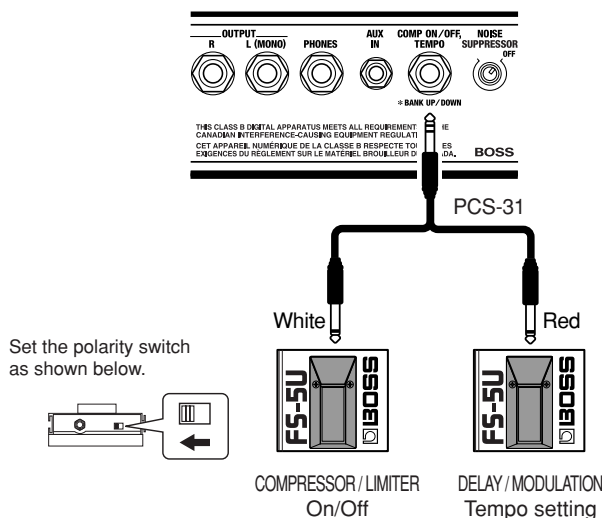

* In Memory mode, the foot switch is used to switch banks. (p. 27)

When **TAP DLY** is selected

The reference tempo is determined by the time interval between each press of the pedal. The reference tempo is calculated in terms of quarter notes, and the delay time setting is the dotted eighth note as referenced to the reference tempo.

The delay time can be set only when the effect is ON. The pedal indicator flashes in time with the tempo.

When **ANALOG DLY, 0-400 ms DLY, 300-1400 ms DLY, or CHO+DELAY** is selected

The delay time is set according to the time interval between each press of the pedal. The delay time can be set within the range of 62 ms to 1400 ms.

The delay time can be set only when the effect is ON.

* Press the pedal to set the delay time while no bass sound is playing.

When **PHASER, FLANGER, or CHORUS** is selected

The tempo is set to the interval between presses of the pedal, and the effect sound is synchronized to the performance tempo.

The tempo can be set only when the effect is ON.

* The tempo can be set to a rate period lasting from 62 ms to 2000 ms.

When **HOLD DLY** is selected

The recording or the playback stops immediately by pressing the pedal, and returns to the recording standby position.

When **CHO+REVERB** or **REVERB** is selected

No change results.

Switching Banks

In Memory mode (p. 21), with a foot switch (the optional FS-5U) connected to the FOOT SW jack on the rear panel, you can use the foot switch to switch Banks (switching up).

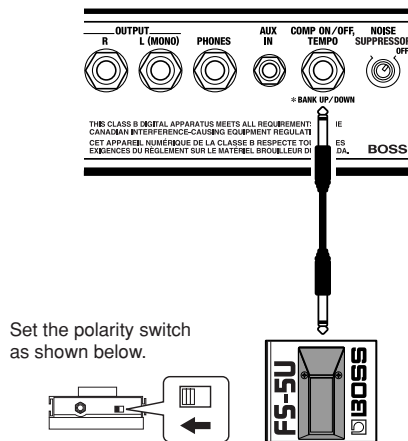

By connecting with a special cable (the optional PCS-31), you can connect two foot switches, and use them to switch Banks up and down.

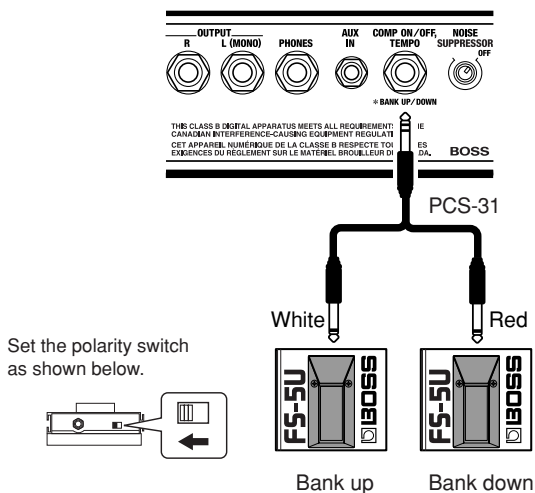

Practicing Along with CDs and MDs (AUX IN)

When playing CDs, MDs, tapes, or other such input, connect the CD or MD player, tape recorder, or other device to the AUX IN jack.

* *AUX IN is a stereo mini jack.*

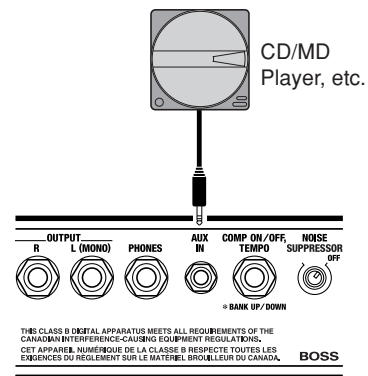

Sound input to the AUX IN jack is mixed in the ME-50B with the bass sounds, a convenient feature when using headphones for home practice and other such situations.

* *On the ME-50B, you cannot adjust the volume level of the sound input from the AUX IN jack. Adjust this on the connected equipment.*

* *Do not use a cable containing a resistor to connect CD or MD players to the AUX IN jack. If a cable incorporating resistance is used, audio from CD and MD players may become inaudible.*

Appendices

Returning the ME-50B to Its Factory Settings (Factory Reset)

You can restore all of the ME-50B's settings (24 patches and tuner reference pitch) to what they were at the time the unit was shipped from the factory.

This is referred to as "Factory Reset."

To perform Factory Reset, carry out the following steps.

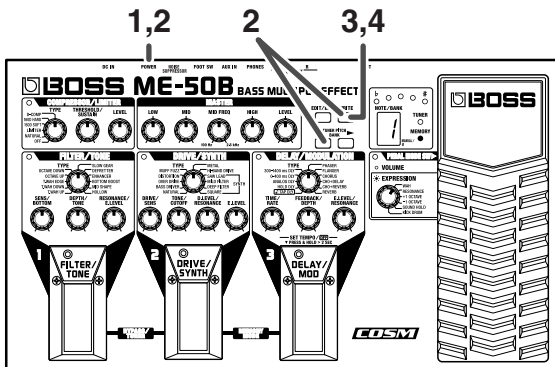

1. Turn off the power.
2. While simultaneously pressing BANK [◀] and [WRITE], turn on the power.
"F" appears in the Display.
** To cancel Factory Reset, first turn off the power, and then turn it on again.*
3. Press [WRITE].
The MEMORY indicator flashes.
4. Press [WRITE] once more.
"F" flashes in the Display, and Factory Reset is executed.

NOTE

Never turn off the power while Factory Reset is in progress.

When Factory Reset is completed, the ME-50B returns to Manual mode.

Adjusting the Expression Pedal

Although the ME-50B's expression pedal has been set for optimum operation at the factory, extended use and the operating environment can result in the pedal going out of adjustment.

If you encounter problems such as being unable to switch the PEDAL MODE SW on or off or fully cut off the sound with the volume pedal, you can use the following procedure to readjust the pedal.



When you operate the expression pedal, please be careful not to get your fingers pinched between the movable part and the panel.



In households with small children, an adult should provide supervision until the child is capable of following all the rules essential for the safe operation of the unit.

1. While simultaneously pressing BANK [▶] and [WRITE], turn on the power.
"P" appears in the Display, then changes to "U."
2. Press the heel of the expression pedal to the base, press [WRITE].
"d" appears in the Display.
3. Press the toe of the expression pedal to the base, press [WRITE].
"5" appears in the Display.
4. Adjust the PEDAL MODE SW.
Press BANK [◀] [▶] to set the value (1-9).
The smaller the value, the lighter is the depression force needed to switch the pedal on or off.
5. Press [WRITE].
Save the settings in memory, then return to Manual mode.
** If the TUNING indicator flashes during steps 2 and 3, press the pedal again, then press [WRITE].*

Troubleshooting

If there is no sound, or if it appears the ME-50B is not functioning correctly, first check the points below.

If the following measures do not solve the problem, contact your dealer or the nearest Roland Service Center.

No Sound/Volume is Low

- **Are connections to other devices correctly made?**
Check the connections once more.
- **Is the volume turned down?**
Check the volume levels on any connected amp or mixer.
- **Can you hear sound through the headphones when headphones are connected?**
If you can hear sound, it may be that there is a short in the cable used to connect the amp or other device, or perhaps a mistake in an external device's settings. Check the connecting cables and external devices once more.
- **Are volume-related parameters set to a low value?**
Check "LEVEL" and other volume parameters to make sure none is set too low.
- **Has the level been lowered with the expression pedal?**
Sound is not output when the toe of the expression pedal is in the raised position while the pedal is set to function as a volume pedal.

Patches Cannot Be Changed

- Is the ME-50B in Manual mode (p. 21)?
- Is the ME-50B in Patch Edit mode (p. 24)?
- Is the ME-50B in Tuner mode (p. 25)?

"1." to "6." is displayed when BANK [◀] [▶] is pressed

- **A number display with dot indicates a number for KICK DRUM sound.**
In Manual or Patch Edit mode, you can select the variation of kick drum sound by pressing BANK [◀] [▶] when KICK DRUM is selected, whether the effect is on or off (p. 19).

A "b" appears in the display

- **The batteries are depleted. Replace them with new batteries (p. 6).**

Specifications

ME-50B: Bass Multiple Effects

- **AD Conversion**

24 bit + AF method (*)

- **DA Conversion**

24 bit

- **Sampling Frequency**

44.1 kHz

- **Patches**

24 (user)

- **Effects**

Compressor/Limiter

Filter/Tone

T. Wah

Octave (Up/Down)

Slow Gear

Defretter

Enhancer

Bottom Boost

Mid Shape

Hollow

Drive/Synth

Overdrive/Distortion

Bass Synth

Delay/Modulation

Delay

Phaser

Flanger

Chorus

Reverb

Noise Suppressor

Master EQ

Effects for Expression Pedal

Foot Volume

Wah

Resonance

Bend (+1 Octave, -1 Octave)

Sound Hold

Kick Drum

- **Nominal Input Level**

INPUT: -10 dBu

AUX IN: -10 dBu

- **Input Impedance**

INPUT: 1 M Ω

AUX IN: 100 k Ω

- **Nominal Output Level**

-10 dBu

- **Output Impedance**

2 k Ω

- **Display**

7 segments, 1 character LED

- **Jacks**

INPUT jack

OUTPUT jacks L (MONO)/R

AUX IN jack (Stereo Mini type)

PHONES jack

FOOT SW jack (COMP ON/OFF, TEMPO)

AC Adaptor jack

- **Power Supply**

DC 9 V: Dry batteries (R6/LR6 (AA) type) x 6,

AC Adaptor (PSA series: Optional)

- **Current Draw**

140 mA

* *Expected battery life under continuous use:*

Carbon: 3.5 hours

Alkaline: 12 hours

These figures will vary depending on the actual conditions of use.

- **Dimensions**

384 (W) x 225 (D) x 78 (H) mm

15-1/8 (W) x 8-7/8 (D) x 3-1/8 (H) inches

Maximum height:

384 (W) x 225 (D) x 102 (H) mm

15-1/8 (W) x 8-7/8 (D) x 4-1/16 (H) inches

- **Weight**

3.15 kg / 7 lbs (including batteries)

- **Accessories**

Owner's Manual

Dry Batteries (Alkaline: LR6 (AA) type) x 6

Roland Service (Information Sheet)

- **Options**

AC Adaptor: BOSS PSA series

Foot Switch: BOSS FS-5U

* $0 \text{ dBu} = 0.775 \text{ Vrms}$

NOTE

In the interest of product improvement, the specifications and/or appearance of this unit are subject to change without prior notice.

(*) AF method (Adaptive Focus method)

This is a proprietary method from Roland that vastly improves the signal-to-noise (S/N) ratio of the A/D and D/A converters.

Patch List

| BANK | NO. | Description |
|------|-----|---|
| 1 | 1 | Sound using MID SHAPE, suitable for slapping play. |
| | 2 | Tube amp sound, good for rock'n roll. |
| | 3 | Touch wah sound for funk music. |
| 2 | 1 | Mellow sound of a fretless bass. Good for use with a bridge pickup. |
| | 2 | Fuzz sound of 60's. |
| | 3 | Spacy, analog synth bass sound. |
| 3 | 1 | Fat bass sound using BOTTOM BOOST. |
| | 2 | Drive sound with wild distortion. |
| | 3 | Distorted octave-up sound mixed with direct bass sound, suitable for single note playing. |
| 4 | 1 | Phaser sound suitable for slapping or picking play. |
| | 2 | Nice distorted sound with pedal wah. |
| | 3 | Sound for solo performance using  .TAP DLY and SOUND HOLD. |
| 5 | 1 | Fat, rocking sound for picking play. |
| | 2 | Wild jet phaser sound. |
| | 3 | Synth bass sound with much sound pressure. |
| 6 | 1 | Sound for R&B style of playing. |
| | 2 | A bowing type of sound using SLOW GEAR. |
| | 3 | Synth bass sound with heavy vibrato. |
| 7 | 1 | Slapping sound for funk-rock type of music. |
| | 2 | Heavy sound with a combination of OCTAVE DOWN and MUFF FUZZ. |
| | 3 | An effective synth sound. You changes pitch with use of Expression pedal. |
| 8 | 1 | An acoustic bass type sound. Play near the fret-board, using a neck pickup. |
| | 2 | Whirling flanger sound. |
| | 3 | Heavily filtered sound by combining touch wah and synth bass. |

Factory Settings

| BANK | NO. | COMPRESSOR/LIMITER | | | FILTER/TONE | | | | DRIVE/SYNTH | | | | |
|------|-----|--------------------|-----------------------|-------|--------------|-----------------|----------------|-----------------------|---------------|----------------|-----------------|-----------------------|---------|
| | | TYPE | THRESHOLD/ SUSTAIN | LEVEL | TYPE | SENS/ BOTTOM | DEPTH/ TONE | RESONANCE/ E.LEVEL | TYPE | DRIVE/ SENS | TONE/ CUTOFF | D.LEVEL/ RESONANCE | E.LEVEL |
| 1 | 1 | NATURAL | 40 | 55 | MID SHAPE | 60 | 70 | 50 | OFF | | | | |
| | 2 | NATURAL | 85 | 45 | ENHANCER | 50 | 40 | 35 | NATURAL | 75 | 50 | 0 | 60 |
| | 3 | D-COMP | 45 | 65 | T.WAH UP | 50 | 45 | 50 | OFF | | | | |
| 2 | 1 | NATURAL | 50 | 50 | DEFRETTER | 50 | 50 | 50 | OFF | | | | |
| | 2 | OFF | | | OFF | | | | MUFF FUZZ | 70 | 40 | 50 | 40 |
| | 3 | NATURAL | 40 | 55 | OFF | | | | DEEP FILTER | 25 | 35 | 35 | 40 |
| 3 | 1 | 160D SOFT | 70 | 45 | BOTTOM BOOST | 50 | 50 | 50 | OFF | | | | |
| | 2 | NATURAL | 50 | 50 | ENHANCER | 50 | 25 | 35 | BASS DRIVER | 80 | 15 | 0 | 50 |
| | 3 | OFF | | | OCTAVE UP | 50 | 100 | 50 | METAL | 90 | 30 | 75 | 50 |
| 4 | 1 | D-COMP | 40 | 45 | OFF | | | | OFF | | | | |
| | 2 | OFF | | | BOTTOM BOOST | 55 | 50 | 40 | METAL | 50 | 50 | 50 | 50 |
| | 3 | NATURAL | 40 | 55 | OCTAVE UP | 50 | 90 | 15 | OFF | | | | |
| 5 | 1 | LIMITER | 50 | 45 | ENHANCER | 50 | 20 | 50 | OFF | | | | |
| | 2 | 160D HARD | 25 | 60 | OFF | | | | MUFF FUZZ | 85 | 40 | 40 | 40 |
| | 3 | LIMITER | 50 | 50 | OFF | | | | SAW LEAD | 0 | 15 | 50 | 50 |
| 6 | 1 | NATURAL | 40 | 45 | BOTTOM BOOST | 50 | 50 | 40 | NATURAL | 20 | 45 | 0 | 80 |
| | 2 | OFF | | | SLOW GEAR | 50 | 90 | 100 | DISTORTION | 85 | 15 | 50 | 50 |
| | 3 | 160D SOFT | 40 | 65 | OFF | | | | SQUARE | 20 | 40 | 45 | 50 |
| 7 | 1 | 160D HARD | 15 | 85 | MID SHAPE | 70 | 80 | 65 | OFF | | | | |
| | 2 | NATURAL | 15 | 50 | OCTAVE DOWN | 100 | 45 | 100 | MUFF FUZZ | 100 | 25 | 80 | 40 |
| | 3 | NATURAL | 50 | 50 | OFF | | | | DEEP FILTER | 45 | 50 | 50 | 30 |
| 8 | 1 | NATURAL | 70 | 45 | HOLLOW | 100 | 50 | 30 | OFF | | | | |
| | 2 | NATURAL | 50 | 45 | OFF | | | | HI-BAND DRIVE | 100 | 60 | 85 | 45 |
| | 3 | 160D SOFT | 50 | 55 | T.WAH DOWN | 40 | 50 | 100 | SQUARE | 50 | 50 | 50 | 50 |

* The correspondence between the setting value and the actual knob position is shown on the following diagram.

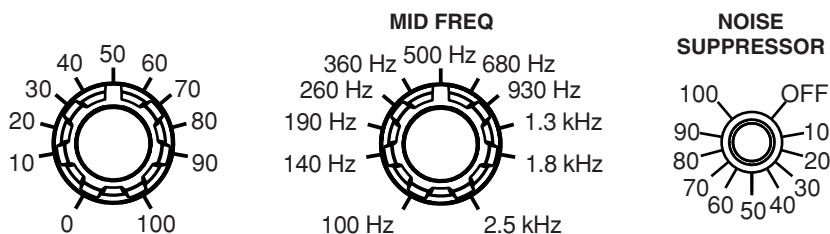

| DELAY/MODULATION | | | | Expression Pedal | | MASTER | | | | | NOISE SUPPRESSOR |
|------------------|-----------|----------------|-------------------|------------------|------------|--------|-----|----------|------|-------|------------------|
| TYPE | TIME/RATE | FEEDBACK/DEPTH | E.LEVEL/RESONANCE | PEDAL MODE | EXPRESSION | LOW | MID | MID FREQ | HIGH | LEVEL | |
| OFF | | | | VOLUME | KICK DRUM | 80 | 70 | 100 Hz | 60 | 50 | 60 |
| OFF | | | | VOLUME | WAH | 70 | 40 | 680 Hz | 40 | 50 | 60 |
| REVERB | 0 | 50 | 5 | VOLUME | -1 OCTAVE | 60 | 20 | 300 Hz | 40 | 50 | 60 |
| CHO+REVERB | 50 | 50 | 15 | VOLUME | KICK DRUM | 70 | 85 | 1.5 kHz | 50 | 50 | 40 |
| OFF | | | | VOLUME | WAH | 85 | 85 | 930 Hz | 50 | 50 | 90 |
| ANALOG DLY | 50 | 30 | 45 | VOLUME | RESONANCE | 85 | 60 | 680 Hz | 50 | 50 | 60 |
| OFF | | | | VOLUME | WAH | 50 | 85 | 1.3 kHz | 40 | 50 | 30 |
| PHASER | 0 | 0 | 0 | VOLUME | WAH | 50 | 85 | 930 Hz | 30 | 50 | 40 |
| 300-1400 ms DLY | 15 | 30 | 40 | VOLUME | WAH | 50 | 50 | 680 Hz | 50 | 50 | 90 |
| PHASER | 40 | 40 | 60 | VOLUME | WAH | 80 | 60 | 1.8 kHz | 60 | 50 | 30 |
| OFF | | | | EXPRESSION | WAH | 60 | 40 | 300 Hz | 50 | 50 | 60 |
| ♪.TAP DLY | - | 15 | 90 | EXPRESSION | SOUND HOLD | 50 | 50 | 360 Hz | 50 | 50 | 60 |
| OFF | | | | VOLUME | WAH | 75 | 80 | 360 Hz | 40 | 50 | 45 |
| PHASER | 10 | 85 | 50 | VOLUME | KICK DRUM | 70 | 50 | 500 Hz | 50 | 50 | 30 |
| OFF | | | | VOLUME | RESONANCE | 50 | 60 | 680 Hz | 50 | 50 | 30 |
| OFF | | | | VOLUME | WAH | 50 | 65 | 800 Hz | 50 | 50 | 45 |
| CHO+DELAY | 50 | 35 | 30 | VOLUME | -1 OCTAVE | 50 | 50 | 500 Hz | 50 | 50 | 70 |
| FLANGER | 85 | 50 | 15 | VOLUME | RESONANCE | 70 | 40 | 420 Hz | 60 | 50 | 60 |
| OFF | | | | VOLUME | +1 OCTAVE | 65 | 60 | 1.8 kHz | 70 | 50 | 90 |
| OFF | | | | VOLUME | WAH | 50 | 60 | 680 Hz | 45 | 50 | 70 |
| CHO+DELAY | 0 | 50 | 85 | EXPRESSION | -1 OCTAVE | 50 | 50 | 500 Hz | 50 | 50 | 75 |
| REVERB | 15 | 50 | 15 | VOLUME | SOUND HOLD | 50 | 15 | 160 Hz | 35 | 50 | 60 |
| FLANGER | 10 | 85 | 50 | VOLUME | +1 OCTAVE | 50 | 50 | 680 Hz | 40 | 50 | 30 |
| 0-400 ms DLY | 40 | 20 | 20 | VOLUME | RESONANCE | 60 | 40 | 2.1 kHz | 60 | 50 | 70 |

Blank Chart

| BANK | NO. | COMPRESSOR/LIMITER | | | FILTER/TONE | | | | DRIVE/SYNTH | | | | |
|------|-----|--------------------|-----------------------|-------|-------------|-----------------|----------------|-----------------------|-------------|----------------|-----------------|-----------------------|---------|
| | | TYPE | THRESHOLD/ SUSTAIN | LEVEL | TYPE | SENS/ BOTTOM | DEPTH/ TONE | RESONANCE/ E.LEVEL | TYPE | DRIVE/ SENS | TONE/ CUTOFF | D.LEVEL/ RESONANCE | E.LEVEL |
| 1 | 1 | | | | | | | | | | | | |
| | 2 | | | | | | | | | | | | |
| | 3 | | | | | | | | | | | | |
| 2 | 1 | | | | | | | | | | | | |
| | 2 | | | | | | | | | | | | |
| | 3 | | | | | | | | | | | | |
| 3 | 1 | | | | | | | | | | | | |
| | 2 | | | | | | | | | | | | |
| | 3 | | | | | | | | | | | | |
| 4 | 1 | | | | | | | | | | | | |
| | 2 | | | | | | | | | | | | |
| | 3 | | | | | | | | | | | | |
| 5 | 1 | | | | | | | | | | | | |
| | 2 | | | | | | | | | | | | |
| | 3 | | | | | | | | | | | | |
| 6 | 1 | | | | | | | | | | | | |
| | 2 | | | | | | | | | | | | |
| | 3 | | | | | | | | | | | | |
| 7 | 1 | | | | | | | | | | | | |
| | 2 | | | | | | | | | | | | |
| | 3 | | | | | | | | | | | | |
| 8 | 1 | | | | | | | | | | | | |
| | 2 | | | | | | | | | | | | |
| | 3 | | | | | | | | | | | | |

Blank Chart

| BANK | NO. | COMPRESSOR/LIMITER | | | FILTER/TONE | | | | DRIVE/SYNTH | | | | |
|------|-----|--------------------|-----------------------|-------|-------------|-----------------|----------------|-----------------------|-------------|----------------|-----------------|-----------------------|---------|
| | | TYPE | THRESHOLD/ SUSTAIN | LEVEL | TYPE | SENS/ BOTTOM | DEPTH/ TONE | RESONANCE/ E.LEVEL | TYPE | DRIVE/ SENS | TONE/ CUTOFF | D.LEVEL/ RESONANCE | E.LEVEL |
| 1 | 1 | | | | | | | | | | | | |
| | 2 | | | | | | | | | | | | |
| | 3 | | | | | | | | | | | | |
| 2 | 1 | | | | | | | | | | | | |
| | 2 | | | | | | | | | | | | |
| | 3 | | | | | | | | | | | | |
| 3 | 1 | | | | | | | | | | | | |
| | 2 | | | | | | | | | | | | |
| | 3 | | | | | | | | | | | | |
| 4 | 1 | | | | | | | | | | | | |
| | 2 | | | | | | | | | | | | |
| | 3 | | | | | | | | | | | | |
| 5 | 1 | | | | | | | | | | | | |
| | 2 | | | | | | | | | | | | |
| | 3 | | | | | | | | | | | | |
| 6 | 1 | | | | | | | | | | | | |
| | 2 | | | | | | | | | | | | |
| | 3 | | | | | | | | | | | | |
| 7 | 1 | | | | | | | | | | | | |
| | 2 | | | | | | | | | | | | |
| | 3 | | | | | | | | | | | | |
| 8 | 1 | | | | | | | | | | | | |
| | 2 | | | | | | | | | | | | |
| | 3 | | | | | | | | | | | | |

Index

Numerics

| | |
|-----------------------|----|
| 0-400 ms DLY | 15 |
| +1 OCTAVE | 18 |
| -1 OCTAVE | 18 |
| 160D HARD | 9 |
| 160D SOFT | 9 |
| 300-1400 ms DLY | 15 |

A

| | |
|------------------|----|
| ANALOG DLY | 15 |
| AUX IN | 27 |

B

| | |
|--------------------|-----------|
| Bank (BANK) | 21-22, 27 |
| BASS DRIVER | 12 |
| BOTTOM BOOST | 11 |
| Bypass | 20, 25 |
| BYPASS/TUNER | 25 |

C

| | |
|--------------------------|----|
| CHO+DELAY | 15 |
| CHO+REVERB | 15 |
| CHORUS | 15 |
| COMPRESSOR/LIMITER | 9 |

D

| | |
|-------------------------|-------|
| D.LEVEL/RESONANCE | 13 |
| D-COMP | 9 |
| DEEP FILTER | 12 |
| DEFRETTER | 11 |
| DELAY/MOD | 14 |
| DELAY/MODULATION | 14 |
| DEPTH/TONE | 10-11 |
| DISTORTION | 12 |
| DRIVE/SENS | 12 |
| DRIVE/SYNTH | 12 |

E

| | |
|-------------------------|-------|
| E.LEVEL | 13 |
| E.LEVEL/RESONANCE | 14-15 |
| EDIT/EXIT | 24 |
| ENHANCER | 11 |
| Expression Pedal | 18 |

F

| | |
|----------------------|-------|
| Factory Reset | 28 |
| FEEDBACK/DEPTH | 14-15 |
| FILTER/TONE | 10 |
| FLANGER | 15 |
| Foot Switch | 26 |

H

| | |
|---------------------|------------------|
| HI-BAND DRIVE | 12 |
| HIGH | 20 |
| HOLD DLY | 14, 16-17, 22-23 |
| HOLLOW | 11 |

K

| | |
|-----------------|-----------|
| KICK DRUM | 17-19, 21 |
|-----------------|-----------|

L

| | |
|---------------|-------|
| LEVEL | 9, 20 |
| LIMITER | 9 |
| LOW | 20 |

M

| | |
|--------------------|--------|
| Manual Mode | 21 |
| MASTER | 20 |
| MASTER LEVEL | 7, 21 |
| MEMORY MODE | 21 |
| Memory Mode | 21, 23 |
| METAL | 12 |
| MID | 20 |
| MID FREQ | 20 |
| MID SHAPE | 11 |
| MILD FILTER | 12 |
| MUFF FUZZ | 12 |

N

| | |
|------------------------|-------|
| NATURAL | 9, 12 |
| NOISE SUPPRESSOR | 20-21 |
| Number | 22 |
| Number Pedal | 22 |

O

| | |
|-------------------|----|
| OCTAVE DOWN | 10 |
| OCTAVE UP | 10 |
| OFF | 9 |
| OVER DRIVE | 12 |

P

| | |
|-----------------------|----|
| Patch | 21 |
| Patch Change | 22 |
| Patch Edit Mode | 24 |
| Pedal | 18 |
| PEDAL MODE SW | 18 |
| PHASER | 15 |

R

| | |
|-------------------------|-------|
| RESONANCE | 18 |
| RESONANCE/E.LEVEL | 10-11 |
| REVERB | 15 |

S

| | |
|-------------------|-------|
| SAW LEAD | 12 |
| SENS/BOTTOM | 10-11 |
| SLOW GEAR | 10 |
| SOUND HOLD | 18-19 |
| SQUARE | 12 |

T

| | |
|-------------------------|---------------|
| T.WAH DOWN | 10 |
| T.WAH EDGE | 10 |
| T.WAH UP | 10 |
| ♩.TAP DLY | 14, 16, 22-23 |
| THRESHOLD/SUSTAIN | 9 |
| TIME/RATE | 14-15 |
| TONE/CUTOFF | 13 |
| TUNER | 25 |
| Tuner Mode | 25 |
| TUNER PITCH | 25 |
| Tuning | 25 |
| TYPE | 9-10, 12, 14 |

V

| | |
|--------------------|----|
| Volume Pedal | 18 |
|--------------------|----|

W

| | |
|-------------|----|
| WAH | 18 |
| WRITE | 22 |
| Write | 22 |



This product complies with the requirements of European Directive 89/336/EEC.

For EU Countries

FEDERAL COMMUNICATIONS COMMISSION RADIO FREQUENCY INTERFERENCE STATEMENT

This equipment has been tested and found to comply with the limits for a Class B digital device, pursuant to Part 15 of the FCC Rules. These limits are designed to provide reasonable protection against harmful interference in a residential installation. This equipment generates, uses, and can radiate radio frequency energy and, if not installed and used in accordance with the instructions, may cause harmful interference to radio communications. However, there is no guarantee that interference will not occur in a particular installation. If this equipment does cause harmful interference to radio or television reception, which can be determined by turning the equipment off and on, the user is encouraged to try to correct the interference by one or more of the following measures:

- Reorient or relocate the receiving antenna.
- Increase the separation between the equipment and receiver.
- Connect the equipment into an outlet on a circuit different from that to which the receiver is connected.
- Consult the dealer or an experienced radio/TV technician for help.

This device complies with Part 15 of the FCC Rules. Operation is subject to the following two conditions:

- (1) This device may not cause harmful interference, and
- (2) This device must accept any interference received, including interference that may cause undesired operation.

Unauthorized changes or modification to this system can void the users authority to operate this equipment.
This equipment requires shielded interface cables in order to meet FCC class B Limit.

For the USA

For Canada

NOTICE

This Class B digital apparatus meets all requirements of the Canadian Interference-Causing Equipment Regulations.

AVIS

Cet appareil numérique de la classe B respecte toutes les exigences du Règlement sur le matériel brouilleur du Canada.

Free Manuals Download Website

<http://myh66.com>

<http://usermanuals.us>

<http://www.somanuals.com>

<http://www.4manuals.cc>

<http://www.manual-lib.com>

<http://www.404manual.com>

<http://www.luxmanual.com>

<http://aubethermostatmanual.com>

Golf course search by state

<http://golfingnear.com>

Email search by domain

<http://emailbydomain.com>

Auto manuals search

<http://auto.somanuals.com>

TV manuals search

<http://tv.somanuals.com>