

**POLY OCTAVE**

**OC-20G**

**GK EFFECT**

**GK**

## Owner's Manual

Thank you, and congratulations on your choice of BOSS OC-20G GK Effect.

Before using this unit, carefully read the sections entitled: "USING THE UNIT SAFELY" and "IMPORTANT NOTES" (p. 18; p. 21).

These sections provide important information concerning the proper operation of the unit. Additionally, in order to feel assured that you have gained a good grasp of every feature provided by your new unit, Owner's manual should be read in its entirety. The manual should be saved and kept on hand as a convenient reference.

### Main Features

- New kind of effect for use with GK pickups and GK-Ready guitars.
- Six independent selectable octave processors: on for each string.
- Built-in distortion for ultra-heavy sound.
- Send and return for direct guitar signal.
- The controls and pedals provide simple and intuitive operation.
- Can run on battery power (six AA type).

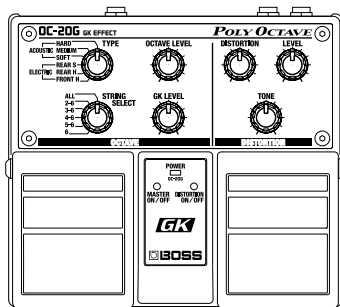

Copyright © 2001 BOSS CORPORATION

All rights reserved. No part of this publication may be reproduced in any form without the written permission of BOSS CORPORATION.

**BOSS**

# Installing Batteries

Insert the included batteries as shown in figure, being careful to orient the batteries correctly.

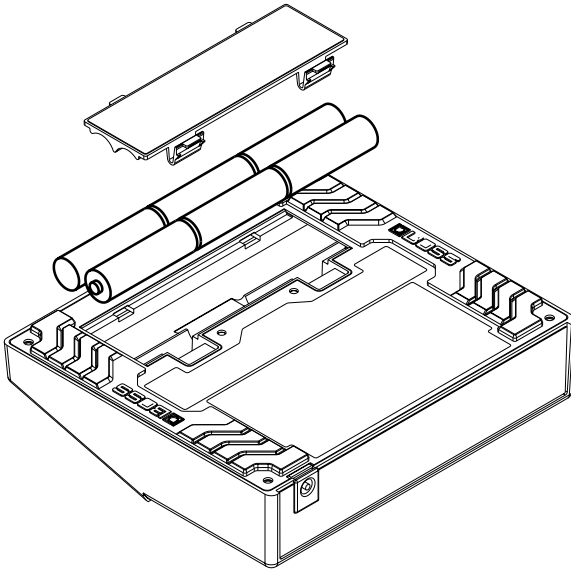

## NOTE

- When turning the unit upside-down, get a bunch of newspapers or magazines, and place them under the four corners or at both ends to prevent damage to controls. Also, you should try to orient the unit so no controls get damaged.
- When turning the unit upside-down, handle with care to avoid dropping it, or allowing it to fall or tip over.
- Make sure the “+” and “-” ends of the batteries are oriented correctly.
- When the batteries run down, the POWER indicator gets dim. If this happens, replace with new batteries.
- When replacing the batteries, use six AA type.
- Do not mix fresh batteries with used ones, or mix batteries of different types. Doing so can result in fluid leakage.
- Battery life can vary depending on battery type.

## MEMO

Continuous usage time under battery power is about 6 hours with alkaline batteries and about 2 hours with carbon batteries. (This may vary according to usage conditions.)

# Making the Connections

## About the GK-2A

To use the OC-20G with a guitar equipped with the GK-2A (or other GK-compatible guitar), you will need an optional GK cable.

Refer to the GK-2A Owner's Manual for instructions on installing the GK-2A.

## S1/S2 Switch

The GK-2A's S1/S2 switches correspond to this unit's MASTER On/Off pedal and Distortion On/Off pedal, respectively.

## Selection Switch

Set to the "MIX" position.

Note that this unit processes tones using the instrument's divided pickup signal (signal output when SYNTH is selected).



**NOTE** No sound is produced when the following settings are combined.

| GK-2A  | This unit's settings                         |
|--------|--|
| SYNTH  | MASTER: OFF                                  |
| GUITAR | MASTER: ON + NORMAL PU MIX: OFF (rear panel) |

## SYNTH VOL Knob

Controls the volume when MASTER ON is selected.

## Connecting

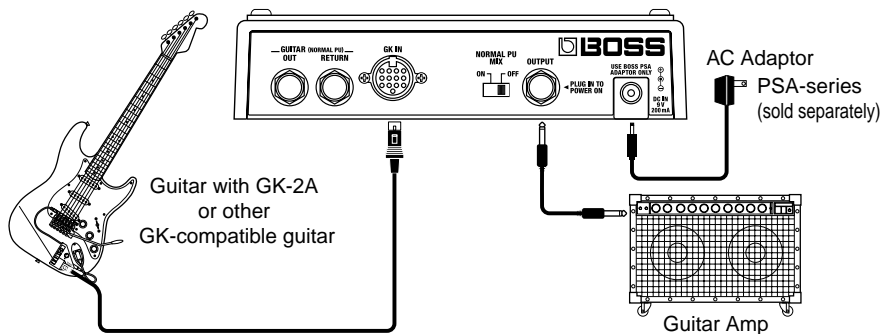

## NOTE

- To get the best performance from the instrument, set your amp to “Clean” (no distortion).
  - When connecting the instrument to a guitar amp, make the necessary adjustments to get the most suitable tone. When recording direct, use this with a COSM amp (GT-3, GP-20 etc.).
  - When connecting a GK cable, insert the cable completely until the connector is securely locked. When disconnecting, press the connector’s lock while you detach the cable.
- \* Always turn the amp volume down completely before connecting and disconnecting cords.*
- \* To prevent malfunction and/or damage to speakers or other devices, always turn down the volume, and turn off the power on all devices before making any connections.*
- \* If there are batteries in the unit while an AC adaptor is being used, normal operation will continue should the line voltage be interrupted (power blackout or power cord disconnection).*

## Turning On the Power

Be sure to observe the following order when connecting devices and switching on the power to your equipment. By turning on devices in the wrong order, you risk causing malfunction and/or damage to speakers and other devices.

Connect the GK-2A → (Connect the AC Adaptor) → Connect the Amp → Turn On Amp Power

- \* When the unit is running on battery power, the power comes on when you insert the connector plug into the OUTPUT jack.*
- \* Always make sure to have the volume level turned down before switching on power. Even with the volume all the way down, you may still hear some sound when the power is switched on, but this is normal, and does not indicate a malfunction.*
- \* When operating on battery power only, the unit’s indicator will become dim when battery power gets too low. Replace the battery as soon as possible.*

# Operating Instructions

## Using the Pedals

“MASTER: ON” and “DISTORTION: OFF” are selected when the power is turned on.

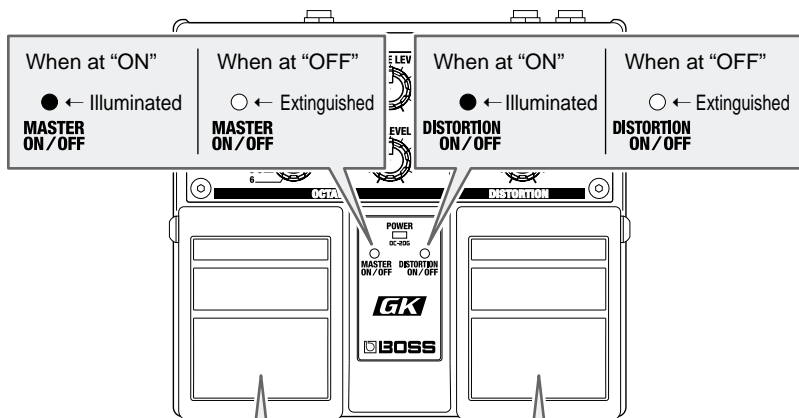

Master is toggled on and off by stepping on the MASTER On/Off pedal. When switched on, the GK effect sound is output. When off, the output from the divided pickup is muted, and the sounds from the normal pickup (or the sounds input to GUITAR RETURN) are output without change.

Distortion is toggled on and off by stepping on the Distortion On/Off pedal. When Master is off, you can switch the distortion on and off in order to prepare the settings.



**NOTE** Distortion is not applied to the output from the normal pickup.

## Panel Operations

In order to follow along with the instructions given here, you should start out by having Master switched ON (depress the MASTER On/Off pedal and confirm that the MASTER ON/OFF indicator has lighted). Also, step on the Distortion On/Off pedal to switch OFF distortion (DISTORTION ON/OFF indicator extinguished).



**You should make GK LEVEL, OCTAVE LEVEL, DISTORTION, TONE, and LEVEL adjustments after first aligning the knob to the center position.**

**1.** Select the tone for the GK sound (the sound at the original pitch). You can select from six different tones.

**2.** Turn the STRING SELECT knob to select the string to which the octave sound is to be added. You can select from six different settings, from all strings to only the sixth string.

**3.** Turn the GK LEVEL knob to adjust the volume of the sound at the original pitch.

**4.** Turn the OCTAVE LEVEL knob to adjust the volume of the sound at the octave.

**HINT** Try switching the MASTER On/Off pedal on and off as you get the balance between the GK sound and octave sound, adjusting the levels until they are roughly the same.

**5.** Press the Distortion On/Off pedal to turn the distortion on (DISTORTION ON/OFF indicator lit).

**6.** Turn the DISTORTION knob to adjust the distortion.

**7.** Turn the TONE knob to adjust the tone.

**8.** Turn the Level knob to adjust the volume level.

**HINT** Switch the Distortion On/Off pedal on and off and adjust until the volume levels are roughly the same.

The diagram shows a control panel with the following components: 'DC-20G GK EFFECT' section with 'TYPE' knob (settings: HARD, ACQUITE, MEDIUM, SOFT) and 'STRING SELECT' knob (settings: ALL, 2-6, 3-6, 4-6, 5-6, 6); 'POLY OCTAVE' section with 'OCTA. LEVEL' knob, 'GK LEVEL' knob, 'DISTORTION' knob, and 'LEVEL' knob; and two foot pedals labeled 'OCTAVE' and 'DISTO. ON/OFF'.

# Part Names and Functions

## Front Panel

### OCTAVE

#### TYPE Knob

Select the tone for the GK Direct sound (the sound at the original pitch).

**ACOUSTIC HARD:** Bright and lively acoustic guitar sound.

**ACOUSTIC MEDIUM:** Acoustic guitar sound between HARD and SOFT.

**ACOUSTIC SOFT:** Richly resonant acoustic guitar sound with body.

**ELECTRIC REAR S:** Rear single coil pickup tone.

**ELECTRIC REAR H:** Rear humbucking pickup tone.

**ELECTRIC FRONT H:** Front humbucking pickup tone.

#### OCTAVE LEVEL Knob

Adjusts the volume of the octave sound.

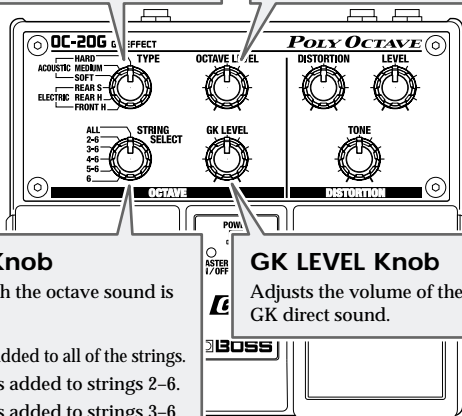

#### STRING SELECT Knob

Select the strings to which the octave sound is to be added.

**ALL:** The octave sound is added to all of the strings.

**2-6:** The octave sound is added to strings 2-6.

**3-6:** The octave sound is added to strings 3-6.

**4-6:** The octave sound is added to strings 4-6.

**5-6:** The octave sound is added to strings 5 and 6.

**6:** The octave sound is added only to the sixth string.

#### GK LEVEL Knob

Adjusts the volume of the GK direct sound.

## DISTORTION

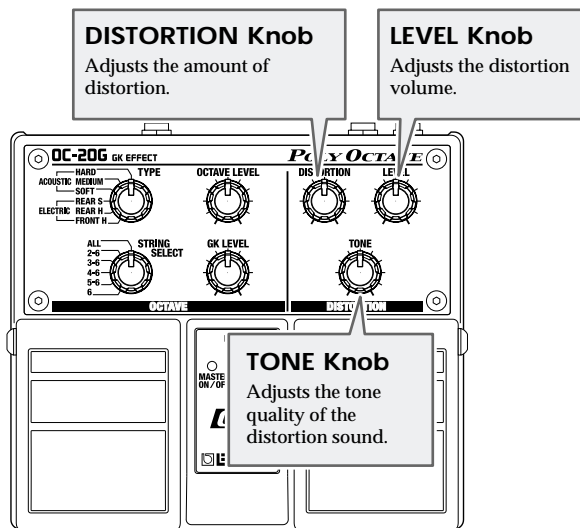



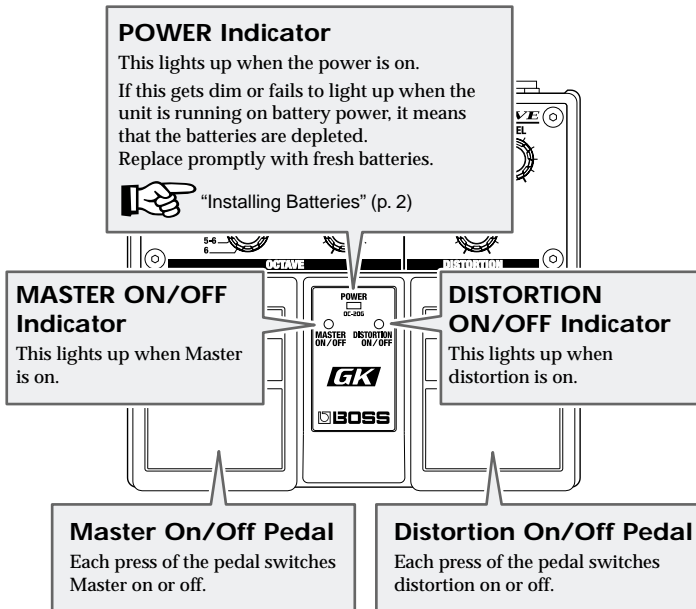

## Rear Panel

### NORMAL PU MIX Switch

When Master is on, this switch determines whether or not the normal pickup sounds (or the sounds input to the GUITAR RETURN) are mixed.



By mixing the normal pickup sound, you can create a sound that makes your guitar sound come alive.

### GK IN Connector

This connector is for connecting your guitar with a GK cable.

### AC ADAPTOR Jack

This jack is for connecting an AC adapter (BOSS PSA-series, sold separately).

Using an AC adapter makes possible long performances with no worry about batteries going dead.

### GUITAR OUT Jack

Normal pickup signals input through the GK-2A are output.



When a cable is connected to this jack, the output of the normal pickup from the OUTPUT jack stops.

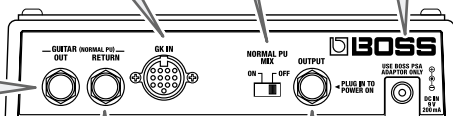

### GUITAR RETURN Jack

This is an input jack for connecting another effects device, electric guitar, or other instrument.

When connected to this jack, you can use sounds other than the normal pickup when Master is off, and for the Mix sounds when Master is on.

(refer to p.11, 12)

### OUTPUT Jack

This jack is for connection to a guitar amp, another effects processor.

\* The OUTPUT jack also doubles as the power switch when the unit is running on battery power. The power comes on when a plug is inserted into the INPUT jack, and goes off when it is unplugged. Unplug any connected cords when the unit is not in use.

# Application Examples

## Using in Combination with Other Effect Devices

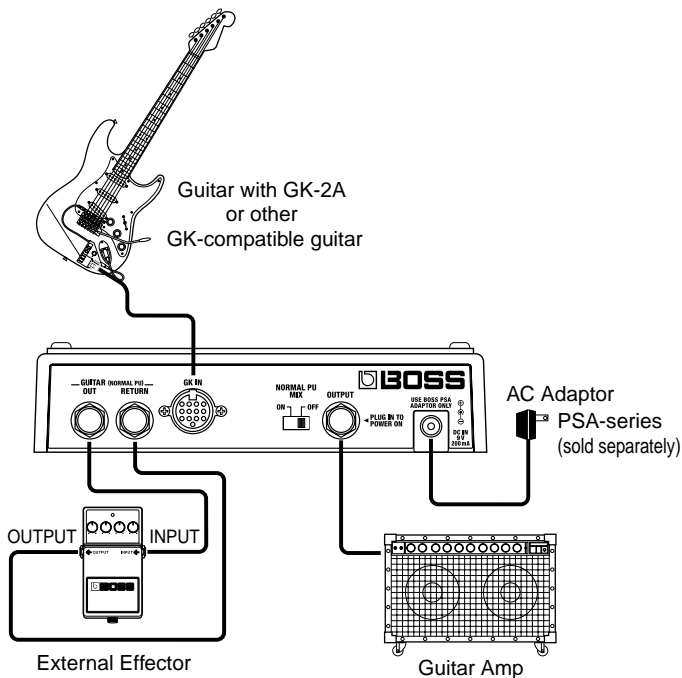

## Using in Combination with Another GK EFFECT (WP-20G)

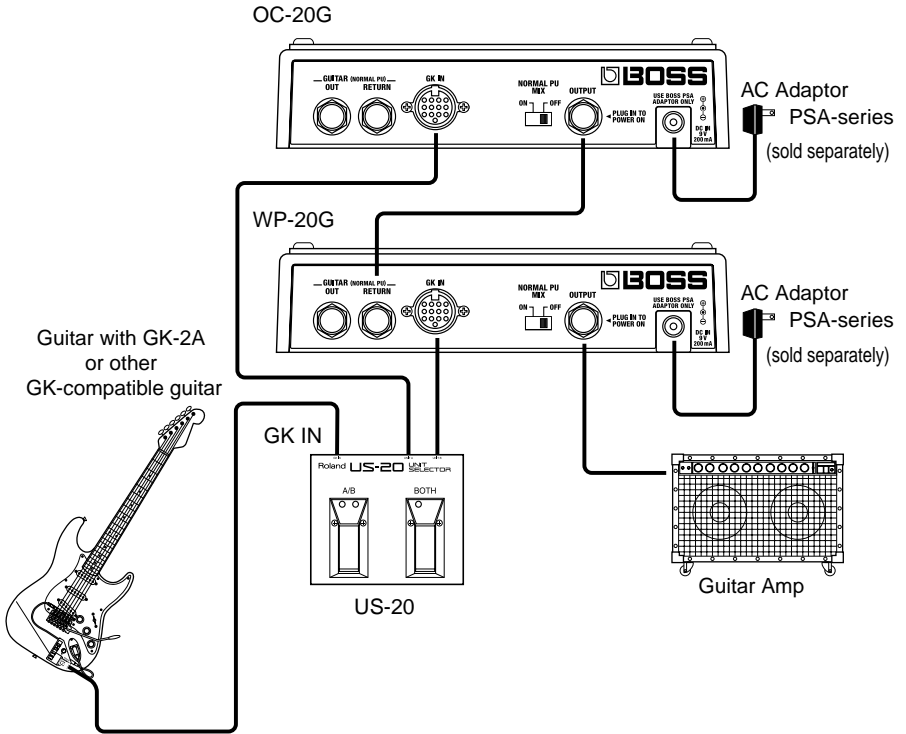

## Using in Combination with the GR-33

Guitar with GK-2A  
or other  
GK-compatible guitar

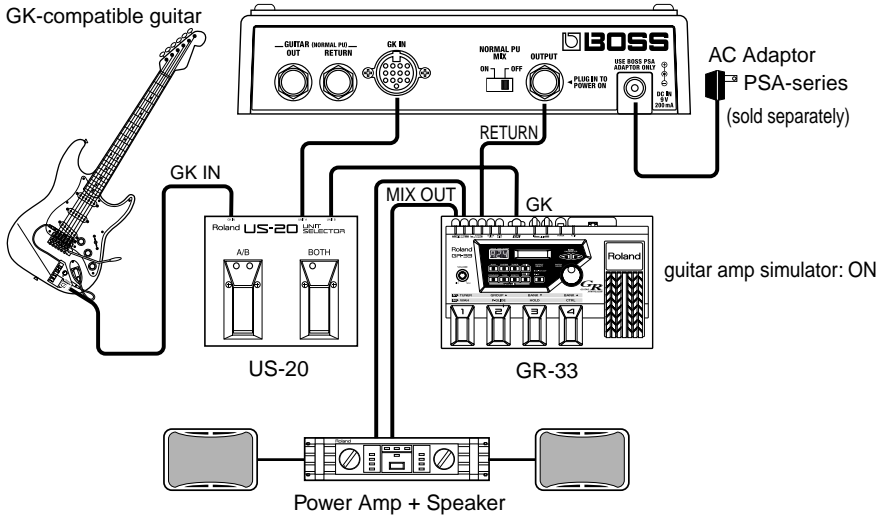

# Troubleshooting

## The power doesn't come on.

- **Is the external device connected correctly to the OUTPUT jack?**
  - Check the connections again.
- \* *When running off batteries, the unit won't switch on unless there's something plugged into the OUTPUT jack. This helps conserve the batteries.*
- **Have the batteries run down?**
  - Replace with fresh batteries (p. 2).
- **Is the specified AC adaptor (PSA-series sold separately) connected correctly?**
  - Check the connections again (p. 3, 4).

## There is no sound/volume is too low.

- **Is the other equipment connected correctly?**
  - Check the connections again (p. 3, 4).
- **Is the volume turned down on the connected guitar amp, effects processor, or other device?**
  - Check the settings on the connected equipment (p. 3, 4).
- **Is the GK-2A correctly installed and connected?**
  - After reading the instructions in the GK-2A Owner's Manual, check the installation once more. Also, confirm that the guitar and the GK-2A have been connected properly, using the supplied cable.
- **Is the GK-2A's SYNTH VOL turned down?**
  - Check to make sure the GK-2A's SYNTH VOL is not lowered.
- **Is the GK-2A's selection switch set to "MIX?"**
  - When set to "GUITAR" or "SYNTH," the necessary signals may not be input to the unit, which may prevent sounds from being produced.

## No effects are being applied.

- **Is the GK-2A's selection switch set to "MIX?"**
  - ➔ When set to "GUITAR" or "SYNTH," the necessary signals may not be input to the unit, which may prevent effects from being applied.
- **No effects are applied to sounds input to GUITAR RETURN and normal pickup sounds.**

## Noise is produced.

- **Is the external device connected to the GUITAR RETURN jack working properly?**
  - ➔ When the GUITAR RETURN jack is used, the signals input to this jack are used instead of the normal pickup sound.  
Therefore, noise may be produced when you've failed to switch on the external device's power, or you haven't hooked it up properly.
- **Is the GK cable securely connected?**
  - ➔ When connecting the GK cable, insert the connector completely, until it is locked.

# Sample Settings

## Warm Octave Sound

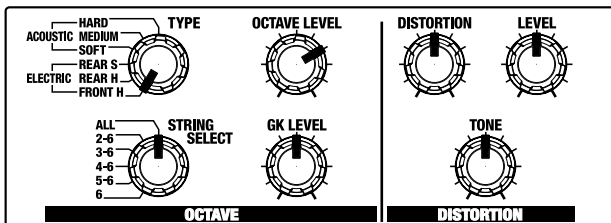

## Acoustic Sound (String 5, 6: Bass)

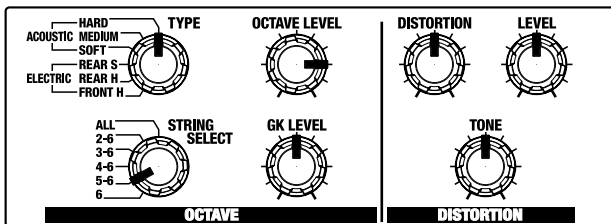

## Heavy Distortion Sound

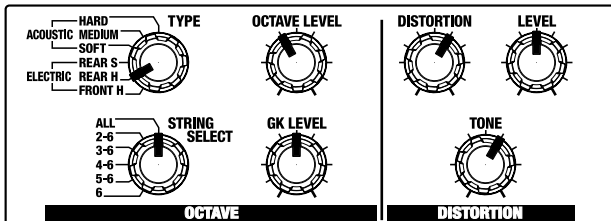



# Specifications

## OC-20G: GK EFFECT

### Controls

Master On/Off Pedal  
Distortion On/Off Pedal  
TYPE Knob  
STRING SELECT Knob  
OCTAVE LEVEL Knob  
GK LEVEL Knob  
DISTORTION Knob  
TONE Knob  
LEVEL Knob  
NORMAL PU MIX Switch

### Indicator

POWER Indicator  
(serves also as battery check indicator)  
MASTER ON/OFF Indicator  
DISTORTION ON/OFF Indicator

### Connectors

GUITAR OUT Jack  
GUITAR RETURN Jack  
GK IN Connector  
OUTOUT Jack  
DC IN Jack (DC 9 V)

### Nominal Input Level

-20 dBu

### Input Impedance

1 M $\Omega$

### Nominal Output Level

-20 dBu

### Output Impedance

OUTPUT : 1 k $\Omega$   
GUITAR OUT : 100  $\Omega$

### Recommended Load Impedance

10 k $\Omega$  or greater

### Residual Noise Level

-96 dBu  
(GK IN: terminated, Effects: OFF, Normal  
PU Mix: OFF, IHF-A, typ.)

### Power Supply

DC 9 V: Dry Battery x 6, AC Adaptor

### Current Draw

150 mA (9 V, with GK-2A)

\* *Expected battery life under continuous use:*

*Carbon : 2 hours*

*Alkaline : 6 hours*

*These figures will vary depending on the actual conditions of use.*

### Dimensions

173 (W) x 158 (D) x 57 (H) mm  
6-13/16 (W) x 6-1/4 (D) x 2-1/4 (H) inches

### Weight

1.1 kg / 2 lbs 7 oz (including batteries)

### Accessories

Dry Battery (LR6 (AA) type) x 6  
Owner's Manual  
Roland Service (Information sheet)

### Options

AC Adaptor : PSA series  
Divided Pickup: GK-2A (Roland)  
Unit Selector : US-20 (Roland)  
GK Connecting Cable: C-13B (10 m: Roland)

\*  $0 \text{ dBu} = 0.775 \text{ Vrms}$





In the interest of product improvement, the specifications and/or appearance of this unit are subject to change without prior notice.







# USING THE UNIT SAFELY

## INSTRUCTIONS FOR THE PREVENTION OF FIRE, ELECTRIC SHOCK, OR INJURY TO PERSONS

About  WARNING and  CAUTION Notices

|   |  |
|---|--|
|  <b>WARNING</b> | Used for instructions intended to alert the user to the risk of death or severe injury should the unit be used improperly.   |
|  <b>CAUTION</b> | Used for instructions intended to alert the user to the risk of injury or material damage should the unit be used improperly.<br>* Material damage refers to damage or other adverse effects caused with respect to the home and all its furnishings, as well to domestic animals or pets. |

About the Symbols

|   |  |
|---|--|
|  | The  symbol alerts the user to important instructions or warnings. The specific meaning of the symbol is determined by the design contained within the triangle. In the case of the symbol at left, it is used for general cautions, warnings, or alerts to danger.         |
|  | The  symbol alerts the user to items that must never be carried out (are forbidden). The specific thing that must not be done is indicated by the design contained within the circle. In the case of the symbol at left, it means that the unit must never be disassembled. |
|  | The  symbol alerts the user to things that must be carried out. The specific thing that must be done is indicated by the design contained within the circle. In the case of the symbol at left, it means that the power-cord plug must be unplugged from the outlet.        |

### ALWAYS OBSERVE THE FOLLOWING

#### **WARNING**

- Before using this unit, make sure to read the instructions below, and the Owner's Manual. 



---

- Do not open (or modify in any way) the unit or its AC adaptor. 

---

- Do not attempt to repair the unit, or replace parts within it (except when this manual provides specific instructions directing you to do so). Refer all servicing to your retailer, the nearest Roland Service Center, or an authorized Roland distributor, as listed on the "Information" page. 

#### **WARNING**

- Never use or store the unit in places that are:
  - Subject to temperature extremes (e.g., direct sunlight in an enclosed vehicle, near a heating duct, on top of heat-generating equipment); or are 
  - Damp (e.g., baths, washrooms, on wet floors); or are 
  - Humid; or are
  - Exposed to rain; or are
  - Dusty; or are
  - Subject to high levels of vibration.

---

- Make sure you always have the unit placed so it is level and sure to remain stable. Never place it on stands that could wobble, or on inclined surfaces. 

**⚠ WARNING**

- Use only the specified AC adaptor, and make sure the line voltage at the installation matches the input voltage specified on the AC adaptor's body. Other AC adaptors may use a different polarity, or be designed for a different voltage, so their use could result in damage, malfunction, or electric shock.



- Do not excessively twist or bend the power cord, nor place heavy objects on it. Doing so can damage the cord, producing severed elements and short circuits. Damaged cords are fire and shock hazards!



- This unit, either alone or in combination with an amplifier and headphones or speakers, may be capable of producing sound levels that could cause permanent hearing loss. Do not operate for a long period of time at a high volume level, or at a level that is uncomfortable. If you experience any hearing loss or ringing in the ears, you should immediately stop using the unit, and consult an audiologist.



- Do not allow any objects (e.g., flammable material, coins, pins); or liquids of any kind (water, soft drinks, etc.) to penetrate the unit.



**⚠ WARNING**

- Immediately turn the power off, remove the AC adaptor from the outlet, and request servicing by your retailer, the nearest Roland Service Center, or an authorized Roland distributor, as listed on the "Information" page when:



- The AC adaptor or the power-supply cord has been damaged; or
- Objects have fallen into, or liquid has been spilled onto the unit; or
- The unit has been exposed to rain (or otherwise has become wet); or
- The unit does not appear to operate normally or exhibits a marked change in performance.

- In households with small children, an adult should provide supervision until the child is capable of following all the rules essential for the safe operation of the unit.



- Protect the unit from strong impact. (Do not drop it!)



- Do not force the unit's power-supply cord to share an outlet with an unreasonable number of other devices. Be especially careful when using extension cords—the total power used by all devices you have connected to the extension cord's outlet must never exceed the power rating (watts/ amperes) for the extension cord. Excessive loads can cause the insulation on the cord to heat up and eventually melt through.



- Before using the unit in a foreign country, consult with your retailer, the nearest Roland Service Center, or an authorized Roland distributor, as listed on the "Information" page.



## **WARNING**

- Batteries must never be recharged, heated, taken apart, or thrown into fire or water.



## **CAUTION**

- The unit and the AC adaptor should be located so their location or position does not interfere with their proper ventilation.



- Always grasp only the plug or the body of the AC adaptor when plugging into, or unplugging from, an outlet or this unit.



- Whenever the unit is to remain unused for an extended period of time, disconnect the AC adaptor.



- Try to prevent cords and cables from becoming entangled. Also, all cords and cables should be placed so they are out of the reach of children.



- Never climb on top of, nor place heavy objects on the unit.



- Never handle the AC adaptor body, or its plugs, with wet hands when plugging into, or unplugging from, an outlet or this unit.



- Before moving the unit, disconnect the AC adaptor and all cords coming from external devices.



## **CAUTION**

- Before cleaning the unit, turn off the power and unplug the AC adaptor from the outlet (p. 3).



- Whenever you suspect the possibility of lightning in your area, disconnect the AC adaptor from the outlet.



- If used improperly, batteries may explode or leak and cause damage or injury. In the interest of safety, please read and observe the following precautions (p. 2).



- Carefully follow the installation instructions for batteries, and make sure you observe the correct polarity.
- Avoid using new batteries together with used ones. In addition, avoid mixing different types of batteries.
- Remove the batteries whenever the unit is to remain unused for an extended period of time.
- If a battery has leaked, use a soft piece of cloth or paper towel to wipe all remnants of the discharge from the battery compartment. Then install new batteries. To avoid inflammation of the skin, make sure that none of the battery discharge gets onto your hands or skin. Exercise the utmost caution so that none of the discharge gets near your eyes. Immediately rinse the affected area with running water if any of the discharge has entered the eyes.
- Never keep batteries together with metallic objects such as ballpoint pens, necklaces, hairpins, etc.



- Used batteries must be disposed of in compliance with whatever regulations for their safe disposal that may be observed in the region in which you live.



# IMPORTANT NOTES

In addition to the items listed under “USING THE UNIT SAFELY” on page 18–20, please read and observe the following:

## Power Supply: Use of Batteries

- Do not use this unit on the same power circuit with any device that will generate line noise (such as an electric motor or variable lighting system).
- The AC adaptor will begin to generate heat after long hours of consecutive use. This is normal, and is not a cause for concern.
- The use of an AC adaptor is recommended as the unit’s power consumption is relatively high. Should you prefer to use batteries, please use the alkaline type.
- Batteries should always be installed or replaced before connecting any other devices. This way, you can prevent malfunction and/or damage to speakers or other devices.
- Batteries are supplied with the unit. The life of these batteries may be limited, however, since their primary purpose was to enable testing.
- Before connecting this unit to other devices, turn off the power to all units. This will help prevent malfunctions and/or damage to speakers or other devices.

## Placement

- Using the unit near power amplifiers (or other equipment containing large power transformers) may induce hum. To alleviate the problem, change the orientation of this unit; or move it farther away from the source of interference.
- This device may interfere with radio and television reception. Do not use this device in the vicinity of such receivers.
- To avoid possible breakdown, do not use the unit in a wet area, such as an area exposed to rain or other moisture.

## Maintenance

- For everyday cleaning wipe the unit with a soft, dry cloth or one that has been slightly dampened with water. To remove stubborn dirt, use a cloth impregnated with a mild, non-abrasive detergent. Afterwards, be sure to wipe the unit thoroughly with a soft, dry cloth.
- Never use benzine, thinners, alcohol or solvents of any kind, to avoid the possibility of discoloration and/or deformation.

## Additional Precautions

- Use a reasonable amount of care when using the unit's buttons, sliders, or other controls; and when using its jacks and connectors. Rough handling can lead to malfunctions.
- When connecting / disconnecting all cables, grasp the connector itself—never pull on the cable. This way you will avoid causing shorts, or damage to the cable's internal elements.
- To avoid disturbing your neighbors, try to keep the unit's volume at reasonable levels. You may prefer to use headphones, so you do not need to be concerned about those around you (especially when it is late at night).
- When you need to transport the unit, package it in the box (including padding) that it came in, if possible. Otherwise, you will need to use equivalent packaging materials.



For EU Countries

This product complies with the requirements of European Directive 89/336/EEC.

For the USA

## FEDERAL COMMUNICATIONS COMMISSION RADIO FREQUENCY INTERFERENCE STATEMENT

This equipment has been tested and found to comply with the limits for a Class B digital device, pursuant to Part 15 of the FCC Rules. These limits are designed to provide reasonable protection against harmful interference in a residential installation. This equipment generates, uses, and can radiate radio frequency energy and, if not installed and used in accordance with the instructions, may cause harmful interference to radio communications. However, there is no guarantee that interference will not occur in a particular installation. If this equipment does cause harmful interference to radio or television reception, which can be determined by turning the equipment off and on, the user is encouraged to try to correct the interference by one or more of the following measures:

- Reorient or relocate the receiving antenna.
- Increase the separation between the equipment and receiver.
- Connect the equipment into an outlet on a circuit different from that to which the receiver is connected.
- Consult the dealer or an experienced radio/TV technician for help.

This device complies with Part 15 of the FCC Rules. Operation is subject to the following two conditions:

- (1) This device may not cause harmful interference, and
- (2) This device must accept any interference received, including interference that may cause undesired operation.

Unauthorized changes or modification to this system can void the users authority to operate this equipment. This equipment requires shielded interface cables in order to meet FCC class B Limit.

For Canada

## NOTICE

This Class B digital apparatus meets all requirements of the Canadian Interference-Causing Equipment Regulations.

## AVIS

Cet appareil numérique de la classe B respecte toutes les exigences du Règlement sur le matériel brouilleur du Canada.



**BOSS Corporation**

G6017291

Download from [Www.Somanuals.com](http://www.Somanuals.com). All Manuals Search And Download.



## Free Manuals Download Website

<http://myh66.com>

<http://usermanuals.us>

<http://www.somanuals.com>

<http://www.4manuals.cc>

<http://www.manual-lib.com>

<http://www.404manual.com>

<http://www.luxmanual.com>

<http://aubethermostatmanual.com>

Golf course search by state

<http://golfingnear.com>

Email search by domain

<http://emailbydomain.com>

Auto manuals search

<http://auto.somanuals.com>

TV manuals search

<http://tv.somanuals.com>