

# BRAUN

## Braun Flex Integral 5015

Type 5507

English  
Use Instructions  
Guarantee  
Service Centers

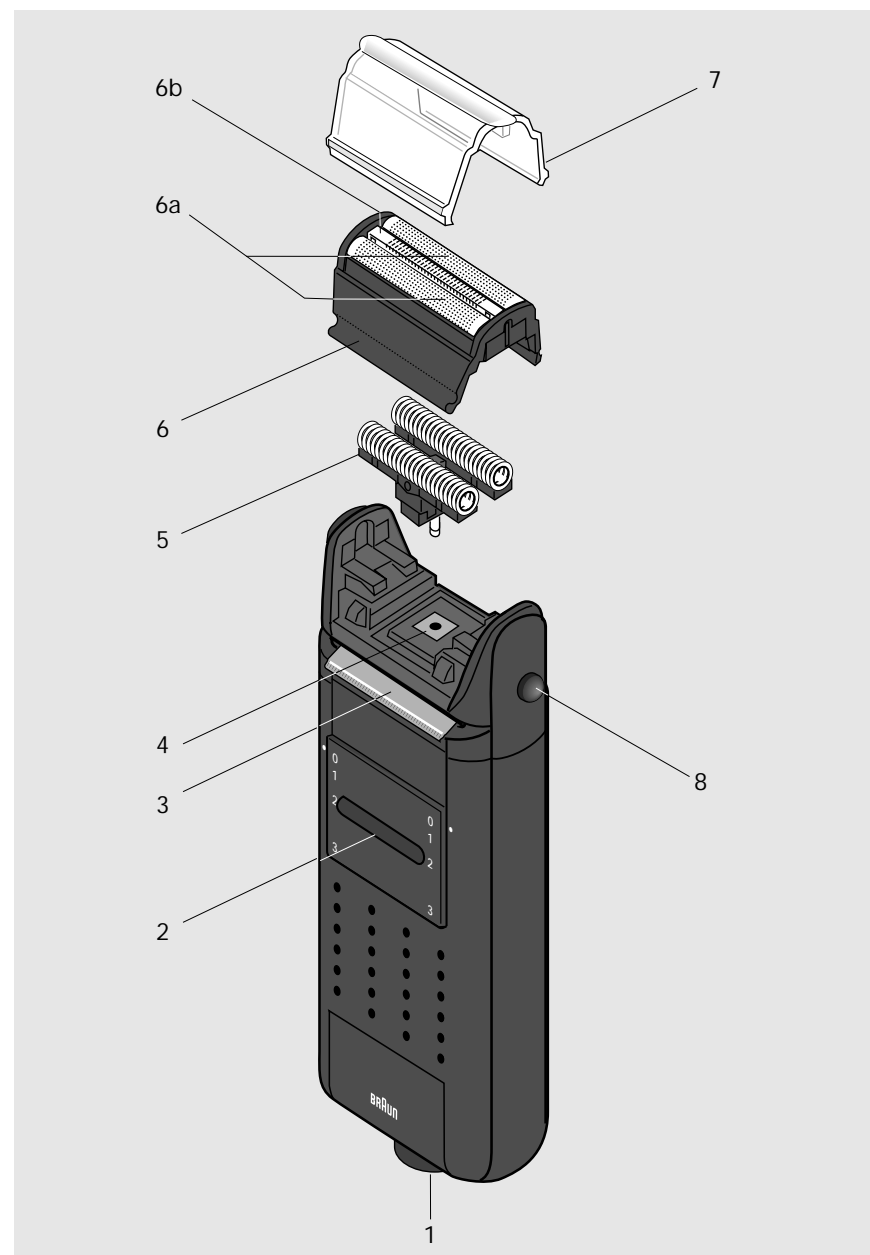

## English

Our products are engineered to meet the highest standards of quality, functionality and design. We hope you thoroughly enjoy your new Braun appliance.

### Caution

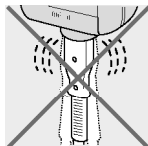

- Do not use the shaver near or over basins filled with water (e. g. bath tubs, showers etc.).
- Periodically check the cord for damages particularly at each end where the cord enters the plug.
- Replace the cord for safety reasons, if it is loose in the shaver socket ①.
- Do not wind the cord around the shaver.

## Braun Flex Integral 5015

### Pivoting head and triple shaving system

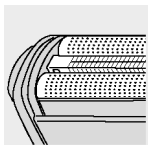
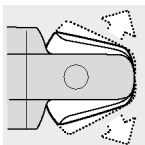

This shaver is equipped with a pivoting head which has a triple shaving system with an integrated longhair cutter. The pivoting head swings to both sides and thus automatically adjusts itself to the contours of your face within its swinging angle. The triple shaving frame ⑥ with its twin foil ⑥a and the integrated longhair cutter ⑥b provide a permanent combination shave.

This means that the integrated longhair cutter cuts the longer hairs, while the twin foil ⑥a together with the cutterblock ⑤ under the foil, provide a close shave – all in one stroke.

### Specifications

- Wattage: 3 W.
- Voltage range: 100 - 240 V  $\approx$  50 / 60 Hz (automatic adaption of voltage and frequency).
- This product conforms to the EMC-Requirements as laid down by the Council Directive 89/336/EEC.

- ① Shaver socket
- ② Switch
- ③ Longhair trimmer
- ④ Cutterblock base
- ⑤ Duo cutterblock
- ⑥ Triple shaving frame
- ⑥a Twin foil
- ⑥b Integrated longhair cutter
- ⑦ Foil protection cap
- ⑧ Button for releasing the triple shaving frame ⑥

Switch positions:

0 = Off

1 = Shaving with the twin foil ⑥a and the integrated longhair cutter ⑥b

2 = Shaving with the pivoting head **locked** at an angle to permit shaving under the nose or at the hairline

3 = The longhair trimmer ③ is activated

- Connect the shaver to the mains.
- Take off the foil protection cap ⑦.
- For shaving, push the switch ② to setting «1».
- **Hold the shaver at right angles (90°) to the skin.**
- Stretch the skin with your free hand.
- Guide the shaver smoothly against the direction of beard growth, applying only gentle pressure.

The pivoting cutting system (twin foil ⑥a and integrated longhair cutter ⑥b) follows the contours of your face automatically.

While shaving difficult parts of your face (e. g. under the nose or at the hairline), push switch ② to setting «2», to lock the pivoting head at an angle.

## Description

### Switch ②

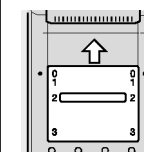

### Shaving

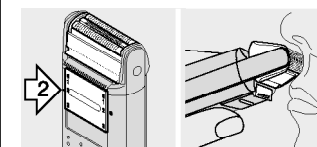
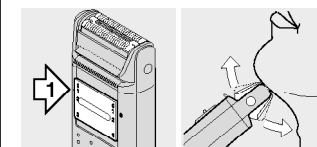

## Longhair trimmer ③

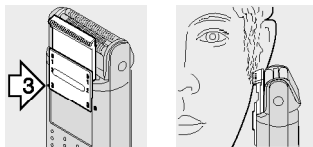

To activate the longhair trimmer, move the switch ② to setting «3». The longhair trimmer moves upwards and allows easy and exact trimming of the side burns.

## Switching the shaver off

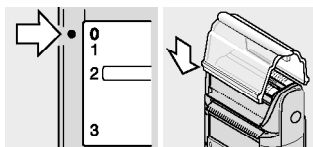

Move the switch ② back to setting «0».

**Important:** After every shave, put the foil protection cap ⑦ on the pivoting head.

## Cleaning and maintenance

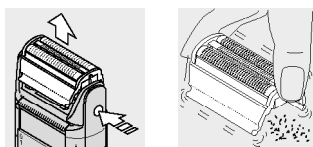

Switch the shaver off.  
After each shave take off the triple shaving frame ⑥. Press the button ③ to release the triple shaving frame and pull it off.

Tap out slightly the triple shaving frame. Do not clean the twin foil ⑥a with the brush.

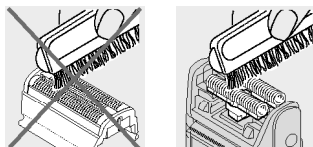

Clean the duo cutterblock ⑤ thoroughly with the brush.  
Move the duo cutterblock crosswise and take it off. Brush out the entire pivoting head area, including the cutterblock base ④. After cleaning place the duo cutterblock back into the cutterblock base ④ and replace the triple shaving frame ⑥ until it clicks into place.

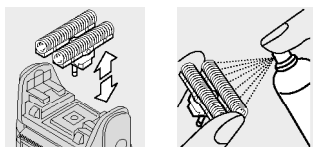

Approximately every four weeks clean the duo cutterblock ⑤ with Braun cleaning agents.

After every cleaning replace the foil protection cap ⑦.

The triple shaving frame and duo cutterblock are precision parts that will wear out over time. To maintain optimal shaving performance you should replace these parts when worn. This will ensure that you continue to get the close, comfortable shave you expect from your Braun shaver.

**Important:** Buy only original Braun spare parts, especially when replacing the cord or the triple shaving frame ⑥. When replacing the triple shaving frame look for the **BRAUN** brand. Only this way you will obtain a perfect shave.

**Triple shaving frame ⑥:** Remove as described under «Cleaning and maintenance». Set the new triple shaving frame on the pivoting head until it clicks into place. Handle with care.

**Duo cutterblock ⑤:** Take as described under «Cleaning and maintenance». Place the new duo cutterblock into the cutterblock base ④ until it clicks into place.

Subject to change without notice.

- It is recommended to shave before washing your face; your skin is slightly swollen after washing.
- Hold the shaver at right angles (90°) to the skin.
- Stretch your skin and shave against the direction of beard growth.
- Clean the shaver after every shave (see «Cleaning and maintenance»). A poorly cleaned shaver has a reduced shaving performance.
- Use only properly functioning shaving parts.

## Purchasing spare parts

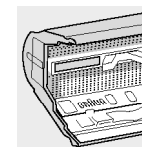

## Tips for the perfect shave

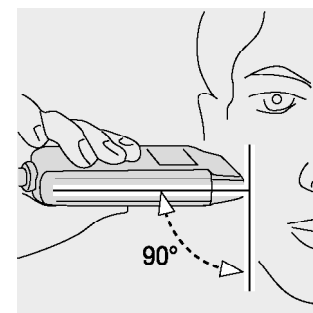

## Guarantee

We grant a 1 year guarantee on the product commencing of the date of purchase.

Within the guarantee period we will eliminate, free of charge, any defects in the appliance resulting from faults in material or workmanship either by repairing, or exchanging parts or exchanging the whole appliance as we may choose.

Not covered by this guarantee: damage arising from improper use (operation with incorrect current/voltage, plugging it into an unsuitable power point, kinks in the shaving foil, breakage), normal wear on the shaving foil and defects which have a negligible effect on the value or operation of the appliance. The guarantee becomes void if repairs are undertaken by unauthorized persons and if original Braun parts are not used.

The guarantee only comes into force if the date of purchase is confirmed by the dealer's stamp and signature on the guarantee card and registration card.

This guarantee extends to every country where this appliance is supplied by Braun or its appointed distributor and where no import restrictions or other legal regulations hinder or prevent service being given under guarantee.

Service under the guarantee does not affect the expiry date of the guarantee. The guarantee on parts or entire appliances which are exchanged ends when the guarantee on this appliance expires.

In the event of a claim under this guarantee, hand in the complete appliance with the valid guarantee card to your dealer, or send both to the nearest Braun Customer Service Centre.

All other claims including for damages resulting from this guarantee are excluded unless our liability is legally mandatory.

Those claims arising out of the sales contract with the vendor are not affected by this guarantee.

**For UK only:**

This guarantee in no way affects your rights under statutory law.

## Free Manuals Download Website

<http://myh66.com>

<http://usermanuals.us>

<http://www.somanuals.com>

<http://www.4manuals.cc>

<http://www.manual-lib.com>

<http://www.404manual.com>

<http://www.luxmanual.com>

<http://aubethermostatmanual.com>

Golf course search by state

<http://golfingnear.com>

Email search by domain

<http://emailbydomain.com>

Auto manuals search

<http://auto.somanuals.com>

TV manuals search

<http://tv.somanuals.com>