

BravettiTM

QUAD-BLADE BLENDER

OWNER'S MANUAL

Model KB305H

120V~, 60Hz., 700 Watts

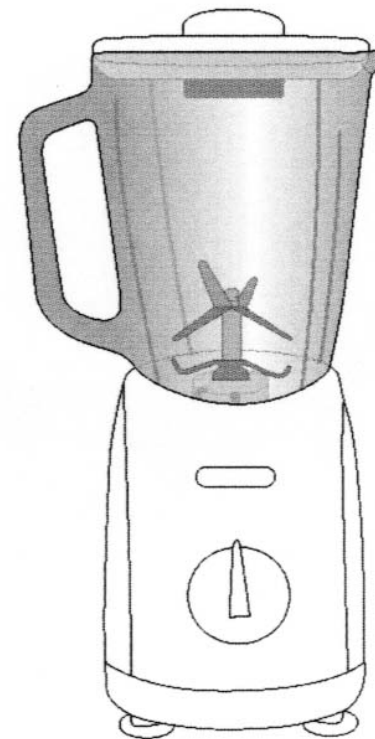

EURO-PRO Operating LLC
94 Main Mill Street, Door 16
Plattsburgh, NY 12901
Tel.: 1-800-798-7398

IMPORTANT SAFETY INSTRUCTIONS

When using your **Bravetti QUAD-BLADE BLENDER**, basic safety precautions should always be observed, including the following:

1. Read all instructions before using your **Quad-Blade Blender**.
2. To protect against electrical shock, do not submerge the blender or allow the power cord to come into contact with water or any other liquid.
3. Close supervision is necessary when any appliance is used by or near children. Never leave an appliance unattended when in use.
4. Turn the appliance Off and remove the power cord from the electrical outlet when not in use, before assembling or disassembling parts and before cleaning. To unplug, grasp the plug and pull from the electrical outlet. Never pull from the power cord
5. Always allow the appliance to cool before taking off parts and before cleaning.
6. Avoid contact with moving parts.
7. Do not operate the appliance with a damaged power cord or plug. Do not use appliance if it has been dropped, damaged, left outdoors or dropped in water. Return appliance to EURO-PRO Operating LLC for examination, repair or adjustment.
8. Do not use outdoors.
9. Do not let the power cord hang over the edge of table or counter or touch hot surfaces such as the stove.
10. Do not operate this appliance on or near any hot surfaces (such as gas or electric burner or in a heated oven).
11. The use of attachments or accessories not recommended by the manufacturer may result in fire, electric shock or personal injury.
12. Do not overfill.
13. Do not abuse the power cord. Never carry the appliance by the power cord or yank it to disconnect from electrical outlet; instead grasp the plug and pull to disconnect. Keep hands, hair, clothing, as well as utensils out of container while blending to reduce the risk of severe injury to persons or damage to the appliance. A scraper may be used but only when the blender is not running.
14. Blades are sharp; handle carefully.
15. To reduce risk of injury, never place the blade assembly on base with blender jar properly attached.
16. Always operate the blender with the blender cover in place.
17. When processing hot liquids, remove the measuring cap from the two piece blender cover.
18. **THIS PRODUCT IS INTENDED FOR HOUSEHOLD USE ONLY.**

This unit has a short power supply cord to Reduce the risk resulting from becoming entangled in or tripping over a long cord. An extension cord may be used if you are careful in its use:

1. The electrical rating of the extension cord should be at least as great as the electrical rating of the appliance.
2. An extension cord with the power cord must be arranged so that it will not drape over the countertop or tabletop where they can be pulled on by children or tripped over accidentally.

SAVE THESE INSTRUCTIONS

For Household Use Only

WARNING: To reduce the risk of electric shock, this appliance has a polarized plug (one blade is wider than the other). This plug will fit in a polarized outlet only one way. If the plug does not fit fully in the outlet, reverse the plug. If it still does not fit, contact a qualified electrician to install the proper outlet. Do not modify the plug in any way.

Model KB305H

Bravetti™

ONE (1) YEAR LIMITED WARRANTY

EURO-PRO Operating LLC warrants this product to be free from defects in material and workmanship for a period of one (1) year from the date of purchase when utilized for normal household use.

If your appliance fails to operate properly while in use under normal household conditions within the warranty period, return the complete appliance and accessories, freight prepaid to **EURO-PRO** Operating LLC, 94 Main Mill Street, Door 16, Plattsburgh, NY 12901. If the appliance is found by **EURO-PRO** Operating LLC to be defective in material or workmanship, **EURO-PRO** Operating LLC will repair or replace it free of charge. Proof of purchase date and \$12.95 to cover the cost of return shipping and handling must be included.*

The liability of **EURO-PRO** Operating LLC is limited solely to the cost of the repair or replacement of the unit at our option. This warranty does not cover normal wear of parts and does not apply to any unit that has been tampered with or used for commercial purposes. This limited warranty does not cover damage caused by misuse, abuse, negligent handling or damage due to faulty packaging or mishandling in transit.

This warranty is extended to the original purchaser of the unit and excludes all other legal and/or conventional warranties. The responsibility of **EURO-PRO** Operating LLC if any, is limited to the specific obligations expressly assumed by it under the terms of the limited warranty. **In no event** is **EURO-PRO** Operating LLC liable for incidental or consequential damages of any nature whatsoever. Some states do not permit the exclusion or limitation of incidental or consequential damages, so the above may not apply to you.

This warranty gives you specific legal rights, and you may also have other rights which vary from state to state.

***Important: Carefully pack item to avoid damage in shipping. Be sure to include proof of purchase date and to attach tag to item before packing with your name, complete address and phone number with a note giving purchase information, model number and what you believe is the problem with item. We recommend you insure the package (as damage in shipping is not covered by your warranty). Mark the outside of your package "ATTENTION CUSTOMER SERVICE". We are constantly striving to improve our products, therefore the specifications contained herein are subject to change without notice.**

OWNERSHIP REGISTRATION CARD

Please fill out and mail the product registration card within ten (10) days of purchase in order to validate the foregoing Limited Warranty. The registration will enable us to contact you in the unlikely event of a product safety notification. By returning this card you acknowledge to have read and understood the instructions for use, and warnings set forth in the accompanying instructions.

RETURN TO:

EURO-PRO Operating LLC, 94 Main Mill Street, Door 16, Plattsburgh, NY 12901

Model KB305H

Appliance model

Date purchased

Name of store

Owner's name

Address

City

State

Zip code

OPERATING INSTRUCTIONS

Helpful Hints

- Always operate the blender with the blender cover on.
- Always hold the blender jar with one hand while processing.
- To ensure proper blending and to prevent overflow, add ingredients to the blending jar a little at a time.
- Never fill blender jar more than 3/4 full - the blade action will cause the ingredients to rise in the blender jar. Blend large quantities in several batches.
- Unless your recipe says otherwise, pour liquid ingredients first into the blender jar before solid ingredients. The liquid will help the processing go much faster and allow the blender to operate at a more efficient rate.
- Do not use blender continuously for an extended amount of time, (no more than four (4) minutes running time without cooling down).
- Do not remove the blender jar from the power base while the motor is running.
- To prevent the possibility of severe injury or damage to the appliance, keep hands and utensils out of the blender jar while processing. A scraper may be used only when the blender is not working.
- Do not store food or beverages in the blender jar.
- Even though the blender is a versatile appliance, it will not mash potatoes, beat egg whites, extract juice from fruits or vegetables, grind raw meat or knead dough.
- When grating hard cheese, cut into small cubes and put small amounts into the jar. Cover the jar and process on high speed. Do not overload. Use the pulse button and process until it reaches the consistency that you desire.
- When processing solids, always cut food into 1"-2" sized pieces before blending.
- **Use extreme caution when processing hot foods to avoid accidental scalding or burns. When processing hot foods, always remove the measuring cap from the blender cover before beginning.**

Maintenance

This blender requires no maintenance. It contains no user-serviceable parts inside the motor housing. Do not remove the motor housing cover. Contact EURO-PRO if this product needs servicing.

Cleaning

NEVER IMMERSE POWER BASE IN WATER OR ANY OTHER LIQUID.

1. Turn blender "Off".
2. Unplug blender from electrical outlet.
3. Remove the blender jar from the power base.
4. Disassemble the blender jar and wash in warm soapy water. **Use extreme caution when handling the blade assembly.**
5. Wipe the power base with a damp cloth. Dry completely with a soft cloth.

Storage

Caution: Always assemble blender parts correctly before storing the power base.

1. Unplug and clean unit.
2. Wrap power cord counterclockwise underneath the power base. (Fig. 5)

Note: Do not store the blender with the jar cover in place.

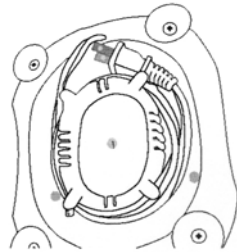
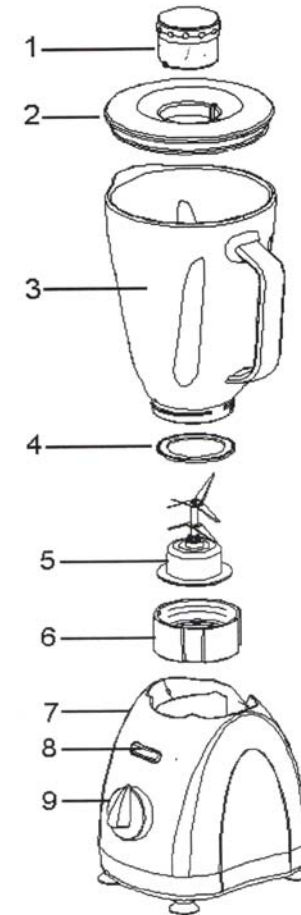

Fig. 5

GETTING TO KNOW YOUR QUAD-BLADE BLENDER



- | | |
|----------------------|---|
| 1. Measuring Cap | 6. Retainer Ring |
| 2. Blender Jar Cover | 7. Power Base |
| 3. Glass Blender Jar | 8. Pulse Button |
| 4. Rubber Gasket | 9. On/Off - Progressive Variable Speed Control Dial |
| 5. Blade Assembly | |

Technical Specifications

Voltage:	120V., 60Hz.
Power:	700 Watts
Jar Capacity:	48 oz.

OPERATING INSTRUCTIONS

The **Bravetti Blender** is an indispensable kitchen tool for blending, chopping or pureeing when preparing your favorite recipes. For best results, be sure to carefully read all the instructions contained in this book before using this appliance.

700 Watt Power Unit

The 700 Watt Power Unit operates on 120V~, 60Hz. electrical power. **Never** allow the power unit to become wet when plugged into an electrical outlet.

Warning: The power unit should never be immersed in water.

Caution: Make sure that the power unit is unplugged from power source and the blades have stopped turning before attaching or removing any accessory.

Important: Do NOT operate the appliance when empty as it could damage the power base.

Assembling the Blender

Caution - Blades are sharp. Use extreme caution when handling the blade assembly, always hold it by the base of the blade assembly. (Fig. 1) NEVER HANDLE BY BLADES, VERY SHARP. Do not immerse the power base in water or any other liquid.

Glass Blender Jar Assembly

1. Place jar upside down on a flat level surface. (Fig. 2)
2. Place the rubber gasket on the rim of the blender jar. (Fig. 2)
3. Holding the blade assembly by the base, place it carefully over the rubber gasket. (Fig. 2)
4. Place the retainer ring over the base of the blade assembly and screw on tightly. (Fig. 2)
5. Before placing the assembled blender jar on the power base, make sure that the unit is not plugged in and that the speed control dial is in the "OFF" position. (Fig. 3)

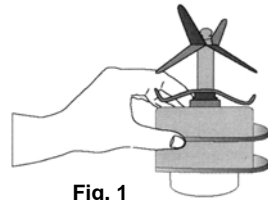

Fig. 1

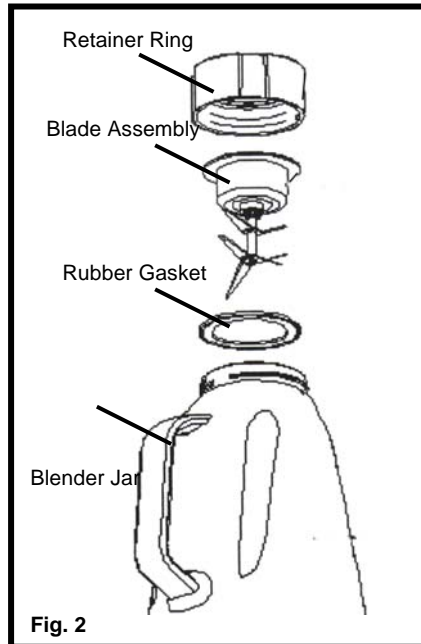

Fig. 2

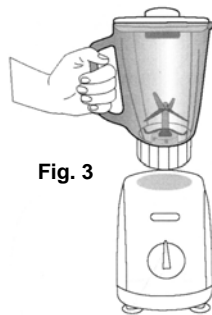

Fig. 3

OPERATING INSTRUCTIONS

How to Use Your Blender

Caution - Blades are sharp. Use extreme caution when handling the blade assembly, always hold it by the base of the blade assembly. (Fig. 1) Do not immerse the power base in water or any other liquid.

Caution: Make sure that the power unit is unplugged from power source and the blades have stopped turning before attaching or removing any accessory.

Important: Do NOT operate the appliance when empty.

1. Place the power base on a dry, level surface.
2. Make sure that the On/Off-Variable Speed Control Dial is in the "OFF" position.
3. Place the blender jar into position on the power base. (Fig. 4)
4. Plug the power cord into the electrical outlet.
5. Add ingredients to the blender jar as directed by your recipe.
6. Place the blender jar cover on the blender jar with the measuring cap in place. Make sure that the measuring cap is securely in place by turning it clockwise to lock. Always hold the measuring cap firmly in place during processing so that it does not come loose.
7. If you need to add additional ingredients while the blender is processing, just remove the measuring cap and pour the ingredients in through the opening in the blender jar cover.
8. Turn the variable speed control dial clockwise until the desired speed is reached. Speed may be varied during processing.
9. After use, always turn the unit to the "Off" position and unplug the power cord from the electrical outlet before removing the blender jar from the power base.

CAUTION: NEVER REMOVE THE BLENDER JAR FROM THE POWER BASE WHILE THE BLENDER IS STILL RUNNING.

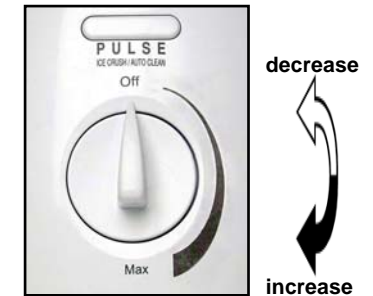

Fig. 4

Caution: When working with hot foods or liquids, always remove the measuring cap from the blender jar cover to vent the steam. Keep hands and other exposed skin away from the opening to prevent possible burns or scalding. Do not use more than two (2) cups of hot liquid at a time.

Progressive Variable Speed Control

The Bravetti Quad-Blade Blender is equipped with a progressive variable speed control. It gives the user the ability to increase or decrease the processing speed easily during use.



Note: Always turn appliance to the "Off" position after use and unplug the power base. To remove the blender jar, lift it straight up; there is no need to twist it. Due to differences in amounts and desired consistencies of some processed foods, a higher or lower speed may be required.

Pulse Function

Use the Pulse function when you need an extra burst of speed but only when you are below the "MAX" (maximum) speed level.

You can use the Pulse function to crush ice, but ice may also be crushed at lower speeds as well. Crush only about 8-10 oz. of ice at a time.

To clean the blender, fill the blender with warm water and a drop of dishwashing liquid and pulse a few times and then remove the blender jar from the power base and rinse the blender jar.

Free Manuals Download Website

<http://myh66.com>

<http://usermanuals.us>

<http://www.somanuals.com>

<http://www.4manuals.cc>

<http://www.manual-lib.com>

<http://www.404manual.com>

<http://www.luxmanual.com>

<http://aubethermostatmanual.com>

Golf course search by state

<http://golfingnear.com>

Email search by domain

<http://emailbydomain.com>

Auto manuals search

<http://auto.somanuals.com>

TV manuals search

<http://tv.somanuals.com>