

Bravetti™

PLATINUM PRO

Electronic Pressure Cooker

OWNER'S MANUAL

Model PC107HA
120V., 60Hz., 900 Watts



USA: **EURO-PRO OPERATING LLC**
94 Main Mill Street, Door 16
Plattsburg, NY 12901

Tel.: 1 (800) 798-7398

Canada: **EURO-PRO OPERATING LLC**
4400 Bois Franc
St. Laurent, QC H4S 1A7

EURO-PRO 



ONE (1) YEAR LIMITED WARRANTY

EURO-PRO Operating LLC warrants this product to be free from defects in material and workmanship for a period of one (1) year from the date of the original purchase, when utilized for normal household use, subject to the following conditions, exclusions and exceptions.

If your appliance fails to operate properly while in use under normal household conditions within the warranty period, return the complete appliance and accessories, freight prepaid to:

U.S.: **EURO-PRO Operating LLC**, 94 Main Mill Street, Door 16, Plattsburgh, NY 12901
CANADA: **EURO-PRO Operating LLC**, 4400 Bois Franc, St Laurent, Qc, H9S 1A7

If the appliance is found to be defective in material or workmanship, **EURO-PRO Operating LLC** will repair or replace it free of charge. Proof of purchase date must be included.*

Non-durable parts including, without limitation, sealing gasket and electrical parts which normally require replacement are specifically excluded from warranty.

The liability of **EURO-PRO Operating LLC** is limited solely to the cost of the repair or replacement of the unit at our option. This warranty does not cover normal wear of parts and does not apply to any unit that has been tampered with or used for commercial purposes. This limited warranty does not cover damage caused by misuse, abuse, negligent handling or damage due to faulty packaging or mishandling in transit. This warranty does not cover damage or defects caused by or resulting from damages from shipping or repairs, service or alterations to the product or any of its parts, which have been performed by a repair person not authorized by **EURO-PRO Operating LLC**.

This warranty is extended to the original purchaser of the unit and excludes all other legal and/or conventional warranties. The responsibility of **EURO-PRO Operating LLC** if any, is limited to the specific obligations expressly assumed by it under the terms of the limited warranty. **In no event is EURO-PRO Operating LLC** liable for incidental or consequential damages of any nature whatsoever. Some states do not permit the exclusion or limitation of incidental or consequential damages, so the above may not apply to you.

This warranty gives you specific legal rights, and you may also have other rights which vary from state to state or from province to province.

***Important: Carefully pack item to avoid damage in shipping. Be sure to include proof of purchase date and to attach tag to item before packing with your name, complete address and phone number with a note giving purchase information, model number and what you believe is the problem with item. We recommend you insure the package (as damage in shipping is not covered by your warranty). Mark the outside of your package "ATTENTION CUSTOMER SERVICE". We are constantly striving to improve our products, therefore the specifications contained herein are subject to change without notice.**



OWNERSHIP REGISTRATION CARD

Please fill out and mail the product registration card within ten (10) days of purchase. The registration will enable us to contact you in the unlikely event of a product safety notification. By returning this card you acknowledge to have read and understood the instructions for use, and warnings set forth in the accompanying instructions.

U.S.: **EURO-PRO Operating LLC**, 94 Main Mill Street, Door 16, Plattsburgh, N.Y., 12901

Model PC107HA

Appliance model

Date purchased

Name of store

Owner's name

Address

City

State

Zip Code

Recipes

Recipes courtesy of Alison Dubois

SPANISH CHICKEN

Place ingredients into pressure cooker in following order:

2 tbs.	olive oil
1 med	yellow onion sliced into thick rings
3	cloves minced garlic
4	frozen (or thawed) boneless, skinless chicken breasts, about 1.5 lbs
1 14.5 oz	can petite diced tomatoes
1 14.5 oz	can tomato sauce
¼ tsp	salt
¼ tsp	pepper
¼ tsp	thyme
¼ cup	chicken broth
1	bay leaf
10	large Spanish olives cut in half

Place the lid on the pressure cooker, and securely lock lid. Close vent. Press the pre-set button "**Chicken**". When the pressure cooker switches to "**Keep Warm**", unplug the machine and let the pressure slowly drop until no pressure remains. Serve with yellow rice.

CHICKEN & DUMPLINGS

Place ingredients into pressure cooker in following order:

4 cups	chicken broth
½ cup	diced carrots
¼ cup	diced celery
1-1 ½ lbs	boneless, skinless chicken breasts; cut into bite-sized cubes
¼ cup	flour
½ tsp	salt
¼ tsp	pepper
¼ tsp	poultry seasoning
2 – 7.5 oz	cans biscuits, pressed slightly flat, & cut into 4 strips per biscuits

Use a spoon and gently push biscuits into broth. Put lid on unit and secure. Press the pre-set "**Cook**" button. When the pressure cooker switches to "**Keep Warm**".

IMPORTANT SAFETY INSTRUCTIONS

When using your **Pressure Cooker** basic safety precautions should always be observed, including the following:

1. Read all instructions before using your **Pressure Cooker**.
2. To protect against fire, electric shock and injury to persons, **do not** immerse cord, plugs, or the pressure cooker housing in water or other liquid.
3. **Do not** touch hot surfaces. Always use handles or knobs.
4. Close supervision is necessary when any appliance is used by or near children.
5. **Do not** let cord hang over edge of table or counter, or touch hot surfaces.
6. **Do not** operate any appliance with a damaged cord or plug or after the appliance malfunctions or has been dropped or damaged in any manner. Return appliance to **EURO-PRO Operating LLC** for examination, repair or adjustment.
7. The use of accessory attachments not recommended by the appliance manufacturer may result in fire, electric shock or injury to persons.
8. **Do not** place on or near a hot gas or electric burner or in a heated oven.
9. To avoid possible steam damage, place pressure cooker away from walls or cabinets during use.
10. Unplug from outlet when not in use and before cleaning. Allow the appliance to cool before putting on or taking off parts, and before cleaning.
11. To disconnect, press the "**Cancel**" button, then remove the plug from electrical outlet. Always hold the plug, and never pull the cord.
12. Extreme caution must be used when moving an appliance containing hot oil or other hot liquids.
13. Oversized foods, metal foil packages, or utensils must not be inserted in the appliance, as they may involve a risk of fire or electric shock.
14. This appliance cooks under pressure. Improper use may result in scalding injury. Make certain unit is properly closed before operating. See "**Operating Instructions**".
15. A fire may occur if the appliance is covered or touching flammable material, including curtains, draperies, walls and the like when in operation.
16. **Do not** attempt to dislodge food when appliance is plugged in.
17. Always check the pressure release devices for clogging before use.
18. **Do not fill the unit over 2/3 full.** When cooking foods that expand during cooking such as rice or dried vegetables, do not fill the unit over **1/2 full**. See "**Tips for Cooking with your Pressure Cooker**".
19. **Do not** cook foods such as applesauce, cranberries, pearl barley, oatmeal or other cereals, split peas, noodles, macaroni, rhubarb, or spaghetti. These foods tend to foam, froth and sputter, and may block the steam release valve.
20. **Do not** attempt to open cover until internal pressure has been reduced.
21. **Do not** use this pressure cooker for pressure frying with oil or shortening.
22. **Never** operate the pressure cooker without any liquid inside. **Do not** allow the pressure cooker to boil dry.
23. Always wear protective, insulated oven mitts when opening the pressure release valve.
24. **Do not** use this appliance outdoors.
25. **Do not** use this appliance for other than intended use.
26. Keep hands and face away from steam release valve when releasing pressure.
27. **Caution:** To reduce the risk of electric shock, cook only in the removable cooking pot. **Never** place anything into the housing.
28. **Do not** use without the removable cooking pot in place.
29. **Do not** cover the pressure release valve with anything or lock it in place as an explosion may occur.
30. Use extreme caution when removing the cover after cooking. Serious burns can result from steam inside. Always lift and tilt the cover away from you and allow water to drip into the unit.
31. **Never** remove the cover while the pressure cooker is in operation.
32. Let the pressure cooker cool before removing the cover.
33. **Do not** use with foods that can overcook easily and quickly.



WARNING: Danger of Scalding. Please use caution when using the pressure cooker. The steam emitted from this appliance is very hot.

SAVE THESE INSTRUCTIONS

For Household Use Only

Grounding Instructions

This appliance must be grounded. If it should malfunction or breakdown, grounding provides a path of least resistance for electric current to reduce the risk of electric shock. This appliance is equipped with a cord having an equipment-grounding conductor and grounding plug. The plug must be inserted into an appropriate outlet that is properly installed and grounded in accordance with all local codes and ordinances.

WARNING: Improper connection of the equipment-grounding conductor can result in a risk of electric shock. Consult with a qualified electrician or service person if you are in doubt as to whether the outlet is properly grounded. Do not modify the plug provided with the appliance - if it will not fit the outlet, have a proper outlet installed by a qualified electrician.

This appliance is for use on a nominal 120-volt circuit, and has a grounding attachment plug that looks like the plug illustrated at right. Make sure that the appliance is connected to an outlet having the same configuration as the plug. No adaptor should be used with this appliance.



1. If it is necessary to use an extension cord, use only a 3-wire extension cord that has a 3-blade grounding plug and a 3-slot receptacle that will accept the plug on the appliance. The marked rating of the extension cord should be equal to or greater than the electrical rating of the appliance.

OR

2. Do not use an extension cord. If the power cord is too short, have a qualified electrician or serviceman install an outlet near the appliance.

Please Note:

1. A short power supply cord is provided to reduce the risks resulting from becoming entangled in or tripping over a longer cord.
2. Extension cords may be used if care is exercised in their use.
3. If a long cord or extension cord is used, (1) the marked electrical rating of the cord set or extension cord should be at least as great as the electrical rating of the appliance, (2) the extension cord must be a grounding-type 3-wire cord, and (3) the longer cord should be arranged so that it will not drape over the countertop or tabletop where it can be pulled on by children or tripped over accidentally.

Suggested Cooking Guide

FOOD	SETTING	COOKING TIME	RELEASE METHOD
VEGETABLES: Add 1-1/2 cups water			
Artichoke	Cook	Cook times will range from 15 to 40 minutes on the Cook Setting.	Quick
Asparagus	Cook		Quick
Beans (Green)	Cook		Quick
Beets	Cook		Quick
Broccoli	Cook		Quick
Cabbage	Cook		Combination
Carrots	Cook		Quick
Cauliflower	Cook		Quick
Corn	Cook		Quick
Potato	Cook		Combination
Spinach	Cook		Combination
Squash	Cook		Combination
BEANS, MEAT, POULTRY, AND FISH: When adapting standard recipes, use 1/2 amount of water used with conventional cooking			
Beef	Beef/Pork	Cook times will range from 40 to 70 minutes on Beef/Pork Setting, 30 to 50 minutes on Chicken Setting, 15 to 40 minutes on Fish Setting.	Combination
Chicken	Chicken		Combination
Pork	Beef/Pork		Combination
Shellfish	Fish		Combination
Fish	Fish		Combination
Beans (Navy)	Beef/Pork		Combination
Beans (Kidney)	Beef/Pork		Combination
Split peas	Fish		Quick
RICE: To reduce foam add at least one tablespoon of oil or butter			
Rice (White) - Use 1/3 to 1/2 less than normal recipe	Cook	Cook times will range from 15 to 40 minutes on the Cook Setting.	Combination
Rice (Brown) - Use 1/4 to 1/2 less than normal recipe	Cook		Combination

Note: Cook times will vary as the pressure cooker will adjust the cooking times based on the volume of ingredients and liquid added to the pot.

Tips for Cooking in Your New Pressure Cooker

Meats & Poultry

When adapting recipes for braised meats, allow **20 minutes** cooking time per pound of meat. Use 1 cup liquid for the first pound and 1/2 cup for each additional pound.

For steam-roasting poultry and meats, brown first in oil for better appearance.

Rice

When cooking rice and grains, add 1 Tbs. butter or oil per cup to reduce foaming and clogging the pressure valve.

Since rice doubles in size when cooked, be sure to use only half as much uncooked rice as the cooker's capacity allows. For example, never cook more than 1 3/4 cups raw rice in the 3 1/2 qt. pressure pan and no more than 4 cups raw rice in the 8 qt. pressure pan.

Because rice will be slightly sticky when cooked in a pressure cooker, it is best to use a slow release method. For example, allow cooling naturally or else slowly releasing pressure one level at a time.

To prevent burning, use a heat diffuser if available, or bring to pressure on a medium-high heat setting.

Beans

Although it is not necessary to pre-soak beans for pressure-cooking, there are some advantages. Since the gas-inducing properties of beans are water soluble, soaking reduces their effects.

Always drain the soaking water from the beans and cook with fresh water. Soaking also cuts down the cooking time and keeps the bean skins from separating from the flesh.

If you don't have time to soak the beans overnight, use the **Hot Soaking Method**: Use 5 cups water for every 8 oz. dried beans, pressure cook on low pressure for **3 minutes**, remove from heat source and let stand **1-4 hours**.

Always use at least 2 Tsp. of oil when cooking beans to reduce sputtering.

Always use the natural or slow release method to reduce pressure.

Clean lid and vents thoroughly after cooking rice or beans.

Desserts

Many desserts can be pressure-cooked, especially those that use eggs/and or are cooked over a hot water bath, such as custards, bread puddings and cheesecakes.

Use a dish that easily fits inside pressure cooker allowing 1 inch of space around the edge. The larger pressure cooker works best for this.

Seal the dish completely with foil to keep liquid from seeping into the dessert. Soak up any moisture on top of foil before removal.

For easy removal, place dish inside steamer basket or make a sling out of aluminum foil.

Table of Contents

<u>Safety Instructions</u>	1
<u>Grounding Instructions</u>	2
<u>General Information for Cooking with Pressure Cookers</u>	4
<u>Getting to Know Your Programmable Pressure Cooker</u>	5 - 7
<u>Troubleshooting</u>	7
<u>Safety Features of Your Pressure Cooker</u>	8
<u>Preparing Your Pressure Cooker</u>	9
<u>Using Your Pressure Cooker</u>	9 - 10
<u>Cooking with Pre-Set Buttons</u>	11
<u>Cooking without Pre-Set Buttons</u>	11
<u>Releasing Steam Pressure</u>	12
<u>Using the "Keep Warm" Feature</u>	13
<u>Cleaning and Storage</u>	13
<u>Tips for Cooking with Your Pressure Cooker</u>	14
<u>To Order Replacement Parts</u>	14
<u>Suggested Cooking Guide</u>	15
<u>Recipes</u>	16
<u>Warranty</u>	17

To Order Replacement Parts

1 Set of Replacement Gaskets
Item #: 100KDS
For Model PC107HA

When needing replacement parts, please contact **EURO-PRO** customer service at:
1 (800) 798-7398

Monday to Friday from 8:30 AM to 5:00 PM
Eastern Standard Time

General Information for Cooking with Pressure Cookers

Q. What is pressure-cooking?

A. Pressure cooking is a method of cooking in a sealed pot that does not permit air or liquids to escape below a preset pressure. The water's boiling point increases as the pressure increases. The pressure built up inside the cooker permits the liquid in the pot to rise to a temperature higher than 212°F (100°C) before boiling. The higher temperature causes the food to cook faster.

Q. What are the advantages of pressure cookers?

A. Pressure cookers offer a convenient and quicker method of cooking other than cooking on a regular stove top or oven.

Q. What happens when the cooker heats up?

A. The body of your pressure cooker is made of metal. Heat makes metal expand. When using the pressure cooker for browning, allow the pressure cooker to cool slightly before placing the cover onto the pot and locking it in place.

Q. What if I am cooking at higher altitudes?

A. When you cook at higher altitudes the cooking time must be increased slightly. To adapt the recipes for pressure-cooking, increase the cooking time by 5% for every 1,000 feet above a 2,000 foot elevation.

Q. What kind of liquids are suitable for use in a pressure cooker?

A. Any liquids that contain water such as beer, wine, meat or vegetable stocks, vegetable juices and fruit juices.

Q. What type of liquids SHOULD NOT be used in a pressure cooker?

A. Any liquid that does not contain water such as oils or oil-based marinades and/or dressings. Milk and milk-based foods and sauces or liquids **should not be used**, as they will foam when boiling. These liquids should be added **after** the pressure cooking process is completed and the cooker is opened.

Operating Instructions

Note: Since overcooked food **cannot** be corrected, it is almost better to err on the undercooked side by cooking an unfamiliar food for a shorter period of time than you may think necessary.

Using the “Keep Warm” Feature

This function can keep cooked foods warm for up to **24 hours**. The pressure cooker will go into “Standby” mode for one minute and then the “Keep Warm” mode will automatically be engaged after the cooking process has been completed. The “Keep Warm” light will illuminate when this feature is engaged. (Fig. 10)

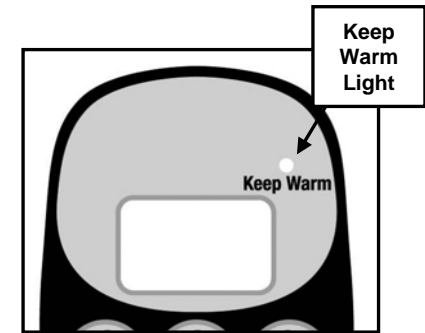

Fig. 10

Maintenance & Cleaning Instructions

Cleaning & Storage

1. Always leave the pressure to cool completely before you take the components apart for cleaning.
2. Unplug and remove the power cord from the appliance and the electrical outlet.
3. Remove the vapor collector by pulling it down and rinse under warm, soapy water. (Fig. 11)



Fig. 11

4. Wipe the outer housing of the pressure cooker with a damp cloth. **DO NOT** use any abrasive cleaners or immerse in water or any other liquid.
5. The removable cooking pot, pressure cooker cover and sealing gasket are washable. Wash them in warm, soapy water. The removable cooking pot and the cover are dishwasher safe. The sealing gasket is **NOT**.

6. Use a sponge or a non-metallic soft brush to clean the diffuser.
7. The pressure release valve does not have to be cleaned after each use unless it has become clogged.
8. The sealant washer may need to be cleaned. Remove it from the safety floating valve and clean with warm, soapy water. To replace, hold the safety float valve with your finger and push it in. (Fig. 12)



Fig. 12

9. Store the pressure cooker with the cover upside down over the main housing. **DO NOT** store with the cover closed to avoid compressing the sealing gasket for long periods of time.

Releasing Steam Pressure

Warning: Use extreme caution when removing the cover after cooking. Serious burns can result from steam inside.

After you have finished cooking in your pressure cooker, you can release the steam pressure in one of three (3) ways, “Quick Release”, “Combination” and “Normal”.

Quick Release Method

1. After the cooking process has been completed, press the “Cancel” button to stop the pressure cooker from going into the “Keep Warm” mode.
2. Turn the steam release valve to the “Open” position to release the steam fast. (Fig. 8)
3. Wait until the safety float valve has gone down before removing the cover. Always lift the cover away from you to release any remaining steam so that you do not get burned.

Caution: Escaping steam is very hot. To avoid serious injuries or burns, keep bare skin, face and eyes away from the steam release valve.

Caution: Do not use the quick release method for foods with a lot of liquid such as soups and sauces. There could be an overflow.

Important: Do not use the “Quick Release” method with foods such as legumes, grains or other foods that froth or when the pressure cooker is very full.

Combination Method

1. After the cooking process has been completed, press the “Cancel” button to stop the pressure cooker from going into the “Keep Warm” mode.
2. Let the unit cool down for approx. **thirty (30) minutes** and then turn the steam release valve to the “Open” position to release the steam. (Fig. 8)



Fig. 8

3. Wait until the safety float valve has gone down before removing the cover. Always lift the cover away from you to release any remaining steam so that you do not get burned.

Normal Method

Allowing the steam to release naturally is preferred when cooking foods like stocks, sauces and certain large cuts of meat which will benefit from continuing to cook in the pressure cooker. As the temperature decreases, so does the pressure.

1. After the cooking process has been completed, press the “Cancel” button to stop the pressure cooker from going into the “Keep Warm” mode.
2. Wait until the safety float valve has gone down before removing the cover. Always lift the cover away from you to release any remaining steam so that you do not get burned. (Fig. 9)



Fig. 9

Note: Do not use this method with foods that easily overcook.

Caution: Never attempt to force open the pressure cooker cover until the safety float valve has dropped.

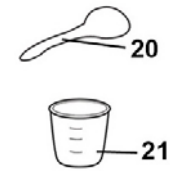
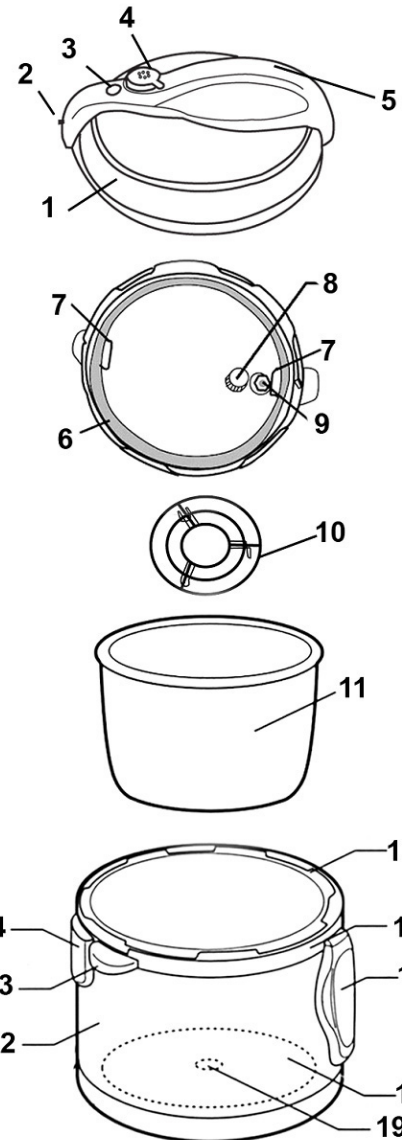

CONTROL PANEL

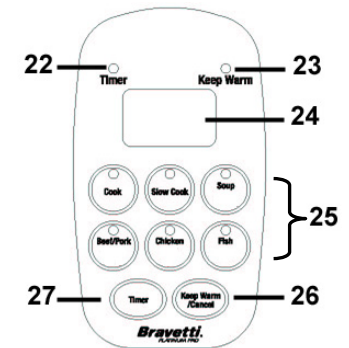

1. Pressure Cooker Cover
2. Cover Locking Pin
3. Safety Float Valve
4. Pressure Release Valve
5. Cover Handle
6. Sealing Gasket
7. Sealing Gasket Holder
8. Diffuser
9. Floating Valve Washer
10. Meat Trivet
11. Removable Cooking Pot
12. Stainless Steel Housing
13. Carry Handles (x2)
14. Vapor Collector
15. Inner Tank
16. Upper Ring
17. Control Panel
18. Heating Plate
19. Temperature Sensor
20. Spatula
21. Measuring Cup
22. Timer Light
23. Keep Warm Light
24. Time Display
25. Preset Buttons
26. Keep Warm/Cancel Button
27. Timer Button
28. Detachable Power Cord (not shown)

Technical Specifications

Voltage: 120V., 60Hz.

Power: 900 Watts

*Illustrations may vary from actual product

Parts of the Pressure Cooker

Sealing Gasket

The sealing gasket fits inside the cover of the pressure cooker to form a very tight seal between the cover and pressure cooker when the cover is locked. The sealing gasket can be easily removed for cleaning. Over time, the sealing gasket may shrink, harden, crack or become distorted with use. If this occurs, the sealing gasket should be replaced.

Warning: Do not wash the sealing gasket in the dishwasher, hand wash only.

Note: If there are any concerns regarding the sealing gasket call customer service.

Stainless Steel Meat Trivet

The meat trivet sits on the bottom of the removable cooking pot to support roasts and other meats and prevents the meat from sticking to the bottom of the pot. It can also be used to support a metal steamer basket for vegetables.

Preset Programmed Cooking Buttons

The preset buttons are programmed to take the guess work out of cooking with your pressure cooker.

Removable Cooking Pot

The removable cooking pot is coated with a non-stick surface for easier clean-up.

Parts of the Control Panel

Cooking with your new **Electronic Pressure Cooker** is simple and easy to use. The intelligent electronic controls take the guesswork out of heat adjustment and cooking times. Simply add your food to the cooking pot, close the cover and push one of the preset buttons and let the pressure cooker do the rest.

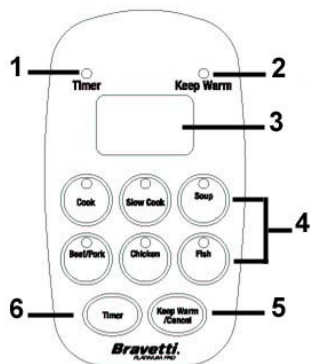

- 1. Timer Indicator Light**
- 2. Keep Warm Indicator Light**
This indicator light (yellow) will illuminate when the cooking process has been completed and the pressure cooker has switched over to the "Keep Warm" cycle.
- 3. Time Display**
When using the pre-set buttons the time display will show the time (in minutes) counting up. When manually setting the timer, the time display will show the time (in minutes) counting down.
- 4. Pre-set Buttons**
 - Cook**
The cook button is excellent for cooking unprocessed white rice and fresh vegetables.
 - Slow Cook**
The slow cook button is excellent for sticky rice, brown or wild rice.
 - Soup Button**
The soup button is programmed to cook soups, stews, or sauces.

- You should add a **minimum of 1 cup (250 ml) of liquid** into the cooking pot. **Do not fill the cooking pot more than one-third full when cooking dried beans an legumes, no more than half way when cooking soups and stews, and not more than two-thirds full when cooking vegetables or whole pieces of meat.**

- Place the cover on the pressure cooker and turn it counter clockwise to lock in place.
- Plug the power cord into the unit and then into the electrical outlet.
- Lower the pressure release valve so that steam may not escape.
- Select the desired preset button depending on food to prepare. (See "**Suggested Cooking Guide**").
- Ensure that the indicator light on the preset button is lit.
- The pressure cooker will beep three (3) times to let you know that the cooking process is complete.
- Wait for the unit to beep to signal end of cooking process.
- The pressure cooker will automatically go into "Standby" mode for one (1) minute and then into "Keep Warm" mode for up to six (6) hours.
- Slowly rotate the pressure release valve to the "Open" position to release the steam. (Fig. 6)



Fig. 6

- After the safety float valve has fallen down, remove the cover and remove the food. (Fig. 7)



Fig. 7

Cooking Without the Pre-Set Buttons

When cooking with the pressure cooker without using the pre-set buttons, use the **timer button** to adjust for the desired time.

- Place the removable cooking pot into the unit.
- Add the ingredients to be cooked into the removable cooking pot, following your recipe.
- You should add a **minimum of 1 cup (250 ml) of liquid** into the cooking pot.
- Place the cover on the pressure cooker and turn it counter clockwise to lock in place.
- Plug the power cord into the unit and then into the electrical outlet.
- Lower the pressure release valve so that steam may not escape.
- Using the **timer button**, adjust for the desired time. Once having set desired time, wait **15 seconds** and the **timer light** will go on.

Important Note: The timer will **not** begin to count down immediately after the timer light goes on. It will only begin to count down once the pressure cooker has reached a sufficient pressure and heat level.

- Wait for the unit to beep to signal end of cooking process.

Operating Instructions

- Replace the cover onto the pressure cooker and turn counter clockwise to lock the cover in place. The cover should stop turning when the cover locking pin is over the carry handle. (Fig. 3)

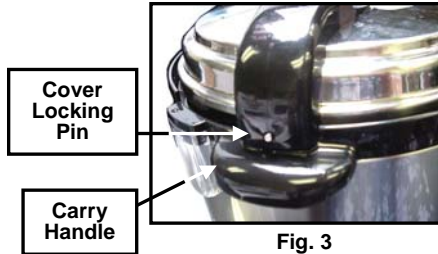

Fig. 3

- Plug the cord into a grounded-type 120V AC electrical wall outlet.
- Choose the desired program by pressing one of the pre-set cooking buttons. Once the indicator light is lit on that selection, the pressure cooker has begun the pre-heating and cooking cycle. The pressure cooker will beep three times when the pressure cooker has finished cooking.
- When the cooking cycle has finished cooking, or to cancel the selection press the **Keep Warm/Cancel** button.

Caution: The cover must be in the locked position when steaming or cooking under pressure.

- For pressure cooking turn the pressure release valve one half turn to the closed position, that is the lowest position the valve naturally sits. (Fig. 4)

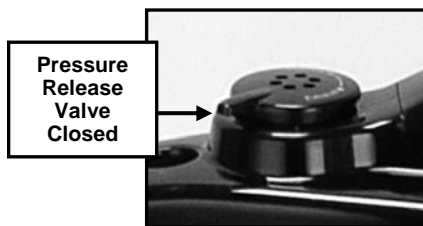

Fig. 4

- When the cooking process is complete, release the pressure by turning the pressure release valve one half turn to the upper most position to release steam. (Fig. 5)

Warning: Steam can cause serious burn injury. Avoid contact with face or hands. To open the pressure release valve it is suggested to use a utensil with a long reach to turn the valve.

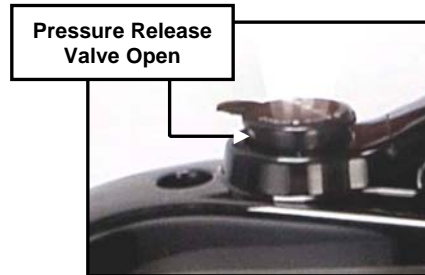

Fig. 5

- Alternately you can allow the steam to release naturally, this can take a few more minutes and add to the cooking time of the food inside.

Note: This unit has a built-in safety feature. The cover will **not** turn to the open position unless the pressure has been released by allowing the unit to sit or by turning the pressure release valve to the open position.

- Allow the unit to cool completely before cleaning.

Cooking with the Pre-Set Buttons

When cooking using the pre-set buttons the unit will automatically set the pressure depending which preset button is selected.

- Place the removable cooking pot into the unit.
- Add the ingredients to be cooked into the removable cooking pot, following your recipe.

Getting to Know Your Programmable Pressure Cooker

Beef/Pork

The beef/pork button is for cooking roasts, briskets or pork ribs. You can also use this setting for dry beans or other legumes, whole beets, chili and other foods that require longer cooking time.

Chicken Button

The chicken button is set to prepare roasts or poultry of any kind.

Fish Button

The fish button is set to cook fish perfectly. You can also cook fresh vegetables on this setting.

- Keep Warm/Cancel Button**

This button is used both for "Keep Warm" and "Cancel". The keep warm can be used to keep cooked food warm until ready for use, and the cancel button can be used to cancel a cooking cycle or to cancel a wrong selection.

- Timer Button**

This button is used to set the desired time for cooking when the pre-set buttons do not apply or you do not want to use them. Simply press on this button until you reach the desired time (timer goes from 0 to 99 minutes).

Troubleshooting

TROUBLESHOOTING		
PROBLEM	POSSIBLE CAUSE	POSSIBLE SOLUTION
Cover will not close	<ol style="list-style-type: none"> The sealing gasket is not well placed. The safety floating valve is stuck. 	<ol style="list-style-type: none"> Re-insert the sealing gasket correctly making sure that it is underneath the sealing gasket holder. Using a straightened paper clip, push the valve slightly.
Cover will not come off	<ol style="list-style-type: none"> The pressure cooker is still has pressure. 	<ol style="list-style-type: none"> Wait for pressure cooker to cool down.
Steam leaking	<ol style="list-style-type: none"> Sealing gasket is not in the cover. Sealing gasket is damaged. The cover has not been locked in place. 	<ol style="list-style-type: none"> Replace the sealing gasket in the cover. Replace the sealing gasket with a new one. Make sure the cover is locked in place.
Safety floating valve leaking	<ol style="list-style-type: none"> The sealant washer is damaged. The safety floating valve needs to be cleaned. 	<ol style="list-style-type: none"> Replace the sealant washer. Clean the safety floating valve.
Safety floating valve is not rising	<ol style="list-style-type: none"> Insufficient food in the cooking pot. 	<ol style="list-style-type: none"> Add more food and/or water according to the recipe.

Safety Features of Your Pressure Cooker

To ensure user safety, this appliance has several safety features built-in.

Safe Lid Closing System

This pressure cooker is equipped with a feature that prevents any increase in pressure if the cover is not properly closed. If the cover is not positioned correctly, pressure cannot build-up. Steam will escape from the sides of the pressure cooker cover.



Safe Lid Opening System

This appliance is equipped with a safety feature that prevents the pressure cooker cover from opening if the pressure in the cooker is too high. The safety float valve will prevent the cover from opening until the pressure has been released from the cooker and the valve has dropped.



Automatic Pressure Control

If the pressure cooker has built up excess pressure, the pressure release valve will automatically discharge steam to regulate safe pressure limits in the cooker.



Depressurizing Control

If for any reason the auto pressure relief valve does not function and pressure builds, the cooker will automatically vent excess pressure from around the lid.



Thermostat Control

When the internal temperature of the pressure cooker increases beyond the preset temperatures, the power to the pressure cooker will be cut off.

Ultra Thermostat Control

There is a fail safe sensor that is set to trip if the temperature and pressure in the pressure cooker are beyond safety limits. This safety system depressurizes the pressure cooker and terminates the power to the unit.

Note: If this occurs, call customer service at **1 (800) 798-7398**.

Operating Instructions

Preparing Your Pressure Cooker

Before using the electronic pressure cooker for the first time:

1. Remove the cooking pot from the unit.
2. Wash the removable cooking pot with warm, soapy water. The removable cooking pot may also be washed in a dishwasher.
3. Remove the sealing gasket from the cover and wash it with warm, soapy water. (Fig. 1)

Important Note: Do not wash in a dishwasher. Allow the sealing gasket to air dry or dry with a paper towel before inserting back into the cover.



Fig. 1

4. The cover of the pressure cooker may be washed with warm, soapy water or can also be placed into the dishwasher **after** the sealing gasket has been removed.
5. Replace the sealing gasket into the cover by placing it under the gasket holding ring ensuring that the crease in the sealing gasket meets with the gasket holding ring.

Important: The removable cooking pot and pressure cooker cover are dishwasher safe, however, you must remove the gasket before placing the cover in dishwasher.

Using Your Pressure Cooker

Note: For best results, always check that the pressure release valve, the diffuser and the sealing gasket are in good working condition. Visually inspect the sealing gasket for any defects such as cracks, punctures or tears. Also check that there are no particles blocking the pressure release valve or the diffuser openings on the underside of the cover.

If you find any defects in the sealing gasket, **do not** use the pressure cooker. For a replacement sealing gasket, call customer service at **1 (800) 798-7398**.

Once all parts are washed and dried according the "Maintenance & Cleaning" section, your pressure cooker is ready for use.

Note: The pressure cooker cover has a locked position and an open position.

1. Remove the cover. To do so, turn cover clockwise until the cover locking pin lines up with the vapor collector. (Fig. 2)



Fig. 2

2. Place food inside the removable cooking pot.

Free Manuals Download Website

<http://myh66.com>

<http://usermanuals.us>

<http://www.somanuals.com>

<http://www.4manuals.cc>

<http://www.manual-lib.com>

<http://www.404manual.com>

<http://www.luxmanual.com>

<http://aubethermostatmanual.com>

Golf course search by state

<http://golfingnear.com>

Email search by domain

<http://emailbydomain.com>

Auto manuals search

<http://auto.somanuals.com>

TV manuals search

<http://tv.somanuals.com>