

# ***Bravetti***<sup>TM</sup>

## **Professional Deep Fryer**

Use and Care Instructions  
Model EP85



For information or assistance  
call 1 (800) 798-7398  
EURO-PRO Operating LLC

# **Bravetti/EURO-PRO**

## **ONE (1) YEAR LIMITED WARRANTY**

**EURO-PRO** CORPORATION warrants this product to be free from defects in material and workmanship for a period of one (1) year from the date of purchase when utilized for normal household use.

If your appliance fails to operate properly while in use under normal household conditions within the warranty period, return the complete appliance and accessories, freight prepaid to **EURO-PRO** Corporation. If the appliance is found by **EURO-PRO** to be defective in material or workmanship, **EURO-PRO** will repair or replace it free of charge. Proof of purchase date and \$7.50 to cover the cost of return shipping and handling must be included.\*

The liability of **EURO-PRO** Corporation is limited solely to the cost of the repair or replacement of the unit at our option. This warranty does not cover normal wear of parts and does not apply to any unit that has been tampered with or used for commercial purposes. This limited warranty does not cover damage caused by misuse, abuse, negligent handling or damage due to faulty packaging or mishandling in transit.

This warranty is extended to the original purchaser of the unit and excludes all other legal and/or conventional warranties. The responsibility of **EURO-PRO** Corporation if any, is limited to the specific obligations expressly assumed by it under the terms of the limited warranty. **In no event** is **EURO-PRO** Corporation liable for incidental or consequential damages of any nature whatsoever. Some states do not permit the exclusion or limitation of incidental or consequential damages, so the above may not apply to you.

This warranty gives you specific legal rights, and you may also have other rights which vary from state to state.

**\*Important: Carefully pack item to avoid damage in shipping. Be sure to include proof of purchase date and to attach tag to item before packing with your name, complete address and phone number with a note giving purchase information, model number and what you believe is the problem with item. We recommend you insure the package (as damage in shipping is not covered by your warranty). Mark the outside of your package "ATTENTION CUSTOMER SERVICE".**



.....  
**OWNERSHIP REGISTRATION CARD**

Please fill out and mail the product registration card within ten (10) days of purchase in order to validate the foregoing Limited Warranty. The registration will enable us to contact you in the unlikely event of a product safety notification. By returning this card you acknowledge to have read and understood the instructions for use, and warnings set forth in the accompanying instructions.

\_\_\_\_\_  
**Appliance model**

\_\_\_\_\_  
**Date purchased**

\_\_\_\_\_  
**Name of store**

\_\_\_\_\_  
**Owner's name**

\_\_\_\_\_  
**Address**

\_\_\_\_\_  
**City**

\_\_\_\_\_  
**State**

\_\_\_\_\_  
**Postal code**

# IMPORTANT SAFEGUARDS

**When using electrical appliances, basic safety precautions should always be followed, including the following:**

1. Read all instructions.
2. Do not touch hot surfaces, use handles or knobs.
3. To protect against electrical shock, do not immerse cord and plug of this appliance in water or other liquids.
4. Close supervision is necessary when any appliance is used by or near children.
5. Unplug from outlet when not in use, and before cleaning. Allow to cool before putting on or taking off parts, and before cleaning the appliance.
6. Do not operate any appliance with a damaged cord or plug or after the appliance malfunctions, or has been damaged in any manner. Return appliance to **EURO-PRO** Corporation for examination, repair or adjustment. See warrantee.
7. Never plug in before the control part is installed in the body of the fryer and the heating element is placed in the oil container.
8. Make sure the basket-lifting knob is properly assembled and locked in place. See detailed instructions.
9. Do not turn the timer on until you have filled the container with oil.
10. Never overfill the fryer with oil. Fill only between the minimum and maximum levels, as indicated inside the oil container.
11. Be sure handle is properly assembled to the basket and locked in place. See detailed assembly instructions.
12. The use of accessory attachments not recommended by the appliance manufacturer may cause injuries.
13. Always insert heating element in the appliance first, then plug into the wall outlet. To disconnect, turn the timer to "0", remove plug from wall outlet then wait for the unit to cool completely before removing the heating element.
14. Extreme caution must be used when moving any appliance containing hot oil or other hot liquids.
15. Do not leave the appliance unattended while in use.
16. Do not use outdoors.
17. Do not let cord hang over edge of table or counter or touch hot surfaces.
18. Do not place on or near a hot gas or electric burner, or in a heated oven.
19. Do not use appliance for other than intended household use.

## **SAVE THESE INSTRUCTIONS FOR HOUSEHOLD USE ONLY**

## **SPECIAL SAFETY INSTRUCTIONS**

- A short power-supply cord is provided to reduce the risk resulting from becoming entangled in or tripping over a longer cord. An extension cord (or longer detachable cord) is not recommended for use with deep fryers.
- Never plug in the control part before it is installed in the body of the fryer with the heating element inside the oil container.

**SEE "SPECIAL SAFETY INSTRUCTIONS" CONTINUED ON PAGE 3**

## Main Components

**Bravetti™**

Model EP85

Professional Deep Fryer

120 Volt, 60 Hz

1700 watts

Oil Capacity: Maximum 13 cups (2.5 liters)

Timer: 0-30 minutes

Dimensions: 14" x 10" x 10"

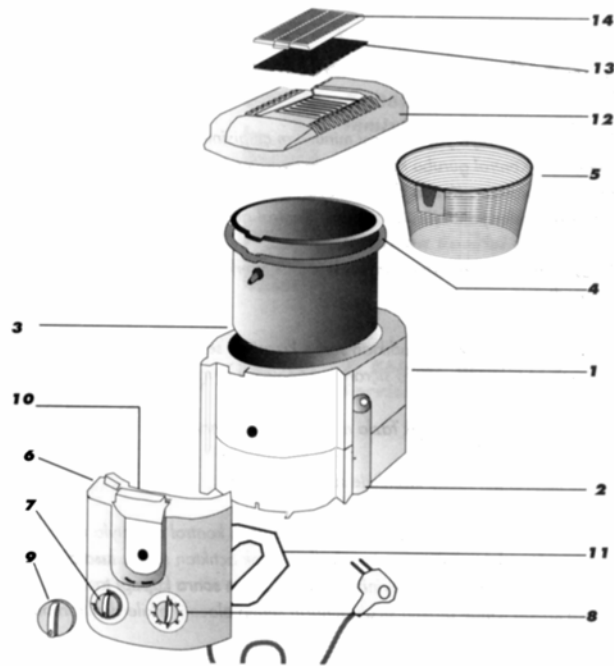

- |                                      |                               |
|--------------------------------------|-------------------------------|
| 1. Body                              | 8. Timer Setting Dial         |
| 2. Basket Handle                     | 9. Basket Lifting Knob        |
| 3. Oil Container                     | 10. Lid Opening Latch         |
| 4. Sealing Ring                      | 11. Heating Element           |
| 5. Frying Basket                     | 12. Lid (Cover)               |
| 6. Control Part with Heating Element | 13. Permanent Washable Filter |
| 7. Temperature Setting Dial          | 14. Filter cover              |

## SPECIAL SAFETY INSTRUCTIONS CONTINUED

- Never set the timer "On" when the oil container is empty or when the oil level is below the minimum line.
- Do not immerse the control part and heating element in water.
- When opening the lid after frying, first release the lid by pushing the latch with your finger, then wait a moment to allow the steam inside to escape before opening fully.
- To avoid a circuit overload, do not operate another high wattage appliance on the same circuit.

## SAVE THESE INSTRUCTIONS

### Contents

Important Safeguards .....	1
Special Safety Instructions .....	1,3
Main Components .....	2
<b>#1 Before Using for the First Time</b> .....	4
- Installing Basket Lifting Knob .....	4
- Cleaning the Deep Fryer .....	4
<b>#2 Filling the Stainless Steel Container With Oil</b> .....	6
- Using Solid Fat .....	6
<b>#3 Using the Deep Fryer</b> .....	7
- Pre-heating .....	7
- Setting Timer / Turning "On" the Unit .....	7
- Filling the Frying Basket .....	8
- Frying Food .....	8
<b>#4 At the End of Cooking</b> .....	9
<b>#5 Frying Tips</b> .....	10
<b>#6 Filtering &amp; Changing the Oil</b> .....	11
<b>#7 Cleaning the Washable Filter</b> .....	12
<b>#8 Cleaning Instructions</b> .....	13

Read all the sections of this booklet and follow all the instructions carefully.

## 1. BEFORE USING FOR THE FIRST TIME

**Warning:** Never plug in the control part when it is not installed in the fryer body with heating element in the oil container. Do not immerse the control part, cord or plug in water.

- 
- Open the lid by pressing up on the lid opening latch (#10). Fig. 1
- Remove any printed documents from the basket.
- Make sure the basket lifting knob (#9) is installed correctly. (It may come out of place while in transit.)

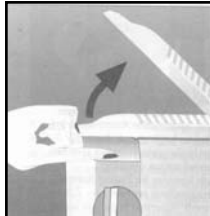

Fig. 1

### Installing Basket Lifting Knob

- Rotate knob while pressing with some force until flat part of socket fits over the flat of the post and the knob can be pushed in all the way. If knob is not fully inserted, it will come out easily and it might be difficult to lower and raise the basket.

### Prior to First Use, Clean the Unit Thoroughly

**Warning:** Always let the fryer cool completely for 1 ½ to 2 hours before taking it apart for cleaning. Never carry or move the Deep Fryer with hot oil inside. Before cleaning, always make sure the plug is not in the wall socket.

- Remove the lid (#12). Slide the lid to the right, then remove by pushing back the right hand side. Fig. 2
- Turn basket lifting knob counter-clockwise to raise the frying basket (#5) to the up position. Fig. 3
- Release the basket handle (#2) from its storage place by pressing with your index finger. Fig.4

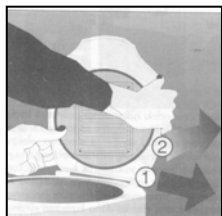

Fig. 2



Fig. 3

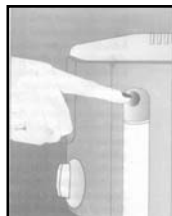

Fig. 4

- Use basket handle (#2) to remove the frying basket (#5) Always make sure the basket handle is securely attached to the basket. To attach the handle to the frying basket, insert the metal part of the handle inside the metal bracket on the frying basket. Fig. 5
- Pull out the basket lifting knob (#9). Fig. 6.
- Lift the control part with heating element (#6) out of its slots by pushing it up from the bottom with one hand while holding the body of the deep fryer with your other hand. **Please note:** Basket lifting knob (#9) must be removed before lifting out the control part (#6). Fig.7
- Remove the oil container. If necessary, you may also remove the sealing ring (#4) by sliding it down from the oil container when cleaning. Fig. 8
- Clean the oil container (#3) and the frying basket (#5) with hot water, dishwashing liquid and a non-abrasive sponge. **Never immerse the control part with heating element (#6) in water.**
- Dry thoroughly, and place the oil container with sealing ring and the frying basket back in the fryer, making sure the basket is hanging securely on the oil container.
- Insert the basket lifting knob (#9) and make sure that turning it will lower or raise the frying basket (#5).
- Wipe the inside of the lid and the outside of the fryer with a damp cloth. Install the lid.

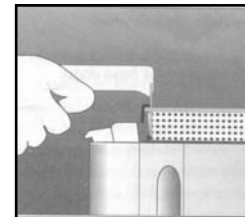

Fig. 5

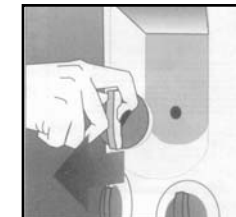

Fig. 6

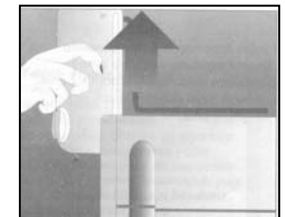

Fig. 7



Fig. 8

## 2. FILLING THE STAINLESS STEEL CONTAINER WITH OIL

**Warning:** Never plug in the Deep Fryer before filling with oil to specified level. Always make sure control part is securely in place in the body and the heating element is inside the oil in the container before plugging in.

- Use blended vegetable oil, pure corn oil or canola (rapeseed) oil. Do not use olive oil, margarine, lard or drippings.
- The oil level must always be maintained between the minimum (11 cup) and maximum (13 cup) levels marked inside the oil container (approx. 2.5 liters). Check oil level before each use. For best results, keep the oil close to the maximum level. Fig. 9
- Never mix different oils and fats together. Do not mix old and new oil.

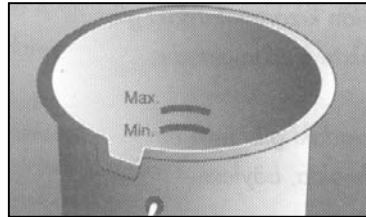

Fig. 9

### Using Solid Fat

**Warning:** Do not put solid shortening in the oil container or frying basket.

- If using solid vegetable shortening, melt it first in a separate pan and then very carefully pour the melted fat into the oil container.
- **Previously used solid vegetable shortening** which has curdled and hardened in the oil container should be removed from the oil container and melted in a separate pan before reusing.

**Warning:** If you try to melt the solidified fat in the oil container, there is a risk of warm melted fat suddenly sputtering from below through the still solid top layer of fat. Therefore use only the following procedure:

- Make sure the fat is at room temperature. If the fat is very cold there is a greater risk of splashing.
- Using a fork, carefully make some holes in the fat. Make sure the lid is securely closed while fat is melting. Set temperature dial to 320°F (160°C).

## 3. USING THE FRYER

**Warning:** Never plug in the Deep Fryer before filling with oil to specified level. Always make sure control part is securely in place in the body and the heating element is inside the oil in the container before plugging in.

### Pre-Heating

**Warning:** Never plug in the Deep Fryer before filling with oil. (See instructions in section #2.) Always unplug the appliance when not in use.

- Please note: During the first use, the deep fryer may give off a slight odor. This is normal and due to the newness of the product.
- Make sure the oil level in the container is between the "minimum" and "maximum" lines inside the container.
- Turn the basket lifting knob (#9) counter-clockwise to raise the basket to the up position. Fig. 10. After filling the basket, turn knob clockwise to lower.
- Close the lid (#12).
- Plug the appliance into a 120-volt outlet.
- Select the required temperature on the temperature setting dial (#7).



Fig. 10

### Safety Timer: Setting the Timer Will Turn the Deep Fryer "On"

**Warning:** Never touch any metal parts on the deep fryer because they may be hot.

- To pre-heat the oil, set the timer at 15 minutes turning the timer setting dial (#8) clockwise. Fig. 11
- **Setting the timer will automatically turn "on" the deep fryer.** The red light indicates that the unit is "on". The timer will turn the unit "off" at the end of the selected time period and the red light will go "off".
- The yellow light above the temperature dial will come on when the temperature is set and the deep fryer is "on" showing that the heating element is in operation. The yellow light goes off when the set temperature is reached.
- The temperature light may go on and off several times during frying. This indicates that the temperature is thermostatically maintained.

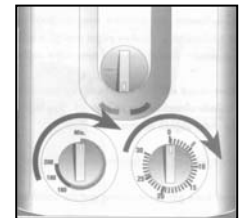

Fig. 11

## Filling the Frying Basket

- Make sure that the basket is raised to the up position by turning the basket lifting knob counter-clockwise.
- Place the food in the frying basket. Do not overfill it and never exceed the maximum quantities. **For optimum results and shorter frying time, basket should be only 1/2 to 3/4 full.**
- The basket has approximately 2 Lbs. food capacity. It will hold 4-5 average size pieces of chicken.
- **Do not fill the basket more than 1/2 to 3/4 full with frozen food.**

**IMPORTANT: When frying frozen foods such as french fries, you should not exceed 1.25 Lbs. (625 gr.). For healthy, crisp results limit quantity to 1 Lb. (500 gr.) or less.**

- Damp food must be dried thoroughly before frying.
- Remove any loose ice from frozen foods before frying.
- Follow instructions on frozen food packages to determine whether to cook food frozen or thawed.

## Frying Food

**Warning:** Do not touch any metal parts on the deep fryer because they may be hot.

- Always use the frying basket to fry food.
- **Always close the lid during frying.**
- When oil is pre-heated, yellow light will go off to indicate desired temperature is reached.
- Slowly turn the basket lifting knob clockwise to lower the basket into the hot oil. Lowering the basket too quickly can result in the oil overflowing and splashing.
- Slowly close the lid.
- It is normal for steam to escape through the sides of the lid while frying. Avoid standing too close to the deep fryer while it is working.

**Warning:** When opening the lid after frying, first release the lid by pressing the lid opening latch, then wait to allow steam to escape before opening the lid completely.

- Set timer for desired frying time. Frying time varies with the amount, type and thickness of the food to be fried. See table for guidance (section 5). However, please note that experience is ultimately the best guide. We therefore recommend carefully opening the lid and raising the basket from time to time to check the progress.
- If the food is fried to your satisfaction before the pre-set period elapses, you can switch off the timer by turning the timer setting dial (#8) to the left. You can add a few minutes to the pre-set time by turning the timer setting dial (#8) to the right.

## 4. AT THE END OF THE COOKING

**Warning:** When you have finished frying, always turn timer setting dial to "0" and temperature setting dial to lowest position and unplug the deep fryer. Do not touch any metal surfaces as they may be hot.

- Set temperature setting dial (#7) to lowest position, (turn fully counter-clockwise).
- Set timer dial (#8) to "0" (turn counter-clockwise).
- Unplug the main cord from the wall socket.
- Release the lid (#12) by pressing on the lid opening latch (#10) Fig. 12, then wait to allow steam to escape before opening the lid completely.
- Turn the basket lifting knob (#9) to raise the frying basket and allow the food to drain for a minute.
- Remove the basket handle (#2) from storage place and attach **securely** to the frying basket, then lift the frying basket and remove the food. Make sure the basket handle is securely attached to the frying basket before lifting.

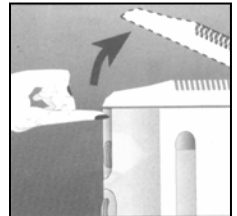

Fig. 12

**Warning:** Always let the deep fryer cool completely (approximately 2 hours) before cleaning or storing. Never carry or move the deep fryer with hot oil inside.

- Wind main cord around holder in the back before storing.

## 5. FRYING TIPS

- Do not mix different oils or old and new oil together.
- Replace oil regularly. In general, oil will be tainted faster when frying food containing a lot of protein, (such as meat and fish). When oil is used mainly to fry potatoes and is filtered after each use, it can be used up to 8 to 10 times but do not use the same oil for more than 6 months.
- Always replace all oil as soon as it starts foaming when heated or when color becomes dark or when it has a rancid smell or taste or becomes syrupy.
- Make sure that the food to be fried is dry.
- Remove loose ice from frozen food before frying.
- To cook evenly, pieces should be the same size and thickness.
- Thicker pieces will take longer to cook.

**Important:** When frying frozen foods such as french fries, you should not exceed 1.25 Lbs. (625 gr.). For healthy, crisp results, limit quantity to 1 Lb. (500 gr.) or less.

The following cooking times reflect only the approximate time needed to fry one basket  $\frac{1}{2}$  to  $\frac{3}{4}$  full. The exact time may be different depending on actual quantity, personal cooking preferences, size and thickness of pieces, etc...

### Temperature Settings

In general, use lower settings for delicate foods (vegetables, fish) and higher settings for frozen foods, french fries and chicken.

Food	Cooking Time	Temperature
French Fries	6-9 minutes	390°F
Fish Fillets	3-5 minutes	320°F
Chicken Fingers	6-8 minutes	350°F
Chicken Pieces	13-20 minutes	350°F
Fried Zucchini	3 minutes	320°F
Fried Mushrooms	3 minutes	320°F
Onion Rings	3 minutes	320°F
Donuts	3-5 minutes	350°F
Apple Beignets	4 minutes	350°F
Shrimp	4-6 minutes	390°F

## 6. FILTERING & CHANGING THE OIL

- Make sure the deep fryer is unplugged and the oil has cooled before cleaning or storing the deep fryer.
- The oil does not need to be changed after each use. In general, the oil will be tainted rather quickly when frying food containing a lot of protein (such as meat or fish). When oil is mainly used to fry potatoes and is filtered after each use, it can be used 8 to 10 times. However, do not use the same oil for longer than 6 months.
- To filter the oil, first make sure the oil has cooled and then empty the oil from the oil container into another container or bottle. Fig. 13 Wash and dry the oil container and basket. Refill the oil container with the oil, pouring the oil through a wire strainer or paper filter. Fig. 14

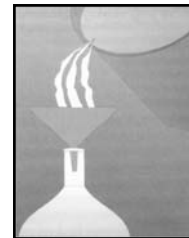

Fig. 13

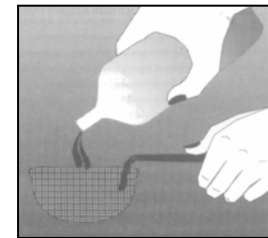

Fig. 14



## 7. CLEANING THE WASHABLE FILTER

- Your deep fryer is equipped with a washable aluminium filter to absorb odors. This filter should be cleaned at regular intervals.
- Depending on the amount of use, you can wash the filter while it is inside the cover or pry open the compartment where it is placed and remove the filter to wash separately. Fig. 15
- You may wash the filter (inside the lid or out) by hand with warm water and dish detergent or you may place it in the dishwasher.

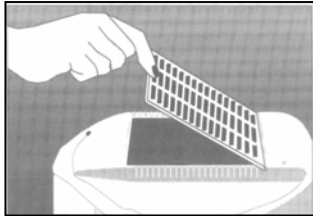

Fig. 15

## 8. CLEANING INSTRUCTIONS

**Warning:** Always remove the plug from the wall socket before cleaning. Allow the deep fryer and the oil to cool completely (approximately 2 hours) before cleaning. Never immerse the control part with the heating element, cord or the plug in water.

- Follow the cleaning instructions in section 1 ("Before Using for the First Time").
- Never immerse the control part with heating element, cord or plug in water or any other liquid.
- **Do not place the control part, cord or plug in the dishwasher.**
- Clean the control part only with a damp cloth.
- **The oil container, basket, and body of the deep fryer, lid and filter can be washed in the dishwasher.**

## Free Manuals Download Website

<http://myh66.com>

<http://usermanuals.us>

<http://www.somanuals.com>

<http://www.4manuals.cc>

<http://www.manual-lib.com>

<http://www.404manual.com>

<http://www.luxmanual.com>

<http://aubethermostatmanual.com>

Golf course search by state

<http://golfingnear.com>

Email search by domain

<http://emailbydomain.com>

Auto manuals search

<http://auto.somanuals.com>

TV manuals search

<http://tv.somanuals.com>