

BravettiTM

Cool Touch Deep Fryer

OWNER'S MANUAL

Model F2000
120V~, 60Hz., 1500 Watts

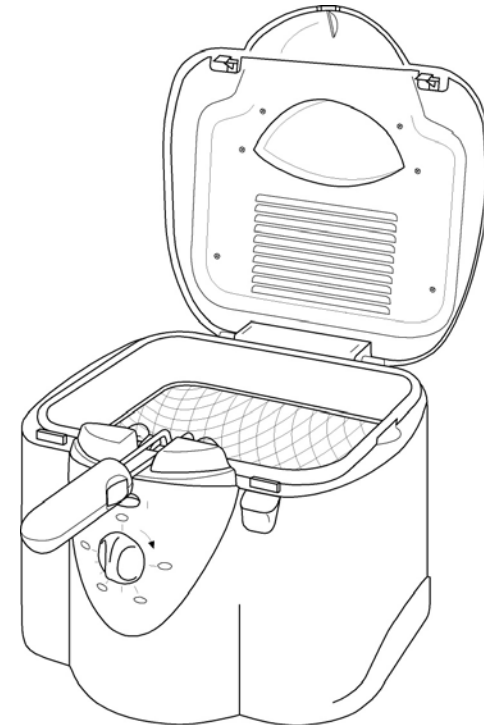

For information or assistance:

EURO-PRO Operating LLC

Boston, MA, 02465

1 (800) 798-7398

www.euro-pro.com

IMPORTANT SAFETY INSTRUCTIONS

When using electrical appliances, basic safety precautions should always be followed, including the following:

1. Read all instructions carefully before use.
2. Do not touch hot surfaces, always use handles or knobs.
3. To protect against electrical shock, do not immerse cord and plugs in water or other liquids.
4. Close supervision is necessary when any appliance is used by or near children.
5. Unplug from outlet when not in use and before cleaning. Allow to cool before putting on or taking off parts and before cleaning the appliance.
6. Do not operate any appliance with a damaged cord or plug, or after the appliance malfunctions, has been dropped or damaged in any manner. Return the appliance to **EURO-PRO Operating LLC** for examination, repair or adjustment. (See warranty.)
7. Never plug in before unit is assembled or before oil is added to Oil Container.
8. Never overfill the fryer with oil. Fill only between the minimum and maximum levels, as indicated inside the oil container.
9. Be sure handle is properly assembled to the basket and locked in place. (See assembly instructions.)
10. The use of accessory attachments not recommended by the appliance manufacturer may cause injuries.
11. Always insert heating element in the appliance before plugging into a wall outlet. To disconnect, remove plug from wall outlet then wait for the unit to cool completely before removing the heating element.
12. Extreme caution must be used when moving any appliance containing hot oil or other hot liquids.
13. Do not leave appliance unattended while in use.
14. Do not use outdoors.
15. Do not let cord hang over the edge of the table, counter or touch hot surfaces.
16. Do not place on or near a hot gas or electric burner, or in a heated oven.
17. Do not use appliance for other than intended household use.

SPECIAL SAFETY INSTRUCTIONS

- A short power supply cord is provided to reduce the risk resulting from becoming entangled in or tripping over a longer cord. **An extension cord (or longer detachable cord) is not recommended for use with deep fryers.**
- Never plug in the control panel before it is installed in the body of the fryer with the heating element inside the oil container.
- Do not immerse the control panel and heating element in water.
- When opening the lid after frying, first release the lid by pushing the latch with your finger, then wait a moment to allow the steam inside to escape before opening fully.
- To avoid a circuit overload, do not operate another high wattage appliance on the same circuit.

This appliance has a polarized plug (one blade is wider than the other). To reduce the risk of electric shock, this plug is intended to fit into a polarized outlet only one way. If the plug does not fit fully into the outlet, reverse the plug. If it still does not fit, contact a qualified electrician. Do not attempt to modify the plug in any way.

SAVE THESE INSTRUCTIONS FOR HOUSEHOLD USE ONLY

GETTING TO KNOW YOUR DEEP FRYER

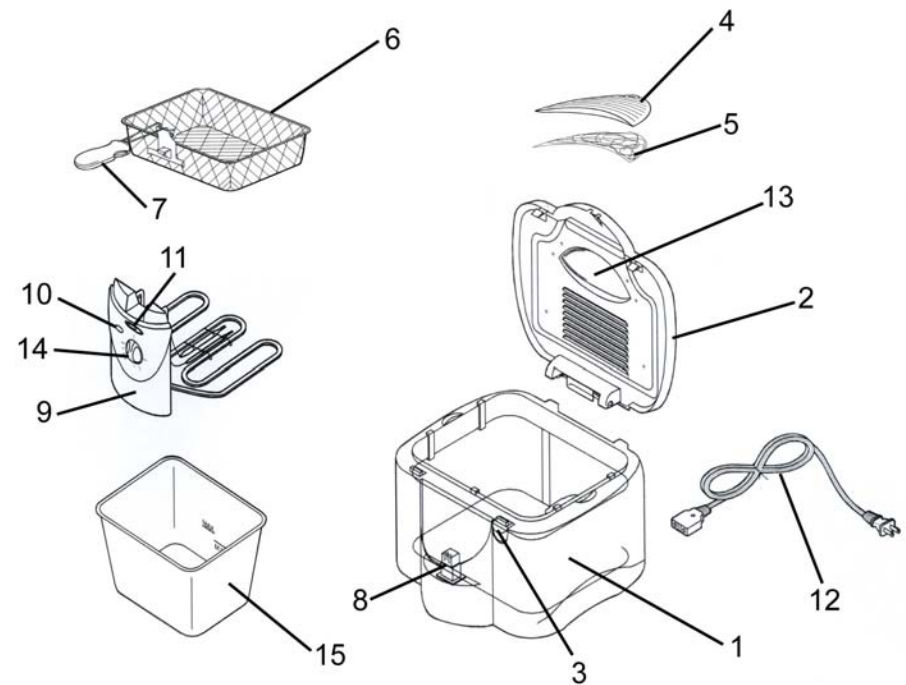

1. Main Enclosure
2. Removable Cover
3. Cover Release Button
4. Filter Cover
5. Removable Filter
6. Fryer Basket
7. Basket Handle
8. Control Panel Connecting Terminal
9. Removable Control Panel w. Heating Elements
10. On / Off Switch
11. Ready Indicator Light
12. Break Away Power Cord
13. Viewing Window
14. Temperature Control Knob
15. Oil Container / Pan

Technical Specifications

Voltage: 120V~ 60Hz.
Power: 1500 Watts
Capacity: 2.5 Liters

OPERATING INSTRUCTIONS

Before Using Your Deep Fryer

Make sure the fryer is unplugged. Wash the Frying Basket and Oil Container in hot, soapy water. Wipe dry thoroughly. Wipe the Removable Heating Control Panel and Heating Elements with a damp, soapy cloth. Wipe dry thoroughly.

NOTE: Any water left in Oil Container or on Frying Basket can cause heated oil to splatter or “pop” during cooking.

Assembling Your Deep Fryer

CAUTION: Never turn on the fryer when the oil pan is empty. Always ensure the fryer is out of the reach of children. Always use fryer on a flat, heat resistant surface.

1. Place filter in cover with carbon (black) side down (facing inside of fryer). Insert filter cover and snap (lock) into place. Open fryer cover by depressing Cover Release Button.
2. Place Oil Container inside base of unit.
3. Slide Control Panel with Heating Elements downward until it connects with the Control Panel Terminal on the outside of the fryer.
4. Make sure fryer On/Off Switch is in “Off” position.
5. Attach the “Break Away” Power Cord. When attaching cord - you will feel a magnetic pull on the cord when attaching cord correctly. (See Fig. 1)

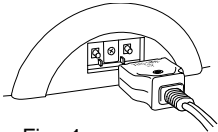

Fig. 1

6. Pour cooking oil into Oil Container. Do not exceed Max level for cooking oil. (See Fig. 2)

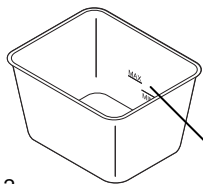

Fig. 2

Max level
for cooking oil.

7. Turn On / Off switch to “On” position. Switch Indicator Light will be on.
8. Attach Basket Handle to Fryer Basket. Press inward on the side of handle to depress the handle shafts. (See page 6 for further instructions on basket.) Place the handle shaft into the mating slots inside of the fryer basket. Make sure ends are in place and secure. Place Fryer Basket into unit. Set fryer temperature control to desired setting.
9. When cooking oil reaches desired setting, the Ready Indicator Light will illuminate. **Note:** The ready indicator light will cycle off and on during the frying cycle as the unit maintains the selected temperature.
10. Open the Cover, lift the Fryer Basket onto the Oil Draining Hook, place food into the Fryer Basket, carefully lower Fryer Basket back into heated oil and close Cover.
11. Cook food according to recommended cooking chart or until desired doneness.
12. When cooking is complete, open Cover, lift Frying Basket and hook onto Oil Draining Hook to allow food to drain.
Caution: Open cover carefully. There may be Hot Steam .
13. Remove food from Fryer Basket by lifting basket by its handle and **CAREFULLY** pouring food onto a plate covered with paper towels or desired serving container or removing food from basket with cooking utensils (example cooking tongs) and placing food onto serving container.
14. Repeat procedure for remaining food to be cooked.
Note: Always carefully replace and remove Fryer Basket when cooking. **Oil is very hot and can cause severe injury.**
15. When is cooking is complete, turn fryer off, unplug and allow to oil to cool approximately 2 hours before attempting to remove oil or clean fryer.
Note: Do not disconnect fryer by pulling on the Break Away Power Cord. Always turn fryer Off before unplugging from electrical outlet.

OPERATION INSTRUCTIONS

Read all the sections of this booklet and follow all the instructions carefully.

Warning: Although your deep fryer has a Cool Touch exterior to avoid possible injury or burns, never touch any metal parts on the deep fryer because they may be hot.

- Do not fill the Frying Basket when it is immersed in oil.
- Place the food in the Frying Basket. Do not drop food into hot cooking oil. Do not overfill it and never exceed the maximum quantities. For optimum results and shorter frying time, basket should be only 1/2 full.
- The basket has approximately 1 lbs. food capacity. It will hold 3-4 average size pieces of chicken.
- Do not fill the basket higher than the MAX line on the basket with frozen food.

Frying Food

Warning: When frying foods, remove the Frying Basket from the Deep Fryer before filling with frozen food because oil will spatter and cause burns.

Caution: When frying frozen foods such as French Fries, you should not exceed 3/4 Lb. (350 gr.) or less. Clean off any ice from frozen food prior to frying. Failure to do so may cause fryer to overflow when food is placed in oil.

- Always use the Frying Basket to fry food.
- Always close the Cover during frying.
- When the oil is pre-heated, Ready Indicator Light will come on indicating the desired oil temperature has been reached.
- Slowly lower the Frying Basket into the hot oil. Lowering the Frying Basket too quickly can result in the oil overflowing and splashing.
- Replace the Cover carefully.
- It is normal for steam to escape through the sides of the Cover while frying.
- Avoid standing too close to the Deep Fryer while it is cooking.

Warning: When opening the Cover after frying, lift up the Cover slightly, then wait to allow steam to escape before opening the Cover completely. Keep face away from unit to avoid burns caused by escaping steam.

- Press the On/Off Switch to turn unit Off”
- Unplug the Power Cord from the wall socket.
- Lift up the Cover slowly and wait to allow steam to escape before opening the Cover completely.
- Lift up the Frying Basket by the handle. Place it on the Oil Draining Hook and allow the food to drain for a minute.
- Once the oil has drained from the Frying Basket, the basket may be lifted off and the food served.

Warning: Always let the Deep Fryer cool completely (approximately 2 hours) before cleaning or storing. Never carry or move the Deep Fryer with hot oil inside.

Frying Tips

- To avoid condensation buildup on the Cover Window - rub a little cooking oil on window.
- Do not mix different oils or new and old oil together.
- Replace oil regularly. In general, oil used to fry food with protein, (such as poultry, meat and fish) should not be reused. When oil is used mainly to fry potatoes and is filtered after each use, it can be used up to 8 to 10 times, but do not use the same oil for more than 6 months.
- Always replace all oil as soon as it starts foaming when heated or when color becomes dark or when it has a rancid smell or taste or becomes syrupy.
- Make sure that the food to be fried is dry.
- Remove loose ice from frozen food before frying.
- To cook evenly, pieces should be the same size and thickness.
- Thicker pieces will take longer to cook.

Warning: Never plug in the Control Panel when it is not assembled to the fryer body. Do not immerse the Control Panel, Power Cord or plug in water or any other liquid.

Warning: This unit should not be used to boil water.

OPERATION INSTRUCTIONS

Using Solid Fat

Warning: It is **NOT RECOMMENDED** to put solid shortening in the Oil Container or the Frying Basket.

- If using solid vegetable shortening, melt it first in a separate pan and then very carefully pour the melted fat into the Oil Container.
- Previously used solid vegetable shortening which has curdled and hardened in the Oil Container should be removed from the Oil Container and melted in a separate pan before reusing.

Caution: If you try to melt the solidified fat in the Oil Container, there is a risk of warm melted fat suddenly sputtering from below through the still solid top layer of fat. Therefore use only the following procedure:

- Make sure the fat is at room temperature. If the fat is very cold, there is a greater risk of splashing.
- Using a fork, carefully make some holes in the fat. Make sure the Cover is securely closed while fat is melting. Heat fat slowly - on lowest temperature setting.

Warning: Never plug in the Deep Fryer before filling with oil to specified level. Always make sure Deep Fryer is properly and completely assembled before using or plugging into wall outlet.

Important: Ensure the Control Panel is fitted correctly to the main unit otherwise the unit will not function. This is not a defect. This product is fitted with a safety switch to prevent the unit from turning on accidentally.

- Set the required temperature by turning the Temperature Control Knob. – The temperature is adjustable from 155 °F to 375 °F.

Pre-Heating

Warning: Never plug in the Deep Fryer before filling with oil. (See How to Use Your Deep Fryer.) Always unplug the appliance when not in use.

- Make sure the oil level in the Oil Container is between the "minimum" and "maximum" lines inside the Oil Container.
- The Frying Basket should not be immersed in the oil during the pre-heating.
- Close Cover.
- Plug the appliance into a 120-volt outlet.
- Press the On/Off Switch to ON. The Power Indicator Light will come on. It's showing that the power is on.
- Turn the Temperature Control Knob to the desired temperature setting.

Filling the Oil Container With Oil

Warning: Never plug in the Deep Fryer before filling with oil to specified level. Always make sure Control Panel is securely in place in the body and the Heating Element is inside the oil in the container before plugging in.

- Use blended vegetable oil, pure corn oil or canola (rapeseed) oil. Do not use olive oil, margarine, lard or drippings.
- The oil level must always be maintained between the minimum and the maximum levels marked inside the oil container. (See Fig. 2) Check the oil level before each use. For best results, keep the oil close to the maximum level (10 cups/2.5 liters). Never mix different oils and fats together. Do not mix old and new oil.

OPERATING INSTRUCTIONS

Read all the sections of this booklet and follow all the instructions carefully.

Using for the First Time

Warning: Never plug in the Heating Control Panel when it is not properly installed in the fryer body. Do not immerse the Control Panel, Power Cord or plug in water or any other liquid.

Prior To First Use, Clean The Unit Thoroughly

Warning: Always let the fryer cool completely for 2 hours before taking it apart for cleaning. Never carry or move the Deep Fryer with hot oil inside. Before cleaning, always make sure the unit is unplugged from the wall socket and turned Off"

- All components except the electrical parts (Power Cord, Control Panel with Heating Elements and Main Enclosure), can be washed in warm soap water. Dry thoroughly before use.
- Use Basket Handle to remove the Frying Basket. Always make sure the Basket Handle is securely attached to the basket. Attach the handle to the Frying Basket, insert the metal part of the handle inside the metal bracket on the Frying Basket. (Fig. 3)
- Lift the Control Panel with Heating Element out of its slots by pushing it up from the bottom with one hand while holding the body of the Deep Fryer with your the other hand.
- Remove the Oil Container.
- Clean the Oil Container and the Frying Basket with hot water, dishwashing liquid or other non-poisonous detergent and non-abrasive sponge.

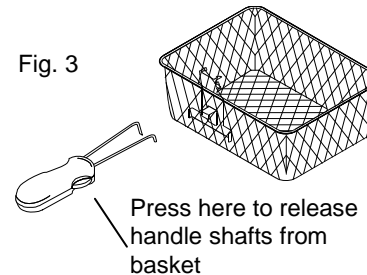

Warning: This unit should not be used to boil water.

Warning: Never immerse the Control Panel in water or any other liquids.

Warning: All components must be completely dried before filling with oil or using. Special care must be taken to ensure the washable Oil Filter located in the Cover is completely dry, otherwise the filter will not function properly and may lead to steam being trapped within the fryer during use.

Warning: Never exceed "MAX" line when filling the basket with food. (Fig. 4)

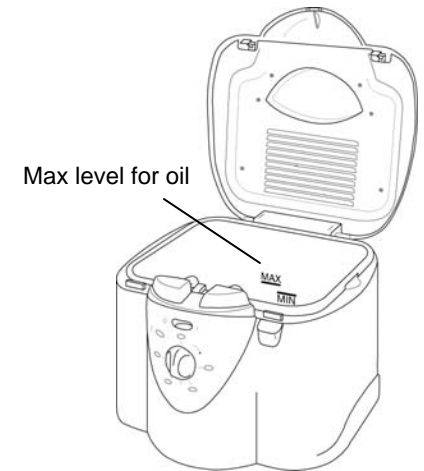

Warning: Never use the Break Away Power Cord to turn Deep Fryer Off. Always turn unit Off by using the On/Off Switch first. Disconnect Power Cord from wall outlet. Use only the Power Cord provided with the Deep Fryer. Any use of another magnetic cord could cause fire, electric shock or injury.

OPERATING INSTRUCTIONS

To Store or Reuse Cooking Oil

- Make sure the Deep Fryer is unplugged and the oil has cooled (approximately 2 hours) before attempting to clean or store the Deep Fryer.
- The oil does not need to be changed after each use. We do not recommend storing and reusing oil that was used for frying high protein foods such as poultry, fish or other meats. When oil is mainly used to fry potatoes and is filtered after each use, it can be used 8 to 10 times. However, do not use the same oil for longer than 6 months.

- To filter the oil first make sure the oil has cooled and then empty the oil from the Oil Container into a storage container or bottle. (See Fig. 5) Wash and dry the Oil Container and basket. To reuse, refill the Oil Container with the oil, pouring the oil through a wire strainer or paper filter. (See Fig. 6)



Storing used oil



Filtering used oil.

CLEANING INSTRUCTIONS

Cleaning Instructions

Warning: Always turn unit OFF and remove the plug from the wall socket before cleaning. Allow the Deep Fryer and the oil to cool completely (approximately 2 hours) before cleaning. Never immerse the Control Panel, cord, plug or main enclosure in water or any other liquid.

- Please read and follow all instructions in this manual for best results with your Deep Fryer.
- Never immerse the Control Panel, cord, plug or main enclosure in water or any other liquid.
- Do not place the Control Panel, cord, plug or main enclosure in the dishwasher.
- Clean the Control Panel and main enclosure only with a damp cloth.
- The Oil Container, Frying Basket and Cover can be washed in the dishwasher. Always remove filter and filter cover before washing in the dishwasher.
- The main enclosure of the Deep Fryer can be washed with warm soapy water. **Do not** immerse the main enclosure of the Deep Fryer in the dishwasher.

- Do not use any type of abrasive pad or steel wool to clean the Power Cord magnetic socket.
- Do not use alcohol or cleaning solutions to clean Deep Fryer.

Replacing and Cleaning Filter

1. Open the Filter Cover.
2. Remove Filter. Filter may be washed in hot soapy water. Allow Filter to air dry before using.
3. Clean inside of the cover with a damp soapy cloth or sponge. Rinse and dry thoroughly.
4. Replace Filter by inserting **charcoal** (dark side) facing up closest to the filter cover. The white side is on the bottom. (Fig. 7)

Fig. 7

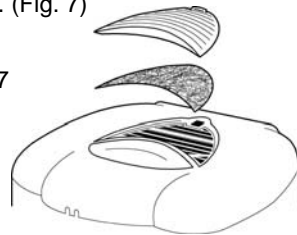

For replacement Filters, please call out Toll Free number - 800-798-7398 or write to the address listed on the front of this manual.

CLEANING INSTRUCTIONS

Detachable "Break Away" Power Cord

Your **Bravetti Cool Touch Deep Fryer** has been specifically designed with your safety in mind. Your Deep Fryer has a unique detachable power supply cord. This power supply cord is designed to "Break Away" from the fryer in the event that the power cord or fryer is inadvertently pulled or tugged. This is intended to prevent the tipping of the appliance and hazardous spillage of hot oil. It is **NOT** intended to disconnect the fryer during normal use.

To connect the power cord - note the instructions on the cord plug area - "THIS SIDE UP". Place cord into opening - you will feel the magnetic pull. Slide cord into slot until it connects. (See Fig. 8)

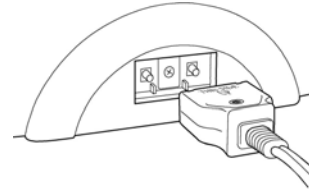

Fig. 8

Warning:

Do not use the "Break - Away" Power Cord to disconnect the Deep Fryer. Always disconnect plug from electrical outlet first before removing the power cord.

Warning:

The "Break-Away" Power Cord is only for accidental disconnection of the Deep Fryer. It is not to be removed during normal operation. If the cord should be disconnected from the unit during operation, the user should **immediately unplug the power cord** from the electrical wall outlet before any attempt to reconnect the magnetic cord back to the deep fryer unit. Do not come in contact with the magnetic connection of the power cord while it is plugged into electrical wall outlet. Injury can occur.

Warning:

Do not attempt to defeat the magnetic cord connection by attempting to permanently attach the power cord to the Deep fryer.

TEMPERATURE and COOKING GUIDE

Temperature Settings

The following cooking times reflect only the approximate time needed to fry one basket 1/2 full. The exact time may be different depending on actual quantity, personal cooking preferences, size and thickness of pieces, etc... In general, use lower settings for delicate foods (vegetables, fish) and higher settings for frozen foods, French Fries and Chicken.

Food	Cooking Time	Temperature
French Fries	6-9 minutes	375°F
Fish Fillets	3-5 minutes	320°F
Chicken Fingers	6-8 minutes	350°F
Chicken Pieces	13-20 minutes	350°F
Fried Zucchini	3 minutes	320°F
Fried Mushrooms	3 minutes	320°F
Onion Rings	3 minutes	320°F
Donuts	3-5 minutes	350°F
Apple Beignets	4 minutes	350°F
Shrimp	4-6 minutes	320°F

Apple Fritters

- 3 cups all-purpose flour
- 2 teaspoons baking powder
- 1/2 teaspoon salt
- 1 cup sugar
- 1 egg, lightly beaten
- 4 tablespoons cooking oil
- 1 teaspoon vanilla extract
- juice of 1 orange (1/3 cup)
- 1 cup chopped apple

Preheat oil to 375°F. Combine flour, baking powder, salt and sugar: set aside. Combine egg, cooking oil and vanilla. Combine dry and liquid ingredients, stir to blend thoroughly. Add orange juice and apple, mix well. Drop from teaspoon into hot oil. (Basket should be lowered into oil so drop carefully - avoiding splattering oil). Fry approximately 2 minutes or until crisp and very brown. Remove from oil and drain. Dust with powdered sugar or a mixture of granulated sugar and cinnamon. Serve warm for best results. Try topping with a scoop of vanilla ice cream for an added treat.

Beer Batter for Fish or Chicken

- 2 eggs(separated)
- 1 tablespoon oil or butter
- 1 teaspoon salt
- 1/4 teaspoon ground black pepper
- 1 1/3 cup all-purpose flour
- 3/4 cup flat beer
- Boneless chicken breasts (optional)
- Fish fillets or frying fish (optional)

Preheat oil to 360°F. Beat egg yolks with oil or butter, salt and pepper. Alternately add the beer and flour to the mixture. Beat ingredients well, refrigerate for 3 to 12 hours. When you are ready to use mixture, gently fold in 2 stiffly beaten egg whites. Pat fish or boneless chicken breasts to remove excess liquid. Coat lightly with flour then dip into beer batter. Place fish in hot carefully (basket should already be lowered into oil) and fry for 3 to 5 minutes or until golden brown. Fry chicken 5 to 10 minutes (depending on thickness) or until brown and fully cooked.

Deep Fried Chicken

- 1 fryer chicken (2 to 3 lbs.)
- 1 1/2 cup all-purpose flour
- 1 teaspoon seasoned salt
- 1/4 teaspoon salt
- 1/4 teaspoon garlic powder (optional)
- 1/4 teaspoon poultry seasoning (optional)
- 1 1/2 cup milk)

Preheat oil to 360°F. Combine flour and seasonings, mixing well. Dip or roll chicken in seasoned flour, dip into milk, and then flour again. Place into Frying Basket, lower basket into preheated oil. Fry for 15 to 20 minutes or until golden brown and fully cooked.

Chicken Kiev

- 4 whole boneless, skinless chicken breasts
- 1 tablespoon chopped onion
- 1 tablespoon parsley
- 1 1/2 teaspoon salt

Preheat oil to 360°F. Place chicken breast between two pieces of plastic wrap. Pound with wooden mallet to flatten chicken to 1/4 inch thick. Remove plastic. Combine onion, parsley and salt. Sprinkle chicken with mixture. Cut butter into 8 pieces. Place a piece of butter on seasoned chicken toward one end. Roll as jelly roll, starting at end with butter, tucking in sides of meat. Press to seal well. (No butter should be seen on the sides or coming from the chicken) Secure with toothpicks. Dust with flour, dip into beaten egg. Then roll in bread crumbs. Chill rolls of chicken for at least one hour or until it has set. Place rolled chicken in a single layer in Frying Basket. Lower basket into preheated oil. Cook 5 to 7 minutes or until brown. To test for doneness, remove a piece of chicken from cooking oil. When a fork can be inserted with ease, chicken is done.

Hush Puppies

- 1 3/4 cup cornmeal
- 1/2 cup all-purpose flour
- 3/4 teaspoon baking soda
- 1/2 teaspoon salt
- 1 teaspoon sugar
- 1/2 teaspoon garlic salt (or 1/4 teaspoon garlic powder)
- 1/2 cup chopped onion
- 1 cup buttermilk
- 1 egg

Preheat oil to 375°F. Sift together cornmeal, flour, baking soda, salt, sugar and garlic salt (or powder). Combine egg and buttermilk, add to dry ingredients gradually, stirring until mixture is moist. Drop batter by teaspoonfuls into preheated oil (basket should already be lowered) frying a few at a time. Turn hush puppies once - if needed to evenly brown and cook until golden brown. Remove and drain on paper towels or food draining rack.

Quick Doughnuts

- 1 10 count can of refrigerated can biscuits
- 2 tablespoons ground cinnamon
- 1/2 cup sugar

Preheat oil to 375°F. Remove biscuits from can. Take each biscuit and flatten slightly with palm of hand. Punch holes in center of each biscuit with your finger to shape into doughnuts. Fry 2 minutes - turning once or until brown. Remove from basket and drain on paper towels or food draining rack. Roll doughnut in mixture of cinnamon and sugar. Serve warm.

Try rolling doughnut in a mixture of 1 cup Ten X powdered sugar, 1/2 teaspoon vanilla and 4 tablespoon milk for a different treat. You may add more milk to achieve your desired consistency.

Model F2000



ONE (1) YEAR LIMITED WARRANTY

EURO-PRO Operating LLC warrants this product to be free from defects in material and workmanship for a period of one (1) year from the date of purchase when utilized for normal household use.

If your appliance fails to operate properly while in use under normal household conditions within the warranty period, return the complete appliance and accessories, freight prepaid. For Customer Service support, call 1 (800) 798-7398 or visit our website www.euro-pro.com.

If the appliance is found by **EURO-PRO Operating LLC** to be defective in material or workmanship, **EURO-PRO Operating LLC** will repair or replace it free of charge. Proof of purchase date and \$11.95 to cover the cost of return shipping and handling must be included.*

The liability of **EURO-PRO Operating LLC** is limited solely to the cost of the repair or replacement of the unit at our option. This warranty does not cover normal wear of parts and does not apply to any unit that has been tampered with or used for commercial purposes. This limited warranty does not cover damage caused by misuse, abuse, negligent handling or damage due to faulty packaging or mishandling in transit.

This warranty is extended to the original purchaser of the unit and excludes all other legal and/or conventional warranties. The responsibility of **EURO-PRO Operating LLC** if any, is limited to the specific obligations expressly assumed by it under the terms of the limited warranty. **In no event is EURO-PRO Operating LLC** liable for incidental or consequential damages of any nature whatsoever. Some states do not permit the exclusion or limitation of incidental or consequential damages, so the above may not apply to you.

This warranty gives you specific legal rights, and you may also have other rights which vary from state to state.

***Important: Carefully pack item to avoid damage in shipping. Be sure to include proof of purchase date and to attach tag to item before packing with your name, complete address and phone number with a note giving purchase information, model number and what you believe is the problem with item. We recommend you insure the package (as damage in shipping is not covered by your warranty). Mark the outside of your package "ATTENTION CUSTOMER SERVICE".**



OWNERSHIP REGISTRATION CARD FOR CANADIAN CONSUMERS ONLY

Please fill out and mail the product registration card within ten (10) days of purchase. The registration will enable us to contact you in the unlikely event of a product safety notification. By returning this card you acknowledge to have read and understood the instructions for use, and warnings set forth in the accompanying instructions.

RETURN TO:

EURO-PRO Operating LLC, 4400 Bois Franc, St-Laurent, QC, H4S 1A7

Model F2000

Appliance model

Date purchased

Name of store

Owner's name

Address

City

Prov.

Code

Free Manuals Download Website

<http://myh66.com>

<http://usermanuals.us>

<http://www.somanuals.com>

<http://www.4manuals.cc>

<http://www.manual-lib.com>

<http://www.404manual.com>

<http://www.luxmanual.com>

<http://aubethermostatmanual.com>

Golf course search by state

<http://golfingnear.com>

Email search by domain

<http://emailbydomain.com>

Auto manuals search

<http://auto.somanuals.com>

TV manuals search

<http://tv.somanuals.com>