



12H800

Illustrated Parts List

Model Series

12H800

TYPE NUMBERS
0652 through 6699.

TABLE OF CONTENTS

Alternator	7
Air Cleaner	4
Blower Housing/Shrouds	6
Camshaft	2
Carburetor	3
Controls	5
Crankshaft	2
Cylinder	2
Electric Starter	7
Electrical	7
Engine Sump	2
Exhaust System	4
Flywheel	7
Flywheel Brake	7
Fuel Supply	5
Governor Spring	5
Ignition	7
Kits/Gaskets	2 & 3
Lubrication	2
Piston Group	2
Rewind Starter	7
Valves	2



PRINTED IN U.S.A.

COPYRIGHT by BRIGGS & STRATTON CORPORATION
All rights reserved. No part of this material may be reproduced or transmitted,
in any form or by any means, electronic or mechanical, including photocopying,
recording or by any information storage and retrieval system, without permission
in writing from Briggs & Stratton Corporation.

12H800

1319 WARNING LABEL



REQUIRED when replacing parts with warning labels affixed.

1058 OPERATOR'S MANUAL



1330 REPAIR MANUAL



1019 LABEL KIT

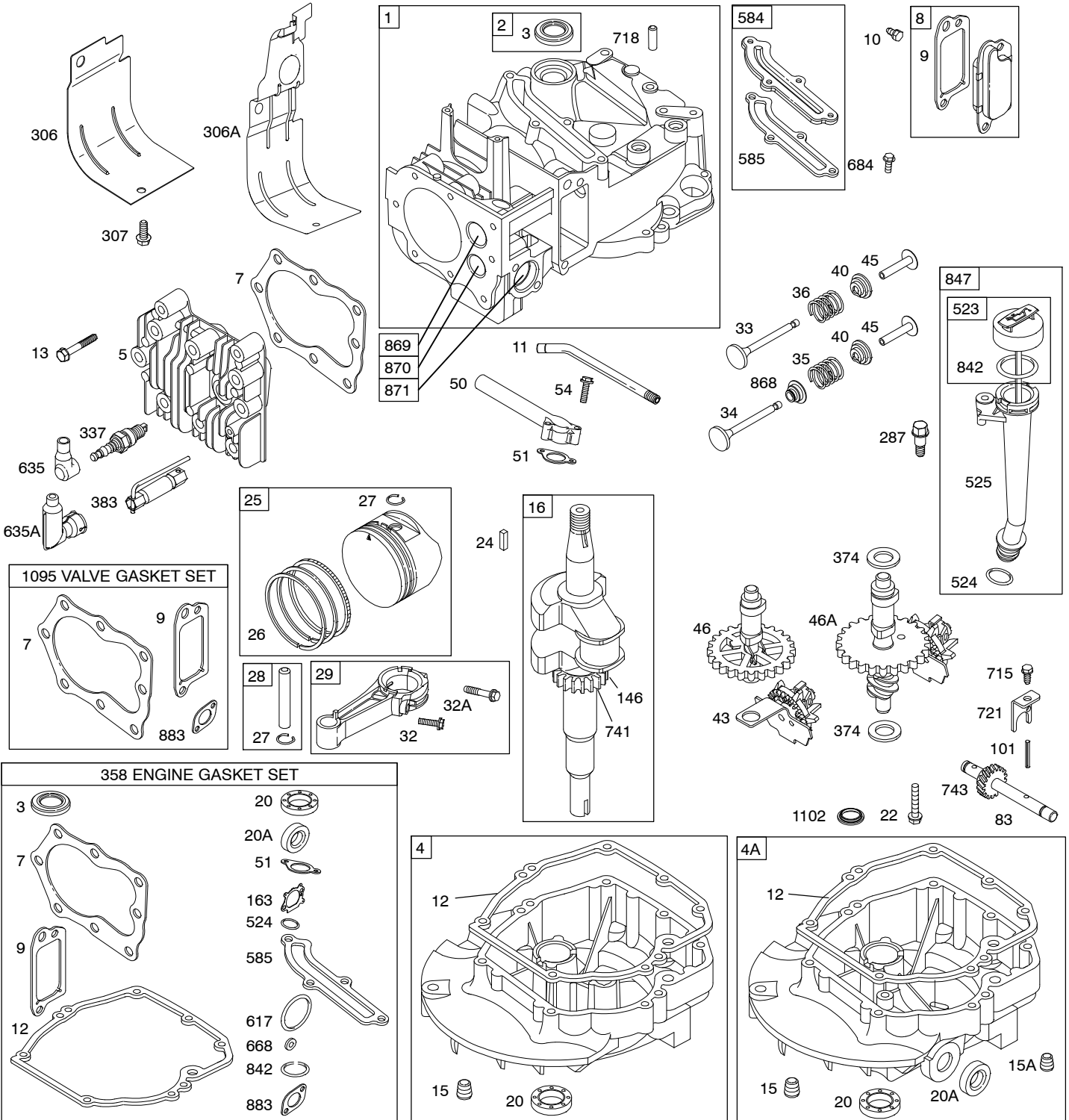

Illustrations cover a range of engines. Parts shown without corresponding text may not be used on your specific engine. 0990-2 Assemblies include all parts shown in frames. 07/01/2008

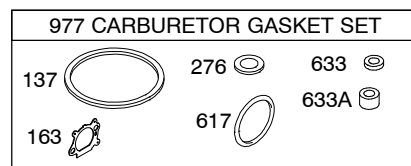
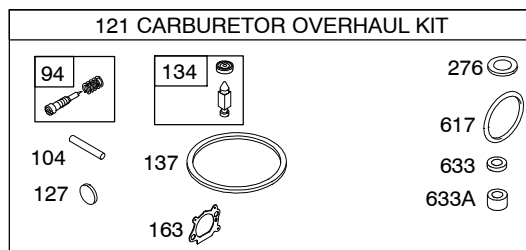
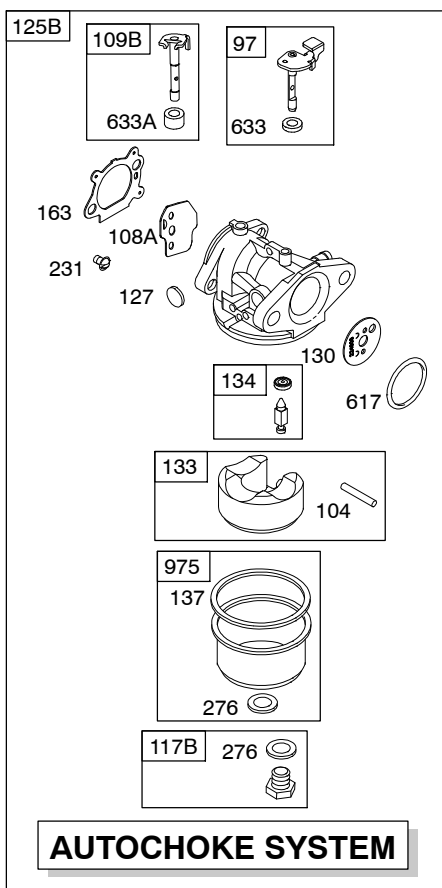
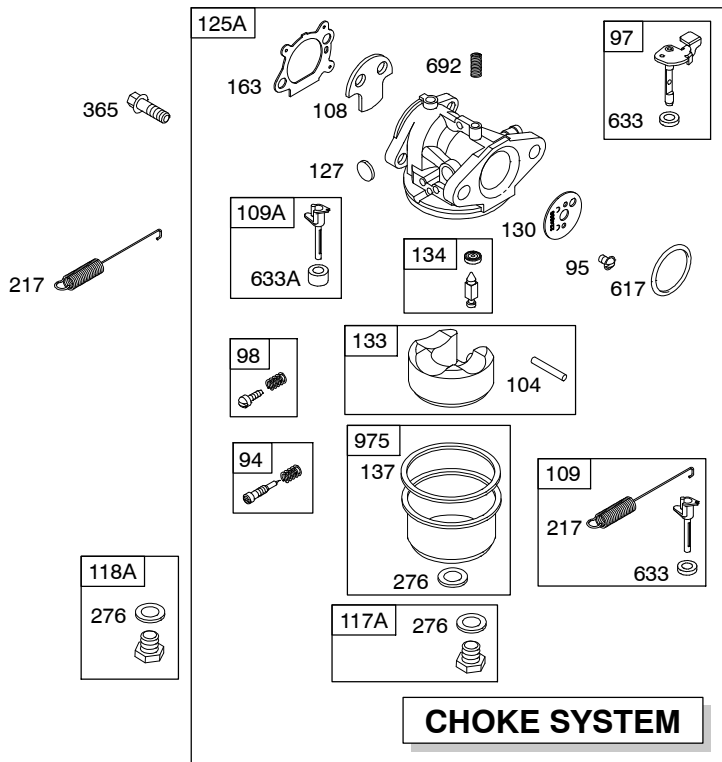
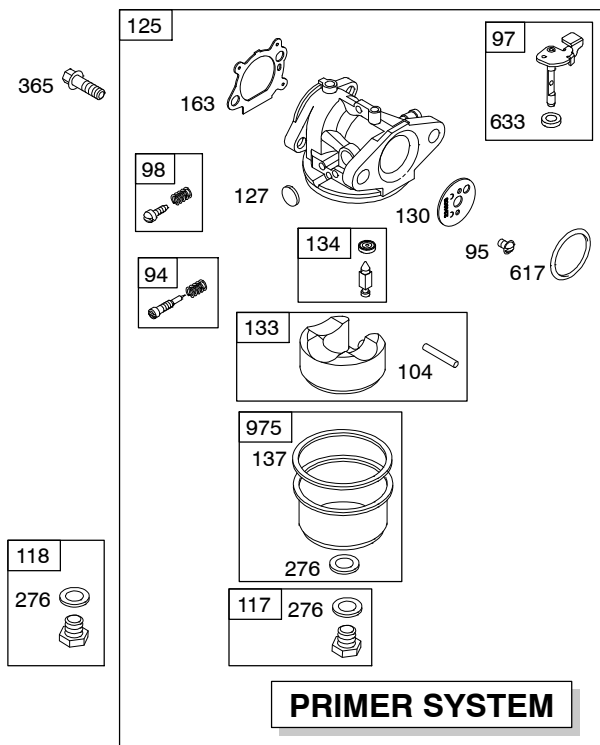

Illustrations cover a range of engines. Parts shown without corresponding text may not be used on your specific engine.

12H800

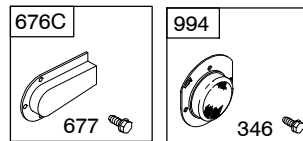
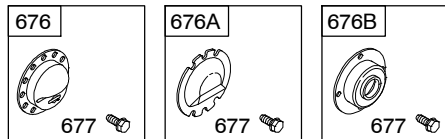
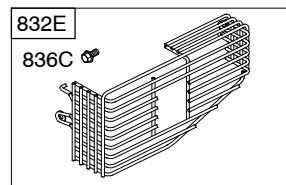
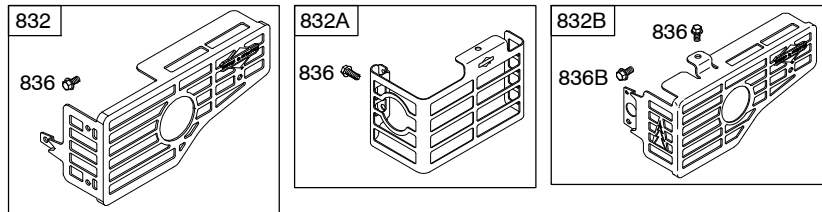
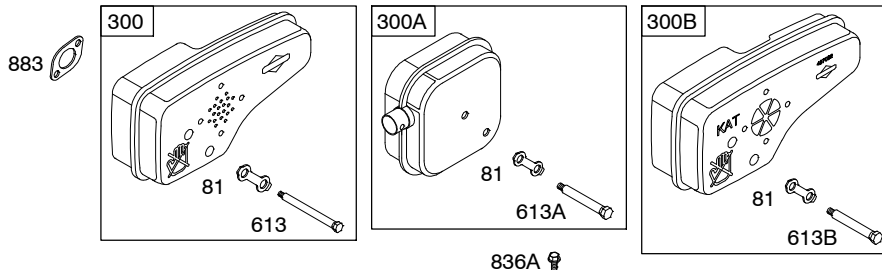
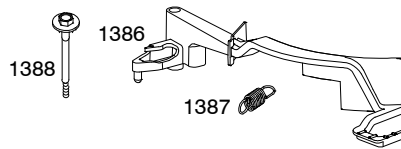
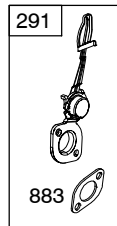
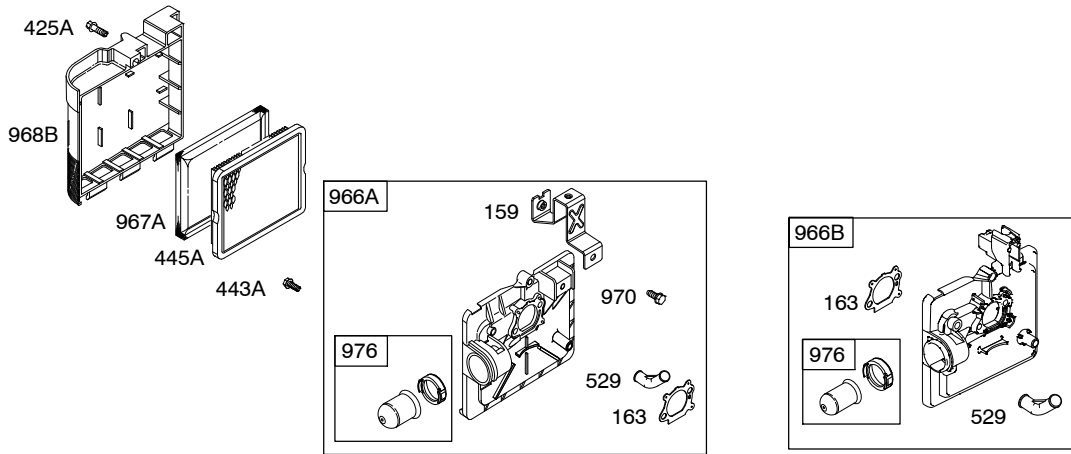

Illustrations cover a range of engines. Parts shown without corresponding text may not be used on your specific engine.
0990-4 Assemblies include all parts shown in frames. **07/01/2008**

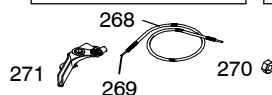
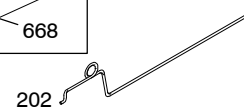
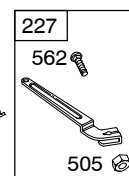
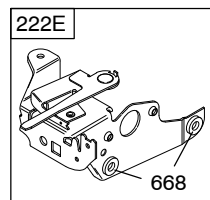
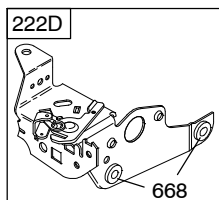
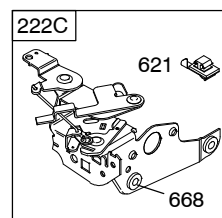
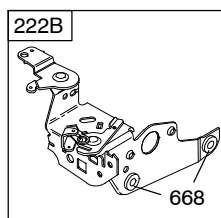
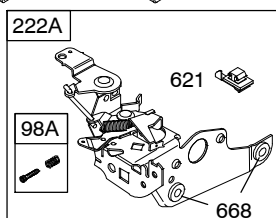
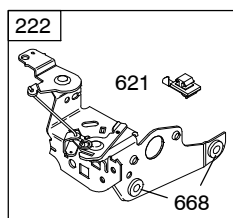
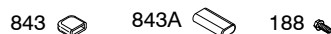
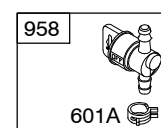
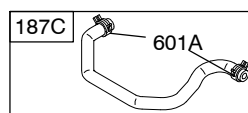
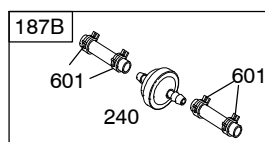
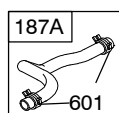
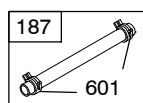
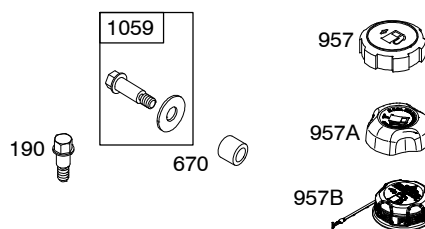
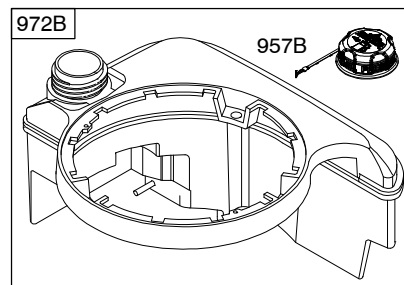
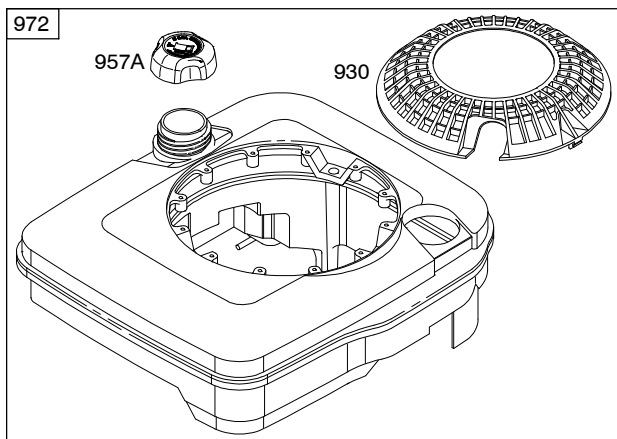

Illustrations cover a range of engines. Parts shown without corresponding text may not be used on your specific engine.

0990-5

Assemblies include all parts shown in frames.

07/01/2008

12H800

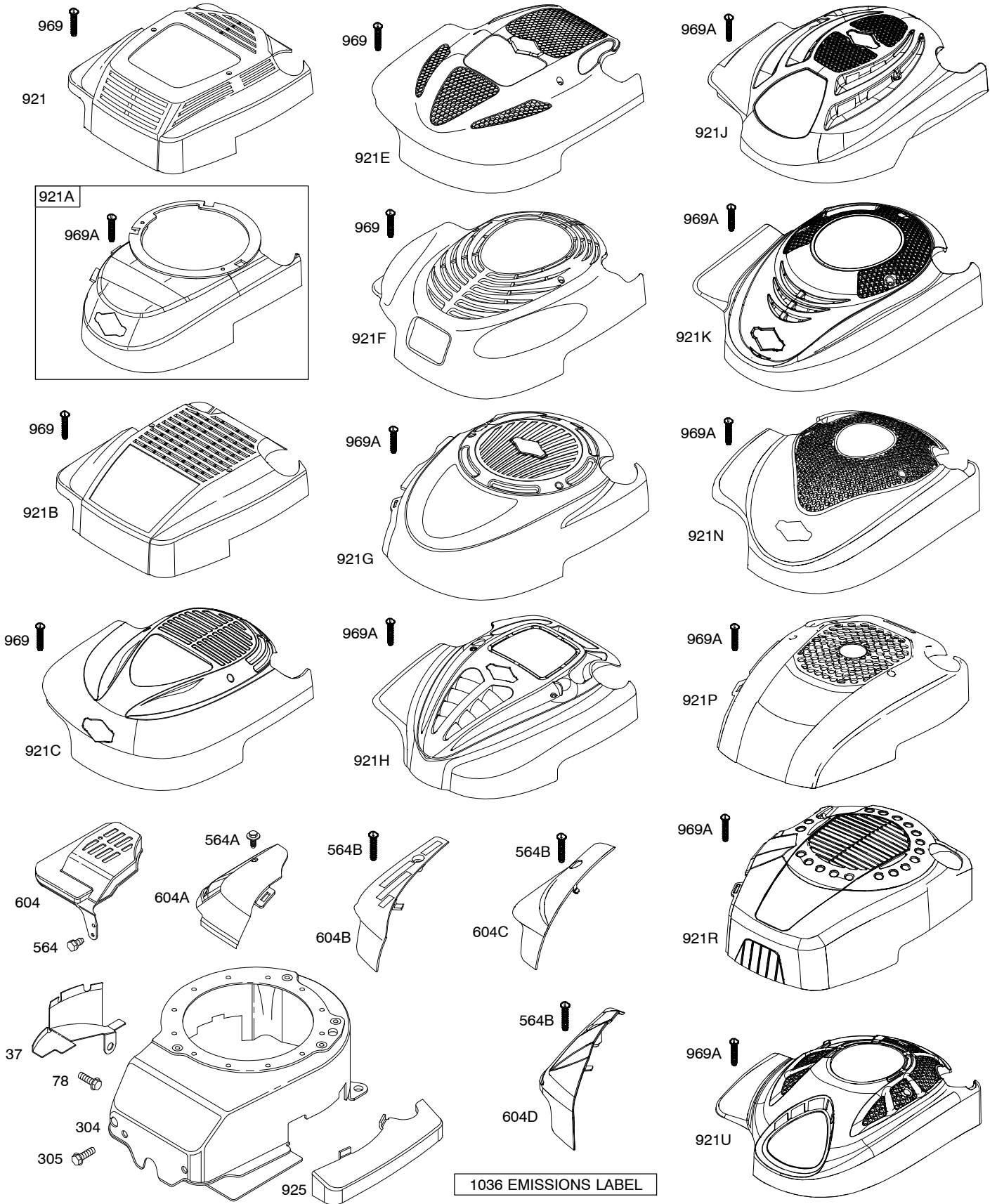

Illustrations cover a range of engines. Parts shown without corresponding text may not be used on your specific engine.
0990-6 Assemblies include all parts shown in frames. **07/01/2008**

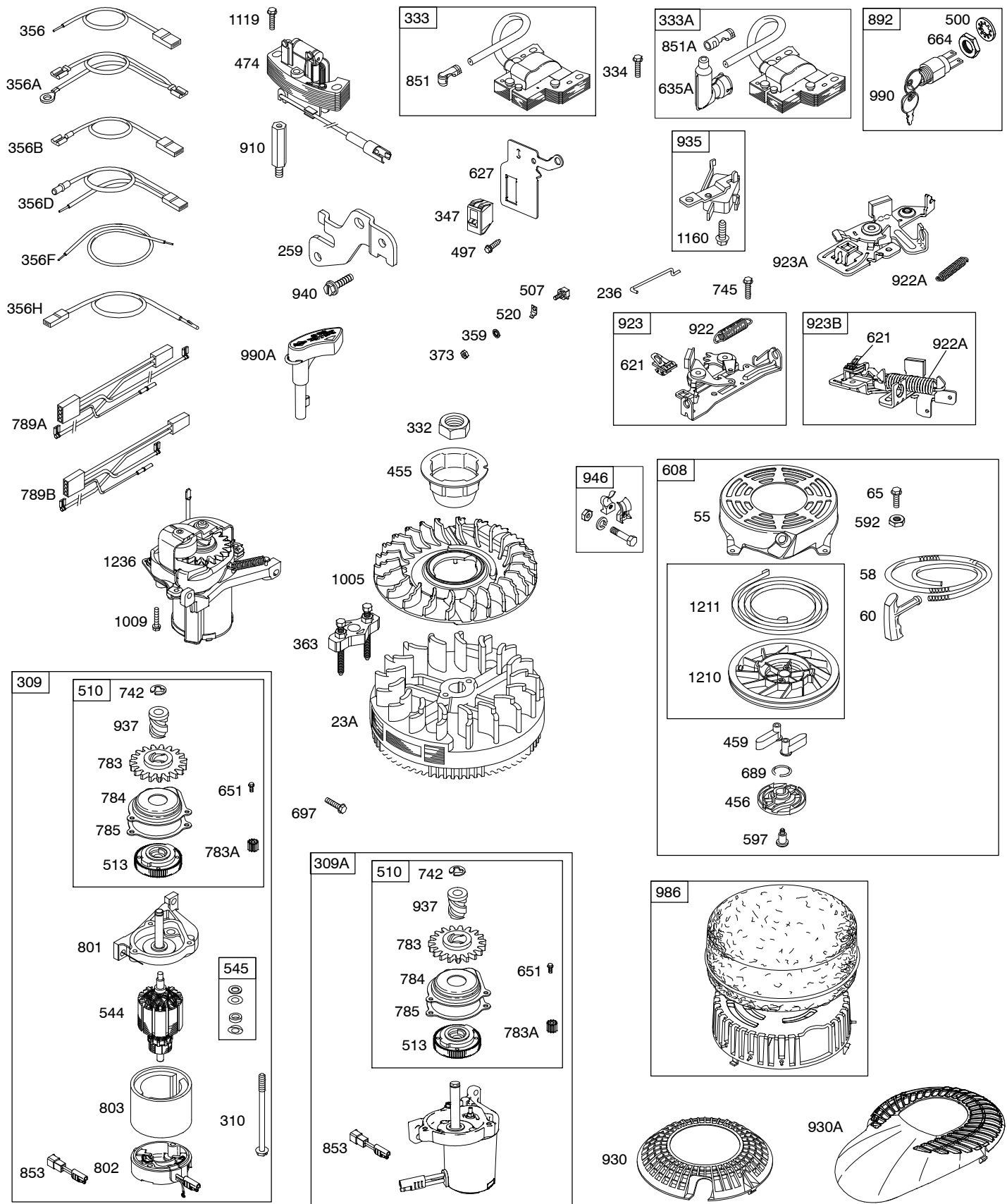

Illustrations cover a range of engines. Parts shown without corresponding text may not be used on your specific engine.
0990-7 Assemblies include all parts shown in frames. **07/01/2008**

12H800

REF. NO.	PART NO.	DESCRIPTION	REF. NO.	PART NO.	DESCRIPTION	REF. NO.	PART NO.	DESCRIPTION
1	697322	Cylinder Assembly	5	691160	Head-Cylinder	12	★692232	Gasket-Crankcase
2	399269	Kit-Bushing/Seal (Magneto Side)	7	★∅692249	Gasket-Cylinder Head	13	690912	Screw (Cylinder Head)
3	★299819S	Seal-Oil (Magneto Side)	8	495786	Breather Assembly	15	691680	Plug-Oil Drain (Square Socket)
4	493279	Sump-Engine ----- Note ----- 498983 Sump-Engine Used on Type No(s). 1167, 1715, 1955, 1961, 2320, 2324, 2331, 2367, 2673, 2681, 3182. 696294 Sump-Engine Used on Type No(s). 1375, 1376, 1379, 1717, 1718, 1719, 1730, 1731, 1732, 1735, 1754, 1781, 1792, 1795, 1809, 1811, 1959, 1960, 1996, 2002, 2042, 2043, 2108, 2326, 3181, 3187, 3188.	9	★∅699833	Gasket-Breather	15A	691093	Plug-Oil Drain (Hex Socket)
4A	493365	Sump-Engine (Auxilliary PTO)	10	94650	Screw (Breather Assembly)			
			11	691781	Tube-Breather			

★ Included in Engine Gasket Set-Ref. No.358.

● Included in Carburetor Overhaul Kit-Ref. No. 121.

◆ Included in Carburetor Gasket Set-Ref. No. 977.

∅ Included in Valve Gasket Set-Ref. No 1095.

Illustrations cover a range of engines. Parts shown without corresponding text may not be used on your specific engine.

0990-8

Assemblies include all parts shown in frames.

07/01/2008

REF. NO.	PART NO.	DESCRIPTION	REF. NO.	PART NO.	DESCRIPTION	REF. NO.	PART NO.	DESCRIPTION
16	691451	<p>Crankshaft (Used After Code Date 97011200).</p> <p>----- Note -----</p> <p>694442 Crankshaft (Used Before Code Date 97011300).</p> <p>691450 Crankshaft (Used After Code Date 97011200). Used on Type No(s). 0823,1520,1530,1531, 1532,1533,1567,1705, 1718,1746,1747,1751, 1769,1782,1850,1851, 1905,1906,1907,1910, 1911,1912,1913,1915, 1916,1918,1923,1939, 1940,1950,1951,1952, 1972,1975,1979,1980, 1987,2018,2019,2024, 2029,2150,2313,2375. 2376,2379,2380,2609, 2610,2611,2612,2630, 2631,2649,2667,2677, 2678,2679,2686,3120, 3123,3138,3140,3167, 3176,3184,3187,3188.</p> <p>694440 Crankshaft (Used Before Code Date 97011300). Used on Type No(s). 0823,1520,1530,1531, 1532,1533,1567,2630, 2631.</p> <p>692980 Crankshaft (Used After Code Date 97011200). Used on Type No(s). 0658,0660,1570,1758, 1760,1763,2670.</p> <p>694443 Crankshaft (Used Before Code Date 97011300). Used on Type No(s). 0658,0660,1758.</p>			<p>691452 Crankshaft (Used After Code Date 97011200). Used on Type No(s). 0664,0665,0666,0670, 0671,0672,0680,0840, 0866,0868,0873,0877, 0878,1150,1166,1170, 1171,1320,1326,1332, 1366,1368,1370,1371, 1372,1374,1375,1376, 1377,1378,1379,1544, 1559,1569,1723,1727, 1730,1731,1733,1734, 1736,1737,1738,1739, 1740,1748,1749,1770, 1771,1784,1785,1786, 1790,1794,1795,1801, 1803,1804,1805,1810, 1811,1814,1816,1818, 1821,1823,1825,1826, 1827,1829,1830,1831, 1832,1835,1837,1839, 1844,1845,1846,1847, 1849,1852,1914,1917, 1919,1920,1926,1932, 1935,1936,1941,1942, 1943,1947,1948,1958, 1959,1962,1964,1965, 1966,1967,1970,1973, 1976,1977,1983,1985, 1988,1991,1992,1993, 1994,1995,1996,2001, 2002,2006,2008,2009, 2010,2012,2014,2015, 2017,2023,2027,2028, 2035,2042,2043,2108, 2148,2149,2350,2644, 2669,2676,3130,3132, 3137,3166,3169,3170, 3181,3185,3186,3189, 3313,3314,3315,3320, 3322,3323,3325.</p> <p>694059 Crankshaft (Used Before Code Date 97011300). Used on Type No(s). 0866,0868,0873,0877, 1166,1170,1332,1366, 1368,1370,1371,1544, 1559,1569,1977.</p>			<p>691455 Crankshaft (Used After Code Date 97011200). Used on Type No(s). 1149,1548,1701,1925, 2312,2313,2314,2315, 2316,2324,2328,2352, 2360,2370,2373,2381, 2383,2384,2394,2395, 2396,3172,3173,3180, 3318,3319.</p> <p>691375 Crankshaft (Used Before Code Date 97011300). Used on Type No(s). 1149,1548.</p> <p>692822 Crankshaft Used on Type No(s). 1766.</p> <p>691482 Crankshaft Used on Type No(s). 1961,2329,2334, 3183</p> <p>694079 Crankshaft Used on Type No(s). 1717,1767,1768,1775.</p> <p>692717 Crankshaft Used on Type No(s). 1955,1986,3178.</p> <p>694478 Crankshaft Used on Type No(s). 1777.</p> <p>694849 Crankshaft Used on Type No(s). 1714,1726,2013,2044, 2349,2383,2391,2635, 2683.</p> <p>694850 Crankshaft Used on Type No(s). 1836,2331,2333,2681.</p> <p>696009 Crankshaft Used on Type No(s). 1720,1776,1778,1840, 1841,2032,2036,2039, 2040.</p> <p>696290 Crankshaft Used on Type No(s). 2320.</p> <p>691454 Crankshaft Used on Type No(s). 1706,2151.</p> <p>791061 Crankshaft Used on Type No(s). 2037,2038.</p>

★ Included in Engine Gasket Set-Ref. No.358.

● Included in Carburetor Overhaul Kit-Ref. No. 121.

◆ Included in Carburetor Gasket Set-Ref. No. 977.

⊘ Included in Valve Gasket Set-Ref. No 1095.

Illustrations cover a range of engines. Parts shown without corresponding text may not be used on your specific engine.

0990-9

Assemblies include all parts shown in frames.

07/01/2008

12H800

REF. NO.	PART NO.	DESCRIPTION	REF. NO.	PART NO.	DESCRIPTION	REF. NO.	PART NO.	DESCRIPTION
20	★399781S	Seal–Oil (PTO Side)	25	795429	Piston Assembly (Standard) (Used After Code Date 07090300).	26	795431	Ring Set (Standard) (Used After Code Date 07090300).
20A	★691952	Seal–Oil (PTO Side) (Auxilliary PTO)			----- Note -----			----- Note -----
22	691092	Screw (Crankcase Cover/ Sump)		791097	Piston Assembly (Standard) (Used After Code Date 04031400 and Before Code Date 07090400).		791098	Ring Set (Standard) (Used After Code Date 04031400 and Before Code Date 07090400).
23A	691987	Flywheel ----- Note ----- 691992 Flywheel Used on Type No(s). 0667, 0878, 1149, 1167, 1369, 1548, 1559, 1569, 1701, 1714, 1715, 1726, 1729, 1750, 1786, 1802, 1807, 1817, 1822, 1824, 1836, 1849, 1919, 1932, 1941, 1942, 1948, 1955, 1961, 1967, 2005, 2009, 2013, 2016, 2037, 2038, 2044, 2320, 2324, 2331, 2333, 2349, 2367, 2383, 2391, 2635, 2669, 2673, 2681, 3133, 3178, 3179, 3183, 3324. 696291 Flywheel Used on Type No(s). 1375, 1376, 1379, 1717, 1718, 1719, 1730, 1731, 1732, 1735, 1754, 1781, 1792, 1795, 1809, 1811, 1959, 1960, 1996, 2001, 2002, 2042, 2043, 2108, 2326, 3181, 3187, 3188.		493262	Piston Assembly (Standard) (Used Before Code Date 97011300).		499425	Ring Set (Standard) (Used After Code Date 97011200 and Before Code Date 04031500).
				795430	Piston Assembly (.020" Oversize) (Used After Code Date 07090300).		493261	Ring Set (Standard) (Used Before Code Date 97011300).
				791326	Piston Assembly (.020" Oversize) (Used After Code Date 04102100 and Before Code Date 07040400).		795432	Ring Set (.020" Oversize) (Used After Code Date 07090300).
				499431	Piston Assembly (.020" Oversize) (Used After Code Date 97011200 and Before Code Date 04102200).		791324	Ring Set (.020" Oversize) (Used After Code Date 04102100 and Before Code Date 07090400).
				493386	Piston Assembly (.020" Oversize) (Used Before Code Date 97011300).		499427	Ring Set (.020" Oversize) (Used After Code Date 97011200 and Before Code Date 04102200).
				493387	Piston Assembly (.030" Oversize) (Used Before Code Date 97011300).		493389	Ring Set (.020" Oversize) (Used Before Code Date 97011300).
24	222698S	Key–Flywheel				27	691866	Lock–Piston Pin (Used After Code Date 97011200).
								----- Note ----- 691588 Lock– Piston Pin (Used Before Code Date 97011300).

★ Included in Engine Gasket Set–Ref. No.358.

● Included in Carburetor Overhaul Kit–Ref. No. 121.

◆ Included in Carburetor Gasket Set–Ref. No. 977.

⊘ Included in Valve Gasket Set–Ref. No 1095.

Illustrations cover a range of engines. Parts shown without corresponding text may not be used on your specific engine.

0990–10

Assemblies include all parts shown in frames.

07/01/2008

REF. NO.	PART NO.	DESCRIPTION	REF. NO.	PART NO.	DESCRIPTION	REF. NO.	PART NO.	DESCRIPTION	
28	499423	Pin-Piston (Standard) (Used After Code Date 97011200). ----- Note ----- 298909 Pin-Piston (Standard) (Used Before Code Date 97011300). 298908 Pin-Piston (.005" Oversize) (Used Before Code Date 97011300).	46	691449	Camshaft (Used After Code Date 96060200). ----- Note ----- 492830 Camshaft (Used Before Code Date 96060300).	81	691740	Lock-Muffler Screw	
29	499424	Rod-Connecting (Standard) (Used After Code Date 97011200). ----- Note ----- 490566 Rod-Connecting (Standard) (Used Before Code Date 97011300).	46A	691460	Camshaft (Clockwise) (Used After Code Date 96060200). Used on Type No(s). 0823, 1923. ----- Note ----- 493740 Camshaft (Clockwise) (Used Before Code Date 96060300). Used on Type No(s). 0823.	83	691778	Shaft-Auxiliary Drive Used on Type No(s). 0679, 0823, 1923, 1947, 1949, 1989. ----- Note ----- 690527 Shaft-Auxiliary Drive Used on Type No(s). 0662, 1315, 1538, 1762, 2312, 2313, 2314, 2315, 2316, 2351, 2352, 2360, 2378, 2385, 2394, 3115, 3173, 3319. 690521 Shaft-Auxiliary Drive Used on Type No(s). 1934, 1982, 2330.	
32	691664	Screw (Connecting Rod)			691459 Camshaft (Counterclockwise) (Used After Code Date 96060200). Used on Type No(s). 0662, 1315, 1367, 1538, 1762, 1934, 1947, 1949, 1982, 1989, 2312, 2313, 2314, 2315, 2316, 2330, 2351, 2352, 2360, 2378, 2385, 2394, 3115, 3173, 3319.	94	493765	Kit-Idle Mixture	
32A	695759	Screw (Connecting Rod) (Used After Code Date 00042200).			50	497465	Manifold-Intake		
33	262651S	Valve-Exhaust			51	★272199S	Gasket-Intake		
34	262652S	Valve-Intake			54	691650	Screw (Intake Manifold)		
35	691270	Spring-Valve (Intake)			55	691421	Housing-Rewind Starter		
36	691270	Spring-Valve (Exhaust)			58	280399S	Rope-Starter (Cut To Required Length)		
37	694086	Guard-Flywheel			60	281434S	Grip-Starter Rope		
40	692194	Retainer-Valve			65	690837	Screw (Rewind Starter)		
43	691997	Slinger-Governor/Oil ----- Note ----- 691486 Slinger-Governor/Oil Used on Type No(s). 1167, 1715, 1961, 2334, 2367, 2673, 3183.			78	691108	Screw (Flywheel Guard)		
45	690548	Tappet-Valve					108A	795935 Valve-Choke (Used After Code Date 08031200). ----- Note ----- 790844 Valve-Choke (Used Before Code Date 08031300).	
							98	398185	Kit-Idle Speed
							98A	493280	Kit-Idle Speed
							101	691623	Pin-Shaft
							104	●691242	Pin-Float Hinge
							108	691182	Valve-Choke
							109	494218	Shaft-Choke
							109A	498593	Shaft-Choke
							109B	795936	Shaft-Choke (Used After Code Date 08031200). ----- Note ----- 790843 Shaft-Choke (Used Before Code Date 08031300).

★ Included in Engine Gasket Set-Ref. No.358.

● Included in Carburetor Overhaul Kit-Ref. No. 121.

◆ Included in Carburetor Gasket Set-Ref. No. 977.

⊘ Included in Valve Gasket Set-Ref. No 1095.

Illustrations cover a range of engines. Parts shown without corresponding text may not be used on your specific engine.

12H800

REF. NO.	PART NO.	DESCRIPTION	REF. NO.	PART NO.	DESCRIPTION	REF. NO.	PART NO.	DESCRIPTION
117	494870	Jet–Main (Standard) ----- Note ----- 497466 Jet–Main (Standard) Used on Type No(s). 1538. 498977 Jet–Main (Standard) Used on Type No(s). 0664,0665,0666,0667, 0671,0672,1149,1167, 1170,1368,1369,1370, 1373,1374,1377,1548.	121	498260	Kit–Carburetor Overhaul	127	●694468	Plug–Welch
117A	498978	Jet–Main (Standard) ----- Note ----- 498981 Jet–Main (Standard) Used on Type No(s). 0678,0679,1726,1746, 1777,1801,1802,1803, 1804,1805,1836,1926, 1942,1955,1986,2331, 2349.	125	498170	Carburetor (Primer System) ----- Note ----- 498254 Carburetor (Primer System) Used on Type No(s). 1538. 790821 Carburetor (Primer System) Used on Type No(s). 0680,1749,1837,1850, 1917,2035.	130	●691203	Valve–Throttle ----- Note ----- 696564 Valve–Throttle (Used With Plastic Throttle Shaft)
117B	697355	Jet–Main (Standard)	125A	499059	Carburetor (Choke System) Used on Type No(s). 1701,1714,1715,1786, 1932,1961,2013,2044, 2324,2329,2333,2334, 2349,2367,2383,2391, 2635,2673,2681,3178, 3183. ----- Note ----- 498965 Carburetor (Choke System) Used on Type No(s). 0664,0665,0666,0667, 0671,0672,1149,1167, 1170,1368,1369,1370, 1373,1374,1377,1548, 1747. 790978 Carburetor (Choke System) Used on Type No(s). 0678,0679,1746,1801, 1802,1803,1804,1805. 792253 Carburetor (Choke System) (Used After Code Date 05091800). Used on Type No(s). 1726,1777,1836,1926, 1942,1955,1986,2331, 2349.	133	●398187	Float–Carburetor
118	497315	Jet–Main (High Altitude) ----- Note ----- 496495 Jet–Main (High Altitude) Used on Type No(s). 1538. 498978 Jet–Main (High Altitude) Used on Type No(s). 0664,0665,0666,0667, 0671,0672,1149,1167, 1170,1368,1369,1370, 1373,1374,1377,1548.			134	●398188	Kit–Needle/Seat	
118A	498975	Jet–Main (High Altitude) ----- Note ----- 494870 Jet–Main (High Altitude) Used on Type No(s). 0678,0679,1726,1746, 1777,1801,1802,1803, 1804,1805,1836,1926, 1942,1955,1986,2331, 2349.	125B	790845	Carburetor (Autochoke System)	137	◆693981	Gasket–Float Bowl
118B	692677	Jet–Main (High Altitude)			146	●690979	Key–Timing	
					159	●691753	Bracket–Air Cleaner Primer	
					163★◆272653	●	Gasket–Air Cleaner	
					187	●791766	Line–Fuel (Cut to Required Length)	
					187A	●791873	Line–Fuel (Molded)	
					187B	●791891	Line–Fuel (Includes Filter) (Used After Code Date 05063000). ----- Note ----- 692042 Line–Fuel (Includes Filter) (Used Before Code Date 05070100).	
					187C	●791875	Line–Fuel (Molded)	
					188	●690877	Screw (Control Bracket)	
					190	●690940	Screw (Fuel Tank)	
					202	●691829	Link–Mechanical Governor	

★ Included in Engine Gasket Set–Ref. No.358.

● Included in Carburetor Overhaul Kit–Ref. No. 121.

◆ Included in Carburetor Gasket Set–Ref. No. 977.

⊗ Included in Valve Gasket Set–Ref. No 1095.

Illustrations cover a range of engines. Parts shown without corresponding text may not be used on your specific engine.

0990–12

Assemblies include all parts shown in frames.

07/01/2008

REF. NO.	PART NO.	DESCRIPTION	REF. NO.	PART NO.	DESCRIPTION	
209	691864	Spring-Governor Used on Type No(s). 2329. ----- Note ----- 690242 Spring-Governor Used on Type No(s). 1932. 690241 Spring-Governor Used on Type No(s). 1961,3183. 790944 Spring-Governor Used on Type No(s). 1701.	209B	691851	Spring-Governor ----- Note ----- 699056 Spring-Governor Used on Type No(s). 0652,0656,0661,0662, 0822,0824,0828,0837, 0838,0839,0877,1148, 1315,1316,1322,1324, 1325,1332,1378,1534, 1540,1544,1547,1569, 1570,1571,1721,1751, 1752,1754,1755,1756, 1761,1762,1764,1770, 1771,1781,1784,1789, 1901,1922,1928,1934, 1937,1938,1947,1949, 1967,1977,1978,1982, 1983,1987,1989,1990, 2009,2312,2314,2316, 2319,2323,2326,2328, 2330,2348,2351,2371, 2372,2378,2381,2384, 2385,2386,2387,2388, 2389,2390,2394,2395, 2396,2632,2634,2641, 2642,2643,2644,2645, 2646,2647,2648,2649, 2670,2671,2672,2675, 2676,2680,2682,2684, 2685,2686,3115,3116, 3122,3124,3127,3128, 3129,3132,3172,3173, 3174,3180,3306,3307, 3308,3309,3312,3318, 3319,3509,6699. 693187 Spring-Governor Used on Type No(s). 2383,2683. 691291 Spring-Governor Used on Type No(s). 1715,1777,1786,1836, 1942,1955,1986,2320, 2324,2331,2349,2391, 3178. 691290 Spring-Governor Used on Type No(s). 1714,1726,2013,2044, 2367,2673,2635,2681.	691292 Spring-Governor Used on Type No(s). 0658,0840,0866,0868, 0873,0878,1150,1166, 1171,1320,1365,1366, 1367,1371,1372,1375, 1376,1379,1520,1559, 1717,1718,1719,1723, 1724,1731,1732,1733, 1734,1736,1737,1738, 1750,1758,1760,1763, 1764,1765,1766,1767, 1768,1775,1778,1782, 1785,1790,1791,1792, 1795,1808,1809,1810, 1816,1817,1826,1827, 1829,1837,1839,1845, 1849,1850,1852,1905, 1906,1907,1910,1911, 1912,1913,1915,1916, 1917,1918,1925,1926, 1936,1940,1943,1959, 1962,1963,1964,1965, 1966,1968,1970,1972, 1974,1975,1976,1985, 1991,1992,1993,1995, 1996,1999,2001,2002, 2003,2004,2005,2008, 2011,2012,2014,2017, 2018,2019,2024,2027, 2028,2029,2033,2034, 2041,2148,2149,2151, 2352,3125,3130,3137, 3165,3168,3179,3170, 3181,3185,3186,3314, 3315,3316,3317,3320, 3322,3323,3324,3325. 691852 Spring-Governor Used on Type No(s). 0670,0680,1706,1720, 1727,1728,1729,1739, 1748,1749,1807,1811, 1814,1818,1820,1821, 1822,1823,1824,1825, 1830,1831,1832,1833, 1835,1840,1841,1844, 1846,1847,1914,1958, 1960,1994,2006,2010, 2015,2016,2021,2023, 2032,2035,2036,2037, 2038,2039,2040,2042, 2043,2108,2379,2380, 3169,3189.
209A	690567	Spring-Governor Used on Type No(s). 1167. ----- Note ----- 690568 Spring-Governor Used on Type No(s). 1149,1548. 691835 Spring-Governor Used on Type No(s). 0664,0665,0666,0667, 1170,1368,1369,1370, 1373. 262663 Spring-Governor Used on Type No(s). 0671,0672. 690569 Spring-Governor Used on Type No(s). 1374,1377,1747. 791157 Spring-Governor Used on Type No(s). 1746,1801,1803,1804, 1805. 791315 Spring-Governor Used on Type No(s). 0678, 0679. 792666 Spring-Governor Used on Type No(s). 1802.				

★ Included in Engine Gasket Set-Ref. No.358.

● Included in Carburetor Overhaul Kit-Ref. No. 121.

◆ Included in Carburetor Gasket Set-Ref. No. 977.

⊘ Included in Valve Gasket Set-Ref. No 1095.

Illustrations cover a range of engines. Parts shown without corresponding text may not be used on your specific engine.

12H800

REF. NO.	PART NO.	DESCRIPTION	REF. NO.	PART NO.	DESCRIPTION	REF. NO.	PART NO.	DESCRIPTION
217	690354	Spring-Choke Return	227	690783	Lever-Governor Control	291	790830	Thermostat
222	790143	Bracket-Control (Remote/Manual Friction)(Primer)	231	691636	Screw (Choke Valve)	300	692038	Muffler (Super Lo Tone)
222A	692021	Bracket-Control (Remote, Choke A Matic, Non Compliance)	236	691826	Link-Lockout	----- Note -----		
		----- Note -----	240	298090S	Filter-Fuel	790828		Muffler
		690839 Bracket-Control (Manual Friction) (Choke A Matic) Used on Type No(s). 1149, 1167, 1548.	259	691223	Bracket-Casing Clamp (Control Wire Casing)			Used on Type No(s). 1706, 1738, 1739, 1748, 1750, 1807, 1808, 1816, 1817, 1823, 1824, 1825, 1826, 1827, 1829, 1831, 1835, 1845, 1846, 1847, 1849, 1851, 1963, 1964, 1965, 2011, 2015, 2016, 2017, 2018, 2021, 2022, 2028, 2034, 2041.
		790982 Bracket-Control Used on Type No(s). 0678, 0679, 1746, 1801, 1803, 1804, 1805.	265	690798	Clamp-Casing			792677 Muffler Used on Type No(s). 1844.
222B	693006	Bracket-Control (Fixed Speed Auto Primer Control)	265A	691024	Clamp-Casing	300A	494343S	Muffler (Square Lo Tone)
222C	692150	Bracket-Control (Variable Speed) (5 Position Manual Choke)	265B	692179	Clamp-Casing	300B	497681	Muffler (Catalyst)
222D	692467	Bracket-Control (Fixed Speed)	267	691044	Screw (Casing Clamp)			
		----- Note -----	268	691025	Casing-Control Wire (Cut to Required Length)			
		791128 Bracket-Control Used on Type No(s). 1379, 1738, 1739, 1781, 1782, 1808, 1809, 1811, 1823, 1825, 1831, 1840, 1841, 1972, 1975, 2015, 2017, 2018, 2019, 2024, 2032, 2036, 2037, 2038, 2039, 2040, 2108, 2151.	269	691026	Wire-Control (Cut to Required Length)			
222E	692982	Bracket-Control (Manual Friction, 5 Position Manual Choke)	270	691027	Nut (Control Wire Casing)			
			271	691028	Lever-Control			
			276 ♦	271716	Washer-Sealing			
			287	690940	Screw (Dipstick Tube)			

★ Included in Engine Gasket Set-Ref. No.358.

● Included in Carburetor Overhaul Kit-Ref. No. 121.

♦ Included in Carburetor Gasket Set-Ref. No. 977.

⊘ Included in Valve Gasket Set-Ref. No 1095.

Illustrations cover a range of engines. Parts shown without corresponding text may not be used on your specific engine.

0990-14

Assemblies include all parts shown in frames.

07/01/2008

REF. NO.	PART NO.	DESCRIPTION	REF. NO.	PART NO.	DESCRIPTION	REF. NO.	PART NO.	DESCRIPTION	
304	493293	Housing-Blower ----- Note ----- 493294 Housing-Blower Used on Type No(s). 0666, 0667, 0868, 0878, 1149, 1150, 1167, 1171, 1369, 1548, 1559, 1569, 1701, 1705, 1714, 1715, 1726, 1729, 1755, 1766, 1777, 1786, 1802, 1822, 1836, 1839, 1919, 1926, 1932, 1941, 1942, 1948, 1955, 1961, 1967, 1988, 2005, 2009, 2013, 2014, 2027, 2037, 2038, 2044, 2150, 2320, 2324, 2329, 2331, 2333, 2334, 2349, 2350, 2367, 2383, 2391, 2635, 2669, 2673, 2681, 3110, 3120, 3123, 3133, 3138, 3140, 3167, 3176, 3178, 3179, 3183, 3184, 3324. 695892 Housing-Blower Used on Type No(s). 1721, 1724, 1746, 1747, 1784, 1790, 1830, 1837, 1841, 1850, 1852, 1901, 1906, 1907, 1910, 1911, 1912, 1913, 1915, 1972, 1975, 1989, 2019, 2029, 2033, 2320, 2360, 2370, 2384, 2385, 2386, 2389, 2390, 2394, 2395, 2641, 2643, 2646, 2649, 2684, 2685, 2686, 3129, 3180, 3182, 3308, 3309, 3318, 3319, 3509.			696298 Housing-Blower Used on Type No(s). 1375, 1376, 1379, 1717, 1718, 1719, 1730, 1731, 1732, 1735, 1754, 1781, 1792, 1809, 1811, 1959, 1960, 1996, 2001, 2108, 2326, 3181, 3187, 3188. 790826 Housing-Blower Used on Type No(s). 1706, 1829, 1831, 1835, 1846, 1965, 2018, 2022, 2028. 790983 Housing-Blower Used on Type No(s). 1738, 1739, 1808, 1823, 1825, 1826, 1964, 2015, 2017. 791291 Housing-Blower Used on Type No(s). 1750, 1807, 1817, 1824, 1849, 1851, 2016, 2034.				695892 Housing-Blower (Used After Code Date 06081300). Used on Type No(s). 0680, 1737, 1749, 1782, 1818, 1820, 1917, 1966, 2012, 2024, 2035, 2148, 2149, 3170, 3185, 3189. 493293 Housing-Blower (Used Before Code Date 06081400). Used on Type No(s). 0680, 1737, 1749, 1818, 1820, 1917, 1966, 2012, 2148, 2149, 3170, 3185, 3189. 790826 Housing-Blower (Used After Code Date 06081300). Used on Type No(s). 1748, 1816, 1827, 1844, 1845, 1963, 2011, 2012, 2041. 790983 Housing-Blower (Used Before Code Date 06081400). Used on Type No(s). 1748, 1816, 1847, 1963, 2011, 2012.

★ Included in Engine Gasket Set-Ref. No.358.

● Included in Carburetor Overhaul Kit-Ref. No. 121.

◆ Included in Carburetor Gasket Set-Ref. No. 977.

⊗ Included in Valve Gasket Set-Ref. No 1095.

Illustrations cover a range of engines. Parts shown without corresponding text may not be used on your specific engine.

0990-15

Assemblies include all parts shown in frames.

07/01/2008

12H800

REF. NO.	PART NO.	DESCRIPTION	REF. NO.	PART NO.	DESCRIPTION	REF. NO.	PART NO.	DESCRIPTION
305	691108	Screw (Blower Housing)	333A	792640	Armature-Magneto (Screw On Spark Plug Boot)	356	692390	Wire-Stop
306	690450	Shield-Cylinder				356A	690650	Wire-Stop
306A	790836	Shield-Cylinder			----- Note -----	356B	693010	Wire-Stop
307	690345	Screw (Cylinder Shield)			793353 Armature-Magneto	356D	496381	Wire-Stop
309	695550	Motor-Starter (Used Before Code Date 07052900).			(Snap In Spark Plug Boot)	356F	494250	Wire-Stop
309A	795092	Motor-Starter (Used After Code Date 07052800).			792631 Armature-Magneto	356H	690791	Wire-Stop
310	692327	Bolt (Starter Motor)			(Screw On Spark Plug Boot)	358	497316	Gasket Set-Engine
332	690662	Nut (Flywheel)			Used on Type No(s). 0680,1706,1739,1748, 1749,1750,1807,1808, 1816,1823,1824,1825, 1829,1831,1835,1837, 1917,1963,1965,2011, 2015,2016,2017,2021, 2028.	359	691077	Washer (Ground Terminal)
333	802574	Armature-Magneto ----- Note ----- 790817 Armature-Magneto Used on Type No(s). 0680,1738,1739,1748, 1749,1750,1807,1808, 1816,1817,1844,1846, 1847,1917,1963,1964, 1965,2011,2021, 2034.			793354 Armature-Magneto (Snap In Spark Plug Boot) Used on Type No(s). 0680,1706,1739,1748, 1749,1750,1807,1808, 1816,1823,1824,1825, 1826,1827,1829,1831, 1835,1837,1844,1845, 1846,1847,1849,1850, 1917,1963,1965,2011, 2015,2016,2017,2021, 2028,2035,2041.	363	19069	Flywheel Puller
			334	691061	Screw (Magneto Armature)	365	691688	Screw (Carburetor)
			337	802592S	Plug-Spark (Resistor) ----- Note ----- 697451 Plug-Spark (EMS)	373	691612	Nut (Ground Terminal)
			346	690661	Screw (Spark Arrestor)	374	691074	Washer (Camshaft)
			347	691396	Switch-Rocker	383	89838S	Wrench-Spark Plug
						404	690272	Washer (Governor Crank)
						425A	690670	Screw (Air Cleaner Cover)
						443A	692523	Screw (Air Cleaner Primer Base)
						445A	491588S	Filter-Air Cleaner Cartridge
						455	791960	Cup-Flywheel
						456	692299	Plate-Pawl Friction
						459	281505S	Plate-Ratchet
						474	691991	Alternator
						497	690664	Screw (Stop Switch Bracket)
						500	691086	Washer (Key Switch)
						505	691251	Nut (Governor Control Lever)
						507	691972	Insulator
						510	795093	Drive-Starter
						513	692358	Clutch-Drive
						520	691084	Terminal-Ground
						523	499621	Dipstick
						524	★692296	Seal-Dipstick Tube
						525	495265	Tube-Dipstick

★ Included in Engine Gasket Set-Ref. No.358.

● Included in Carburetor Overhaul Kit-Ref. No. 121.

◆ Included in Carburetor Gasket Set-Ref. No. 977.

⊘ Included in Valve Gasket Set-Ref. No 1095.

Illustrations cover a range of engines. Parts shown without corresponding text may not be used on your specific engine.

0990-16

Assemblies include all parts shown in frames.

07/01/2008

REF. NO.	PART NO.	DESCRIPTION	REF. NO.	PART NO.	DESCRIPTION	REF. NO.	PART NO.	DESCRIPTION
529	691923	Grommet	613	691340	Screw (Muffler)	664	691087	Nut (Key Switch)
544	690786	Armature–Starter			----- Note -----	668	★493823	Spacer
545	492919	Washer Set (Starter Motor)			790833 Screw (Muffler)	670	692294	Spacer–Fuel Tank
562	92613	Bolt (Governor Control Lever)			Used on Type No(s). 1706, 1738, 1739, 1748, 1750, 1807, 1808, 1816, 1817, 1823, 1824, 1825, 1826, 1827, 1829, 1831, 1835, 1845, 1846, 1847, 1849, 1851, 1963, 1964, 1965, 2011, 2015, 2016, 2017, 2018, 2021, 2022, 2028, 2034, 2041.	676	396548	Deflector–Muffler (Louvered)
564	690664	Screw (Control Cover) ----- Note -----			613A 691653 Screw (Muffler)	676A	393756	Deflector–Muffler (Side Out)
		691132 Screw (Control Cover)			613B 691114 Screw (Muffler)	676B	397931	Deflector–Muffler (Direct Out)
564A	691142	Screw (Control Cover)			615 690340 Retainer–Governor Shaft	676C	493871	Deflector–Muffler (Side Out) (Extended)
564B	698589	Screw (Control Cover)			616 698801 Crank–Governor	677	690661	Screw (Muffler Deflector)
584	697734	Cover–Breather Passage			617★◆270344 Seal–O Ring (Intake Manifold)	684	690345	Screw (Breather Passage Cover)
585	★691879	Gasket–Breather Passage			621 692310 Switch–Stop	689	691855	Spring–Friction
592	690800	Nut (Rewind Starter)			627 692872 Bracket–Stop Switch ----- Note -----	692	690572	Spring–Detent
597	691696	Screw (Pawl Friction Plate)			792565 Bracket–Stop Switch Used on Type No(s). 1701, 1836, 1961.	697	691127	Screw (Drive Cap)
601	791850	Clamp–Hose			633 ◆◆691321 Seal–Choke/Throttle Shaft	715	691147	Screw (Shaft Stop)
601A	691038	Clamp–Hose			633A ◆◆693867 Seal–Choke/Throttle Shaft	718	690959	Pin–Locating
604	691757	Cover–Control			635 66538S Boot–Spark Plug	721	690449	Stop–Shaft
604A	691344	Cover–Control			635A 792597 Boot–Spark Plug (Screw On Style) ----- Note -----	741	795755	Gear–Timing (Plastic) ----- Note -----
604B	790703	Cover–Control			793351 Boot–Spark Plug (Snap On Style)			794388 Gear–Timing (Use Without Woodruff Key) (Used After Code Date 07093000).
604C	792418	Cover–Control			651 691660 Screw (Starter Gear Cover)			790345 Gear–Timing (Use Without Woodruff Key) (Used Before Code Date 07100100).
604D	793770	Cover–Control						691830 Gear–Timing (Uses Woodruff Key)
608	497680	Starter–Rewind						742 93941 Retainer–E Ring
								743 691772 Gear–Drive (Counterclockwise) ----- Note -----
								690516 Gear–Drive (Clockwise) Used on Type No(s). 0823.
								745 691648 Screw (Brake)

★ Included in Engine Gasket Set–Ref. No.358.

● Included in Carburetor Overhaul Kit–Ref. No. 121.

◆ Included in Carburetor Gasket Set–Ref. No. 977.

⊘ Included in Valve Gasket Set–Ref. No 1095.

Illustrations cover a range of engines. Parts shown without corresponding text may not be used on your specific engine.

0990–17

Assemblies include all parts shown in frames.

07/01/2008

12H800

REF. NO.	PART NO.	DESCRIPTION	REF. NO.	PART NO.	DESCRIPTION	REF. NO.	PART NO.	DESCRIPTION
783	691918	Gear-Pinion	847	692047	Dipstick/Tube Assembly	923	691994	Brake
783A	691269	Gear-Pinion				923A	695891	Brake
784	795095	Cover-Starter Gear	851	493880S	Terminal-Spark Plug			----- Note -----
785	692352	Gasket-Starter Cover	851A	692424	Terminal-Spark Plug			695891 Brake
789A	691372	Harness-Wiring (Used Before Code Date 00040700).	853	695268	Adapter-Wire			(Used Before Code Date 08050100).
789B	696547	Harness-Wiring ----- Note ----- 696546 Harness-Wiring Used on Type No(s). 2333, 3138, 3179.	868	697338	Seal-Valve			Used on Type No(s). 0680, 1700, 1706, 1721, 1724, 1737, 1746, 1747, 1748, 1749, 1753, 1782, 1816, 1818, 1820, 1827, 1829, 1830, 1831, 1835, 1837, 1841, 1844, 1845, 1846, 1850, 1852, 1906, 1907, 1908, 1910, 1911, 1912, 1913, 1915, 1917, 1930, 1963, 1965, 1966, 1972, 1975, 2011, 2012, 2018, 2019, 2021, 2022, 2024, 2028, 2029, 2033, 2035, 2041, 2148, 2149, 2308, 2639, 3170, 3185, 3189, 3509.
801	690782	Cap-Drive	870	690380	Seat-Valve (Intake)			
802	695267	Cap-End (Used After Code Date 00040600). ----- Note ----- 695975 Cap-End (Used Before Code Date 00040700).	871	262001	Seat-Valve (Exhaust)			
803	695266	Housing-Starter (Used After Code Date 00040600). ----- Note ----- 695975 Housing-Starter (Used Before Code Date 00040700).						
832	499034	Guard-Muffler						
832A	691424	Guard-Muffler						
832B	497683	Guard-Muffler						
832E	793568	Guard-Muffler						
836	690664	Screw (Muffler Guard)						
836A	690661	Screw (Muffler Guard)						
836B	691147	Screw (Muffler Guard)						
836C	790745	Screw (Muffler Guard)						
842	★691031	Seal-O Ring (Dipstick Tube)						
843	691884	Sleeve-Lever (Speed Control)						
843A	691895	Sleeve-Lever (Choke)						
			883	★Ø691881	Gasket-Exhaust			
			892	690646	Switch-Key			
			910	691094	Stud (Alternator)			
			921	497233	Cover-Blower Housing			
			921A	695886	Cover-Blower Housing			
			921B	692931	Cover-Blower Housing Used on Type No(s). 2012, 2320, 2331, 2626, 2391, 2396. ----- Note ----- 692932 Cover-Blower Housing Used on Type No(s). 2333, 2334.			
			921C	695889	Cover-Blower Housing			
			921E	696262	Cover-Blower Housing			
			921F	697343	Cover-Blower Housing			
			921G	790701	Cover-Blower Housing			
			921H	790037	Cover-Blower Housing			
			921J	790036	Cover-Blower Housing			
			921K	699984	Cover-Blower Housing			
			921N	792675	Cover-Blower Housing			
			921P	792687	Cover-Blower Housing			
			921R	793771	Cover-Blower Housing			
			921U	794355	Cover-Blower Housing			
			922	691831	Spring-Brake			
			922A	692135	Spring-Brake			
						923B	796136	Brake (Used After Code Date 08043000). Used on Type No(s). 0680, 1700, 1706, 1721, 1724, 1737, 1746, 1747, 1748, 1749, 1753, 1782, 1816, 1818, 1820, 1827, 1829, 1830, 1831, 1835, 1837, 1841, 1844, 1845, 1846, 1850, 1852, 1906, 1907, 1908, 1910, 1911, 1912, 1913, 1915, 1917, 1930, 1963, 1965, 1966, 1972, 1975, 2011, 2012, 2018, 2019, 2021, 2022, 2024, 2028, 2029, 2033, 2035, 2041, 2148, 2149, 2308, 2639, 3170, 3185, 3189, 3509.

★ Included in Engine Gasket Set-Ref. No.358.

● Included in Carburetor Overhaul Kit-Ref. No. 121.

◆ Included in Carburetor Gasket Set-Ref. No. 977.

Ø Included in Valve Gasket Set-Ref. No 1095.

Illustrations cover a range of engines. Parts shown without corresponding text may not be used on your specific engine.

0990-18

Assemblies include all parts shown in frames.

07/01/2008

REF. NO.	PART NO.	DESCRIPTION	REF. NO.	PART NO.	DESCRIPTION	REF. NO.	PART NO.	DESCRIPTION
925	795403	Cover-Linkage (Used After Code Date 07072200). ----- Note ----- 690595 Cover-Linkage (Used Before Code Date 07072300).	972	699392	Tank-Fuel (Plastic)	1095	498528	Gasket Set-Valve
			972B	699374	Tank-Fuel (Plastic) ----- Note ----- 699387 Tank-Fuel (Plastic) Used on Type No(s). 1375, 1376, 1379, 1717, 1718, 1719, 1730, 1731, 1732, 1735, 1754, 1781, 1792, 1795, 1959, 1960, 1996, 2001, 2002, 2042, 2043, 2108, 2326, 3181, 3187, 3188.	1102	691266	Pilot-Guide Used on Type No(s). 1167, 1715, 2367, 2673. ----- Note ----- 691255 Pilot-Guide Used on Type No(s). 1955, 1961, 2681, 3183.
930	691919	Guard-Rewind (Round)				1119	691648	Screw (Alternator)
930A	691345	Guard-Rewind (Teardrop)				1160	690345	Screw (Interlock Switch)
935	499421	Switch-Interlock				1210	498144	Pulley/Spring Assembly (Pulley)
937	691325	Spline-Starter				1211	498144	Pulley/Spring Assembly (Spring)
940	690664	Screw (Casing Clamp Bracket)				1236	695959	Starter-Mechanical (Touch N Mow) (Do Not Service Individual Parts, Only As A Whole) ----- Note ----- 699914 Starter-Me- chanical (Touch N Mow) (Do Not Service Individual Parts, Only As A Whole) Used on Type No(s). 2001.
946	691738	Stop-Rope	975	493640	Bowl-Float			
957	397974S	Cap-Fuel Tank (Plastic) ----- Note ----- 692662 Cap-Fuel Tank (Plastic) Used on Type No(s). 2384, 3312, 3318, 3319.	976	694395	Primer-Carburetor			
			977	498261	Gasket Set-Carburetor			
			986	693514	Filter-Debris Foam			
			990	691959	Key Set			
			990A	695951	Key Set (Touch N Mow)			
957A	692046	Cap-Fuel Tank (Plastic)	994	398067	Arrestor-Spark			
957B	699985	Cap-Fuel Tank (Plastic)	1005	691346	Fan-Flywheel			
958	698183	Valve-Fuel Shut Off (Plastic)	1009	696255	Screw (Starter Motor)			
966A	496116	Base-Air Cleaner Primer	1019	494256	Kit-Label ----- Note ----- 790231 Kit-Label (Touch N Mow)			
966B	792040	Base-Air Cleaner Primer	1036		Label-Emissions (Available From A Briggs & Statton Authorized Dealer)	1319	794467	Label-Warning
967A	493537S	Filter-Pre Cleaner	1058	277039	Operator's Manual	1330	270962	Manual-Repair
968B	692298	Cover-Air Cleaner			----- Note ----- 277101 Operator's Manual (Touch N Mow)	1386	790848	Vane-Air (Autochoke System)
969	690700	Screw (Blower Housing Cover)			----- Note ----- 277101 Operator's Manual (Touch N Mow)	1387	790849	Spring-Air Vane
969A	691138	Screw (Blower Housing Cover)	1059	692311	Kit-Screw/Washer ----- Note ----- 696293 Kit-Screw/ Washer (Touch N Mow)	1388	790850	Screw (Air Vane) (Autochoke System)
970	691669	Screw (Air Cleaner Primer Bracket)						

★ Included in Engine Gasket Set-Ref. No.358.

● Included in Carburetor Overhaul Kit-Ref. No. 121.

◆ Included in Carburetor Gasket Set-Ref. No. 977.

⊘ Included in Valve Gasket Set-Ref. No 1095.

Illustrations cover a range of engines. Parts shown without corresponding text may not be used on your specific engine.

0990-19

Assemblies include all parts shown in frames.

07/01/2008

Free Manuals Download Website

<http://myh66.com>

<http://usermanuals.us>

<http://www.somanuals.com>

<http://www.4manuals.cc>

<http://www.manual-lib.com>

<http://www.404manual.com>

<http://www.luxmanual.com>

<http://aubethermostatmanual.com>

Golf course search by state

<http://golfingnear.com>

Email search by domain

<http://emailbydomain.com>

Auto manuals search

<http://auto.somanuals.com>

TV manuals search

<http://tv.somanuals.com>