

# MAX SERIES

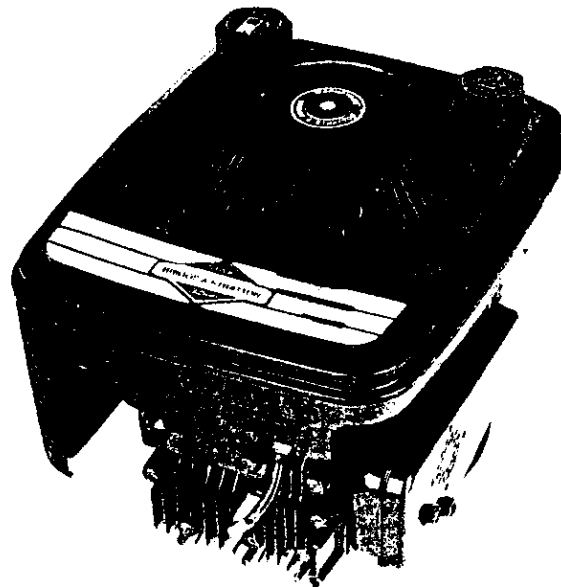

*Operating and Maintenance  
Instructions for Max Model Series  
90700, 91700, 110700, 111700, 112700, 114700*

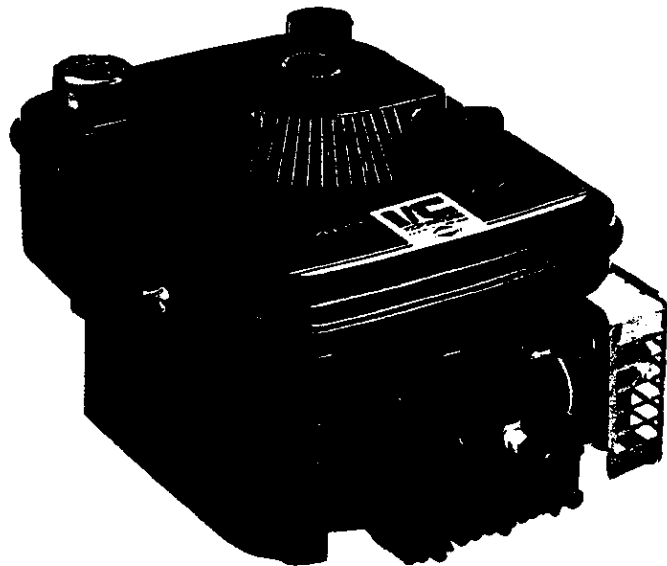

**Briggs & Stratton Corporation**  
Milwaukee, Wisconsin 53201

© Copyright 1988 by Briggs & Stratton Corporation

FORM NO. 271745-11/89  
PRINTED IN U.S.A.

# IMPORTANT SAFETY INFORMATION AND INSTRUCTIONS FOR ENGINE SELECTION ENGINE INSTALLATION ENGINE OPERATION

In the USA and Canada,  
our 24 hour hotline is:

18002333723

Briggs & Stratton Corporation  
Milwaukee, Wisconsin 53201

[www.briggsandstratton.com](http://www.briggsandstratton.com)

Keep these instructions for future reference.



**Before installing and operating this engine read and observe all warnings, cautions and instructions on both sides of this sheet, on the engine, and in the operating & maintenance instructions.**

**NOTE:** This sheet of instructions and safety information is not meant to cover all possible conditions and situations that may occur. Read entire Operating & Maintenance Instructions for this engine AND the instructions for the equipment this engine powers. Failure to follow instructions and safety information could result in serious injury or death.

The safety alert symbol () is used to identify safety information about hazards that can result in personal injury.

A signal word (DANGER, WARNING, or CAUTION) is used with the alert symbol to indicate the likelihood and the potential severity of injury. In addition, a hazard symbol may be used to represent the type of hazard.

 **DANGER** indicates a hazard which, if not avoided, will result in death or serious injury.

 **WARNING** indicates a hazard which, if not avoided, could result in death or serious injury.

 **CAUTION** indicates a hazard which, if not avoided, might result in minor or moderate injury.

**CAUTION**, when used **without** the alert symbol, indicates a situation that **could result in damage to the engine.**

## HAZARD SYMBOLS AND MEANINGS



Fire



Explosion



Moving Parts



Toxic Fumes



Hot Surface



Shock



Kickback

(OVER)

FORM MS-6445-01/03

# ENGINE SELECTION

 <b>WARNING</b>



<b>Failure to select the correct engine could result in fire or explosion.</b>

- Some engines are unique and designed for specific applications or types of equipment. If this engine will be used to build new equipment, contact Briggs & Stratton to ensure that the engine is appropriate for the intended use.  
**Note: For all Go-karts use only a model 136200 series engine, which offers improved safety and performance.**
- Replacement engines should be the same model as the original engine, or be the Briggs & Stratton designated replacement engine. Refer to the Operation & Maintenance Instructions for engine identification information.  
**Note: For all Go-karts use only a model 136200 series engine, which offers improved safety and performance.**
- Do not use Briggs & Stratton engines on 3-wheel All-Terrain Vehicles (ATVs), motor bikes, air craft products, or vehicles intended for use in competitive events. Briggs & Stratton does not approve of or authorize such uses.

# ENGINE INSTALLATION



- [1] Do not attempt to install this engine if you do not have the appropriate tools and knowledge of small engine installation procedures. Use only Briggs & Stratton parts. Contact your Authorized Service Dealer for assistance.
- [2] Do not modify the engine in any way without Briggs & Stratton factory approval. Any such modification is at the owner's sole risk.
- [3] If the exhaust system on the old engine was supplied by the equipment manufacturer, you must transfer the exhaust system and related components (original muffler and related pipes, brackets, clamps, and shields) to the new engine. All components must be in good condition.
- [4] 



 <b>WARNING</b>	Install muffler (and muffler deflector if used) so outlet points away from operator, fuel tank, and equipment, and so muffler heat will not damage or deform engine and components.
	
- [5] 



 <b>WARNING</b>	Ensure all fuel lines and fittings are properly assembled and do not leak. Replacement parts must be the same model as the original.
	
- [6] 



 <b>WARNING</b>	Ensure all wiring, including safety switches and engine shut-off components are completely installed and functioning properly.
	
- [7] Set engine speed to equipment manufacturer's specification. Refer to equipment manufacturer's manual. Do not tamper with governor springs, or other parts that will increase engine speed above specification.

- [8] 







 <b>WARNING</b>	All engine parts, including fuel cap, spark plug, muffler, air cleaner, and covers and guards for drive components (gears, belts, shafts, couplings, etc.) must be in place before attempting to start engine.
	
- [9] 

 <b>WARNING</b>	If engine is installed on walk behind lawn mower, all mower components, including cutting blade, must be correctly installed before attempting to start engine.
	
- [10] 

 <b>WARNING</b>	When working on the engine or equipment, remove spark plug wire from spark plug. For electric start, remove negative wire from battery.
	
- [11] 

 <b>WARNING</b>	Do not check for spark with spark plug removed. Use Briggs & Stratton spark tester #19368.
	

# ENGINE OPERATION

	 <b>WARNING</b>
	<b>When adding fuel:</b>
<p>Turn engine off and let engine cool at least 2 minutes before removing gas cap.</p> <p>Fill fuel tank outdoors or in well-ventilated area. Fill tank to about 1 inch below lowest portion of neck to allow for fuel expansion.</p> <p>Keep gasoline away from sparks, open flames, pilot lights, heat, and other ignition sources.</p>	
	 <b>WARNING</b>
	<b>When starting engine:</b>
<p>Remove all external equipment/engine loads.</p> <p>Wait until spilled fuel is evaporated. Start engine outdoors.</p> <p>Pull cord slowly until resistance is felt, then pull rapidly.</p> <p>If engine floods, set choke to OPEN/RUN, place throttle in FAST and crank until engine starts.</p>	
	 <b>WARNING</b>
	<b>When operating equipment:</b>
<p>Do not tip engine or equipment at angle which causes gasoline to spill.</p> <p>Run engine outdoors. Do not run in enclosed area, even if doors or windows are open.</p> <p>Do not choke carburetor to stop engine.</p>	

# In The Interest Of Safety



THIS SYMBOL MEANS **WARNING** or **CAUTION**. PERSONAL INJURY AND/OR PROPERTY DAMAGE MAY OCCUR UNLESS INSTRUCTIONS ARE FOLLOWED CAREFULLY.



## WARNING

1. DO NOT run engine in an enclosed area. Exhaust gases contain carbon monoxide, an odorless and deadly poison.
2. DO NOT check for spark with spark plug or spark plug wire removed. Use an approved tester.
3. DO NOT crank engine with spark plug removed. If engine is flooded, place throttle in "FAST" position and crank until engine starts.
4. DO NOT smoke when filling fuel tank.
5. DO NOT fill fuel tank while engine is running. Allow engine to cool for two minutes before refueling.
6. DO NOT operate engine when an odor of gasoline is present or other explosive conditions exist.
7. DO NOT operate engine if gasoline is spilled. Move machine away from the spill and avoid creating any ignition until the gasoline has evaporated.
8. DO NOT STORE, SPILL, OR USE GASOLINE NEAR AN OPEN FLAME, or devices such as a stove, furnace, or water heater which utilize a pilot light or devices which can create a spark.
9. DO NOT refuel indoors where area is not well ventilated. Outdoor refueling is preferred.
10. DO NOT OPERATE ENGINE WITHOUT A MUFFLER. Inspect periodically and replace if necessary.

11. DO NOT operate engine with an accumulation of grass, leaves, dirt or other combustible material in the muffler area.
12. DO NOT use this engine on any forest covered, brush covered, or grass covered unimproved land unless a spark arrester is installed on the muffler.
13. DO NOT run engine with air cleaner or air cleaner cover removed.



## CAUTION

1. DO NOT RUN ENGINE AT EXCESSIVE SPEEDS, AS THIS MAY RESULT IN INJURY.
2. DO NOT tamper with governor springs, governor links or other parts which may increase the governed engine speed.
3. DO NOT tamper with the engine speed selected by the original equipment manufacturer.
4. DO NOT touch hot mufflers, cylinders, or fins as contact may cause burns.
5. DO NOT place hands or feet near moving or rotating parts.
6. DO keep cylinder fins and governor parts free of grass and other debris as this can affect engine speed.
7. DO pull starter cord slowly until resistance is felt. Then pull cord rapidly to avoid kickback and prevent hand or arm injury.
8. TO PREVENT ACCIDENTAL STARTING when servicing the engine or equipment, always remove the spark plug or wire from the spark plug. Disconnect negative wire from battery terminal if equipped with a 12 volt starting system.
9. DO use fresh gasoline. Stale fuel can cause leakage.

## WHEN WORKING ON EQUIPMENT

DO NOT STRIKE FLYWHEEL with a hard object or metal tool as this may cause flywheel to shatter in operation, causing personal injury or property damage. To remove flywheel, use Briggs & Stratton approved tools only.

The use of genuine Briggs & Stratton parts preserves the original design of your engine. Imitation replacement parts offer potential risk including the risk of personal injury.

## IN THE INTEREST OF ENVIRONMENT

A muffler which leaks because of rust or damage can permit an increased exhaust noise level. Therefore, examine the muffler periodically to be sure it is functioning effectively. To purchase a new muffler, contact any Briggs & Stratton Authorized Service Center for correct replacement.

**CAUTION: A SPARK ARRESTER MUST BE ADDED** to the muffler of this engine if it is to be used on any forest covered, brush covered, or grass covered unimproved land. The arrester must be maintained in effective working order by the operator. In the State of California the above is required by law (Section 4442 of the California Public Resources Code). Other states may have similar laws. Federal laws apply on federal lands. See your Briggs & Stratton Authorized Service Center or equipment dealer for spark arrester muffler options.

# Before Starting

**READ THE OPERATING INSTRUCTIONS OF THE EQUIPMENT THIS ENGINE POWERS**

**NOTE:** Engine is shipped **WITHOUT** oil.  
**OIL RECOMMENDATIONS**

We recommend the use of a high quality detergent oil classified "For Service SF, SE, SD, SC," such as Briggs & Stratton high quality detergent oil 10W/30 (part no. 272001) or 30 weight (part no. 100005). Detergent oils keep the engine cleaner and retard the formation of gum and varnish deposits. No special additives should be used with recommended oils.

**RECOMMENDED SAE VISCOSITY GRADES**

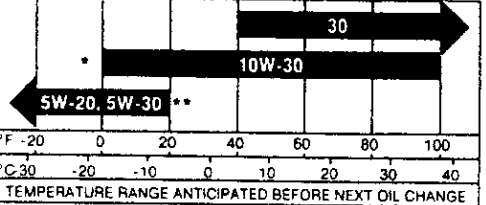

\* 10W-40 oil may be used if 10W-30 is not available.  
\*\* If not available, a synthetic oil may be used having 5W-20, 5W-30 or 5W-40 viscosity.

**TO FILL CRANKCASE WITH OIL:**

Place engine level. Clean area around oil fill. Remove oil dipstick. **POUR OIL SLOWLY.** Fill to **FULL** mark on dipstick. **DO NOT OVERFILL.** Capacity is approximately 1.25 pints (0.6 liters).

**TO CHECK OIL LEVEL:**

Remove oil dipstick and wipe oil from dipstick with clean cloth. Screw dipstick firmly into place until cap bottoms on tube. Remove to check oil level. Dipstick assembly must be firmly assembled into tube when engine is operating.

**NOTE:** If overfilled, engine may smoke excessively or appear to be seized. To correct, drain excess oil and remove spark plug to clear oil trapped above piston. See MAINTENANCE instructions.

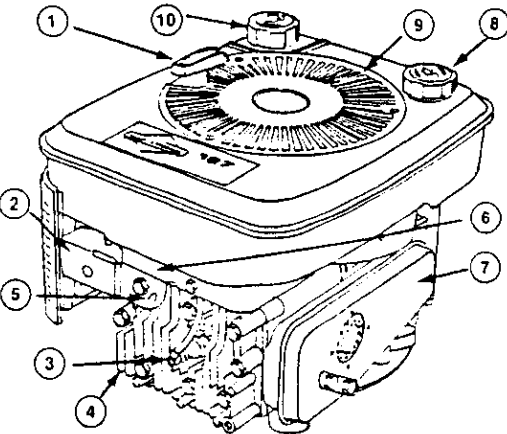
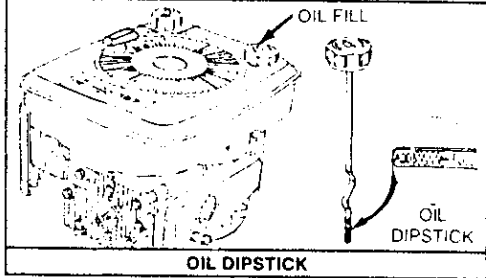

- 1 Vertical Pull Starter Rope
- 2 Carburetor
- 3 Spark Plug
- 4 Cylinder Head
- 5 Holding Tab For Spark Plug Wire
- 6 Model, Type, and Code Number on Blower Housing
- 7 Muffler
- 8 Oil Fill
- 9 Static Guard
- 10 Fuel Fill



**FUEL RECOMMENDATIONS**

This engine will operate satisfactorily on any gasoline intended for automotive use. A minimum of 77 octane is recommended. **DO NOT MIX OIL WITH GASOLINE.**

We recommend the use of clean, fresh, lead-free gasoline and use of Briggs & Stratton Gasoline Additive, part no. 100001. Purchase fuel in quantity that can be used within 30 days. This will assure fuel freshness and volatility tailored to the season. Leaded gasoline may be used if lead-free is not available. Use of lead-free gasoline results in fewer combustion deposits and longer valve life.

**NOTE:** We **DO NOT** recommend the use of gasoline which contains alcohol, such as gasohol. However, if gasoline with alcohol is used, it **MUST NOT** contain more than 10 percent Ethanol and **MUST** be removed from the engine during storage. **DO NOT** use gasoline containing Methanol. See STORAGE INSTRUCTIONS.

**DO NOT FILL** fuel tank to point of overflowing. Allow approximately 1/4 in. (5 mm) of tank space for fuel expansion.

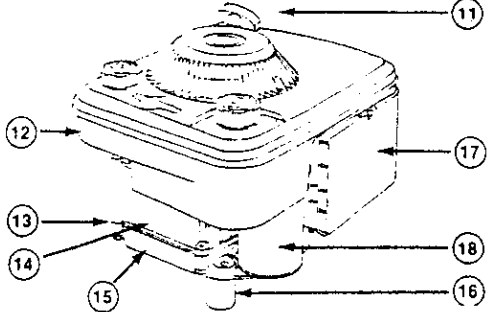

- 11 Rewind Starter Rope
- 12 Fuel Tank
- 13 Oil Level
- 14 Cylinder
- 15 Oil Sump
- 16 Crankshaft
- 17 Air Cleaner
- 18 Electric Starter

# Starting & Stopping

## TIPS TO OBTAIN BEST STARTING PERFORMANCE

1. Start, store and fuel engine in a level position.
2. Start engine with mower on sidewalk or driveway where the cutting blades are out of the grass in an unloaded condition.  
  
If starts must be made on the lawn, move mower over previously cut grass.
3. Keep the underside of the mower deck clean. Periodically remove any built up grass which might add resistance to the cutter blade.
4. DO NOT use a pressurized starting fluid as severe internal engine damage may occur due to loss of lubrication.
5. The best electric starter life is provided by using short starting cycles of several seconds. Prolonged cranking can damage the starter motor if cranked more than 15 seconds per minute.
6. Restart a warm engine with equipment control lever in "FAST" position.
7. To improve cool weather starting (40° F), turn carburetor idle mixture screw 1/8 turn counter-clockwise (richer mixture).

## TO START ENGINE



**WARNING:** ALWAYS KEEP HANDS AND FEET CLEAR OF MOWER BLADE OR OTHER ROTATING MACHINERY.



**OPEN FUEL VALVE:** Turn counter-clockwise approximately 1/4 turn.

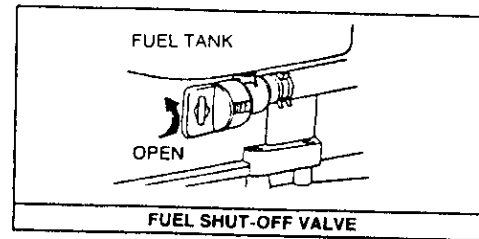

**SET EQUIPMENT CONTROL LEVER:**

Move equipment control lever to "CHOKE" position.

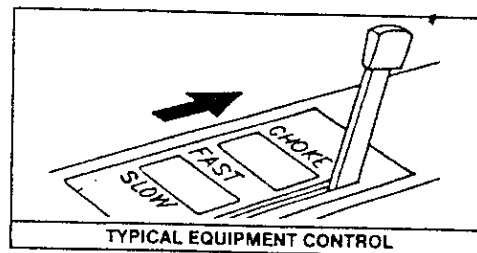

## CHOKE-A-MATIC® CARBURETOR CONTROL

The Choke-A-Matic® carburetor permits choking, varying the engine speed, and stopping the engine by moving a single control lever.

**NOTE:** Choke must fully close on carburetor. If it does not, remote control must be readjusted. See ADJUSTMENT section.

**NOTE:** A warm engine requires little or no choking.

## SAFETY CONTROL HANDLE

**NOTE:** If equipment has a safety control handle, the handle **MUST** be actuated for engine to start and continue running.

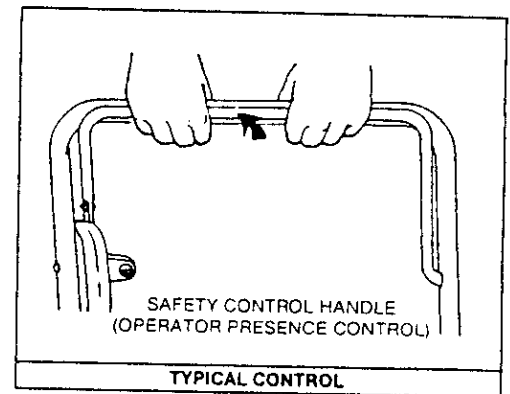

# Starting & Stopping

## STARTER MODELS

### Manual Start (Safety Control and Rewind)

**!** Actuate safety control handle and hold. Grasp starter grip as illustrated and pull slowly until resistance is felt. Then pull cord rapidly to prevent kickback and start engine. Repeat if necessary with equipment control lever in "FAST" position. When engine starts, move equipment control to desired speed.

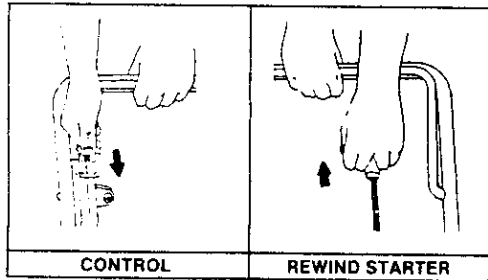

### Manual Start (Rewind/Vertical Pull).

**!** Grasp starter grip as illustrated and pull slowly until resistance is felt. Then pull cord rapidly to prevent kickback and start engine. Repeat if necessary with speed control lever in "FAST" position. When engine starts, move speed control to desired speed.

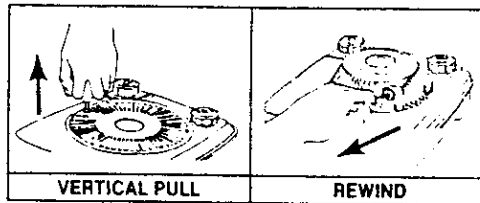

### TO STOP ENGINE (SAFETY CONTROL EQUIPPED):

Move equipment control lever to "SLOW" position. Release safety control handle to engage band brake and stop the engine. Then move speed control lever to "STOP" position or turn key to "OFF" position, if so equipped. Do not choke carburetor to stop the engine. Fire may result if choke is used to stop engine.

**CAUTION:** Always remove key from switch, if so equipped, when leaving mower unattended and/or when mower is not in operation.

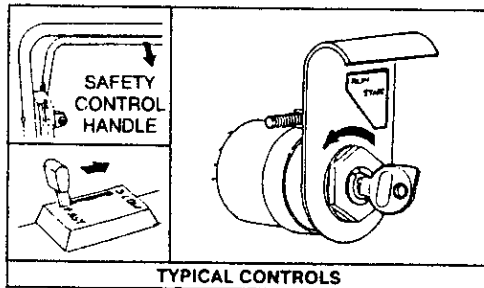

### TO STOP ENGINE

#### (NOT EQUIPPED WITH SAFETY CONTROL):

Move control to "SLOW", then "STOP" position. Do not choke carburetor to stop the engine. Fire may result if choke is used to stop engine.

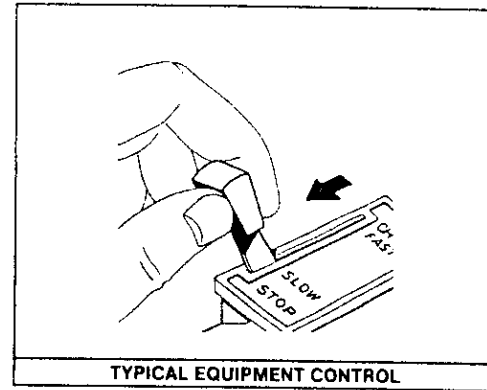

### Electric Start

**!** Actuate safety control handle and hold while turning key to start engine as recommended by equipment manufacturer. Repeat if necessary with speed control in "FAST" position. When engine starts, move speed control to desired speed.

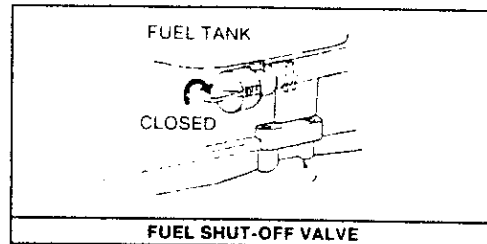
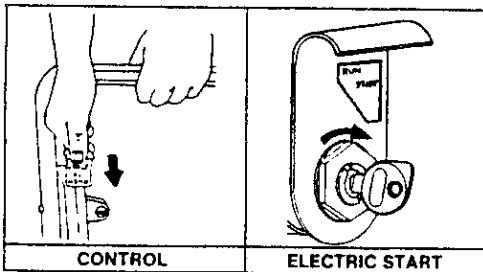

**NOTE:** Close fuel shut-off valve when equipment is not in operation to prevent fuel leakage from the carburetor.

# Adjustments

## CARBURETOR ADJUSTMENTS

Minor carburetor adjustment may be required to compensate for differences in fuel, temperature, altitude or load.

**NOTE:** The air cleaner and air cleaner cover must be assembled to carburetor when running engine.

### INITIAL ADJUSTMENT:

Gently turn idle mixture screw clockwise until it just closes. Screw may be damaged by turning it in too far.

Next open the screw one turn counterclockwise. This initial adjustment will permit the engine to be started and warmed up (approximately 5 minutes) prior to final adjustment.

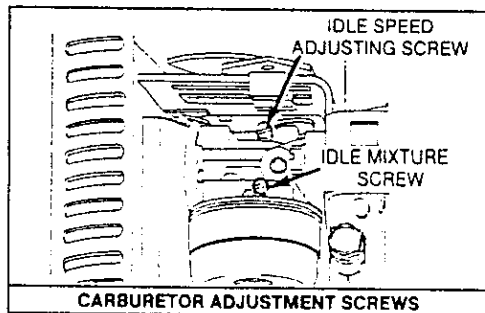

### FINAL ADJUSTMENT:

Place equipment control lever in "IDLE" or "SLOW" position. Then rotate throttle counterclockwise and hold against throttle stop while adjusting idle RPM by turning idle speed adjusting screw to obtain 1750 RPM. Turn idle mixture screw in (clockwise - lean mixture) until engine just starts to slow. Then turn idle mixture screw out (counterclockwise - rich mixture) until engine runs unevenly. Now turn idle mixture screw

midway between rich and lean. Release throttle - engine should accelerate smoothly. If engine does not accelerate properly, the carburetor should be readjusted, usually to a slightly richer mixture, by turning the idle mixture screw counterclockwise 1/8 turn more.

## EQUIPMENT CONTROL ADJUSTMENTS

The equipment control must be properly adjusted to stop, start and operate the engine at maximum speed.



**NOTE:** The acceptable operating speed range is 1800 to 3600 RPM. Idle speed is 1750 RPM. The manufacturer of the equipment on which the engine is installed specifies the Top No Load RPM at which the engine will be operated. **DO NOT EXCEED** this speed.



### TO CHECK OPERATION OF EQUIPMENT CONTROLS:



Remove air cleaner. Move equipment control lever to "CHOKE" position. The carburetor choke should be closed as illustrated below.

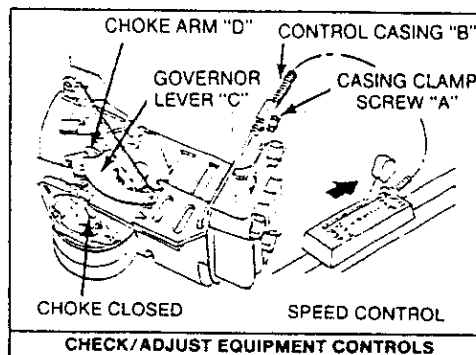

Move the equipment control lever to "STOP." Control lever on carburetor **MUST** make positive contact with stop switch as illustrated below.

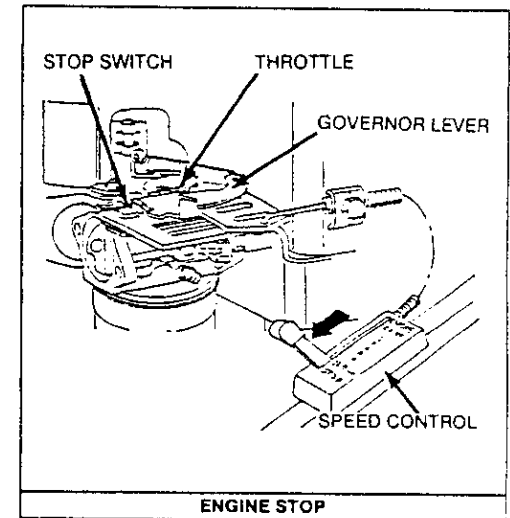

### TO ADJUST EQUIPMENT CONTROLS:

Refer to the illustration to left and move equipment control lever to "FAST" position.

Governor lever "C" on carburetor should be just touching choke arm at "D." To adjust, loosen casing clamp screw "A" on blower housing. Move control casing "B" forward or backward until correct position is obtained. Tighten screw "A."

Recheck operation of controls after adjustment. Replace air cleaner.



# Maintenance

**CAUTION:** TO PREVENT ACCIDENTAL STARTING when servicing the engine or equipment, always remove the spark plug or wire from spark plug and insert wire terminal in holding tab.

## CHECK OIL LEVEL REGULARLY:

Check after each 5 hours of operation. BE SURE OIL LEVEL IS MAINTAINED.

## **CHANGE OIL AS RECOMMENDED:**

Change oil after first 5 hours of operation. Then, under normal operating conditions, change oil monthly or every 50 hours of operation, whichever occurs first. Change oil every 25 hours of operation if the engine is operated under heavy load, or in high ambient temperatures. Change oil while engine is warm. Oil may be drained through oil drain on bottom of engine. To drain completely, always place engine level when draining through the bottom. Oil may also be drained through oil fill as shown.

**CAUTION:** When tipping to service engine or equipment, close fuel shut off valve and keep engine spark plug or muffler side up.

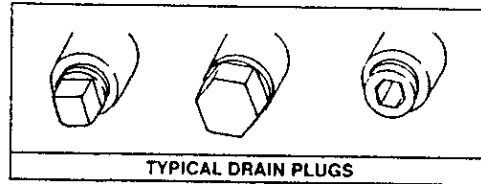
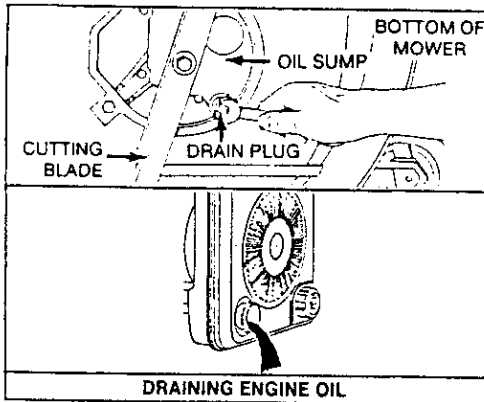

## **SERVICE AIR CLEANER:**

Clean cartridge every 25 hours or weekly, whichever occurs first.

NOTE: Service more often under dusty conditions.

### **CARTRIDGE AIR CLEANER**

1. Loosen screw and tilt cover as illustrated.
2. Carefully remove cartridge (and pre-filter if so equipped).
3. Clean cartridge by tapping gently on flat surface. If very dirty, replace or clean as follows:

Wash in a low or non-sudsing detergent and warm water solution. Rinse thoroughly with flowing water from mesh side until water runs clear. Let cartridge air dry thoroughly before using.



**CAUTION:** Petroleum solvents, such as kerosene, are not to be used to clean cartridge. They may cause deterioration of the cartridge. **DO NOT OIL CARTRIDGE. DO NOT USE PRESSURIZED AIR TO CLEAN OR DRY CARTRIDGE.**

4. Wash pre-filter and allow to air dry thoroughly.
5. Install cartridge and pre-filter, then close cover and fasten screw securely.

NOTE: Be sure to insert tabs on bottom of cover into grooves in back plate.

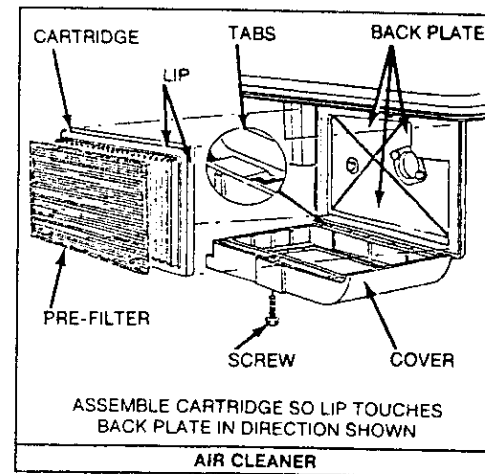

### **REMOVE COMBUSTION DEPOSITS**

Every 100-300 hours of operation. Remove cylinder head and cylinder head shield. Scrape and wire brush the combustion deposits from cylinder, cylinder head, top of piston and around valves. Use a soft brush to remove deposits. Re-assemble gasket, cylinder head and cylinder head shield. Turn screws down finger tight, with the three longer screws around the exhaust valve, if so equipped. Torque cylinder head screws in a staggered sequence to 140 inch pounds (15.82 Nm).

# Maintenance

## CLEAN ENGINE:

Remove dirt and debris with a cloth or brush. Cleaning with a forceful spray of water is not recommended as water could contaminate the fuel system.

## CLEAN STATIC GARD:

Grass or chaff may clog the Static Gard, especially during prolonged operation, when cutting tall grass. Clean the area shown as often as needed to prevent overheating and engine damage.

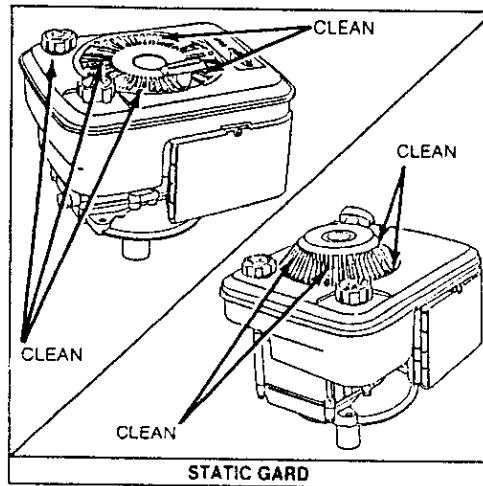

**CAUTION:** To assure smooth operation keep rack and pinion controls free of debris.

**CAUTION:** Periodically clean muffler area to remove all grass, dirt and combustible debris.

## CLEAN COOLING SYSTEM:

Grass, chaff or dirt may clog the engine's air cooling system, especially after prolonged service cutting dry grass. Yearly or after 100 hours of operation (more often if necessary), the internal cooling fins and surfaces may require cleaning to prevent overspeeding, overheating and engine damage. To obtain service, contact any Briggs & Stratton Authorized Service Center.

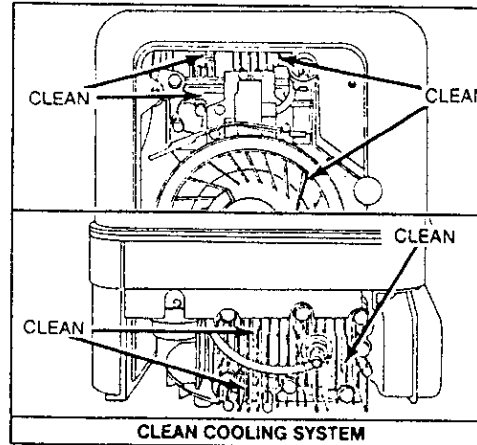

## CLEAN SPARK ARRESTER SCREEN:

If engine muffler is equipped with spark arrester screen assembly, remove monthly or every 50 hours for cleaning and inspection. Replace if damaged. Contact any Briggs & Stratton Authorized Service Center.

## CLEAN DEBRIS GARD (Optional)

Brush grass, chaff and dirt from Debris Gard every 5 hours or daily to prevent overheating and engine damage. Clean more often if necessary.

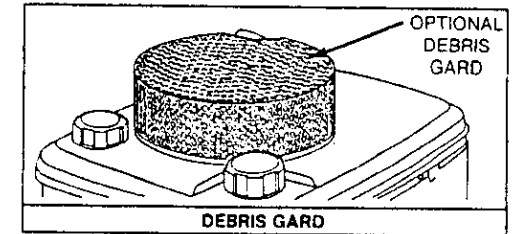

## CLEAN/REPLACE SPARK PLUG:

Clean or replace yearly or every 100 hours of operation, whichever occurs first.

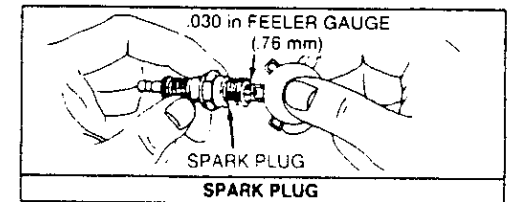

**NOTE:** Do not blast clean spark plug. Spark plug should be cleaned by scraping or wire brushing and washing with a commercial solvent.

**CAUTION:** Sparking can occur if wire terminal does not fit firmly on spark plug. Reform terminal if necessary.

## REPLACE FUEL FILTER:

Replace IN-LINE filter every season. Contact any Briggs & Stratton Authorized Service Center for correct replacement.

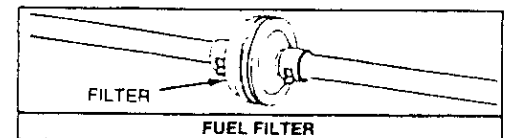

# Maintenance Intervals

Follow the recommended maintenance schedule and make in-between checks. This will help you obtain maximum engine life.

MAINTENANCE OPERATION	Every 5 Hours or Daily	25 Hours or Weekly	50 Hours or Monthly	100 Hours or Yearly	100-300 Hours	Yearly
Check Oil Level	•					
Change Oil †			• Note 1			
Clean Pre-Filter (If Equipped)		• Note 2				
Service Air Cleaner Cartridge		• Note 2				
Clean Cooling System				• Note 2		
Clean Debris Gard (Optional Accessory)	•					
Inspect Spark Arrester (Optional Accessory)			•			
Replace In-Line Fuel Filter						•
Clean or Replace Spark Plug				•		
Clean Combustion Chamber Deposits					•	







† Change oil after first 5 hours.

**Note 1:** Change oil every 25 hours when operating under heavy load.

**Note 2:** Clean more often under dusty conditions or when airborne debris is present.

**BRIGGS & STRATTON AUTHORIZED SERVICE CENTERS ARE READY TO SERVE YOU AND ARE COMMITTED TO QUALITY SERVICE.**

# International Symbols

-  ..... Air Cleaner
-  ..... Caution
-  ..... Choke
-  ..... Fast
-  ..... Fuel
-  ..... Oil
-  ..... Slow

# General Information

This is a single cylinder, L-head, air cooled engine.

On mobile equipment, the engine will operate satisfactorily at any angle at which operator and equipment can function safely.

## MODEL SERIES 90700 and 91700

Bore ..... 2-9/16 in. (65.09 mm)  
 Stroke ..... 1-3/4 in. (44.45 mm)  
 Displacement ..... 9.02 cu. in. (147.8 cc)  
 Horsepower (Net) ..... 3.5 HP @ 3600 RPM  
 Torque (Ft.-Lbs.) ..... 5.26 Max. @ 3100 RPM

## MODEL SERIES 110700, 111700, 112700 and 114700

Bore ..... 2-25/32 in. (70.65 mm)  
 Stroke ..... 1-7/8 in. (47.63 mm)  
 Displacement ..... 11.39 cu. in. (186.7 cc)  
 Horsepower (Net) ..... 4.0 HP @ 3600 RPM  
 Torque (Ft.-Lbs.) ..... 6.12 Max. @ 2600 RPM

The horsepower ratings listed are established in accordance with the Society of Automotive Engineers Test Code J-607. For practical operation, the horsepower loading should not exceed 85% of this rating. Engine power will decrease 3-1/2% for each 1,000 feet (304.8 m) above sea level and 1% for each 10° F above 60° F (16° C).

## TUNE-UP SPECIFICATIONS

Spark Plug Type	Champion	Autolite
Short Plug	CJ-8	235
Long Plug	J-8C	295
Resistor Short Plug	RCJ-8	245
Resistor Long Plug	RJ-8C	306
Spark Plug Gap	.030 in. (.76 mm)	
Intake Valve Clearance*	.004 - .006 in. (.10 - .15 mm)	
Exhaust Valve Clearance*	.007 - .009 in. (.18 - .23 mm)	

\* with valve springs installed.

In some areas, local law requires the use of a resistor spark plug to suppress ignition signals. If an engine was originally equipped with a resistor spark plug, be sure to use the same type of spark plug for replacement.

## STORAGE INSTRUCTIONS

Engines to be stored over 30 days should be completely drained of fuel to prevent gum deposits forming on essential carburetor parts, fuel filter and tank.

**NOTE:** We recommend the use of Briggs & Stratton Gasoline Additive, part no. 100001, or an equivalent, which will minimize the formation of fuel gum deposits during storage. Such an additive may be added to the gasoline in the fuel tank of the engine, or to the gasoline in a storage container.

- All fuel should be removed from the tank. Run the engine until it stops from lack of fuel.
- While engine is still warm, drain oil from crankcase. Refill with fresh oil.
- Remove spark plug and pour approximately 1/2 ounce (15 ml) of engine oil into the cylinder. Replace spark plug and crank slowly to distribute oil.
- Clean dirt and chaff from cylinder, cylinder head fins, blower housing, rotating screen and muffler areas.
- Store in a clean and dry area.

## SERVICE & REPAIR INFORMATION

If service or repair is needed, contact a Briggs & Stratton Authorized Service Center. To serve you promptly and efficiently, the Service Center will need the model, type and code numbers on your engine.

Each Authorized Service Center carries a stock of Original Briggs & Stratton Service Replacement Parts and is equipped with special service tools. Ask for Original Briggs & Stratton Service Replacement Parts. The use of Genuine Parts preserves the original design of your Briggs & Stratton engine. Imitation replacement parts offer potential risks, not just obvious differences such as fit, finish, and warranty back-up, but hidden differences in internal construction as well. Trained mechanics assure expert repair service on all Briggs & Stratton engines.

Major engine repairs should not be attempted unless you have the proper tools and a thorough knowledge of internal combustion engine repair procedure.



Your nearest service center is listed in the "Yellow Pages" under "Engines, Gasoline" or "Gasoline Engines". He is one of over 25,000 authorized dealers available to serve you.

This illustrated book includes "Theories of Operation," common specifications and detailed information covering the adjustment, tune-up and repair procedures for 2 through 16 HP single cylinder, 4 cycle models. It is available from any Briggs & Stratton Authorized Service Center. Order as Part Number 270962.

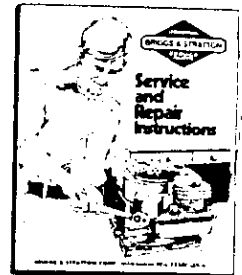

Briggs & Stratton Authorized Service Centers are ready to serve you and are committed to quality service.

## ABOUT THE WARRANTY ON YOUR ENGINE

**NOTE: See Back Cover for Statement of Limited Warranty.**

If warranty service is needed, contact your nearest Authorized Briggs & Stratton Service Center. For prompt attention, your Center will need to know the engine model, type and code numbers, the trouble experienced and the total number of hours the engine was run.

BRIGGS & STRATTON WARRANTY covers only DEFECTIVE MATERIAL and/or WORKMANSHIP.

Briggs & Stratton Corporation welcomes the opportunity to make justified warranty repairs by any of its Authorized Service Centers. In most instances, the requests for warranty repair are handled in a quick and routine manner. However, some requests for warranty are received which appear not justified. In these cases, though engine owners may not be aware of it, the premature failure of their engine was caused by abuse or neglect, or the equipment on which it was mounted, rather than the engine.

If you differ with the decision of your Service Center, investigation will be made to determine the applicability of warranty. Ask the Service Center to submit all supporting facts to the Factory for review. If the Factory decides that your claim is justified, you will be fully reimbursed for those items accepted as defective. To avoid misunderstanding which might occur between engine owners and Authorized Briggs & Stratton Service Centers, we list below some of the causes of engine failure that Briggs & Stratton warranty does not cover for repair or replacement.

**NORMAL WEAR:** Engines, like all mechanical devices, need periodic parts service and replacement to perform well. Warranty will not cover repair when normal use has exhausted the life of a part or an engine.

**IMPROPER MAINTENANCE:** Remember that the service life of an engine depends upon the conditions under which it operates and the care it receives. Some applications, such as tillers, trash pumps and rotary mowers, are very often used in dusty or dirty conditions which can cause what appears to be premature wear. Such wear, when caused by dirt, dust, spark plug cleaning grit or other abrasive material that has entered the engine because of improper maintenance, is not covered by warranty.

**WARRANTY DOES NOT APPLY FOR SOME ADJUSTMENTS OR IF ABUSE OR NEGLIGENCE CAUSES ENGINE DAMAGE: SUCH AS**

1. Bent or broken crankshafts that could be caused by striking a solid object with the cutter blade of a rotary lawn mower;
2. Sticking valves or clogged carburetors, fuel pipes or other damage caused by using contaminated or stale fuel (Use clean, fresh, lead-free gasoline.);

3. Parts which are scored or broken because an engine was operated with insufficient or contaminated lubricating oil or an incorrect grade of lubricating oil. (4 cycle engines: check oil level daily or after every 8 hours of operation. Refill when necessary and change at recommended intervals.) (2 cycle engines: use correct mixture of gasoline and BIA/NMMA certified oil.);
4. Parts damaged by overspeeding or overheating caused by dirt, grass or debris plugging the cooling fins and clogging the flywheel area, or caused by operating the engine in a confined area without sufficient ventilation (Clean fins on the cylinder, cylinder head and flywheel at recommended intervals.);
5. Damage or wear to parts caused by dirt which entered the engine because of improper air cleaner maintenance or re-assembly (Clean and re-oil the foam pre-cleaner and clean or replace the paper cartridge at recommended intervals.);
6. Damage or wear to parts caused by grit which entered the engine from spark plugs cleaned on an abrasive blast cleaning machine;
7. Tune-up or adjustment needed by an engine but not caused by defective material nor workmanship (Follow the "Operating and Maintenance Instructions" when making any minor adjustments.);
8. Parts broken by excessive vibration caused by loose engine mounting, loose cutter blades, unbalanced blades or impellers, improperly attaching equipment to engine crankshaft, overspeeding or abuse in operation;
9. Repair or adjustment of associated parts or assemblies such as clutches, transmissions, remote controls, etc., which are not of Briggs & Stratton manufacture;
10. PARTS THAT ARE NOT ORIGINAL BRIGGS & STRATTON PARTS OR PARTS THAT ARE NOT APPROVED BY BRIGGS & STRATTON.

Warranty is available only through service centers which have been authorized by the Briggs & Stratton Corporation. Your nearest service center is listed in the Yellow Pages of your Telephone Directory, under "Engines, Gasoline" or "Gasoline Engines."

**Superseding Warranty**  
**BRIGGS & STRATTON ENGINE WARRANTY POLICY**  
**effective July 31, 1989**  
**Replaces all undated previous Warranties and all Warranties**  
**dated before July 31, 1989**

When warranty repair is justified, Briggs & Stratton Corporation welcomes such repair by any of its Authorized Service Centers.

In most instances, the requests for warranty brought to the attention of our Service Accounts are handled in a prompt routine manner with no question regarding their validity. However, some requests for warranty are received which appear not justified. In these cases, engine owners may not be aware that the premature failure of their engine was the result of abuse or neglect, or that the difficulty which they experience is caused by the equipment rather than the engine.

BRIGGS & STRATTON WARRANTY covers only DEFECTIVE MATERIAL and/or WORKMANSHIP.

**LIMITED WARRANTY**

"For time period shown below from date of purchase, Briggs & Stratton Corporation will replace for the original purchasers, free of charge, any part, or parts of the engine, found upon examination by any Factory Authorized Service Center, or by the Factory at Milwaukee, Wisconsin, to be defective in material or workmanship or both; this is the exclusive remedy. All transportation charges on parts submitted for replacement under this Warranty must be borne by purchaser. For warranty service contact your nearest Authorized Service Center as listed in the 'Yellow Pages' under 'Engines, Gasoline' or 'Gasoline Engines.' THERE IS NO OTHER EXPRESS WARRANTY. IMPLIED WARRANTIES, INCLUDING THOSE OF MERCHANTABILITY AND FITNESS FOR A PARTICULAR PURPOSE ARE LIMITED TO ONE YEAR FROM PURCHASE AND TO THE EXTENT PERMITTED BY LAW ANY AND ALL IMPLIED WARRANTIES ARE EXCLUDED. LIABILITY FOR CONSEQUENTIAL DAMAGES UNDER ANY AND ALL WARRANTIES ARE EXCLUDED TO THE EXTENT EXCLUSION IS PERMITTED BY LAW. Some states do not allow limitations on how long an implied warranty lasts, and some states do not allow the exclusion or limitation of incidental or consequential damages, so the above limitation and exclusion may not apply to you. This warranty gives you specific legal rights and you may also have other rights which vary from state to state."

Briggs & Stratton Corporation  
 F. P. Stratton, Jr.  
 Chairman and Chief Executive Officer

**WARRANTY PERIOD**

ENGINES	CONSUMER USE*	COMMERCIAL USE*
All 2 thru 18 hp engines installed on equipment other than lawn mowers, edgers, tillers, and all Sno Gard engines.	1 year - engine	1 year - engine
All 2 thru 18 hp engines installed on lawn mowers, edgers, tillers, and all Sno Gard engines.	2 year - engine*** 5 year - Magnetron® ignition***	1 year - engine
All Vanguard and I/C® engines	2 year - engine Lifetime** - Magnetron® ignition	2 year - engine Lifetime** - Magnetron® ignition

\* For purposes of this warranty policy, "consumer use" shall mean personal residential household use by the original retail consumer. "Commercial use" shall mean all other uses, including use for commercial, income producing or rental purposes. Once an engine has experienced commercial use, it shall thereafter be considered as a commercial use engine for purposes of this warranty policy.

\*\* Lifetime limited warranty of the Magnetron® ignition shall cover parts and labor for the first five (5) years from the date of purchase; thereafter only parts. "Lifetime" shall mean lifetime of the engine in the hands of the original purchaser.

\*\*\* Applies to equipment retailed in the U.S.A. and Canada. In all other countries, the warranty for CONSUMER USE is the same as COMMERCIAL USE.

**NO REGISTRATION (WARRANTY) CARD IS NECESSARY TO OBTAIN WARRANTY ON BRIGGS & STRATTON ENGINES. SAVE YOUR PURCHASE RECEIPT. PROOF OF PURCHASE DATE WILL BE REQUIRED TO OBTAIN WARRANTY.**

BRIGGS & STRATTON ENGINES ARE MADE UNDER ONE OR MORE OF THE FOLLOWING PATENTS										DESIGN
2,999,491	3,305,223	3,526,146	3,625,492	3,745,393	3,971,353	4,233,043	3,194,224	3,457,804	3,572,218	D-247,177
3,650,354	3,961,724	4,168,288	4,270,509	3,276,439	3,465,740	3,625,071	3,738,345	3,968,854	4,189,040	OTHER PATENTS PENDING

## Free Manuals Download Website

<http://myh66.com>

<http://usermanuals.us>

<http://www.somanuals.com>

<http://www.4manuals.cc>

<http://www.manual-lib.com>

<http://www.404manual.com>

<http://www.luxmanual.com>

<http://aubethermostatmanual.com>

Golf course search by state

<http://golfingnear.com>

Email search by domain

<http://emailbydomain.com>

Auto manuals search

<http://auto.somanuals.com>

TV manuals search

<http://tv.somanuals.com>