

Briggs & Stratton OPERATING AND MAINTENANCE INSTRUCTIONS

MODELS

142300 to 142497
143300 to 143497

IMPORTANT: Do not start this engine before reading Section I and Section II of this manual.

CAUTION

PROVIDE EFFICIENT VENTILATION. Exhaust gases contain carbon monoxide, an odorless and deadly poison. Do not operate engine in an enclosed area.

DO NOT FILL GASOLINE TANK WHILE ENGINE IS RUNNING. Avoid spilling gasoline on a hot engine - this may cause an explosion and serious injury.

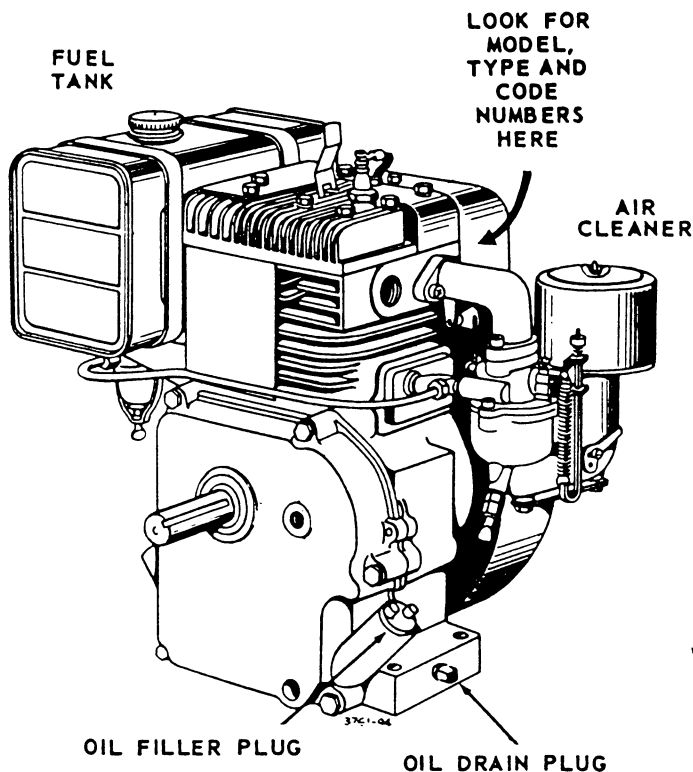

SECTION BEFORE STARTING

FILL CRANKCASE WITH OIL

Remove the oil filler plug. Use a screw driver or bar. Some engines have oil filler cap. Use a wrench to remove.

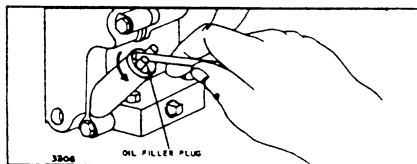

Models equipped with nylon oil filler plugs should be filled to point of overflowing.

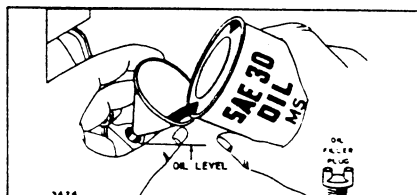

Models equipped with dip sticks should be filled to "F" mark. (Capacity 2-3/4 U.S. pints). Replace filler plug.

FORM NO. 27843-84
PRINTED IN U.S.A.

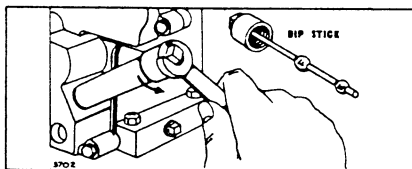

LUBRICATION RECOMMENDATIONS

Any high quality detergent oil bearing the American Petroleum Institute Classification "For Service MS" can be used in your Briggs & Stratton engine. Detergent oils keep the engine cleaner and retard the formation of gum and varnish deposits.

WINTER
(Below 40° F.)
Use SAE 5W-20
If not Available
Use SAE 10W
Above 10° F.

SUMMER
(Above 40° F.)
Use SAE 30
If not Available
Use SAE 10W-30

Nothing should be added to the recommended oils.

BRIGGS & STRATTON CORP.
Milwaukee, Wisconsin 53201

FILL FUEL TANK

Use clean, fresh "regular" grade gasoline.

CAUTION: The use of old or stale gasoline will result in gum deposits clogging the fuel system and carburetor. Make sure that vent hole in the tank cap is open.

DO NOT MIX OIL WITH GASOLINE.

"OIL-FOAM"® AIR CLEANER

"Oil-Foam"® air cleaners are oiled at the factory and do not require initial service.

FILL OIL BATH AIR CLEANER

Oil bath air cleaners used on some models require initial service prior to operating engine. (See Section 3).

Fill oil bath air cleaner with same grade oil as in the crankcase.



IMPORTANT SAFETY INFORMATION AND INSTRUCTIONS FOR ENGINE SELECTION ENGINE INSTALLATION ENGINE OPERATION

In the USA and Canada,
our 24 hour hotline is:

18002333723

Briggs & Stratton Corporation
Milwaukee, Wisconsin 53201

www.briggsandstratton.com

Keep these instructions for future reference.



Before installing and operating this engine read and observe all warnings, cautions and instructions on both sides of this sheet, on the engine, and in the operating & maintenance instructions.

NOTE: This sheet of instructions and safety information is not meant to cover all possible conditions and situations that may occur. Read entire Operating & Maintenance Instructions for this engine AND the instructions for the equipment this engine powers. Failure to follow instructions and safety information could result in serious injury or death.

The safety alert symbol () is used to identify safety information about hazards that can result in personal injury.

A signal word (DANGER, WARNING, or CAUTION) is used with the alert symbol to indicate the likelihood and the potential severity of injury. In addition, a hazard symbol may be used to represent the type of hazard.

 **DANGER** indicates a hazard which, if not avoided, will result in death or serious injury.

 **WARNING** indicates a hazard which, if not avoided, could result in death or serious injury.

 **CAUTION** indicates a hazard which, if not avoided, might result in minor or moderate injury.

CAUTION, when used **without** the alert symbol, indicates a situation that **could result in damage to the engine.**

HAZARD SYMBOLS AND MEANINGS



Fire



Explosion



Moving Parts



Toxic Fumes



Hot Surface



Shock



Kickback

(OVER)

FORM MS-6445-01/03

ENGINE SELECTION

 WARNING

Failure to select the correct engine could result in fire or explosion.

- Some engines are unique and designed for specific applications or types of equipment. If this engine will be used to build new equipment, contact Briggs & Stratton to ensure that the engine is appropriate for the intended use.
Note: For all Go-karts use only a model 136200 series engine, which offers improved safety and performance.
- Replacement engines should be the same model as the original engine, or be the Briggs & Stratton designated replacement engine. Refer to the Operation & Maintenance Instructions for engine identification information.
Note: For all Go-karts use only a model 136200 series engine, which offers improved safety and performance.
- Do not use Briggs & Stratton engines on 3-wheel All-Terrain Vehicles (ATVs), motor bikes, air craft products, or vehicles intended for use in competitive events. Briggs & Stratton does not approve of or authorize such uses.

ENGINE INSTALLATION

- [1] Do not attempt to install this engine if you do not have the appropriate tools and knowledge of small engine installation procedures. Use only Briggs & Stratton parts. Contact your Authorized Service Dealer for assistance.
- [2] Do not modify the engine in any way without Briggs & Stratton factory approval. Any such modification is at the owner's sole risk.
- [3] If the exhaust system on the old engine was supplied by the equipment manufacturer, you must transfer the exhaust system and related components (original muffler and related pipes, brackets, clamps, and shields) to the new engine. All components must be in good condition.
- [4]

 WARNING	Install muffler (and muffler deflector if used) so outlet points away from operator, fuel tank, and equipment, and so muffler heat will not damage or deform engine and components.
	
- [5]

 WARNING	Ensure all fuel lines and fittings are properly assembled and do not leak. Replacement parts must be the same model as the original.
	
- [6]

 WARNING	Ensure all wiring, including safety switches and engine shut-off components are completely installed and functioning properly.
	
- [7] Set engine speed to equipment manufacturer's specification. Refer to equipment manufacturer's manual. Do not tamper with governor springs, or other parts that will increase engine speed above specification.

- [8]







 WARNING	All engine parts, including fuel cap, spark plug, muffler, air cleaner, and covers and guards for drive components (gears, belts, shafts, couplings, etc.) must be in place before attempting to start engine.
	
- [9]

 WARNING	If engine is installed on walk behind lawn mower, all mower components, including cutting blade, must be correctly installed before attempting to start engine.
	
- [10]

 WARNING	When working on the engine or equipment, remove spark plug wire from spark plug. For electric start, remove negative wire from battery.
	
- [11]

 WARNING	Do not check for spark with spark plug removed. Use Briggs & Stratton spark tester #19368.
	

ENGINE OPERATION

	 WARNING
When adding fuel:	
Turn engine off and let engine cool at least 2 minutes before removing gas cap. Fill fuel tank outdoors or in well-ventilated area. Fill tank to about 1 inch below lowest portion of neck to allow for fuel expansion. Keep gasoline away from sparks, open flames, pilot lights, heat, and other ignition sources.	
	 WARNING
When starting engine:	
Remove all external equipment/engine loads. Wait until spilled fuel is evaporated. Start engine outdoors. Pull cord slowly until resistance is felt, then pull rapidly. If engine floods, set choke to OPEN/RUN, place throttle in FAST and crank until engine starts.	
	 WARNING
When operating equipment:	
Do not tip engine or equipment at angle which causes gasoline to spill. Run engine outdoors. Do not run in enclosed area, even if doors or windows are open. Do not choke carburetor to stop engine.	

SECTION II STARTING

TO START ENGINE

1. Be Sure the Stop Switch Is Away From Spark Plug

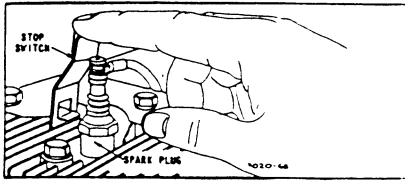

2. Open Fuel Valve

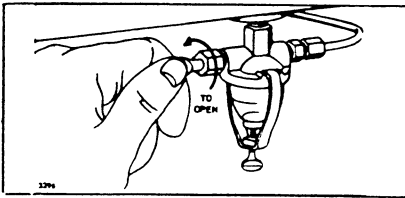

3. Choke the Carburetor

a. Manual Type

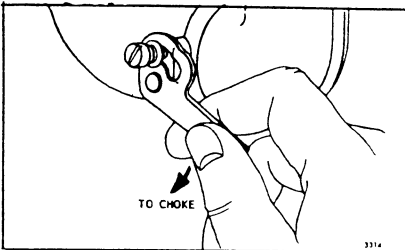

Move lever in direction of arrow to fully closed choke position. Set governor control in normal operating position.

NOTE: A warm engine requires less choking than a cold engine.

b. Choke-A-Matic

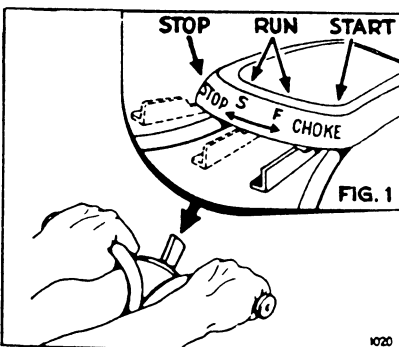

The Choke-A-Matic Carburetor permits choking, varying the engine speed, and stopping the engine by merely moving a single remote control lever to the desired position.

Move lever to "Full Choke" or "Start" position.

NOTE: This should fully close choke on carburetor. If it does not, remote control must be re-adjusted. See "Choke-A-Matic Carburetor" Adjustments, Section IV.

4. Start Engine

a. "Easy-Spin"® Rewind Starter

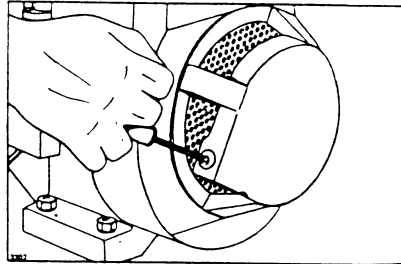

Grasp starter grip as illustrated and pull out cord two to three feet. Repeat if necessary with choke opened slightly. When engine starts open choke gradually.

b. Rope Starter

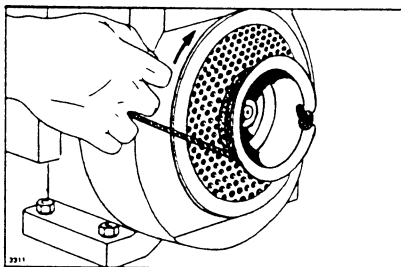

Wind the starter rope around the pulley in direction shown by arrow. Pull the rope with a quick full arm stroke. Repeat if necessary with choke opened slightly. When engine starts open choke gradually.

c. 12 Volt D.C. Electric Starter

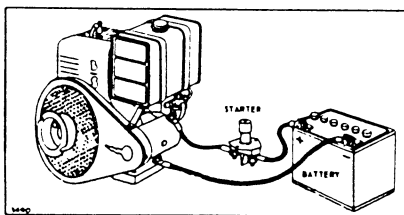

Press starter button on powered equipment. When engine starts open choke gradually.

SPECIAL LOW TEMPERATURE STARTING PROCEDURE

- A. Turn needle valve located on side of carburetor, 1/8 turn

counterclockwise from normal summer adjustment.

- B. Pull choke out. Pull starter rope 1 or more times until engine fires at least once. A "pop" at the muffler indicates the engine is firing.

- C. Push choke in slightly.

- D. Pull starter again - engine should start.

- E. As engine begins to run, push choke in slowly.

- F. If engine begins to die, give more choke.

NOTE: If fuel drips out of carburetor while trying to start engine, the engine is over choked. Pull starter several times with choke open (inward).

SPECIAL WINTER RECOMMENDATIONS

- A. Be sure to use the proper weight of oil for the air temperature expected.

- B. Disconnect all external loads. Any V-belt drives must be removed or loosened so that the belts are standing still for satisfactory operation below freezing. Starter, motor and battery are designed to start the engine only.

- C. Keep battery and engine warm if possible. If it is not possible to keep the entire unit warm, there is a big advantage in keeping the battery warm until it is required for starting. A warm battery has much more starting capacity than a cold battery.

NOTE: The electric starter will crank a completely unloaded engine at temperatures as low as 0° F. with SAE 10W oil. Below 0° F. rock starter pulley back and forth to disengage starter motor clutch and use the rope starter.

STOPPING

a. Manual Choke

Push the stop switch against end of spark plug.

b. Choke-A-Matic

Move control lever to "stop" position.

SECTION III REGULAR MAINTENANCE

SERVICE AIR CLEANER REGULARLY "OIL-FOAM"® TYPE

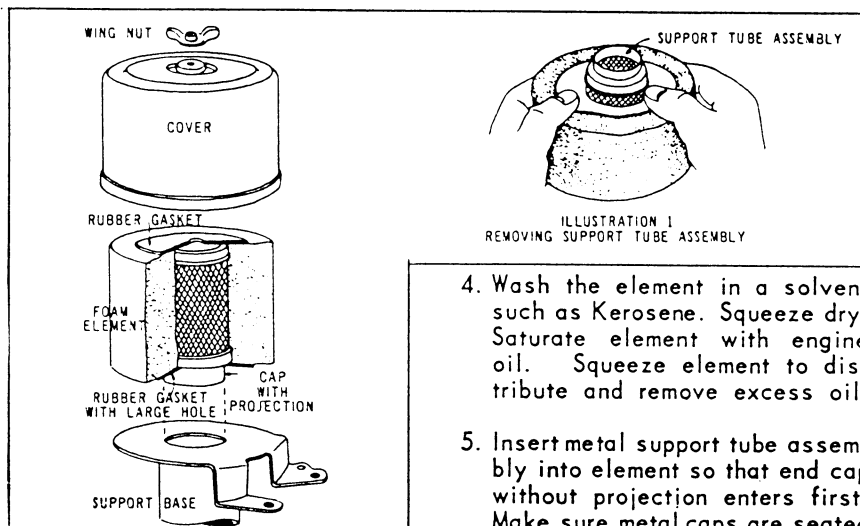

ILLUSTRATION 1
REMOVING SUPPORT TUBE ASSEMBLY

1. Remove wing nut and cover.
2. Lift off foam element from support base.
3. Remove metal support tube assembly (screen and two metal end caps) from foam element by compressing foam element. See Illustration 1.

4. Wash the element in a solvent such as Kerosene. Squeeze dry. Saturate element with engine oil. Squeeze element to distribute and remove excess oil.
5. Insert metal support tube assembly into element so that end cap without projection enters first. Make sure metal caps are seated on screen.

IMPORTANT: When support tube is in place, pull rubber gasket over shoulder of metal end cap. Rubber gasket then forms a protective seal when cover is assembled.

6. Install element and cover. Tighten wing nut securely.

CHECK OIL (GEAR REDUCTION)

Remove drain plug in bottom of gear case cover and drain oil every 100 hours of operation. Replace plug. To refill, remove oil check plug and oil filler plug and pour oil (same grade as used in crankcase) into filler hole until it runs out level check hole. Replace both plugs. **CAUTION:** Oil filler plug has a vent hole and must be installed on top of gear case cover.

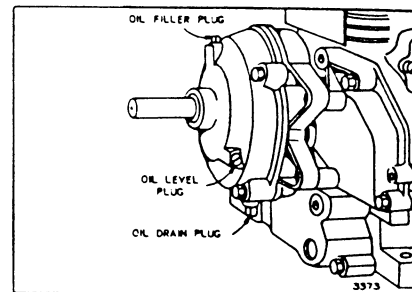

CYLINDER HEAD - COMBUSTION CHAMBER CLEAN-OUT

The use of Automotive fuels in constant speed-constant load industrial engine service often results in the build up of tetraethyl lead deposits in the combustion chamber. This reduces engine power and may prevent the valves from seating properly. Removing the deposits is easy and will pay big dividends in reliability and increased valve life.

Clean Combustion Chamber Every
100-300 Hours of Operation

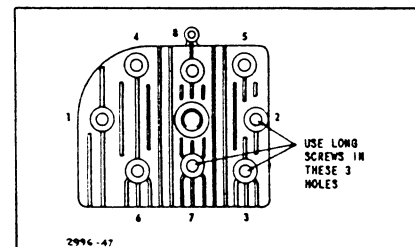

1. Remove cylinder head screws. Be sure to note if screws are of different length and have steel washers as they must be replaced in original position.
2. Turn crankshaft until piston is at top of cylinder and both valves are closed. Scrape and wire brush the lead and carbon deposits from cylinder head, top of piston, and around valves.

Use soft brush or compressed air to remove loose deposits.

OIL BATH TYPE

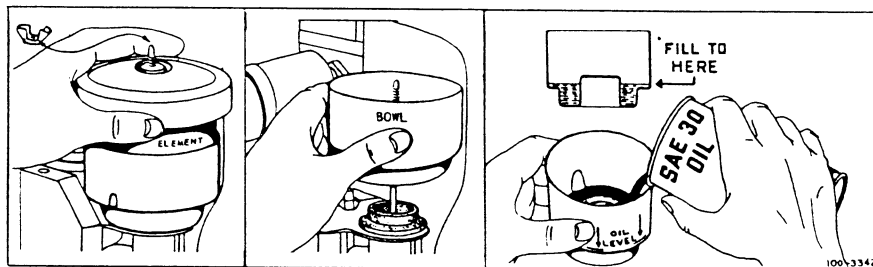

1. Remove wing nut. Lift off filter element. Lift off bowl.
2. Pour out old oil.
3. Wash the filter element and bowl in kerosene or solvent and wipe dry.
4. Pour oil in small bottom part of bowl to "OIL LEVEL" mark shown at end of arrows. Replace bowl on carburetor.
5. Replace filter element and turn wing nut clockwise until snug. Be sure gaskets are in place.

NOTE: Steps 2 and 3 are not required for initial service.

CHANGE OIL (CRANKCASE)

Change oil after first 5 hours of operation. Thereafter change oil every 25 hours of operation. Remove oil drain plug and drain oil while engine is warm. Replace drain plug. Remove oil filler plug or cap and refill with new oil of proper grade. Replace oil filler plug or cap. Check oil level regu-

larly - at least after 5 hours of operation. **BE SURE OIL LEVEL IS MAINTAINED.**

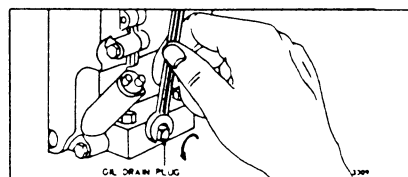

SECTION III REGULAR MAINTENANCE (Cont'd.)

3. Re-use cylinder head gasket only if in good condition. Reassemble cylinder head, gasket, head cover, washers and screws. Tighten screws with wrench until screw heads seat lightly.
4. Use socket wrench with 6" handle and turn all screws 1/4 turn. Tighten screws in sequence illustrated. Run engine approximately 5 minutes and retighten all screws snugly - (approximately 1/4 turn)

CLEAN COOLING SYSTEM

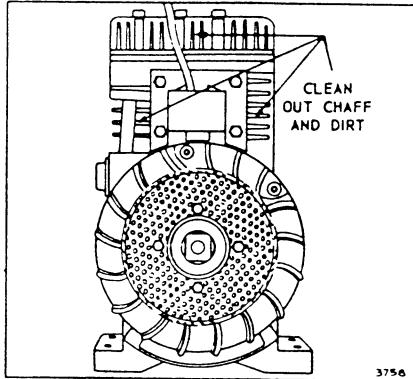

Grass or chaff may clog cooling system after prolonged service in cutting tall dry grasses or hay. Continued operation with a clogged cooling system causes severe overheating and possible engine damage. Remove blower housing and clean regularly.

DRAINING FUEL TANK AND CLEANING FUEL FILTER

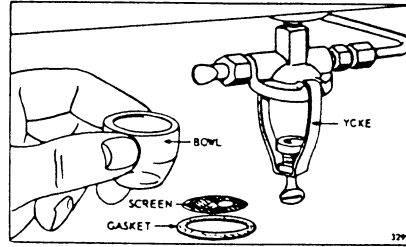

Loosen thumb screw below filter bowl. Remove and clean filter bowl and screen. Open shut-off valve to see if fuel flows freely from the tank. **IMPORTANT:** If you find a gummy, varnish-like substance use alcohol or acetone to dissolve it.

SPARK PLUG

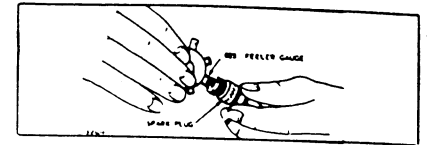

Clean and reset gap at .025" every 100 hours of operation.

CAUTION: Blast cleaning of spark plug in machine using abrasive grit is not recommended.

Spark Plug Type AC-GC-46;
AL-A71; or Champion J-8.

BREAKER POINTS

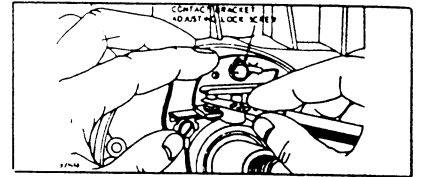

Breaker Point Gap, .020". Access to points requires removal of blower housing and flywheel. **NOTE:** Crank shafts have **RIGHT HAND THREAD.**

Valve Intake .005" - .007"
Clearance - Exhaust .009" - .011"

SECTION IV ADJUSTMENTS

CARBURETOR ADJUSTMENTS

Initial Adjustment

Turn needle valve clockwise until it just closes. **CAUTION:** Valve may be damaged by turning it in too far.

Now open needle valve 1 1/2 turns counterclockwise.

Close idle valve in same manner and open 1/2 to 3/4 turns. This initial adjustment will permit the engine to be started and warmed up prior to final adjustment.

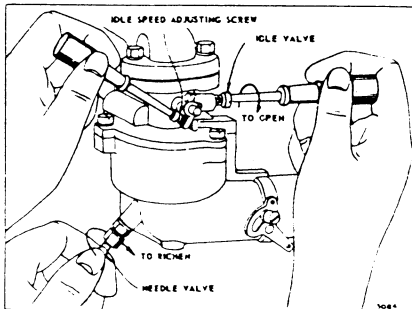

Final Adjustment

Turn needle valve in until engine misses (lean mixture) then turn it out past smooth operating point until engine runs unevenly (rich

mixture). Now turn needle valve to the mid-point between rich and lean so the engine runs smoothly.

Hold throttle at idle position and set idle speed adjusting screw until fast idle is obtained (1750 R.P.M.). Hold throttle in idle position and turn idle valve in (lean) and out (rich) until engine idles smoothly. Then reset idle speed adjusting screw so that engine idles at 1750 R.P.M. Release throttle - engine should accelerate without hesitation or sputtering. If engine does not accelerate properly, the carburetor should be re-adjusted to a slightly richer mixture.

Choke-A-Matic Carburetor Control

Proper choke and stop switch operation is dependent upon proper adjustment of remote control on the powered equipment.

To Check Operation of Choke-A-Matic Controls:

- a. Remove air cleaner.
- b. Move remote control lever to

"Choke" position. The carburetor choke should be closed, (See "B") and speed slide at end of slot.

- c. Move remote control to "Stop" position (See "C"). The speed slide must be at end of slot for stop switch to make good contact.
- d. Move remote control to "Fast" and observe through view hole (See "A"). Speed slide must be just touching pin on choke shaft.

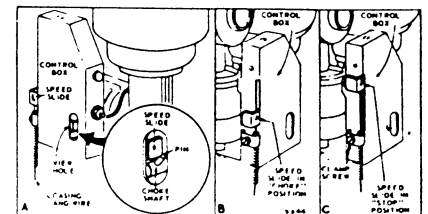

To Adjust Choke-A-Matic Remote Controls:

With remote control lever at "Fast", loosen casing clamp screw and move casing and wire

SECTION IV ADJUSTMENTS (Cont'd.)

up or down until speed slide, seen through view hole, is just touching pin on chokeshaft. Tighten casing clamp screw. Re-check operation of controls. Reassemble air cleaner.

GOVERNOR ADJUSTMENTS

There are two different types of governors used on these engines – air vane and mechanical. The recommended operating speed range is 1800 to 3600 R.P.M. The standard speed setting (no load) is 3600 R.P.M. Idle speed is 1750 R.P.M.

Air Vane Governor Adjustments

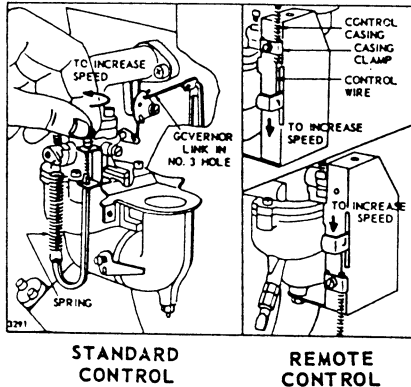

Standard Speed Control – Speed adjusting thumb nut is located on top

of engine. To increase speed turn thumb nut counterclockwise.

Remote Governor Control – Remote control casing and wire are fastened to top or bottom of control box on carburetor. Illustration shows direction of movement of control lever on control box to increase or decrease speed.

Mechanical Governor Adjustment

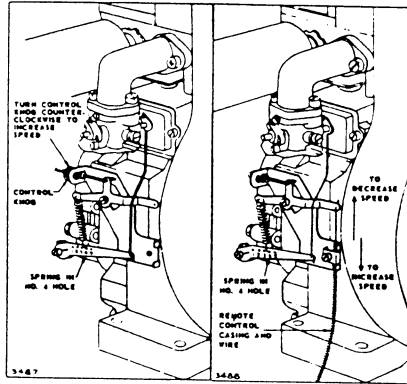

Standard Speed Control – Speed adjusting thumb nut is located on the power take-off side of engine. To increase speed turn adjusting nut counterclockwise.

NOTE: Spring loop should be in No. 3 hole of governor for speeds below 3100 R.P.M. Use No. 4 hole above 3100 R.P.M.

Remote Governor Control – The mechanical governor remote control is adjusted in the same manner as the air vane governor remote control.

Remote Throttle Control

Top speed of the engine is controlled by the governor. All other speeds from idle to top speed are controlled by a remote control lever.

Move control lever to LOW speed position. Loosen screw on swivel. Move wire through swivel until carburetor throttle closes. Tighten swivel screw, bend loose end of wire around swivel. Cut off excess wire.

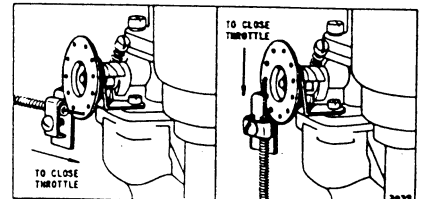

SECTION V GENERAL INFORMATION

These engines are single-cylinder L-head, air-cooled type

Bore 2 3/4"
Stroke 2 3/8"
Displacement 14.1 cu. in.
Horsepower 6.0 @ 3600 RPM
Torque (Ft.-Lbs.) 9.25 max. @ 3000 RPM

The horsepower rating listed above is established by standard I.C.E.I. procedures. For practical operation, the horsepower loading should not exceed 85% of these ratings. Engine power will decrease 3 1/2% for each 1,000 ft. above sea level and 1% for each 10 degrees above 60 degrees F.

Briggs & Stratton's policy of continual product improvement is evidenced by the many patents issued to the corporation covering engine improvements, some of which are listed below.

2,431,329	2,510,825	2,564,787	2,693,789	2,717,916	2,954,506	3,040,853
2,438,585	2,529,242	2,573,116	2,693,791	2,781,280	2,999,489	3,044,238
2,459,428	2,529,243	2,605,753	2,696,577	2,796,453	2,999,491	3,044,239
2,491,070	2,529,244	2,649,488	2,699,636	2,796,454	2,999,562	3,114,851
2,496,688	2,548,334	2,669,322	2,717,589	2,908,263	3,028,848	3,118,433

DESIGN PATENTS

173,072

191,806

STORAGE INSTRUCTIONS

Engines to be stored over 30 days should be completely drained of fuel to prevent gum deposits forming on essential carburetor parts, fuel filter, fuel lines and tank.

- Drain fuel tank completely. (See Section III).
- Re-assemble fuel filter assembly, fuel pipe and fuel shut-off valve. Leave shut-off valve open.
- Operate engine until gasoline

in carburetor is completely consumed.

- While engine is still warm, drain oil from crankcase. Refill with fresh oil.
- Remove spark plug, pour 1 ounce of SAE-30 oil into cylinder and crank slowly to distribute oil. Replace spark plug.
- Clean dirt and chaff from cylinder head fins and blower housing. (See Section III).

SECTION VI
WARRANTY

SAVE THIS INFORMATION FOR YOUR OWN RECORD

BRIGGS & STRATTON ENGINE WARRANTY

For ONE YEAR from purchase date, Briggs & Stratton Corp. will replace for the original purchaser, FREE OF CHARGE, any part, or parts, found upon examination by any Factory Authorized Service Outlet, or by the Factory at Milwaukee, Wisconsin, to be DEFECTIVE IN MATERIAL AND/OR WORKMANSHIP.

All transportation charges on parts submitted for replacement under this Warranty must be borne by purchaser.

There is no other Warranty express or implied. Briggs & Stratton Corp. shall in no event be liable for consequential damages.

BRIGGS & STRATTON CORP.

C. L. COUGHLIN - PRESIDENT

NOTE: The Briggs & Stratton Engine Warranty does not cover breakage of parts or damage to parts due to abuse or failure to follow recommended regular maintenance of crankcase oil level, cleaning of air cleaner and engine cooling fins, nor does it warrant any accessories, controls or equipment not of our manufacture.

Engine Model No. _____
Engine Type No. _____ } See Illustration on Page 1 to locate Model,
Engine Code No. _____ } Type and Code Number.
Date Purchased _____
Dealer Purchased from _____
Type of Equipment _____
Name or Trademark of Equipment Manufacturer _____

NO REGISTRATION (WARRANTY) CARD IS NECESSARY IN ORDER TO OBTAIN WARRANTY ON BRIGGS & STRATTON ENGINES

In case warranty service is ever needed you should present the above information to the nearest Authorized Service Dealer. You will need to give a complete report on the trouble experienced and the number of hours the engine has run since the equipment was purchased.

If you differ with the decision of a Service Dealer on a warranty claim, the Dealer's terms should be accepted. The Dealer will submit all supporting facts to the factory for review. If the factory's decision is that your claim is justified, you will be fully reimbursed for those items accepted as defective.

For replacement parts or service, only the Model, Type and Code numbers are needed by the Authorized Service Dealer.

NATION WIDE SERVICE ORGANIZATION

Briggs & Stratton maintains a vast network of Authorized Service Dealers that are prepared to give you prompt and efficient engine service.

Each member of this organization carries a stock of original Briggs & Stratton repair parts and is equipped with special service tools. Trained mechanics assure expert repair service on all Briggs & Stratton engines.

See yellow pages of your Classified Telephone Directory for nearby engine service under heading --

"Engines Gasoline" or "Gasoline Engines".



Free Manuals Download Website

<http://myh66.com>

<http://usermanuals.us>

<http://www.somanuals.com>

<http://www.4manuals.cc>

<http://www.manual-lib.com>

<http://www.404manual.com>

<http://www.luxmanual.com>

<http://aubethermostatmanual.com>

Golf course search by state

<http://golfingnear.com>

Email search by domain

<http://emailbydomain.com>

Auto manuals search

<http://auto.somanuals.com>

TV manuals search

<http://tv.somanuals.com>