

# Briggs & Stratton OPERATING AND MAINTENANCE INSTRUCTIONS MODELS

## 220700 to 220799 252700 to 252799

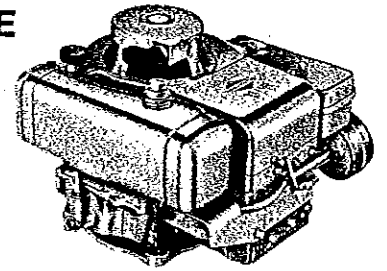

### IN THE INTEREST OF SAFETY

DO NOT RUN ENGINE AT EXCESSIVE SPEEDS. Operating an engine at excessive speeds increases the hazard of personal injury. DO NOT TAMPER WITH PARTS WHICH MAY INCREASE THE GOVERNED SPEED.

For rotary lawnmower safety, A.N.S.I. Standard Safety Specifications for Power Lawn Mowers specify a maximum blade tip speed of 19,000 feet per minute (96.5 meters per second), primarily to reduce the hazard from thrown objects.

Rotary lawnmower manufacturers select the governed top speed of the engine based on the length and design of the cutter blade and design of other mower parts.

All rotary lawnmowers should be checked for conformance to the A.N.S.I. Standard Safety Specifications for Power Lawn Mowers on blade tip speed, if the engine is repaired or replaced, or if mower parts are changed.

**DANGER:** GASOLINE VAPOR IS HIGHLY FLAMMABLE. Refuel outdoors preferably, or only in well ventilated areas.

DO NOT STORE, SPILL OR USE GASOLINE NEAR AN OPEN FLAME or devices such as a stove, furnace, water heater which utilize a pilot light, or devices that can create a spark.

If gasoline is accidentally spilled, move machine away from area of spill and avoid creating any source of ignition until gasoline vapors have dissipated.

DO NOT REFUEL GASOLINE TANK WHILE ENGINE IS RUNNING.

DO NOT RUN THE ENGINE IN AN ENCLOSED AREA. Exhaust gases contain carbon monoxide, an odorless and deadly poison.

TO PREVENT ACCIDENTAL STARTING always remove the spark plug from the engine, before working on the engine or equipment driven by the engine.

Except for adjustment; DO NOT operate engine if air cleaner or cover directly over carburetor air intake is removed. Removal of such part could create a fire hazard.

DO NOT OPERATE WITHOUT A MUFFLER OR TAMPER WITH THE EXHAUST SYSTEM. Damaged mufflers or spark arresters could create a fire hazard. Inspect periodically and replace if necessary.

DO NOT STRIKE FLYWHEEL with a hard object or metal tool as this may cause flywheel to shatter in operation, causing personal injury or property damage. Use Briggs & Stratton approved tools only, and if in doubt, contact your Authorized Briggs & Stratton Service Center.

ALWAYS KEEP HANDS AND FEET CLEAR OF ROTATING PARTS.

### IN THE INTEREST OF ENVIRONMENT

A muffler which leaks because of rust or damage can permit an increased exhaust noise level. Therefore, examine the muffler periodically to be sure it is functioning effectively. To purchase a new muffler, see SERVICE AND REPAIR INFORMATION.

**WARNING:** If this engine is not equipped with a spark arrester and is to be used on any forest covered, brush covered, or grass covered unimproved land, before using on such land a spark arrester must be added to the muffler. The arrester must be maintained in effective working order by the operator. In the State of California the above is required by law (Section 4442 of the California Public Resources Code). Other states may have similar laws. Federal laws apply on federal lands. See your Authorized Briggs & Stratton Service Center for spark arrester muffler options.

## SERVICE & REPAIR INFORMATION

If service or repair is needed, contact an Authorized Briggs & Stratton Service Center. To serve you promptly and efficiently, the Service Center will need the model, type and code number on your engine.

Each Authorized Service Center carries a stock of original Briggs & Stratton repair parts and is equipped with special service tools. Trained mechanics assure expert repair service on all Briggs & Stratton engines.

Major engine repairs should not be attempted unless you have the proper tools and a thorough knowledge of internal combustion engine repair procedure.



yellow pages

Your nearest service center is listed in the "Yellow Pages" under "Engines, Gasoline" or "Gasoline Engines." He is one of over 25,000 authorized dealers available to serve you.

This illustrated book includes "Theories of Operation," common specifications, and detailed information covering the adjustment, tune-up and repair procedures for 2 through 16 H.P. single cylinder models. It is available from any Authorized Briggs & Stratton Service Center. Order as Part Number 270962.



FORM NO. 270862-4/80  
PRINTED IN U.S.A.

BRIGGS & STRATTON CORP.  
Milwaukee, Wisconsin 53201

# BEFORE STARTING

## READ THE OPERATING INSTRUCTIONS OF THE EQUIPMENT THIS ENGINE POWERS

Use a high quality detergent oil classified "For Service SC, SD, SE or MS." Detergent oils keep the engine cleaner and retard the formation of gum and varnish deposits. Nothing should be added to the recommended oil.

## RECOMMENDED SAE VISCOSITY GRADES

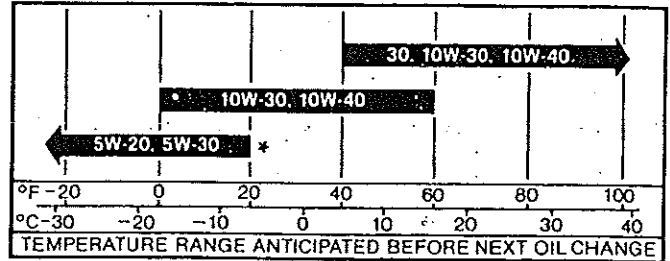

\*If not available, a synthetic oil may be used having 5W-20, 5W-30 or 5W-40 viscosity.

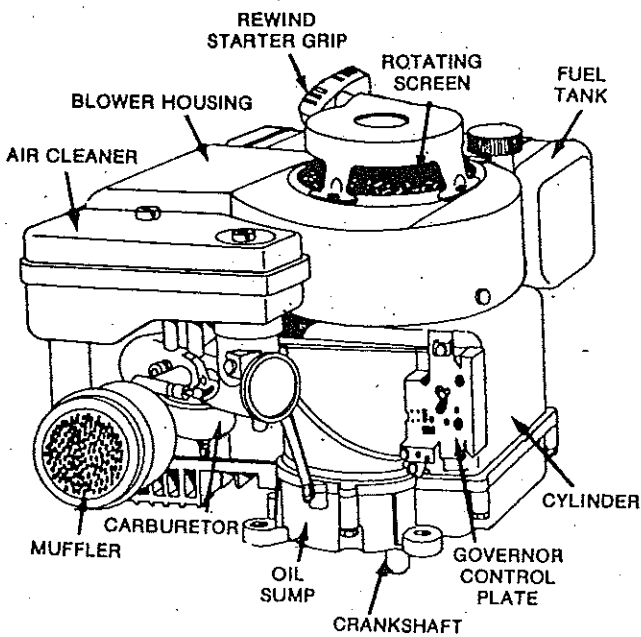
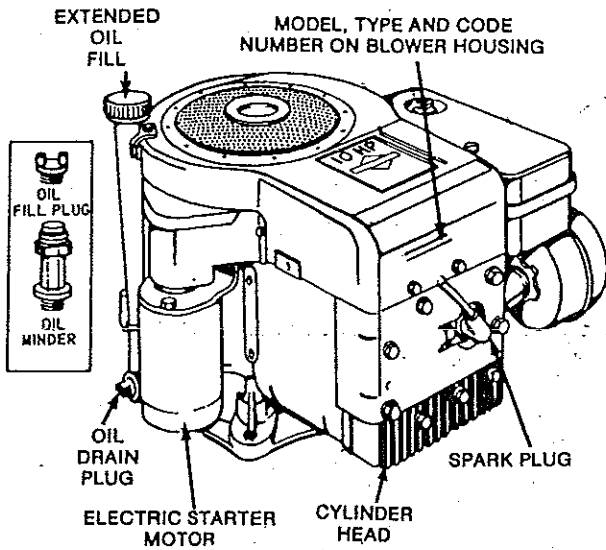

## TO FILL SUMP WITH OIL

Place engine level. Clean area around oil fill before removing oil fill plug, dipstick or oil-minder.

**OIL FILL PLUG** Remove oil fill plug or (optional) oil-minder. Fill crankcase to point of overflowing. **POUR SLOWLY.** Capacity 3 pints (1.42 liters). Replace oil fill plug or oil-minder.

**EXTENDED OIL FILL.** (Optional) Remove cap and dipstick. **FILL TO FULL MARK** on dipstick, **POUR SLOWLY.** Capacity 3 pints (1.42 liters). When checking oil level, screw dipstick assembly firmly but slowly until cap bottoms on tube. **DO NOT OVERFILL.** Dipstick assembly must be securely assembled into tube at all times when engine is operating.

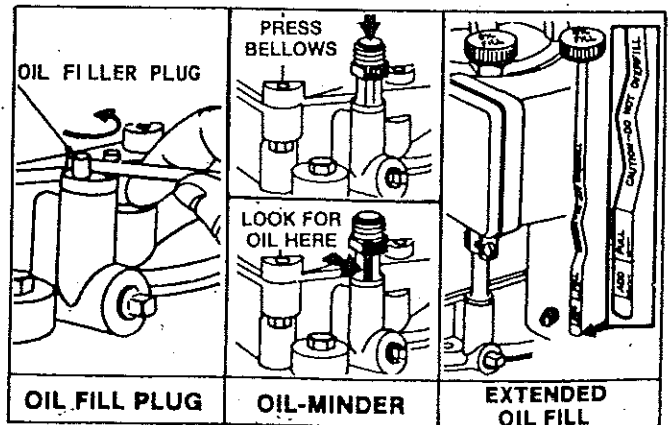

## CHARGE BATTERY

Charge battery before use on engines equipped with (OPTIONAL) 12 volt electric starter motor. See equipment manufacturers' recommendations.

### FILL FUEL TANK

Use clean, fresh, "regular grade leaded or low-lead" gasoline. DO NOT MIX OIL WITH GASOLINE.

NOTE: The use of "lead-free" gasoline produces fewer combustion deposits, but may shorten valve life if carburetor adjustment is too lean.

## STARTING

Start, store and fuel engine in a level position.

### OPEN FUEL VALVE

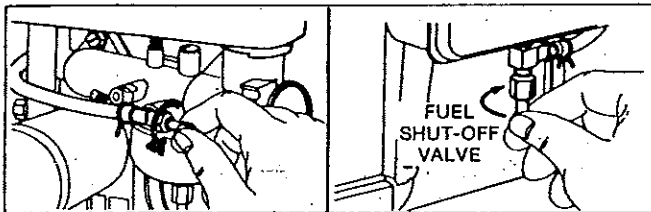

**CHOKE ENGINE:** Engine may be equipped with either manual, remote or choke-a-matic controls.

**MANUAL CHOKE:** Move lever as illustrated.

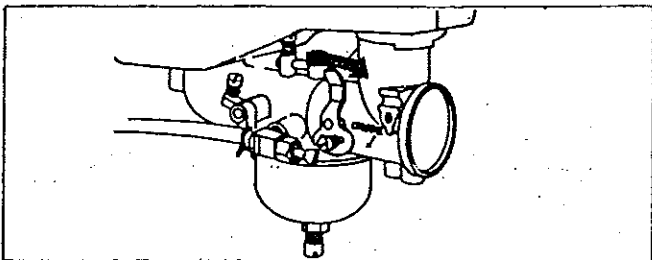

**REMOTE CHOKE:** Move equipment control lever to "CHOKE" position.

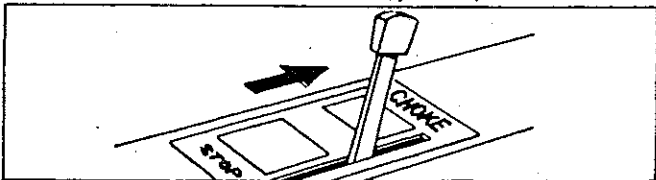

**CHOKE-A-MATIC:** Move lever to "Full Choke" or "Start" position.

NOTE: This should fully close choke on carburetor. If it does not, remote control must be re-adjusted. See ADJUSTMENT section.

NOTE: A warm engine requires less choking than a cold engine.

**GOVERNOR SPEED CONTROL LEVER:** Move governor speed control lever as far as possible toward "RUN" or "FAST" position.

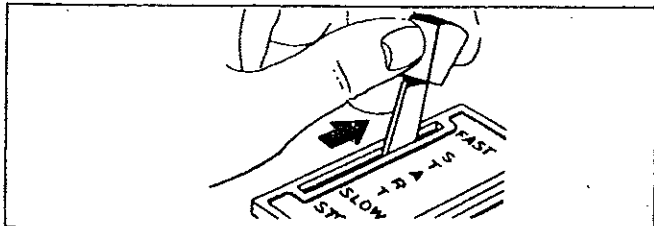

### TO START ENGINE

**DANGER: ALWAYS KEEP HANDS AND FEET CLEAR OF MOWER BLADE OR OTHER ROTATING MACHINERY.**

Rewind Starter. Grasp starter grip as illustrated and pull out cord rapidly to overcome compression and prevent kick-back. Repeat if necessary with choke opened slightly. When engine starts open choke gradually.

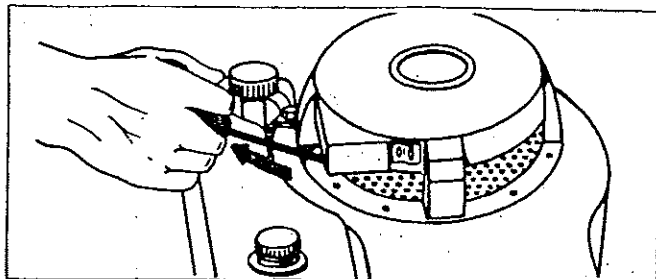

**Electric Starter. (Optional)** Turn key to "Start" position and/or press starter button on powered equipment. When engine starts open choke gradually.

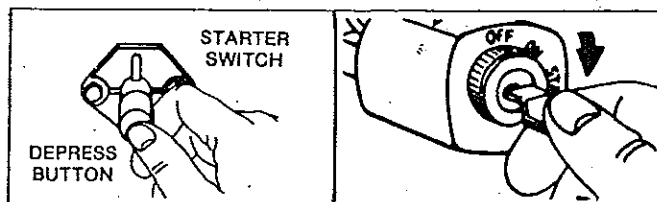

NOTE: If fuel drips out of carburetor while trying to start engine, the engine is over-choked. Pull starter several times or push starter switch with choke open.

### COLD WEATHER STARTING HINTS

1. Be sure to use the proper oil for the temperature expected.
2. Declutch all possible external loads.
3. Set throttle at part-throttle position.
4. A slightly richer fuel mixture, obtained by turning carburetor needle valve 1/8 turn, counterclockwise, will usually improve cold starting.
5. A warm battery has much more starting capacity than a cold battery.
6. Use fresh winter grade fuel.

When equipment is not in operation, provide protection from direct exposure to weather.

### TO STOP ENGINE

Move engine governor speed control lever to "STOP" or key to "OFF" position.

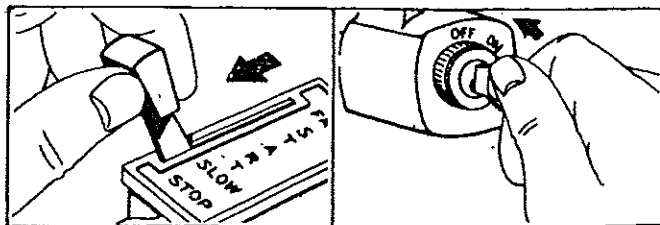

- 3 CAUTION: Always remove key from switch when leaving mower unattended or when mower is not in use.

# MAINTENANCE

**CHECK OIL LEVEL** regularly — after each five hours of operation. BE SURE OIL LEVEL IS MAINTAINED.

**CHANGE OIL** after first five hours of operation. Thereafter change every 25 hours of operation. Remove oil drain plug and drain oil while engine is warm. Replace drain plug. Remove oil fill plug, oil-minder or dipstick and refill with new oil of proper grade. Replace oil fill plug, oil-minder or dipstick.

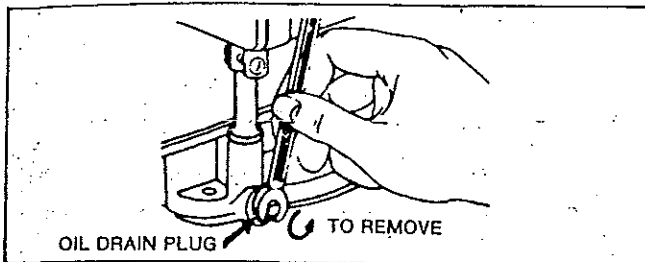

## TO SERVICE AIR CLEANER

Clean and re-oil foam element at three month intervals or every 25 hours, whichever occurs first.

NOTE: Service more often under dusty conditions.

### STANDARD OIL FOAM AIR CLEANER

1. Remove two screws and lift off complete air cleaner assembly.
2. Remove screen and spacers from foam element.
3. Remove foam element from air cleaner body.
4.
  - a. Wash foam element in kerosene or liquid detergent and water to remove dirt.
  - b. Wrap foam in cloth and squeeze dry.
  - c. Saturate foam in engine oil. Squeeze to remove excess oil.
  - d. Assemble parts — securely fasten to carburetor with screws.

When assembling make certain the lip of the foam element extends over edge of the air cleaner body. The foam element lip will form a protective seal.

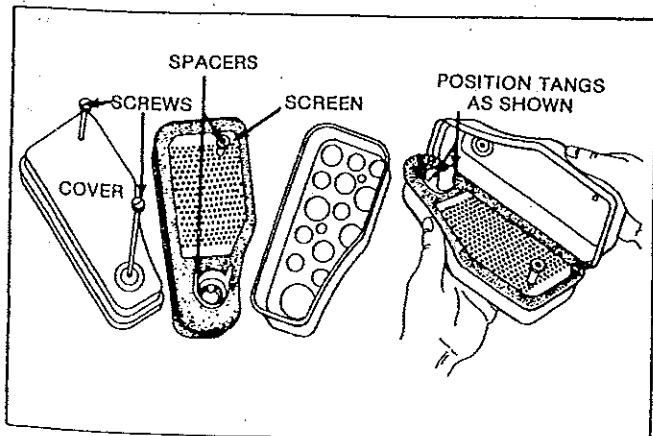

### DUCTED OIL FOAM AIR CLEANER

Same as standard except after foam element is removed, the element support and inside of body should be cleaned before assembly of the air cleaner.

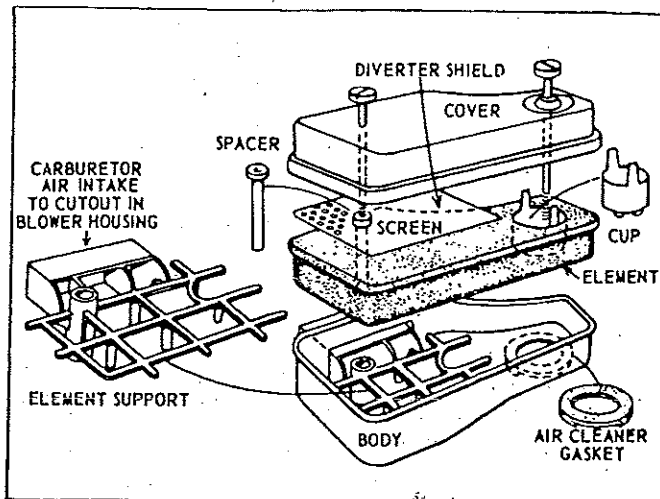

### CARTRIDGE AIR CLEANER

1. Remove air cleaner stud, screw and cover. Replace cover gasket if damaged.
2. Remove plate screw, washer and plate.
3. Remove cartridge and clean air cleaner body carefully to prevent dirt from entering carburetor. Brush dirt from body thru holes into duct.
4. Clean cartridge by tapping gently on flat surface.
  - a. If very dirty, replace cartridge or wash in a low or non-sudsing detergent and warm water solution.
  - b. Rinse thoroughly from OUTSIDE IN until water is clear.
  - c. Cartridge must be allowed to stand and air dry thoroughly before using.
5. Reassemble air cleaner.

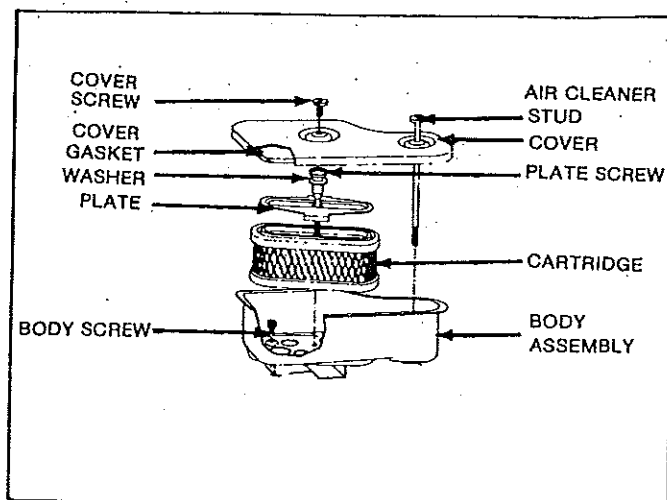

CAUTION: Petroleum solvents, such as kerosene, are not to be used to clean cartridge. They may cause deterioration of the cartridge. DO NOT OIL CARTRIDGE. DO NOT USE PRESSURIZED AIR TO CLEAN OR DRY CARTRIDGE.

**CLEAN COOLING SYSTEM** — Grass, chaff or dirt may clog the rotating screen and the air cooling system after prolonged service in cutting tall dry grasses or hay. Yearly or every 100 hours, whichever occurs first, remove the blower housing and clean the area shown to avoid overspeeding, overheating and engine damage. Clean more often if necessary.

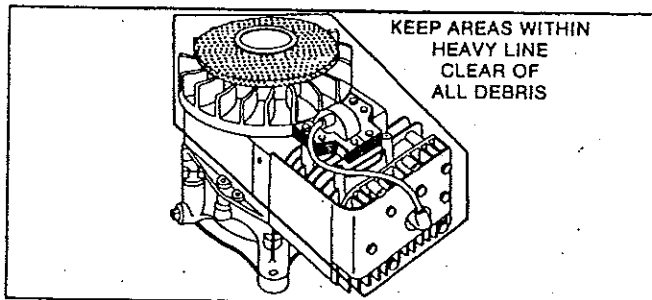

**DANGER:** Periodically clean muffler area to remove all grass, dirt and combustible debris.

**SPARK PLUG** — Clean and reset gap at .030" every 100 hours of operation.

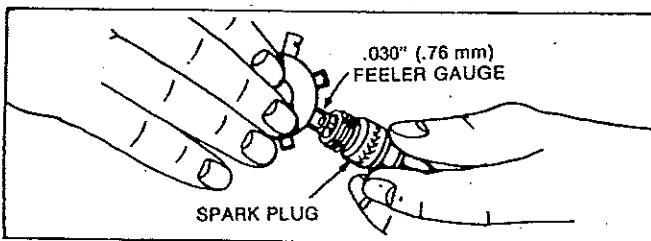

**CAUTION:** Do not blast clean spark plug. Spark plug should be cleaned by scraping or wire brushing and washing with a commercial solvent.

Sparking can occur if wire terminal does not fit firmly on spark plug, or if stop switch vibrates against spark plug. Reform terminal or repair switch if necessary.

**REMOVE COMBUSTION DEPOSITS** every 100-300 hours of operation. Remove cylinder head and cylinder head shield. Scrape and wire brush the combustion deposits from cylinder, cylinder head, top of piston and around valves. Use a soft brush to remove deposits. Re-assemble gasket, cylinder head and cylinder head shield. Turn screws down finger tight. Torque cylinder head screws in a staggered sequence to 165 inch pounds (18.65 Nm).

**SPARK ARRESTER EQUIPPED MUFFLER** — If engine muffler is equipped with spark arrester screen assembly, remove every 50 hours for cleaning and inspection. Replace if damaged.

## ADJUSTMENTS

### CARBURETOR ADJUSTMENTS

Minor carburetor adjustment may be required to compensate for differences in fuel, temperature, altitude or load.

**TO ADJUST CARBURETOR** — Turn needle valve clockwise until it just closes.

**CAUTION:** Valves may be damaged by turning them too far.

Now open needle valve 1½ turns counterclockwise. Close idle valve in same manner and open 1¼ turn. This initial adjustment will permit the engine to be started and warmed up prior to final adjustment.

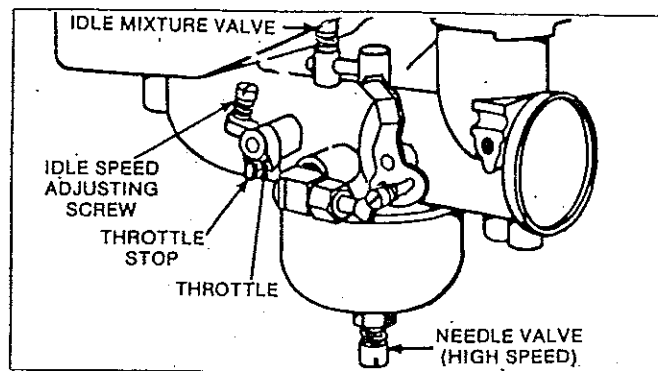

### FINAL ADJUSTMENT

Place governor speed control lever in "FAST" position. Turn needle valve in until engine slows (clockwise — lean mixture). Then turn it out past smooth operating point (rich mixture). Now turn needle valve to midpoint between rich and lean. Next, adjust idle RPM. Rotate throttle counterclockwise and hold against stop. Adjust idle speed adjusting screw to obtain 1750 RPM. Holding throttle against idle stop, turn idle valve in (lean) and out (rich). Set at midpoint between rich and lean. Re-check idle RPM. Release throttle. If engine will not accelerate properly, the carburetor should be re-adjusted, usually to a slightly richer mixture.

### CONTROL ADJUSTMENTS

Proper choke and stop switch operation is dependent upon proper adjustment of remote controls on the powered equipment.

#### TO CHECK OPERATION OF CHOKE CONTROLS:

Move remote control lever to "Choke" position. The carburetor choke should be closed.

#### TO ADJUST CHOKE:

Place remote control lever on equipment in "CHOKE" position. Loosen control casing clamp screw. Move casing and wire in direction shown by arrow. Tighten casing clamp screw.

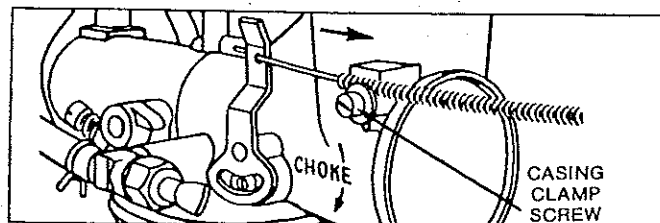

#### TO ADJUST CHOKE-A-MATIC CONTROLS:

Place remote speed control lever on equipment in FAST (high speed) position. Loosen control casing clamp screw "C." Move control casing "A" and wire until lever "E" lines up with bottom edge of tang "F." Tighten casing clamp screw "C." Move remote control to "STOP" position. Lever should make good contact with stop switch, if so equipped.

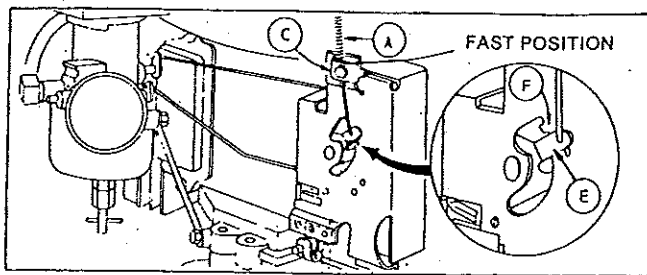

### GOVERNOR SPEED CONTROL ADJUSTMENTS

The acceptable operating speed range is 1800 to 3600 RPM. Idle speed is 1750 RPM. The manufacturer of the equipment on which the engine is used, specifies the top governed no load speed at which the engine may be operated. **DO NOT EXCEED** this speed.

To increase engine speed move control in direction shown by arrow. Refer to illustration.

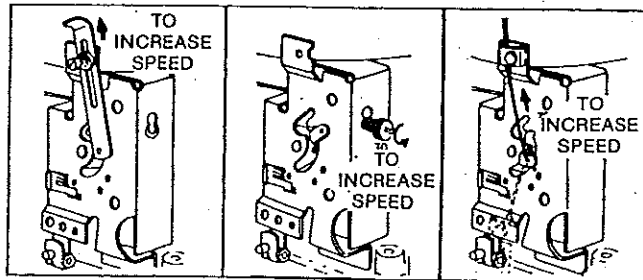

## GENERAL INFORMATION

These engines are single cylinder, L-head, air-cooled type.

### MODEL SERIES 220700 to 220799

Bore ..... 3-7/16" (87.31 mm)  
 Stroke ..... 2-3/8" (60.33 mm)  
 Displacement ..... 22.04 cu. in. (361.2 cc)  
 Horsepower ..... 10 H.P. Max. @ 3600 RPM  
 Torque (Ft. Lbs.) ..... 16.8 Max. @ 2400 RPM

### MODEL SERIES 252700 to 252799

Bore ..... 3-7/16" (87.31 mm)  
 Stroke ..... 2-5/8" (66.68 mm)  
 Displacement ..... 24.36 cu. in. (399.2 cc)  
 Horsepower ..... 11 HP Max. @ 3600 RPM  
 Torque (Ft. Lbs.) ..... 16.8 Max. @ 2800 RPM

The horsepower ratings listed above are established in accordance with the Society of Automotive Engineers Test Code-J607. For practical operation, the horsepower loading should not exceed 85% of these ratings. Engine power will decrease 3½% for each 1,000 feet (304.8 m) above sea level and 1% for each 10° above 60° F (16° C). In some areas, local law requires the use of a resistor spark plug so as to suppress ignition signals. If an engine was originally equipped with a resistor spark plug, be sure to use the same type of spark plug for replacement.

BRIGGS & STRATTON ENGINES ARE MADE UNDER ONE OR MORE OF THE FOLLOWING PATENTS:

28,960	3,149,618	3,276,439	3,526,146	3,625,071	3,968,854
2,999,491	3,194,224	3,305,223	3,572,218	3,831,268	3,971,353
2,999,562	3,236,937	3,457,804	3,572,307	3,882,336	3,991,152
3,114,851	3,242,741	3,465,740	3,625,492	3,901,199	3,991,152
3,118,433	3,252,449			3,961,724	4,168,288

### TUNE-UP SPECIFICATIONS

	Champion	Autolite	Robert Bosch
Spark Plug Type	CJ-8	235	WS9E
Short Plug	J-8	295	—
Long Plug	RCJ-8	245	WSR9E
Resistor Short Plug	RJ-8	306	—
Resistor Long Plug			

Spark Plug Gap ..... .030" (.76 mm)  
 Ignition Point Gap ..... .020" (.51 mm)  
 Intake Valve Clearance ..... .005"-.007" (.13-.18 mm)  
 Exhaust Valve Clearance ..... .009"-.011" (.23-.28 mm)

**WARNING:** For electrical safety always remove cable from negative (-) side of the battery before attempting any repairs or maintenance.

### Typical Wiring Diagrams

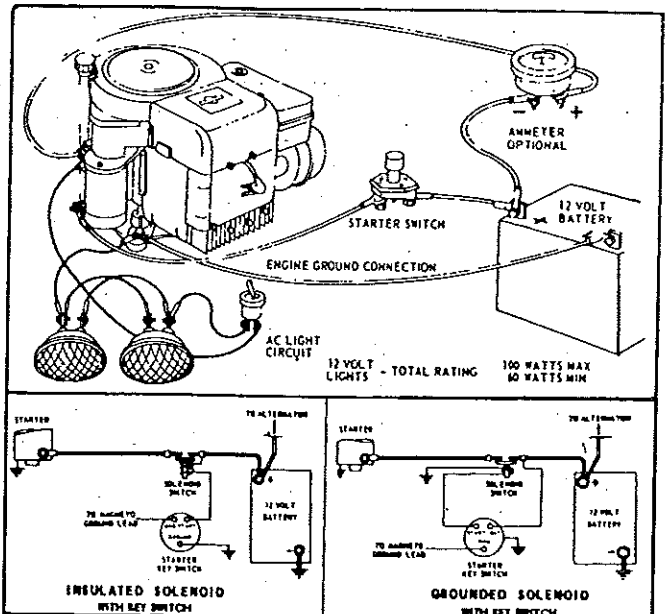

### STORAGE INSTRUCTIONS

Engines to be stored over 30 days should be completely drained of fuel to prevent gum deposits forming on essential carburetor parts, fuel filter and tank.

Note: The use of a fuel additive, such as STA-BIL, or an equivalent, will minimize the formation of fuel gum deposits during storage. Such an additive may be added to the gasoline in the fuel tank of the engine, or to the gasoline in a storage container.

- All fuel should be removed from the tank. Run the engine until it stops from lack of fuel. The small amount of fuel that remains in the sump of the tank should be removed by absorbing it with a clean, dry cloth.
- While engine is still warm, drain oil from crankcase. Refill with fresh oil.
- Remove spark plug, pour one ounce (29.6 cc) of engine oil into cylinder and crank slowly to distribute oil. Replace spark plug.
- Clean dirt and chaff from cylinder, cylinder head fins, blower housing, rotating screen and muffler areas.
- Store in a clean and dry area.

## Free Manuals Download Website

<http://myh66.com>

<http://usermanuals.us>

<http://www.somanuals.com>

<http://www.4manuals.cc>

<http://www.manual-lib.com>

<http://www.404manual.com>

<http://www.luxmanual.com>

<http://aubethermostatmanual.com>

Golf course search by state

<http://golfingnear.com>

Email search by domain

<http://emailbydomain.com>

Auto manuals search

<http://auto.somanuals.com>

TV manuals search

<http://tv.somanuals.com>