



## MODEL SERIES

60500 to 60506  
61500 to 61506  
80500 to 80596  
81500 to 81596

# OPERATING AND MAINTENANCE INSTRUCTIONS

**IMPORTANT:**

Do not start this engine before reading Section I and Section II of this manual. It takes only a few minutes.

## SECTION I BEFORE STARTING

### CAUTION:

1. PROVIDE EFFICIENT VENTILATION. Exhaust gases contain carbon monoxide which is odorless and a deadly poison. Proper care must be taken to provide efficient ventilation.
2. DO NOT FILL GASOLINE TANK WHILE ENGINE IS RUNNING. Avoid spilling gasoline on a hot engine — this may cause an explosion and serious injury.
3. KEEP ENGINE CLEAN. This engine is air-cooled. If cooling system becomes clogged, serious damage may result. Therefore, keep the blower screen, fins on flywheel, cylinder head and block free from grass or dirt.
4. When tipping engine on side for service, spark plug must be in upward position.
5. Be sure nobody is behind you when starting engine with rope starter.
6. ROTARY LAWN MOWERS. Always disconnect spark plug wire from spark plug before moving mower blade when cleaning under mower deck or sharpening blade.

### "OIL-FOAM" AIR CLEANER

"Oil-Foam" air cleaners are oiled at the factory and do not require initial service.

### FILL FUEL TANK

Use clean, fresh, "regular" grade gasoline. Fill tank completely.

**CAUTION:** The use of old or stale gasoline will result in gum deposits clogging the fuel system and carburetor. Make sure that vent hole in the tank is open. DO NOT MIX OIL WITH GASOLINE.

### FILL SUMP WITH OIL

Remove the oil filler plug or oil minder located on base of engine. Place the engine level. Fill the oil sump to overflowing. POUR SLOWLY. CAPACITY 1/4 PINTS. Replace the filler plug.

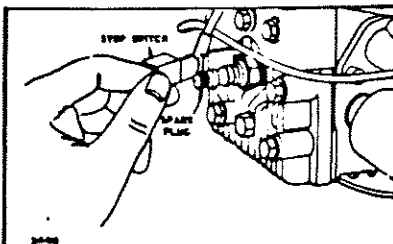

\*Trademark of Briggs & Stratton Corp

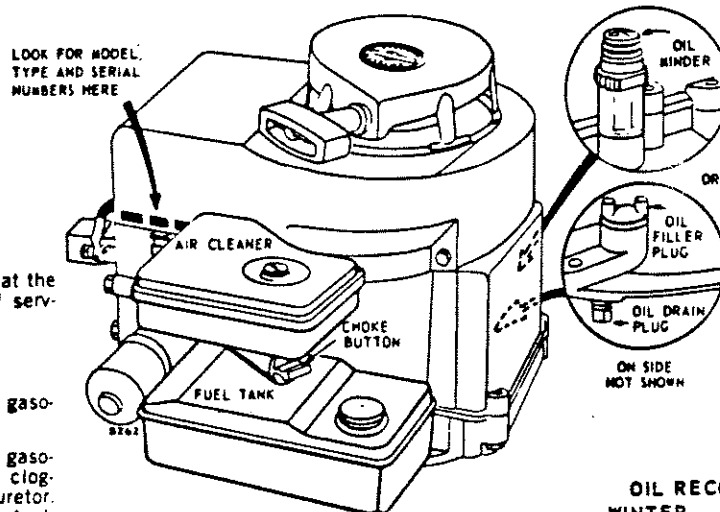

Any high quality detergent oil having the American Petroleum Institute classification "For Service MS" can be used in your Briggs & Stratton engine. Detergent oils keep the engine cleaner and retard the formation of gum and varnish deposits.

OIL RECOMMENDATIONS	
WINTER (Below 40° F.)	SUMMER (Above 40° F.)
Use SAE 5W-20 If not Available Use SAE 10W	Use SAE 30 If not Available Use SAE 10W-30

Nothing should be added to the recommended oils.

### CHOKE ENGINE — MANUAL TYPE

BE SURE  
STOP SWITCH  
IS AWAY FROM  
SPARK PLUG

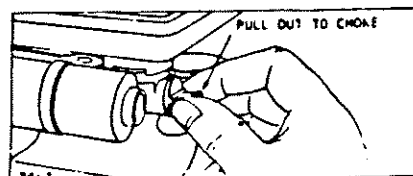

CLOSE  
CARBURETOR  
CHOKE  
BY PULLING  
OUT THE  
CHOKE KNOB

# IMPORTANT SAFETY INFORMATION AND INSTRUCTIONS FOR ENGINE SELECTION ENGINE INSTALLATION ENGINE OPERATION

In the USA and Canada,  
our 24 hour hotline is:

18002333723

Briggs & Stratton Corporation  
Milwaukee, Wisconsin 53201

[www.briggsandstratton.com](http://www.briggsandstratton.com)

Keep these instructions for future reference.

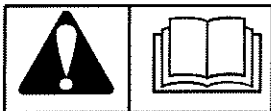



**Before installing and operating this engine read and observe all warnings, cautions and instructions on both sides of this sheet, on the engine, and in the operating & maintenance instructions.**

**NOTE:** This sheet of instructions and safety information is not meant to cover all possible conditions and situations that may occur. Read entire Operating & Maintenance Instructions for this engine AND the instructions for the equipment this engine powers. Failure to follow instructions and safety information could result in serious injury or death.

The safety alert symbol () is used to identify safety information about hazards that can result in personal injury.

A signal word (DANGER, WARNING, or CAUTION) is used with the alert symbol to indicate the likelihood and the potential severity of injury. In addition, a hazard symbol may be used to represent the type of hazard.

 **DANGER** indicates a hazard which, if not avoided, will result in death or serious injury.

 **WARNING** indicates a hazard which, if not avoided, could result in death or serious injury.

 **CAUTION** indicates a hazard which, if not avoided, might result in minor or moderate injury.

**CAUTION**, when used **without** the alert symbol, indicates a situation that **could result in damage to the engine.**

## HAZARD SYMBOLS AND MEANINGS



Fire



Explosion



Moving Parts



Toxic Fumes



Hot Surface



Shock



Kickback

(OVER)

FORM MS-6445-01/03





# ENGINE SELECTION









 <b>WARNING</b>

<b>Failure to select the correct engine could result in fire or explosion.</b>







- Some engines are unique and designed for specific applications or types of equipment. If this engine will be used to build new equipment, contact Briggs & Stratton to ensure that the engine is appropriate for the intended use.  
**Note: For all Go-karts use only a model 136200 series engine, which offers improved safety and performance.**
- Replacement engines should be the same model as the original engine, or be the Briggs & Stratton designated replacement engine. Refer to the Operation & Maintenance Instructions for engine identification information.  
**Note: For all Go-karts use only a model 136200 series engine, which offers improved safety and performance.**
- Do not use Briggs & Stratton engines on 3-wheel All-Terrain Vehicles (ATVs), motor bikes, air craft products, or vehicles intended for use in competitive events. Briggs & Stratton does not approve of or authorize such uses.

# ENGINE INSTALLATION

- Do not attempt to install this engine if you do not have the appropriate tools and knowledge of small engine installation procedures. Use only Briggs & Stratton parts. Contact your Authorized Service Dealer for assistance.
- Do not modify the engine in any way without Briggs & Stratton factory approval. Any such modification is at the owner's sole risk.
- If the exhaust system on the old engine was supplied by the equipment manufacturer, you must transfer the exhaust system and related components (original muffler and related pipes, brackets, clamps, and shields) to the new engine. All components must be in good condition.
- |  |   |
|--|---|
|  <b>WARNING</b> | Install muffler (and muffler deflector if used) so outlet points away from operator, fuel tank, and equipment, and so muffler heat will not damage or deform engine and components. |
|                 |   |
- |  |  |
|--|--|
|  <b>WARNING</b> | Ensure all fuel lines and fittings are properly assembled and do not leak. Replacement parts must be the same model as the original. |
|                 |  |
- |  |  |
|--|--|
|  <b>WARNING</b> | Ensure all wiring, including safety switches and engine shut-off components are completely installed and functioning properly. |
|                 |  |
- Set engine speed to equipment manufacturer's specification. Refer to equipment manufacturer's manual. Do not tamper with governor springs, or other parts that will increase engine speed above specification.

- |  |  |
|--|--|
|  <b>WARNING</b> | All engine parts, including fuel cap, spark plug, muffler, air cleaner, and covers and guards for drive components (gears, belts, shafts, couplings, etc.) must be in place before attempting to start engine. |
|                |  |
- |  |   |
|--|---|
|  <b>WARNING</b> | If engine is installed on walk behind lawn mower, all mower components, including cutting blade, must be correctly installed before attempting to start engine. |
|                |   |
- |  |   |
|--|---|
|  <b>WARNING</b> | When working on the engine or equipment, remove spark plug wire from spark plug. For electric start, remove negative wire from battery. |
|                |   |
- |  |  |
|--|--|
|  <b>WARNING</b> | Do not check for spark with spark plug removed. Use Briggs & Stratton spark tester #19368. |
|                |  |

# ENGINE OPERATION

	 <b>WARNING</b>
<b>When adding fuel:</b>	
Turn engine off and let engine cool at least 2 minutes before removing gas cap. Fill fuel tank outdoors or in well-ventilated area. Fill tank to about 1 inch below lowest portion of neck to allow for fuel expansion. Keep gasoline away from sparks, open flames, pilot lights, heat, and other ignition sources.	
	 <b>WARNING</b>
<b>When starting engine:</b>	
Remove all external equipment/engine loads. Wait until spilled fuel is evaporated. Start engine outdoors. Pull cord slowly until resistance is felt, then pull rapidly. If engine floods, set choke to OPEN/RUN, place throttle in FAST and crank until engine starts.	
	 <b>WARNING</b>
<b>When operating equipment:</b>	
Do not tip engine or equipment at angle which causes gasoline to spill. Run engine outdoors. Do not run in enclosed area, even if doors or windows are open. Do not choke carburetor to stop engine.	

## SECTION I — BEFORE STARTING (Cont'd)

### CHOKE ENGINE — CHOKE-A-MATIC TYPE

The Choke-A-Matic Carburetor permits choking, varying the engine speed, and stopping the engine by merely moving a single remote control lever to the desired position. Move lever to full choke or "start" position.

**NOTE:** ENGINE MAY NOT START IF CONTROLS ON POWERED EQUIPMENT DO NOT CLOSE CHOKE FULLY. See Choke-A-Matic adjustment instructions in Section IV of this manual if controls on equipment do not fully close choke as illustrated at right.

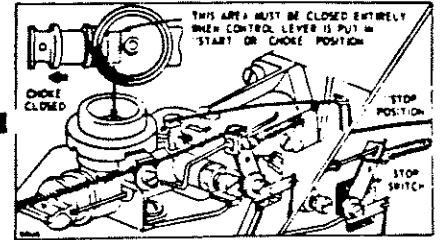
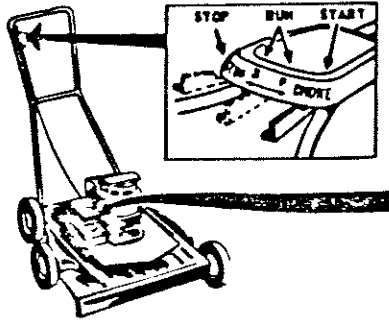

## SECTION II STARTING

### "Easy-Spin"™ Rewind Starter

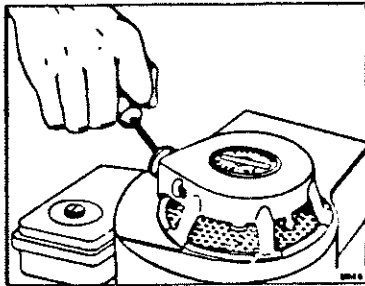

Grasp starter grip as illustrated and pull out cord two to three feet.

Repeat if necessary with choke opened slightly. When engine starts open choke gradually.

### "Easy-Spin"™ Rope Starter

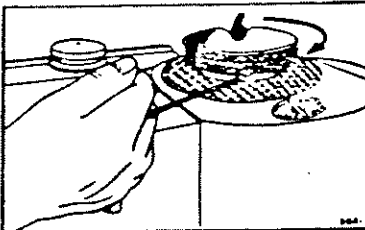

Wind the starter rope around the pulley in direction shown by arrow. Pull the rope with a quick full arm stroke. Repeat if necessary with choke opened slightly. When engine starts, open choke gradually.

## STOPPING

#### a. Choke-A-Matic Type

Move control lever to "stop" position.

#### b. Manual Choke Type

Push the stop switch against end of spark plug.

#### c. Other Type

Push square speed adjusting rod all the way inward to stop engine.

### Wind-up Starter

1. Turn control knob, on the side of the blower housing, clockwise to "Crank" position.

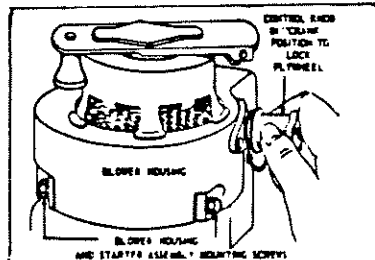

2. Lift cranking handle and extend to cranking position.

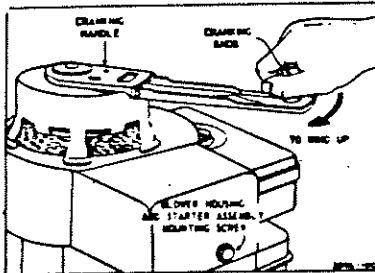

- 3A. 360° Rotation Type — Turn handle clockwise to wind up starter. Fold cranking handle to retracted position.

- 3B. Ratchet Type — Ratchet type starters are wound up by moving handle clockwise as far as possible and returning handle to original position. Repeat this operation until spring is fully wound. Fold cranking handle to retracted position and place knob between rubber bumpers.

4. Turn control knob on blower housing counterclockwise to "Start" position. As engine starts, gradually move choke control to open (run) position.

**CAUTION ALWAYS KEEP HANDS AND FEET CLEAR OF MOWER BLADE OR OTHER ROTATING MACHINERY.**

**CAUTION:** NEVER WORK ON MOWER BLADES WHEN WIND-UP STARTER IS WOUND UP. IF BLADE BECOMES JAMMED SO THAT STARTER WILL NOT CRANK ENGINE, REMOVE BLOWER HOUSING AND STARTER ASSEMBLY FROM ENGINE BEFORE DOING ANY WORK ON MOWER OR ENGINE.

Do not turn the control knob to "Crank" position while the engine is running.

If the Wind-up Starter is disassembled for any reason, do not remove the starter spring from its steel housing. The powerful starter spring will unwind explosively and could cause severe injury.

### 110 Volt A. C. Electric Starter

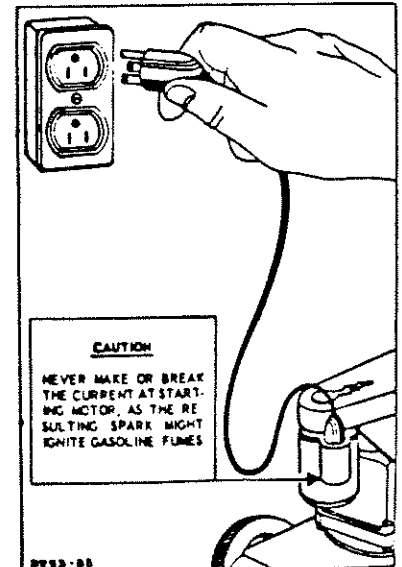

Attach electrical cord to engine starting motor. To start engine, plug starter cord into wall receptacle. When engine starts, remove plug from wall receptacle. Open choke gradually. Detach cord at engine.

If the engine does not start after two or three attempts, open choke wide, wait a few seconds, then repeat.

\*Trademark of Briggs & Stratton Corp

## SECTION III REGULAR MAINTENANCE

### CHANGE OIL (Oil Sump)

Change oil after first 5 hours of operation while engine is warm. Thereafter change oil every 25 hours of operation while engine is warm. Drain plug is on bottom of oil sump.

Engine may be drained through oil drain Fig. 1, or oil filler opening shown in Fig. 2. Be sure to replace drain plug and oil filler cap. Check oil level regularly — at least after each 5 hours of operation. Be sure oil level is maintained FULL TO POINT OF OVERFLOWING.

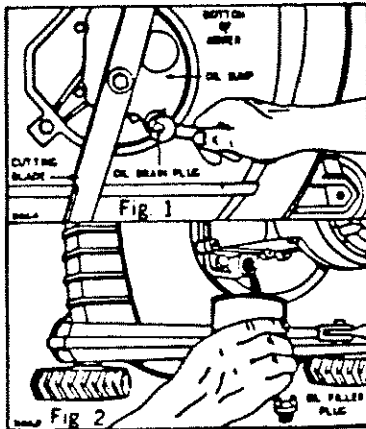

### SERVICE AIR CLEANER REGULARLY

Clean and re-oil the air cleaner frequently (every few hours under extremely dusty conditions). Clean and re-oil at least every 25 hours under normal conditions.

### "Oil-Foam" Type

1. Remove thumb screw
2. Lift air cleaner from carburetor

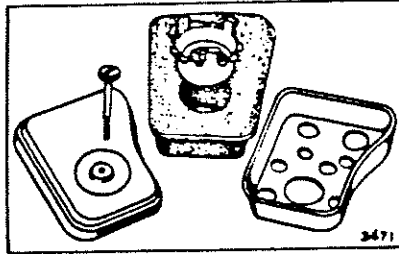

3. Take air cleaner apart
4. A — Wash element in kerosene or solvent.  
B — Squeeze dry and re-oil with 3 tablespoons of engine oil.  
C — Squeeze again to spread oil thru foam.  
D — Assemble parts — fasten to carburetor with screw.

### STORAGE INSTRUCTIONS

Engines to be stored over 30 days should be completely drained of fuel to prevent gum deposits forming on essential carburetor parts, fuel filter, fuel lines and tank.

- a. All fuel should be removed from fuel tank. Run the engine until it stops from lack of fuel. The small amount of fuel that remains in the sump of the tank should then be removed by absorbing it with a clean dry cloth.

### OIL-MINDER

Special accessory furnished on some vertical crankshaft models. This visual gauge permits checking the oil level without removing oil filler plug.

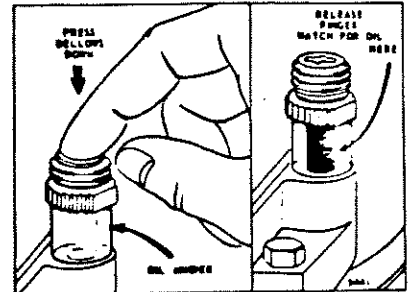

1. Position engine level (Not Running).
2. Press and release bellows several times.

If plastic tube fills with oil, it is safe to operate engine.

If plastic tube does not fill with oil, engine oil is low. Remove OIL-MINDER and fill crankcase to point of overflowing.

- b. While engine is still warm, drain oil from crankcase. Refill with fresh oil.
- c. Remove spark plug, pour 1 ounce of SAE-30 oil into cylinder and crank slowly to distribute oil. Replace spark plug.
- d. Clean dirt and chaff from cylinder, cylinder head fins and blower housing.

## SECTION IV ADJUSTMENTS

### GOVERNOR ADJUSTMENTS

#### Choke-A-Matic Carburetor

Proper choke and stop switch operation is dependent upon proper adjustment of remote controls on the powered equipment.

#### To Check Operation:

Remove Air Cleaner. Move remote control lever to CHOKE position. The carburetor choke should then be closed. Move the remote control lever to STOP. Speed lever on carburetor should then make contact with stop switch to short out ignition.

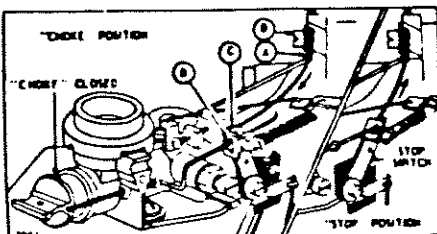

#### To Adjust:

Place remote control lever in FAST position. Loosen casing clamp screw (B) on carburetor. Move control casing (A) forward or backward until speed lever (C) just touches the choke operating link at (D). Tighten casing clamp screw (B) on carburetor. Re-check operation of controls after adjustment. Replace air cleaner.

#### Manual Friction-Type Governor Control

To increase or decrease engine speed, move speed adjusting rod as shown.

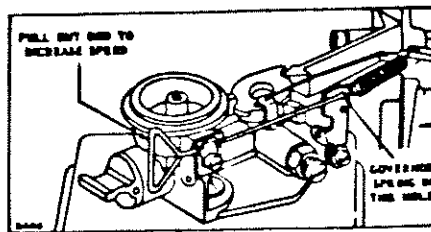

#### Remote Governor Controls

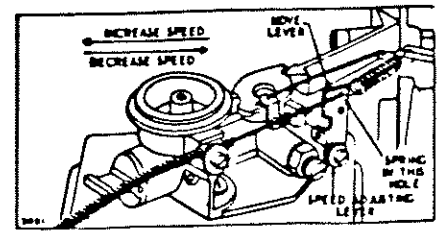
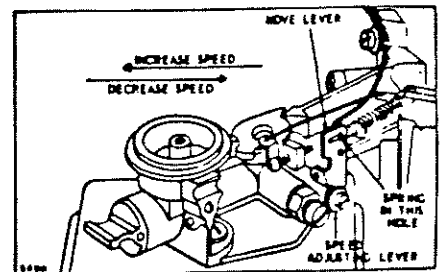

SECTION IV  
SECTION IV — ADJUSTMENTS (Cont'd)

CARBURETOR ADJUSTMENTS

**Initial Adjustment:**

Close needle valve (turn clockwise) then open 1½ turns (turn counter-clockwise). This initial adjustment will permit the engine to be started and warmed up before making final adjustment.

**Final Adjustment:**

With engine running at normal operating speed (approximately 3000 R.P.M. without load) close the needle valve (turn clockwise) until engine starts to lose speed (lean mixture). Then slowly

open needle valve (turn counter-clockwise), past the point of smoothest operation, until engine just begins to run unevenly. This mixture should be rich enough for best performance under load.

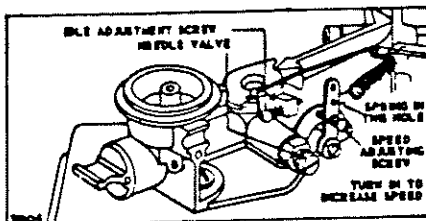

Hold throttle in idling position. Turn idle speed adjusting screw until fast idle is obtained (1750 R.P.M.).

Test the engine under full load. If engine tends to stall or die out, it usually indicates that the mixture is slightly lean and it may be necessary to open the needle valve slightly to provide a richer mixture. This richer mixture may cause a slight unevenness in idling.

SECTION V  
PARTS AND SERVICE

GENERAL INFORMATION

These engines are single-cylinder, L-head, air-cooled type.

MODEL SERIES 80500 to 80508 and 81500 to 81508	MODEL SERIES 80500 to 80508 and 81500 to 81508
Bore ..... 2¾"	Bore ..... 2¾"
Stroke ..... 1½"	Stroke ..... 1¾"
Displacement ..... 6.65 cu. in.	Displacement ..... 7.75 cu. in.
Horsepower 2.0 HP max. @ 3600 RPM	Horsepower 2.5 HP max. @ 3600 RPM

The horsepower ratings listed above are established by standard I.C.E.I. procedures. For practical operation, the horsepower loading should not exceed 85% of these ratings. Engine power will decrease 3½% for each 1,000 ft. above sea level and 1% for each 10 degrees above 60 degrees F.

TUNE-UP SPECIFICATIONS

Spark Plug Type	AC-GC-46; AL-A7R; Champ. J8.
Spark Plug Gap	..... .025"
Ignition Point Gap	..... .020"
Intake Valve Clearance	..... .005"-.007"
Exhaust Valve Clearance	..... .009"-.011"

**CAUTION:** Blast Cleaning of spark plugs in machines that use abrasive grit is not recommended. Spark plugs should be cleaned by scraping or wire brushing and washing with a commercial solvent or gasoline.

Major engine repairs should not be attempted unless you have the proper tools and a thorough knowledge of internal combustion engines.

## BRIGGS & STRATTON ENGINE WARRANTY POLICY

Here is a reproduction of the Briggs & Stratton Warranty that is supplied with each engine. (Be sure to fill out and return registration card at time of purchase):

### THE WARRANTY

For **ONE YEAR** from purchase date, Briggs & Stratton Corp. will replace for the original purchaser, **FREE OF CHARGE**, any part, or parts, found upon examination by any Factory Authorized Service Outlet, or by the Factory at Milwaukee, Wisconsin, to be **DEFECTIVE IN MATERIAL AND/OR WORKMANSHIP**.

All transportation charges on parts submitted for replacement under this Warranty must be borne by purchaser.

There is no other Warranty express or implied. Briggs & Stratton Corp. shall in no event be liable for consequential damages.

**WARRANTY DOES NOT COVER BENT CRANKSHAFTS, FAILURE TO MAINTAIN OIL IN CRANKCASE, USER NEGLIGENCE OR ABUSE**

### WARRANTY INSTRUCTIONS

When you request engine or engine parts warranty service, always supply the Briggs & Stratton Authorized Service Dealer the following information:

Model Number, Type Number and Serial Number that are stamped on side of engine blower housing.

Date Purchased.

Kind of equipment engine is used on.

Name or trademark of manufacturer.

Name and address of dealer from whom purchased.

Approximate number of hours engine has run since equipment was purchased.

Also, give complete report of trouble experienced and special servicing instructions.

The above information is necessary to insure prompt and proper service.

If you differ with the decision of a Service Dealer on a warranty claim, the Dealer's terms should be accepted. The Dealer will submit all supporting facts to the factory for review. If the factory's decision is that your claim is justified, you will be fully reimbursed for those items accepted as defective.

An illustrated parts list is available from any Briggs & Stratton authorized service organization.

### NATION WIDE SERVICE ORGANIZATION

Briggs & Stratton maintains a vast network of Authorized Service Dealers that are prepared to give you prompt and efficient engine service.

Each member of this organization carries a stock of original Briggs & Stratton repair parts and is equipped with special service tools. Trained mechanics assure expert repair service on all Briggs & Stratton engines.



See yellow pages of your Classified Telephone Directory for nearby engine service under heading "Engines - Gasoline" or "Gasoline Engines".

## Free Manuals Download Website

<http://myh66.com>

<http://usermanuals.us>

<http://www.somanuals.com>

<http://www.4manuals.cc>

<http://www.manual-lib.com>

<http://www.404manual.com>

<http://www.luxmanual.com>

<http://aubethermostatmanual.com>

Golf course search by state

<http://golfingnear.com>

Email search by domain

<http://emailbydomain.com>

Auto manuals search

<http://auto.somanuals.com>

TV manuals search

<http://tv.somanuals.com>