

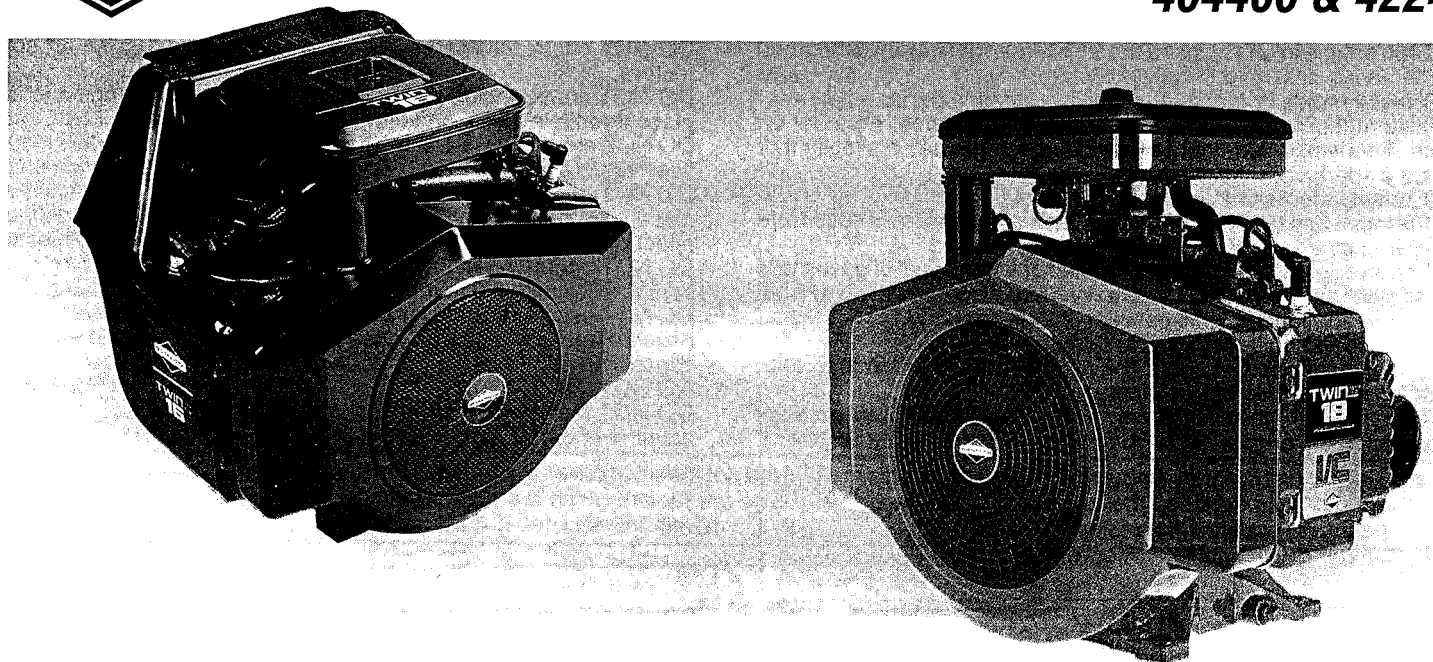

Before starting this engine,  
read and understand this *Owner's Manual*.

**Owner's Manual**  
**Model Series 400400, 402400,**  
**404400 & 422400**



For future reference, write numbers here. \_\_\_\_\_  
See page 8 for location of your engine Model/Type/Code.

**Model**                      **Type**                      **Code**

---

**Table of Contents**

<i>In the Interest of Safety</i> .....	<b>1</b>	<i>Adjustments</i> .....	<b>5</b>
<i>Oil &amp; Fuel Recommendations</i> .....	<b>2</b>	<i>Maintenance</i> .....	<b>6</b>
<i>Before Starting</i> .....	<b>3</b>	<i>Service &amp; Storage</i> .....	<b>9</b>
<i>Starting and Stopping</i> .....	<b>4</b>	<i>Warranty</i> .....	<b>10</b>

**Briggs & Stratton Corporation**  
**Milwaukee, Wisconsin 53201**

© Copyright 1989 by Briggs & Stratton Corporation

FORM NO. 272111-10/92  
PRINTED IN U.S.A.

# IMPORTANT SAFETY INFORMATION AND INSTRUCTIONS FOR ENGINE SELECTION ENGINE INSTALLATION ENGINE OPERATION

In the USA and Canada,  
our 24 hour hotline is:

18002333723

Briggs & Stratton Corporation  
Milwaukee, Wisconsin 53201

[www.briggsandstratton.com](http://www.briggsandstratton.com)

Keep these instructions for future reference.





**Before installing and operating this engine read and observe all warnings, cautions and instructions on both sides of this sheet, on the engine, and in the operating & maintenance instructions.**

**NOTE:** This sheet of instructions and safety information is not meant to cover all possible conditions and situations that may occur. Read entire Operating & Maintenance Instructions for this engine AND the instructions for the equipment this engine powers. Failure to follow instructions and safety information could result in serious injury or death.

The safety alert symbol () is used to identify safety information about hazards that can result in personal injury.

A signal word (DANGER, WARNING, or CAUTION) is used with the alert symbol to indicate the likelihood and the potential severity of injury. In addition, a hazard symbol may be used to represent the type of hazard.

 **DANGER** indicates a hazard which, if not avoided, will result in death or serious injury.

 **WARNING** indicates a hazard which, if not avoided, could result in death or serious injury.

 **CAUTION** indicates a hazard which, if not avoided, might result in minor or moderate injury.

**CAUTION**, when used **without** the alert symbol, indicates a situation that **could result in damage to the engine.**

## HAZARD SYMBOLS AND MEANINGS



Fire



Explosion



Moving Parts



Toxic Fumes



Hot Surface



Shock



Kickback

(OVER)

FORM MS-6445-01/03

# ENGINE SELECTION



 <b>WARNING</b>



<b>Failure to select the correct engine could result in fire or explosion.</b>



- Some engines are unique and designed for specific applications or types of equipment. If this engine will be used to build new equipment, contact Briggs & Stratton to ensure that the engine is appropriate for the intended use.  
**Note: For all Go-karts use only a model 136200 series engine, which offers improved safety and performance.**
- Replacement engines should be the same model as the original engine, or be the Briggs & Stratton designated replacement engine. Refer to the Operation & Maintenance Instructions for engine identification information.  
**Note: For all Go-karts use only a model 136200 series engine, which offers improved safety and performance.**
- Do not use Briggs & Stratton engines on 3-wheel All-Terrain Vehicles (ATVs), motor bikes, air craft products, or vehicles intended for use in competitive events. Briggs & Stratton does not approve of or authorize such uses.

# ENGINE INSTALLATION



- [1] Do not attempt to install this engine if you do not have the appropriate tools and knowledge of small engine installation procedures. Use only Briggs & Stratton parts. Contact your Authorized Service Dealer for assistance.
- [2] Do not modify the engine in any way without Briggs & Stratton factory approval. Any such modification is at the owner's sole risk.
- [3] If the exhaust system on the old engine was supplied by the equipment manufacturer, you must transfer the exhaust system and related components (original muffler and related pipes, brackets, clamps, and shields) to the new engine. All components must be in good condition.
- [4] 



 <b>WARNING</b>	Install muffler (and muffler deflector if used) so outlet points away from operator, fuel tank, and equipment, and so muffler heat will not damage or deform engine and components.
	
- [5] 



 <b>WARNING</b>	Ensure all fuel lines and fittings are properly assembled and do not leak. Replacement parts must be the same model as the original.
	
- [6] 



 <b>WARNING</b>	Ensure all wiring, including safety switches and engine shut-off components are completely installed and functioning properly.
	
- [7] Set engine speed to equipment manufacturer's specification. Refer to equipment manufacturer's manual. Do not tamper with governor springs, or other parts that will increase engine speed above specification.

- [8] 



 <b>WARNING</b>	All engine parts, including fuel cap, spark plug, muffler, air cleaner, and covers and guards for drive components (gears, belts, shafts, couplings, etc.) must be in place before attempting to start engine.
	
- [9] 



 <b>WARNING</b>	If engine is installed on walk behind lawn mower, all mower components, including cutting blade, must be correctly installed before attempting to start engine.
	
- [10] 



 <b>WARNING</b>	When working on the engine or equipment, remove spark plug wire from spark plug. For electric start, remove negative wire from battery.
	
- [11] 

 <b>WARNING</b>	Do not check for spark with spark plug removed. Use Briggs & Stratton spark tester #19368.
	

# ENGINE OPERATION

	 <b>WARNING</b>
<b>When adding fuel:</b>	
Turn engine off and let engine cool at least 2 minutes before removing gas cap. Fill fuel tank outdoors or in well-ventilated area. Fill tank to about 1 inch below lowest portion of neck to allow for fuel expansion. Keep gasoline away from sparks, open flames, pilot lights, heat, and other ignition sources.	

	 <b>WARNING</b>
<b>When starting engine:</b>	
Remove all external equipment/engine loads. Wait until spilled fuel is evaporated. Start engine outdoors. Pull cord slowly until resistance is felt, then pull rapidly. If engine floods, set choke to OPEN/RUN, place throttle in FAST and crank until engine starts.	

	 <b>WARNING</b>
<b>When operating equipment:</b>	
Do not tip engine or equipment at angle which causes gasoline to spill. Run engine outdoors. Do not run in enclosed area, even if doors or windows are open. Do not choke carburetor to stop engine.	

## In the Interest of Safety



This symbol means safety alert which indicates that a message involves personal safety. Death, personal injury and/or property damage may occur unless instructions are followed carefully.



DO NOT run engine in an enclosed area. (Exhaust gases contain carbon monoxide, an odorless and deadly poison.)  
 DO NOT place hands or feet near moving or rotating parts.  
 DO NOT store, spill, or use gasoline near an open flame, nor near an appliance like a stove, furnace, or water heater that uses a pilot light or can create a spark.  
 DO NOT refuel indoors or in unventilated area.  
 DO NOT remove fuel tank cap nor fill fuel tank while engine is hot or running. (Allow engine to cool 2 minutes before refueling.)  
 DO NOT operate engine if gasoline is spilled or when smell of gasoline is present or other explosive conditions exist. (Move equipment away from spill and avoid any ignition until gasoline has evaporated.)  
 DO NOT transport engine with fuel in tank.  
 DO NOT choke carburetor to stop engine. (Whenever possible, gradually reduce engine speed before stopping.)  
 DO NOT tamper with governor springs, links or other parts to increase engine speed. (Run engine at speed set for equipment manufacturer.)

**Note:** The important safety instructions appearing in this manual are not meant to cover all possible conditions and situations that may occur. It must be understood that common sense, caution and care are factors which are not built into an engine, but are supplied by the person(s) maintaining and operating it.



- ✓ PREVENT ACCIDENTAL STARTING by removing spark plug wire when servicing engine or equipment. Disconnect negative wire from battery terminal if equipped with electric starting system.
- ✓ KEEP cylinder fins and governor parts free of dirt, grass and other debris which can affect engine speed.
- ✓ PULL starter cord slowly until resistance is felt. Then pull cord rapidly to avoid kickback and prevent hand or arm injury.



You are not ready to operate this engine if you have not read and understood the following safety items. Read this entire owner's manual and the operating instructions of the equipment this engine powers.



### WARNING

DO NOT check for spark with spark plug removed. (Use an approved tester.)  
 DO NOT crank engine with spark plug removed. (If engine is flooded, place throttle in FAST and crank until engine starts.)  
 DO NOT strike flywheel with a hammer or hard object as this may cause flywheel to shatter in operation. (Use correct tools to service engine.)  
 DO NOT operate engine without a muffler. (Inspect periodically and replace if worn or leaking. If engine is equipped with muffler deflector, inspect periodically and, if necessary, replace with correct deflector.)  
 DO NOT operate engine with an accumulation of grass, leaves or other combustible material in muffler area.  
 DO NOT use this engine on any forest covered, brush covered, or grass covered unimproved land unless a spark arrester is installed on muffler. (Spark arrester must be maintained in working order by operator.)  
 DO NOT touch hot muffler, cylinder, or fins which can cause burns.  
 DO NOT start engine with air cleaner or air cleaner cover removed (or cover over carburetor air intake, if Sno/Gard engine).



### WARNING

- ✓ USE fresh gasoline. Stale fuel can gum carburetor and cause leakage.
- ✓ CHECK fuel lines and fittings frequently for cracks or leaks. Replace if necessary.

Use only Genuine Briggs & Stratton Parts or their equivalent. The use of replacement parts which are not of equivalent quality may damage the engine.

### INTERNATIONAL SYMBOLS



... Read Owner's Manual



..... Oil



.... On Off



... Fuel Shutoff



..... Choke



..... Slow



..... Safety-alert Symbol



..... Fuel



..... Stop



... Primer



..... Fast



... Air Cleaner

In the USA and Canada, a 24 hour hot line, 1-800-233-3723, has a menu of pre-recorded messages offering you engine maintenance information.

# Oil & Fuel Recommendations

**Note:** Engine is shipped from Briggs & Stratton without oil.  
**Before starting engine, check oil level as shown below.**

Change and add oil according to chart below. Do not over-fill.  
 Use a high quality detergent oil classified "For Service SC, SD, SE, SF, SG," such as Briggs & Stratton "warranty certified" SAE 30 oil, part no. 100005. Use no special additives with recommended oils.  
 Do not mix oil with gasoline.

SAE Viscosity Grades

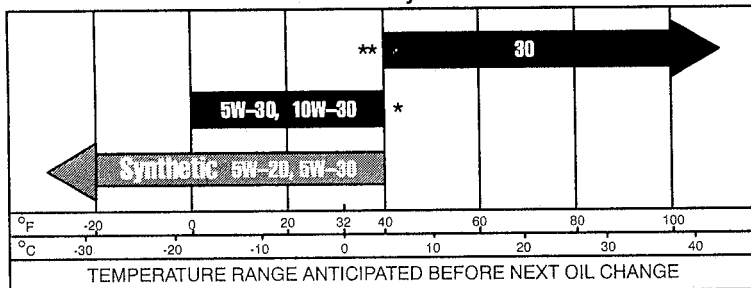

- \* Air cooled engines run hotter than automotive engines. Use of multi-viscosity oils (10W-30, etc.) above 40° F (4° C) will result in high oil consumption and possible engine damage. Check oil level more frequently if using these types of oils.
- \*\* SAE 30 oil, if used below 40° F (4° C), will result in hard starting and possible engine bore damage due to inadequate lubrication.

**Check oil level before starting engine. Add oil as shown below.**

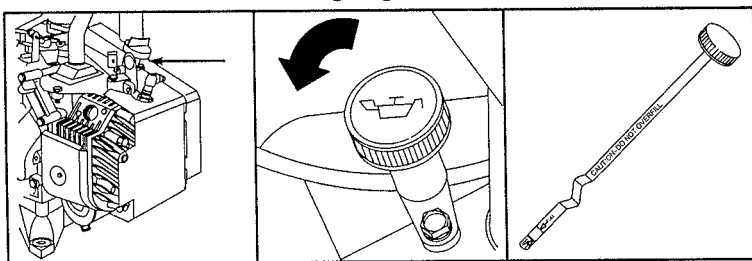

Place engine level  
Clean around oil fill

Remove dipstick  
Wipe with clean cloth

Tighten dipstick  
Remove and check



This engine will operate satisfactorily using any automobile gasoline. Use clean, fresh, lead-free gasoline with a minimum of 77 octane. (Leaded gasoline may be used if it is commercially available, and if lead-free is not available.) Purchase fuel in quantity that can be used within 30 days. See **STORAGE INSTRUCTIONS**, page 9.

Do not mix oil with gasoline.

**Note:** We do not recommend using gasoline which contains alcohol, such as gasohol. If gasoline with alcohol is used, it must contain less than 10% Ethanol and must be removed from engine during storage. Do not use gasoline which contains Methanol.

## Fuel level

Do not over-fill. Allow space in fuel tank for fuel expansion.

Oil capacity is about 1-1/2 quarts (48 ounces or 1.4 liters) if engine is not equipped with oil filter.

Oil capacity is about 1-3/4 quarts (56 ounces or 1.7 liters) if engine is equipped with oil filter.

**Note:** Oil capacity will be greater if engine is equipped with optional remote oil filter.  
 Start and run engine at idle for 30 seconds. Shut engine off. Wait 30 seconds and check oil level. Add oil to bring level to **Full** mark on dipstick, if required.

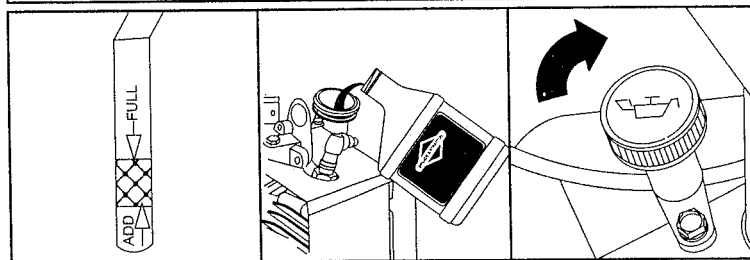

Oil level should be  
at FULL mark

If oil is required, add  
slowly - recheck

Tighten dipstick  
firmly before starting

In the USA and Canada, a 24 hour hot line, 1-800-233-3723, has a menu of pre-recorded messages offering you engine maintenance information.

## Before Starting

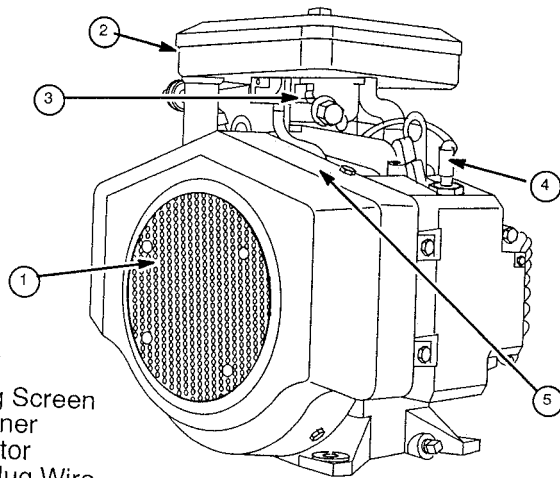

1. Rotating Screen
2. Air Cleaner
3. Carburetor
4. Spark Plug Wire
5. Engine Model

Model	Type	Code
xxxxx	xxxx xx	xxxxxxxx

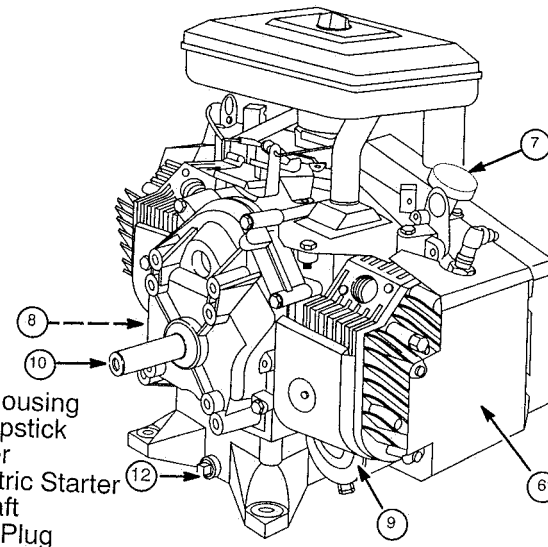

6. Blower Housing
7. Oil Fill/Dipstick
8. Fuel Filter
9. 12V Electric Starter
10. Crankshaft
11. Oil Drain Plug

### Tips to obtain best starting results

Start lawn mower on hard surface or over previously cut grass.  
Start, store and fuel lawn mower in level position.



Do not use a pressurized starting fluid. Starting fluid is flammable. Severe engine damage or fire may occur.

Slightly richer fuel mixture usually improves cold starting (below 40° F).  
See **CARBURETOR ADJUSTMENTS**, page 5.

### Cold weather starting hints

1. Use the correct oil for the starting temperature expected.
2. De-clutch all possible external loads.
3. Set speed control at part throttle position.
4. A warm battery has much more starting capacity than a cold battery.
5. Do not use gasoline left over from summer. Use fresh winter grade gasoline which has higher volatility to improve starting.

In the USA and Canada, a 24 hour hot line, 1-800-233-3723, has a menu of pre-recorded messages offering you engine maintenance information.

### OIL GARD® (optional)

If engine is run low on oil, the OIL GARD® will either activate a warning device or stop the engine. Add oil to engine. Fill to **FULL** mark on dipstick. Read the operating instructions supplied by the equipment manufacturer to determine which way your engine is equipped.

### Oil pressure switch (optional on engines with oil filter)

If engine is run low on oil, the pressure switch will either activate a warning device or stop the engine. (Read the operating instructions supplied by the equipment manufacturer to determine which way your engine is equipped.) Add oil to engine. Fill to **FULL** mark on dipstick.

# Starting & Stopping

## START ENGINE

**!** ALWAYS KEEP HANDS AND FEET CLEAR OF MOWER BLADE OR OTHER ROTATING MACHINERY.

### Fuel shut-off valve

Open fuel shut-off valve, if engine is so equipped.

### Throttle

Move throttle control to RUN or FAST position.

### Choke

Move choke control to CHOKE or START position.

**Note:** Choke must fully close. If engine does not start, see **Adjustments**, page 5.

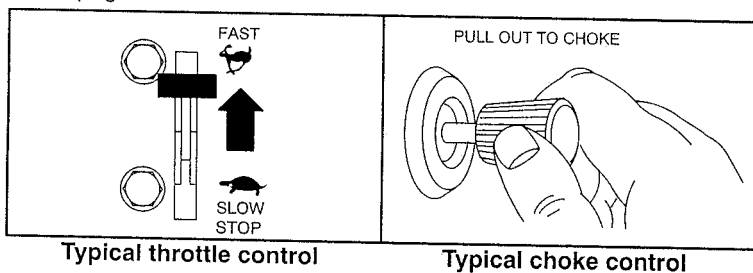

Typical throttle control

Typical choke control

### Rewind starter

**!** Grasp rope handle as illustrated and pull slowly until resistance is felt. THEN PULL CORD RAPIDLY TO OVERCOME COMPRESSION, PREVENT KICKBACK AND START ENGINE. Repeat if necessary with choke off and throttle control in FAST position. When engine starts, operate in FAST position.

### Rope starter

**!** Wind starter rope around pulley in direction shown by arrow. Pull rope handle slowly until resistance is felt, then pull with a quick full arm stroke to prevent kickback. Repeat if necessary with choke opened slightly. When engine starts, open choke gradually. When using rope starter to crank engine, use caution so knotted end of rope does not strike persons standing nearby.

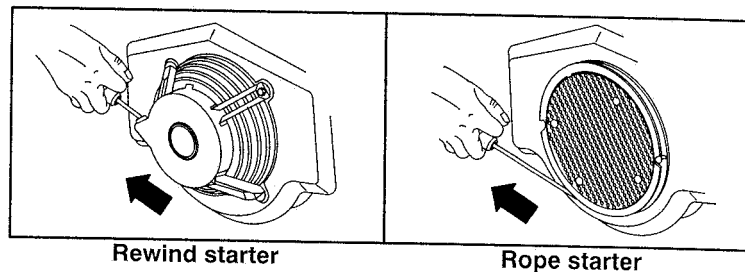

Rewind starter

Rope starter

### Electric starter (optional)

Turn key to START. Repeat if necessary with throttle control in FAST position. When engine starts, operate in FAST position.

**Note:** If equipment manufacturer has supplied battery, charge it before trying to start engine, as equipment manufacturer recommends. Use short starting cycles (15 secs. per min.) to prolong starter life. Extended cranking can damage starter motor.

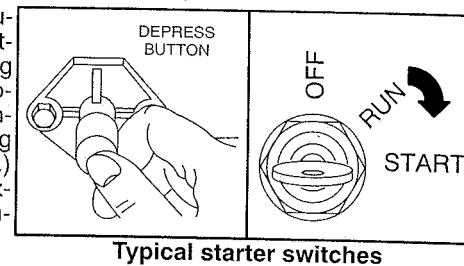

Typical starter switches

### STOP ENGINE

Do not move choke control to CHOKE position to stop engine. Backfire or engine damage may occur. Move throttle control to SLOW position, then to STOP, or turn key to OFF, if so equipped. Always remove key from switch when equipment is not in use or left unattended.

**!** Close fuel shut-off valve, when transporting engine, to prevent fuel leakage.

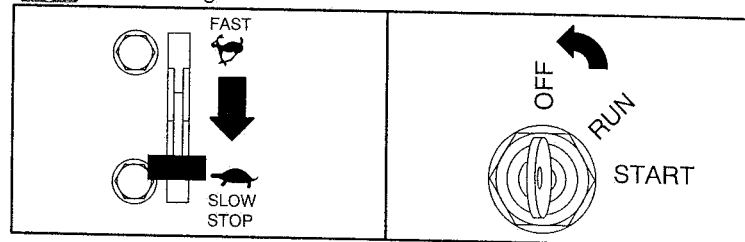

Typical stop switches

In the USA and Canada, a 24 hour hot line, 1-800-233-3723, has a menu of pre-recorded messages offering you engine maintenance information.

# Adjustments

## CONTROL ADJUSTMENTS



TO PREVENT ACCIDENTAL STARTING

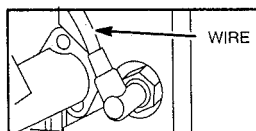

Remove spark plug wires and disconnect battery at negative terminal, when adjusting controls.

### To adjust choke control:

Remove air cleaner. Move choke control to CHOKE or START position. Carburetor choke should be completely closed. If not, loosen casing clamp screw. Then move casing, wire and engine choke lever until choke is completely closed. Tighten casing clamp screw. Replace air cleaner.

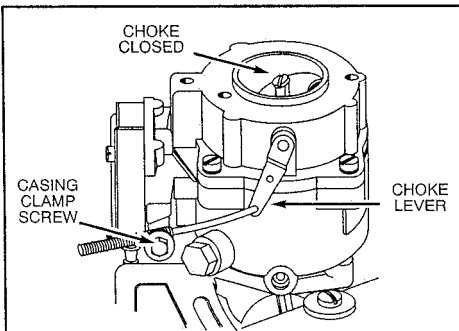

Choke control adjustment

### To adjust throttle control:

Remove air cleaner. Move throttle control to FAST position. Swivel should be against side of quarter circle. If not, loosen casing clamp screw. Move casing and wire in direction shown until swivel is against side of quarter circle. Tighten casing clamp screw. Replace air cleaner.

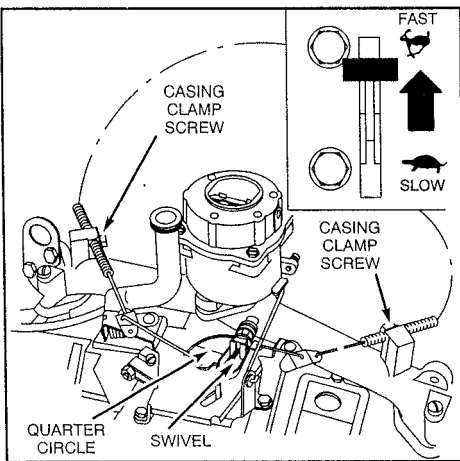

Throttle control adjustment

## CARBURETOR ADJUSTMENTS



The manufacturer of equipment on which this engine is installed specifies top speed at which engine will be operated. DO NOT EXCEED this speed.

Differences in fuel, temperature, altitude or load may require minor carburetor adjustment. Air cleaner and air cleaner cover must be assembled to carburetor before starting engine.

TWIN CYLINDER CARBURETOR ADJUSTMENT IS UNIQUE. ADJUST CARBURETOR FUEL MIXTURE IN ORDER STATED AS FOLLOWS.

### Initial adjustment

Gently turn idle mixture screw clockwise until it just closes (turning screw in too far may damage it). Next open idle mixture screw 1-1/2 turns counterclockwise. Start and warm up engine (approximately 5 minutes) prior to final adjustment.

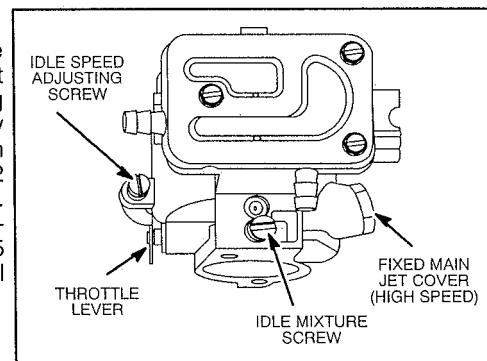

Carburetor adjustments

### Final adjustment

Place throttle control in IDLE or SLOW position. Rotate carburetor throttle lever against idle speed screw and hold. Adjust idle speed screw to obtain 1200 to 1400 RPM. While still holding carburetor throttle lever against idle speed screw, turn idle mixture screw slowly clockwise (lean mixture) until speed just starts to slow, and then slowly counterclockwise (rich mixture) until speed just starts to slow again. Now turn idle mixture screw to midpoint between rich and lean. Finally readjust idle speed to 900 to 1200 RPM. Release carburetor throttle lever. Move throttle control to FAST position. Engine should accelerate smoothly. If it does not, readjust idle mixture screw approximately 1/8 turn counterclockwise (rich).

In the USA and Canada, a 24 hour hot line, 1-800-233-3723, has a menu of pre-recorded messages offering you engine maintenance information.



# Maintenance

See *Maintenance Schedule*, page 8. Follow the hourly or calendar intervals, whichever occur first. Note that more frequent service is required when operating in adverse conditions.



## TO PREVENT ACCIDENTAL STARTING

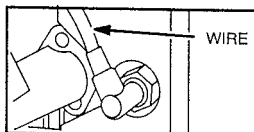

Remove spark plug wires and disconnect battery at negative terminal, when servicing engine or equipment.

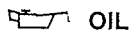

## OIL

### Check oil level regularly.

Be sure correct oil level is maintained. Check every 5 hours or daily, before starting engine. See **Check oil level** on page 2.

### Change oil (Follow *Maintenance Schedule*.)

Change oil after first 5 hours of operation. Remove drain plug and drain oil while engine is warm. Replace drain plug. Remove dipstick and refill with new oil of recommended grade (see chart on page 2). Start and run engine at idle for 30 seconds. Stop engine. Wait 30 seconds and re-check oil level. If required, add oil to bring level to **FULL** mark on dipstick.

**Note:** If engine is not equipped with oil filter, change oil every 25 hours. If engine is equipped with oil filter, change oil every 50 hours. Change oil more often if engine is operated under heavy load or high ambient temperatures.

### Change oil filter (Follow *Maintenance Schedule*.)

Replace oil filter after every 100 hours of operation. Remove used oil filter. Before installing new filter, lightly oil filter gasket with fresh, clean oil. Screw filter on by hand until gasket contacts oil filter adapter. Tighten 1/2 to 3/4 turn more. Start and run engine at idle to check for leaks. Stop engine. Re-check oil level. Add oil if required.

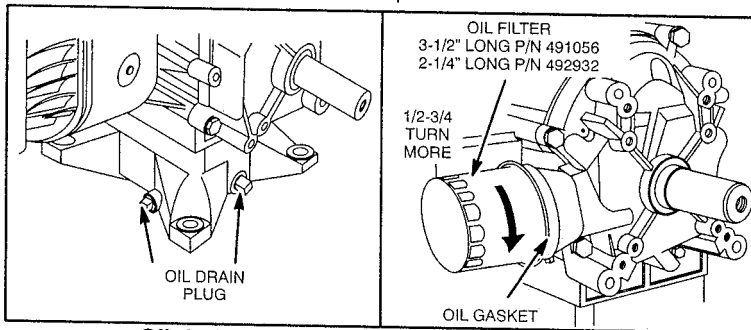

Oil drain

Oil filter

## Oil Pressure

Normal warm operating oil pressure for a pressure lube engine (engine with oil filter) is 10 to 50 psi at normal operating temperature. If pressure drops below normal range, stop engine and check oil level with dipstick. If oil level is low, add oil to bring level to **FULL** mark on dipstick. Restart engine and check oil pressure. If pressure is normal, operation may continue. If oil level is between **ADD** and **FULL** mark on dipstick, **DO NOT RESTART ENGINE**. Contact a Briggs & Stratton Service Dealer. **DO NOT OPERATE ENGINE UNTIL OIL PRESSURE IS CORRECTED.**

**Note:** Optional oil pressure gauge is supplied by manufacturer of equipment.



## AIR CLEANER

**Note:** Service according to *Maintenance Schedule*.

1. Remove knob and cover.
2. Carefully slide pre-cleaner off cartridge.

To service pre-cleaner, wash in liquid detergent and water. Squeeze dry in a clean cloth. Saturate in engine oil. Squeeze in clean, absorbent cloth to remove all **EXCESS** oil. Replace if very dirty or damaged.

3. Remove hex nut, washer and cartridge plate. Carefully remove cartridge to prevent debris from entering carburetor.

To service cartridge, clean by tapping gently on a flat surface. Do not oil cartridge. Replace if very dirty or damaged.

**Note:** Do not use petroleum solvents, e.g., kerosene, or pressurized air to clean cartridge. They can damage the cartridge.

4. Reinstall cartridge, cartridge plate and washer. Tighten hex nut securely.
5. Reassemble pre-cleaner on cartridge.
6. Replace cover and tighten knob securely.

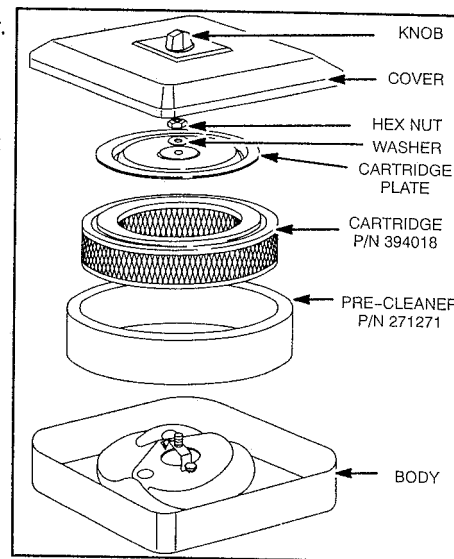

Dual element air cleaner

In the USA and Canada, a 24 hour hot line, 1-800-233-3723, has a menu of pre-recorded messages offering you engine maintenance information.

# Maintenance

See **Maintenance Schedule**, page 8. Follow the hourly or calendar intervals, whichever occur first. Note that more frequent service is required when operating in adverse conditions.

## KEEP ENGINE AND PARTS CLEAN

Remove dirt and debris with a cloth or brush. Do not clean with a forceful spray of water because water could contaminate fuel system.

Remove grass, chaff and dirt from debris guard or rotating screen daily or more often if needed to prevent engine damage caused by overheating.

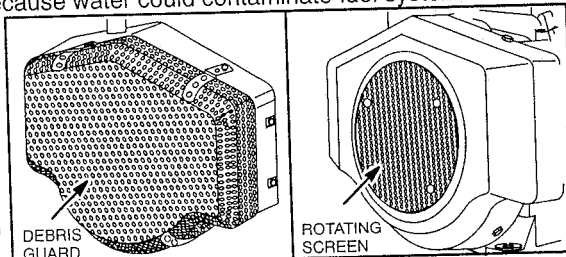

Debris guard

Rotating screen

To assure smooth operation, keep governor linkage, springs and controls free of debris.

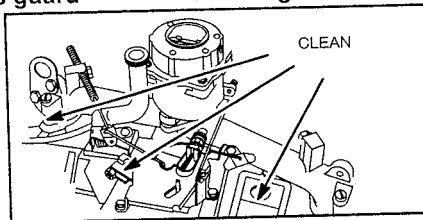

Linkage, springs & controls



Daily or more often, before running engine, clean muffler area to remove all grass and combustible debris.

If engine muffler(s) is/are equipped with spark arrester screens, remove for cleaning and inspection. Replace if damaged or plugged.

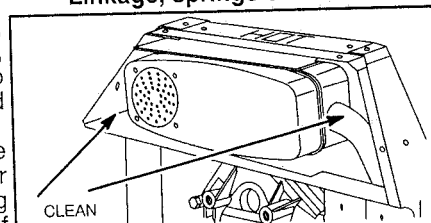

Muffler area/Spark arrester screens

Replace in-line fuel filter. See any Authorized Briggs & Stratton Dealer for correct replacement.



Drain fuel tank or close fuel shut-off valve before replacing fuel filter.

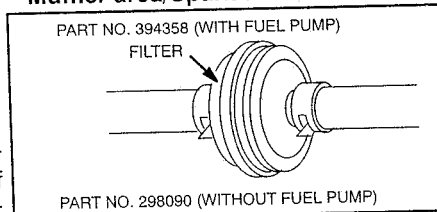

Fuel filter

Grass or chaff may clog the air cooling system, especially after prolonged operation cutting tall, dry grass. Clean area shown to prevent overheating and engine damage.

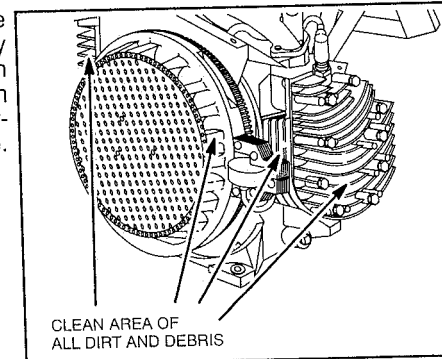

Air cooling system

Replace or clean spark plugs.



Use only Briggs & Stratton Spark Tester, P.N. 19368, to check for spark.

Arcing can occur if wire terminals do not fit firmly on spark plugs. Reform terminals if necessary.

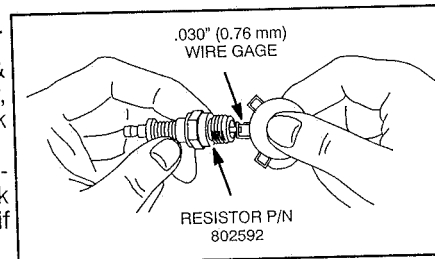

Spark plug

**Note:** In some areas, local law requires using resistor spark plug to suppress ignition signals. If this engine was originally equipped with resistor spark plug, use same type for replacement.

## Remove combustion deposits

Remove cylinder heads and cylinder head shields every 100-300 hours of operation. Scrape and wire brush combustion deposits from cylinders, cylinder heads, tops of pistons and around valves. Use a soft brush to remove deposits. Reassemble with new gaskets, cylinder heads and cylinder head shields. Turn screws down finger tight, with the three longer screws, if so equipped, around exhaust valve. Torque cylinder head screws in a staggered sequence to 165 in.-lbs. (18.65 Nm).

In the USA and Canada, a 24 hour hot line, 1-800-233-3723, has a menu of pre-recorded messages offering you engine maintenance information.

# Maintenance Schedule

Follow the hourly or calendar intervals, whichever occur first.  
More frequent service is required when operating in adverse conditions noted below

Maintenance Operation	Every 5 Hours or Daily	25 Hours or Every Season	50 Hours or Every Season	100 Hours or Every Season	100-300 Hours
Check Oil Level	●				
Change Oil ♦ (Engine without Oil Filter)		● Note 1			
Change Oil ♦ (Engine with Oil Filter)			● Note 1		
Change Oil Filter ♦				● Note 1	
Service Air Cleaner Pre-Cleaner		● Note 2			
Service Air Cleaner Cartridge				● Note 2	
Clean Cooling System				● Note 2	
Inspect Spark Arrester (Optional Accessory)			●		
Replace or Clean Spark Plugs & Replace In-Line Fuel Filter				●	
Clean Combustion Chamber Deposits					●

♦ Change oil after first 5 hours, then after every 50 hours or every season.  
**Note 1:** Change oil every 25 hours when operating under heavy load or in high temperatures.  
**Note 2:** Clean more often under dusty conditions or when airborne debris is present. Replace air cleaner parts, if very dirty.

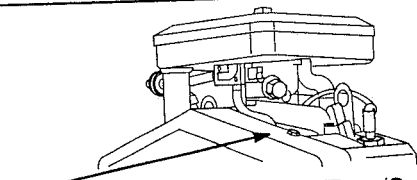

Look here for engine Model/Type/Code. This assures fast service & correct parts.

See any Authorized Briggs & Stratton Service Dealer and **Insist on Genuine Briggs & Stratton parts!** Non-original copies may not perform as well and may void your warranty.

### Briggs & Stratton Part Numbers of some Genuine Briggs & Stratton Parts:

Part	Briggs & Stratton Part No.
Air cleaner cartridge	394018
Air cleaner pre-cleaner	271271
Resistor spark plug	802592
Spark plug elbow	66538
Spark plug wrench	89838
Spark tester	19368
Oil	100005
Oil Filter (3-1/2 in. long)	491056
Oil Filter (2-1/4 in. long)	492932
Fuel filter (with fuel pump)	394358
Fuel filter (without fuel pump)	298090
Gas additive	5041
Gasket, Cylinder Head #1	271867
Gasket, Cylinder Head #2	271868

**To obtain a complete Parts List of Genuine Briggs & Stratton Parts for your engine, print your engine Model/Type/Code and your name and address below. Cut out and send (with \$2) to address on other side.**

Your Engine:    Model                    Type                    Code

\_\_\_\_\_

Name

\_\_\_\_\_

Address

\_\_\_\_\_

City, State, Zip

\_\_\_\_\_

In the USA and Canada, a 24 hour hot line, 1-800-233-3723, has a menu of pre-recorded messages offering you engine maintenance information.

## Service & Storage

### FOR SERVICE

See an Authorized Briggs & Stratton Service Dealer. Each carries a stock of Genuine Briggs & Stratton Parts and is equipped with special service tools. Trained mechanics assure expert repair service on all Briggs & Stratton engines. Only dealers advertising as "Authorized Briggs & Stratton" are required to meet Briggs & Stratton standards.



You may locate your nearest Authorized Briggs & Stratton Service Dealer in the "Yellow Pages™" directory under "Engines, Gasoline," "Gasoline Engines," "Lawn Mowers" or similar category. There are over 30,000 Authorized Service Dealers worldwide available to serve you.

Note: Walking fingers logo and "Yellow Pages" are registered trademarks in various jurisdictions.

The illustrated shop manual shown here includes "Theories of Operation," common specifications and detailed information covering adjustment, tune-up and repair of Briggs & Stratton L-head, twin cylinder, 4 cycle engines. It is available from an Authorized Briggs & Stratton Service Dealer or you can order it from the factory. Write: Briggs & Stratton Corp. P. O. Box 1144, Milwaukee, WI 53201 Attention: Service Division.

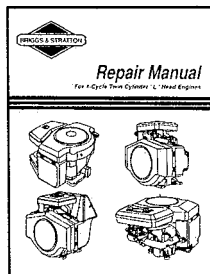

Part No. 271172

### STORAGE INSTRUCTIONS

Engines stored over 30 days need to be protected or drained of fuel to prevent gum from forming in fuel system or on essential carburetor parts.

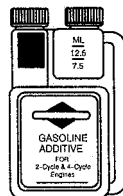

1. For engine protection, we recommend use of Briggs & Stratton Gasoline Additive, Part No. 5041, available from any Authorized Briggs & Stratton Service Dealer. Mix Additive with fuel in fuel tank or storage container. Run engine for a short time to circulate Additive through carburetor. Engine and fuel can be stored up to 24 months.

**Note:** If Additive is not used or if engine is operating on gasoline containing alcohol, such as gasohol, remove all fuel from tank and run engine until it stops from lack of fuel.

2. While engine is still warm, drain oil from crankcase (see page 6). Refill with fresh oil of recommended grade (see chart on page 2).
3. Remove spark plugs and pour about 1 oz (30 ml) of engine oil into each cylinder. Replace spark plugs and crank slowly to distribute oil.
4. Clean dirt and chaff from cylinders, cylinder head fins, blower housing, rotating screen and muffler areas (see page 7).
5. Store in a clean and dry area, but NOT near a stove, furnace or water heater which uses a pilot light or any device that can create a spark.

**Send to: Briggs & Stratton Corporation  
P.O. Box 1144  
Milwaukee, WI 53201-1144**

**Att. Service Division**



**Only Genuine  
Briggs & Stratton Parts  
have the  
Briggs & Stratton logo!**

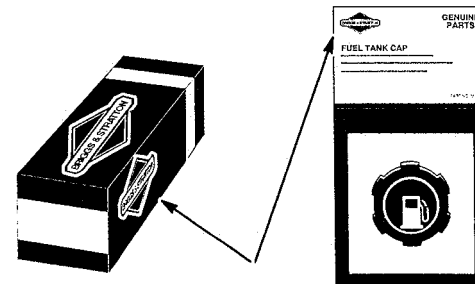

**Look for Briggs & Stratton logo  
stamped on part and/or package!**

In the USA and Canada, a 24 hour hot line, 1-800-233-3723, has a menu of pre-recorded messages offering you engine maintenance information.

**ABOUT YOUR ENGINE WARRANTY: (see back cover for statement of LIMITED WARRANTY.)**

If warranty service is needed, contact your nearest Authorized Briggs & Stratton Service Dealer. For prompt attention, your Dealer will need to know the engine model, type and code numbers, the trouble experienced and the total number of hours the engine was run.

BRIGGS & STRATTON WARRANTY COVERS ONLY DEFECTIVE MATERIAL AND/OR WORKMANSHIP.

Briggs & Stratton Corporation welcomes the opportunity to make justified warranty repairs by any of its Authorized Service Dealers. In most instances, the requests for warranty repair are handled in a quick and routine manner. However, some requests for warranty are received which appear not justified. In these cases, though engine owners may not be aware of it, the premature failure of their engine was caused by abuse or neglect, or equipment on which it was mounted, rather than the engine.

If you differ with the decision of your Authorized Service Dealer, an investigation will be made to determine the applicability of warranty. Ask the Authorized Service Dealer to submit all supporting facts to the Factory for review. If the Factory decides that your claim is justified, you will be fully reimbursed for those items accepted as defective. To avoid misunderstanding which might occur between engine owners and Authorized Briggs & Stratton Service Dealers, we list below some of the causes of engine failure that Briggs & Stratton warranty does not cover for repair or replacement.

**Normal Wear:** Engines, like all mechanical devices, need periodic parts service and replacement to perform well. Warranty will not cover repair when normal use has exhausted the life of a part or an engine.

**Improper Maintenance:** Remember that the service life of an engine depends upon the conditions under which it operates and the care it receives. Some applications, such as tillers, pumps and rotary mowers, are very often used in dusty or dirty conditions which can cause what appears to be premature wear. Such wear, when caused by dirt, dust, spark plug cleaning grit or other abrasive material that has entered the engine because of improper maintenance, is not covered by warranty.

**Warranty does not apply to engine adjustment or repair required due to:**

1. THE USE OF PARTS THAT ARE NOT ORIGINAL BRIGGS & STRATTON PARTS OR PARTS THAT ARE NOT APPROVED BY BRIGGS & STRATTON.
2. Equipment controls or installations that prevent starting, cause unsatisfactory engine performance, or shorten engine life. (Contact equipment manufacturer.)
3. Leaking carburetors, clogged fuel pipes, sticking valves, or other damage, caused by using contaminated or stale fuel. (Use clean, fresh, lead-free gasoline and Briggs & Stratton gasoline stabilizer Part No. 5041.)
4. Parts which are scored or broken because an engine was operated with insufficient or contaminated lubricating oil, or an incorrect grade of lubricating oil. (4

cycle engines: check oil level daily or after every 8 hours of operation. Refill when necessary and change at recommended intervals. (2 cycle engines: use correct mixture of gasoline and BIA/NMMA certified oil.) Read owner's manual.

5. Repair or adjustment of associated parts or assemblies such as clutches, transmissions, remote controls, etc., which are not of Briggs & Stratton manufacture.
6. Damage or wear to parts caused by dirt which entered the engine because of improper air cleaner maintenance, re-assembly or using a non-original air cleaner element. (At recommended intervals, clean and re-oil the oil-foam® element or the foam pre-cleaner and replace the cartridge.)
7. Parts damaged by over-speeding or overheating caused by grass, debris or dirt plugging the cooling fins and clogging the flywheel area, or caused by operating the engine in a confined area without sufficient ventilation (Clean fins on the cylinder, cylinder head and flywheel at recommended intervals.)
8. Engine or equipment parts broken by excessive vibration caused by loose engine mounting, loose cutter blades, unbalanced blades or impellers, improperly attaching equipment to engine crankshaft, over-speeding or abuse in operation.
9. A bent or broken crankshaft, caused by striking a solid object with the cutter blade of a rotary lawn mower, or excessive vee belt tightness.
10. Routine tune-up or adjustment needed by an engine but not caused by defective material nor workmanship (Follow the "Owner's Manual" when making any minor adjustments.)
11. Failure of the combustion chamber valves, valve seats, valve guides or burned starter motor windings, which occur when operating an engine with alternate fuels such as, liquified petroleum, natural gas, altered gasolines, etc.

Warranty is available only through service dealers which have been authorized by the Briggs & Stratton Corporation. Your nearest Authorized Service Dealer is listed in the "yellow pages™" of your telephone directory, under "engines, gasoline" or "gasoline engines," "lawn mowers" or similar category.

In cases where an engine owner insists on Warranty repair, and our Authorized Service Dealer does not feel Warranty is justified, it is suggested that repair be completed and the owner charged. A Warranty Claim, with full details, should be forwarded to the Factory for decision. Mark the Claim "Questionable Warranty - Customer charged." If Warranty is approved, credit will be issued to the account who performed repair, and the Authorized Service Dealer will reimburse the customer. If Warranty is not in order, the Factory will advise the Authorized Service Dealer accordingly. If the Authorized Service Dealer requests the Factory to do so, a copy of the letter can be mailed to the engine owner.

Briggs & Stratton Engines Are Made Under One Or More Of The Following Patents: Design D-247,177 (Other Patents Pending)

5,077,343	5,038,727	4,996,956	4,909,218	4,694,792	4,414,993	4,205,737	4,048,788	4,003,190
5,070,851	5,038,064	4,995,357	4,895,119	4,684,917	4,414,934	4,189,040	4,048,787	3,991,152
5,070,829	5,031,587	4,986,228	4,889,006	4,633,556	4,372,433	4,188,930	4,037,389	3,981,289
5,058,544	5,024,204	4,984,543	4,875,448	4,630,498	4,355,253	4,181,206	4,031,872	3,971,353
5,058,542	5,022,495	4,977,879	4,823,752	4,622,935	4,353,335	4,178,894	4,023,550	3,970,913
5,050,371	5,014,897	4,977,877	4,819,593	4,522,080	4,345,885	4,168,808	4,014,302	3,968,854
5,048,502	5,014,605	4,971,219	4,817,577	4,520,288	4,306,522	4,168,288	4,014,195	3,961,724
5,046,373	5,009,208	4,971,001	4,745,895	4,512,499	4,270,509	4,090,345	4,013,105	3,958,906
5,040,644	5,007,573	4,939,916	4,720,638	4,453,507	4,233,534	4,068,636	4,011,533	3,955,904
5,040,503	5,007,388	4,915,068	4,719,682	4,430,984	4,233,043	4,055,898	4,006,616	3,951,223

In the USA and Canada, a 24 hour hot line, 1-800-233-3723, has a menu of pre-recorded messages offering you engine maintenance information.

**Superseding Warranty**  
**BRIGGS & STRATTON ENGINE WARRANTY POLICY**  
 effective September 1, 1992  
 Replaces all undated previous Warranties and all Warranties  
 dated before September 1, 1992

When warranty repair is justified, Briggs & Stratton Corporation welcomes such repair by any of its Authorized Service Dealers. In most instances, the requests for warranty brought to the attention of our Service Accounts are handled in a prompt routine manner with no question regarding their validity. However, some requests for warranty are received which appear not justified. In these cases, engine owners may not be aware that the premature failure of their engine was the result of abuse or neglect, or that the difficulty which they experience is caused by the equipment rather than the engine.

**BRIGGS & STRATTON WARRANTY COVERS ONLY DEFECTIVE MATERIAL AND/OR WORKMANSHIP.**

**LIMITED WARRANTY**

"For time period shown below from date of purchase, Briggs & Stratton Corporation will replace for the original purchasers, free of charge, any part, or parts of the engine, found upon examination by any Factory Authorized Service Dealer, or by the Factory at Milwaukee, Wisconsin, to be defective in material or workmanship or both; this is the exclusive remedy. All transportation charges on parts submitted for replacement under this Warranty must be borne by purchaser. For warranty service, contact your nearest Authorized Service Dealer as listed in the 'Yellow Pages™' under 'Engines, Gasoline,' or 'Gasoline Engines,' 'Lawn Mower' or similar category. THERE IS NO OTHER EXPRESS WARRANTY. IMPLIED WARRANTIES, INCLUDING THOSE OF MERCHANTABILITY AND FITNESS FOR A PARTICULAR PURPOSE ARE LIMITED TO ONE YEAR FROM PURCHASE, AND TO THE EXTENT PERMITTED BY LAW ANY AND ALL IMPLIED WARRANTIES ARE EXCLUDED. LIABILITY FOR CONSEQUENTIAL DAMAGES UNDER ANY AND ALL WARRANTIES ARE EXCLUDED TO THE EXTENT EXCLUSION IS PERMITTED BY LAW. Some states do not allow limitations on how long an implied warranty lasts, and some states do not allow the exclusion of limitation of incidental or consequential damages, so the above limitation and exclusion may not apply to you. This warranty gives you specific legal rights and you may also have other rights which vary from state to state."

Briggs & Stratton Corporation  
 F. P. Stratton, Jr.  
 Chairman and Chief Executive Officer

**WARRANTY PERIOD**

ENGINES	WITHIN U.S.A. AND CANADA		OUTSIDE U.S.A. AND CANADA
	CONSUMER USE*	COMMERCIAL USE*	ALL USES
All 2 thru 18 HP engines installed on equipment other than lawn mowers, edgers, tillers, and all Sno/Gard engines.	1 year-engine and Magnetron® ignition	1 year-engine and Magnetron® ignition	1 year-engine and Magnetron® ignition
All 2 thru 18 HP engines installed on lawn mowers, edgers, tillers, and all Sno/Gard engines.	2 year-engine 5 year-Magnetron® ignition	1 year-engine and Magnetron® ignition	1 year-engine and Magnetron® ignition
All Vanguard™, I/C® and Industrial Plus™ engines.	2 year-engine Lifetime** - Magnetron® ignition	2 year-engine Lifetime** - Magnetron® ignition	2 year-engine Lifetime** - Magnetron® ignition

\* For purposes of this warranty policy, "consumer use" shall mean personal residential household use by the original retail consumer. "Commercial use" shall mean all other uses, including use for commercial, income producing or rental purposes. Once an engine has experienced commercial use, it shall thereafter be considered as a commercial use engine for purposes of this warranty policy.

\*\* Lifetime limited warranty of the Magnetron® ignition shall cover parts and labor for the first five (5) years from the date of purchase; thereafter only parts. "Lifetime" shall mean lifetime of the engine in the hands of the original purchaser.

**No registration (warranty) card is necessary to obtain warranty on Briggs & Stratton engines.**  
**The customer must save the purchase receipt. A proof of purchase date will be required to obtain warranty.**

## Free Manuals Download Website

<http://myh66.com>

<http://usermanuals.us>

<http://www.somanuals.com>

<http://www.4manuals.cc>

<http://www.manual-lib.com>

<http://www.404manual.com>

<http://www.luxmanual.com>

<http://aubethermostatmanual.com>

Golf course search by state

<http://golfingnear.com>

Email search by domain

<http://emailbydomain.com>

Auto manuals search

<http://auto.somanuals.com>

TV manuals search

<http://tv.somanuals.com>