

P/N. MD4206U-01

Edition 1  
June 2004

# Century Falcon 4D User Manual

## Table of Contents



## **FCC COMPLIANCE STATEMENT FOR AMERICAN USERS**

This equipment has been tested and found to comply with the limits for a CLASS A digital device, pursuant to Part 15 of the FCC Rules. These limits are designed to provide reasonable protection against harmful interference when the equipment is operated in a commercial environment. This equipment generates, uses, and can radiate radio frequency energy and, if not installed and used in accordance with the instructions, may cause harmful interference to radio communications. Operation of this equipment in a residential area is likely to cause harmful interference in which case the user will be required to correct the interference at his/her own expense.

## **EMS AND EMI COMPLIANCE STATEMENT FOR EUROPEAN USERS**

This equipment has been tested and passed with the requirements relating to electromagnetic compatibility based on the standards EN50081-1 (EN55022 CLASS A) and EN61000-4-2/-3/-4/-5/-6/-8/-11 (IEC Teil 2,3,4). The equipment also tested and passed in accordance with the European Standard EN55022 for the both Radiated and Conducted emissions limits.

## **FALCON 4D Serial TO WHICH THIS DECLARATION RELATES IS IN CONFORMITY WITH THE FOLLOWING STANDARDS**

EN55022 : 1998, CISPR 22 , Class A / EN55024 : 1998 IEC 61000-4 Serial / EN61000-3-2 : 2000 / EN 61000-3-3 : 1995 / CRF 47, Part 15/CISPR 22 3rd Edition : 1997, Class A / ANSI C63.4 : 2001 / CNS 13438, CISPR 22(Class A) / IEC60950 3rd Edition (1999) / GB4943 : 2001 / GB9254 : 1998 / GB17625.1 : 2003

### **CAUTION**

Danger of explosion if battery is incorrectly replaced

Replace only with the equivalent type recommended by the manufacture.

Dispose of used batteries according to the manufacturer's instructions.

Specifications are subject to change without notice.

<b>WARRANTY INFORMATION .....</b>	<b>II</b>
<b>CHAPTER 1 – BARCODE PRINTER .....</b>	<b>1</b>
1-1 Introduction.....	1
1-2 Printer Models .....	1
1-3 Printer Accessories.....	1
1-4 General Specifications.....	2
1-5 Communication Interface.....	3
1-6 Printer Parts.....	4
<b>CHAPTER 2 – PRINTER INSTALLATION.....</b>	<b>5</b>
2-1 Ribbon Installation.....	5
2-2 Label Installation.....	6
2-3 Label Roll Core Installation Instruction .....	7
2-4 Card / Hang tags Installation .....	8
2-5 USB Installation .....	8
2-6 USB Uninstallation.....	10
2-7 PC Connection .....	11
<b>CHAPTER 3 – OPTIONS INSTALLATION .....</b>	<b>12</b>
3-1 Stripper Parts.....	12
3-2 Stripper Installation.....	12
3-3 Stripper Installation Diagram .....	14
3-4 Cutter Parts .....	15
3-5 Cutter Installation.....	15
3-6 Extended Memory Parts .....	17
3-7 Extended Memory Installation .....	18
3-8 Ethernet Parts.....	19
3-9 Ethernet Installation.....	19
<b>CHAPTER 4 – LED MESSAGE DESCRIPTION .....</b>	<b>21</b>
4-1 LED Status .....	21
4-2 General Operation .....	21
4-3 Self-Test .....	21
4-4 Dump Mode.....	23
4-5 Auto Sensing .....	23
4-6 Direct Thermal / Thermal Transfer Mode Switch.....	23
4-7 Error Messages .....	24
<b>CHAPTER 5 – MAINTENANCE AND ADJUSTMENT .....</b>	<b>25</b>
5-1 Thermal Print Head Cleaning .....	25
5-2 Thermal Print Head Balance Adjustment .....	25
5-3 Print Line Adjustment .....	26
5-4 Adjust the Cutter.....	26
5-5 Troubleshooting.....	27

# Chapter 1 - Barcode Printer

## 1-1. Introduction

The Century Systems FALCON 4D series is a desktop thermal transfer / direct thermal label printer. With plastic outer casing, the FALCON 4D series is designed to be a lightweight and a low cost printer for large variety of printing requirement. Its features are as follows:

- ◆ Direct Thermal and Thermal Transfer Printing Mode
- ◆ Print head density of 8 dots or 12dots per mm (203 or 300 dots per inch)
- ◆ Memory for label, graphics, and fonts download (approximately 100KB)
- ◆ Optional Real Time Clock for time recording and tracking
- ◆ Internal 5" (125mm) label roll capacity and 300M (Max O.D. 64mm) ribbon length (1" core size)
- ◆ Standard 2MB RAM for Maximum 68" print length
- ◆ Optional stripper module for label
- ◆ Optional cutter for ticketing or receipt printing applications
- ◆ Free Bundle of label editing software QLabel III

## 1-2. Printer Models

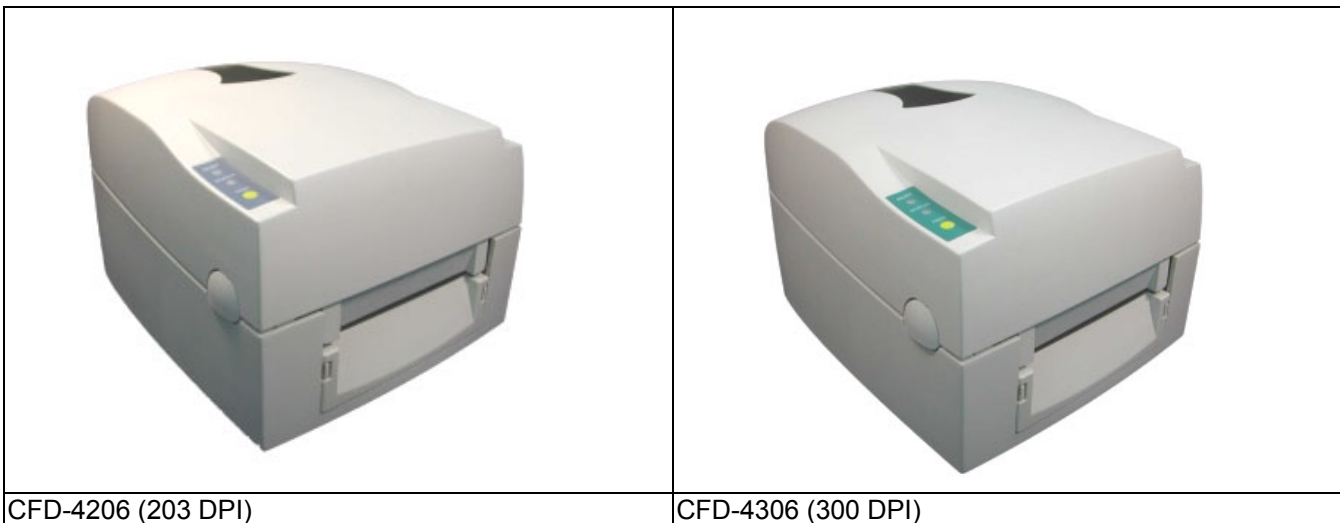

## 1-3. Printer Accessories

After unpacking, please check the accessories that come with the package, and store them appropriately.

Barcode Printer	Power Cables (110V and 230V)	Switching Power Adapter
Parallel Port Cable	Serial Port Cable (Optional)	USB Cable
Label Roll Core	Ribbon Shaft (2pcs)	Empty Roll Core
Label Roll Sample	Ribbon Roll Sample	Quick Start Guide
CD (including Software/Manual/Driver/DLL)		
Print Head Cleaning Card	15. Warranty Card / Warranty Information	

**\* If a different power supply is used with the printer which has caused damages to the printer itself, then this is not covered as part of the product warranty.**

## 1-4. General Specifications

Model Name	<b>CFD-4206</b>	<b>CFD-4306</b>
Resolution	203 dpi (8 dot/mm)	300 dpi (12 dot/mm)
Print Mode	Thermal Transfer / Direct Thermal	Thermal Transfer / Direct Thermal
CPU	16 Bit	
Sensor Location	Moveable, center aligned	
Sensor Type	Reflective	
Sensor Detection	Type: Label gap, black mark, and punch hole sensing. Detection: Label length auto sensing and / or program command setting	
Print Speed	2~4 IPS Standard 5~6 IPS can be achieved (media dependant)	2~3 IPS
Print Length	Min. 12mm (0.47"); Max. 1727mm (68")	Min. 12mm (0.47"); Max. 762mm (30")
Print Width	104mm (4.10")	104mm (4.10")
Media	Label Roll OD: Max. 127mm (5") Core Diameter: 1", 1.5", 3" Width: 25mm (1") ~ 118mm (4.65") Thickness: 0.06~0.3mm (0.0025"~0.012")	
Ribbon	Length: 300M (981 ft) Max. ribbon roll OD: 64mm (2.52") Type: transfer ribbons (wax, hybrid, and resin) in widths of 30mm to 110mm (1.88" to 4.33") Core Inner Diameter: 25.4mm (1")	
Printer Language	EZPL; Firmware Downloadable	
Software	Application: QLabel-III DLL & Driver: Microsoft Windows 95, 98, Me, NT 4.0, 2000 and XP	
Resident Fonts	9 resident alphanumeric fonts (included OCR A & B) those are expandable 8 times horizontally and vertically. All fonts in 8 directions rotation. 6,8,10,12,14,18,24,30 points	
Fonts Download	Windows Bit-map fonts and Asian fonts downloadable. All fonts in 8 directions rotation.	
Image Handling	PCX, BMP (With QLabel Software Supporting ICO, WMF, JPG, EMF).	
Barcode	Code 39, Code 93, Code 128 (subset A, B, C), UCC/EAN-128 K-Mart, UCC/EAN-128, UPC A / E (add on 2 & 5), I 2 of 5, I 2 of 5 with Shipping Bearer Bars, EAN 8 / 13 (add on 2 & 5), Codabar, Post NET, EAN 128, DUN 14, MaxiCode, HIBC, Plessey, Random Weight, Telepen, FIM, China Postal Code, RPS 128, PDF417 & Datamatrix code (QR code available)	
Interface	Serial, Parallel, USB	
Interface Transmission	Baud rate 4800 ~ 38400, XON/XOFF, DSR/DTR	
Memory	DRAM: 2MB, FLASH: 1MB	
LED Display	LED * 2, Bi-Color Function Key * 1, FEED	
Power	Auto Switching 100/240VAC, 50/60 Hz	
Environment	Operation: 40°F to 104°F (5°C to 40°C) Storage: -40°F to 122°F (-20°C to 50°C)	
Humidity	Operation: 30-85%, non-condensing. Free air. Storage: 10-90%, non-condensing. Free air.	
Cert. Approval	CE, FCC Class A, CCC, CB, CUL, BSMI	
Printer Dimension	Length: 285mm (11.2") Height: 171mm (6.8") Width: 226mm (8.9") Weight: 2.72Kg	
Options	Rotary Cutter Module Stripper Module 1MB Flash Expansion Card + RTC (Real Time Clock) 2 MB Flash Expansion Card + RTC (Real Time Clock) Internal Ethernet Adapter Card	

Specifications are subject to change without notice.

## 1-5. Communication Interface

### Parallel Interface

Interface cable : Parallel cable compatible with IBM PC

Pin out : See below

PIN NO.	FUNCTION	TRANSMITTER
1	/Strobe	host / printer
2-9	Data 0-7	host
10	/Acknowledge	printer
11	Busy	printer
12	/Paper empty	printer
13	/Select	printer
14	/Auto-Linefeed	host / printer
15	N/C	
16	Signal Gnd	
17	Chassis Gnd	
18	+5V,max 500mA	
19-30	Signal Gnd	host
31	/Initialize	host / printer
32	/Error	printer
33	Signal Ground	
34-35	N/C	
36	/Select-in	host / printer

### Serial Interface

Serial Default Setting : 9600 baud rate, no parity, 8 data bits, 1 stop bit, XON/XOFF protocol and RTS/CTS

#### RS232 HOUSING (9-pin to 9-pin)

DB9 SOCKET			DB9 PLUG
---	1	1	+5V,max 500mA
RXD	2	2	TXD
TXD	3	3	RXD
DTR	4	4	DSR
GND	5	5	GND
DSR	6	6	DTR
RTS	7	7	N/C
CTS	8	8	RTS
RI	9	9	N/C
PC			PRINTER

NOTE: The total voltage output from parallel port and serial port altogether can not exceed 500mA.

### USB Interface

Connector Type : Type B

PIN NO.	1	2	3	4
FUNCTION	USBVCC	D-	D+	GND

## 1-6. Printer Parts

Please use the following diagrams to identify each printer part.

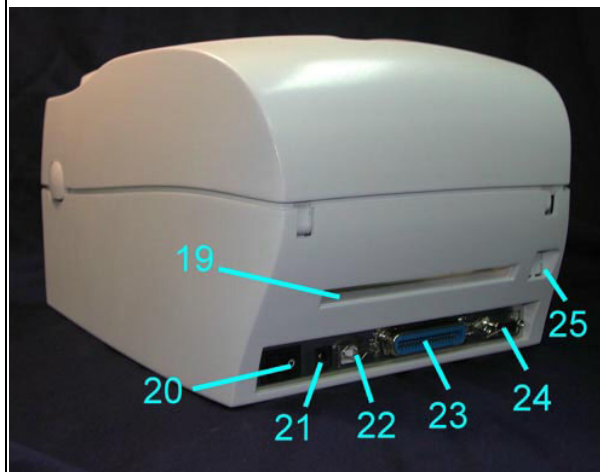
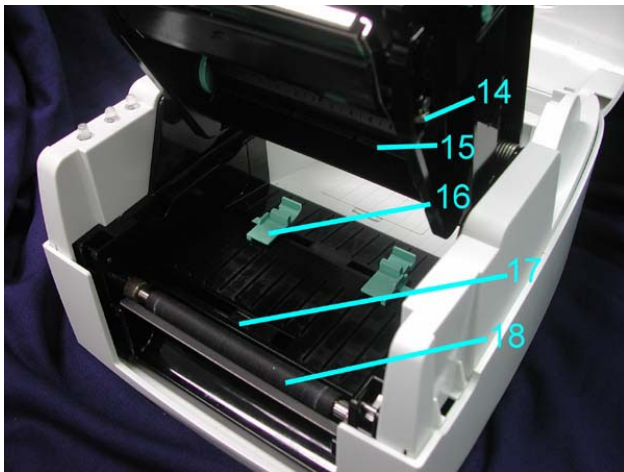
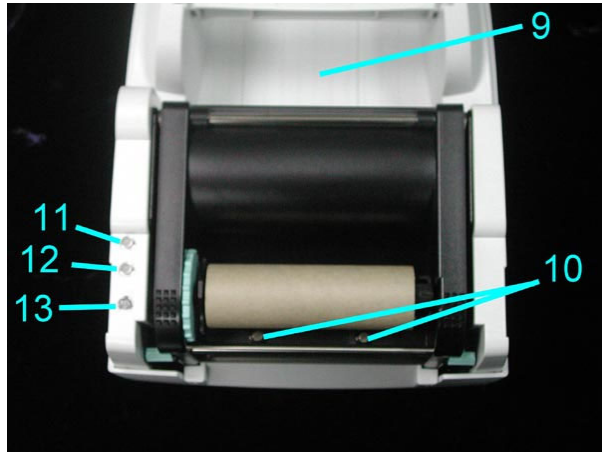
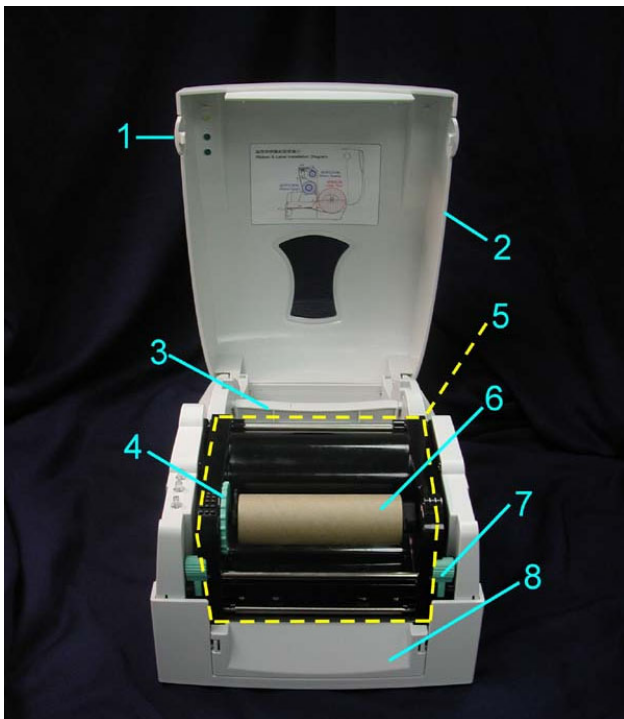



1	Cover Open Button	11	LED Light (Ready)	21	Power Socket
2	Top Cover	12	LED Light (Status)	22	USB Port
3	Label Roll Core	13	FEED Key	23	Parallel Port
4	Ribbon Rewind Wheel	14	Print Line Adj. Gear	24	Serial Port
5	Print Mechanism	15	Ribbon Supply Shaft	25	Ethernet Socket (Option)
6	Ribbon Rewind Shaft + Empty Ribbon Take Up Core	16	Label Guide		
7	Locking Tenon (left/right)	17	Label Sensor		
8	Front Cover Piece	18	Platen Roller		
9	Memory Card Cover	19	Fan-Fold Label Insert		
10	Print Head Pressure Adj. Screw (left/right)	20	Power Switch		

# Chapter 2 - Printer Installation

This printer model has the following print modes:



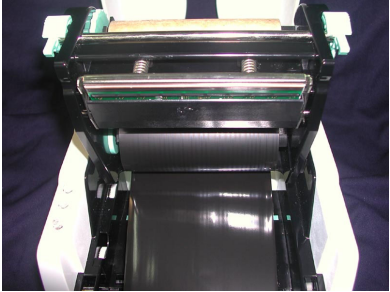
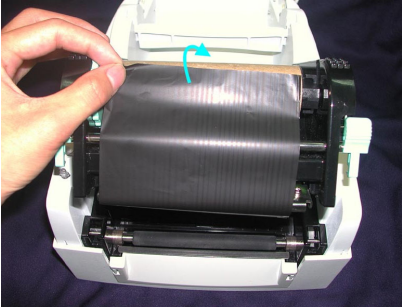
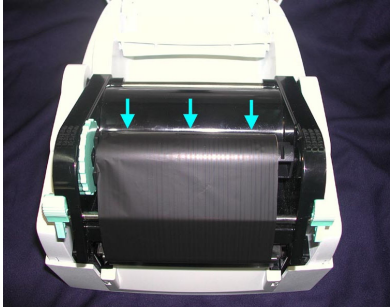
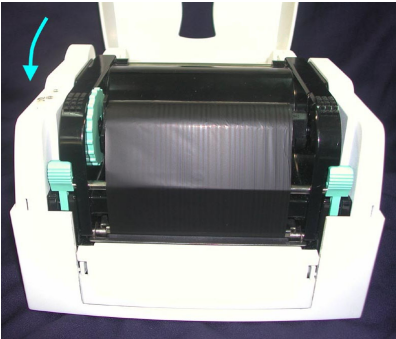

Thermal Transfer (TT):	When printing, ribbon must be installed to transfer the print contents onto the media.
Direct Thermal (DT):	When printing, no ribbon is necessary; it only requires direct thermal media.

## 2-1. Ribbon Installation

<p>1. Place the printer onto a smooth surface, and open the top cover.</p>	 A top-down view of the printer with its top cover open. Two red arrows point to the hinges on either side of the cover.
<p>2. Loosen and then lift the upper print mechanism by pressing the locking tenons. 3. Take out the ribbon supply shaft and rewind shaft. 4. Place the new ribbon roll onto the ribbon supply shaft.</p>	  Two side-view photographs. The left one shows hands pressing green locking tenons on the sides of the upper print mechanism. A blue arrow points to the right, where the second photo shows the upper mechanism lifted and a ribbon roll placed onto the supply shaft.
<p>5. Feed the ribbon from the Ribbon Supply Shaft under the Print Head. 6. Wrap the ribbon around the Ribbon Shaft and stick the ribbon onto the Empty Ribbon Roll Core.</p>	  Two side-view photographs. The left one shows a hand feeding a ribbon from the supply shaft under the print head. A red arrow indicates the direction. A blue arrow points to the right, where the second photo shows the ribbon wrapped around a shaft. Three red arrows point to the ribbon's position.
<p>7. Firmly close the upper print mechanism.</p>	 A top-down view of the printer with the upper print mechanism closed. A red arrow points to the top cover hinge.

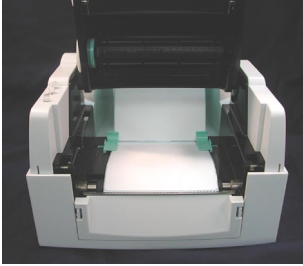

## 2-2. Label Installation

<p>1. Open the top cover.</p>	
<p>2. Place the label roll onto the Label Roll Core,</p>	
<p>3. Loosen and lift the upper print mechanism by pressing the locking tenons.</p>	
<p>4. Feed the label through the two Label Guides to the Tear-off Bar. 5. Align the label guides to the label edge.</p>	
<p>6. Close the upper print mechanism from the top to finish label installation.</p>	

## 2-3 Label Roll Core Installation Instruction

(A) 1" roll core installation instruction

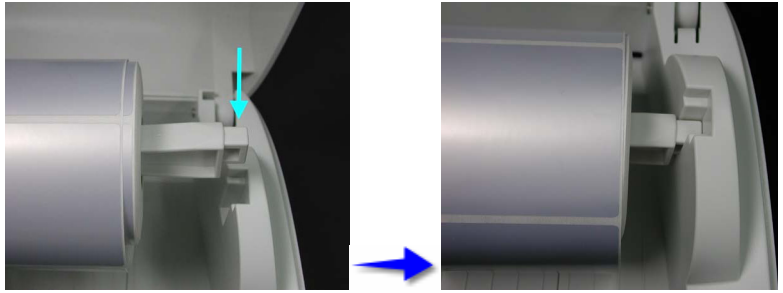
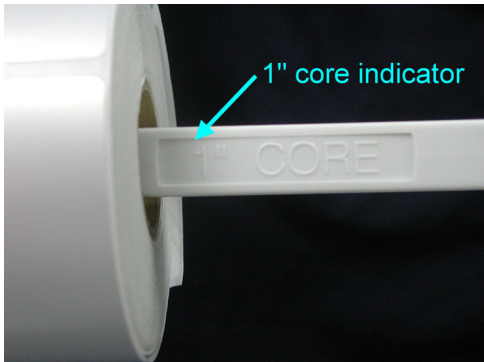

(B) 1.5" roll core installation instruction

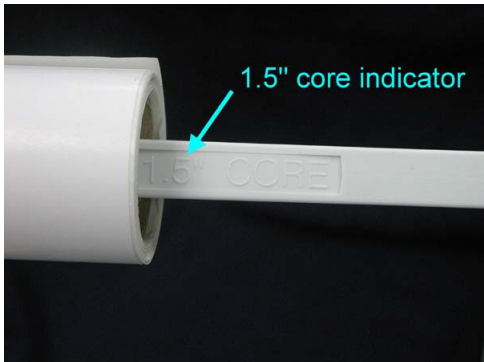

(C) 3" roll core installation instruction

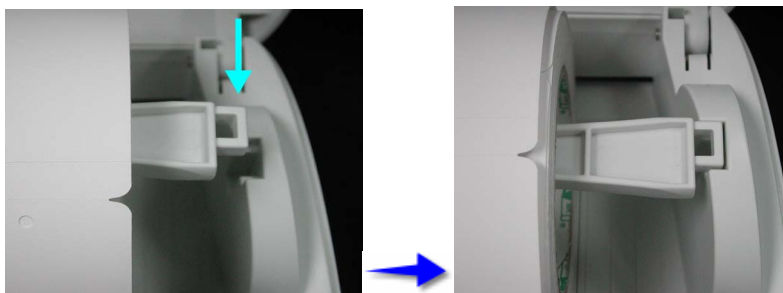
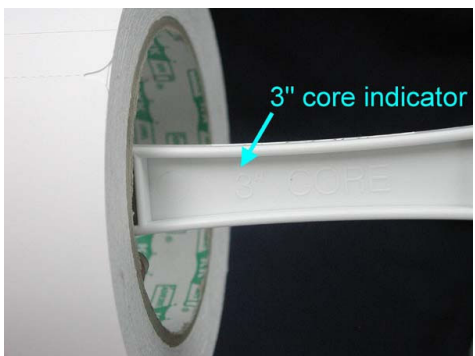

## 2-4 Card / Hang tags Installation

When installing cord tags, the tag hole must align with the sensor arrow (as indicated in Photo 1), then use the Label Guide to secure the tags.

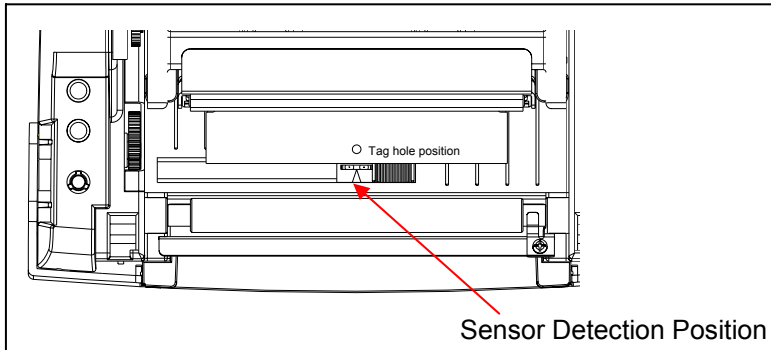

(Photo 1)

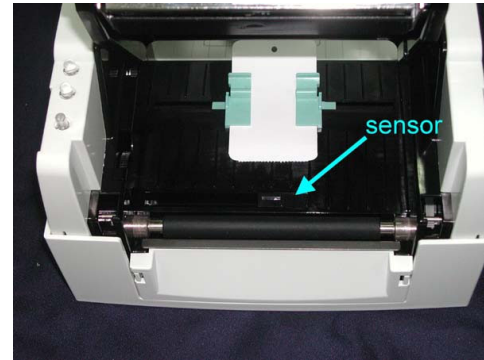

## 2-5. USB Installation

1. USB is a Plug & Play facility. Once the USB cable is connected from PC to the printer, PC will automatically detect the new device and begin the installation process.



<p>2. Select " Search for a suitable driver for my device [recommended]" and click "Next"</p>	
<p>3. Select the location of the driver.</p>	
<p>4. When the USB device driver is assigned and saved, click "Next"</p>	

5. The USB device is built on the serial port, therefore make sure the interface setting is specified to the assigned port.

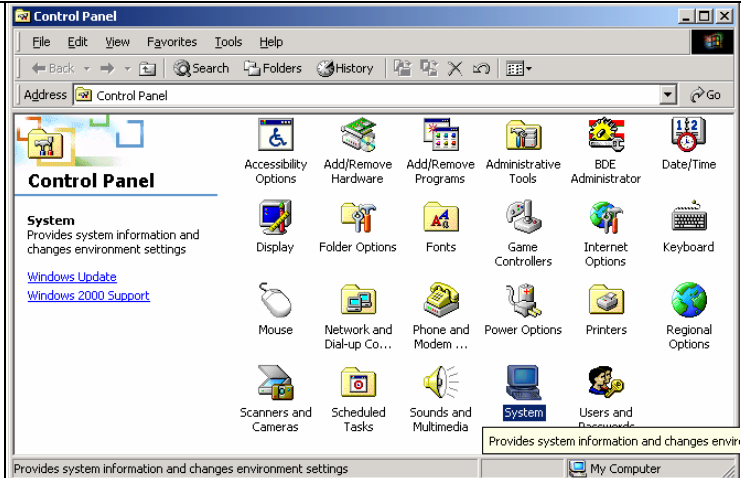

6. Go to Control Panel\System\Device Manager and the USB port will be listed under Ports (COM & LPT). The example from the right hand side indicates that the USB Serial Port is COM3.

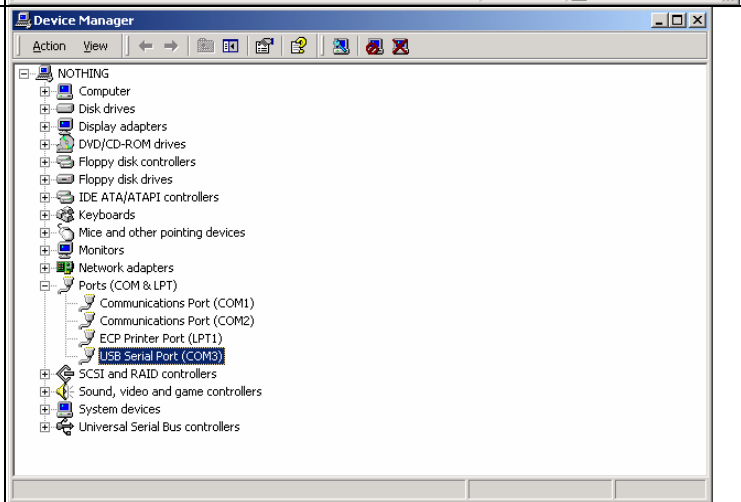

7. After the USB driver is installed, the USB device can be used through software (such as QLabel III or Century Systems drivers) to print labels.

## 2-6. USB Uninstallation

To remove the USB driver, open "USB Driver" folder and execute the "Ftdiunin" program, the message box on the right hand side will appear. Click "Continue" to remove the USB driver.

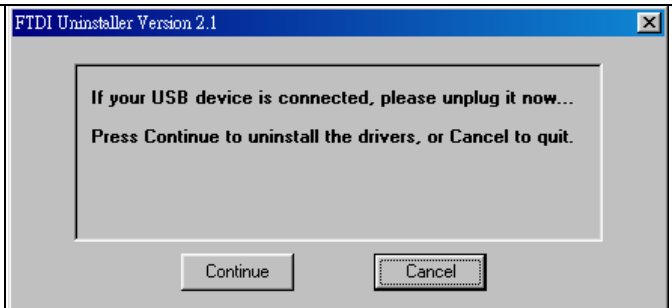

## 2-7. PC Connection

1. Please make sure the printer is powered off.
2. Take the power cable, plug the cable switch to the power socket, and then connect the other end of the cable to the printer power socket.
3. Connect the cable to the parallel port on the printer and on the PC.
4. Power on the printer. The LED light (Ready) should turn green when power is on.

*NOTE: If you wish to connect with an USB interface, please install the USB driver first.*

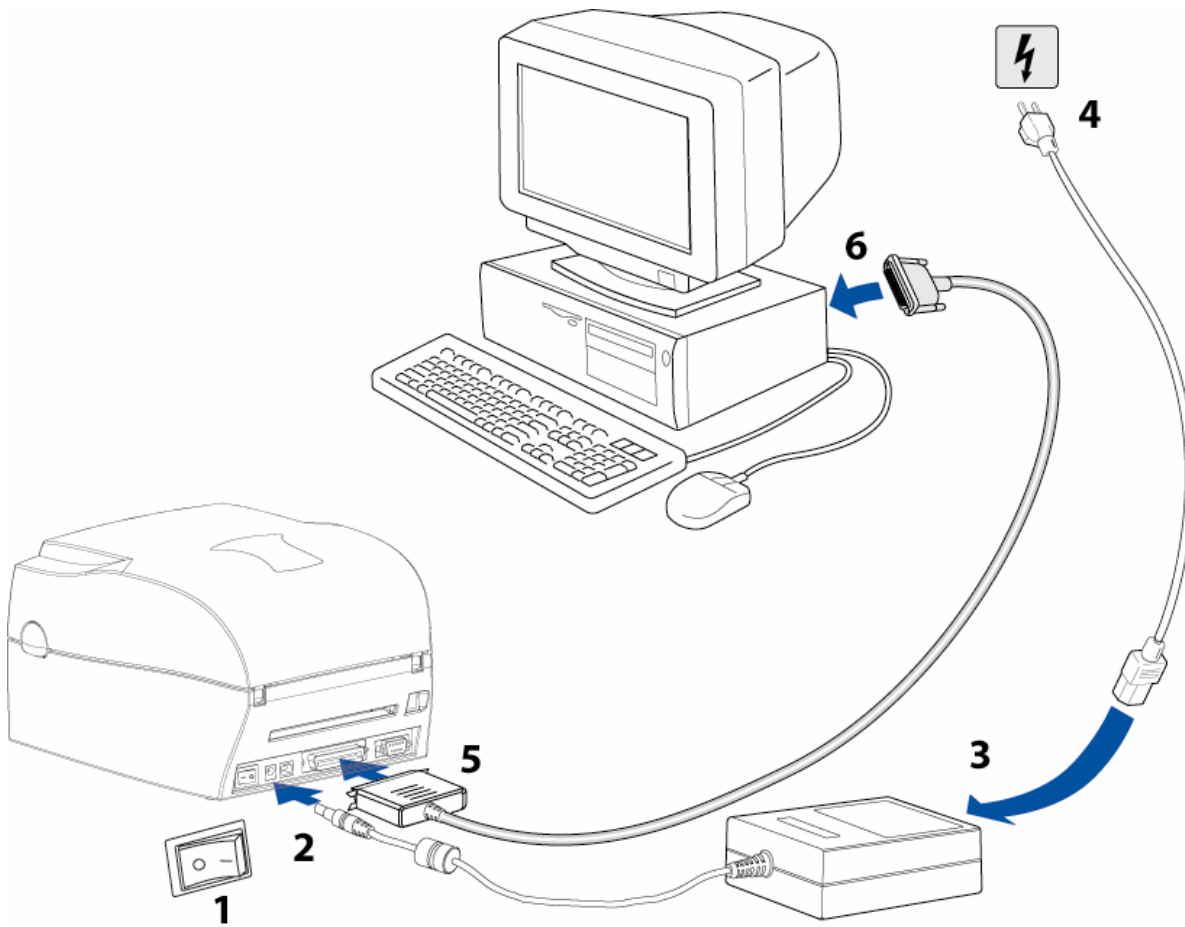

# Chapter 3 - Options Installation

## 3-1. Stripper Parts

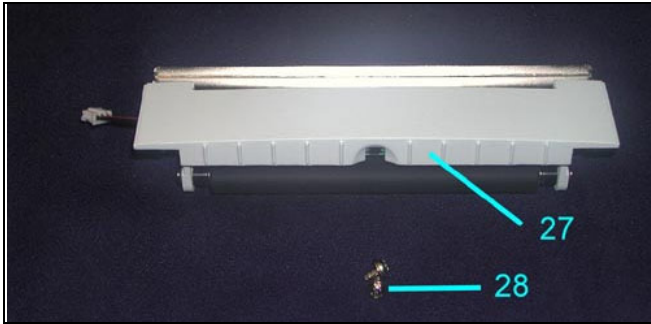

27	Stripper Module
28	Screw (TAP 3*8) x 2pcs

[NOTE]: Please power off the printer before installing the stripper module.

## 3-2. Stripper Installation

1. Open the top cover by pressing the Cover Open Buttons on both sides.

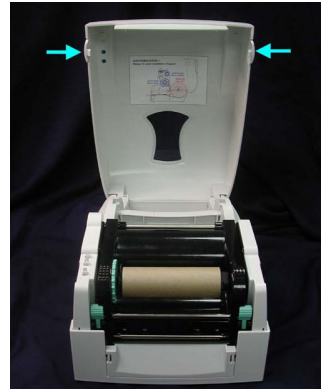

2. Push the front cover piece buttons inward to open.
3. Lift/take off the front cover piece according to the direction shown in the photo.

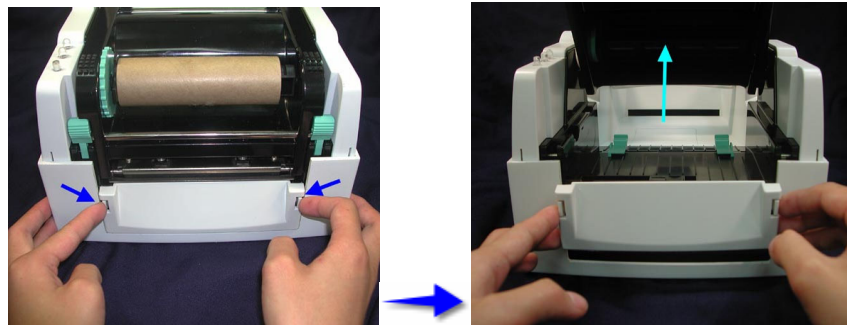

4. Plug in the connector (refer to the right photo) ◦

*Note: There are 2 sockets on the converting boards (one is for stripper installation, another is for cutter installation), before plug the connector into socket, please check the pin first.*

5. The label / paper used for rewinding purposes is suggested to be at least 30mm in height.

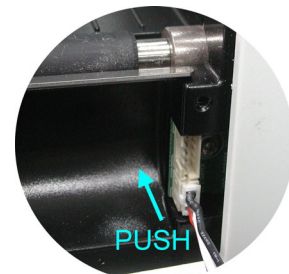
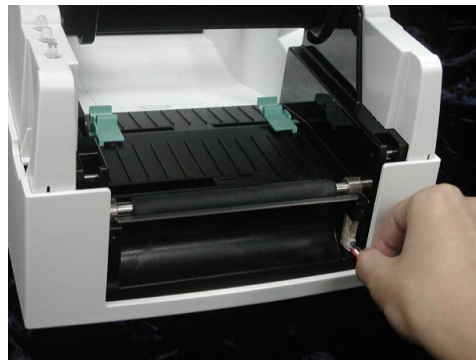



6. Place the right side in first, and then fit the left side.

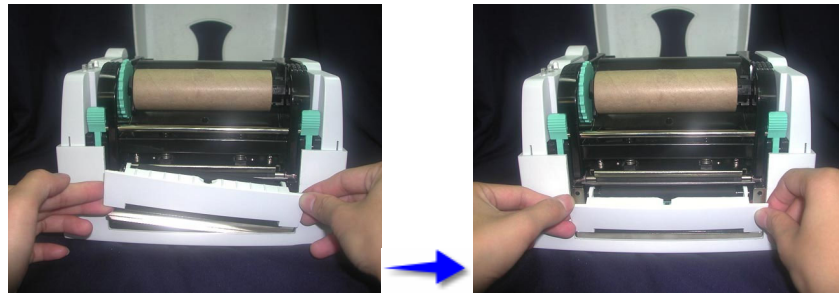

7. Hold the stripper module and tighten the screws (28).

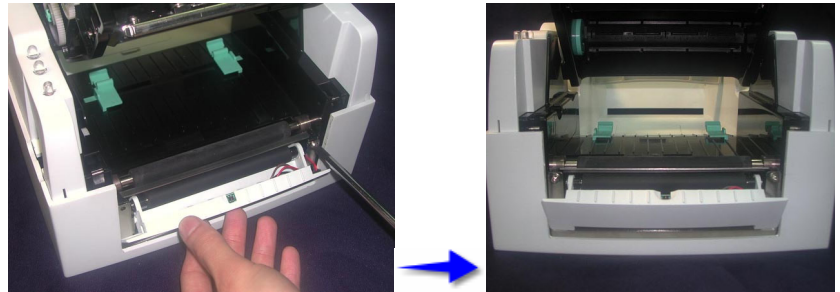

8. Peel off the first label, and feed the liner through the roller and the peel off bracket.  
9. Flip close the stripper module.

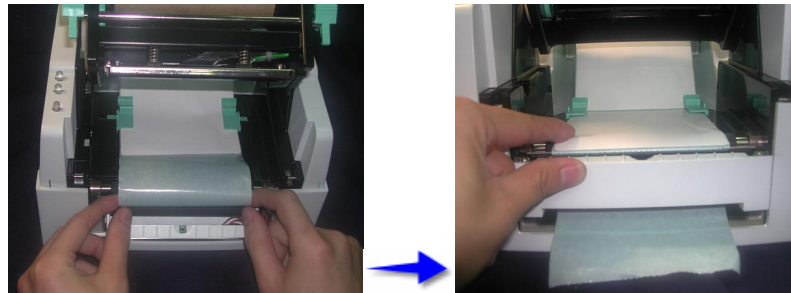

10. Close the print mechanism, then press the FEED key.





### 3-3. Stripper Installation Diagram

#### Stripper Installation Diagram

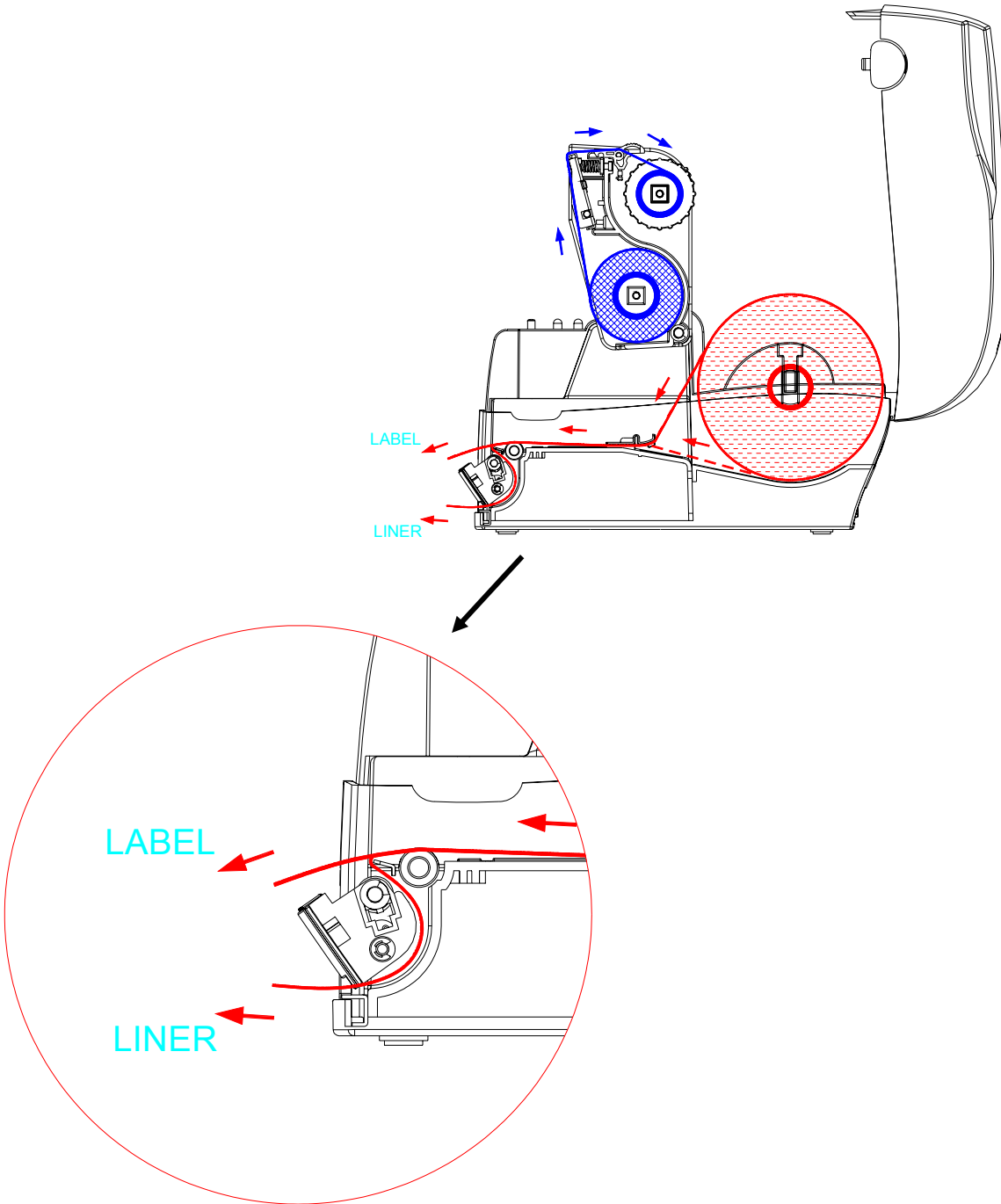

### 3-4. Cutter Parts

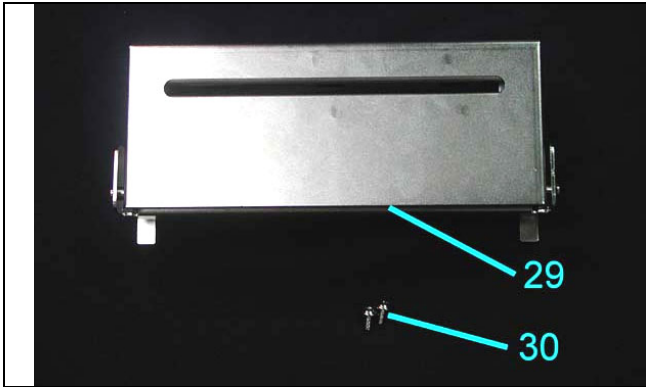

29	Cutter Module
30	Screw (TAP 3*8) x 2pcs

[NOTE]: Please power off the printer before installing the cutter module.

[NOTE]: Do not cut self-adhesive labels! The traces of adhesive will pollute the rotary knife and impair safe operation!

### 3-5. Cutter Installation

1. Open the top cover by pressing the Cover Open Buttons on both sides.

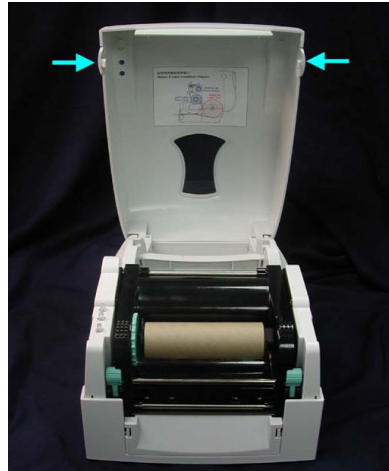

2. Push the front cover piece buttons inward to open.
3. Lift/take off the front cover piece according to the direction shown in the photo.

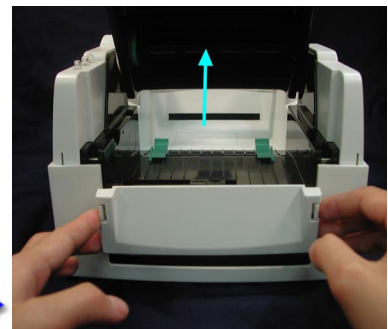
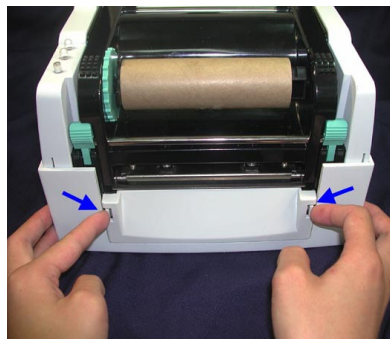

4. Open the mechanism by pressing the Locking Tenon, plug in the cable connector of the cutter module (29) onto the switchboard socket.

*Note: There are 2 sockets on the converting boards (one is for stripper installation, another is for cutter installation), before plug the connector into socket, please check the pin first.*

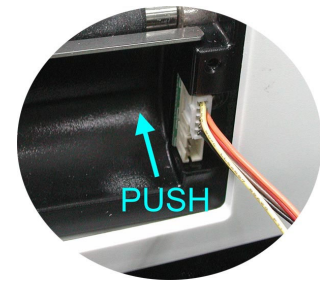
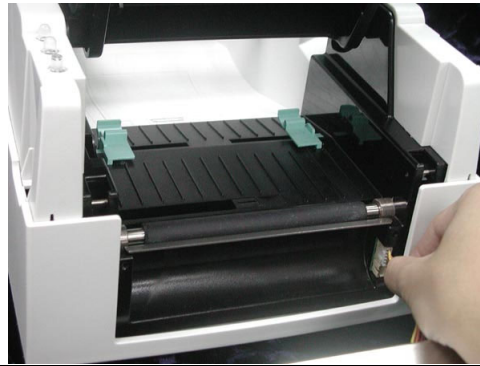

5. Clip in the right side of the cutter module (29) first, then secure the left side.

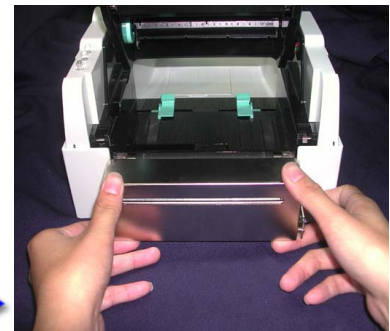
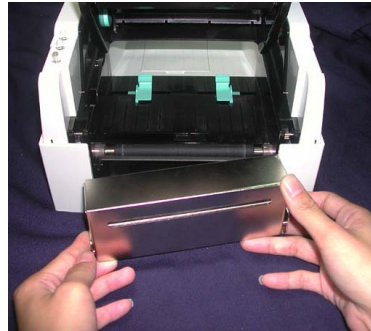

6. Flip the cutter module (29) down to open the cutter.

*Note: Please refer to photo (A).*

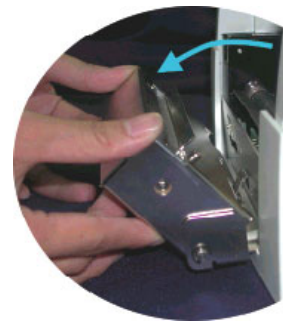
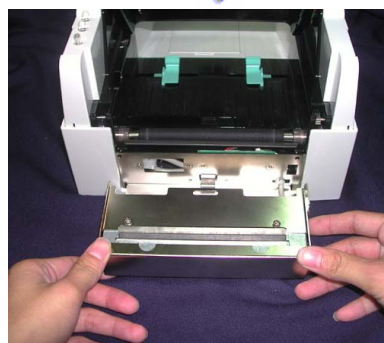
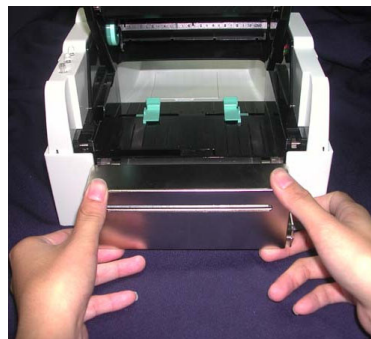

(A)

7. Hold the cutter module and lock it with the two side screws (30).

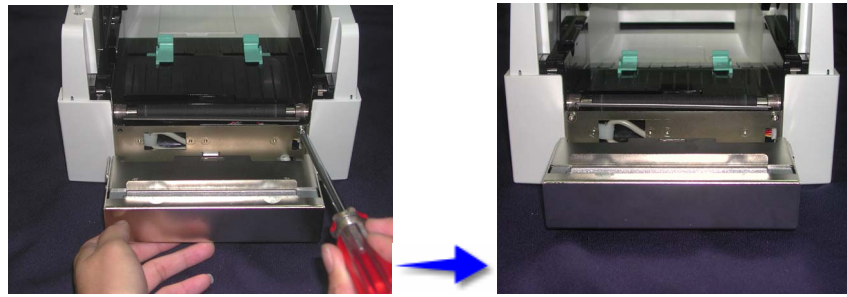

8. After the screws are locked, flip close the cutter module.

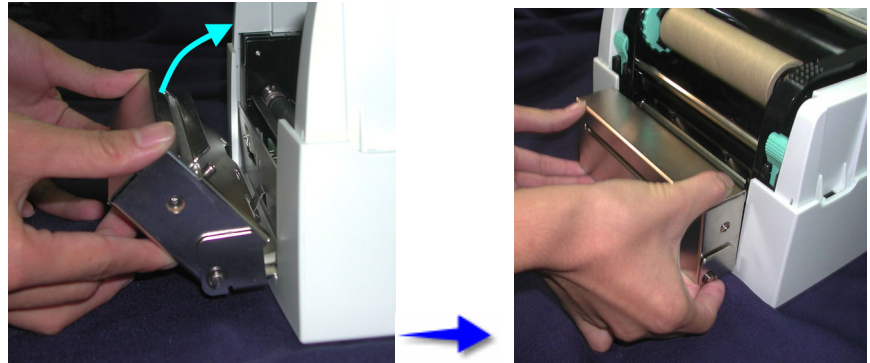

9. Close the mechanism to complete the cutter module installation.



### 3-6. Extended Memory Parts

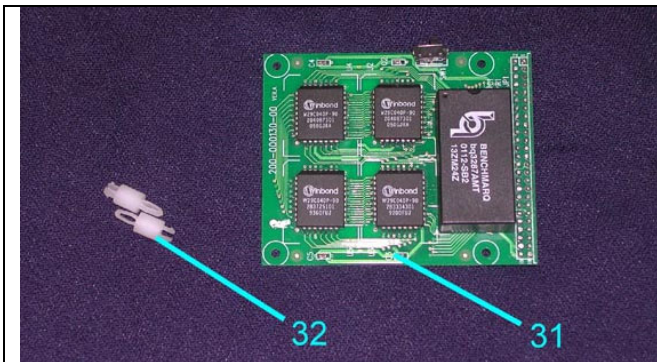

31	Extended Memory Card
32	PCB Pillar x 2pcs

[NOTE]: Please power off the printer before installing the extended memory.



### 3-7. Extended Memory Installation

1. Open the top cover by pressing the Cover Open Buttons on both sides.



2. Take off the media roll spindle. Open and remove the plastic cover on the inner base.

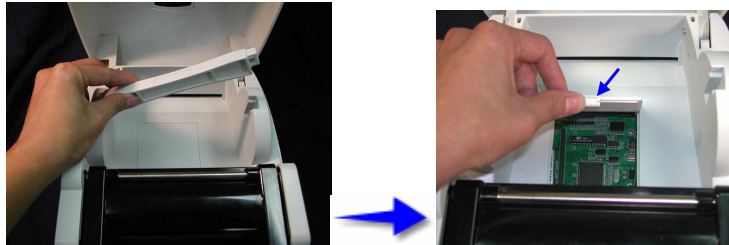

3. Secure the PCB pillar onto the main board.

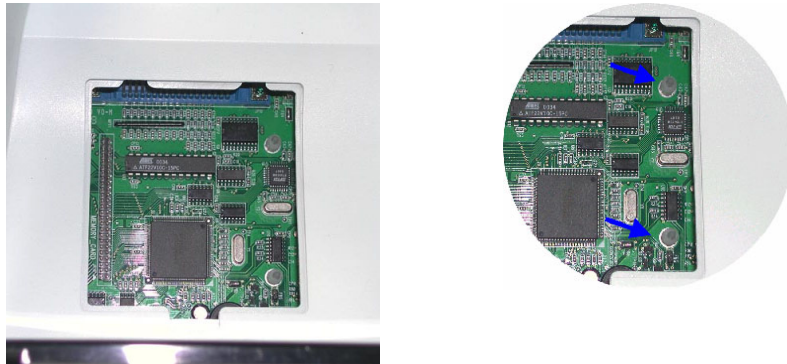

4. Check the pins where the memory is to be connected to, then plug the memory card onto the main board.

*Note: Please make sure the aperture on the connector and the pins match, otherwise when too much force is applied onto the memory card, there's a possibility that the pins may get damaged.*

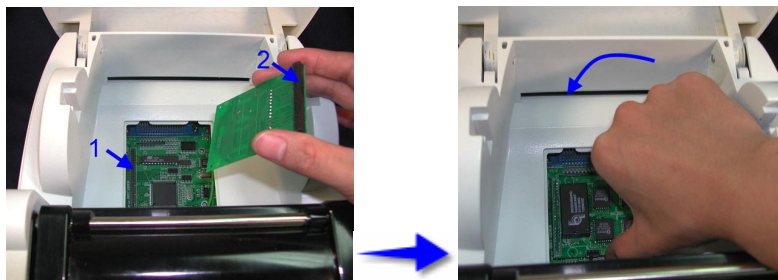

5. Close the plastic memory cover.

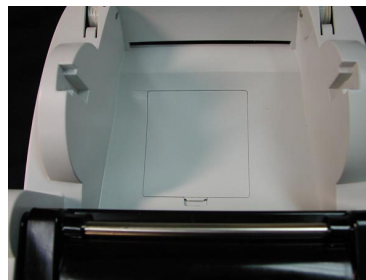

### 3-8. Ethernet Parts

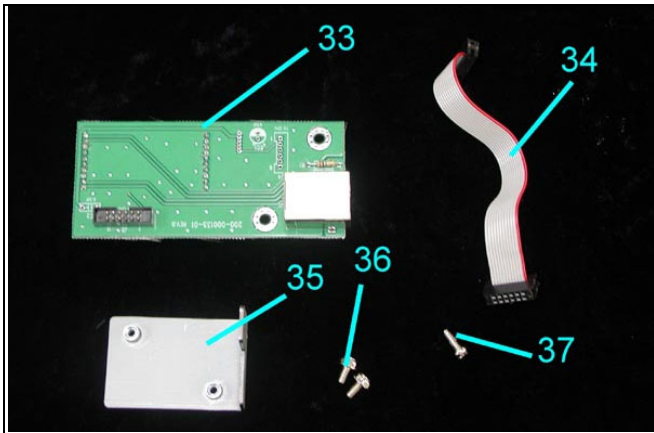

33	Ethernet Module
34	Connector Cable
35	Network Board Stand
36	Screws (MACHINE 3x6) x 2
37	Screw (TAP 3x8) x 1

<Note> Please turn power off when assembling Ethernet module.

### 3-9. Ethernet Installation

1. Remove screws at the bottom of the printer (refer to arrows).



2. Facing the printer, exert force on two sides of the printer and remove the middle compartment.

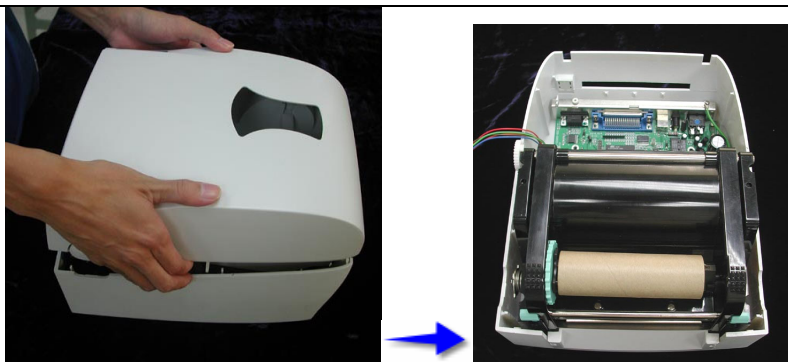

3. Remove the spare opening (A) at the back of the printer (refer to Figure 1)

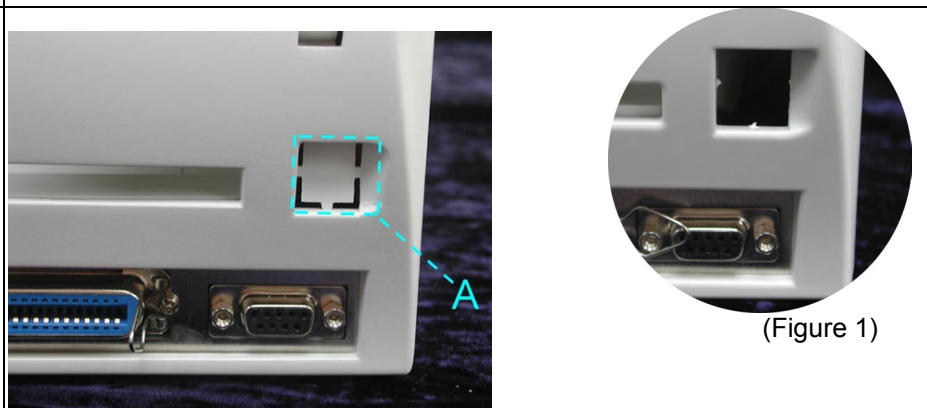

4. Secure Ethernet Module (33) and Network Board Stand (35) together as shown in Figure 2

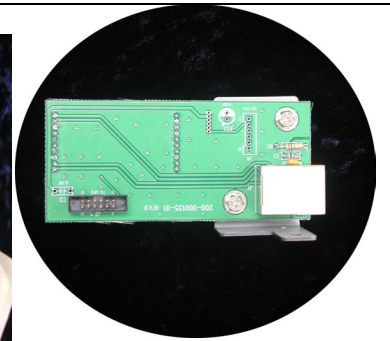
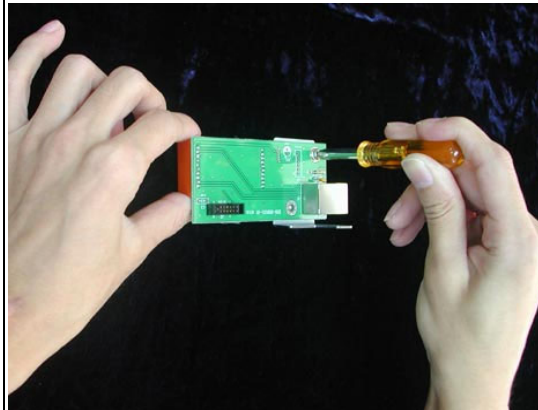

(Figure 2)

5. Screw the secured module and stand onto the bottom of the printer.

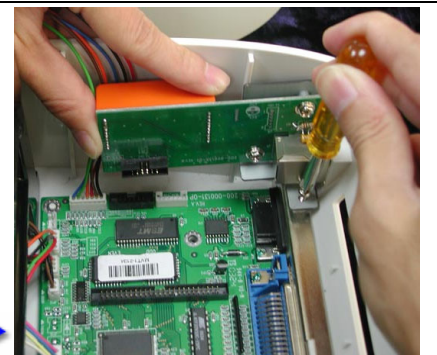

6. Connect one end of the Connector Cable (34) to the printer main board and the other end to Ethernet Module.

*Note: Bend the cable inward when making the connection to prevent interference with the main board.*

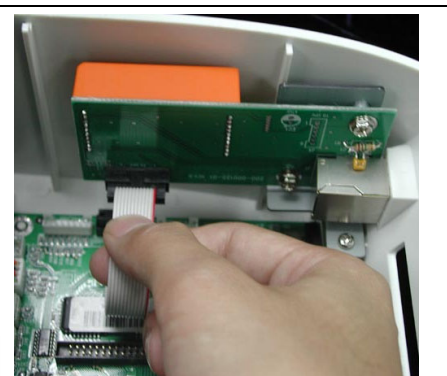
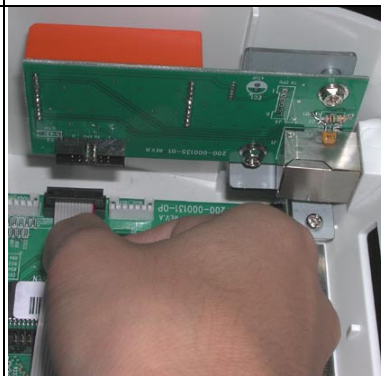

7. To complete installation, put the middle compartment back and re-screw it onto the bottom of the printer.

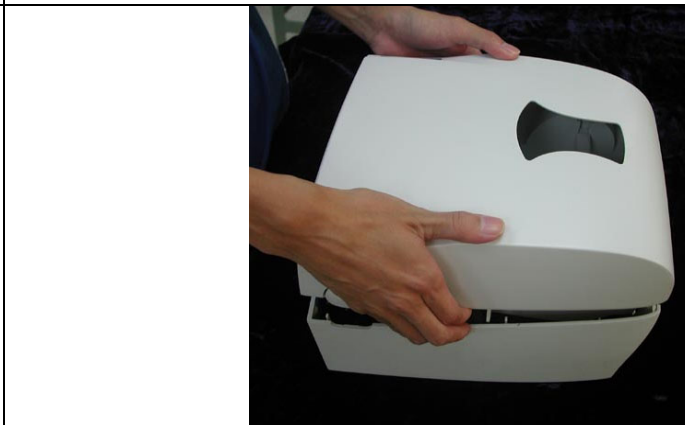

# Chapter 4 - LED Message Description

## 4-1. LED Status

	FEED	LED Ling	Beep	Status	Description
	READY	Green	1	Normal status	Normal status
	STATUS				
	READY	Green (Flash)	3	Dump Mode,	Printers currently in Dump Mode, for operation instructions please refer to <a href="#">4-4</a> .
	STATUS	Orange			
	READY	Red (Flash)	3	Self-Test	Printing Self-Test page, for operation instructions please refer to <a href="#">4-3</a> .
	STATUS	Orange			
	READY	Orange (Flash)	3	Auto Sensing Mode	Printers currently in Auto Sensing Mode, for operation instructions please refer to <a href="#">4-5</a> .
	STATUS	Orange			
	READY	Red (Flash)	3	Direct Thermal (DT) Mode	Printer currently in Direct Thermal (DT) Mode, for operation instructions please refer to <a href="#">4-6</a> .
	STATUS	Red			
	READY	Orange (Flash)	3	Thermal Transfer (TT) Mode	Printers currently in Thermal Transfer (TT) Mode, for operation instructions please refer to <a href="#">4-6</a> .
	STATUS	Red			
READY				Printer is currently downloading F/W.	
STATUS	Red (Flash)				

## 4-2. General Operation

### Feed Key

When pressing the Feed key, printer will send the media (according to media type) to the specified stop position. When printing with continuous media, when pressing the Feed key, the printer will feed media out to a certain length. When printing labels, pressing the Feed key, the printer will feed one label at a time; if the label is not sent out in a correct position, then please proceed with the Auto Sensing (see page 21).

## 4-3. Self-Test

The Self-Test function in a printer will help the user to troubleshoot whether the printer is operating normally. In the Self-Test Mode, the printer will print out a test sample each time when the Feed key is pressed. To stop the Self-Test procedure in the middle, simply power off the printer. Below are the Self-Test procedures:

- 1 Power off the printer, press and hold the Feed key.
- 2 Press and hold the FEED button while power on the printer, after the printer makes 3 beeps, and the LED REARY light flashes red and the LED STATUS light turns orange, the printer goes into the Self-Test Mode. Then release the FEED button, One second later, the printer will automatically print out the following contents.

After about 1 second, printer would automatically print out the following, and this means the printer is operating normally.



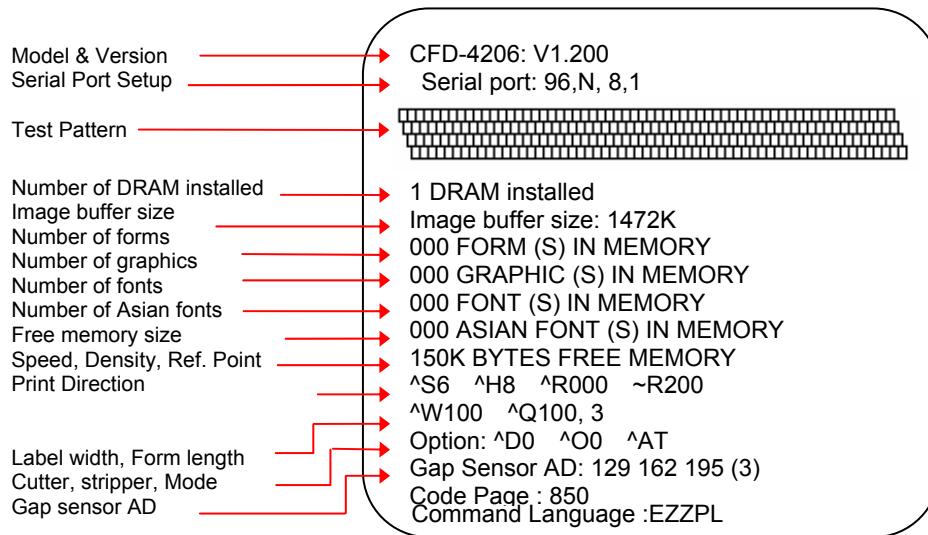

Self-Test includes the internal printer data setting.

## 4-4. Dump Mode

When label setting and the print result don't match, it's recommended to go into the Dump Mode to check whether there's a mistake in data transmission between the printer and the PC. For example, when printer receives 8 commands, yet without processing these commands, only print out the contents of the commands, this will confirm whether the commands were received correctly. Test procedures to enter the Dump Mode are as follows:

1. Power off the printer, press and hold the Feed key.
2. Press and hold the FEED button while power on the printer, after the printer makes 3 beeps, and the LED READY light flashes green and the LED STATUS light turns orange, the printer goes into the Dump Mode. Then release the FEED button. The printer will automatically print out "DUMP MODE BEGIN". This indicates that the printer is currently in Dump Mode.
3. Printer will automatically print "DUMP MODE BEGIN." This means the printer is already in Dump Mode.
4. Send commands to the printer, and check to see if the print result matches the commands sent.
5. Press the Feed key to exit the Dump Mode, now the printer will automatically print "OUT OF DUMP MODE." This means the printer is back in the normal status.

Note: To cancel (get out of the Dump Mode), press the Feed key, this time printer will automatically print out "OUT OF DUMP MODE." This indicates that printer is back in the standby mode. Or power off to exit the Dump Mode.

## 4-5. Auto Sensing

Printer can automatically detect label (black mark paper) length and record. This way, without setting the print length, the printer can accurately detect the label (black mark) positions.

1. Check if the Moveable Sensor Mark is located at the right sensing position.
2. Power off the printer, press and hold the Feed key.
3. Press and hold the FEED button while power on the printer, after the printer makes 3 beeps, and wait until the LED READY light flashes orange and the LED STATUS light turns orange, the printer will go into the Auto Sensing Mode. Then release the FEED button. The printer will automatically record the label size.

## 4-6. Direct Thermal / Thermal Transfer Mode Switch

1. Power off the printer, press and hold the Feed key.
2. Press and hold the FEED button while power on the printer, after the printer makes 3 beeps, and wait until the LED READY light flashes red and the LED STATUS light turns red, the printer will go into Direct Thermal (DT) Mode. Then release the FEED button. The printers will automatically print "NOW IS DIRECT THERMAL (DT MODE)". This indicates that printer is currently in DT Mode.
3. Press and hold the FEED button while power on the printer, after the printer makes 3 beeps, and wait until the LED READY light flashes orange and the LED STATUS light turns red, the printer will go into the Thermal Transfer (TT) Mode. Then release the FEED button. The printers will automatically print "NOW IS THERMAL TRANSFER (TT MODE)". This indicates that printer is currently in TT Mode.

NOW IS THERMAL TRANSFER ( TT MODE)

NOW IS DIRECT THERMAL (DT MODE)

## 4-7. Error Messages

LED Message	LED Light		Beep	Description	Solution
	Ready	Status			
Print head is opened		Red	4 beeps twice	Print head not firmly in place.	Re-open print head and make sure it closes tightly.
Entering the Cooling Process		Red	None	Print head temperature high.	When print head temperature drops to the normal temperature range, printer will go back to the standby mode.
Out of ribbon or check ribbon sensor		Red	3 beeps twice	Ribbon not installed, and printer shows error message.	Make sure the printer is in the Direct Thermal mode.
				Ribbon used up or ribbon supply shaft not moving.	Replace with new ribbon roll.
Out of media or check media gap sensor		Red	2 beeps twice	Unable to detect paper.	Make sure the movable sensor mark is at the correct position, if the sensor is still unable to detect paper, and then go through Auto Sensing again.
				Paper used up.	Replace with new label roll.
Check paper setting		Red	2 beeps twice	Abnormal paper feed.	Possible causes: card tags or paper fall into the gap behind the platen roller, can't find label gap/black mark, black mark paper out. Please adjust according to actual usage.
Command is not recognized		Red	2 beeps twice	Wrong command; printer prints out "Command is not recognized."	Check printer commands, possible value missing or errors.
Memory is full		Red	2 beeps twice	Memory is full; printer prints out "Memory full."	Delete unnecessary data in the memory or purchase extended memory (options).
Filename can not be found		Red	2 beeps twice	Can't find the file; printer prints out "Filename can not be found."	Use "~X4" command to print out all the files, then check whether the file exist and the names are correct.
Filename is repeated		Red	2 beeps twice	File name is repeated; printer prints out "Filename is repeated."	Change the file name and download again.

# Chapter 5 - Maintenance and Adjustment

## 5-1. Thermal Print Head Cleaning

Unclear printouts (some parts unable to print) may be caused by dusty print head, ribbon stain, or label liner glue, therefore when printing, it's necessary to keep the top cover closed. Also, check and prevent paper/label from being stained or dusty to ensure print quality and to prolong the print head life. Print head cleaning instructions are as follows:

1. Power-off the printer.
2. Open top cover.
3. Take out the ribbon.
4. Open the print head by pressing the locking tenons.
5. If on the print head (see yellow arrow) there's label pieces or other stain, please use a soft cloth with industrial use alcohol to wipe away the stain.

Note:

- (1) Weekly cleaning on the print head is recommended.
- (2) Please clean the print head with the cleaning card that comes with the printer.

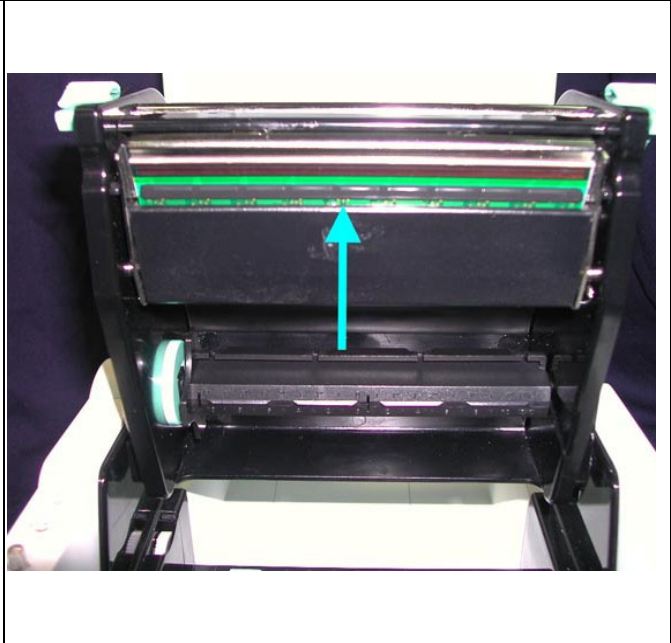

## 5-2. Thermal Print Head Balance Adjustment

When printing with different label materials or using different ribbon types, unbalanced print quality may occur due to the media material differences, thus it's necessary to adjust the Thermal Print Head pressure.

1. Open top cover.
2. Take out the ribbon.
3. Turning the print head adjustment screws slightly by Philips screwdriver to increase or decrease print head pressure.

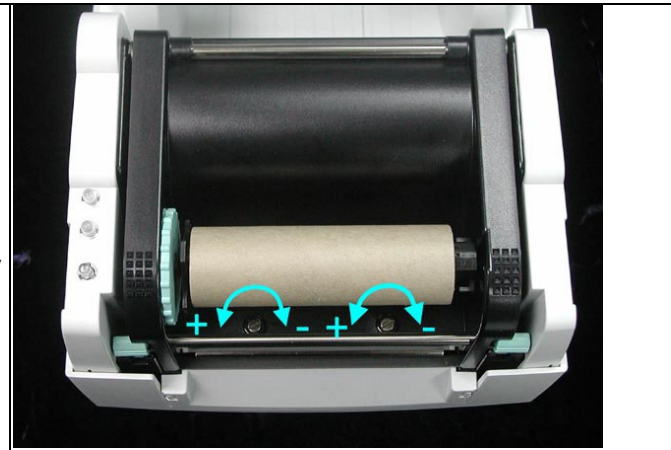

### 5-3. Print Line Adjustment

Use print head adjusting gear to adjust the contacting surface between print head and label. To get better printing balance and quality.

1. When turning print head adjusting gear counter-clockwise (as arrow 1 shows), print head would move in a direction where arrow A is.
2. When turning print head adjusting gear clockwise (as arrow 2 shows), print head would move in a direction where arrow B is.

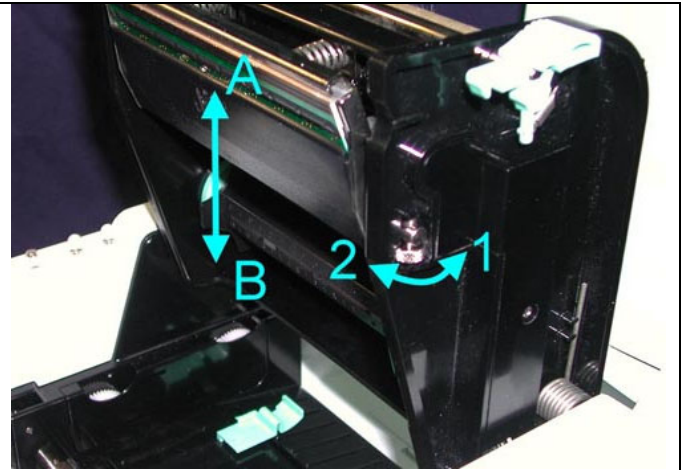

### 5-4. Adjust the cutter

1. A cutter-adjusting hole is present on both sides (where A is pointing to).
2. The cutter will not function properly if there is a paper jam. Turn the power off and use a #M3 hexagon wrench inserted into hole "A" and open the cutter from right to left.
3. Power on the printer after clearing the paper jam, the cutter will return to the correct position automatically.

Note: The label / paper used for cutting is suggested to be at least 30mm in height.

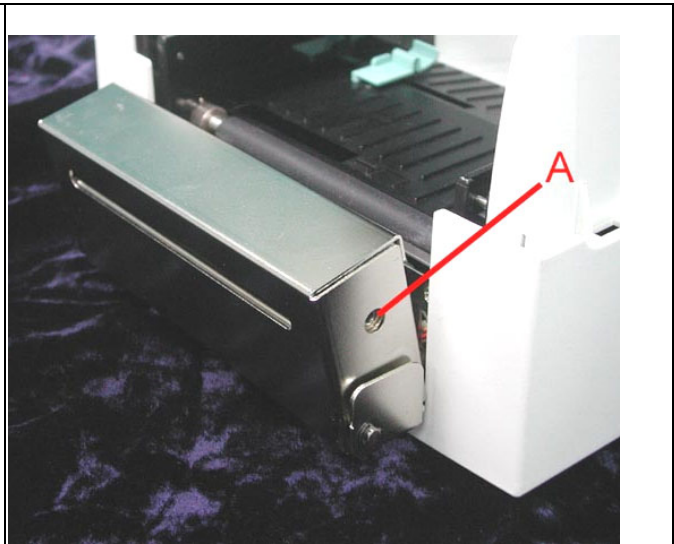

## 5-5. Troubleshooting

Problem	Recommended Solution
Power on the printer, but the LED does not light up	<ul style="list-style-type: none"> <li>◆ Check the power connector</li> </ul>
LED light turns red (power/status) after printing stops	<ul style="list-style-type: none"> <li>◆ Check for software setting or program command errors</li> <li>◆ Replace with suitable label or ribbon</li> <li>◆ Check if label or ribbon is all out</li> <li>◆ Check if label is jammed/tangled up</li> <li>◆ Check if mechanism is closed (Thermal Print Head not positioned correctly)</li> <li>◆ Check if sensor is blocked by paper/label</li> <li>◆ Check for abnormal cutter function or of no actions (if cutter is installed)</li> </ul>
Printing started, but nothing was printed on the label	<ul style="list-style-type: none"> <li>◆ Check if label is placed upside down or if label is not suitable for the application</li> <li>◆ Select the correct printer driver</li> <li>◆ Select the correct label and print type</li> </ul>
When printing, label is jammed/tangled up	<ul style="list-style-type: none"> <li>◆ Clean the label jam, and if label is stuck on Thermal Print Head, please remove it by using soft cloth with alcohol.</li> </ul>
When printing, only part of the contents were printed	<ul style="list-style-type: none"> <li>◆ Check if label or ribbon is stuck on the Thermal Print Head</li> <li>◆ Check if application software has errors</li> <li>◆ Check if start position setting has errors</li> <li>◆ Check if ribbon has wrinkles</li> <li>◆ Check if ribbon supply shaft is creating friction with the platen roller. If the platen roller needs to be replaced, please contact your reseller for more information</li> <li>◆ Check if power supply is correct</li> </ul>
When printing, part of the label wasn't printed completely	<ul style="list-style-type: none"> <li>◆ Check if Thermal Print Head is stained or dusted</li> <li>◆ Use internal command "~T" to check Thermal Print Head can print completely</li> <li>◆ Check the media quality</li> </ul>
Printout not in desired position	<ul style="list-style-type: none"> <li>◆ Check if sensor is covered by paper or dust</li> <li>◆ Check if liner is suitable for use, please contact reseller for more information</li> <li>◆ Check if label roll edge is aligned with Label Width Guide</li> </ul>
When printing, page skipping occurs	<ul style="list-style-type: none"> <li>◆ Check if error occurs on label height setting</li> <li>◆ Check is sensor is covered by dust</li> </ul>
Unclear printout	<ul style="list-style-type: none"> <li>◆ Check print darkness setting</li> <li>◆ Check if Thermal Print Head is covered with glue or stain</li> </ul>
When using cutter, label wasn't cut straight	<ul style="list-style-type: none"> <li>◆ Check if label is set up straight</li> </ul>
When using cutter, label wasn't cut successfully	<ul style="list-style-type: none"> <li>◆ Check whether label thickness exceeds 0.2mm</li> </ul>
When using cutter, label couldn't feed or abnormal cutting occurs	<ul style="list-style-type: none"> <li>◆ Check if cutter is installed properly</li> <li>◆ Check if Paper Feed Rods are sticky</li> </ul>
When using stripper, abnormal function occurs	<ul style="list-style-type: none"> <li>◆ Check if stripper sensor is covered with dust</li> <li>◆ Check if label is installed properly</li> </ul>

Note: If further problems occur, please contact your distributor for more information.

## Free Manuals Download Website

<http://myh66.com>

<http://usermanuals.us>

<http://www.somanuals.com>

<http://www.4manuals.cc>

<http://www.manual-lib.com>

<http://www.404manual.com>

<http://www.luxmanual.com>

<http://aubethermostatmanual.com>

Golf course search by state

<http://golfingnear.com>

Email search by domain

<http://emailbydomain.com>

Auto manuals search

<http://auto.somanuals.com>

TV manuals search

<http://tv.somanuals.com>