

brother®

- **1** GETTING READY
- **Read before use.** ● **2** SEWING BASICS
- **3** UTILITY STITCHES
- **Read when additional information is required.** ● **4** APPENDIX

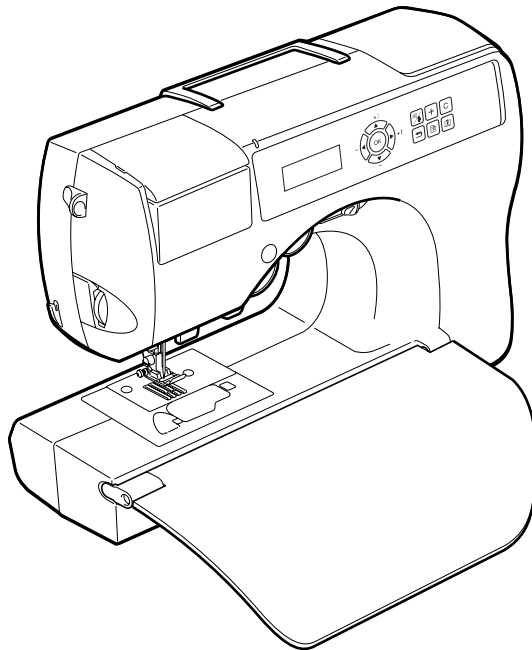

Computerized Sewing Machine
Operation Manual

Enclosed Accessories

After opening the box, check that the following accessories are enclosed. If any item is missing or damaged, contact your retailer.

Accessories



Note

(For U.S.A. only)

- Foot controller: Model N5V
This foot controller can be used on this machine model CS-8150.
- The screw of the presser foot holder is available through your authorized dealer.
(Part code: XA4813-051)

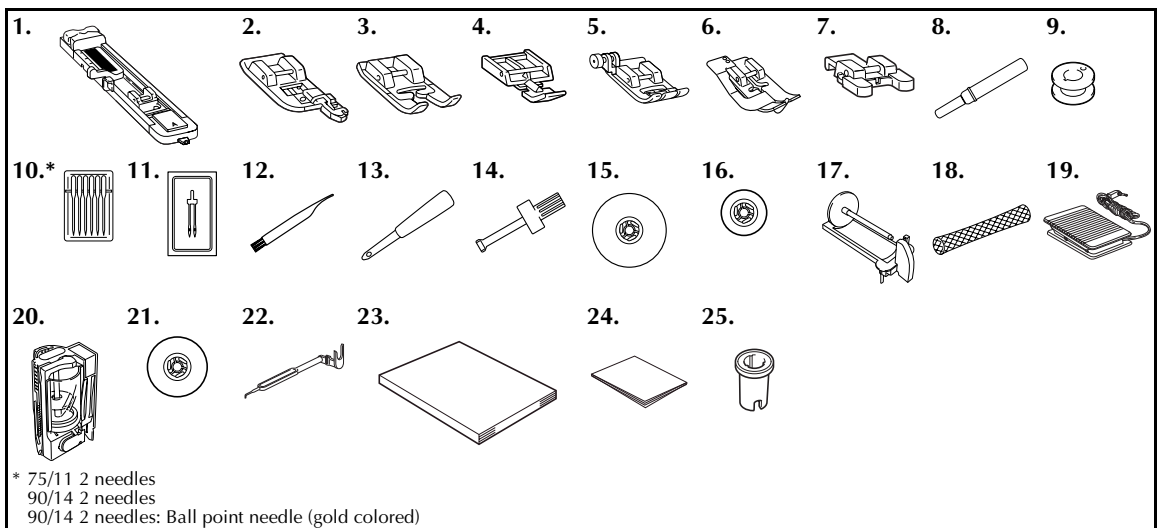

No.	Part Name	Part Code		No.	Part Name	Part Code	
		U.S.A.	Others			U.S.A.	Others
1	Buttonhole foot "A"	XC2691-051		14	Screwdriver	XC4237-021	
2	Overcasting foot "G"	XC3098-051		15	Spool cap (large)	130012-054	
3	Monogramming foot "N"	X53840-351		16	Spool cap (small)	130013-154	
4	Zipper foot "I"	X59370-051		17	Extra spool pin	XC3834-021	
5	Zigzag foot "J" (on machine)	XC3021-051		18	Spool net	XA5523-050	
6	Blind stitch foot "R"	XC4051-051		19	Foot controller	XC1154-021	
7	Button fitting foot "M"	X59375-151		20	Thread cassette (on machine)	XC3664-021	
8	Seam ripper	X54243-001		21	Spool cap (orange) (on machine)	XC3673-021	
9	Bobbin (4)	SA156	XA5539-151	22	Needle-changing tool	XC4551-021	
10	Needle set	X58358-051		23	Operation manual	XC5252-021	
11	Twin needle	X59296-051		24	Quick reference guide	XC5256-021, XC5257-021	
12	Cleaning brush	X59476-051		25	Spool cap (special)	XA5752-021	
13	Eyelet punch	135793-051					

Names of Machine Parts and Their Functions

The names of the various parts of the sewing machine and their functions are described below. Before using the sewing machine, carefully read these descriptions to learn the names of the machine parts.

Front view

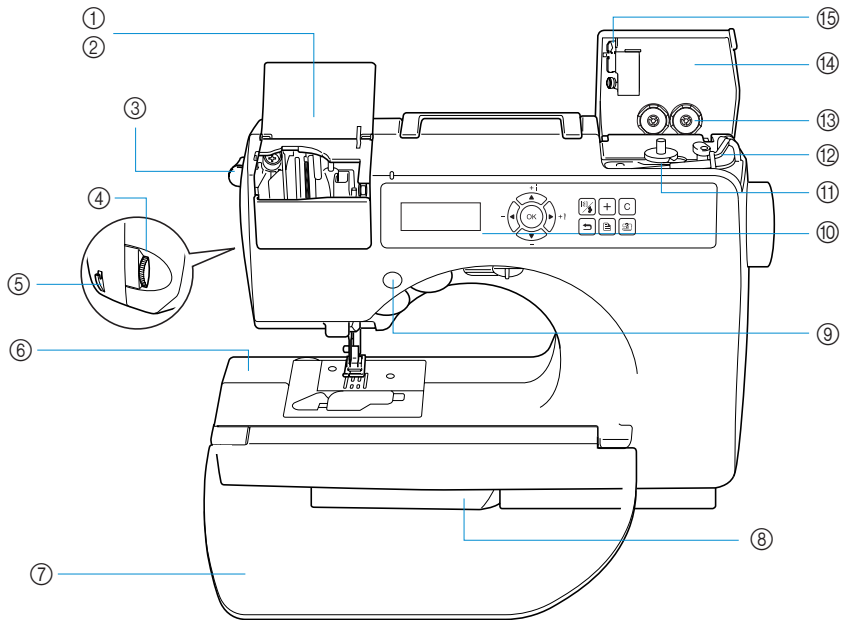

① **Thread cassette compartment cover**

② **Thread cassette compartment**

Insert a thread cassette into the thread cassette compartment.

③ **Thread cassette eject lever**

Press this lever to eject the installed thread cassette.

④ **Thread tension dial**

Use the thread tension dial to adjust the tension of the upper thread.

⑤ **Thread cutter**

Pass the threads through the thread cutter to cut them.

⑥ **Arm**

⑦ **Flap**

Use the flap to create a table. When the sewing machine is not being used, store the machine with the flap folded up. Remove the flap to sew cylindrical pieces such as sleeve cuffs.

⑧ **Sliding leg**

Pull out the sliding leg during free-arm sewing.

⑨ **Operation buttons**

Use the operation buttons to start the sewing machine and raise and lower the needle. (page Cover D)

⑩ **Operation panel**

Select a stitch from those that appear in the operation panel. (page Cover E)

⑪ **Bobbin winder**

Use the bobbin winder when winding the bobbin.

⑫ **Bobbin thread spool pin**

Place the spool of thread for the bobbin onto this spool pin in order to wind the bobbin.

⑬ **Bobbin storage compartment**

Store the bobbins designed specifically for this sewing machine in this compartment.

⑭ **Bobbin winder cover**

Open this cover when winding the bobbin.

⑮ **Thread guide for bobbin winding**

Pass the thread around this thread guide when winding the bobbin thread.

Needle and presser foot section

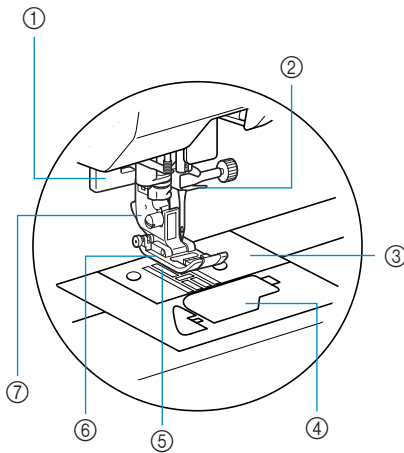

- ① **Buttonhole lever**
Lower the buttonhole lever when sewing buttonholes and bar tacks.
- ② **Needle bar thread hook**
Pass the upper thread through the needle bar thread hook.
- ③ **Needle plate**
The needle plate is marked with guides for sewing straight seams.
- ④ **Bobbin cover/shuttle**
Remove the bobbin cover, and then insert the bobbin into the shuttle.
- ⑤ **Feed dogs**
The feed dogs feed the fabric in the sewing direction.
- ⑥ **Presser foot**
The presser foot applies pressure consistently on the fabric as the sewing takes place. Attach the appropriate presser foot for the selected stitching.
- ⑦ **Presser foot holder**
The presser foot is installed onto the presser foot holder.

Right-side/rear view

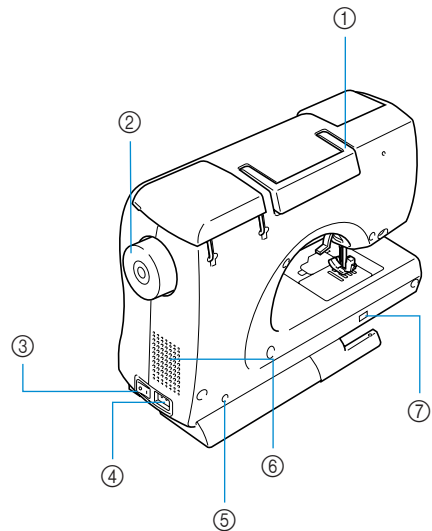

- ① **Handle**
Carry the sewing machine by its handle when transporting the machine.
- ② **Balance wheel**
Turn the balance wheel toward you to raise and lower the needle to sew one stitch.
- ③ **Main power switch**
Use the main power switch to turn the sewing machine on and off.
- ④ **Power supply jack**
Insert the plug on the power supply cord into the power supply jack.
- ⑤ **Foot controller jack**
Insert the plug on the end of the foot controller cable into the foot controller jack.
- ⑥ **Air vent**
The air vent allows the air surrounding the motor to be exchanged. Do not cover the air vent while the sewing machine is being used.
- ⑦ **Feed dog position switch**
Use the feed dog position switch to lower the feed dogs.







Memo

- Refer to Cover B, D or E pages while you are learning to use your machine.

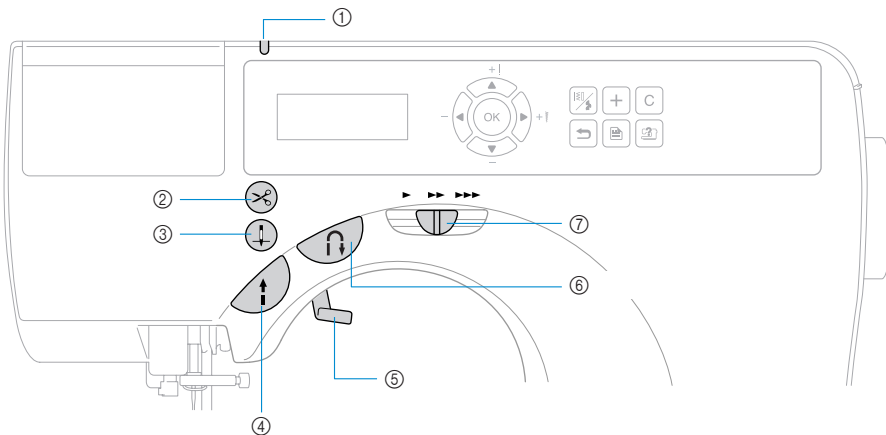
Operation buttons

The operation buttons help you to easily perform various basic sewing machine operations.



- ① **Thread cassette indicator**
The indicator lights up or goes off depending on the condition of the sewing machine.
Green: A thread cassette can be inserted.
Red: A thread cassette cannot be inserted.
Off: The sewing machine has been turned off or a thread cassette is already inserted.
- ② **Thread cutter button**  (Only for models equipped with the thread cutter button)
Press the thread cutter button after stopping sewing to cut both the upper and the bobbin threads. For details, refer to “Cutting the thread” (page 55).
- ③ **Needle position button** 
Press the needle position button to raise or lower the needle. Pressing the button twice sews one stitch.
- ④ **Start/stop button** 
Press the start/stop button to start or stop sewing. The machine sews at a slow speed at the beginning of sewing while the button is depressed. When sewing is stopped, the needle is lowered in the fabric. For details, refer to “Starting to sew” (page 51).
- ⑤ **Presser foot lever**
Raise and lower the presser foot lever to raise and lower the presser foot.
- ⑥ **Reverse/reinforcement stitch button** 
Press the reverse/reinforcement stitch button to sew reverse stitches or reinforcement stitches. Reverse stitches are sewn by keeping the button pressed down to sew in the opposite direction. Reinforcement stitches are sewn by sewing 3 to 5 stitches on top of each other. For details, refer to “Securing the stitching” (page 53).

- ⑦ **Sewing speed controller**
Slide the sewing speed controller to adjust the sewing speed.

CAUTION

- Do not press the thread cutter button after the threads have already been cut, otherwise the needle may break, the threads may become tangled or damage to the machine may occur.

Note

- Do not press the thread cutter button if there is no fabric under the presser foot or while the machine is sewing, otherwise damage to the machine may occur.
- When cutting thread thicker than #30, nylon thread or other special threads, use the thread cutter on the side of the machine. For details, refer to “Cutting the thread” (page 55).

Operation panel

The operation panel, located on the front of the sewing machine, consists of the LCD (liquid crystal display) and keys for specifying various sewing settings.

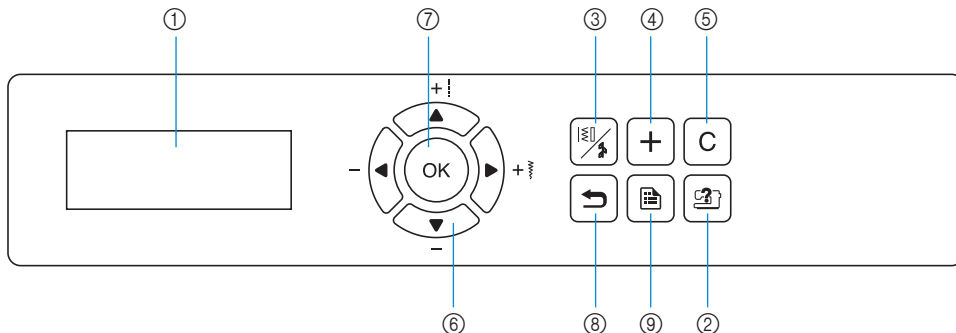

① LCD (liquid crystal display)

Settings for the selected stitch and error messages for incorrect operations appear in the LCD. Use keys ② through ⑨, described below, to display various items and select the settings. For details, refer to “Understanding the LCD Screens” (page 12).

② Sewing machine help key

Press this key to display operation information. Simple descriptions on threading the upper thread, installing the bobbin, winding the bobbin and replacing the presser foot can be displayed.

③ Stitch selection key

Press this key to select the desired type of stitch.





④ + key

Press this key to add a pattern when sewing combinations of decorative stitches.

⑤ C key

Press this key to remove an added pattern when sewing combinations of decorative stitches.

⑥ Arrow keys

Use these keys to move in the indicated direction when selecting an item displayed on the screen. In addition,   can be pressed to select a lower setting and   can be pressed to select a higher setting.

⑦ OK key

Press this key to apply the selected item.

⑧ Back key

Press this key to return to the previous screen.

⑨ Settings key

Press this key to select sewing settings, such as for automatic reverse/reinforcement stitching, or other settings such as the operation beep.

Optional Accessories

The following are available as optional accessories.

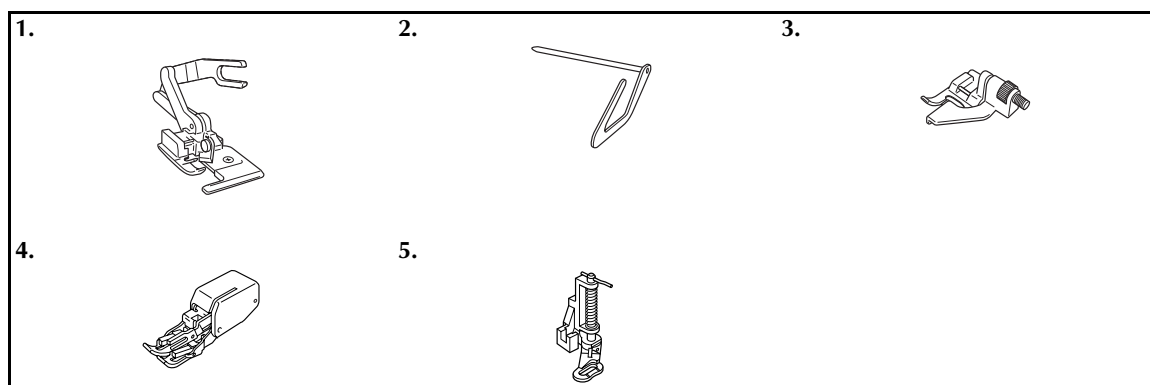

1. Side cutter

Part code: SA177, XC3879-002

2. Quilting guide

Part code: SA132, XC2215-002

3. Guide foot

Part code: SA133, XC1957-002

4. Walking foot

Part code: SA140, XC2214-002

5. Quilting foot

Part code: SA129, XC1948-002



Memo

- To obtain optional accessories or parts, contact your sales representative or the nearest authorized service center.

Introduction

Thank you for purchasing this sewing machine.

Before using this sewing machine, carefully read the "Important Safety Instructions" (page 6), and then study this manual for the correct operation of the various functions.

In addition, after you have finished reading this manual, store it where it can quickly be accessed for future reference.

Sewing Machine Features

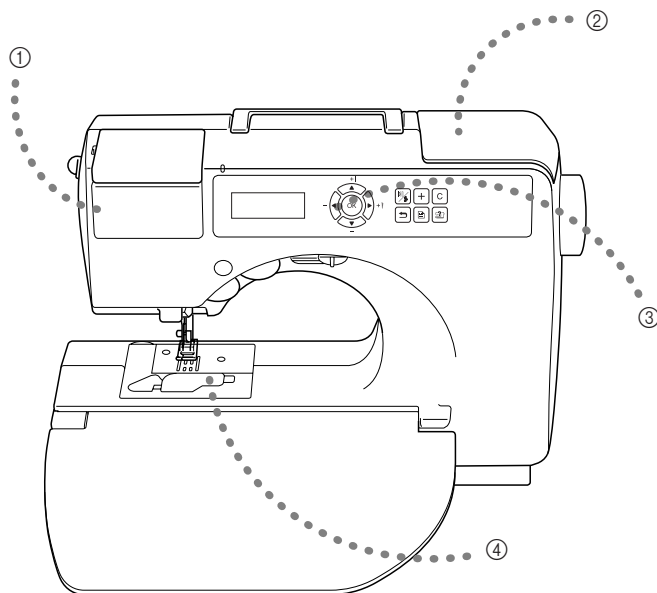

- ① **Thread cassette**
Easily thread the upper thread by loading a spool of thread into the thread cassette. In addition, simply insert the thread cassette into the compartment to thread the needle. (page 25)
- ② **Simple bobbin-winding**
The bobbin can quickly and easily be wound with thread. (page 18)
- ③ **Built-in stitches**
You can select from the built-in stitches available, including utility stitches and decorative stitches. (page 66)
- ④ **One-touch lower threading**
You can start sewing without pulling up the bobbin thread. (page 22)

Contents

Enclosed Accessories	Cover A
Accessories	Cover A
Names of Machine Parts and Their Functions	Cover B
Front view	Cover B
Needle and presser foot section	Cover C
Right-side/rear view	Cover C
Operation buttons	Cover D
Operation panel	Cover E
Optional Accessories	1
Introduction	2
Sewing Machine Features	2
Contents	3
Important Safety Instructions	6

GETTING READY 9

Turning the Machine On/Off	10
Power supply precautions	10
Turning on the machine	11
Turning off the machine	11
Understanding the LCD Screens	12
Checking machine operating procedures	13
Changing the Machine Settings	14
Changing the settings	14
Changing the needle stop position	16
Adjusting the brightness of the LCD	16
Changing the screen language	17
Winding/Installing the Bobbin	18
Bobbin precautions	18
Winding the bobbin	18
Installing the bobbin	22
Upper Threading	24
About the spool of thread	24
Loading the spool into the thread cassette	25
Threading the needle	28
Using the extra spool pin	30
Thread the needle manually (without using the needle threader)	31
Using the twin needle	32
Pulling up the bobbin thread	35
Replacing the Needle	36
Needle precautions	36
Needle types and their uses	36
Checking the needle	37
Replacing the needle	38
Replacing the Presser Foot	41
Presser foot precautions	41
Replacing the presser foot	41
Removing the presser foot holder	43
Using the optional walking foot	44
Sewing Cylindrical Pieces	46
Free-arm sewing	46

SEWING BASICS	47
Sewing	48
General sewing procedure	49
Positioning the fabric	50
Starting to sew	51
Securing the stitching	53
Cutting the thread	55
Adjusting the Thread Tension	56
Changing the tension of the upper thread	57
Adjusting the Stitch Width and Length	57
Adjusting the stitch width	57
Adjusting the stitch length	58
Useful Functions	59
Automatically sewing reverse/reinforcement stitches	59
Useful Sewing Tips	61
Trial sewing	61
Changing the sewing direction	61
Sewing curves	61
Sewing thick fabrics	62
Sewing thin fabrics	63
Sewing stretch fabrics	63
Sewing an even seam allowance	63
UTILITY STITCHES	65
Selecting Stitching	66
Stitch types	66
Selecting stitching	66
Overcasting Stitches	68
Sewing overcasting stitches using overcasting foot "G"	68
Sewing overcasting stitches using zigzag foot "J"	69
Sewing overcasting stitches using the optional side cutter	70
Basic Stitching	72
Basting	72
Basic stitching	72
Blind Hem Stitching	74
Buttonhole Stitching	76
Buttonhole sewing	77
Button sewing	80
Zipper Insertion	82
Inserting a centered zipper	82
Inserting a side zipper	83
Sewing Stretch Fabrics and Elastic Tape	86
Stretch stitching	86
Elastic attaching	86
Appliqué, Patchwork and Quilt Stitching	88
Appliqué stitching	89
Patchwork (crazy quilt) stitching	90
Piecing	90
Quilting	91
Free-motion quilting	92
Satin stitching	94
Reinforcement Stitching	95
Triple stretch stitching	95
Bar tack stitching	95
Darning	97
Eyelet Stitching	99

Decorative Stitching	100
Fagoting	101
Scallop stitching	102
Smocking	102
Shell tuck stitching	103
Joining	104
Heirloom stitching	105
Sewing the Various Built-In Decorative Patterns	108
Sewing beautiful patterns	108
Sewing patterns	108
Combining patterns	109
Repeat sewing patterns	110
Checking the selected pattern	111
Changing the pattern length	111
Mirror imaging the pattern	112
Storing a pattern	113
Realigning the pattern	114
APPENDIX	117
Stitch Settings	118
Utility stitches	118
Other stitches	123
Maintenance	124
Cleaning the machine surface	124
Cleaning the shuttle	124
Troubleshooting	126
Error messages	130
Nothing appears in the LCD	131
Operation beep	131
Cancelling the operation beep	132
Index	133

Important Safety Instructions

When using this machine, basic safety precautions should always be taken, including the following:

Read all instructions before using.

DANGER - To reduce the risk of electric shock:

1. The machine should never be left unattended while plugged in. Always unplug the machine from the electrical outlet immediately after using and before cleaning.

WARNING - To reduce the risk of burns, fire, electric shock, or injury to persons:

1. Do not allow this machine to be used as a toy. Close attention is necessary when the machine is used by or near children.
2. Use this machine only for its intended use as described in this manual. Use only accessories recommended by the manufacturer as contained in this manual.
3. Never operate this machine if it has a damaged cord or plug, if it is not working properly, if it has been dropped or damaged, or dropped into water. Return the machine to the nearest authorized dealer or service center for examination, repair, electrical or mechanical adjustment.
4. Never operate the machine with any air openings blocked. Keep ventilation openings of the machine and foot control free from the accumulation of lint, dust, and loose cloth.
5. Never drop or insert any object into any opening.
6. Do not use outdoors.
7. Do not operate where aerosol (spray) products are being used or where oxygen is being administered.
8. To disconnect, turn the main switch to the symbol "O" position which represents off, then remove plug from outlet.
9. Do not unplug by pulling on cord. To unplug, grasp the plug, not the cord.
10. Keep fingers away from all moving parts. Special care is required around the machine needle.
11. Always use the proper needle plate. The wrong plate can cause the needle to break.
12. Do not use bent needles.
13. Do not pull or push fabric while stitching. It may deflect the needle causing it to break.
14. Switch the machine to the symbol "O" position when making any adjustments in the needle area, such as threading needle, changing needle, threading bobbin, or changing presser foot, and the like.
15. Always unplug the machine from the electrical outlet when removing covers, lubricating, or when making any other user servicing adjustments mentioned in the instruction manual.
16. This sewing machine is not intended for use by young children or infirm persons without supervision.
17. Young children should be supervised to ensure that they do not play with this machine.
18. If the Light unit is damaged, it must be replaced by authorized dealer.

SAVE THESE INSTRUCTIONS
This machine is intended for household use.

FOR USERS IN THE UK, EIRE, MALTA AND CYPRUS ONLY

If this machine is fitted with a three-pin non-rewireable BS plug then please read the following.

IMPORTANT

If the available socket outlet is not suitable for the plug supplied with this equipment, it should be cut off and an appropriate three-pin plug fitted. With alternative plugs an approved fuse must be fitted in the plug.

NOTE

The plug served from the main lead must be destroyed as a plug with bared flexible cords is hazardous if engaged in a live socket outlet. In the event of replacing the plug fuse, use a fuse approved by ASTA to BS 1362, i.e. carrying the  mark, rating as marked on plug. Always replace the fuse cover, never use plugs with the fuse cover omitted.

WARNING

DO NOT CONNECT EITHER WIRE TO THE EARTH TERMINAL WHICH IS MARKED WITH THE LETTER 'E', BY THE EARTH SYMBOL  OR COLOURED GREEN OR GREEN AND YELLOW.

The wires in this main lead are colored in accordance with the following code:

Blue	Neutral
Brown	Live

As the colors of the wiring in the main lead of this appliance may not correspond with the colored markings identifying the terminals in your plug, proceed as follows.

The wire which is colored blue must be connected to the terminal which is marked with the letter 'N' or colored black or blue.

The wire which is colored brown must be connected to the terminal which is marked with the letter 'L' or colored red or brown.

CONGRATULATIONS ON CHOOSING OUR MACHINE

Your machine is one of the most advanced computerized household sewing machines. To fully enjoy all the features, we suggest that you study the manual before using the machine.

PLEASE READ BEFORE USING THIS MACHINE

For safe operation

1. Be sure to keep your eye on the needle while sewing. Do not touch the hand wheel, thread take-up lever, needle, or other moving parts.
2. Remember to turn off the power switch and unplug the cord when:
 - Operation is completed
 - Replacing or removing the needle or any other parts
 - A power failure occurs during use
 - Maintaining the machine
 - Leaving the machine unattended
3. Do not store anything on the foot controller.
4. Plug the machine directly into the wall. Do not use extension cords.

For a longer service life

1. When storing this machine, avoid direct sunlight and high humidity locations. Do not use or store the machine near a space heater, iron, halogen lamp, or other hot objects.
2. Use only neutral soaps or detergents to clean the case. Benzene, thinner, and scouring powders can damage the case and machine, and should never be used.
3. Do not drop or hit the machine.
4. Always consult the operation manual when replacing or installing any assemblies, the presser feet, needle, or other parts to assure correct installation.

For repair or adjustment

In the event a malfunction occurs or adjustment is required, first follow the troubleshooting table in the back of the operation manual to inspect and adjust the machine yourself. If the problem persists, please consult your local authorized Brother dealer.

For additional product information and updates, visit our web site at www.brother.com

1

GETTING READY

The various preparations required before starting to sew are described in this chapter.

Turning the Machine On/Off	10
Understanding the LCD Screens	12
Changing the Machine Settings	14
Winding/Installing the Bobbin	18
Upper Threading	24
Replacing the Needle	36
Replacing the Presser Foot	41
Sewing Cylindrical Pieces.....	46

Turning the Machine On/Off

This section explains how to turn the sewing machine on and off.

Power supply precautions

Be sure to observe the following precautions concerning the power supply.

WARNING

- Use only regular household electricity for the power source. Using other power sources may result in fire, electric shock, or damage to the machine.
- Turn off the main power and remove the plug in the following circumstances:
 - When you are away from the machine
 - After using the machine
 - When the power fails during use
 - When the machine does not operate correctly due to a bad connection or a disconnection
 - During electrical storms

CAUTION

- Do not use extension cords or multi-plug adapters with many other appliances plugged in to them. Fire or electric shock may result.
- Do not touch the plug with wet hands. Electric shock may result.
- When unplugging the machine, always turn off the main power first. Always grasp the plug to remove it from the outlet. Pulling on the cord may damage the cord, or lead to fire or electric shock.
- Do not allow the power cord to be cut, damaged, modified, forcefully bent, pulled, twisted, or bundled. Do not place heavy objects on the cord. Do not subject the cord to heat. These things may damage the cord and cause fire or electric shock. If the cord or plug is damaged, take the machine to your authorized dealer for repairs before continuing use.
- Unplug the power cord if the machine is not to be used for a long period of time. Otherwise a fire may result.

Turning on the machine

- 1 Make sure that the sewing machine is turned off (the main power switch is set to "O"), and then plug the power supply cord into the power supply jack on the right side of the machine.
- 2 Insert the plug of the power supply cord into a household electrical outlet.

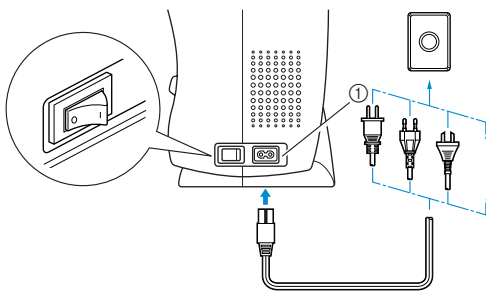

① Power supply jack

- 3 Press the right side of the main power switch on the right side of the machine (set it to "I").

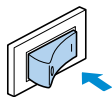

► The sewing lamp comes on when the machine is turned on.

- 4 Fold the flap at the front of the sewing machine down toward you.

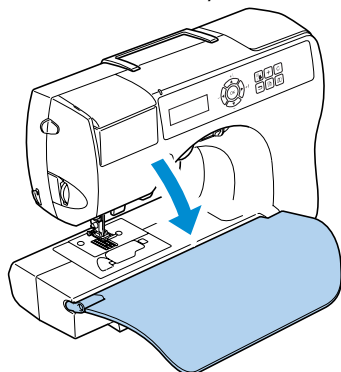

Turning off the machine

When you are finished using the sewing machine, turn it off. In addition, before transporting the sewing machine to another location, be sure to turn it off.

- 1 Make sure that the machine is not sewing.
- 2 Press the left side of the main power switch on the right side of the machine (set it to "O").

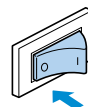

► The sewing lamp goes off when the machine is turned off.

- 3 Unplug the power supply cord from the electrical outlet.
Grasp the plug when unplugging the power supply cord.
- 4 Unplug the power supply cord from the power supply jack.

Note

- If a power outage occurs while the sewing machine is being operated, turn off the sewing machine and unplug the power supply cord. When restarting the sewing machine, follow the necessary procedure to correctly operate the machine.

(For U.S.A only)

- This appliance has a polarized plug (one blade wider than the other). To reduce the risk of electrical shock, this plug is intended to fit in a polarized outlet only one way. If the plug does not fit fully in the outlet, reverse the plug. If it still does not fit, contact a qualified electrician to install the proper outlet. Do not modify the plug in any way.

Understanding the LCD Screens

The LCD screen, located on the front of the sewing machine, displays the settings for the selected stitch and error messages if operations are performed incorrectly.

When the sewing machine is turned on, the LCD comes on and the following screen appears.

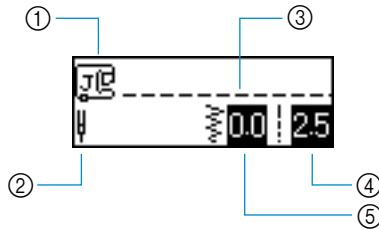

- ① Presser foot that should be used
- ② Single or twin needle
- ③ Selected stitch
- ④ Stitch length (mm)
- ⑤ Stitch width (mm)



Memo

- For details on the error messages that appear when an operation is performed incorrectly, refer to “Error messages” (page 130).

Checking machine operating procedures

Simple descriptions on replacing the presser foot, threading the upper thread, winding the bobbin and installing the bobbin can be displayed in the LCD.

1 Turn on the sewing machine.

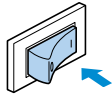

► The LCD comes on.

2 Press (sewing machine help key) in the operation panel.

► The sewing machine help screen appears.

3 Press , , and (arrow keys) until the image illustrating desired topic is selected.

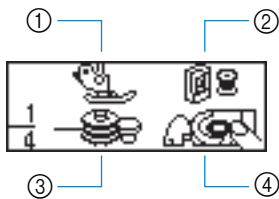

- ① Replacing the presser foot
- ② Threading the upper thread
- ③ Winding the bobbin
- ④ Installing the bobbin

4 Press (OK key).

► The first screen describing the procedure for the selected topic appears.

5 To display the next screen, press . To return to the previous screen, press .

□ Example: Upper threading

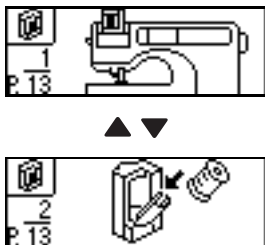

6 When you are finished with the help screen, press (OK key).

► The initial stitch screen appears again.

Note

- For details on each topic, refer to the corresponding page in this Operation Manual.

Changing the Machine Settings

Various sewing machine operations and sewing settings can be changed.

Changing the settings

The general procedure for changing machine settings is described below.



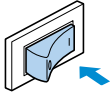

- 1 Turn on the sewing machine.



▶ The LCD comes on.

- 2 Press  (settings key) in the operation panel.



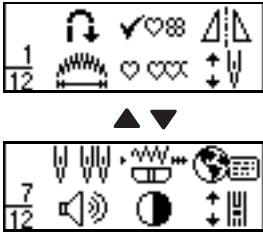

▶ The settings screen appears.

- 3 Press , ,  and  (arrow keys) until the stitch or machine attribute that you wish to set is selected.



- 4 Press  (OK key).

▶ A screen containing settings for the selected attribute appears.

- 5 Press , ,  and  (arrow keys) until the desired setting is selected.













▶ The setting is changed.

- 6 Press  (OK key).

▶ The initial stitch screen appears again.







■ List of stitch or machine attributes

The stitch or machine attributes that can be set are listed below. For details on each attribute, refer to the corresponding reference page.

Attribute	Icon	Details	Reference
Automatic reverse/reinforcement stitching		Specifies automatic reverse/reinforcement stitching.	page 59
Check pattern		Allows combined patterns to be checked.	page 109
Left/right mirror imaging		Mirror images patterns along a vertical axis.	page 112
Pattern length		Adjusts the length of satin stitches.	page 111
Repeated/single sewing		Specifies whether the pattern will be sewn once or repeatedly.	page 110
Needle position		Specifies where the needle is positioned when the sewing machine is stopped.	page 16
Twin needle sewing		Specifies the twin needle.	page 32
Stitch width control		Allows the stitch width to be adjusted with the sewing speed controller.	page 94
Language		Allows the language used in the screens to be changed.	page 17
Buzzer		Specifies whether or not a beep is sounded with each operation.	page 130
LCD brightness		Adjusts the brightness of the LCD.	page 16
Vertical pattern adjustment		Adjusts the up and down position of the pattern.	page 114





Changing the needle stop position

When the sewing machine is purchased, it is set to leave the needle lowered in the fabric when sewing is stopped. However, the machine can be set to instead leave the needle raised when sewing is stopped.

- 1 Press  (settings key) in the operation panel, and then press , ,  and  (arrow keys) until  is selected.



- 2 Press  (OK key).
 - ▶ The screen for changing the needle stop position appears.

- 3 Press  to select . To return to , press .

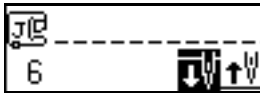

- ▶ The machine is now set to stop with the needle in the raised position.



- 4 Press  (OK key).
 - ▶ The initial stitch screen appears again.

Adjusting the brightness of the LCD

The brightness of the LCD can be adjusted.

- 1 Press  (settings key) in the operation panel, and then press , ,  and  (arrow keys) until  is selected.



- 2 Press  (OK key).
 - ▶ The screen for changing the brightness of the LCD appears.
- 3 To make the LCD brighter, press  (-). To make the LCD darker, press  (+).



- ▶ The brightness of the LCD is changed.

- 4 Press  (OK key).
 - ▶ The initial stitch screen appears again.

Changing the screen language

The language used in the screens that are displayed can be changed to one of the many available.

- 1 Press  (settings key) in the operation panel, and then press ▲, ▼, ◀ and ▶ (arrow keys) until  is selected.



- 2 Press  (OK key).
 - ▶ The screen for changing the language of the screens appears.

- 3 Press ◀ or ▶ until the desired language is selected.

The language can be changed to one of the available: English, French, German, Dutch, Spanish, Italian, Danish, Norwegian, Finnish, Swedish, Portuguese, Russian, Japanese, Korean or others.

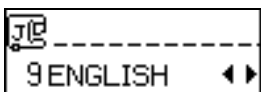

- ▶ The language of the screens is changed.

- 4 Press  (OK key).
 - ▶ The initial stitch screen appears again.

Winding/Installing the Bobbin

This section describes how to wind the thread onto the bobbin, and then insert the bobbin thread.

Bobbin precautions

Be sure to observe the following precautions concerning the bobbin.

CAUTION

- Only use the bobbin (part code: SA156, XA5539-151) designed specifically for this sewing machine. Use of any other bobbin may result in injuries or damage to the machine.
- The enclosed bobbin was designed specifically for this sewing machine. If bobbins from older models are used, the machine will not operate correctly. Use only the enclosed bobbin or bobbins of the same type (part code: SA156, XA5539-151).

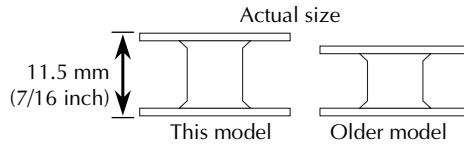

Winding the bobbin

Wind the thread around the bobbin to prepare the bobbin thread.

- 1 Turn on the sewing machine.

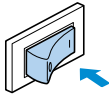

- 2 Open the bobbin winder cover at the top on the right side of the sewing machine.

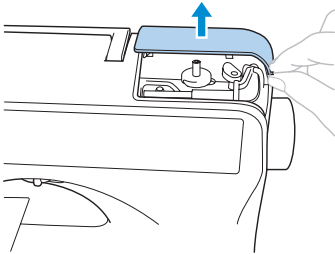

- 3 Swing up the bobbin thread spool pin. Move the bobbin thread spool pin up as far as possible.

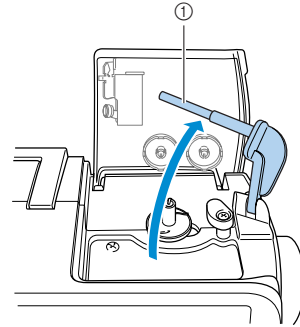

① Bobbin thread spool pin

- 4 Place the bobbin on the bobbin winder shaft so that the spring on the shaft fits into the notch in the bobbin.

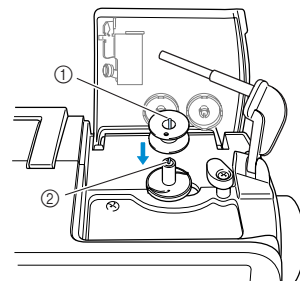

① Notch
② Bobbin winder shaft spring

- 5 Slide the bobbin winder shaft to the right.

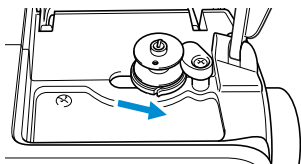

- 6 Place the spool of thread for the bobbin onto the bobbin thread spool pin.

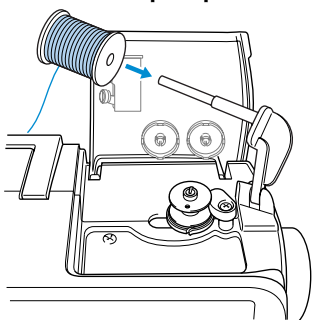

- 7 Slide the spool cap onto the bobbin thread spool pin.

With the rounded side of the spool cap positioned toward the left, slide the spool cap onto the bobbin thread spool pin as far as possible until the right side of the spool touches the right end of the bobbin thread spool pin.

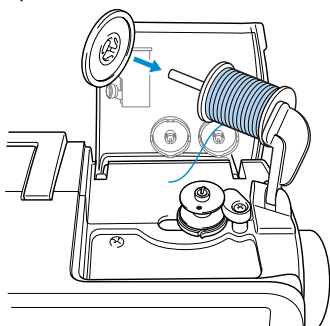

! CAUTION

- Two spool cap sizes are available, allowing you to choose a spool cap that best fits the size of spool being used. If the spool cap is too small for the spool being used, the thread may catch on the slit in the spool or the needle may break.

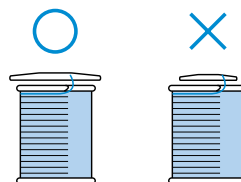

☀ Note

- If a spool of thread 12 mm (1/2 inch) in diameter and 75 mm (3 inch) high is inserted onto the bobbin thread spool pin, use the special spool cap.

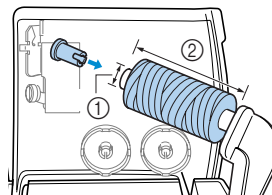

- ① 12 mm (1/2 inch)
- ② 75 mm (3 inch)

**Memo**

- When using thread that winds off quickly, such as transparent nylon thread or metallic thread, place the enclosed spool net over the spool before placing the spool of thread onto the spool pin.

If the spool net is too long, fold it to fit the size of the spool.

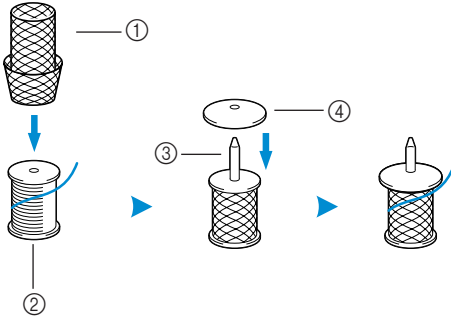

- ① Spool net
- ② Spool
- ③ Spool pin
- ④ Spool cap

8 Pull out some thread, and then thread the thread guide for bobbin winding.

Hold the thread with both hands, and then securely pass the thread as far as possible into the two slits in the thread guide.

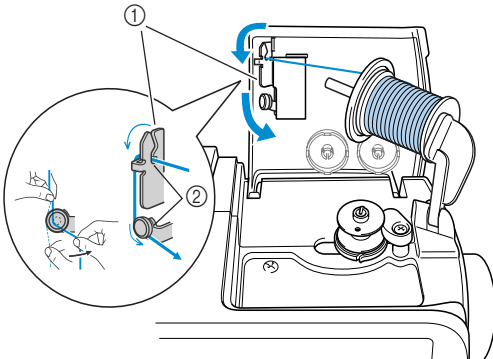

- ① Thread guide for bobbin winding
- ② Two slits

- 9** While using your left hand to hold the end of the thread that wraps around the thread guide for bobbin winding, use your right hand to wind the free end of the thread clockwise around the bobbin five or six times.

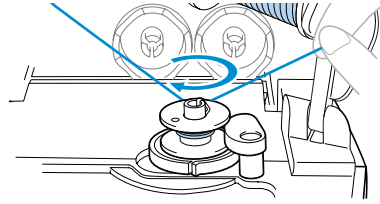

- 10** Pull the thread to the right and pass it through the slit in the bobbin winder seat.

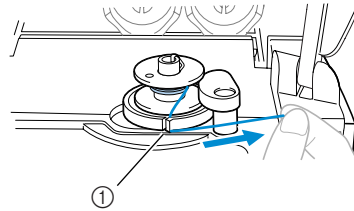

- ① Slit in bobbin winder seat (with built-in cutter)
- ▶ The thread is cut to a suitable length.

CAUTION

- Be sure to cut the thread as described. If the bobbin is wound without cutting the thread using the cutter built into the slit in the bobbin winder seat, the thread may become tangled in the bobbin or the needle may bend or break when the bobbin thread starts to run out.

- 11** Slide the sewing speed controller to the right (so that the speed will be fast).

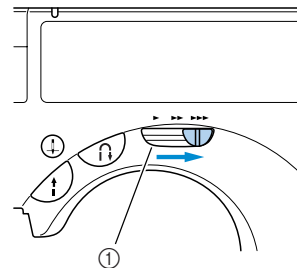

- ① Sewing speed controller

- 12** Press  (start/stop button) once.

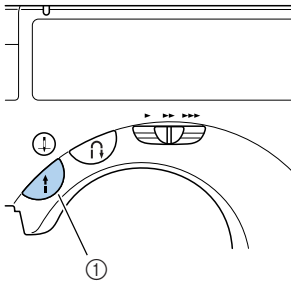

① Start/stop button

- ▶ The bobbin starts spinning and the thread is wound around the bobbin.
- ▶ The bobbin spins slowly when it is full.

- 13** When the bobbin begins spinning slowly,

Press  (start/stop button) once.

- ▶ The sewing machine stops.

- 14** Use scissors to cut the end of the thread wound around the bobbin.

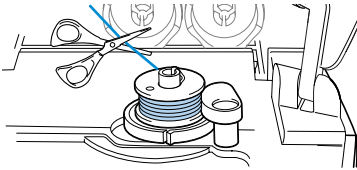

- 15** Slide the bobbin winder shaft to the left.

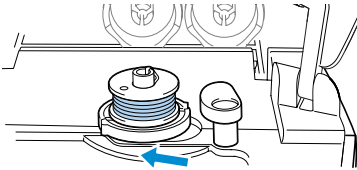

- 16** Remove the bobbin from the shaft.

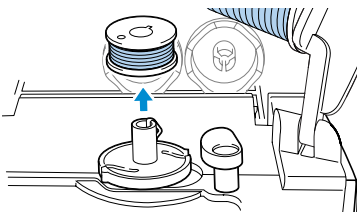

- 17** Remove the spool cap and spool.

- 18** Swing down the bobbin thread spool pin, close the bobbin winder cover, and then slide the sewing speed controller back to its original position.



Memo

- When the sewing machine is started or the balance wheel is turned after winding the thread around the bobbin, the machine will make a clicking sound; this is not a malfunction.

Installing the bobbin

Install the bobbin wound with thread.

CAUTION

- Use a bobbin thread that has been correctly wound, otherwise the needle may break or the thread tension will be incorrect.

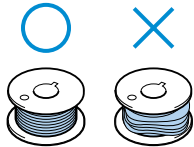

- The bobbin was designed specifically for this sewing machine. If bobbins from older models are used, the machine will not operate correctly. Use only the enclosed bobbin or bobbins of the same type (part code: SA156, XA5539-151).

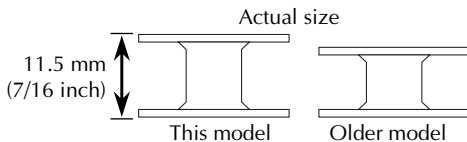

Memo

- The order that the bobbin thread should be passed through the needle plate is indicated by marks around the shuttle. Be sure to thread the machine as indicated.

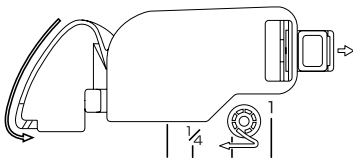

- 1 Slide the bobbin cover latch to the right.

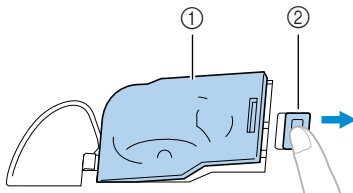

- 1 Bobbin cover
- 2 Latch

▶ The bobbin cover opens.

- 2 Remove the bobbin cover.

- 3 Hold the bobbin with your right hand and hold the end of the thread with your left.

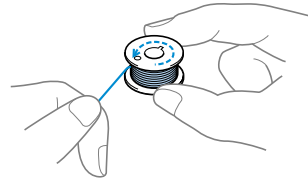

- Be careful not to drop the bobbin.

- 4 Insert the bobbin into the shuttle so that the thread unrolls to the left.

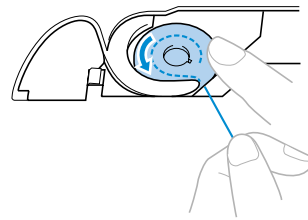

- Be sure to insert the bobbin correctly.

- 5 Lightly hold down the bobbin with your right hand, and then guide the thread as shown with your left hand.

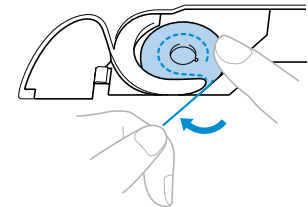

CAUTION

- Be sure to hold down the bobbin with your finger and unroll the bobbin thread correctly, otherwise the thread may break or the thread tension will be incorrect.

- 6** Pass the thread through the slot as shown, and then pull the thread out toward the front.

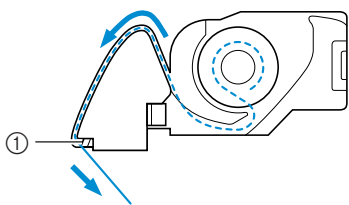

① Cutter

► The cutter cuts the thread.

- 7** Reattach the bobbin cover. Insert the tab in the lower-left corner of the bobbin cover, and then lightly press down on the right side.

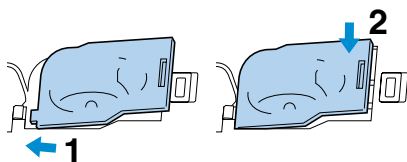

► The lower threading is finished.

Next, thread the upper thread. Continue with the procedure in “Upper Threading” (on the next page).

Memo

- You can begin sewing without pulling up the bobbin thread. If you wish to pull up the bobbin thread before starting to sew, pull up the thread according to the procedure in “Pulling up the bobbin thread” (page 35).

Upper Threading

In this section, the procedures for positioning the spool for the upper thread and threading the needle are described.

CAUTION

- When threading the upper thread, carefully follow the instructions. If the upper threading is not correct, the thread may become tangled or the needle may bend or break.

About the spool of thread

With this sewing machine, a spool of thread can be loaded into the enclosed thread cassette, and then the thread cassette can be threaded. Information about the spools of thread is described below.

■ Spools that can be loaded into the thread cassette

Normally, a spool of thread is loaded into the thread cassette and used. The spools that can be loaded must have a diameter smaller than the orange spool cap and a height shorter than the mark on the cover of the thread cassette.

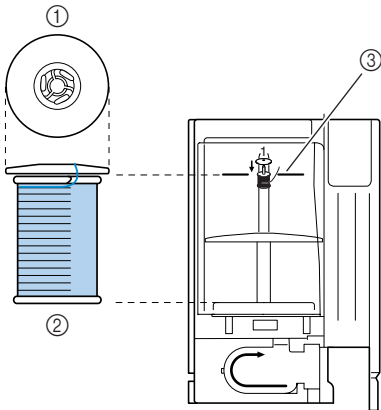

- ① Spool cap (orange)
- ② Spool
- ③ Mark on thread cassette compartment cover

■ Spools that cannot be loaded into the thread cassette

When using spools that cannot be loaded into the thread cassette, use the enclosed extra spool pin.

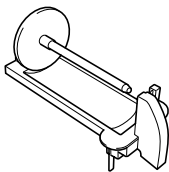

When using the extra spool pin, attach either the large or small white spool cap, depending on the size of the spool. Use the spool cap with a diameter that is slightly larger than the diameter of the spool.

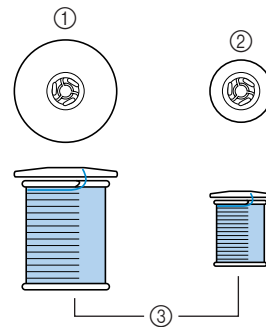

- ① Spool cap (large)
- ② Spool cap (small)
- ③ Spool

Memo

- For details on using the extra spool pin, refer to "Using the extra spool pin" (page 30).
- When using a spool of cross-wound thread, install the small white spool cap with some space between the cap and the spool.

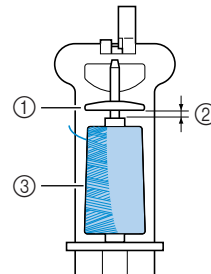

- ① Spool cap (small)
- ② Gap
- ③ Spool

! CAUTION

- Two spool cap sizes are available, allowing you to choose a spool cap that best fits the size of spool being used. If the spool cap is too small for the spool being used, the thread may catch on the slit in the spool or the needle may break.

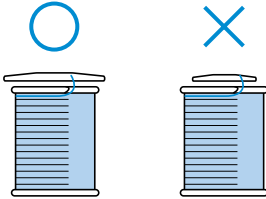

Loading the spool into the thread cassette

Load the spool of thread into the enclosed thread cassette to prepare the upper thread.

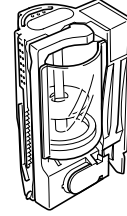

Memo

- The order for threading the thread cassette is indicated on the thread cassette. Also check the markings on the thread cassette while threading it.

- 1 Turn on the sewing machine.

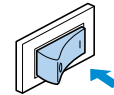

- 2 Open the thread cassette compartment cover at the top on the left side of the machine.

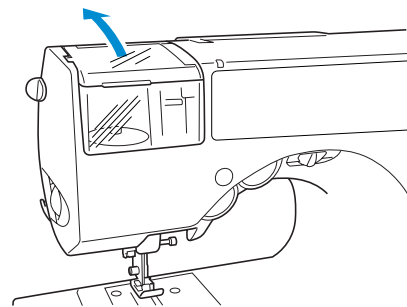

- 3** Push the thread cassette eject lever on the left side of the machine toward the back.

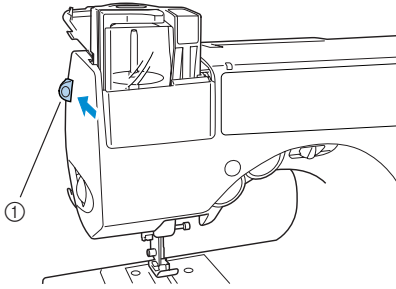

① Thread cassette eject lever

► The thread cassette is raised.

- If the sewing machine is turned off, the thread cassette will not be ejected correctly.

- 4** Remove the thread cassette.

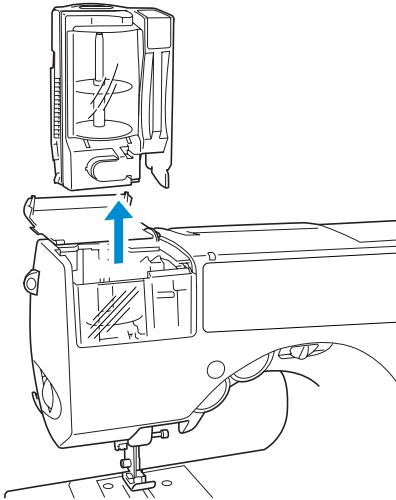

- 5** Pull the cover of the thread cassette out toward you, and then pull off the spool cap that is inserted onto the spool pin.

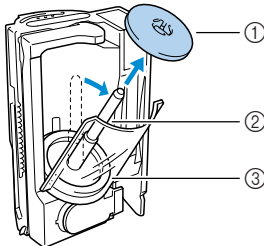

① Spool cap (orange)
② Spool pin
③ Cover

- 6** Place the spool for the upper thread onto the spool pin.

Slide the spool onto the spool pin so that the thread unwinds from the left, as seen from the top.

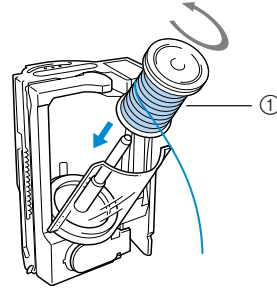

① Spool

- 7** Slide the spool cap onto the spool pin.

With the rounded side of the spool cap positioned toward the top, slide the spool cap onto the spool pin as far as possible until the down side of the spool touches the down end of the spool pin.

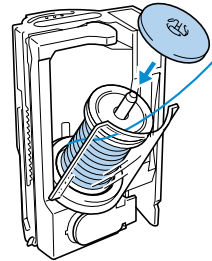

- Only the orange spool cap should be placed on the spool pin in the thread cassette.

! CAUTION

- If the spool or the spool cap is not positioned correctly, the thread may become tangled around the spool pin or the needle may break.

- 8** While holding the end of the thread with your right hand and the thread cassette with your left hand, close the cover.

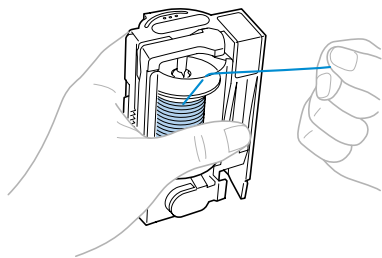

- 9** Pass the thread through the slit in the top of the thread cassette.
Follow arrow 2 indicated on the thread cassette.

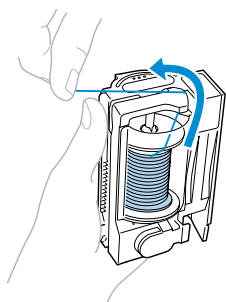

- 10** Pull the thread to the left and pass it through the slit along the left side of the thread cassette.
Follow arrow 3 indicated on the thread cassette.

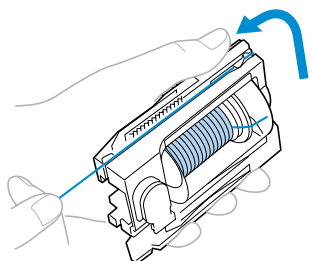

- When using special thread such as metallic thread, use the thumb of your left hand to press down on the area indicated in the illustration to create an opening that allows for easier threading.

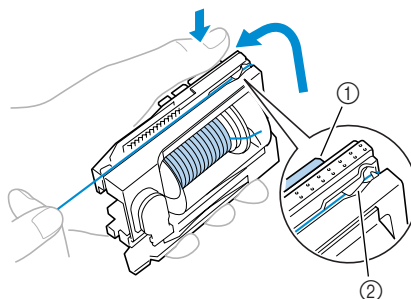

- ① Push
② Gap

- 11** Pass the thread along the bottom of the thread cassette.
Follow arrow 4 indicated on the thread cassette.

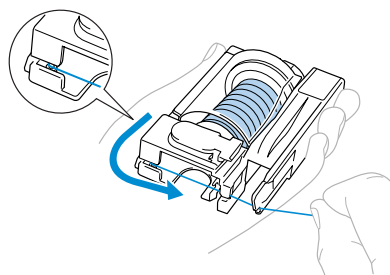

- 12** Pass the thread through the notch in the lower-right corner of the thread cassette, and then pull the thread to the left.
Follow arrow 5 indicated on the thread cassette.

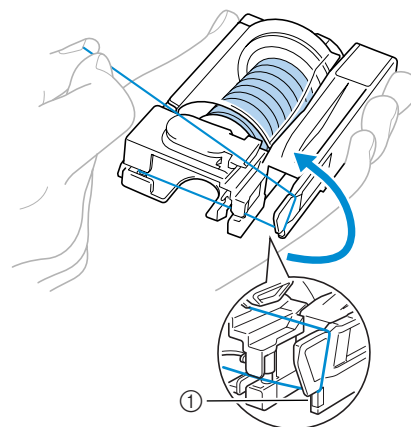

- ① Notch

- 13** Pull the thread under the disc at the front in the lower-left corner and around to the right, and then cut the thread with the cutter. Follow arrow 6 indicated on the thread cassette.

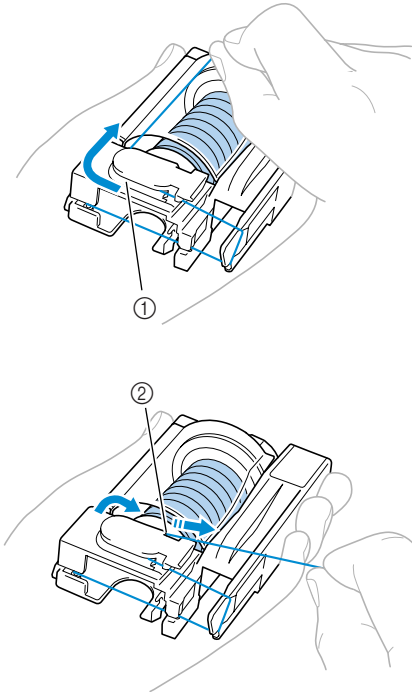

- ① Disc
② Cutter

- ▶ The spool of thread is now loaded in the thread cassette.



Note

- Be sure to cut the thread as described above, otherwise the needle threader cannot be used to thread the needle.

Threading the needle

In this section, the procedures for installing the thread cassette and threading the needle are described. The needle threader is used to thread the needle at the same time that the thread cassette is inserted.



Memo

- The needle threader can be used with sewing machine needles 75/11 through 100/16.
- Thread with a thickness of 130/20 or less cannot be used with the needle threader.
- The needle threader cannot be used with the wing needle or the twin needle.
- If the needle threader cannot be used, refer to "Threading the needle manually" (page 31).

- 1** Check that the thread cassette indicator is lit up in green.

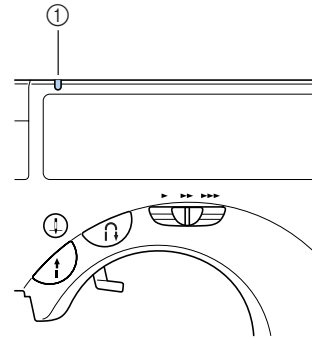

- ① Thread cassette indicator

If the thread cassette indicator is lit up in red, the needle has not been raised to the correct position. Press  (needle position button) once to raise the needle.

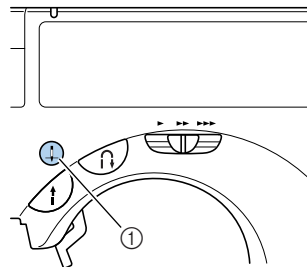

- ① Needle position button

- If the needle is not raised to the correct position, the needle cannot be threaded with the needle threader. Be sure to check that the thread cassette indicator is lit up in green before inserting the thread cassette.

2 Insert the thread cassette into the thread cassette compartment.

Slowly press down on the thread cassette until it clicks into place.

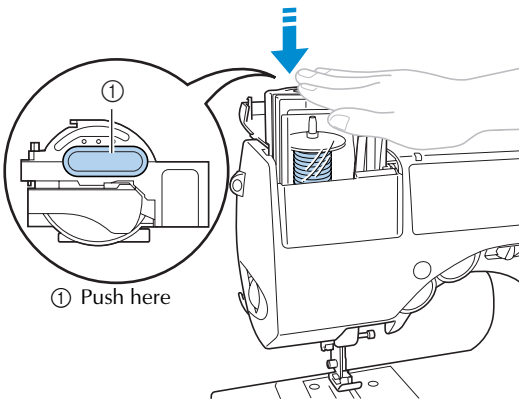
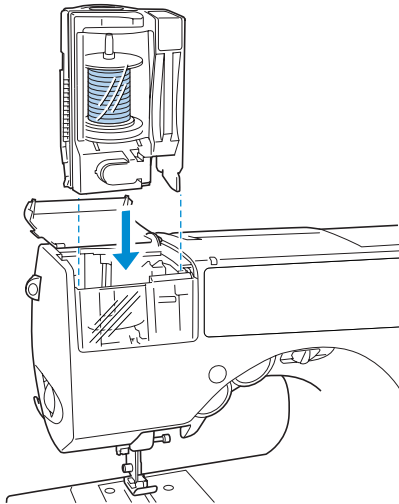

① Push here

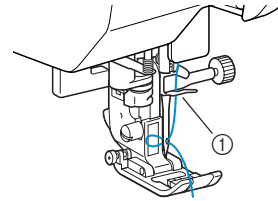
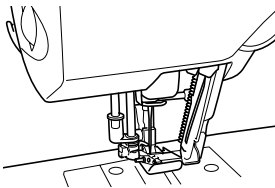

① Needle bar thread hook

▶ At the same time that the thread cassette is inserted, the needle is threaded.

▶ The thread cassette indicator goes off.

- If the needle could not be threaded or the thread was not passed through the needle bar thread hook, refer to “Loading the spool into the thread cassette” (page 25) and perform the procedure again starting from step e.

! CAUTION

- The needle threader is operated when the needle is threaded. Be sure to keep your hands and other items away from the needle, otherwise injuries may occur.

3 Raise the presser foot lever, carefully pull on the loop of thread passed through the eye of the needle to pull out the end of the thread.

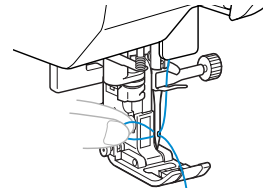

4 Pass the thread through the presser foot, and then pull out about 10-15 cm (3/8-5/8 inch) of thread toward the rear of the machine.

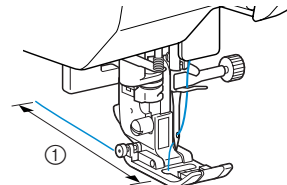

① 10-15 cm (3/8-5/8 inch)

▶ The upper threading is finished.

5 Close the thread cassette compartment cover.

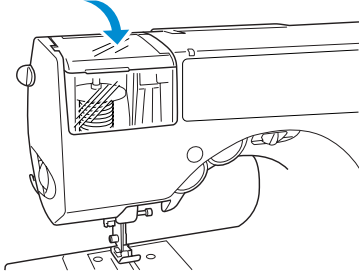

- Now that the upper threading and the lower threading are finished, you are ready to begin sewing.



Note

- When inserting the thread cassette into its compartment, slowly press it down.
- If the sewing machine could not be threaded, try performing the procedure again starting from loading the spool of thread into the thread cassette.

Using the extra spool pin

When using spools with a size that cannot be loaded into the thread cassette, use the enclosed extra spool pin.

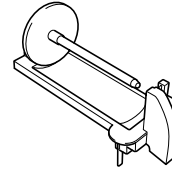

1 Place the spool of thread onto the extra spool pin.

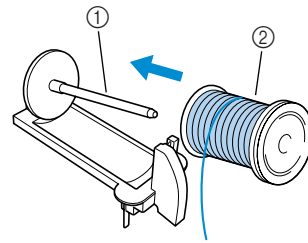

- ① Extra spool pin
- ② Spool

2 Slide the spool cap for the size of the spool onto the spool pin.

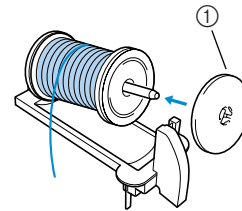

- ① Spool cap
- For more details, refer to “About the spool of thread” (page 24).

3 Insert the tabs on the extra spool pin into the holes on the top of the thread cassette.

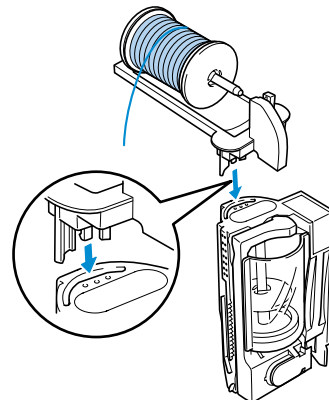

- 4** Thread the thread cassette with the thread from the spool on the extra spool pin.

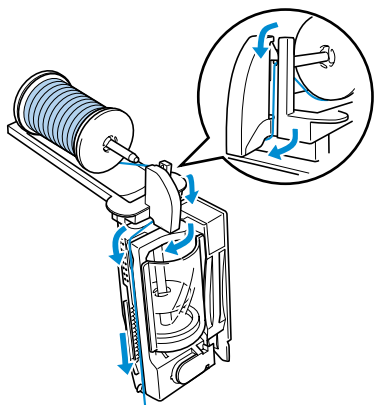

- For more details, refer to “Loading the spool into the thread cassette” (page 25).

- 5** Insert the thread cassette (with the extra spool pin attached) into the thread cassette compartment.

Use both hands to press down on both sides of the extra spool pin.

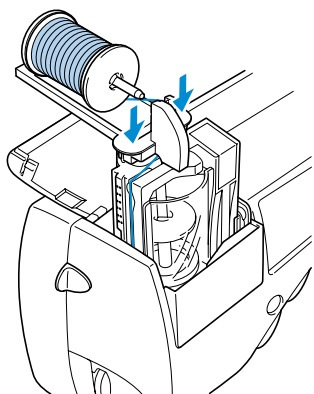

- ▶ At the same time that the thread cassette is inserted, the needle is threaded.
- ▶ The extra spool pin is now installed.

Thread the needle manually (without using the needle threader)

When using special thread, thread with a thickness of 130/20 or less, the wing needle or the twin needle which cannot be used with the needle threader, thread the needle as described below.

- 1** Remove the needle.
- Refer to “Replacing the needle” (page 38).
 - When using the wing needle, the twin needle or thread that cannot be used with the needle threader, be sure to remove the needle, otherwise the machine may be damaged.
- 2** Check that the thread cassette indicator is lit up in green, and then insert the thread cassette into the thread cassette compartment.
- For details, refer to 1 through 2 (page 28).
- ▶ Pass the thread through the needle bar thread hook.

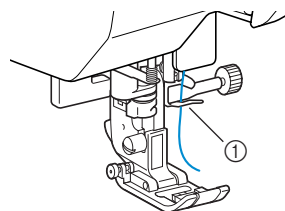

① Needle bar thread hook

- 3** Install a needle.
- Refer to “Replacing the needle” (page 38).
- 4** Pass the thread through the eye of the needle from front to back.

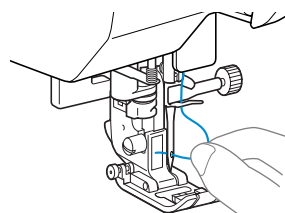

Using the twin needle

Using the twin needle, you can sew two parallel lines of the same stitch with two different colors. Both upper threads should have the same thickness and quality. Be sure to use the enclosed twin needle and the extra spool pin.

For details on the stitches that can be sewn with the twin needle, refer to "Stitch Settings" (page 118).

! CAUTION

- **Only use the twin needle (Part code : X59296-051).**
Use of any other needle may bend the needle or damage the machine.
- **Never use bent needles. Bent needles can easily break, possibly resulting in injuries.**
- **Do not try installing the twin needle while the thread cassette is not installed, otherwise the needle may break or damage to the machine may result.**

1 Remove the needle.

- For details, refer to "Replacing the Needle" (page 36).

2 Load the spool for the first thread color into the thread cassette.

Thread the thread cassette up to arrow 2, indicated on the thread cassette.

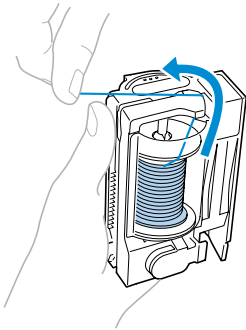

- For more details, refer to steps 1 through 9 in "Loading the spool into the thread cassette" (page 25).

3 Load the spool for the second thread color onto the extra spool pin.

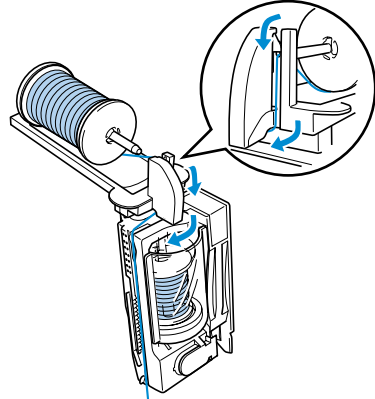

- For more details, refer to steps 1 through 4 in "Using the extra spool pin" (page 30).

4 Use the two threads to thread the thread cassette, and then cut the threads.

Thread the thread cassette along arrows 3 through 6, indicated on the thread cassette.

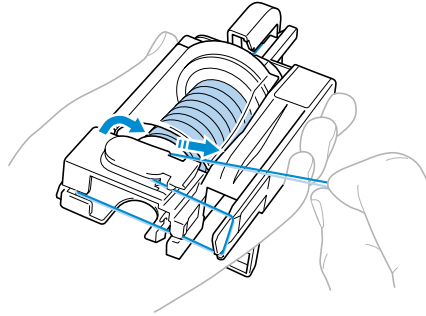

- For more details, refer to steps 10 through 13 in "Loading the spool into the thread cassette" (page 25).

- 5** Insert the thread cartridge (with the extra spool pin attached) into the thread cassette compartment.

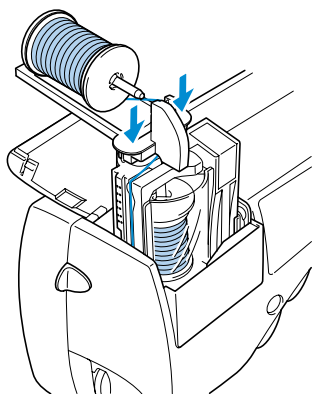

- For more details, refer to step **5** in “Using the extra spool pin” (page 30).
- ▶ Pass both threads through the needle bar thread hook.
- The needle threader cannot be used. If the needle threader is used with the twin needle, the sewing machine may be damaged.

- 6** Install the twin needle.
- For details, refer to “Replacing the needle” (page 36).

- 7** Manually thread the left needle with the thread for the left side of the stitch.
- For details, refer to “Thread the needle manually” (page 31).

- 8** Remove the thread for the right side of the stitch from the needle bar thread hook, and then use it to thread the right needle.

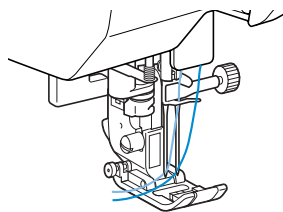

- 9** Attach zigzag foot “J”.
- For details on changing the presser foot, refer to “Replacing the presser foot” (page 41).

! CAUTION



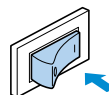

- When using the twin needle, be sure to attach zigzag foot “J”, otherwise the needle may break or the machine may be damaged.

- 10** Turn on the sewing machine.







- ▶ The LCD comes on.

- 11** Press  (settings key) in the operation panel.
- ▶ The settings screen appears.

- 12** Press , ,  and  (arrow keys) until  is selected.



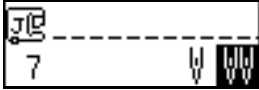

- 13** Press  (OK key).
- ▶ The screen for selecting the twin needle appears.

- 14** Press  to select .
- To return to , press .



- ▶ The twin needle can now be used.

- 15** Press  (OK key).
- ▶ The initial stitch screen appears again, and  appears in the lower-left corner of the screen.

**Note**

- Even after the sewing machine is turned off, the twin needle setting is not cancelled.

CAUTION

- When using the twin needle, be sure to select the twin needle setting, otherwise the needle may break or the machine may be damaged.

- 16** Select a stitch.
- For details on selecting a stitch, refer to “Selecting stitching” (page 66).
 - For details on the stitches that can be sewn with the twin needle, refer to “Stitch Settings” (page 118).

CAUTION

- When using the twin needle, be sure to select an appropriate stitch, otherwise the needle may break or the machine may be damaged.

- 17** Start sewing.

- For details on starting to sew, refer to “Starting to sew” (page 51).
- ▶ Two lines of stitching are sewn parallel to each other.

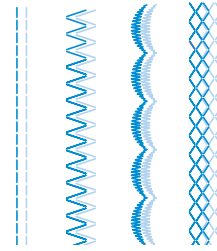
**Note**

- When changing the sewing direction, press  (needle position button) to raise the needle from the fabric, and then raise the presser foot lever and turn the fabric.

**CAUTION**

- Do not try turning the fabric with the twin needle left in the fabric, otherwise the needle may break or the machine may be damaged.

Pulling up the bobbin thread

When making gathers or before free-motion quilting, first pull up the bobbin thread as described below.

- 1 Insert the bobbin into the shuttle.**
 - Refer to steps 1 through 5 of "Installing the bobbin" (page 22).
- 2 Pass the bobbin thread through the slot.**
Do not cut the thread with the cutter.

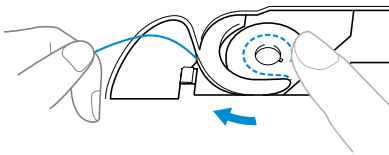

- 3 While lightly holding the upper thread with your left hand, press \oplus (needle position button) twice to raise the needle.**

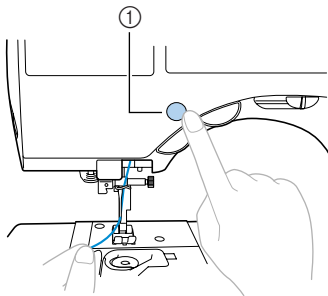

① Needle position button

- The bobbin thread is looped around the upper thread and can be pulled up.

- 4 Carefully pull the upper thread upward to pull out the end of the bobbin thread.**

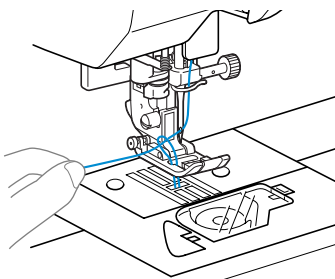

- 5 Pull out about 10-15 cm (3/8-5/8 inch) of the bobbin thread under the presser foot toward the rear of the machine.**

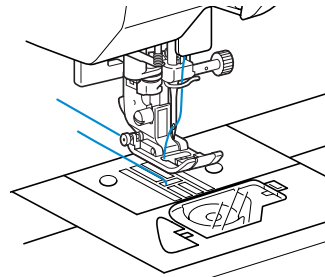

- 6 Reattach the bobbin cover.**
Insert the tab in the lower-left corner of the bobbin cover, and then lightly press down on the right side.

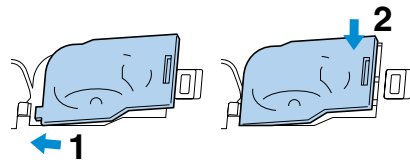

Replacing the Needle

This section provides information on sewing machine needles.

Needle precautions

Be sure to observe the following precautions concerning the handling of the needle. Failure to observe these precautions is extremely dangerous, for example, if the needle breaks and fragments are dispersed. Be sure to read and carefully follow the instructions below.

CAUTION

- Only use home sewing machine needles. Use of any other needle may bend the needle or damage the machine.
- Never use bent needles. Bent needles can easily break, possibly resulting in injuries.

Needle types and their uses

The sewing machine needle that should be used depends on the fabric and thread thickness. Refer to the following table when choosing the thread and needle appropriate for the fabric that you wish to sew.

Fabric Type/Application		Thread		Size of Needle
		Type	Size	
Medium weight fabrics	Broadcloth	Cotton thread	60–80	75/11–90/14
	Taffeta	Synthetic thread		
	Flannel, Gabardine	Silk thread	50–80	
Thin fabrics	Lawn	Cotton thread	60–80	65/9–75/11
	Georgette	Synthetic thread		
	Challis, Satin	Silk thread	50–80	
Thick fabrics	Denim	Cotton thread	30–50	90/14–100/16
	Corduroy	Synthetic thread	50	
	Tweed	Silk thread		
Stretch fabrics	Jersey	Thread for knits	50–60	Ball point needle (golden colored) 75/11–90/14
	Tricot			
Easily frayed fabrics		Cotton thread	50–80	65/9–90/14
		Synthetic thread		
		Silk thread		
For top-stitching		Synthetic thread	30	90/14–100/16
		Silk thread		



Memo

- The smaller the thread number, the thicker the thread, and the larger the needle number, the thicker the needle.
- Use the ball point needle when sewing on stretch fabrics or fabrics where skipped stitches easily occur.
- Use a 90/14 to 100/16 needle with transparent nylon threads, regardless of the fabric being sewn.
- A 75/11 needle is already installed when the sewing machine is purchased.



CAUTION

- The appropriate fabric, thread and needle combinations are shown in the table on the previous page. If the combination of the fabric, thread and needle is not correct, particularly when sewing thick fabrics (such as denim) with thin needles (such as 65/9 to 75/11), the needle may bend or break. In addition, the stitching may be uneven or puckered or there may be skipped stitches.

Checking the needle

Sewing with a bent needle is extremely dangerous since the needle may break while the machine is being operated.

Before using the needle, place the flat side of the needle on a flat surface and check that the distance between the needle and the flat surface is even.

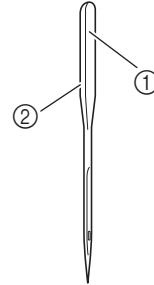

- ① Flat side
- ② Needle type marking

■ Correct needle

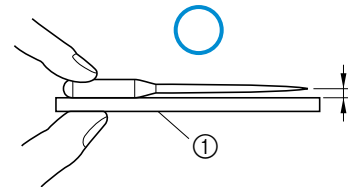

- ① Flat surface

■ Incorrect needle

If the distance between the needle and the flat surface is not even, the needle is bent. Do not use a bent needle.

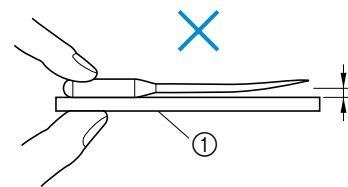

- ① Flat surface

Replacing the needle

Replace the needle as described below. Use the screwdriver and a needle that has been determined to be straight according to the instructions in "Checking the needle".

- 1** Press  (needle position button) once or twice to raise the needle.

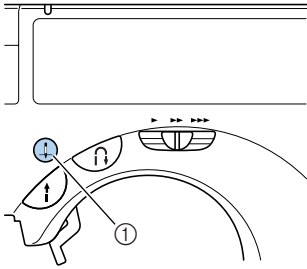

① Needle position button

- 2** Turn off the sewing machine.

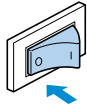

CAUTION

- Before replacing the needle, be sure to turn off the sewing machine, otherwise injuries may occur if the start/stop button is accidentally pressed and the machine starts sewing.

- 3** Lower the presser foot lever.

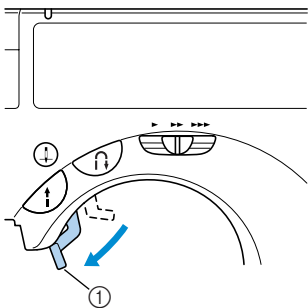

① Presser foot lever

- 4** Hold the needle with your left hand, and then use a screwdriver to turn the needle clamp screw counterclockwise to remove the needle.

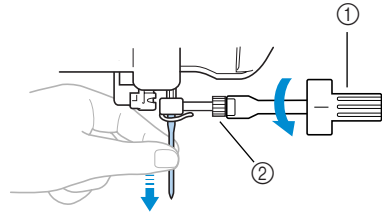

- ① Screwdriver
② Needle clamp screw
- Do not apply a strong force when loosening or tightening the needle clamp screw, otherwise certain parts of the sewing machine may be damaged.

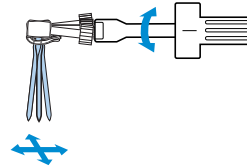

- 5** With the flat side of the needle toward the rear of the machine, insert the needle until it touches the needle stopper.

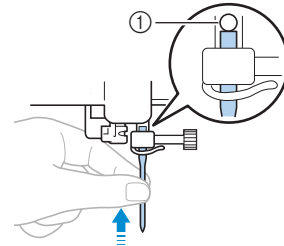

① Needle stopper

- 6** While holding the needle with your left hand, use the screwdriver to tighten the needle clamp screw.

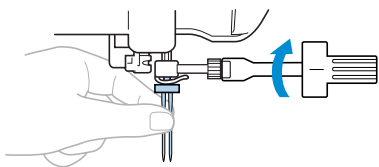

Install the twin needle in the same way.

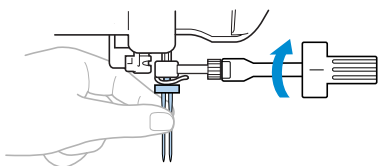

CAUTION

- Be sure to insert the needle until it touches the needle stopper and securely tighten the needle clamp screw with the screwdriver, otherwise the needle may break or damage may result.

■ **Using the needle-changing tool**

Use the enclosed needle-changing tool to replace the needle as described below.

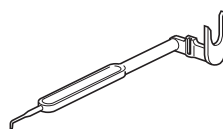

- 1** Pass the needle through the hole in the needle-changing tool.

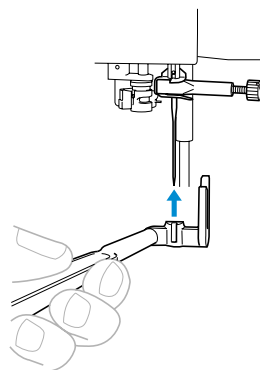

- 2** Lift up the needle-changing tool so that the fork hooks onto the needle clamp screw.

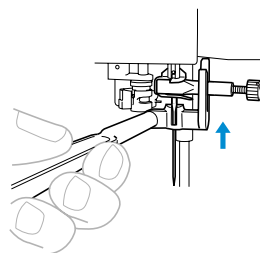

- 3** Using the screwdriver, loosen the needle clamp screw.

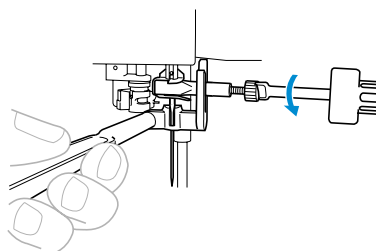

- 4** Lower the needle-changing tool.

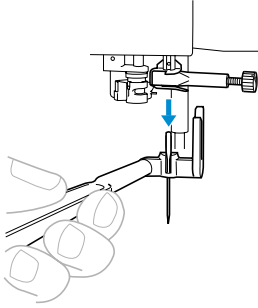

- The needle can be removed from the needle bar.

- 5** Insert the new needle into the hole in the needle-changing tool.

Insert the needle with the flat side of the needle toward the rear of the machine.

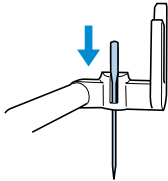

- 6** Lift up the needle-changing tool so that the fork hooks onto the needle clamp screw.

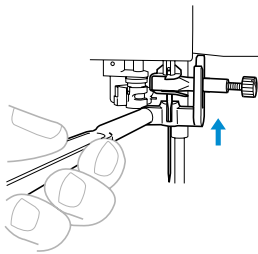

- 7** Insert the needle until it touches the needle stopper, and then use the screwdriver to tighten the needle clamp screw.

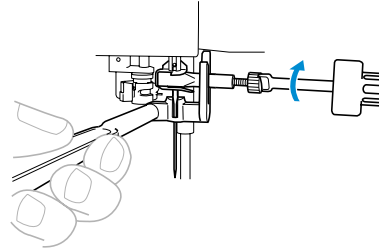

- The needle is installed.

- 8** Lower the needle-changing tool off of the needle.

Replacing the Presser Foot

The presser foot presses down on the fabric.

Presser foot precautions

Be sure to observe the following precautions concerning the presser feet.

! CAUTION

- Use the presser foot appropriate for the type of stitch that you wish to sew, otherwise the needle may hit the presser foot, causing the needle to bend or break.
- Only use presser feet designed specifically for this sewing machine. Use of any other presser foot may result in injuries or damage to the machine.

Replacing the presser foot

Replace the presser foot as described below.

- 1 Press **+** (needle position button) once or twice to raise the needle.

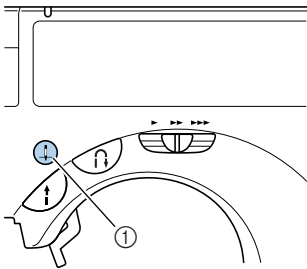

- ① Needle position button
- ▶ The needle is raised.

- 2 Turn off the sewing machine.

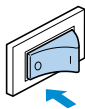

! CAUTION

- Before replacing the presser foot, be sure to turn off the sewing machine, otherwise injuries may occur if the start/stop button is accidentally pressed and the machine starts sewing.

- 3 Raise the presser foot lever.

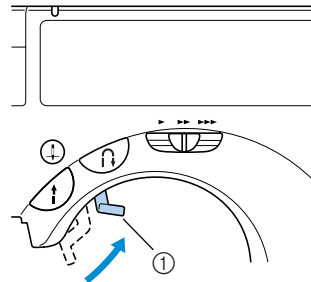

- ① Presser foot lever
- ▶ The presser foot is raised.

- 4** Press the black button at the back of the presser foot holder.

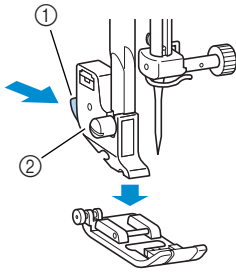

- ① Black button
② Presser foot holder

► The presser foot holder releases the presser foot.

- 5** Place a different presser foot below the holder so that the presser foot pin is aligned with the notch in the holder.

Position the presser foot so the letter indicating the presser foot type (A, G, I, J, M, N or R) is positioned to be read.

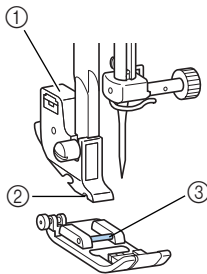

- ① Presser foot holder
② Notch
③ Pin

- 6** Slowly lower the presser foot lever so that the presser foot pin snaps into the notch in the presser foot holder.

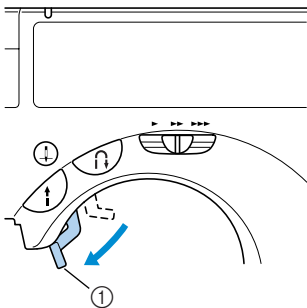

- ① Presser foot lever

► The presser foot is attached.

- 7** Raise the presser foot lever to check that the presser foot is securely attached.

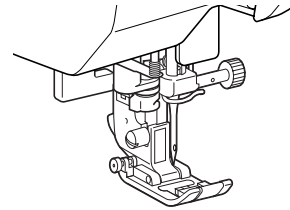

Note

- When a stitch is selected, the icon for the presser foot that should be used appears in the screen. Check that the correct presser foot is attached before starting to sew. If the wrong presser foot is installed, turn off the sewing machine, attach the correct presser foot, and then select the desired stitch again.



Buttonhole foot "A"



Overcasting foot "G"



Zigzag foot "J"



Button fitting foot "M"



Monogramming foot "N"



Blind stitch foot "R"



Side cutter "S"

- For details on the presser foot that should be used with the selected stitch, refer to "Stitch Settings" (page 118).

Removing the presser foot holder

Remove the presser foot holder when cleaning the sewing machine or when installing a presser foot that does not use the presser foot holder, such as the quilting foot. Use the screwdriver to remove the presser foot holder.

■ Removing the presser foot holder

- 1 Remove the presser foot.
 - For details, refer to "Replacing the presser foot" (page 41).
- 2 Use the screwdriver to loosen the presser foot holder screw.

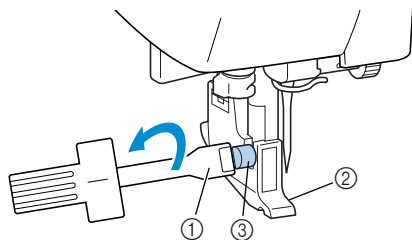

- ① Screwdriver
- ② Presser foot holder
- ③ Presser foot holder screw

■ Attaching the presser foot holder

- 1 Align the presser foot holder with the lower-left side of the presser bar.

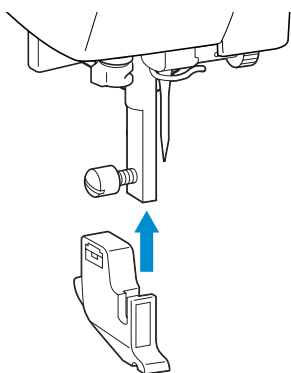

- 2 Hold the presser foot holder in place with your right hand, and then tighten the screw using the screwdriver in your left hand.

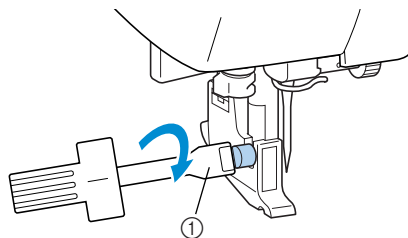

- ① Screwdriver

Note

- If the presser foot holder is not correctly installed, the thread tension will be incorrect.

Using the optional walking foot

With the walking foot, both pieces of fabric are fed evenly by the feed dogs and the teeth on the presser foot. This is useful when sewing fabrics that are hard to feed such as vinyl and leather and when sewing fabrics that easily slip such as velvets or when quilting.

Use the screwdriver to attach the walking foot.

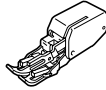

■ Attaching the walking foot

- 1 Remove the presser foot holder.
 - For details, refer to "Removing the presser foot holder" (on the previous page).
- 2 Hook the connecting fork of the walking foot onto the needle clamp screw.

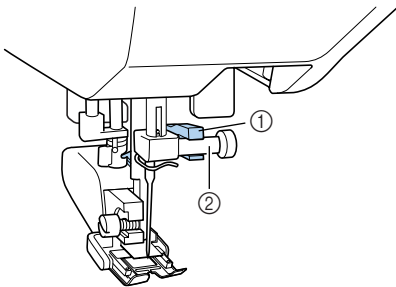

- ① Connecting fork
- ② Needle clamp screw

- 3 Lower the presser foot lever, insert the presser foot holder screw, and then tighten the screw with the screwdriver.

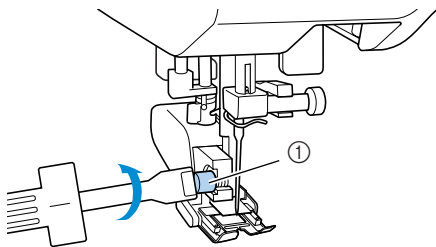

- ① Presser foot holder screw

! CAUTION

- Be sure to securely tighten the screw with the screwdriver, otherwise the needle may touch the presser foot, causing it to bend or break.
- Before starting to sew, slowly turn the balance wheel toward you and check that the needle does not touch the presser foot. If the needle hits the presser foot, the needle may bend or break.

⚡ Note

- When sewing with the walking foot, sew at a speed between slow and medium.

■ Removing the walking foot

- 1 Press  (needle position button) once or twice to raise the needle.

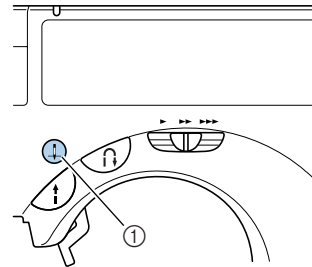

- ① Needle position button
- ▶ The needle is raised.

- 2 Turn off the sewing machine.

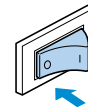

3 Raise the presser foot lever.

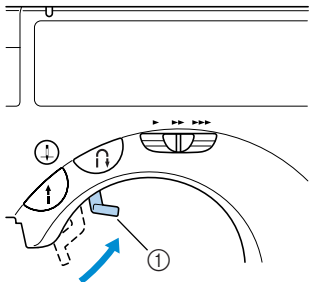

① Presser foot lever

► The presser foot is raised.

4 With a screwdriver, loosen the presser foot holder screw, and then remove the walking foot.

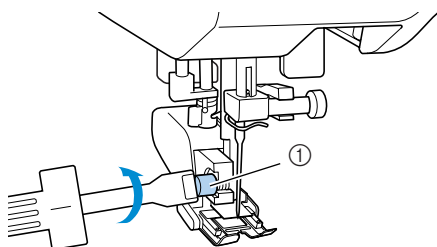

① Presser foot holder screw

5 Attach the presser foot holder.

- For details, refer to “Removing the presser foot holder” (page 43).



Memo

- Only the straight stitch (with reinforcement stitching) and the zigzag stitch can be used with the walking foot. For details on the stitches, refer to “Stitch Settings” (page 118).

Sewing Cylindrical Pieces

Free-arm sewing makes sewing cylindrical pieces easy.

Free-arm sewing

Removing the flap allows for free-arm sewing, making it easier to sew cylindrical pieces such as sleeve cuffs and pant legs.

- 1 Slide the flap off to the left.

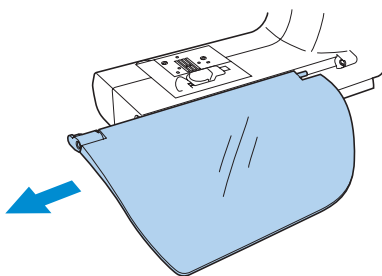

- ▶ With the flap removed, free-arm sewing is possible.

- 2 Pull the sliding leg (at the bottom of the machine) out toward you.

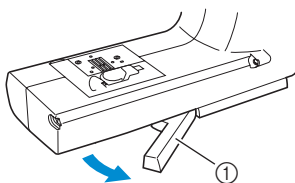

- ① Sliding leg
- During free-arm sewing, be sure to pull out the sliding leg.

- 3 Slide the part that you wish to sew onto the arm, and then sew from the top.

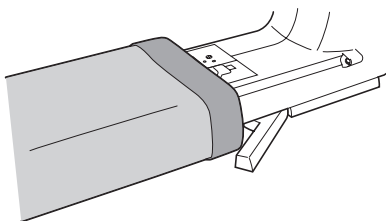

- 4 When you are finished with free-arm sewing, push the sliding leg back into position.

- 5 Then, install the flap back to its original position.

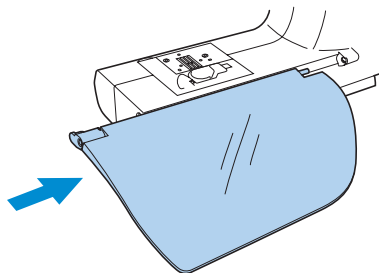

2

SEWING BASICS

The necessary preparations for sewing are described in this chapter.

Sewing	48
Adjusting the Thread Tension	56
Adjusting the Stitch Width and Length	57
Useful Functions	59
Useful Sewing Tips	61

Sewing

Basic sewing operations are described below.

Before operating the sewing machine, read the following precautions.



CAUTION

- **While the machine is in operation, pay special attention to the needle location. In addition, keep your hands away from all moving parts such as the needle and balance wheel, otherwise injuries may occur.**
- **Do not pull or push the fabric too hard while sewing, otherwise injuries may occur or the needle may break.**
- **Never use bent needles. Bent needles can easily break, possibly resulting in injuries.**
- **Make sure that the needle does not strike basting pins, otherwise the needle may break or bend.**

General sewing procedure

Follow the basic procedures below to sew.

1	Turn on the machine.	Turn on the sewing machine. For details on turning on the machine, refer to "Turning on the machine" (page 11).
↓		
2	Select the stitch.	Select the stitch appropriate for the area to be sewn. For details on selecting a stitch, refer to "Selecting stitching" (page 66).
↓		
3	Attach the presser foot.	Attach the presser foot appropriate for the stitch. For details on replacing the presser foot, refer to "Replacing the presser foot" (page 41).
↓		
4	Position the fabric.	Place the area to be sewn under the presser foot. Be sure that the fabric pieces are sewn in the correct order and that the right and wrong sides of the fabric are aligned correctly. For details on positioning the fabric, refer to "Positioning the fabric" (page 50).
↓		
5	Start sewing.	Start sewing. For details on starting to sew, refer to "Starting to sew" (page 51).
↓		
6	Cut the thread.	Cut the thread at the end of sewing. For details on cutting the thread, refer to "Cutting the thread" (page 55).

Positioning the fabric

Be sure that the fabric pieces are sewn in the correct order and that the right and wrong sides of the fabric are aligned correctly.

1 Turn on the sewing machine.

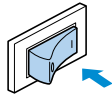

The straight stitch (left needle position) is automatically selected.

2 Press (needle position button) once or twice to raise the needle.

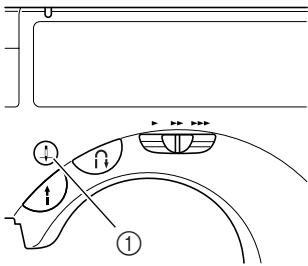

① Needle position button

3 Place the fabric under the presser foot.

- If the seam allowance is positioned on the right side, sewing in a straight line is easier and the extra fabric does not get in the way.

4 While holding the end of the thread and the fabric with your left hand, turn the balance wheel toward you with your right hand to lower the needle to the starting point of the stitching.

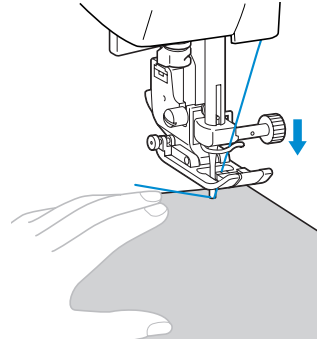
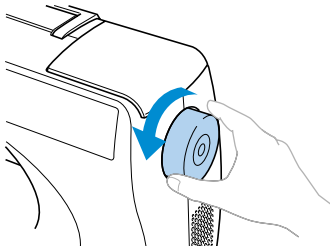

5 Lower the presser foot lever.

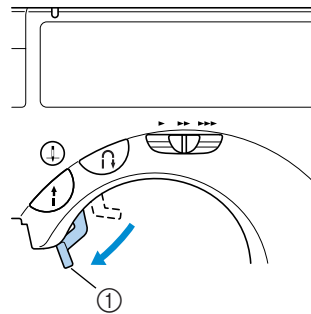

① Presser foot lever

► The fabric is now positioned to be sewn.

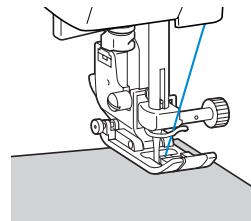

Starting to sew

Once you are ready to start sewing, you can start the sewing machine. The sewing speed can be adjusted using either the operation buttons or the foot controller.

■ Using the operation buttons

Sewing can be started and stopped using the operation button  (start/stop button).

① Slide the sewing speed controller to the left or right to select the desired sewing speed.

Slide the sewing speed controller to the left to sew at a slower speed, or slide the speed controller to the right to sew at a faster speed.

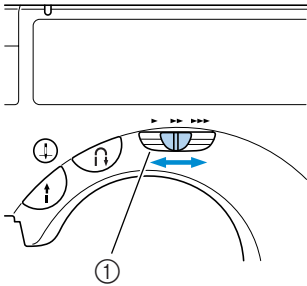

① Sewing speed controller

② Press (start/stop button) once.

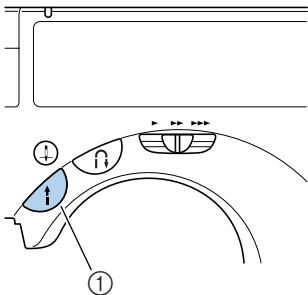

① Start/stop button

► The machine starts sewing.

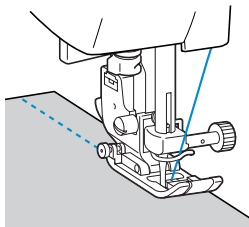

- If you continue to hold the start/stop button pressed immediately after the sewing starts, the machine will sew at a slow speed.

③ When the end of the stitching is reached, press (start/stop button) once.

► The machine stops sewing with the needle down (in the fabric).

④ When you are finished sewing, raise the needle, and then cut the threads.

- For details, refer to “Cutting the thread” (page 55).

■ Using the foot controller

Sewing can be started and stopped using the foot controller.

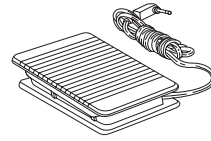

① Turn off the sewing machine.

When connecting the foot controller, be sure to turn off the sewing machine in order to prevent the machine from accidentally being started.

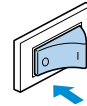

② Insert the foot controller plug into its jack on the side of the sewing machine.

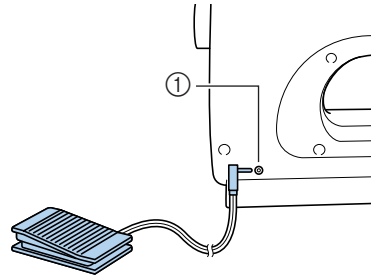

① Foot controller jack

Note

(For U.S.A. only)

- Foot controller: Model N5V
This foot controller can be used on this machine model CS-8150.

3 Turn on the sewing machine.

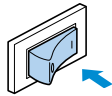

4 Slide the sewing speed controller to the left or right to select the desired sewing speed.

Slide the sewing speed controller to the left to sew at a slower speed, or slide the speed controller to the right to sew at a faster speed.

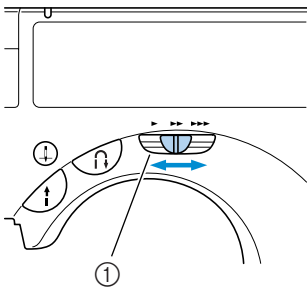

① Sewing speed controller

- The speed set using the sewing speed controller is the foot controller's maximum sewing speed.

5 Once you are ready to start sewing, slowly press down on the foot controller.

Pressing down on the foot controller increases the sewing speed; releasing the pressure on the foot controller decreases the sewing speed.

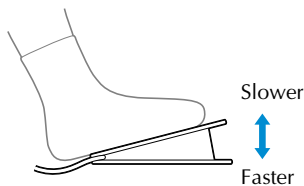

- Slowly press down on the foot controller. Pressing it down hard starts sewing too quickly.
- ▶ The machine starts sewing.

6 When the end of the stitching is reached, completely release the foot controller.

- ▶ The machine stops sewing with the needle lowered (in the fabric).

7 When you are finished sewing, raise the needle, and then cut the threads.

- For details, refer to "Cutting the thread" (page 55).

Memo

- When the foot controller is plugged in, the start/stop button cannot be used to start or stop sewing.
- When sewing is stopped, the needle remains lowered (in the fabric). The machine can be set so that the needle will stay up when sewing is stopped. For details on setting the machine so that the needle stays up when sewing is stopped, refer to "Changing the needle stop position" (page 16).

CAUTION

- Do not allow thread or dust to accumulate in the foot controller, otherwise a fire or an electric shock may occur.
- Do not place objects on the foot controller, otherwise damage to the machine or injuries may occur.
- If the machine is not to be used for a long period of time, unplug the foot controller, otherwise a fire or an electric shock may occur.

Securing the stitching

When sewing with the straight stitch, for example, at the end of an opening or where seams do not overlap, use reverse stitching or reinforcement stitching to secure the end of the thread.

- 1 Lower the needle into the fabric at the beginning of the stitching, and then lower the presser foot lever.

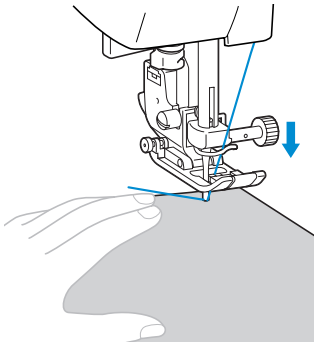

- 2 Press  (start/stop button) or press down on the foot controller.

At this time, if the start/stop button is held pressed, the machine sews at a low speed.

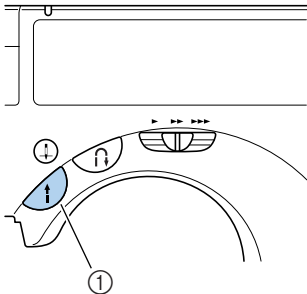

① Start/stop button

- For details, refer to “Starting to sew” (page 51).

► The machine starts sewing.

- 3 After sewing 3 to 5 stitches, press  (reverse/reinforcement stitch button). Keep the reverse/reinforcement stitch button held down until you reach the beginning of the stitching.

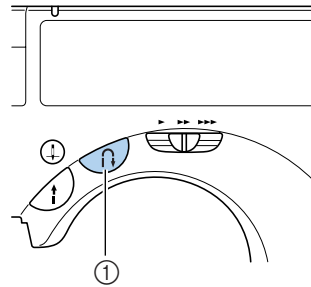

① Reverse/reinforcement stitch button

► While the reverse/reinforcement stitch button is held pressed, reverse stitches are sewn.

- 4 After sewing back to the beginning of the stitching, release the reverse/reinforcement stitch button.

► The machine stops sewing.

- 5 Press  (start/stop button), or press down on the foot controller.

► The machine starts sewing in the normal sewing direction.

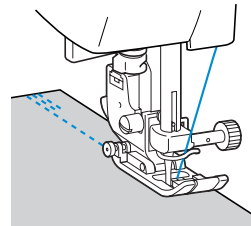

- 6 When the end of the stitching is reached, press  (reverse/reinforcement stitch button).

Keep the reverse/reinforcement stitch button held down until 3 to 5 reverse stitches are sewn.

► While the reverse/reinforcement stitch button is depressed, reverse stitches are sewn.

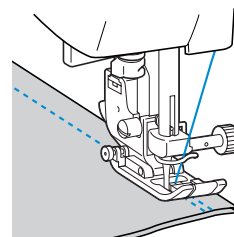

- 7** After 3 to 5 reverse stitches have been sewn, release  (reverse/reinforcement stitch button).

▶ The machine stops sewing.

- 8** Press , or press down on the foot controller.

At this time, if the start/stop button is held pressed, the machine sews at a low speed.

▶ The machine starts sewing in the normal sewing direction.

- 9** After sewing to the end of the stitching, the sewing machine stops.

Release the start/stop button or foot controller.

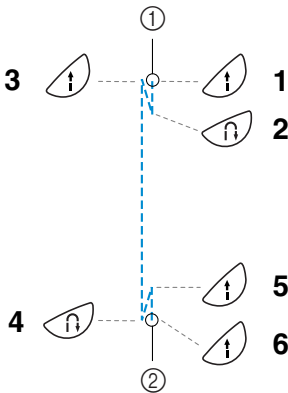

- ① Beginning of stitching
② End of stitching

■ Sewing reinforcement stitches

When sewing stitches other than straight or zigzag stitches that are secured with reverse stitching, pressing  (reverse/reinforcement stitch button) sews reinforcement stitches, 3 to 5 stitches on top of each other.

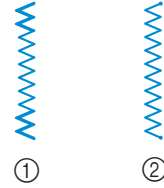

- ① Reverse stitching
② Reinforcement stitching



Memo

- Whether reverse stitches or reinforcement stitches are sewn depends on the stitch that is selected. For details, refer to “Stitch Settings” (page 118).

Cutting the thread

When you have finished sewing, cut the threads.

- 1 When you wish to finish the stitching and the sewing machine is stopped, press  (needle position button) once to raise the needle.

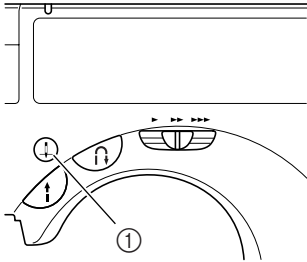

- 1 Needle position button
- ▶ The needle is raised.

- 2 Raise the presser foot lever.

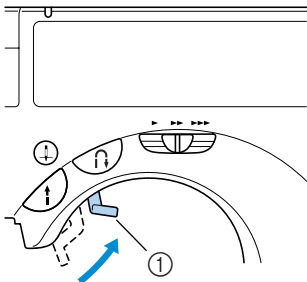

- 1 Presser foot lever

- 3 Pull the fabric to the left side of the machine, and then pass the threads through the thread cutter to cut them.

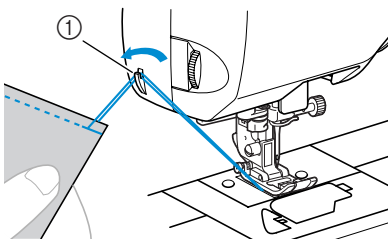

- 1 Thread cutter

- Using the thread cutter button
(Only for models equipped with the thread cutter button)

- 1 When you wish to finish the stitching, press  (thread cutter button) once.

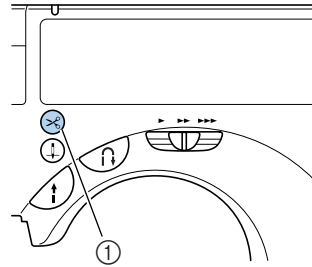

- 1 Thread cutter button
- ▶ The threads are cut and the needle is raised.

- 2 Raise the presser foot lever.

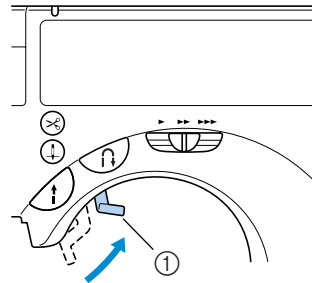

- 1 Presser foot lever

! CAUTION

- Do not press the thread cutter button after the threads have already been cut, otherwise the needle may break, the threads may become tangled or damage to the machine may occur.

☀ Note

- Do not press the thread cutter button if there is no fabric under the presser foot or while the machine is sewing, otherwise damage to the machine may occur.
- When cutting thread thicker than #30, nylon thread or other special thread, use the thread cutter on the side of the machine.

Adjusting the Thread Tension

The tensions of the upper thread and of the bobbin thread (thread tension) should be adjusted so that they are equal.

Changing the tension of the upper thread

If the thread and needle combination is correct for the type of fabric being sewn (according to "Needle types and their uses" on page 36), the thread tension will automatically be adjusted to the appropriate setting. However, if the preset thread tension does not give the desired result or if you are sewing with special thread or on special fabric, use the thread tension dial on the left side of the machine to adjust the tension of the upper thread.

■ Correct thread tension

The upper thread and the bobbin thread should cross near the center of the fabric. Only the upper thread should be visible from the right side of the fabric, and only the bobbin thread should be visible from the wrong side of the fabric.

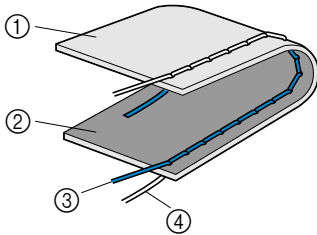

- ① Wrong side of fabric
- ② Right side of fabric
- ③ Upper thread
- ④ Bobbin thread

■ Upper thread is too tight

If the bobbin thread is visible from the right side of the fabric, the upper thread is too tight.

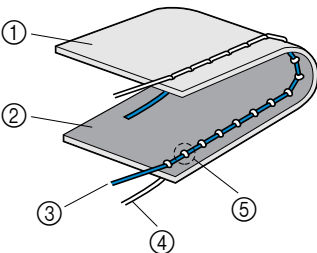

- ① Wrong side of fabric
- ② Right side of fabric
- ③ Upper thread
- ④ Bobbin thread
- ⑤ The bobbin thread is visible from the right side of the fabric.

Turn the thread tension dial downward to loosen the upper thread.

■ Upper thread is too loose

If the upper thread is visible from the wrong side of the fabric, the upper thread is too loose.

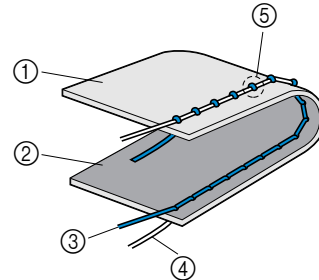

- ① Wrong side of fabric
- ② Right side of fabric
- ③ Upper thread
- ④ Bobbin thread
- ⑤ The upper thread is visible from the wrong side of the fabric.

Turn the thread tension dial upward to tighten the upper thread.

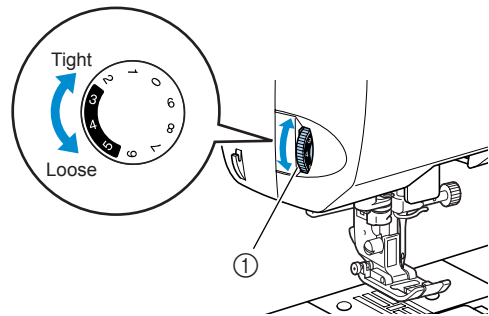

- ① Thread tension dial

Adjusting the Stitch Width and Length

The zigzag width (pattern width) and stitch length of utility stitches can be adjusted. Normally, when a stitch is selected, the appropriate width and length are automatically selected. For details on the range of values within which the width and length can be set, refer to “Stitch Settings” (page 118).

Adjusting the stitch width

The stitch width can be adjusted with the arrow keys.

1 Turn on the sewing machine.

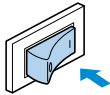

► The LCD comes on.

2 Select a stitch.

► A screen containing settings for the selected stitch appears.



- For details on selecting a stitch, refer to “Selecting stitching” (page 66).
- Immediately after the stitch is selected, the standard settings (highlighted) appear.

3 To make the stitch width narrower, press ◀ (-). To make the stitch width wider, press ▶ (+).

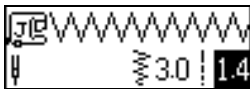

► The stitch width is changed.

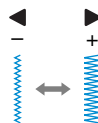

- If the setting is changed, the highlighted value is erased.

Memo

- To reset the stitch width to its standard setting, select the same stitch again or change the setting to the highlighted value.
- If the straight stitch (left needle position or triple stretch stitch) was selected, changing the stitch width changes the needle position. Increasing the width moves the needle to the right; reducing the width moves the needle to the left.
- The sewing machine can be set so that the stitch width can easily be changed with the sewing speed controller. For details, refer to “Satin stitching” (page 94).

CAUTION

- After adjusting the stitch width, slowly turn the balance wheel toward you and check that the needle does not touch the presser foot. If the needle hits the presser foot, the needle may bend or break.

Adjusting the stitch length

The stitch length can be adjusted with the arrow keys.

1 Turn on the sewing machine.

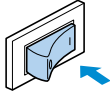

- ▶ The LCD comes on.

2 Select a stitch.

- ▶ A screen containing settings for the selected stitch appears.



- For details on selecting a stitch, refer to "Selecting stitching" (page 66).
- Immediately after the stitch is selected, the standard settings (highlighted) appear.

3 To make the stitch length shorter, press ▼ (-). To make the stitch length longer, press ▲ (+).



- ▶ The stitch length is changed.

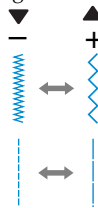

- If the setting is changed, the highlighted value is erased.



Memo

- To reset the stitch length to its standard setting, select the same stitch again or change the setting to the highlighted value.



CAUTION

- If the stitches are bunched together, increase the stitch length. Continuing to sew with the stitches bunched together may result in the needle bending or breaking.

Useful Functions

Functions useful in improving sewing efficiency are described below.

Automatically sewing reverse/reinforcement stitches

The sewing machine can be set to automatically sew reverse or reinforcement stitches at the beginning and end of the stitching.

Whether reverse stitches or reinforcement stitches are sewn depends on the stitch that is selected. For details, refer to “Stitch Settings” (page 118).

1 Turn on the sewing machine.

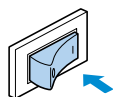

▶ The LCD comes on.

2 Select a stitch.

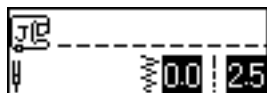

• For details on selecting a stitch, refer to “Selecting stitching” (page 66).

3 Press (settings key) in the operation panel.

▶ The settings screen appears.

4 Press , , and (arrow keys) until is selected.



5 Press (OK key).

▶ The screen for specifying automatic reverse/reinforcement stitching appears.

6 Press to select . To return to , press .

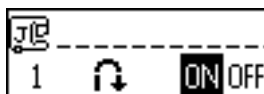

▶ The machine is now set to automatically sew reverse/reinforcement stitches.

7 Press (OK key).

▶ The initial stitch screen appears again, and  appears in the lower-left corner of the screen.

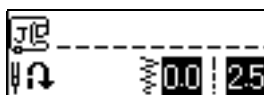

• When the sewing machine is turned off, the automatic reverse/reinforcement stitching setting is cancelled.

8 Position the fabric under the presser foot, and then press (start/stop button) once.

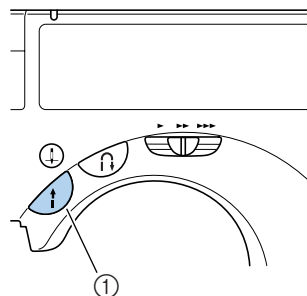

① Start/stop button

▶ After reverse/reinforcement stitches are sewn, the machine starts sewing.

- 9** After reaching the end of the stitching, press  (reverse/reinforcement stitch button) **once**.

This step is not necessary if a stitch such as those for sewing buttonholes and bar tacks is selected where reinforcement stitches are automatically sewn.

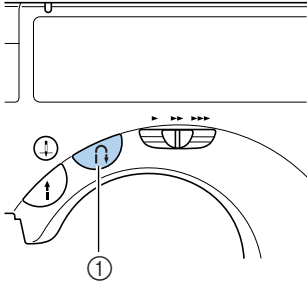

- ① Reverse/reinforcement stitch button
- After reverse/reinforcement stitches are sewn, the sewing machine stops.

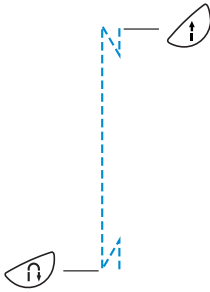

Memo

- Reverse/reinforcement stitches will not be sewn if the start/stop button is pressed at the end of the stitching. Be sure to press the reverse/reinforcement stitch button at the end of the stitching.

Useful Sewing Tips

Various ways to achieve better results for your sewing projects are described below. Refer to these tips when sewing your project.

Trial sewing

After you have set up the machine with the thread and needle appropriate for the type of fabric being sewn, the machine automatically sets the thread tension and stitch length and width for the stitch that is selected. However, a trial piece of fabric should be sewn since, depending on the type of fabric and stitching being sewn, the desired results may not be achieved.

For the trial sewing, use a piece of fabric and thread that are the same as those used for your project, and check the thread tension and stitch length and width. Since the results differ depending on the type of stitching and the number of layers of fabric sewn, perform the trial sewing under the same conditions that will be used with your project.

Changing the sewing direction

1 When the stitching reaches a corner, stop the sewing machine.

Leave the needle lowered (in the fabric). If the needle remained up when the machine stopped sewing, press  (needle position button) to lower the needle.

2 Raise the presser foot lever, and then turn the fabric.

Turn the fabric using the needle as a pivot.

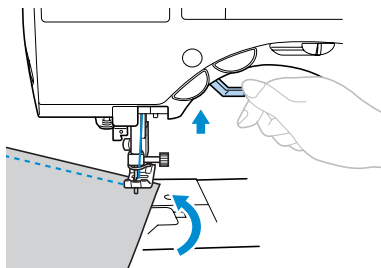

3 Lower the presser foot lever and continue sewing.

Sewing curves

Stop sewing, and then slightly change the sewing direction to sew around the curve. For details on sewing with an even seam allowance, refer to “Sewing an even seam allowance” (page 63).

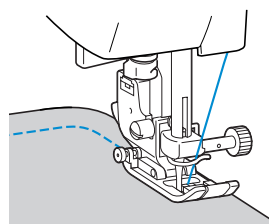

When sewing along a curve while using a zigzag stitch, select a shorter stitch length in order to obtain a finer stitch.

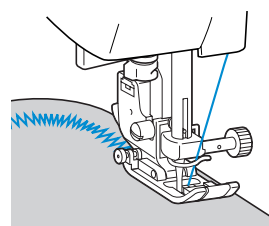

Sewing thick fabrics

- **If the fabric does not fit under the presser foot**
If the fabric does not fit easily under the presser foot, raise the presser foot lever even higher to bring the presser foot to its highest position.

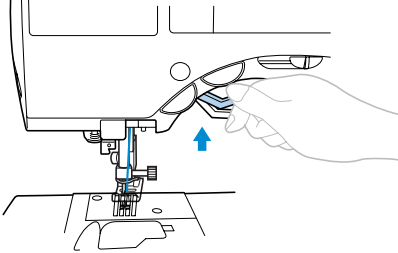

- **If thick seams are being sewn and the fabric does not feed at the beginning of stitching**
Zigzag foot "J" is equipped with a feature that keeps the presser foot level.

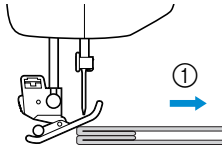

① Sewing direction

- 1 **When you encounter a seam that is too thick to feed under the foot, raise the presser foot lever.**
- 2 **Press the black button on the left side of the foot. Keep the button held in and lower the presser foot.**

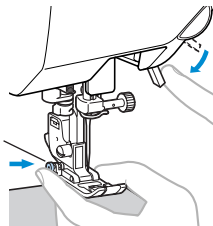

- 3 **Release the button. The foot will lock in place level with the seam, allowing the fabric to feed.**

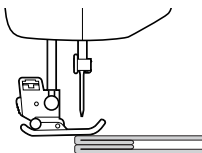

- Once the trouble spot has been passed, the foot will return to its normal position.

! CAUTION

- **If fabric more than 6 mm (15/64 inch) thick is sewn or if the fabric is pushed with too much force, the needle may bend or break.**

Sewing thin fabrics

When sewing thin fabrics, the stitching may become misaligned or the fabric may not feed correctly. If this occurs, place thin paper or stabilizer material under the fabric and sew it together with the fabric. When you have finished sewing, tear off any excess paper.

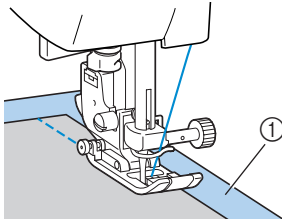

① Stabilizer material or paper

Sewing stretch fabrics

First, baste the pieces of fabric together, and then sew without stretching the fabric.

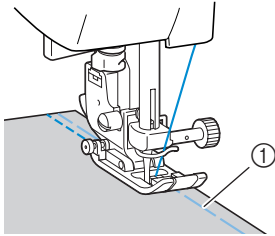

① Basting

Sewing an even seam allowance

To sew an even seam allowance, start sewing so that the seam allowance is to the right of the presser foot, and the edge of the fabric is aligned with either the right edge of the presser foot or a marking on the needle plate.

■ Aligning the fabric with the presser foot

Sew while keeping the right edge of the presser foot a fixed distance from the edge of the fabric.

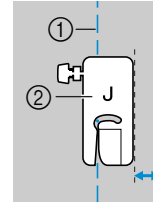

① Seam
② Presser foot

■ Aligning the fabric with a needle plate marking

The markings on the needle plate show the distance from the needle position of a seam sewn with the straight stitch (left needle position). Sew while keeping the edge of the fabric aligned with a marking in the needle plate. The distance between the markings in the upper scale is 1/8 inch (3 mm) and the distance between the markings in the grid is 5 mm (3/16 inch).

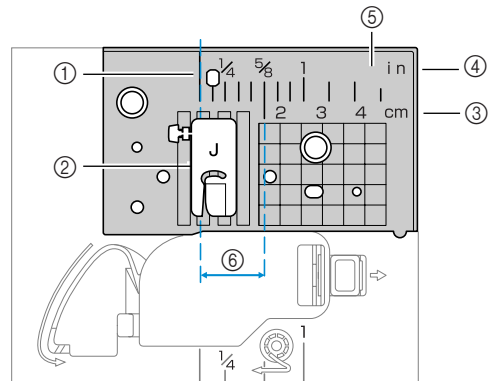

① Seam
② Presser foot
③ Centimeters
④ Inches
⑤ Needle plate
⑥ 16 mm (5/8 inch)

CONTENTS

GETTING READY

SEWING BASICS

UTILITY STITCHES

APPENDIX

INDEX

3

UTILITY STITCHES

The various stitches and their applications are described in this chapter.

Selecting Stitching	66
Overcasting Stitches	68
Basic Stitching	72
Blind Hem Stitching	74
Buttonhole Stitching	76
Zipper Insertion	82
Sewing Stretch Fabrics and Elastic Tape	86
Appliqué, Patchwork and Quilt Stitching	88
Reinforcement Stitching	95
Eyelet Stitching	99
Decorative Stitching	100
Sewing the Various Built-In Decorative Patterns	108

Selecting Stitching

You can select any of the various types of stitching available.

Stitch types

A total of 4 groups of stitch types (utility stitches, decorative stitches, satin stitches and cross-stitches) are available.

For details on the types of stitches available, refer to "Stitch Settings" (page 118).

■ Utility stitches

There are 67 utility stitches, including straight stitches, overcasting stitches and buttonhole stitches.

■ Decorative stitches

There are 31 decorative stitches, including hearts, leaves and flowers.

■ Satin stitches

There are 16 satin stitches.

■ Cross-stitches

There are 5 types of cross-stitches.

Selecting stitching

Using the operation panel keys, select the desired stitch from those shown in the LCD.

When the sewing machine is turned on, the straight stitch (left needle position) is selected.

- 1 **Determine the stitch that you wish to use.**
 - Refer to "Stitch types" (at the left).
- 2 **Determine which presser foot should be used with the selected stitch.**

The presser feet are stored in the accessory compartment.

 - For details on the stitches that can be sewn with the twin needle, refer to "Stitch Settings" (page 118).
- 3 **Attach the presser foot.**
 - For details, refer to "Replacing the presser foot" (page 41).
- 4 **Turn on the sewing machine.**

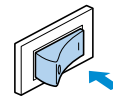

- ▶ The straight stitch (left needle position) is shown selected in the LCD.
- 5 **Press  (stitch selection key) in the operation panel.**
 - ▶ The screen containing the various types of stitches appears.

- 6 Press ▲, ▼, ◀ and ▶ (arrow keys) until the type of stitch that you wish to use is selected.



- 7 Press  (OK key).

- ▶ The screen containing the various stitches in the selected stitch type appears.

■ Understanding the screen

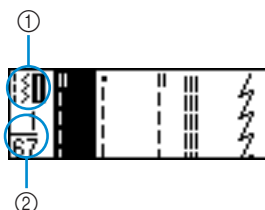

- ① Selected stitch type
- ② Number of stitches in the selected stitch type

- To select a different stitch type, press  (back key).

- 8 Press ▲, ▼, ◀ and ▶ (arrow keys) until the stitch that you wish to use is selected.

Press ▲ to return to the previous screen.

Press ▼ to display the next screen.

- 9 Press  (OK key).

- ▶ The stitch is selected.

- 10 If necessary, specify the setting for automatic reverse/reinforcement stitching and adjust the stitch length, etc.

- For details on sewing with each of the utility stitches, refer to the following pages.

Note

- When a stitch is selected, the icon for the presser foot that should be used appears in the screen. Check that the correct presser foot is attached before starting to sew. If the wrong presser foot is installed, turn off the sewing machine, attach the correct presser foot, and then select the desired stitch again.

Memo



- For details on adjusting the stitch width and length, refer to “Adjusting the Stitch Width and Length” (page 57).

Overcasting Stitches

Sew overcasting stitches along the edges of cut fabric to prevent them from fraying. Fifteen stitches are available for overcasting. The procedure for sewing overcasting stitch is explained according to the presser foot that is used.

Sewing overcasting stitches using overcasting foot “G”

Three stitches can be used to sew overcasting with overcasting foot “G”.

Stitch Name	Pattern	Application	Stitch Width [mm (inch.)]		Stitch Length [mm (inch.)]		Presser Foot
			Auto	Manual	Auto	Manual	
Overcasting stitch	11 	Preventing fraying in medium weight and thin fabrics	3.5 (1/8)	2.5–5.0 (3/32–3/16)	2.0 (1/16)	1.0–4.0 (1/16–3/16)	G
	12 	Preventing fraying in thick fabrics and fabrics that fray easily	5.0 (3/16)	2.5–5.0 (3/32–3/16)	2.5 (3/32)	1.0–4.0 (1/16–3/16)	
	13 		5.0 (3/16)	3.5–5.0 (1/8–3/16)	2.5 (3/32)	1.0–4.0 (1/16–3/16)	

1 Attach overcasting foot “G”.

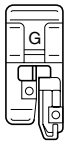

- For details, refer to “Replacing the presser foot” (page 41).

2 Select a stitch.

- For details, refer to “Selecting stitching” (page 66).

3 Position the fabric with the edge of the fabric against the guide of the presser foot, and then lower the presser foot lever.

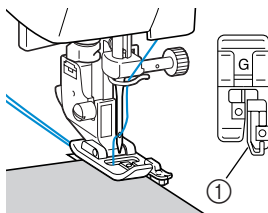

① Guide

4 Sew with the edge of the fabric against the presser foot guide.

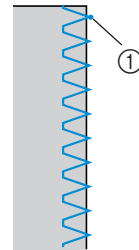

① Needle drop point

! CAUTION

- After adjusting the stitch width, slowly turn the balance wheel toward you and check that the needle does not touch the presser foot. If the needle hits the presser foot, the needle may bend or break.

Sewing overcasting stitches using zigzag foot “J”

Seven stitches can be used to sew overcasting stitches with zigzag foot “J”.

Stitch Name	Pattern	Application	Stitch Width [mm (inch.)]		Stitch Length [mm (inch.)]		Presser Foot
			Auto	Manual	Auto	Manual	
Zigzag stitch (center needle position)	7	Preventing fraying (center baseline/reverse stitching)	3.5 (1/8)	0.0–7.0 (0–1/4)	1.4 (1/16)	0.0–4.0 (0–3/16)	J
Zigzag stitch (right needle position)	8	Preventing fraying (right baseline/reinforcement stitching)	3.5 (1/8)	2.5–5.0 (3/32–3/16)	1.4 (1/16)	0.3–4.0 (1/64–3/16)	
2-point zigzag stitch	9	Preventing fraying in thick fabrics and stretch fabrics	5.0 (3/16)	1.5–7.0 (1/16–1/4)	1.0 (1/16)	0.2–4.0 (1/64–3/16)	
3-point zigzag stitch	10		5.0 (3/16)	1.5–7.0 (1/16–1/4)	1.0 (1/16)	0.2–4.0 (1/64–3/16)	
Overcasting stitch	14	Preventing fraying in stretch fabrics	5.0 (3/16)	0.0–7.0 (0–1/4)	2.5 (3/32)	0.5–4.0 (1/32–3/16)	
	15	Preventing fraying in thick fabrics and stretch fabrics	5.0 (3/16)	0.0–7.0 (0–1/4)	2.5 (3/32)	0.5–4.0 (1/32–3/16)	
	16	Preventing fraying in stretch fabrics	4.0 (3/16)	0.0–7.0 (0–1/4)	4.0 (3/16)	1.0–4.0 (1/16–3/16)	

1 Attach zigzag foot “J”.

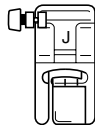

- For details, refer to “Replacing the presser foot” (page 41).

2 Select a stitch.

- For details, refer to “Selecting stitching” (page 66).

3 Sew along the edge of the fabric with the needle dropping off the edge at the right.

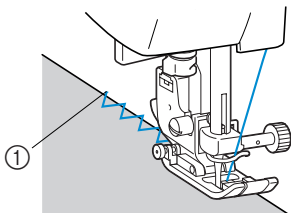



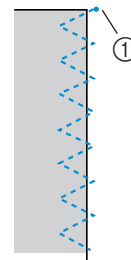

- ① Needle drop point



- ① Needle drop point

Sewing overcasting stitches using the optional side cutter

Using the side cutter, seam allowances can be finished while the edge of the fabric is cut off. Five stitches can be used to sew overcasting stitches with the side cutter.

Stitch Name	Pattern	Application	Stitch Width [mm (inch.)]		Stitch Length [mm (inch.)]		Presser Foot
			Auto	Manual	Auto	Manual	
Overcasting stitch	63 	Sewing straight stitches while cutting the fabric	0.0 (0)	0.0–2.5 (0–3/32)	2.5 (3/32)	0.2–5.0 (1/64–3/16)	S
	64 	Sewing zigzag stitches while cutting the fabric	3.5 (1/8)	3.5–5.0 (1/8–3/16)	1.4 (1/16)	0.0–4.0 (0–3/16)	
	65 	Preventing fraying in thin and mediumweight fabrics while cutting the fabric	3.5 (1/8)	3.5–5.0 (1/8–3/16)	2.0 (1/16)	1.0–4.0 (1/16–3/16)	
	66 	Preventing fraying in thick fabrics while cutting the fabric	5.0 (3/16)	3.5–5.0 (1/8–3/16)	2.5 (3/32)	1.0–4.0 (1/16–3/16)	
	67 	Preventing fraying in thick fabrics while cutting the fabric	5.0 (3/16)	3.5–5.0 (1/8–3/16)	2.5 (3/32)	1.0–4.0 (1/16–3/16)	

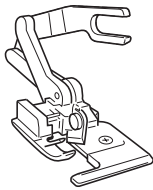

- 1 Remove the presser foot.**
 - For details, refer to “Replacing the presser foot” (page 41).

- 2 Hook the connecting fork of the side cutter onto the needle clamp screw.**

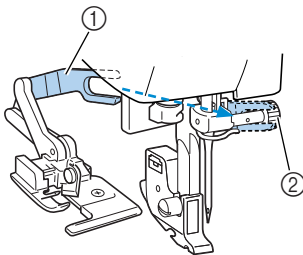

- ① Connecting fork
- ② Needle clamp screw

- 3 Position the side cutter so that side cutter pin is aligned with the notch in the presser foot holder, and then slowly lower the presser foot lever.**

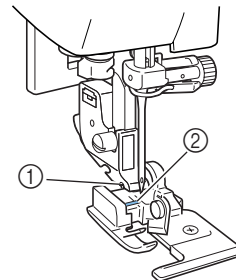

- ① Notch in presser foot holder
 - ② Pin
- The side cutter is attached.

- 4 Raise the presser foot lever to check that the side cutter is securely attached.

CAUTION

- If the thread cassette is to be installed with the side cutter attached, be sure to lower the presser foot lever. If the presser foot lever remains raised, the needle threader will hit the presser foot, which may result in damages.

- 5 Pass the upper thread under the side cutter, and then pull it out toward the rear of the sewing machine.

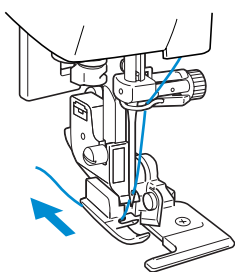

- 6 Select a stitch.
- For details, refer to "Selecting stitching" (page 66).

CAUTION

- After adjusting the stitch width, slowly turn the balance wheel toward you and check that the needle does not touch the presser foot. If the needle hits the presser foot, the needle may bend or break.

- 7 Make a cut of about 2 cm (1/16 inch) long in the fabric at the beginning of the stitching.

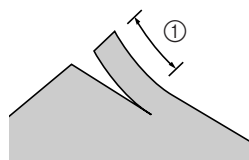

① 2 cm (1/16 inch)

- 8 Position the fabric in the side cutter. The cut in the fabric should be positioned over the guide plate of the side cutter.

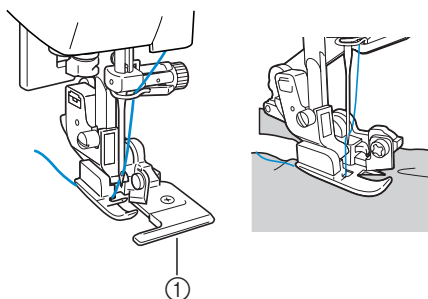

① Guide plate

- If the fabric is not positioned correctly, the fabric will not be cut.

- 9 Lower the presser foot lever, and then start sewing.

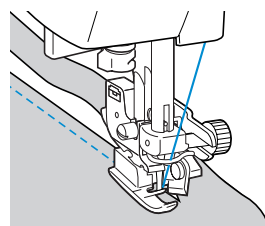

- ▶ A seam allowance is cut while the stitching is sewn.
- If the stitching is sewn in a straight line, the seam allowance will be about 5 mm (3/16 inch).

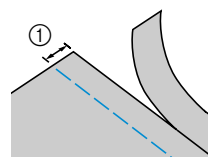

① 5 mm (3/16 inch)

Memo

- The side cutter can cut as much as one layer of 13-oz. denim.
- After using the side cutter, clean it by removing any lint or dust.
- If the side cutter can no longer cut fabric, use a rag to apply a small amount of oil to the cutting edge of the cutter.

Basic Stitching

Straight stitches are used for sewing plain seams. Five stitches are available for basic stitching.

Stitch Name	Pattern	Application	Stitch Width [mm (inch.)]		Stitch Length [mm (inch.)]		Presser Foot
			Auto	Manual	Auto	Manual	
Basting stitch	6	Temporarily securing	0.0 (0)	0.0–7.0 (0–1/4)	–	–	J
Straight stitch (left needle position)	1	Basic stitching and sewing gathers or pintucks (left baseline/reverse stitching)	0.0 (0)	0.0–7.0 (0–1/4)	2.5 (3/32)	0.2–5.0 (1/64–3/16)	
	2 :	Basic stitching and sewing gathers or pintucks (left baseline/reinforcement stitching)	0.0 (0)	0.0–7.0 (0–1/4)	2.5 (3/32)	0.2–5.0 (1/64–3/16)	
Straight stitch (center needle position)	3	Basic stitching and sewing gathers or pintucks (center baseline/reverse stitching)	–	–	2.5 (3/32)	0.2–5.0 (1/64–3/16)	
Triple stretch stitch	4	Reinforcing seams and sewing stretch fabrics	0.0 (0)	0.0–7.0 (0–1/4)	2.5 (3/32)	1.5–4.0 (1/16–3/16)	

Basting

Sew basting with a stitch length of 5 mm (3/16 inch).

- 1 Attach zigzag foot “J”.

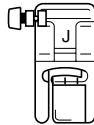

- For details, refer to “Replacing the presser foot” (page 41).

- 2 Select stitch 6 | |.

- For details, refer to “Selecting stitching” (page 66).

- 3 Start sewing.

- For details, refer to “Starting to sew” (page 51).

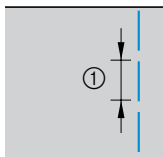

① 5 mm (3/16 inch)

Basic stitching

- 1 Baste or pin together the fabric pieces.

- 2 Attach zigzag foot “J”.

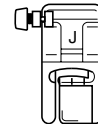

- For details, refer to “Replacing the presser foot” (page 41).

- 3 Select a stitch.

- For details, refer to “Selecting stitching” (page 66).

- 4 Lower the needle into the fabric at the beginning of the stitching.

5 Start sewing.

- For details, refer to “Starting to sew” (page 51).
- For details on sewing reverse/reinforcement stitches, refer to “Securing the stitching” (page 53).

6 When sewing is finished, cut the thread.

- For details, refer to “Cutting the thread” (page 55).



■ Changing the needle position

The needle position used as the baseline is different for the straight stitch (left needle position) and the straight stitch (center needle position).

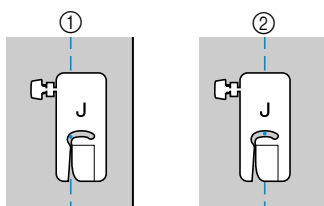

- ① Straight stitch (left needle position)
- ② Straight stitch (center needle position)

When the stitch width of the straight stitch (left needle position) is set to its standard setting (0.0 mm), the distance from the needle position to the right side of the presser foot is 12 mm (1/2 inch). If the stitch width is changed (between 0 and 7 mm (1/4 inch)), the needle position will also change. By changing the stitch width and sewing with the right side of the presser foot aligned with the edge of the fabric, a seam allowance can be sewn with a fixed width.

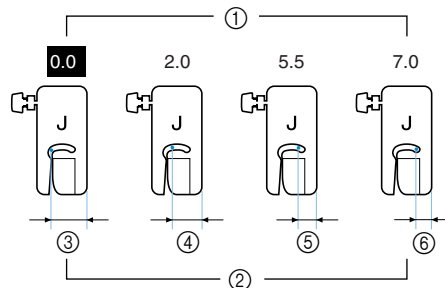

- ① Stitch width
- ② Distance from the needle position to the right side of the presser foot
- ③ 12.0 mm (1/2 inch)
- ④ 10.0 mm (3/8 inch)
- ⑤ 6.5 mm (1/4 inch)
- ⑥ 5.0 mm (3/16 inch)

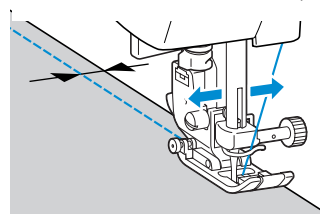

- For details, refer to “Adjusting the stitch width” (page 57).

Blind Hem Stitching

Secure the bottoms of skirts and pants with a blind hem. Two stitches are available for blind hem stitching.

Stitch Name	Pattern	Application	Stitch Width [mm (inch.)]		Stitch Length [mm (inch.)]		Presser Foot
			Auto	Manual	Auto	Manual	
Blind hem stitch	17	Blind hem stitching on mediumweight fabrics	0.0 (0)	3← - 3→	2.0 (1/16)	1.0-3.5 (1/16-1/8)	R
	18	Blind hem stitching on stretch fabrics	0.0 (0)	3← - 3→	2.0 (1/16)	1.0-3.5 (1/16-1/8)	R

Sew a blind hem according to the following procedure.

- 1** Fold the fabric along the desired edge of the hem, and then baste it about 5 mm (3/16 inch) from the edge of the fabric.

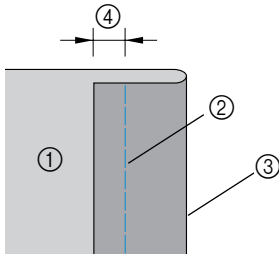

- ① Wrong side of fabric
- ② Basting stitching
- ③ Desired edge of hem
- ④ 5 mm (3/16 inch)

- 2** Fold back the fabric along the basting, and then position the fabric with the wrong side facing up.

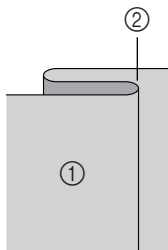

- ① Wrong side of fabric
- ② Basting

- 3** Attach blind hem foot "R".

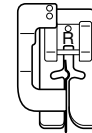

- For details, refer to "Replacing the presser foot" (page 41).

- 4** Select a stitch.
- For details, refer to "Selecting stitching" (page 66).

- 5** Position the fabric with the edge of the folded hem against the guide of the presser foot, and then lower the presser foot lever.

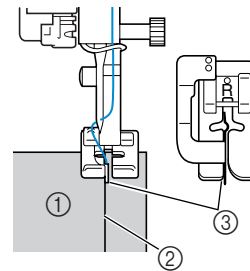

- ① Wrong side of fabric
- ② Fold of hem
- ③ Guide

6 Adjust the stitch width until the needle slightly catches the fold of the hem.

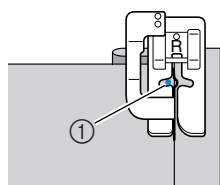

① Needle drop point

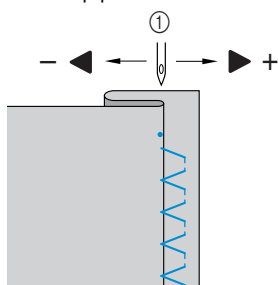

① Stitch width

■ **If the needle catches too much of the hem fold**

The needle is too far to the left. Press ► (of the arrow keys) to decrease the stitch width so that the needle slightly catches the fold of the hem.

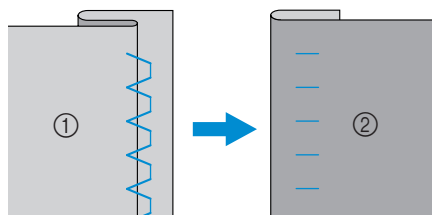

① Wrong side of fabric
② Right side of fabric

■ **If the needle does not catch the hem fold**

The needle is too far to the right. Press ◀ (of the arrow keys) to increase the stitch width so that the needle slightly catches the fold of the hem.

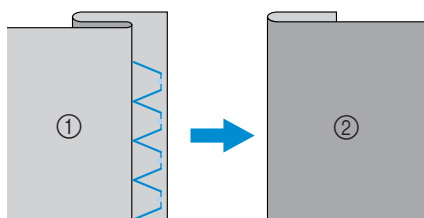

① Wrong side of fabric
② Right side of fabric

- For details on changing the stitch width, refer to “Adjusting the Stitch Width and Length” (page 57).

7 Sew with the fold of the hem against the presser foot guide.



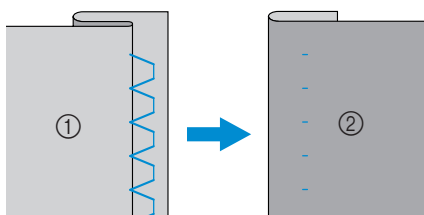







8 Remove the basting stitching.



① Wrong side of fabric
② Right side of fabric

Buttonhole Stitching

Buttonholes can be sewn and buttons can be sewn on. Eleven stitches are available for sewing on buttons and one-step buttonholes.

Stitch Name	Pattern	Application	Stitch Width [mm (inch.)]		Stitch Length [mm (inch.)]		Presser Foot
			Auto	Manual	Auto	Manual	
Buttonhole stitch	42 	Horizontal buttonholes on thin and mediumweight fabrics	5.0 (3/16)	3.0–5.0 (1/8–3/16)	0.4 (1/64)	0.2–1.0 (1/64–1/16)	A
	43 	Horizontal buttonholes on areas that are subject to strain	5.0 (3/16)	3.0–5.0 (1/8–3/16)	0.4 (1/64)	0.2–1.0 (1/64–1/16)	
	44 	Horizontal buttonholes on thick fabrics	5.0 (3/16)	3.0–5.0 (1/8–3/16)	0.4 (1/64)	0.2–1.0 (1/64–1/16)	
	45 	Buttonholes with bar tacks on both ends for stabilized fabrics	5.0 (3/16)	3.0–5.0 (1/8–3/16)	0.4 (1/64)	0.2–1.0 (1/64–1/16)	
	46 	Buttonholes for stretch or knit fabrics	6.0 (15/64)	3.0–6.0 (1/8–15/64)	1.0 (1/16)	0.5–2.0 (1/32–1/16)	
	47 	Buttonholes for stretch fabrics	6.0 (15/64)	3.0–6.0 (1/8–15/64)	1.5 (1/16)	1.0–3.0 (1/16–1/8)	
	48 	Bound buttonholes	5.0 (3/16)	0.0–6.0 (0–15/64)	2.0 (1/16)	0.2–4.0 (1/64–3/16)	
	49 	Keyhole buttonholes for thick or plush fabrics	7.0 (1/4)	3.0–7.0 (1/8–1/4)	0.5 (1/32)	0.3–1.0 (1/64–1/16)	
	50 	Keyhole buttonholes for mediumweight and thick fabrics	7.0 (1/4)	3.0–7.0 (1/8–1/4)	0.5 (1/32)	0.3–1.0 (1/64–1/16)	
	51 	Horizontal buttonhole for thick or plush fabrics	7.0 (1/4)	3.0–7.0 (1/8–1/4)	0.5 (1/32)	0.3–1.0 (1/64–1/16)	
Button-sewing stitch	55 	Button sewing	3.5 (1/8)	2.5–4.5 (3/32–3/16)	–	–	M

- CONTENTS
- GETTING READY
- SEWING BASICS
- UTILITY STITCHES
- APPENDIX
- INDEX

Buttonhole sewing

The maximum buttonhole length is about 28 mm (1-1/8 inch) (diameter + thickness of the button). Buttonholes are sewn from the front of the presser foot to the back, as shown below.

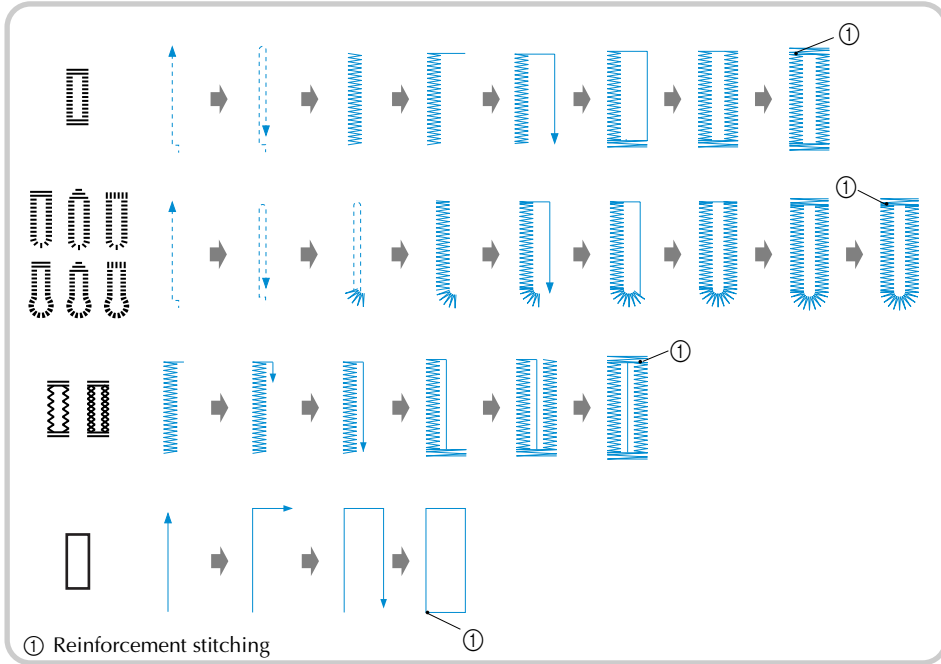

The names of parts of buttonhole foot "A", which is used for sewing buttonholes, are indicated below.

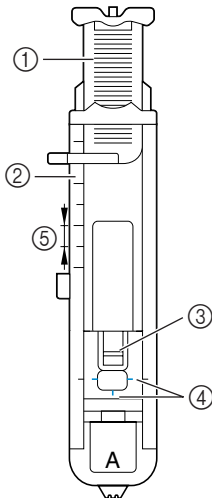

- ① Button guide plate
- ② Presser foot scale
- ③ Pin
- ④ Marks on buttonhole foot
- ⑤ 5 mm (3/16 inch)

- 1** Use chalk to mark on the fabric the position and length of the buttonhole.

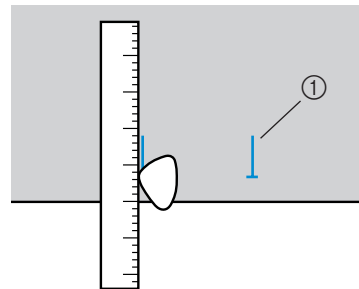

- ① Marks on fabric

- 2** Pull out the button guide plate of buttonhole foot "A", and then insert the button that will be put through the buttonhole.

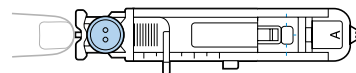

■ **If the button does not fit in the button guide plate**

Add together the diameter and thickness of the button, and then set the button guide plate to the calculated length. (The distance between the markings on the presser foot scale is 5 mm (3/16 inch).)

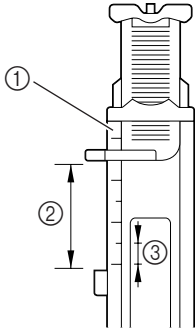

- ① Presser foot scale
- ② Length of buttonhole (Diameter + thickness of button)
- ③ 5 mm (3/16 inch)

Example: For a button with a diameter of 15 mm (9/16 inch) and a thickness of 10 mm (3/8 inch), the button guide plate should be set to 25 mm (1 inch) on the scale.

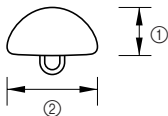

- ① 10 mm (3/8 inch)
- ② 15 mm (9/16 inch)

► The size of the buttonhole is set.

3 Attach buttonhole foot "A".

- For details, refer to "Replacing the presser foot" (page 41).

4 Select a stitch.

- For details, refer to "Selecting stitching" (page 66).

5 Position the fabric with the front end of the buttonhole mark aligned with the red marks on the sides of the buttonhole foot, and then lower the presser foot lever.

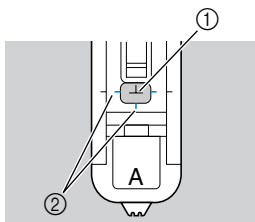

- ① Mark on fabric
- ② Red marks on buttonhole foot

Pass the upper thread down through the hole in the presser foot.

- When lowering the presser foot, do not push in the front of the presser foot, otherwise the buttonhole will not be sewn with the correct size.

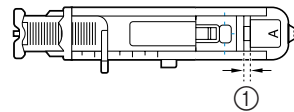
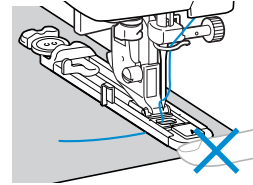

- ① Do not reduce the gap.

6 Pull down the buttonhole lever as far as possible.

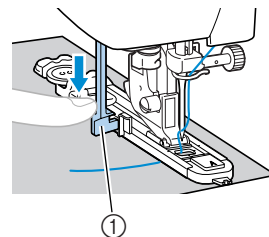

- ① Buttonhole lever

The buttonhole lever is positioned behind the bracket on the buttonhole foot.

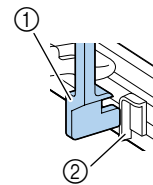

- ① Buttonhole lever
- ② Bracket

7 Gently hold the end of the upper thread in your left hand, and then start sewing.

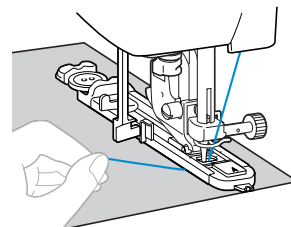

- Once sewing is completed, the machine automatically sews reinforcement stitches, then stops

- 8 Raise the presser foot lever, remove the fabric, and then cut the thread.
- 9 Raise the buttonhole lever to its original position.
- 10 Insert a pin along the inside of one bar tack at the end of the buttonhole stitching to prevent the stitching from being cut.

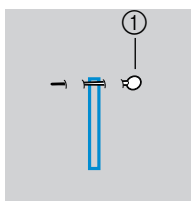

① Pin

- 11 Use the seam ripper to cut towards the pin and open the buttonhole.

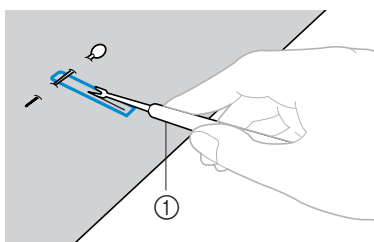

① Seam ripper

For keyhole buttonholes, use the eyelet punch to make a hole in the rounded end of the buttonhole, and then use the seam ripper to cut open the buttonhole.

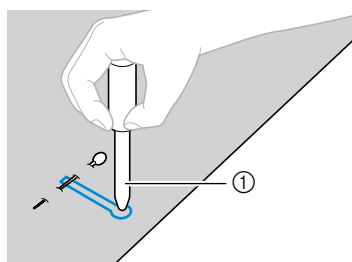

① Eyelet punch

- When using the eyelet punch, place thick paper or some other protective sheet under the fabric before punching the hole in the fabric.

! CAUTION

- When opening the buttonhole with the seam ripper, do not place your hands in the cutting direction, otherwise injuries may result if the seam ripper slips.

- Changing the density of the stitching
Adjust the stitch length.

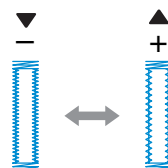

- For details, refer to "Adjusting the stitch length" (page 58).
- If the fabric does not feed (for example, if it is too thick), decrease the density of the stitching.

- Changing the stitch width
Adjust the stitch width.

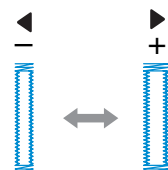

- For details, refer to "Adjusting the stitch width" (page 57).

🔔 Memo

- Before sewing buttonholes, check the stitch length and width by sewing a trial buttonhole on a scrap piece of fabric.

■ Sewing buttonholes on stretch fabrics

When sewing buttonholes on stretch fabrics, use a gimp thread.

- 1 Hook the gimp thread onto the part of buttonhole foot “A” shown in the illustration so that it fits into the grooves, and then loosely tie it.

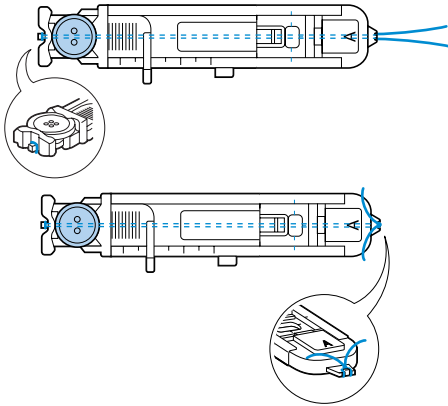

- 2 Attach buttonhole foot “A”.
 - For details, refer to “Replacing the presser foot” (page 41).

- 3 Select stitch 46 or 47.

- 4 Adjust the stitch width to the thickness of the gimp thread.

- 5 Lower the presser foot lever and the buttonhole lever, and then start sewing.

- 6 When sewing is finished, gently pull the gimp thread to remove any slack.

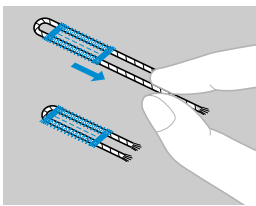

- 7 Use a handsewing needle to pull the gimp thread to the wrong side of the fabric, and then tie it.

- 8 With a seam ripper, cut the middle part of the gimp thread remaining at the top end of the buttonhole.

Trim off any excess of the gimp thread.

Button sewing

Buttons can be sewn on with the sewing machine. Buttons with 2 or with 4 holes can be attached.

- 1 Measure the distance between the holes in the button to be attached.

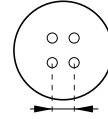

- 2 Raise the presser foot lever, and then slide the drop feed lever, located at the rear of the machine on the base, to the right as seen from the front of the machine.

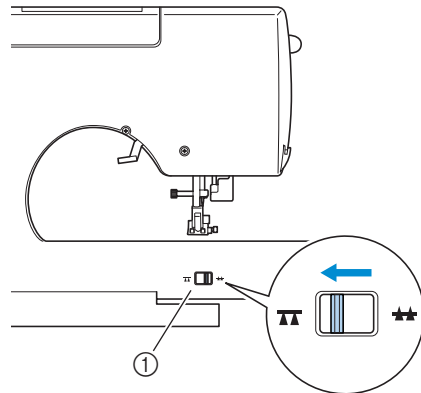

- 1 Drop feed lever (as seen from the rear of the machine)

► The feed dogs are lowered.

- 3 Attach button-sewing foot “M”.

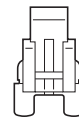

- For details, refer to “Replacing the presser foot” (page 41).

4 Place the button into button-sewing foot “M”.

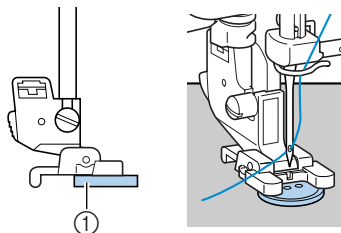

① Button

- When attaching four-hole buttons, first sew the two holes closest to you. Then, slide the button so that the needle goes into the two holes toward the rear of the sewing machine, and then sew them in the same way.

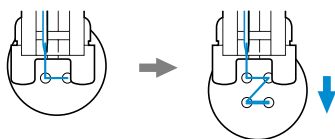

5 Select stitch 55.

- For details, refer to “Selecting stitching” (page 66).

6 Adjust the stitch width so that it is the same as the distance between the holes in the button.

7 Turn the balance wheel toward you to check that the needle correctly goes into the two holes of the button.

Adjust the stitch width to the distance between the button holes.

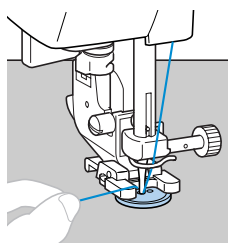
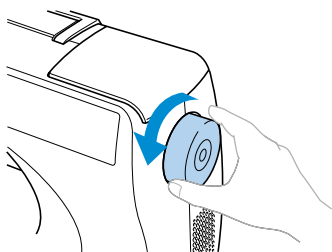

! CAUTION

- When sewing, be sure that the needle does not touch the button, otherwise the needle may bend or break.

8 Start sewing.

- ▶ The sewing machine automatically stops after sewing reinforcement stitches.
- If additional strength is needed to secure the button, perform the button-sewing operation twice.
- Do not press the thread cutter button.

9 Pull the upper thread at the end of the stitching to the wrong side of the fabric, and then tie it with the bobbin thread.

Use scissors to cut the upper thread and the bobbin thread at the beginning of the stitching.

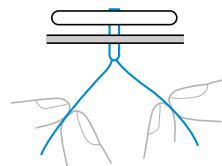

10 When you are finished attaching the button, slide the drop feed lever to ▲▲ (to the left as seen from the front of the machine) to raise the feed dogs.

Zipper Insertion

A zipper can be sewn in place.

Stitch Name	Pattern	Application	Stitch Width [mm (inch.)]		Stitch Length [mm (inch.)]		Presser Foot
			Auto	Manual	Auto	Manual	
Straight stitch (center needle position)	3 -	Attaching zippers Sewing concealed seams and pintucks	-	-	2.5 (3/32)	0.2–5.0 (1/64–3/16)	I

There are many methods for inserting zippers. The procedures for inserting a centered zipper and a side zipper are described below.

Inserting a centered zipper

Stitching is sewn on both pieces of fabric butted against each other.

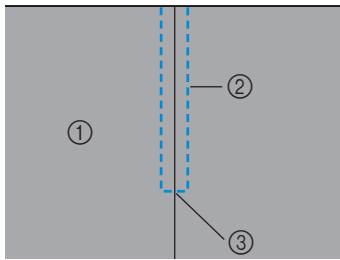

- ① Right side of fabric
- ② Stitching
- ③ End of zipper opening

1 Attach zigzag foot “J” and sew straight stitches up to the zipper opening.

With the right sides of the fabric facing each other, sew reverse stitches after reaching the zipper opening.

- For details, refer to “Basic Stitching” (page 72).

2 Using a basting stitch, continue sewing to the edge of the fabric.

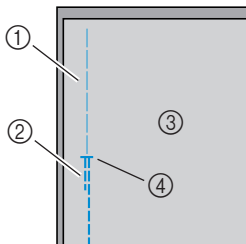

- ① Basting stitching
- ② Reverse stitches
- ③ Wrong side of fabric
- ④ End of zipper opening

3 Press open the seam allowance from the wrong side of the fabric.

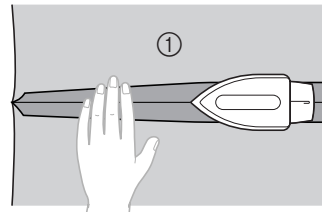

- ① Wrong side of fabric

4 Align the seam with the center of the zipper, and then baste the zipper in place.

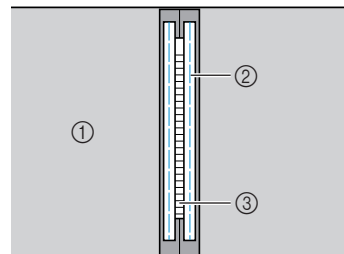

- ① Basting stitching
- ② Wrong side of fabric
- ③ Zipper

5 Attach the presser foot holder to the right pin of zipper foot “1”.

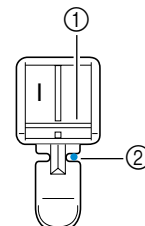

- ① Pin on the right side
- ② Needle drop point

- For details, refer to “Replacing the presser foot” (page 41).

6 Select stitch ³ .

- For details, refer to "Selecting stitching" (page 66).

! CAUTION

- When using zipper foot "I", be sure to select the straight stitch (center needle position), and slowly turn the balance wheel toward you to check that the needle does not touch the presser foot. If a different stitch is selected or the needle hits the presser foot, the needle may bend or break.

7 Topstitch around the zipper.

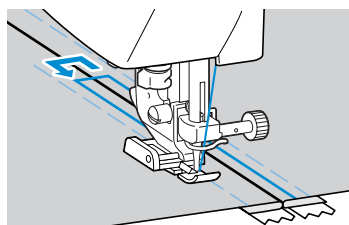
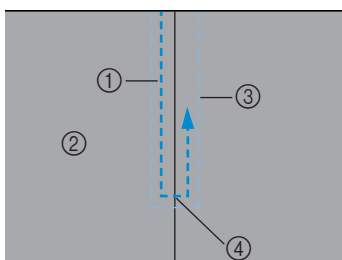

- ① Stitching
- ② Right side of fabric
- ③ Basting stitching
- ④ End of zipper opening

! CAUTION

- When sewing, be sure that the needle does not touch the zipper, otherwise the needle may bend or break.

8 Remove the basting stitching.

Inserting a side zipper

Stitching is sewn on only one piece of fabric. Use this type of zipper for side openings and back openings.

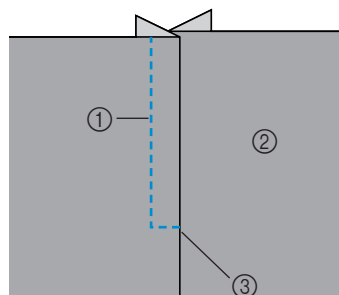

- ① Stitching
- ② Right side of fabric
- ③ End of zipper opening

The following procedure will describe how to stitch on the left side, as shown in the illustration.

1 Attach zigzag foot "J" and sew straight stitches up to the zipper opening.

With the right sides of the fabric facing each other, sew reverse stitches after reaching the zipper opening.

- For details, refer to "Basic Stitching" (page 72).

2 Using a basting stitch, continue sewing to the edge of the fabric.

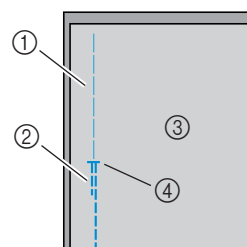

- ① Basting stitching
- ② Reverse stitches
- ③ Wrong side of fabric
- ④ End of zipper opening

3 Press open the seam allowance from the wrong side of the fabric.

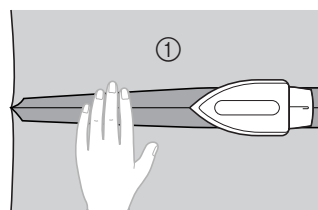

- ① Wrong side of fabric

- 4** Press the seam allowance so that the right side (the side that will not be stitched) has an extra 3 mm (1/8 inch).

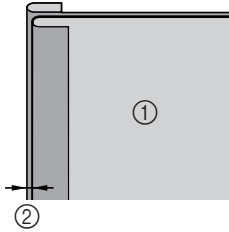

- ① Wrong side of fabric
- ② 3 mm (1/8 inch)

- 5** Align the zipper teeth with the pressed edge of the fabric having the extra 3 mm (1/8 inch), and then baste or pin the zipper in place.

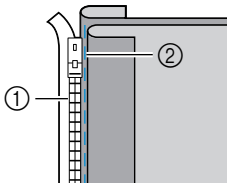

- ① Zipper teeth
- ② Basting stitching

- 6** Attach the presser foot holder to the right pin of zipper foot "1".

If the stitching will be sewn on the right side, attach the presser foot holder to the left pin of the zipper foot.

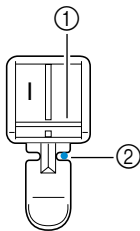

- ① Pin on the right side
- ② Needle drop point

- For details, refer to "Replacing the presser foot" (page 41).

- 7** Select stitch 3 " .

- For details, refer to "Selecting stitching" (page 66).

! CAUTION

- When using zipper foot "1", be sure to select the straight stitch (center needle position), and slowly turn the balance wheel toward you to check that the needle does not touch the presser foot. If a different stitch is selected or the needle hits the presser foot, the needle may bend or break.

- 8** Sew the zipper to the piece of fabric with the extra 3 mm (1/8 inch), starting from the base of the zipper.

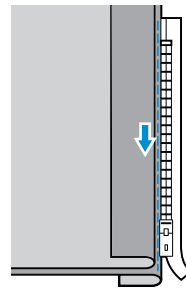

! CAUTION

- When sewing, be sure that the needle does not touch the zipper, otherwise the needle may bend or break.

- 9** When you are about 5 cm (2 inch) from the end of the zipper, stop the sewing machine with the needle lowered (in the fabric), raise the presser foot lever, and then open the zipper and continue sewing.

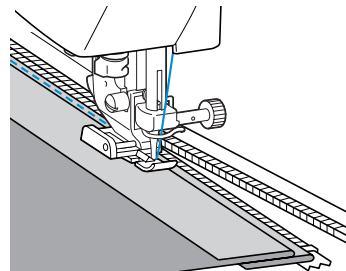

- 10** Close the zipper, turn over the fabric, and then baste the other side of the zipper to the fabric.

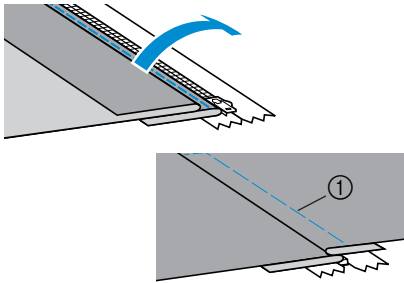

① Basting stitching

- 11** Attach the presser foot holder to the other pin of zipper foot “1”.

If the presser foot holder was attached to the right pin in step 6, change it to the left pin.

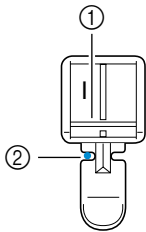

① Pin on the left side
② Needle drop point

- 12** Topstitch around the zipper. Sew reverse stitches at the end of the zipper opening and align the zipper teeth with the side of the presser foot.

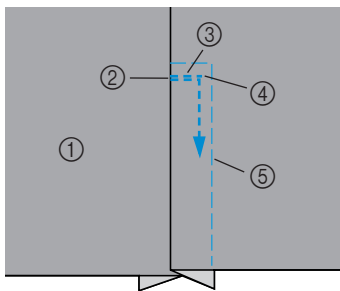

① Right side of fabric
② End of zipper opening
③ Reverse stitches
④ Beginning of stitching
⑤ Basting stitching



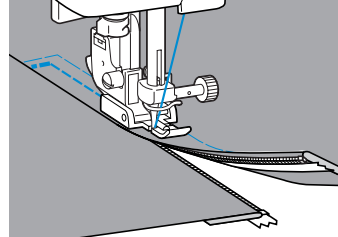

- 13** When you are about 5 cm (2 inch) from the end of the zipper, stop the sewing machine with the needle lowered (in the fabric), and then raise the presser foot lever.

- 14** Remove the basting stitching, open the zipper, and then continue sewing.



Sewing Stretch Fabrics and Elastic Tape

Stretch fabrics can be sewn and elastic tape can be attached.

Stitch Name	Pattern	Application	Stitch Width [mm (inch.)]		Stitch Length [mm (inch.)]		Presser Foot
			Auto	Manual	Auto	Manual	
Stretch stitch	5 	Stretch fabrics	1.0 (1/16)	1.0–3.0 (1/16–1/8)	2.5 (3/32)	1.0–4.0 (1/16–3/16)	J
2-point zigzag stitch	9 	Attaching elastic	5.0 (3/16)	1.5–7.0 (1/16–1/4)	1.0 (1/16)	0.2–4.0 (1/64–3/16)	
3-point zigzag stitch	10 		5.0 (3/16)	1.5–7.0 (1/16–1/4)	1.0 (1/16)	0.2–4.0 (1/64–3/16)	
Elastic-attaching stitch	28 	Attaching elastic to stretch fabrics	4.0 (3/16)	0.0–7.0 (0–1/4)	1.0 (1/16)	0.2–4.0 (1/64–3/16)	

Observe the corresponding precautions when performing each of the following stitching operations.

Stretch stitching

1 Attach zigzag foot “J”.

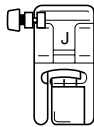

- For details, refer to “Replacing the presser foot” (page 41).

2 Select stitch 5 .

- For details, refer to “Selecting stitching” (page 66).

3 Sew the fabric without stretching it.

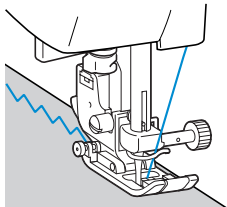

Elastic attaching

When elastic tape is attached to the cuff or waist of a piece of clothing, the finished dimensions will be that of the stretched elastic tape. Therefore, it is necessary that a suitable length of the elastic tape be used.

1 Pin the elastic tape to the wrong side of the fabric.

Pin the elastic tape to the fabric at a few points to make sure that the tape is uniformly positioned on the fabric.

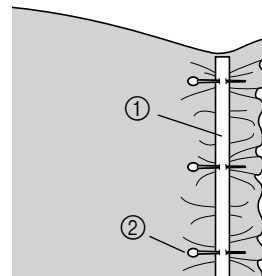

- ① Elastic tape
- ② Pin

2 Attach zigzag foot “J”.

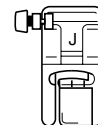

- For details, refer to “Replacing the presser foot” (page 41).

- 3 Select a stitch.**
- For details, refer to “Selecting stitching” (page 66).

- 4 Sew the elastic tape to the fabric while stretching the tape so that it is the same length as the fabric.**

While pulling the fabric behind the presser foot with your left hand, pull the fabric at the pin nearest the front of the presser foot with your right hand.

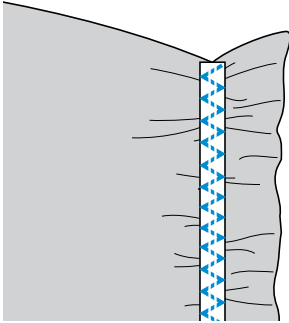
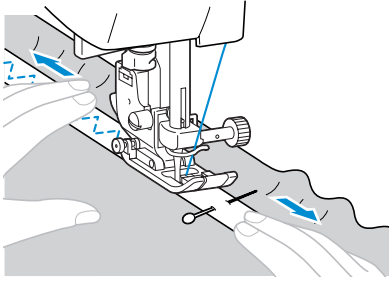











! CAUTION

- When sewing, be sure that the needle does not touch any pins, otherwise the needle may bend or break.

Appliqué, Patchwork and Quilt Stitching

The stitches that can be used for sewing appliqués, patchwork and quilts are described below.

Stitch Name	Pattern	Application	Stitch Width [mm (inch.)]		Stitch Length [mm (inch.)]		Presser Foot
			Auto	Manual	Auto	Manual	
Zigzag stitch	7 	Attaching appliqués (center baseline/reverse stitching)	3.5 (1/8)	0.0–7.0 (0–1/4)	1.4 (1/16)	0.0–4.0 (0–3/16)	J
	60 	Appliqué quilting, free-motion quilting, satin stitching	3.5 (1/8)	0.0–7.0 (0–1/4)	1.4 (1/16)	0.0–4.0 (0–3/16)	
Appliqué stitch	19 	Attaching appliqués	3.5 (1/8)	2.5–5.0 (3/32–3/16)	2.5 (3/32)	1.6–4.0 (1/16–3/16)	
	61 	Attaching appliqués and binding	1.5 (1/16)	0.5–5.0 (1/32–3/16)	1.2 (1/16)	1.0–4.0 (1/16–3/16)	
Piecing straight stitch	57 	Piecing straight stitching (with a seam allowance of 6.5 mm from the right edge of the presser foot)	5.5 (7/32)	0.0–7.0 (0–1/4)	1.6 (1/16)	0.2–5.0 (1/64–3/16)	
	58 	Piecing straight stitching (with a seam allowance of 6.5 mm from the left edge of the presser foot)	1.5 (1/16)	0.0–7.0 (0–1/4)	1.6 (1/16)	0.2–5.0 (1/64–3/16)	
Joining stitch	22 	Patchwork stitching	4.0 (3/16)	0.0–7.0 (0–1/4)	1.2 (1/16)	0.2–4.0 (1/64–3/16)	
	23 		5.0 (3/16)	2.5–7.0 (3/32–1/4)	2.5 (3/32)	1.0–4.0 (1/16–3/16)	
	24 		5.0 (3/16)	0.0–7.0 (0–1/4)	1.2 (1/16)	0.2–4.0 (1/64–3/16)	
Mock hand quilting stitch	59 	Straight stitch quilting that looks hand quilting	0.0 (0)	0.0–7.0 (0–1/4)	2.5 (3/32)	1.0–4.0 (1/16–3/16)	
Quilting stippling	62 	Stippling	7.0 (1/4)	1.0–7.0 (1/16–1/4)	1.6 (1/16)	1.0–4.0 (1/16–3/16)	

Appliqué stitching

- 1 Cut out the appliqué, leaving a seam allowance of between 3 and 5 mm (1/8 and 3/16 inch).

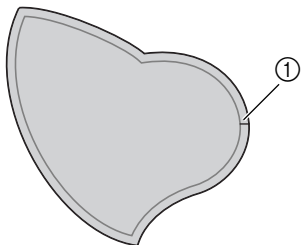

① Seam allowance

- 2 Place a pattern made of thick paper on the back of the appliqué, and then fold over the seam allowance using an iron.

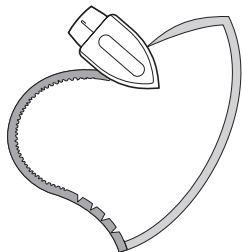

- Remove the thick paper after pressing the seam allowance.

- 3 Turn the fabric over, and then baste or pin it onto the fabric that it will be attached to.

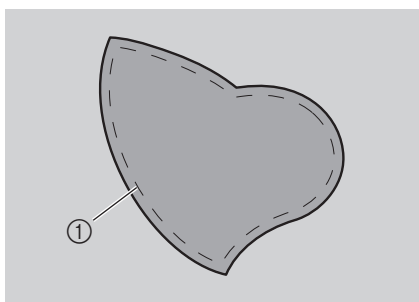

① Basting stitching

- 4 Attach zigzag foot "J".

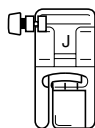

- For details, refer to "Replacing the presser foot" (page 41).

- 5 Select a stitch.
 - For details, refer to "Selecting stitching" (page 66).

- 6 Turn the balance wheel toward you, and then begin sewing around the edge of the appliqué, making sure that the needle drops just outside of the appliqué.

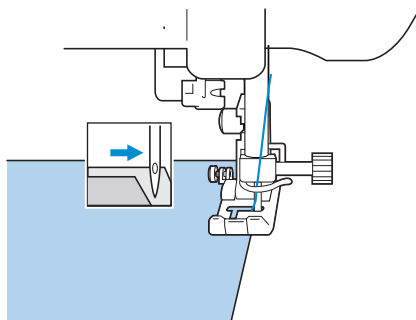

When sewing around corners, stop the machine with the needle in the fabric just outside of the appliqué, raise the presser foot lever, and then turn the fabric as needed to change the sewing direction.

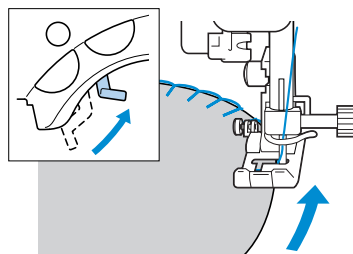



Memo

- To change the width of the seam allowance (the needle position), adjust the stitch width.

Quilting

Sandwiching batting between the top and bottom layers of fabric is called “quilting”. Quilts can easily be sewn using the optional walking foot and the optional quilting guide.

- 1 Baste the fabric to be quilted.**
- 2 Attach the walking foot.**
 - For details, refer to “Using the optional walking foot” (page 44).
- 3 Select a stitch.**
 - For details, refer to “Selecting stitching” (page 66).
- 4 Place one hand on each side of the presser foot, and then evenly stretch the fabric while sewing.**

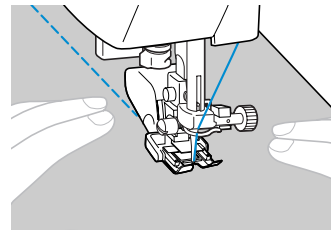

Note

- When sewing with the walking foot, sew at a speed between slow and medium.

■ Using the optional quilting guide

Use the quilting guide to sew parallel stitches that are equally spaced.

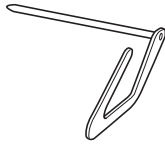

- 1 Insert the stem of the quilting guide into the hole at the rear of the walking foot or presser foot holder.

Walking foot

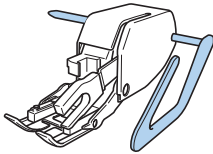

Presser foot holder

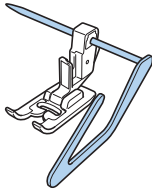

- 2 Adjust the stem of the quilting guide so that the quilt guide aligns with the seam that has already been sewn.

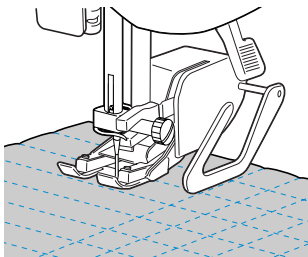

Free-motion quilting

With free-motion quilting, the feed dogs can be lowered (using the drop feed lever) so that the fabric can be moved freely in any direction. The optional quilting foot is needed for free-motion quilting.

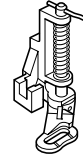

- 1 Remove the presser foot and the presser foot holder.

- Refer to "Removing the presser foot holder" (page 43).

- 2 Align the quilting foot with the lower-left side of the presser bar.

The pin on the quilting foot should be positioned over the needle clamp screw.

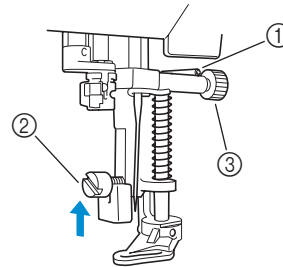

- ① Pin on quilting foot
- ② Presser foot holder screw
- ③ Needle clamp screw

- 3 Hold the quilting foot in place with your right hand, and then tighten the presser foot holder screw using the screwdriver in your left hand.

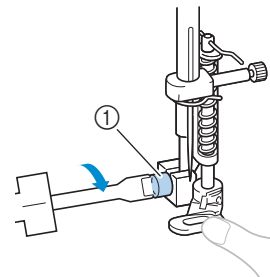

- ① Presser foot holder screw

! CAUTION

● Be sure to securely tighten the screws with the screwdriver, otherwise the needle may touch the presser foot, causing it to bend or break.

- 4** Slide the drop feed lever, located at the rear of the machine on the base, to  (to the right as seen from the front of the machine).

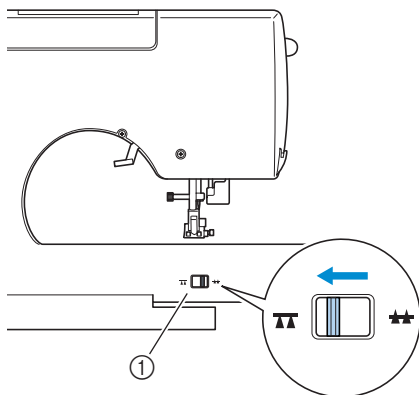

① Feed dog position switch
(as seen from the rear of the machine)

► The feed dogs are lowered.

- 5** Turn on the sewing machine, and then select a stitch.

- For details, refer to “Selecting stitching” (page 66).

- 6** Use both hands to stretch the fabric taut, and then move the fabric to follow the pattern.

Reinforcement stitches are sewn at the beginning and end of sewing.

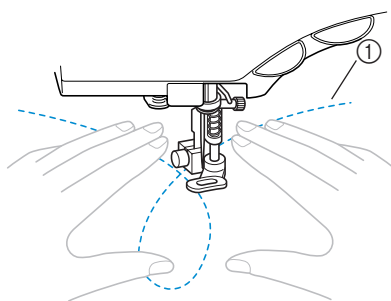

① Pattern

- 7** After sewing is finished, slide the drop feed lever to  (to the left as seen from the front of the machine) to raise the feed dogs.

- Normally, the drop feed lever is positioned at the left.

Satin stitching

A decorative stitch can be sewn by changing the stitch width of a satin stitch. If the sewing machine is set so that the stitch width can be adjusted using the sewing speed controller, the stitch width can quickly and easily be adjusted. In this case, the sewing speed is adjusted with the foot controller.

- 1 Connect the foot controller.**
 - For details, refer to “Starting to sew” (page 51).



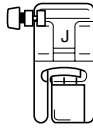

- 2 Attach zigzag foot “J”.**



- For details, refer to “Replacing the presser foot” (page 41).

- 3 Turn on the sewing machine, and then press  (settings key) in the operation panel.**



▶ The settings screen appears.

- 4 Press , ,  and  (arrow keys) until  is selected.**



- 5 Press  (OK key).**

▶ The screen for specifying that the stitch width can be controlled with the sewing speed controller appears.

- 6 Press  to select ON.**
To return to OFF, press .



▶ The machine is now set so that the stitch width can be controlled with the sewing speed controller.

- 7 Press  (OK key).**

▶ The initial stitch screen appears again.

- 8 Select stitch .**

- For details, refer to “Selecting stitching” (page 66).

- 9 While sewing, slide the sewing speed controller to adjust the stitch width.**
Slide the controller to the left to make the width narrower. Slide the controller to the right to make the width wider.

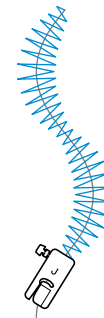
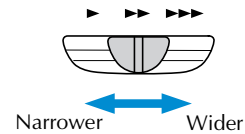

- Adjust the sewing speed with the foot controller.

- 10 When you are finished sewing, set the stitch width control setting back to OFF.**

Memo

- Although the stitching result differs depending on the type of fabric being sewn and the thickness of the thread being used, for best results, adjust the stitch length to between 0.3 and 0.5 mm (1/64 and 1/32 inch).

Reinforcement Stitching

Reinforce points that will be subject to strain, such as sleeve holes, inseams and pocket corners.

Stitch Name	Pattern	Application	Stitch Width [mm (inch.)]		Stitch Length [mm (inch.)]		Presser Foot
			Auto	Manual	Auto	Manual	
Triple stretch stitch	4	Reinforcing the seams of sleeves and inseams	0.0 (0)	0.0–7.0 (0–1/4)	2.5 (3/32)	1.5–4.0 (1/16–3/16)	J
Bar tack stitch	54	Reinforcing the ends of openings, such as the corners of pockets	2.0 (1/16)	1.0–3.0 (1/16–1/8)	0.4 (1/64)	0.3–1.0 (1/64–1/16)	A
Darning stitch	52	Darning mediumweight fabrics	7.0 (1/4)	2.5–7.0 (3/32–1/4)	2.0 (1/16)	0.4–2.5 (1/64–3/32)	
	53	Darning thick fabrics	7.0 (1/4)	2.5–7.0 (3/32–1/4)	2.0 (1/16)	0.4–2.5 (1/64–3/32)	

Triple stretch stitching

Use triple stretch stitching to reinforce sleeve holes and inseams.

1 Attach zigzag foot “J”.

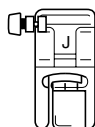

- For details, refer to “Replacing the presser foot” (page 41).

2 Select stitch 4

- For details, refer to “Selecting stitching” (page 66).

3 Start sewing.

- For details, refer to “Starting to sew” (page 51).

Bar tack stitching

Bar tacks are used to reinforce points subject to strain, such as pocket corners and openings. As an example, the procedure for sewing bar tacks at pocket corners is described below.

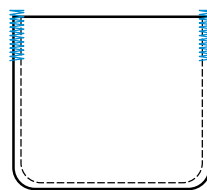

- ### 1 Determine the desired length of the bar tack.
- Set the button guide plate on buttonhole foot “A” to the desired length. (The distance between the markings on the presser foot scale is 5 mm (3/16 inch).)

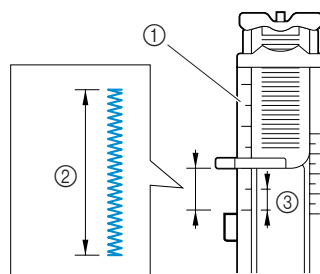

- ① Presser foot scale
- ② Length of bar tack
- ③ 5 mm (3/16 inch)

- A bar tack with a maximum length of about 28 mm (1-1/8 inch) can be sewn.

- 2 Attach buttonhole foot “A”.**
- For details, refer to “Replacing the presser foot” (page 41).

- 3 Select stitch 54** .
- For details, refer to “Selecting stitching” (page 66).

- 4 Position the fabric so that the opening of the pocket faces toward you, and then lower the presser foot lever so that the needle drops 2 mm (1/16 inch) in front of the pocket opening.**

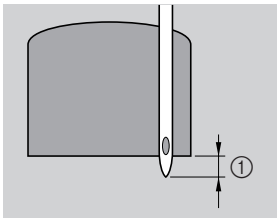

① 2 mm (1/16 inch)

Pass the upper thread down through the hole in the presser foot.

- When lowering the presser foot, do not push in the front of the presser foot, otherwise the bar tack will not be sewn with the correct size.

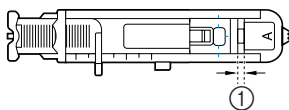
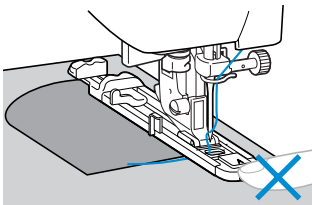

① Do not reduce the gap.

- 5 Pull down the buttonhole lever as far as possible.**

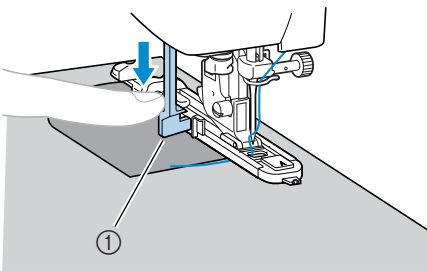

① Buttonhole lever

The buttonhole lever is positioned behind the bracket on the buttonhole foot.

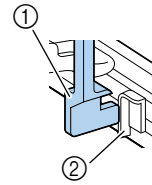

① Buttonhole lever
② Bracket

- 6 Gently hold the end of the upper thread in your left hand, and then start sewing.**

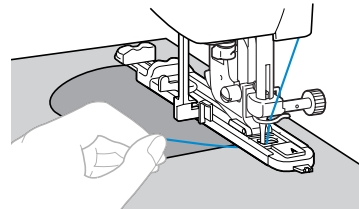

- ▶ Once sewing is completed, the machine automatically sews reinforcement stitches, then stops

- 7 Raise the presser foot lever, remove the fabric, and then cut the threads.**

- 8 Raise the buttonhole lever to its original position.**

 **Memo**

- If the fabric does not feed, for example, because it is too thick, increase the stitch length. For details, refer to “Adjusting the stitch length” (page 58).

Darning

Fabric that has been torn can be darned.
Darning is sewn as shown below.

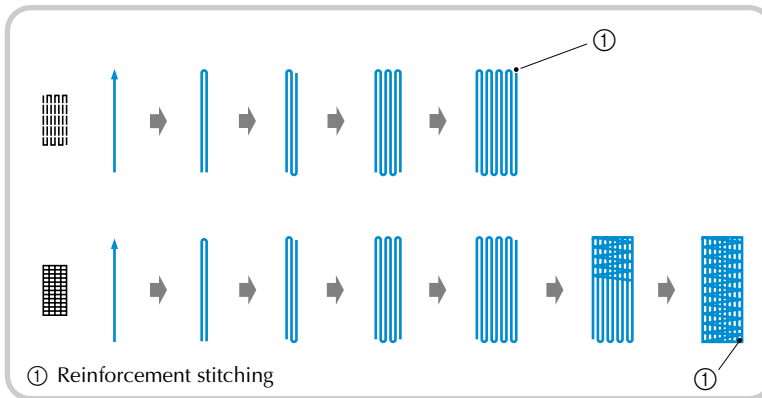

① Reinforcement stitching

- Determine the desired length of the darning.**
Set the button guide plate on buttonhole foot "A" to the desired length. (The distance between the markings on the presser foot scale is 5 mm (3/16 inch).)

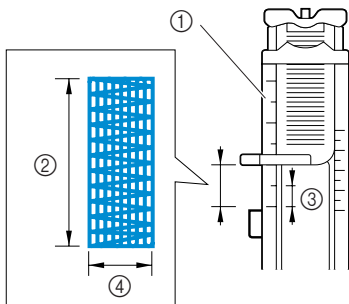

- Presser foot scale
- Length of darning
- 5 mm (3/16 inch)
- 7 mm (1/4 inch)

- A bar tack with a maximum length of about 28 mm (1-1/8 inch) can be sewn.

- Attach buttonhole foot "A".**
For details, refer to "Replacing the presser foot" (page 41).

- Select stitch 52 or 53.**

- For details, refer to "Selecting stitching" (page 66).

- Position the fabric so that the needle is 2 mm (1/16 inch) in front of the area to be darned, and then lower the presser foot lever.**

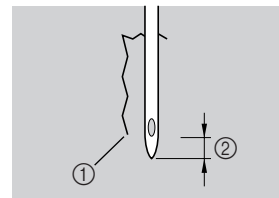

- Tear
- 2 mm (1/16 inch)

Pass the upper thread down through the hole in the presser foot.

- When lowering the presser foot, do not push in the front of the presser foot, otherwise the darning will not be sewn with the correct size.

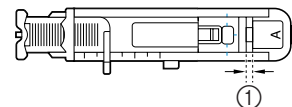
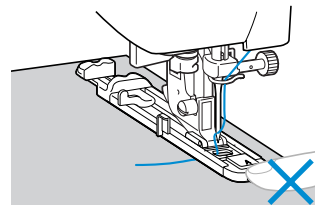

- Do not reduce the gap.

- 5 Pull down the buttonhole lever as far as possible.**

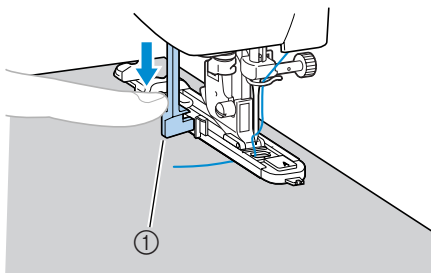

① Buttonhole lever

The buttonhole lever is positioned behind the bracket on the buttonhole foot.

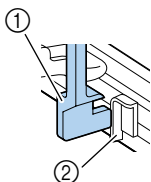

① Buttonhole lever
② Bracket

- 6 Gently hold the end of the upper thread in your left hand, and then start sewing.**

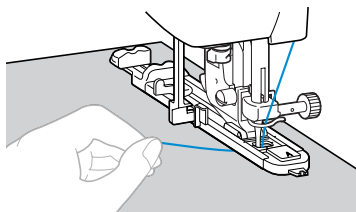

- Once sewing is completed, the machine automatically sews reinforcement stitches, then stops

- 7 Raise the presser foot lever, remove the fabric, and then cut the threads.**

- 8 Raise the buttonhole lever to its original position.**



Memo

- If the fabric does not feed, for example, because it is too thick, increase the stitch length. For details, refer to "Adjusting the stitch length" (page 58).

Eyelet Stitching

Eyelets, such as those on belts, can be sewn. Three sizes of eyelets are possible: 7 mm, 6 mm and 5 mm (1/4, 15/64 and 3/16 inch).

Stitch Name	Pattern	Application	Stitch Width [mm (inch.)]		Stitch Length [mm (inch.)]		Presser Foot
			Auto	Manual	Auto	Manual	
Eyelet stitch	⁵⁶ 	Sewing eyelets, for example, on belts	7.0 (1/4)	7.0, 6.0 or 5.0 (1/4, 15/64 or 3/16)	7.0 (1/4)	7.0, 6.0 or 5.0 (1/4, 15/64 or 3/16)	N

1 Attach monogramming foot "N".

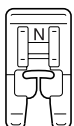

- For details, refer to "Replacing the presser foot" (page 41).

2 Select stitch ⁵⁶ .

- For details, refer to "Selecting stitching" (page 66).

3 Adjust either the stitch width or the stitch length to select the desired eyelet size.



- For details, refer to "Adjusting the Stitch Width and Length" (page 57).

4 Lower the needle into the fabric at the beginning of the stitching, and then lower the presser foot lever.

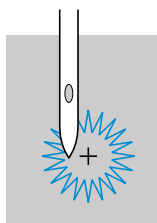

5 Start sewing.

- ▶ Once sewing is completed, the machine automatically sews reinforcement stitches, then stops

6 Use the eyelet punch to cut a hole in the center of the eyelet.

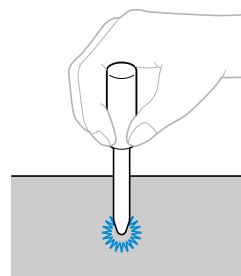



















- When using the eyelet punch, place thick paper or some other protective sheet under the fabric before punching the hole in the fabric.





Memo

- If thin thread is used, the stitching may be coarse. If this occurs, sew the eyelet twice before remove the fabric, one on top of the other.

Decorative Stitching

Various decorative stitches can be sewn with this sewing machine.

Stitch Name	Pattern	Application	Stitch Width [mm (inch.)]		Stitch Length [mm (inch.)]		Presser Foot	
			Auto	Manual	Auto	Manual		
Fagoting stitch	26 	Sewing two pieces of fabric together across an open seam	5.0 (3/16)	0.0–7.0 (0–1/4)	2.5 (3/32)	1.0–4.0 (1/16–3/16)	J	
	27 		5.0 (3/16)	2.5–7.0 (3/25–1/4)	2.5 (3/32)	1.0–4.0 (1/16–3/16)		
Joining stitch	22 	Decorative bridging stitches	4.0 (3/16)	0.0–7.0 (0–1/4)	1.2 (1/16)	0.2–4.0 (1/64–3/16)		
	23 		5.0 (3/16)	2.5–7.0 (3/32–1/4)	2.5 (3/32)	1.0–4.0 (1/16–3/16)		
	24 		5.0 (3/16)	0.0–7.0 (0–1/4)	1.2 (1/16)	0.2–4.0 (1/64–3/16)		
Shell tuck stitch	20 	Shell tuck stitching on collars and curves	4.0 (3/16)	0.0–7.0 (0–1/4)	2.5 (3/32)	0.2–4.0 (1/64–3/16)		
Smocking stitch	25 	Smocking fabrics to add texture and elasticity	5.0 (3/16)	0.0–7.0 (0–1/4)	1.6 (1/16)	1.0–4.0 (1/16–3/16)		
	26 		5.0 (3/16)	0.0–7.0 (0–1/4)	2.5 (3/32)	1.0–4.0 (1/16–3/16)		
	27 		5.0 (3/16)	2.5–7.0 (3/32–1/4)	2.5 (3/32)	1.0–4.0 (1/16–3/16)		
Scallop stitch	21 	Satin scallop stitching	5.0 (3/16)	2.5–7.0 (3/32–1/4)	0.5 (1/32)	0.1–1.0 (1/64–1/16)		
Decorative stitch	33 	Lace sewing, decorative hemming, heirloom stitching, etc.	3.5 (1/8)	1.5–7.0 (1/16–1/4)	2.5 (3/32)	1.6–4.0 (1/16–3/16)		N
	34 		6.0 (15/64)	1.5–7.0 (1/16–1/4)	3.0 (1/8)	1.5–4.0 (1/16–3/16)		
	35 	Decorative hemming and heirloom stitching, etc. on thin, mediumweight and plain weave fabrics	5.0 (3/16)	1.5–7.0 (1/16–1/4)	3.5 (1/8)	1.5–4.0 (1/16–3/16)		
	36 		5.0 (3/16)	1.5–7.0 (1/16–1/4)	4.0 (3/16)	1.5–4.0 (1/16–3/16)		
	37 		5.0 (3/16)	1.5–7.0 (1/16–1/4)	2.5 (3/32)	1.5–4.0 (1/16–3/16)		
	38 		5.0 (3/16)	1.5–7.0 (1/16–1/4)	2.0 (1/16)	1.5–4.0 (1/16–3/16)		
	39 		Decorative hemming, ribbon threading, heirloom stitching, etc.	5.0 (3/16)	1.5–7.0 (1/16–1/4)	3.0 (1/8)	1.5–4.0 (1/16–3/16)	
	40 	Heirloom stitching, etc.	6.0 (15/64)	1.5–7.0 (1/16–1/4)	1.6 (1/16)	1.0–4.0 (1/16–3/16)		
41 	5.0 (3/16)		1.5–7.0 (1/16–1/4)	1.6 (1/16)	1.0–4.0 (1/16–3/16)			

Stitch Name	Pattern	Application	Stitch Width [mm (inch.)]		Stitch Length [mm (inch.)]		Presser Foot
			Auto	Manual	Auto	Manual	
Decorative stitch	29 	Decorative stitching	4.0 (3/16)	0.0–7.0 (0–1/4)	3.0 (1/8)	2.0–4.0 (1/16–3/16)	J
	30 		4.0 (3/16)	0.0–7.0 (0–1/4)	2.5 (3/32)	1.0–4.0 (1/16–3/16)	
	31 		5.5 (7/32)	0.0–7.0 (0–1/4)	1.6 (1/16)	1.0–4.0 (1/16–3/16)	
	32 		5.0 (3/16)	1.5–7.0 (1/16–1/4)	1.0 (1/16)	0.2–4.0 (1/64–3/16)	N

Fagoting

Stitching across an open seam is called “fagoting”. It is used on blouses and children's clothing. This stitch is more decorative when thicker thread is used.

- 1 Use an iron to fold the two pieces of fabric along their seams.
- 2 Baste the two pieces of fabric, separated by about 4 mm (3/16 inch), onto thin paper or a sheet of water-soluble stabilizer.

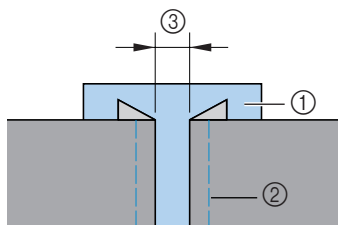

- 1 Thin paper or water soluble stabilizer
- 2 Basting stitching
- 3 4 mm (3/16 inch)

- 3 Attach zigzag foot “J”.

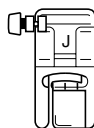

- For details, refer to “Replacing the presser foot” (page 41).

- 4 Select stitch 26  or 27 .

- For details, refer to “Selecting stitching” (page 66).

- 5 Set the stitch width to 7.0 mm (1/4 inch).

- For details, refer to “Adjusting the stitch width” (page 57).

- 6 Sew with the center of the presser foot aligned along the center of the two pieces of fabric.

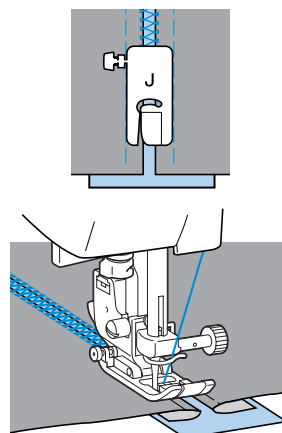

- 7 After sewing is finished, remove the paper.

Scallop stitching

The wave-shaped repeating pattern that looks like shells is called “scalloping”. It is used on the collars of blouses and to decorate the edges of handkerchiefs.

1 Attach monogramming foot “N”.

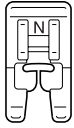

- For details, refer to “Replacing the presser foot” (page 41).

2 Select stitch ²¹ }.

- For details, refer to “Selecting stitching” (page 66).

3 Stitch along the edge of the fabric, making sure not to sew directly on the edge of the fabric.

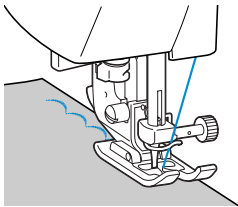

- For better results, apply spray starch onto the fabric and press with a hot iron before it is sewn.

4 Trim along the stitches.

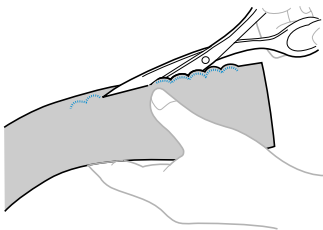

- Be careful not to cut the stitches.

Smocking

The decorative stitch created by stitching or embroidering over gathers is called “smocking”. It is used to decorate the front of blouses or cuffs. The smocking stitch adds texture and elasticity to fabric.

1 Attach zigzag foot “J”.

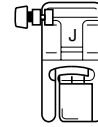

- For details, refer to “Replacing the presser foot” (page 41).

2 Select the straight stitch, and then adjust the stitch length to 4.0 mm (3/16 inch) and loosen the thread tension.

- For details, refer to “Adjusting the stitch length” (page 58) and “Changing the tension of the upper thread” (page 56).

3 Sew parallel stitching at intervals of 1 cm (3/8 inch).

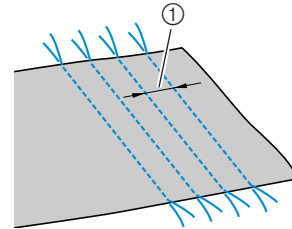



① 1 cm (3/8 inch)

- It is not necessary to sew reverse/reinforcement stitches or cut the thread.

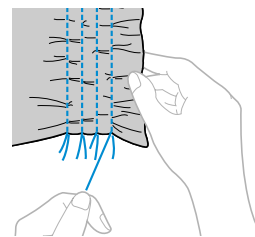
4 Pull the bobbin threads to create gathers. Smooth the gathers by ironing them.



- 5** Select stitch ²⁵ , ²⁶  or ²⁷ .
- For details, refer to “Selecting stitching” (page 66).

- 6** Stitch between the straight stitches.

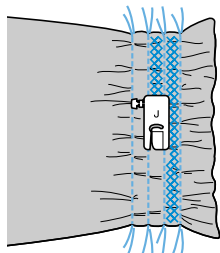

- 7** Pull out the threads for the straight stitches.

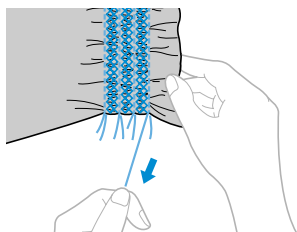

Shell tuck stitching

The gathers that look like shells are called “shell tucks”. They are used to decorate trims, the front of blouses or cuffs made of thin fabrics.

- 1** Fold the fabric along the bias.

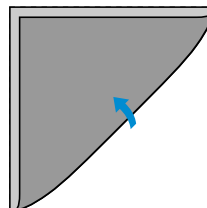

- 2** Attach zigzag foot “J”.

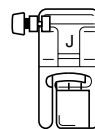

- For details, refer to “Replacing the presser foot” (page 41).

- 3** Select stitch ²⁰ , and then increase the thread tension.

- For details, refer to “Selecting stitching” (page 66).

- 4** Sew while making sure that the needle drops slightly off the edge of the fabric.

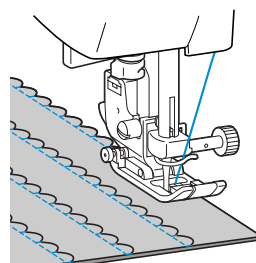
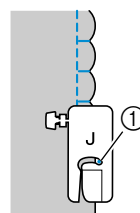

- ① Needle drop point

- 5** Unfold the fabric, and then iron the tucks down to one side.

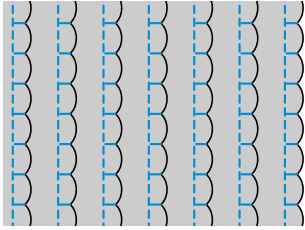

Joining

Decorative bridging stitches can be sewn over the seam allowance of joined fabrics. This is used when making a crazy quilt.

- 1** Attach zigzag foot “J”.

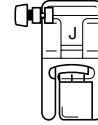

- For details, refer to “Replacing the presser foot” (page 41).

- 2** Sew together the right sides of the two pieces of fabric, and then open up the seam allowances.

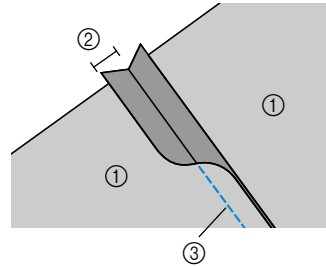

- ① Wrong side of fabric
- ② 6.5 mm (1/4 inch) seam allowance
- ③ Straight stitch

- 3** Select stitch 22, 23 or 24.

- For details, refer to “Selecting stitching” (page 66).

- 4** Turn the fabric over so that the right side faces up, and then sew over the seam with the center of the presser foot aligned with the seam.

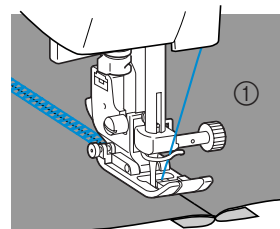

- ① Right side of fabric

Heirloom stitching

When sewing with the wing needle, the needle holes are enlarged, creating a lace-like decorative stitch. This is used to decorate hems and tablecloths on thin or mediumweight fabrics in addition to plain weave fabrics.

1 Install the wing needle.

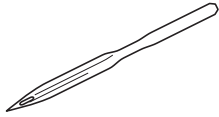

- Use a 130/705H 100/16 wing needle.
- For details on installing a needle, refer to “Replacing the needle” (page 38).
- The needle threader cannot be used with the wing needle, otherwise the sewing machine may be damaged. Manually pass the thread through the eye of the needle from the front to the back.
For details, refer to “Thread the needle manually” (page 31)



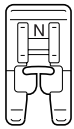



2 Attach monogramming foot “N”.





- For details, refer to “Replacing the presser foot” (page 41).

3 Select a stitch.

The stitches that can be used are 33 ,

34 , 35 , 36 , 37 , 38 , 39 ,

40  or 41 .

- For details, refer to “Selecting stitching” (page 66).
- Select a stitch width of 6.0 mm (15/64 inch) or less.

4 Start sewing.

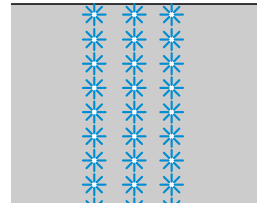

! CAUTION

- Select a stitch width of 6.0 mm (15/64 inch) or less, otherwise the needle may bend or break.
- After adjusting the stitch width, slowly turn the balance wheel toward you and check that the needle does not touch the presser foot. If the needle hits the presser foot, the needle may bend or break.

Partially removing threads is called “drawnwork”. This gives a beautiful result with fabrics that have a loose weave.

Two ways to create drawnwork are described below.

■ Drawnwork (Example 1)

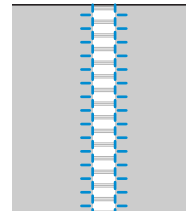

1 Pull out several threads from the fabric.

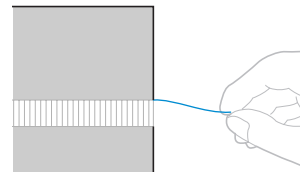

2 Attach monogramming foot “N”.

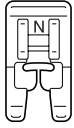



- For details, refer to “Replacing the presser foot” (page 41).

3 Select stitch 33.



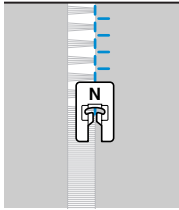

- For details, refer to “Selecting stitching” (page 66).

4 With the right side of the fabric facing up, sew along the right edge of the frayed section.



5 Press  (settings key) in the operation panel.

- ▶ The settings screen appears.

6 Press , ,  and  (arrow keys) until  is selected.



7 Press  (OK key).

- ▶ The screen for mirror imaging the pattern appears.

8 Press  to select .

To return to , press .

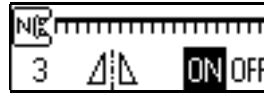

- ▶ The pattern is flipped.

9 Press  (OK key).

- ▶ The initial stitch screen appears again.

10 Sew along the other edge of the frayed section so that it looks like the previous stitching.

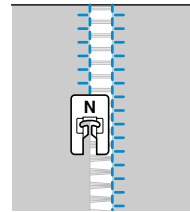

11 Set the mirror image pattern setting back to OFF.

■ Drawnwork (Example 2)

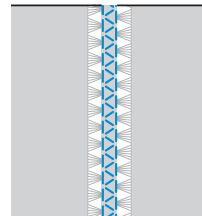

1 Pull out several threads from two sections of the fabric, separated by an unfrayed section of about 4 mm (3/16 inch).

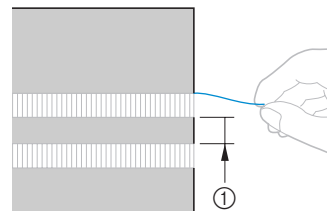

① 4 mm (3/16 inch)

2 Attach monogramming foot “N”.

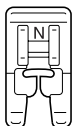

- For details, refer to “Replacing the presser foot” (page 41).

3 Select stitch ³⁶ .

- For details, refer to “Selecting stitching” (page 66).

4 Sew along the center of the unfrayed section.

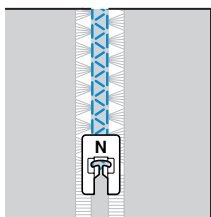

Sewing the Various Built-In Decorative Patterns

Decorative stitches, satin stitches and cross-stitches can be sewn. All are sewn with monogramming foot “N”.

Sewing beautiful patterns

In order to sew the patterns correctly, the following must be considered.

■ Fabric

Before sewing stretch or thin fabrics or fabrics with a coarse weave, affix the optional stabilizer material to the wrong side of the fabric or place a thin sheet of paper, such as tracing paper, under the fabric. Since material puckering or bunched stitches may occur when satin stitches are sewn, be sure to affix stabilizer material to the fabric.

■ Needles and threads

When sewing thin, mediumweight or stretch fabrics, use the ball point needle. When sewing thick fabrics, use a 90/14 home sewing machine needle. In addition, 75/11 to 90/14 thread should be used.

■ Trial sewing

Depending on the type and thickness of the fabric being sewn and whether or not stabilizer material is used, the desired result may not be achieved. Be sure to sew a trial piece of fabric before sewing your project. In addition, while sewing, be sure to guide the fabric with your hands in order to prevent the fabric from slipping.

Sewing patterns

1 Attach monogramming foot “N”.

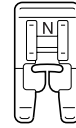

- For details, refer to “Replacing the presser foot” (page 41).

2 Select a stitch.

- For details, refer to steps 4 through 9 of “Selecting stitching” (page 66).

3 Start sewing.

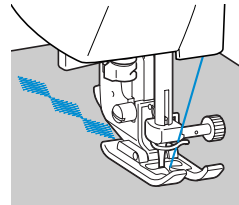

- The stitching is sewn in the direction indicated by the arrow.

4 Sew reinforcement stitches.

- When sewing a pattern, it is useful to first set the automatic reverse/reinforcement stitching setting. For details, refer to “Automatically sewing reverse/reinforcement stitches” (page 59).

5 When you are finished sewing, use scissors to trim off any excess threads at the beginning of the stitching and between the patterns.

Combining patterns

Multiple patterns can be combined and sewn together.

1 Select the first pattern, and then press (OK key).

- ▶ The first pattern is selected and appears in the LCD.



- When the sewing is started, the selected pattern is sewn repeatedly until the sewing machine is stopped.

2 Press the (+) key in the operation panel.

- ▶ The screen for selecting a pattern appears again.

3 Select the next pattern, and then press (OK key).

To select a different stitch type, press (stitch selection key).

- ▶ The combined patterns appear in the LCD.



- To remove a selected pattern, press the (C) key in the operation panel. The pattern that was selected last is removed.

4 Repeat steps 2 and 3.

5 After all of the desired patterns are selected, start sewing.



① Sewing direction

- ▶ The order that the patterns appear in the LCD is the order that they will be sewn.









Memo





- Up to 70 patterns can be combined.
- Some utility stitches cannot be combined.
- If multiple patterns have been combined, the sewing machine stops once all the selected patterns displayed in the LCD have been sewn. To repeatedly sew the combined pattern, refer to "Repeat sewing patterns".
- The combined pattern can be stored for later use. For details, refer to "Storing a pattern" (page 113).

Repeat sewing patterns

To repeatedly sew the combined pattern, follow the procedure described below.

- 1 **Select the pattern.**
 - For details, refer to “Combining patterns” (on the previous page).
- 2 **Press  (settings key) in the operation panel.**
 - ▶ The settings screen appears.
- 3 **Press , ,  and  (arrow keys) until  is selected.**



- 4 **Press  (OK key).**
 - ▶ The screen for specifying repeat sewing appears.
- 5 **Press  to select  (repeat sewing).**
 - To return to  (single sewing), press .

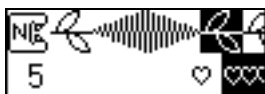

- 6 **Press  (OK key).**
 - ▶ The initial stitch screen appears again, and the machine is set to repeatedly sew the selected pattern.

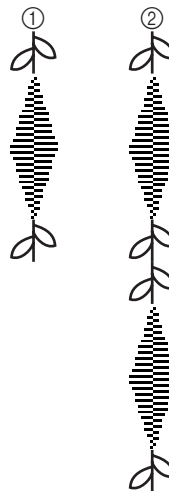

- ① Single
- ② Repeated





Note

- If repeated sewing is set, the pattern is repeatedly sewn until the sewing machine is stopped.
- If the sewing machine is turned off, the repeated/single sewing setting returns to its default setting.

Checking the selected pattern

Up to 70 patterns can be combined. If all of the selected patterns cannot be displayed in the LCD at the same time, the pattern can be checked according to the following procedure.

- 1 Press  (settings key) in the operation panel.
 - ▶ The settings screen appears.

- 2 Press , ,  and  (arrow keys) until  is selected.



- 3 Press  (OK key).
 - ▶ The screen for checking the pattern appears.







- 4 Press  and  to scroll through the pattern and check it.





- 5 Press  (OK key).
 - ▶ The initial stitch screen appears again.

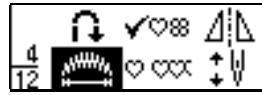

Changing the pattern length

The length of one part of a satin stitch can be set to one of five sizes.

- 1 Select a satin stitch .
- 2 Press  (settings key) in the operation panel.
 - ▶ The settings screen appears.
- 3 Press , ,  and  (arrow keys) until  is selected.



- 4 Press  (OK key).
 - ▶ The screen for changing the length of a satin stitch appears.

- 5 Press  and  until the desired ratio is selected. The length can be set within the range of $\times 1$ and $\times 5$.







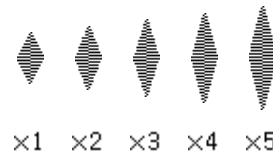

- ▶ The satin stitch length is changed.

- 6 Press  (OK key).
 - ▶ The initial stitch screen appears again.





Mirror imaging the pattern

The pattern can be mirror imaged along a vertical axis.

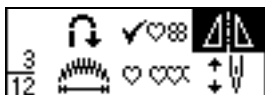
- 1 Select a stitch.
- 2 Press  (settings key) in the operation panel.
▶ The settings screen appears.
- 3 Press , ,  and  (arrow keys) until  is selected.



- 4 Press  (OK key).
▶ The screen for mirror imaging the pattern appears.
- 5 Press  to select **ON**.
To return to **OFF**, press .



▶ The pattern is mirror imaged.



- 6 Press  (OK key).
▶ The initial stitch screen appears again.

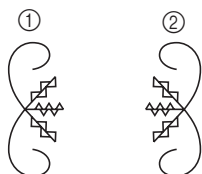

- ① Normal
- ② Mirror-imaged

Memo

- Some of the utility and decorative patterns can be mirror imaged.
- Mirror imaged patterns can also be combined with other patterns.



Storing a pattern

Combined patterns can be stored for later use. Since stored patterns are not lost after the sewing machine is turned off, they can be recalled at any time. This is convenient for patterns, such as names, that will be used often. Up to five patterns can be stored.

■ Storing a pattern

① Create the combined pattern that you wish to store.

- For details, refer to "Combining patterns" (page 109).



② Press (stitch selection key) in the operation panel.

- The screen containing the various types of stitches appears.



③ Press , , and (arrow keys) until is selected.



④ Press (OK key).

- The screen for selecting the storage location (pocket) appears.

⑤ Press and until the pocket (1 through 5) where you wish to store the pattern is selected.

 indicates an empty pocket.  indicates a pocket where a pattern is already stored.



⑥ Press (OK key).

- The contents of the selected pocket are displayed.

⑦ Check the contents, and then press (OK key).

The contents stored in the  pocket are overwritten.

- "Saving..." appears while the pattern is being stored in the pocket.
- Do not turn off the sewing machine while a pattern is being stored, otherwise the pattern data may be lost.
- After the pattern is stored, the initial stitch screen appears again.

■ Recalling a pattern

① Press (stitch selection key) in the operation panel.

- The screen containing the various types of stitches appears.

② Press , , and (arrow keys) until is selected.



③ Press (OK key).

- The screen for selecting a pocket appears.

④ Press and until the pocket containing the pattern that you wish to recall is selected.

A pattern is stored in the  pocket.



5 Press  (OK key).

- ▶ The contents of the selected pocket are displayed.

6 Check the contents, and then press  (OK key).

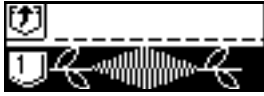

To select a different pocket, press  (back key).

- ▶ The initial stitch screen appears again, and the pattern from the selected pocket is recalled.

Realigning the pattern

The pattern may not be sewn correctly, depending on the type of fabric being sewn or the sewing speed. If this occurs, adjust the pattern while sewing on a piece of scrap fabric that is the same as that used for your project.



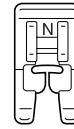



1 Attach monogramming foot “N”.



- For details, refer to “Replacing the presser foot” (page 41).

2 Press  (stitch selection key) in the operation panel.

- ▶ The screen containing the various types of stitches appears.

3 Press , ,  and  (arrow keys) until  is selected, and then select .



- ▶ The pattern alignment stitch is selected.

4 Start sewing.



- ▶ The pattern for making the adjustment is sewn.
- ▶ The sewing machine stops after it has finished sewing the pattern.

5 Check the sewn pattern.

If the part of the pattern indicated in the illustration is sewn uniformly, the pattern is correctly aligned.

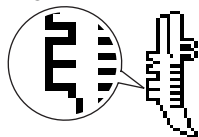

If the pattern is not sewn correctly, following the steps below to adjust the sewing.

6 Press (settings key) in the operation panel.

▶ The settings screen appears.

7 Press , , and (arrow keys) until is selected.



8 Press (OK key).

▶ The screen for adjusting the pattern appears.

9 Press (-) or (+).



▶ Make the necessary adjustments according to how the pattern is sewn.

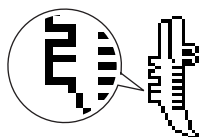

Press  to increase the adjustment setting.

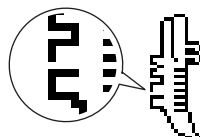

Press  to decrease the adjustment setting.

10 Start sewing again, and then check the pattern.

Continue adjusting the pattern until it is sewn correctly.

11 When the pattern is sewn correctly, press (OK key).

▶ The initial stitch screen appears again.

CONTENTS

GETTING READY

SEWING BASICS

UTILITY STITCHES

APPENDIX

INDEX

4

APPENDIX















The various maintenance and troubleshooting procedures are described in this chapter.













Stitch Settings	118
Maintenance	124
Troubleshooting	126
Index	133

Stitch Settings





















Applications, stitch lengths and widths and whether the twin needle can be used are listed for utility stitches in the following table.





Utility stitches

Stitch Name	Pattern	Presser Foot	Application	Stitch Width [mm (inch.)]		Stitch Length [mm (inch.)]		Twin Needle	Reverse/Reinforcement Stitching	Walking Foot
				Auto	Manual	Auto	Manual			
Straight stitch	Left 	J	Basic stitching, sewing gathers or pintucks, etc.	0.0 (0)	0.0–7.0 (0–1/4)	2.5 (3/32)	0.2–5.0 (1/64–3/16)	Yes	Reverse	No
		J	Basic stitching and sewing gathers or pintucks	0.0 (0)	0.0–7.0 (0–1/4)	2.5 (3/32)	0.2–5.0 (1/64–3/16)	Yes	Reinforcement	Yes
	Center 	J/I	Attaching zippers, basic stitching, sewing gathers or pintucks, etc.	–	–	2.5 (3/32)	0.2–5.0 (1/64–3/16)	Yes	Reverse	No
Triple stretch stitch		J	Attaching sleeves, sewing inseams, sewing stretch fabrics and decorative stitching	0.0 (0)	0.0–7.0 (0–1/4)	2.5 (3/32)	1.5–4.0 (1/16–3/16)	Yes	Reinforcement	No
Stretch stitch		J	Sewing stretch fabrics and decorative stitching	1.0 (1/16)	1.0–3.0 (1/16–1/8)	2.5 (3/32)	1.0–4.0 (1/16–3/16)	Yes	Reinforcement	No
Basting stitch		J	Temporarily securing	0.0 (0)	0.0–7.0 (0–1/4)	–	–	No	Reinforcement	No
Zigzag stitch	Center 	J	Overcasting and attaching appliqués	3.5 (1/8)	0.0–7.0 (0–1/4)	1.4 (1/16)	0.0–4.0 (0–3/16)	Yes	Reverse	No
	Right 	J	Beginning sewing from the right needle position	3.5 (1/8)	2.5–5.0 (3/32–3/16)	1.4 (1/16)	0.3–4.0 (1/64–3/16)	Yes	Reinforcement	Yes
2-point zigzag stitch		J	Overcasting on mediumweight or stretch fabrics, attaching elastic, darning, etc.	5.0 (3/16)	1.5–7.0 (1/16–1/4)	1.0 (1/16)	0.2–4.0 (1/64–3/16)	Yes	Reinforcement	Yes
3-point zigzag stitch		J	Overcasting on mediumweight or stretch fabrics, attaching elastic, darning, etc.	5.0 (3/16)	1.5–7.0 (1/16–1/4)	1.0 (1/16)	0.2–4.0 (1/64–3/16)	Yes	Reinforcement	No
Overcasting stitch		G	Overcasting on thin or mediumweight fabrics	3.5 (1/8)	2.5–5.0 (3/32–3/16)	2.0 (1/16)	1.0–4.0 (1/16–3/16)	No	Reinforcement	No
		G	Overcasting on thick fabrics	5.0 (3/16)	2.5–5.0 (3/32–3/16)	2.5 (3/32)	1.0–4.0 (1/16–3/16)	No	Reinforcement	No
		G	Overcasting on thick fabrics and decorative stitching	5.0 (3/16)	3.5–5.0 (1/8–3/16)	2.5 (3/32)	1.0–4.0 (1/16–3/16)	No	Reinforcement	No
		J	Overcasting on stretch fabrics	5.0 (3/16)	0.0–7.0 (0–1/4)	2.5 (3/32)	0.5–4.0 (1/32–3/16)	Yes	Reinforcement	No
		J	Overcasting on thick or stretch fabrics	5.0 (3/16)	0.0–7.0 (0–1/4)	2.5 (3/32)	0.5–4.0 (1/32–3/16)	Yes	Reinforcement	No
		J	Overcasting on stretch fabrics and decorative stitching	4.0 (3/16)	0.0–7.0 (0–1/4)	4.0 (3/16)	1.0–4.0 (1/16–3/16)	Yes	Reinforcement	No

Stitch Name	Pattern	Presser Foot	Application	Stitch Width [mm (inch.)]		Stitch Length [mm (inch.)]		Twin Needle	Reverse/Reinforcement Stitching	Walking Foot
				Auto	Manual	Auto	Manual			
Blind hem stitch	17 	R	Blind hem stitching on mediumweight fabrics	0.0 (0)	3← - 3→	2.0 (1/16)	1.0-3.5 (1/16-1/8)	No	Reinforcement	No
	18 	R	Blind hem stitching on stretch fabrics	0.0 (0)	3← - 3→	2.0 (1/16)	1.0-3.5 (1/16-1/8)	No	Reinforcement	No
Appliqué stitch	19 	J	Appliqué stitching	3.5 (1/8)	2.5-5.0 (3/32-3/16)	2.5 (3/32)	1.6-4.0 (1/16-3/16)	Yes	Reinforcement	No
Shell tuck stitch	20 	J	Shell tuck stitching	4.0 (3/16)	0.0-7.0 (0-1/4)	2.5 (3/32)	0.2-4.0 (1/64-3/16)	Yes	Reinforcement	No
Satin scallop stitch	21 	N	Scallop stitching	5.0 (3/16)	2.5-7.0 (3/32-1/4)	0.5 (1/32)	0.1-1.0 (1/64-1/16)	Yes	Reinforcement	No
Joining stitch	22 	J	Patchwork stitching and decorative stitching	4.0 (3/16)	0.0-7.0 (0-1/4)	1.2 (1/16)	0.2-4.0 (1/64-3/16)	Yes	Reinforcement	No
	23 	J	Patchwork stitching, decorative stitching and sewing overcasting on both pieces of fabric, such as with tricot	5.0 (3/16)	2.5-7.0 (3/32-1/4)	2.5 (3/32)	1.0-4.0 (1/16-3/16)	Yes	Reinforcement	No
	24 	J	Patchwork stitching and decorative stitching	5.0 (3/16)	0.0-7.0 (0-1/4)	1.2 (1/16)	0.2-4.0 (1/64-3/16)	Yes	Reinforcement	No
Smocking stitch	25 	J	Smocking stitching and decorative stitching	5.0 (3/16)	0.0-7.0 (0-1/4)	1.6 (1/16)	1.0-4.0 (1/16-3/16)	Yes	Reinforcement	No
Fagoting stitch	26 	J	Fagoting and decorative stitching	5.0 (3/16)	0.0-7.0 (0-1/4)	2.5 (3/32)	1.0-4.0 (1/16-3/16)	Yes	Reinforcement	No
	27 	J	Fagoting and decorative stitching	5.0 (3/16)	2.5-7.0 (3/32-1/4)	2.5 (3/32)	1.0-4.0 (1/16-3/16)	Yes	Reinforcement	No
Elastic-attaching stitch	28 	J	Attaching elastic to stretch fabrics	4.0 (3/16)	0.0-7.0 (0-1/4)	1.0 (1/16)	0.2-4.0 (1/64-3/16)	Yes	Reinforcement	No

Stitch Name	Pattern	Presser Foot	Application	Stitch Width [mm (inch.)]		Stitch Length [mm (inch.)]		Twin Needle	Reverse/ Reinforcement Stitching	Walking Foot
				Auto	Manual	Auto	Manual			
Decorative stitch	29	J	Decorative stitching	4.0 (3/16)	0.0–7.0 (0–1/4)	3.0 (1/8)	2.0–4.0 (1/16–3/16)	No	Reinforce- ment	No
	30	J	Decorative stitching	4.0 (3/16)	0.0–7.0 (0–1/4)	2.5 (3/32)	1.0–4.0 (1/16–3/16)	Yes	Reinforce- ment	No
	31	J	Decorative stitching	5.5 (7/32)	0.0–7.0 (0–1/4)	1.6 (1/16)	1.0–4.0 (1/16–3/16)	Yes	Reinforce- ment	No
	32	N	Decorative stitching and elastic-attaching	5.0 (3/16)	1.5–7.0 (1/16–1/4)	1.0 (1/16)	0.2–4.0 (1/64–3/16)	Yes	Reinforce- ment	No
	33	N	Lace sewing, decora- tive hemming, heir- loom stitching, etc.	3.5 (1/8)	1.5–7.0 (1/16–1/4)	2.5 (3/32)	1.6–4.0 (1/16–3/16)	No	Reinforce- ment	No
	34	N	Decorative hemming, heirloom stitching, etc.	6.0 (15/64)	1.5–7.0 (1/16–1/4)	3.0 (1/8)	1.5–4.0 (1/16–3/16)	No	Reinforce- ment	No
	35	N	Decorative hemming on thin, mediumweight and plain weave fab- rics, heirloom stitch- ing, etc.	5.0 (3/16)	1.5–7.0 (1/16–1/4)	3.5 (1/8)	1.5–4.0 (1/16–3/16)	No	Reinforce- ment	No
	36	N	Decorative hemming on thin, mediumweight and plain weave fab- rics, heirloom stitch- ing, etc.	5.0 (3/16)	1.5–7.0 (1/16–1/4)	4.0 (3/16)	1.5–4.0 (1/16–3/16)	Yes	Reinforce- ment	No
	37	N	Decorative hemming on thin, mediumweight and plain weave fab- rics, heirloom stitch- ing, etc.	5.0 (3/16)	1.5–7.0 (1/16–1/4)	2.5 (3/32)	1.5–4.0 (1/16–3/16)	Yes	Reinforce- ment	No
	38	N	Decorative hemming on thin, mediumweight and plain weave fab- rics, heirloom stitch- ing, etc.	5.0 (3/16)	1.5–7.0 (1/16–1/4)	2.0 (1/16)	1.5–4.0 (1/16–3/16)	Yes	Reinforce- ment	No
	39	N	Decorative hemming, ribbon threading, heir- loom stitching, etc.	5.0 (3/16)	1.5–7.0 (1/16–1/4)	3.0 (1/8)	1.5–4.0 (1/16–3/16)	Yes	Reinforce- ment	No
	40	N	Decorative stitching, smocking stitching, heirloom stitching, etc.	6.0 (15/64)	1.5–7.0 (1/16–1/4)	1.6 (1/16)	1.0–4.0 (1/16–3/16)	No	Reinforce- ment	No
	41	N	Decorative stitching, smocking stitching, heirloom stitching, etc.	5.0 (3/16)	1.5–7.0 (1/16–1/4)	1.6 (1/16)	1.0–4.0 (1/16–3/16)	No	Reinforce- ment	No

Stitch Name	Pattern	Presser Foot	Application	Stitch Width [mm (inch.)]		Stitch Length [mm (inch.)]		Twin Needle	Reverse/Reinforcement Stitching	Walking Foot
				Auto	Manual	Auto	Manual			
Buttonhole stitch	42 	A	Horizontal buttonholes on thin and mediumweight fabrics	5.0 (3/16)	3.0–5.0 (1/8–3/16)	0.4 (1/64)	0.2–1.0 (1/64–1/16)	No	Automatic reinforcement	No
	43 	A	Horizontal buttonholes on areas that are subject to strain	5.0 (3/16)	3.0–5.0 (1/8–3/16)	0.4 (1/64)	0.2–1.0 (1/64–1/16)	No	Automatic reinforcement	No
	44 	A	Horizontal buttonholes on thick fabrics	5.0 (3/16)	3.0–5.0 (1/8–3/16)	0.4 (1/64)	0.2–1.0 (1/64–1/16)	No	Automatic reinforcement	No
	45 	A	Secured buttonholes for fabrics that have backings	5.0 (3/16)	3.0–5.0 (1/8–3/16)	0.4 (1/64)	0.2–1.0 (1/64–1/16)	No	Automatic reinforcement	No
	46 	A	Buttonholes for stretch or knit fabrics	6.0 (15/54)	3.0–6.0 (1/8–15/64)	1.0 (1/16)	0.5–2.0 (1/32–1/16)	No	Automatic reinforcement	No
	47 	A	Buttonholes for stretch fabrics	6.0 (15/54)	3.0–6.0 (1/8–15/64)	1.5 (1/16)	1.0–3.0 (1/16–1/8)	No	Automatic reinforcement	No
	48 	A	Bound buttonholes	5.0 (3/16)	0.0–6.0 (0–15/64)	2.0 (1/16)	0.2–4.0 (1/64–3/16)	No	Automatic reinforcement	No
	49 	A	Keyhole buttonholes for thick or furry fabrics	7.0 (1/4)	3.0–7.0 (1/8–1/4)	0.5 (1/32)	0.3–1.0 (1/64–1/16)	No	Automatic reinforcement	No
	50 	A	Keyhole buttonholes for mediumweight and thick fabrics	7.0 (1/4)	3.0–7.0 (1/8–1/4)	0.5 (1/32)	0.3–1.0 (1/64–1/16)	No	Automatic reinforcement	No
	51 	A	Horizontal buttonholes for thick or furry fabrics	7.0 (1/4)	3.0–7.0 (1/8–1/4)	0.5 (1/32)	0.3–1.0 (1/64–1/16)	No	Automatic reinforcement	No
Darning stitch	52 	A	Darning mediumweight fabrics	7.0 (1/4)	2.5–7.0 (3/32–1/4)	2.0 (1/16)	0.4–2.5 (1/64–3/32)	No	Automatic reinforcement	No
	53 	A	Darning thick fabrics	7.0 (1/4)	2.5–7.0 (3/32–1/4)	2.0 (1/16)	0.4–2.5 (1/64–3/32)	No	Automatic reinforcement	No
Bar tack stitch	54 	A	Reinforcing openings and areas where the seam easily comes loose	2.0 (1/16)	1.0–3.0 (1/16–1/8)	0.4 (1/64)	0.3–1.0 (1/64–1/16)	No	Automatic reinforcement	No
Button-sewing stitch	55 	M	Button sewing	3.5 (1/8)	2.5–4.5 (3/32–3/16)	–	–	No	Reinforcement	No
Eyelet stitch	56 	N	Sewing eyelets, for example, on belts	7.0 (1/4)	7.0, 6.0, 5.0 (1/4, 15/64, 3/16)	7.0 (1/4)	7.0, 6.0, 5.0 (1/4, 15/64, 3/16)	No	Automatic reinforcement	No
Piecing straight stitch	57 	J	Piecing straight stitching (with a seam allowance of 6.5 mm from the right edge of the presser foot)	5.5 (7/32)	0.0–7.0 (0–1/4)	1.6 (1/16)	0.2–5.0 (1/64–3/16)	No	Reinforcement	No
	58 	J	Piecing straight stitching (with a seam allowance of 6.5 mm from the left edge of the presser foot)	1.5 (1/16)	0.0–7.0 (0–1/4)	1.6 (1/16)	0.2–5.0 (1/64–3/16)	No	Reinforcement	Yes
Straight stitch that looks hand-sewn (for quilting)	59 	J	Straight stitch quilting that looks hand-sewn	0.0 (0)	0.0–7.0 (0–1/4)	2.5 (3/32)	1.0–4.0 (1/16–3/16)	No	Reinforcement	No
Zigzag stitch (for quilting)	60 	J	Appliqué quilting, free-motion quilting, satin stitching	3.5 (1/8)	0.0–7.0 (0–1/4)	1.4 (1/16)	0.0–4.0 (0–3/16)	No	Reinforcement	Yes
Appliqué stitch (for quilting)	61 	J	Attaching appliqués and binding	1.5 (1/16)	0.5–5.0 (1/32–3/16)	1.2 (1/16)	1.0–4.0 (1/16–3/16)	No	Reinforcement	No
Quilting stitch (for stippling)	62 	J	Quilting background stitching (stippling)	7.0 (1/4)	1.0–7.0 (1/16–1/4)	1.6 (1/16)	1.0–4.0 (1/16–3/16)	No	Reinforcement	No

Stitch Name	Pattern	Presser Foot	Application	Stitch Width [mm (inch.)]		Stitch Length [mm (inch.)]		Twin Needle	Reverse/Reinforcement Stitching	Walking Foot
				Auto	Manual	Auto	Manual			
Side cutter	63 	S	Sewing straight stitches while cutting the fabric	0.0 (0)	0.0–2.5 (0–3/32)	2.5 (3/32)	0.2–5.0 (1/64–3/16)	No	Reinforcement	No
	64 	S	Sewing zigzag stitches while cutting the fabric	3.5 (1/8)	3.5–5.0 (1/8–3/16)	1.4 (1/16)	0.0–4.0 (0–3/16)	No	Reinforcement	No
	65 	S	Overcasting on thin and mediumweight fabrics while cutting the fabric	3.5 (1/8)	3.5–5.0 (1/8–3/16)	2.0 (1/16)	1.0–4.0 (1/16–3/16)	No	Reinforcement	No
	66 	S	Overcasting on thick fabrics while cutting the fabric	5.0 (3/16)	3.5–5.0 (1/8–3/16)	2.5 (3/32)	1.0–4.0 (1/16–3/16)	No	Reinforcement	No
	67 	S	Overcasting on mediumweight and thick fabrics while cutting the fabric	5.0 (3/16)	3.5–5.0 (1/8–3/16)	2.5 (3/32)	1.0–4.0 (1/16–3/16)	No	Reinforcement	No

Other stitches

Stitch Type	Pattern										Presser Foot	Twin Needle	Adjustable Pattern Length/width	Left/Right Flipping
Decorative stitches	1	2	3	4	5	6	7	8	9	10	N	No	Yes	Yes
	11	12	13	14	15	16	17	18	19	20				
	21	22	23	24	25	26	27	28	29	30				
	31 *													
Satin stitches	1	2	3	4	5	6	7	8	9	10	N	Yes	Yes	Yes
	11	12	13	14	15	16								
Cross-stitches	1	2	3	4	5						N	No	Yes	Yes

*Pattern for making adjustment

Maintenance

Simple sewing machine maintenance operations are described below.

Cleaning the machine surface

If the surface of the machine is dirty, lightly soak a cloth in neutral detergent, squeeze it out firmly, and then wipe the surface of the machine. After cleaning it once with a wet cloth, wipe it again with a dry cloth.

CAUTION

- Unplug the power supply cord before cleaning the machine, otherwise injuries or an electric shock may occur.

Cleaning the shuttle

Sewing performance will suffer if dust collects in the shuttle; therefore, it should be cleaned periodically.

- 1 Turn off the sewing machine.

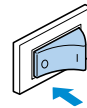

CAUTION

- Unplug the power supply cord before cleaning the machine, otherwise injuries or an electric shock may occur.

- 2 Grasp both sides of the needle plate cover, and then slide it toward you.

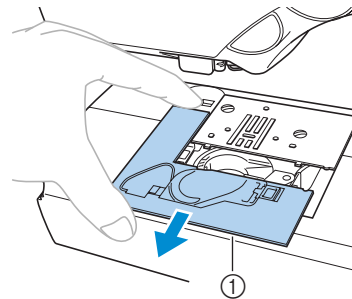

- ① Needle plate cover
- ▶ The needle plate cover is removed.

- 3** Turn the balance wheel toward you until the tip of the shuttle hook aligns with the edge of the race shelf.

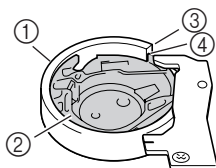

- ① Shuttle race
- ② Shuttle
- ③ Edge of the shuttle hook
- ④ Tip of the shuttle hook

- Be sure to turn the balance wheel toward you. Turning the balance wheel away from you may damage the machine.

- 4** Remove the shuttle. Grasp the shuttle, and then pull it out.

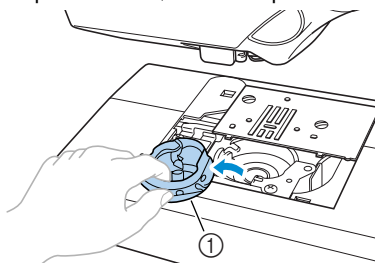

- ① Shuttle

- 5** Use the cleaning brush or a vacuum cleaner to remove any lint and dust from the race and its surrounding area.

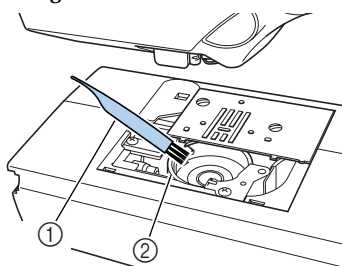

- ① Cleaning brush
- ② Shuttle race

- Do not apply oil to the shuttle.

- 6** Check that the edge of the race shelf is positioned as in step 3, and then insert the shuttle so that the projection on the shuttle aligns with the spring.

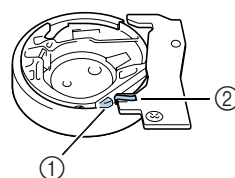
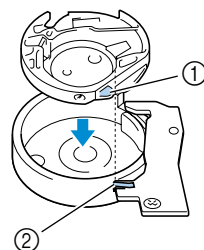

- ① Projection
- ② Spring

- 7** Insert the tabs on the needle plate cover into the needle plate, and then slide the cover back on.

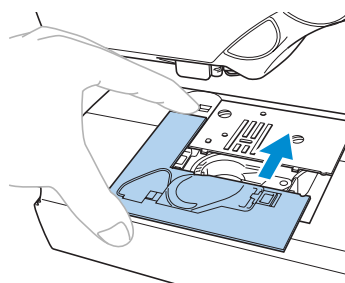

! CAUTION

- Never use a shuttle that is scratched, otherwise the upper thread may become tangled, the needle may break or sewing performance may suffer. For a new shuttle (part code: XC3153-051), contact your nearest authorized service center.
- Be sure that the shuttle is correctly installed, otherwise the needle may break.

Troubleshooting

If the machine stops operating correctly, check the following possible problems before requesting service. If the problem persists, contact your retailer or the nearest authorized service center.

Symptom	Probable Cause	Remedy	Reference
The sewing machine does not operate.	The machine is not turned on.	Turn on the machine.	page 11
	The start/stop button was not pressed.	Press the start/stop button.	page 51
	The presser foot lever is raised.	Lower the presser foot lever.	page 50
	The start/stop button was pressed, even though the foot controller is connected.	Do not use the start/stop button when the foot controller is connected. To use the start/stop button, disconnect the foot controller.	page 51
The needle breaks.	The needle is incorrectly installed.	Correctly install the needle.	page 38
	The needle clamp screw is loose.	Use the screwdriver to firmly tighten the screw.	
	The needle is bent or blunt.	Replace the needle.	
	The combination of fabric, thread and needle is not correct.	Select a thread and needle that are appropriate for the type of fabric being sewn.	page 36
	The presser foot that is used is not appropriate for the type of stitch that you wish to sew.	Attach the presser foot that is appropriate for the type of stitch that you wish to sew.	page 118
	The upper thread tension is too tight.	Loosen the upper thread tension.	page 56
	The fabric is pulled too much.	Lightly guide the fabric.	–
	The spool is incorrectly installed.	Correctly install the spool.	page 24
	The area around the hole in the needle plate is scratched, or has a burr on it.	Replace the needle plate. Contact your retailer or the nearest authorized service center.	–
	The area around the hole in the presser foot is scratched, or has a burr on it.	Replace the presser foot. Contact your retailer or the nearest authorized service center.	–
	The shuttle is scratched, or has a burr on it.	Replace the shuttle. Contact your retailer or the nearest authorized service center.	–
A bobbin designed specifically for this machine is not used.	Incorrect bobbins will not work properly. Only use a bobbin designed specifically for this machine.	page 18	



Symptom	Probable Cause	Remedy	Reference
The upper thread breaks.	The upper thread was not threaded correctly (for example, the spool is not installed correctly, the spool cap is too big for the spool being used, or the thread has come out of the needle-bar thread hook).	Correct the upper threading.	page 24
	There are knots or tangles in the thread.	Remove any knots or tangles.	–
	The selected needle is not appropriate for the thread being used.	Select a needle that is appropriate for the type of stitch being used.	page 36
	The upper thread tension is too tight.	Loosen the upper thread tension.	page 56
	The thread is tangled, for example, in the shuttle.	Remove the tangle thread. If the thread is tangled in the shuttle, clean the shuttle.	page 124
	The needle is bent or blunt.	Replace the needle.	page 38
	The needle is incorrectly installed.	Correctly install the needle.	
	The area around the hole in the needle plate is scratched, or has a burr on it.	Replace the needle plate. Contact your retailer or the nearest authorized service center.	–
	The area around the hole in the presser foot is scratched, or has a burr on it.	Replace the presser foot. Contact your retailer or the nearest authorized service center.	–
	The shuttle is scratched, or has a burr on it.	Replace the shuttle. Contact your retailer or the nearest authorized service center.	–
	A bobbin designed specifically for this machine is not used.	Incorrect bobbins will not work properly. Only use a bobbin designed specifically for this machine.	page 18
The lower thread is tangled or breaks.	The bobbin thread is incorrectly installed.	Correctly install the bobbin thread.	page 22
	The bobbin is scratched or does not rotate smoothly, or has a burr on it.	Replace the bobbin.	–
	The thread is tangled.	Remove the tangled thread and clean the shuttle.	page 124
	A bobbin designed specifically for this machine is not used.	Incorrect bobbins will not work properly. Only use a bobbin designed specifically for this machine.	page 18
The thread tension is incorrect.	The upper thread was not threaded correctly.	Correct the upper threading.	page 24
	The bobbin thread is incorrectly installed.	Correctly install the bobbin thread.	page 22
	The combination of fabric, thread and needle is not correct.	Select a thread and needle that are appropriate for the type of fabric being sewn.	page 36
	The presser foot holder is incorrectly installed.	Correctly install the presser foot holder.	page 41
	The thread tension is incorrect.	Adjust the tension of the upper thread.	page 56
	A bobbin designed specifically for this machine is not used.	Incorrect bobbins will not work properly. Only use a bobbin designed specifically for this machine.	page 18



















Symptom	Probable Cause	Remedy	Reference
The fabric is wrinkled.	The upper thread was not threaded correctly, or the bobbin is incorrectly installed.	Correctly thread the upper thread and correctly install the bobbin thread.	page 22, 24
	The spool is incorrectly installed.	Correctly install the spool.	page 24
	The combination of fabric, thread and needle is not correct.	Select a thread and needle that are appropriate for the type of fabric being sewn.	page 36
	The needle is bent or blunt.	Replace the needle.	page 38
	If thin fabrics are being sewn, the stitch is too coarse.	Shorten the stitch length or sew with stabilizer material under the fabric.	page 58
	The thread tension is incorrect.	Adjust the tension of the upper thread.	page 56
Stitches are skipped.	The upper thread was not threaded correctly.	Correct the upper threading.	page 24
	The combination of fabric, thread and needle is not correct.	Select a thread and needle that are appropriate for the type of fabric being sewn.	page 36
	The needle is bent or blunt.	Replace the needle.	page 38
	The needle is incorrectly installed.	Correctly install the needle.	page 38
	Dust has accumulated under the needle plate or in the shuttle.	Remove the needle plate cover and clean the shuttle.	page 124
A high-pitched noise is made while sewing.	Dust has accumulated in the feed dogs or in the shuttle.	Clean the shuttle.	page 124
	The upper thread was not threaded correctly.	Correct the upper threading.	page 24
	The shuttle is scratched, or has a burr on it.	Replace the shuttle. Contact your retailer or the nearest authorized service center.	–
	A bobbin designed specifically for this machine is not used.	Incorrect bobbins will not work properly. Only use a bobbin designed specifically for this machine.	page 18
The thread does not pass through the eye of the needle.	The needle was not raised. The thread cassette indicator is lit in red.	Press the needle position button. The thread cassette indicator lights up in green.	page 28
	The needle is incorrectly installed.	Correctly install the needle.	page 38
The stitch is not sewn correctly.	The presser foot that is used is not appropriate for the type of stitch that you wish to sew.	Attach the presser foot that is appropriate for the type of stitch that you wish to sew.	page 118
	The thread tension is incorrect.	Adjust the tension of the upper thread.	page 56
	The thread is tangled, for example, in the shuttle.	Remove the tangle thread. If the thread is tangled in the shuttle, clean the shuttle.	page 124

Symptom	Probable Cause	Remedy	Reference
The fabric does not feed.	The feed dogs are lowered.	Slide the drop feed lever to the left.	page 92
	The stitch is too fine.	Lengthen the stitch length.	page 58
	The presser foot that is used is not appropriate for the type of stitch that you wish to sew.	Attach the presser foot that is appropriate for the type of stitch that you wish to sew.	page 118
	The thread is tangled, for example, in the shuttle.	Remove the tangle thread. If the thread is tangled in the shuttle, clean the shuttle.	page 124
The sewing lamp does not come on.	The sewing lamp is damaged.	Contact your retailer or the nearest authorized service center.	–
Nothing appears in the LCD.	The brightness of the LCD is either too light or too dark.	Adjust the brightness of the LCD.	page 131

Error messages

If the start/stop button is pressed before the sewing machine is correctly set up or if an operation is performed incorrectly, an error message appears in the LCD. Follow the instructions that appear.

If you press  (OK key),  (back key) or do the operation correctly while the error message is displayed, the message disappears.



Error Message	Probable Cause
 The safety device has been activated.	The motor locked up because the thread is tangled.
 Lower presser foot lever.	The start/stop button, reverse/reinforcement stitch button or thread cutter button was pressed while the presser foot was raised.
 Return bobbin winding shaft to left.	The reverse/reinforcement stitch button, needle position button or thread cutter button was pressed while the bobbin winder shaft is moved to the right.
 Disconnect foot control.	The start/stop button was pressed while the foot controller was connected.
 Lift buttonhole lever.	A stitch other than the buttonhole, bar tack or darning stitch was selected and the start/stop button was pressed while the buttonhole lever is lowered.
 Lower buttonhole lever.	The buttonhole, bar tack or darning stitch was selected and the start/stop button was pressed while the buttonhole lever is raised.
 Select pattern.	The start/stop button or reverse/reinforcement stitch button was pressed after a stitch has been deleted.
Saving...	A pattern is being stored.
Winding bobbin thread.	The bobbin winder is winding the bobbin.
 No more stitches can be combined.	More than 71 patterns are being combined.
 Change speed controller mode to "OFF".	The start/stop button was pressed without connecting the foot controller while the setting for adjusting the stitch width using the sewing speed controller is set to [ON].
 Change to single needle mode.  → 	The twin needle setting is selected while a pattern that cannot be sewn with the twin needle is selected.
 Delete the selected pattern.  Cancel  Delete	The first pattern was selected while two or more patterns are combined.
 Can not change.	The selected setting cannot be changed with the selected pattern.
 Insert thread cassette.	The start/stop button, reverse/reinforcement stitch button or the thread cutter button was pressed while no thread cassette was installed.
 Press needle position button to raise needle.	You tried to start sewing while the needle is lowered.

Nothing appears in the LCD

If nothing appears in the LCD when the sewing machine is turned on, the brightness of the LCD is either too light or too dark. If this is the case, perform the following operation.

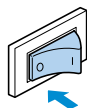
- 1 Turn off the sewing machine.



- 2 While pressing  (back key) in the operation panel, turn on the sewing machine.
- 3 Press  (-) or  (+).
Adjust the brightness of the LCD so that the screens can be seen.
- 4 Turn off the sewing machine, then turn it on again.

Operation beep

Each time a key is pressed or an incorrect operation is performed, a beep is sounded.

- **For a correct operation**
One beep is sounded.
- **If an incorrect operation is performed**
Two or four beeps are sounded.
- **If the machine locks up, for example, because the thread is tangled**
The sewing machine continues to beep for four seconds. The machine automatically stops. Be sure to check for the cause of the error, and correct it before continuing to sew.

Cancelling the operation beep

When the sewing machine is purchased, it is set to beep each time an operation panel key is pressed. This setting can be changed so that the machine does not beep.

- 1 Turn on the sewing machine.

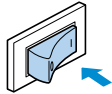

▶ The LCD comes on.

- 2 Press  (settings key) in the operation panel.

▶ The settings screen appears.

- 3 Press , ,  and  (arrow keys) until  is selected.



- 4 Press  (OK key).

▶ The screen for changing the beep setting appears.

- 5 Press  to select OFF.

To return to ON, press .

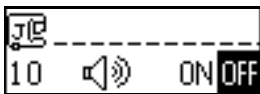

▶ The machine is now set so that it will not beep.

- 6 Press  (OK key).

▶ The initial stitch screen appears again.

Index

Symbols

+ key Cover E

Numerics

2-point zigzag stitch 69
3-point zigzag stitch 69

A

accessories Cover A
air vent Cover C
appliques 89
arrow keys Cover E
automatic reinforcement stitching 59
automatic reverse stitching 59

B

back key Cover E
balance wheel Cover C, 50
bar tack 95
baseline 73
basic stitching 72
blind hem stitch 74
bobbin Cover A, 22
bobbin cover Cover C, 22
bobbin thread 22
 pulling up 35
bobbin winder Cover B, 19
bobbin winder seat 20
bobbin winder shaft spring 18
bobbin-winding 18
button sewing 80
buttonhole foot 78
buttonhole lever Cover C, 78, 96, 98
buttonhole stitching 76

C

C key Cover E
changing sewing direction 61
changing the needle 38
checking patterns 111
cleaning 124
cleaning brush Cover A, 125
combining patterns 109
crazy quilt stitching 90
cross-stitch 108
cross-wound thread 24
curves 61
cylindrical pieces 46

D

darning 97

E

elastic tape 86
electrical outlet 11
error messages 130
even seam allowance 63
eyelet 99
eyelet punch Cover A, 79, 99

F

fagoting 101
features 2
feed dog position switch Cover C, 93
feed dogs Cover C, 92
flipping 112
foot controller Cover A, 51
foot controller jack Cover C
free-motion quilting 92
front view Cover B

H

handle Cover C
hard case Cover A
heirloom stitching 105

J

joining 104
joining stitch 88

L

language 17
LCD Cover E, 12, 131
 brightness 16, 131
lower threading 22

M

main power switch Cover C, 11
maintenance 124

N

needle 36
needle bar thread hook Cover C
needle clamp screw 38
needle plate Cover C, 63
needle plate cover 124
needle position 57, 73
needle position button Cover D
needle set Cover A
needle stop position 16

O

OK key	Cover E
openings	95
operating procedures	13
operation beep	131
operation buttons	Cover B, Cover D
operation manual	Cover A
operation panel	Cover B, Cover E
optional accessories	1
overcasting stitches	68

P

patchwork stitching	90
patterns	108
piecing	90
pocket corners	95
positioning fabric	50
presser foot	Cover C, 41
presser foot holder	Cover C, 43
presser foot lever	Cover D

Q

quick reference guide	Cover A
quilting	91
quilting foot	92
quilting guide	1, 91, 92

R

realigning	114
rear view	Cover C
recalling a pattern	113
reinforcement stitching	53, 95
repeat sewing	110
reverse/reinforcement stitch button	Cover D

S

satin stitch	108
satin stitching	94
saving patterns	113
scallop stitching	102
screen language	17
screwdriver	38
seam ripper	Cover A, 79
selecting stitching	66
settings	14
settings key	Cover E, 14
sewing machine help key	Cover E, 13
sewing machine needles	36
sewing speed	51
sewing speed controller	Cover D, 94
shell tuck stitch	103
shuttle	22, 124
shuttle hook	125
side cutter	1, 70
side view	Cover C
sleeves	95
smocking	102
spool cap	Cover A, 19, 26

spool net	Cover A, 20
spool pin	Cover B, 19
start/stop button	Cover D, 51
starting sewing	51
stitch length	58
stitch selection key	Cover E
stitch settings	118
stitch width	57
controlling	94
storing patterns	113
straight stitch	72
stretch fabrics	63

T

thick fabrics	62
thin fabrics	63
thread cutter	Cover B
thread cutter button	Cover D, 55
thread guide cover	Cover B
thread guide for bobbin winding	Cover B
thread guide plate	Cover B
thread tension	56
thread tension dial	Cover B, 56
trial sewing	61
triple stretch stitch	95
troubleshooting	126
twin needle	Cover A, 32, 39

U

upper thread	24
upper thread tension	56

V

vertical spool pin	Cover A
--------------------------	---------

W

walking foot	44, 91
wide table	1
wing needle	105

Z

zipper stitching	82
------------------------	----

English
885-S08
XC5252-021
Printed in China

Free Manuals Download Website

<http://myh66.com>

<http://usermanuals.us>

<http://www.somanuals.com>

<http://www.4manuals.cc>

<http://www.manual-lib.com>

<http://www.404manual.com>

<http://www.luxmanual.com>

<http://aubethermostatmanual.com>

Golf course search by state

<http://golfingnear.com>

Email search by domain

<http://emailbydomain.com>

Auto manuals search

<http://auto.somanuals.com>

TV manuals search

<http://tv.somanuals.com>