

Electronic direct drive zigzag lock stitcher

Z-8550A

Electronic direct drive zigzag lock stitcher with thread trimmer

Z-8560A

- Clean Sewing
- Economical models with low power consumption
- Good response, comfortable sewing
- Multifunctional panel of easy operation
- Wide-variety pattern sewing performed by one single machine



Z-8560A-431

The energy-saving direct drive and clean dry head technology have been adopted. Great capability for various pattern sewing, widening sewing possibilities.

Clean Sewing

The Z-8550A and Z-8560A are equipped with a sealed oil tank, supplying constant clean oil only to the rotary hook. Having no oil around the needle bar and thread take-up mechanism, there is no concern of oil staining. The direct drive system, having no shaving of the belt, can keep valued products clean.

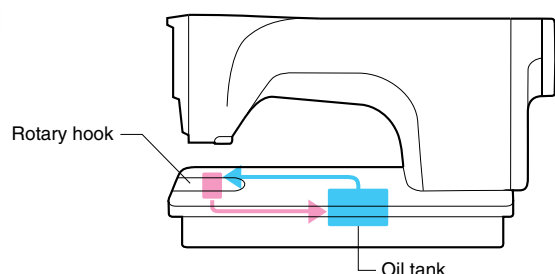

The industry's most efficient energy savings

The internal brand-new direct drive motor, designed through with magnetic field analysis, is the most compact in the industry. As the motor's driving force is transmitted directly to the mechanisms, energy loss can be reduced to the minimum. Electrical power consumption has been lowered to approximately 50% of that of our conventional V-belt driven system (AC servo motor). The Z-8550A and Z-8560A are the top energy-saving models in the industry.

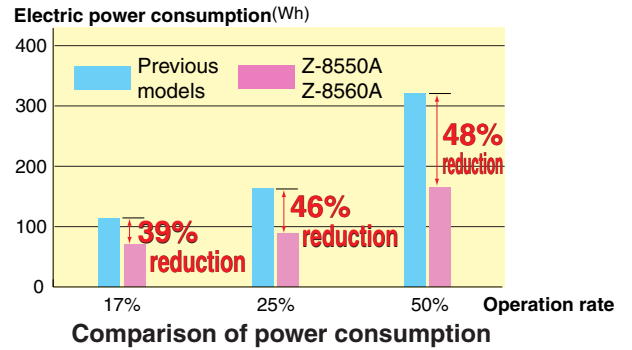
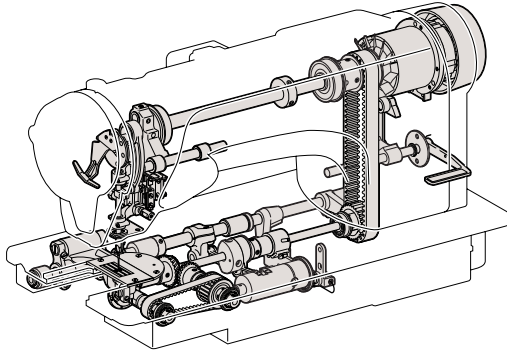

Good response, comfortable sewing

An operator's control is essential for lock stitching process. The direct drive system responds to an operator's control very well and performs sewing fit to his/her intention.

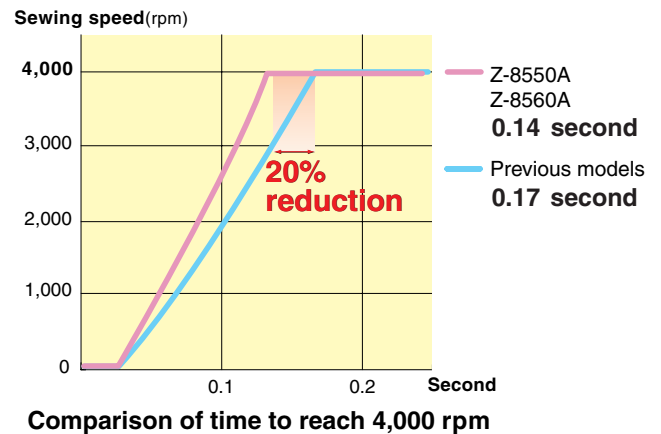

No needle deflection, no position slippage, even at high-speed sewing

With the electronic zigzag stitchers, the needle moves perpendicular to the material so that needle deflection does not occur even at high speed sewing. Furthermore, the pulse motor with servo control, adopted for the needle bar mechanism, prevents position slippage.

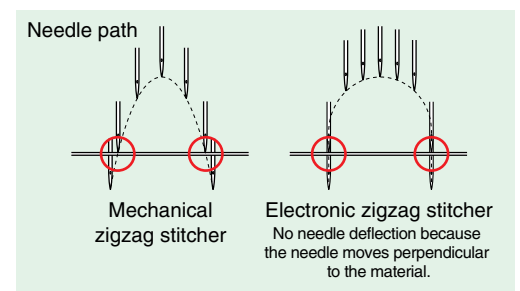

Low noise and low vibration allow stress-free operation

The high-rigidity frame and well-balanced parts details realized by computer analysis have reduced the noise and vibration to the minimum. This frees operators from fatigue and stress.

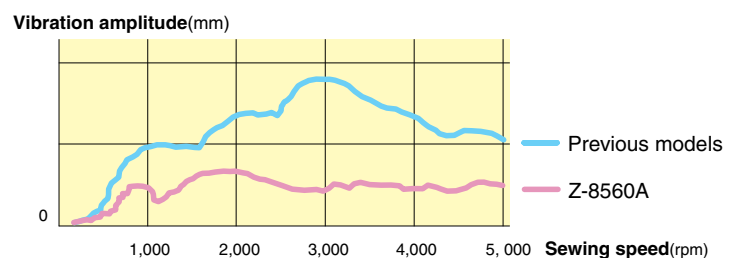

Plain zigzag, 3-step zigzag, scallop patterns and T-stitches* are provided

The basic 8 types, 14 sewing patterns are built-in. Users do not need to have multiple cams for each sewing pattern, which allows excellent cost performance.

| | Straight stitch | Plain zigzag | 2-step zigzag | 3-step zigzag | Scallop (left) | | | | Scallop (right) | | | | Blind stitch (left) | Blind stitch (right) | T-stitch* |
|----------------------|-----------------|--------------|---------------|---------------|----------------|------|----------|------|-----------------|------|----------|------|--|----------------------|--|
| | | | | | Crescent | Even | Standard | Even | Crescent | Even | Standard | Even | | | |
| Basic sewing pattern | | | | | | | | | | | | | | | |
| No. of stitches | — | — | — | — | 24 | 12 | 24 | 24 | 24 | 12 | 24 | 24 | Up to 99 stitches can be set for straight-line sections. | | Setting of T-stitch sewing is to be made with memory switch. |

*T-stitch cannot be sewn with -031 spec.

Custom sewing patterns adding value to the product

Users can store their original sewing patterns in the machine additionally. Custom patterns can be used in a wide variety of applications, such as decorative stitching of ladies wear, knitted articles, neckerchiefs, towel handkerchiefs, foundation garments and swimming wear. Data handling is easily made with CF cards, adopted as storage media. (Up to 99 patterns with a total of 49,500 stitches, 500 stitches or less per pattern. Sewing patterns can be created at the operation panel or by using the sewing data programming software PS-300B (Option).)

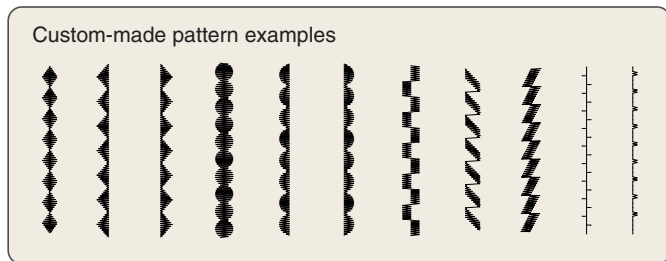

Enhancing sewing quality

Simple setting for condensed stitches

Setting for condensed stitches, making stitches (feed amount) finer at backtacking, can easily be made with the adjustment dial.



Soft, quality sewing finishes

Improvements have been made to enable soft sewing finishes with low thread tension, such as of needle and rotary hook timing, shapes of the rotary hook and the thread take-up, and the thread path.



Minute-adjustable pressing level

Pressing level of the presser foot can minutely be lifted in accordance with materials. It is suitable for sewing of stretch materials and raised fabrics, preventing stitch slippage and damage to the fabrics.



Thread trimming errors can be prevented (Z-8560A)

Grooved cam method, which eliminates thread trimming error, has been adopted. In addition, the knife mechanism is unitized in one unit, allowing simple maintenance.



Trouble-free hook shaft offset mechanism

This mechanism prevents skipped stitches and thread breakages which tend to occur at the needle's right zigzag position. It also makes needle and rotary hook timing adjustment easier and improves the maintenance operation. Damage of the rotary hook tip by the needle guard can be prevented as well.

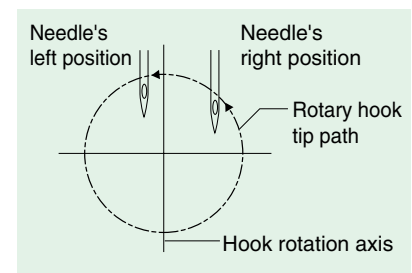

Thread cast-off at sewing start can be prevented (Z-8560A)

The upper thread feeding device supplies just the necessary length of upper thread at sewing start.



User-friendly operation panel

Any required operation is quickly available

The functions are located in symmetrical layout easy to remember, based on user interface. They are grouped and color-coded by operation object so that users are not puzzled at operations.

Two-color display and pictograms, easy to grasp

The two-color display LCD panel has been adopted. It distinguishes contents of displayed items by color. Pictograms easy to grasp are also used.



Digital setting of maximum sewing speed

The maximum sewing speed can be set digitally at the operation panel. The sewing speed can be changed with checking the sewing speed control display visually.



Number of stitches is counted

The number of stitches, which have been sewn, is counted. When the number reaches to the number preset by a user, the machine notifies it with the pictogram and sound. It can be used as a measure of lower thread's used amount or sewn length, and as a production counter.



Easy to view with no eye fatigue

The backlit LCD panel eases users' view of the display. The frosted surface of the display has no reflection that causes users' eye fatigue.

Zigzag base line position can be set as desired

A position of zigzag base line, which is the center of a sewing pattern, can be set at the operation panel. By this setting, a sewing pattern can be shifted right and left.

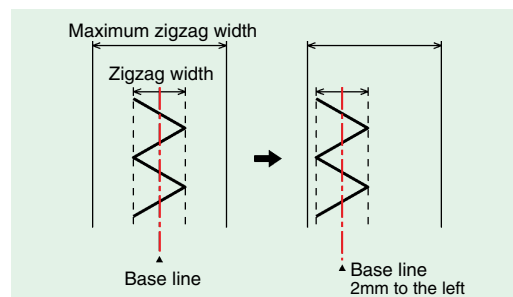

Sewing data can be stored in user programs

Three sets of combinations of such as sewing pattern and zigzag width can be registered. Frequently-used sewing data can be retrieved just by pressing the keys.

Easy operation enhancing productivity

Easy-to-use bobbin winder

The bobbin winder is located at the top of the machine arm. It is easier to adjust the bobbin thread amount and set and remove a bobbin.

Stopping with needle up and needle down position

Needle position function greatly helps material handling. It enables needle down stop, for changing the direction of the material, and needle up stop, for set and removal of materials.

Light-touch pedal operation

The pedal touch of the Z-8550A and Z-8560A is more comfortable compared to that with a clutch motor, making pedal operation easier. Sewing to add some stitches can also be performed with a light-touch pedal operation.

Meeting a wide range of applications by simple adjustment

Feed amount can be set up to 5 mm with the stitch length dial. One single machine can deal with sewing ranging from foundation garments to general materials with large feed pitch, by replacement of the feed dog and the needle plate and simple adjustment.



Easy maintenance

Greasing timing is notified automatically

The running time of the machine is stored, so that a notification for greasing, which is indispensable for dry head sewing machines, is automatically displayed on the panel. (Please use Brother's special grease of good durability.)



Adoption of the CF (CompactFlash) card as storage media

Data passing among sewing machines are easily made. Sewing patterns created using PC (with sewing data programming software PS-300B) can be added by simple operation at the operation panel. Version upgrade of sewing machine control software can also be done with a CF card.



Environment-conscious

Brother has established our original "Brother Green Label" for products in conformity with ISO 14021 and JIS Q14021. The Z-8550A and Z-8560A are environment-conscious sewing machines, certified according to the Brother Green Label's standards such as "Energy-saving capability: a reduction of 35% or above compared with the previous models", "A reduction of lubrication oil consumption of 30% or above by lubrication-free technology" and "Use of lead-free solder in all PC boards".



Energy-saving capability: a reduction of 35% or above compared with the previous models
 A reduction of lubrication oil consumption of 30% or above by lubrication-free technology
 Use of lead-free solder in all PC boards

Sewing examples

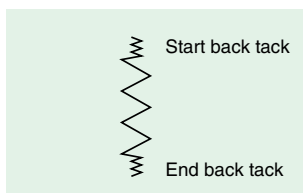

Zigzag width and feed amount can be changed for start backtack and end backtack.

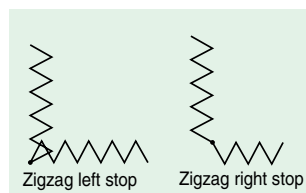

Needle stop position at right or left of zigzag sewing can be set.

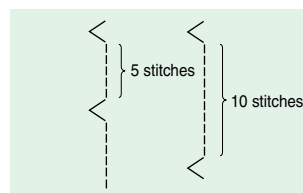

With blind stitches, the number of stitches sewn in a straight line can be set as desired.

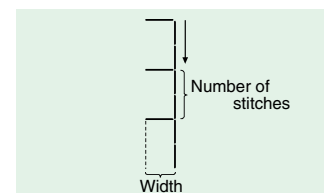

With T-stitches, the width and the number of stitches sewn in a straight line can be set as desired. (The sewing speed for T-stitch is to be 1,000 rpm or below.)

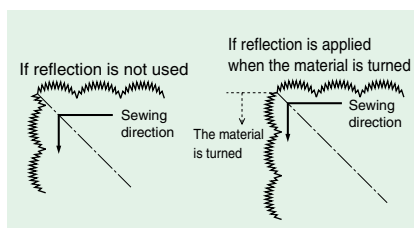

Reflection pattern function can produce beautiful scallop stitches at corners.

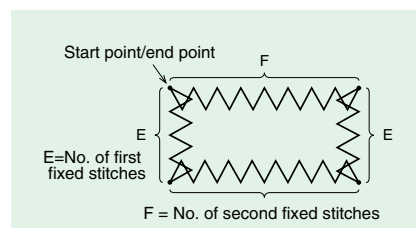

Numbers of stitches of two zigzag stitches can be set with the name label key.

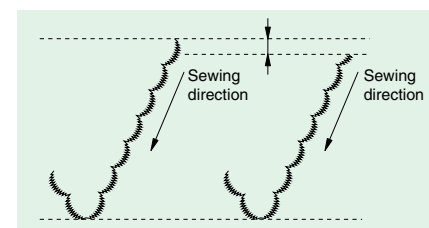

Scallop stitches can be started from the top of a scallop.

Options

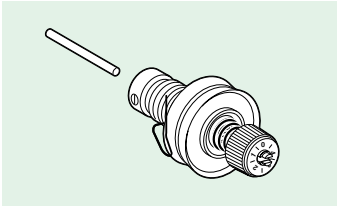

Thread tension assy / Tension release pin

This device prevents the change of thread tightening according to the sewing speed. It is effective for sewing of ladies wear and knitted materials.

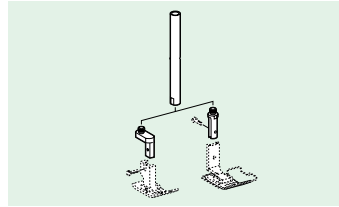

Presser bar

The separate type presser bar for use of presser feet with an attachment of straight lock stitchers' type.



PS-300B Sewing data programming software

Software for sewing pattern creation with PC. Original patterns other than the built-in patterns can be created.

Rotary hook with carbide-reinforced hook tip

The hook tip is wear-resistant, enhancing the hook's durability.

Solenoid type presser foot lifter

Specifications

Z-8550A- 31 Z-8560A- 31

| | | Thread trimmer | Upper thread feeding device | Backtack/condense device*1 | Thread wiper |
|---------|------|----------------|-----------------------------|----------------------------|--------------|
| Z-8550A | -031 | — | — | — | — |
| | -A31 | — | — | ○ | — |
| Z-8560A | -431 | ○ | ○ | ○ | ○ |



ZE-8550A-031



ZE-8560A-431

| Model | DD Direct Drive | Zigzag stitch W | Light materials L | Medium materials M | Height of presser foot ↑↓ | Needle bar stroke ↑↓ | Thread trimmer ✂ | Max sewing speed ⌚ |
|---------|--------------------|---------------------------|----------------------|-----------------------|------------------------------|-------------------------|---------------------|-----------------------|
| Z-8550A | ★ | Max. zigzag width 10 mm*2 | ★ | ★ | Manual 6 mm Knee 10 mm | 33.3 mm | — | 5,000 rpm*3 |
| Z-8560A | | | | | | | ★ | |

*1 Used for condensed stitches and backtack stitches.

*2 The factory setting is 8 mm. To make it 10 mm, gauge parts and a stopper for the size are necessary (Option).

*3 The factory setting is 4,000 rpm. The speed may be limited by some sewing patterns or settings of zigzag width.

*4 The factory setting is 2mm. To make it 5mm, gauge parts for the size are necessary (Option).

| | |
|-----------------------|--|
| Feed amount | Max. 5.0mm*4 |
| Sewing pattern | 8 types, 14 patterns built-in(Custom patterns can be added up to 99 patterns with a total of 49,500 stitches, 500 stitches or less per pattern.) |
| Thread take-up | Rotary |
| Height of feed dog | 1mm |
| Presser foot pressure | 10-60N |
| Needle | Schmets 134SUK Nm70/10 |

| | |
|-----------------|---|
| Weight | Machine head 44.4kg(Z-8550A), 49kg(Z-8560A) Control box 14-15kg(100V-230V spec.), 17-18kg(380V spec.) |
| Arm pocket size | Arm pocket width 300mm, Arm height 121.5mm |
| Arm bed size | 517.5X178mm |
| Motor | AC servo motor (4 poles, 450W) |
| Power supply | Single-phase: 100V, 110V, 220V, 230V 3-phase: 200V, 220V, 380V, 400V, 415V Max. electric power consumption: 400VA |
| Control circuit | Microprocessor |

CF(TM) is a trademark of a SanDisk Corporation. CompactFlash(R) is a trademark or US registered trademark of SanDisk Corporation.

Product specifications are subject to change for improvement without notice. Please read instruction manual before using the machine for safety operation.

brother

BROTHER INDUSTRIES, LTD.

15-1, Naeshiro-cho, Mizuho-ku, Nagoya 467-8561, Japan.
Phone:81-52-824-2177 Fax:81-52-811-7789 <http://www.brother.com/>



Brother Industries, Ltd. Machinery & Solution Company
Mizuho and Minato plants acquired ISO 9001 and 14001 certifications.

| | | |
|--------------------|--|-------------------|
| R.P. CHINA | BROTHER (CHINA) LTD. http://www.brothergroup.com.cn/cn/area_top.html | +86-021-6237-1228 |
| HONG KONG | BROTHER INTERNATIONAL (HK) LTD. http://www.brother.com.hk/eng/home/default.asp | +852-2777-0010 |
| ASIA | BROTHER INTERNATIONAL SINGAPORE PTE LTD. http://www.brother.com.sg/ | +65-538-0311 |
| MIDDLE EAST | BROTHER INTERNATIONAL (GULF) FZE http://www.brother.ae/ | +971-4-8835878 |
| EUROPE | BROTHER INTERNATIONALE INDUSTRIEMASCHINEN G. m. b. H. http://www.brother-ism.de | +49-2822-6090 |
| AMERICA | BROTHER INTERNATIONAL CORPORATION http://www.brother-usa.com/ | +1-908-704-1700 |
| TURKEY | BROTHER INTERNATIONAL CORPORATION TURKISH LIAISON OFFICE | +90-212-495-3971 |

To preserve environment, this catalog is produced using the ECF paper (Elemental Chlorine-Free) and SOY INK.

Printed in Japan 2006.04 I5090894B Vol.2

Free Manuals Download Website

<http://myh66.com>

<http://usermanuals.us>

<http://www.somanuals.com>

<http://www.4manuals.cc>

<http://www.manual-lib.com>

<http://www.404manual.com>

<http://www.luxmanual.com>

<http://aubethermostatmanual.com>

Golf course search by state

<http://golfingnear.com>

Email search by domain

<http://emailbydomain.com>

Auto manuals search

<http://auto.somanuals.com>

TV manuals search

<http://tv.somanuals.com>