

User's Guide

EM-430 CE-400

ELECTRONIC TYPEWRITER

English

brother[®]

US ENGLISH CUEUS

Brother EM-430/CE-400 Electronic Typewriter

Please record in the blank space below the MODEL NO. and SERIAL NO. of this typewriter. The MODEL NO. and SERIAL NO. are located on the back of the typewriter.

MODEL NO.: _____ SERIAL NO.: _____

Please keep these numbers in a safe place for future reference.

FCC NOTICE

This equipment generates and uses radio frequency energy and if not installed and used properly, that is, in strict accordance with the manufacturer's instructions, may cause interference to radio and television reception. It has been type tested and found to comply with the limits for a class B computing device in accordance with the specifications in Subpart J of Part 15 of FCC Rules, which are designed to provide reasonable protection against such interference in a residential installation. However, there is no guarantee that such interference to radio or television reception, which can be determined by turning the equipment on and off, will be avoided. The user is encouraged to try to correct the interference by one or more of the following measures:

- Reorient the receiving antenna
- Relocate the computer with respect to the receiver
- Move the computer away from the receiver
- Plug the computer into a different outlet so that the computer and receiver are on different branch circuits. If necessary, the user should consult the dealer or an experienced radio/television technician for additional suggestions. The user may find the following booklet prepared by the Federal Communications Commission helpful: "How to Identify and Resolve Radio-TV Interference Problems". This booklet is available from the US Government Printing Office, Washington, D.C., 20402, Stock No. 004-000-00345-4.

THE EQUIPMENT MUST BE INSTALLED NEAR THE SOCKET OUTLET, WHICH MUST BE
EASILY ACCESSIBLE.

Table of Contents

GENERAL VIEW	3
SETTING UP THE TYPEWRITER	4
Paper Support	4
Acoustic Cover	5
Margin scale	5
Top Cover	5
Opening the top cover	5
Closing the top cover	6
Power Switch	6
Cassette Daisy Wheel	7
Removing the daisy wheel	7
Inserting the new daisy wheel	8
Cassette Ribbon	8
Removing the old ribbon	9
Inserting the new ribbon	9
Correction Tape	10
Removing the old correction tape	11
Installing the new correction tape	11
BASIC TYPING FUNCTIONS	13
Auto Paper Insert	13
Manual Paper Insert	14
Setting Start Position	15
Paper Thickness Control	15
Setting Impact	15
The Keyboard (Version 1)	16
The Keyboard (Version 2)	16a
Symbol Keyboards	16b
Selecting Keyboard	17
Dead Keys	18
Code Key	18
Extra characters	18
Setting Line Space	18
Setting Typing Pitch	19
Margins	20
Preset margins	20
Margin release	20
Setting margins	20
Setting left margin	20
Setting right margin	20
Setting And Using Tabs	21
Normal tabs	21
Decimal tabs	22
Tab clear	23
All tab clear	23
Using Shift And Caps Keys	23
Shift	23
Shift lock	24
Caps	24
Backspacing	24
Simple backspace	24
Express backspace	24
Micro backspace	24
Repeat Function	25
Auto repeat	26
ADVANCED TYPING	27
Bold	27
Auto Underline	27
Expand	28
Carrier Return	28
Manual carrier return	28
Hot zone	28
Auto carrier return	29
Permanent spaces and hyphens	29
Centering	30
Right Margin Flush	30
Indentation	31
Line indentation	31
Paragraph indentation	31
Indent clear	32
Corrections	32
Automatic correction	32

Character correction	33
Word out	34
Line out	34
Insertions And Deletions	35
Insertions	35
Deletions	36
Relocation	38
Manual Correction	38
Subscript And Superscript	39
Micro index/reverse micro index	40
Memory	40
Storing a line format	40
Calling a line format	
From memory	41
Text memory	41
Correction in store mode	41
Printing text from memory	42
Removing text from memory	43
 MAINTENANCE AND TROUBLE-	
SHOOTING	44
 Maintenance	44
Environment	44
Cleaning	44
Supplies	45
Troubleshooting	46
 SPECIFICATIONS	47
 KEYBOARD LAYOUT (VERSION 1) ...	48
 KEYBOARD LAYOUT (VERSION 2) ...	50
 INDEX	52

Self Demonstration Feature

Your typewriter has a self-demonstration that shows many of the typing features of the machine. Your dealer may already have demonstrated this to you, but if not, you can do it yourself. After you have set up the typewriter and switched it on as detailed in the following section, insert a sheet of paper and press the [SHIFT] and [PITCH] keys together.

To stop the demonstration press the [SPACEBAR].

General View

PRINTER CARRIER

Printing mechanism that holds the ribbon cassette, daisy wheel, and correction tape
It moves back and forth along the platen

PAPER SUPPORT

Holds paper for insertion

PAPER GUIDE

Moves for paper alignment

PAPER RELEASE LEVER

Unlocks the platen to adjust paper position

ACOUSTIC COVER

Suppresses printing noise, protects from dust, and has margin and tab reference scale for convenience

TOP COVER

Protects print carrier

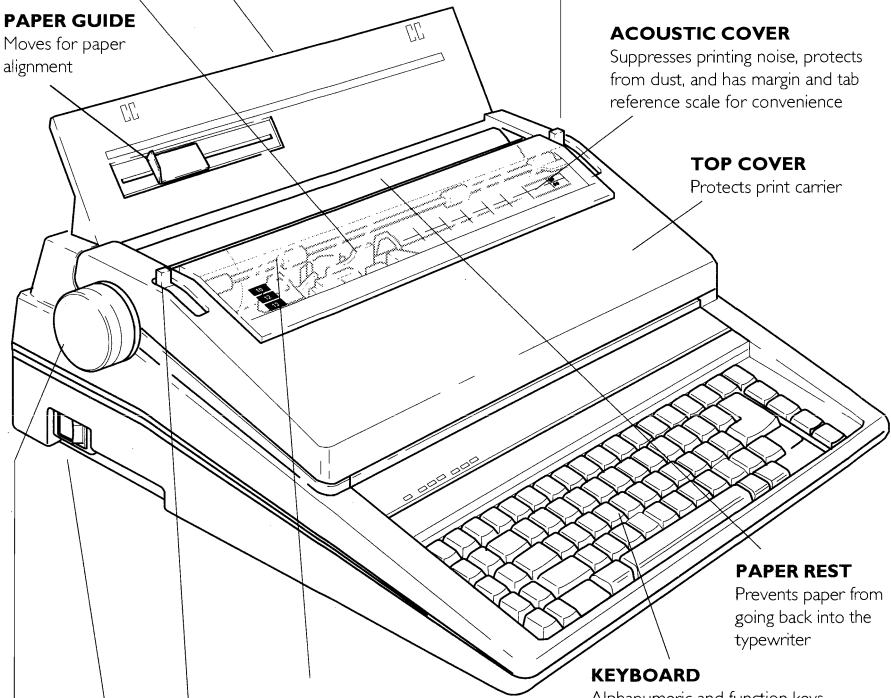

PAPER REST

Prevents paper from going back into the typewriter

KEYBOARD

Alphanumeric and function keys

PAPER BAIL

Applies pressure for automatic paper feeding

PAPER BAIL RELEASE LEVER

Opens the paper bail to ease manual paper insertion

POWER SWITCH

Turns the typewriter ON and OFF

PLATEN KNOB

Feeds paper manually

Setting up the Typewriter

This section tells you how to set up your typewriter to be ready for typing. If you didn't remove the yellow packing pieces and fit the paper support when you unpacked the typewriter, now is the time to do it before you attempt to power up the machine.

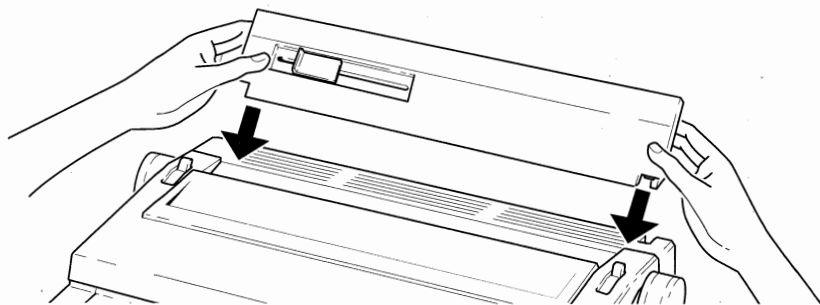

Paper Support

The paper support is used to check and adjust the position of the paper.

Attach the paper support by inserting the tabs into the holes provided on the top of the typewriter.

The sliding paper guide can be used to adjust the position of the left edge of the paper, relative to the extreme left position of the print carrier, which is indicated by the '0' mark on the embossed scale.

Note:

Should you need to move your typewriter, we suggest that you remove the paper support first to avoid the risk of damage.

Acoustic Cover

The acoustic cover suppresses the noise created by the typing carrier and prevents dust from entering the typewriter. Electronic typewriters really dislike dust, so make sure that the acoustic cover of your typewriter is always closed.

Margin scale

The margin scale is embossed on the acoustic cover. It shows the three pitch scales (for 10, 12 and 15 characters per inch), the left and right margins, the tab stop positions and the position of the carrier.

Top Cover

Opening the top cover

In order to insert a new cassette daisy wheel, cassette ribbon or spool of correction tape, first place the top cover of the typewriter to the upright position. Do this by placing both hands on either end of the cover and lifting it upwards until it stands by itself.

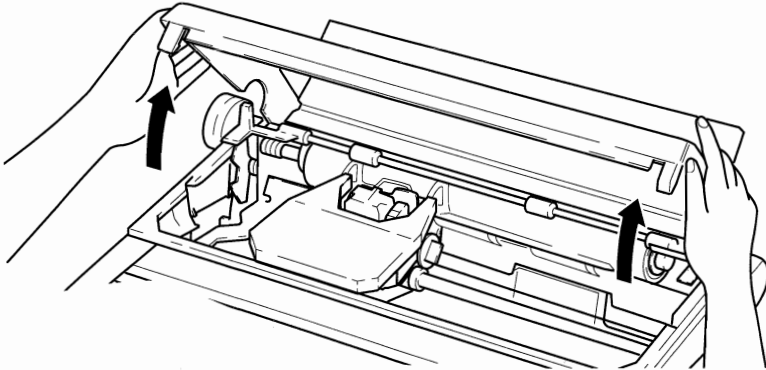

Notes:

1. The keyboard locks up when the cover is raised, and typing is not possible until it is closed again.
2. Opening the top cover has no effect on margin settings, tab settings or the correction memory, all of which are retained without change.

Closing the top cover

After inserting the cassette daisy wheel, cassette ribbon or spool of correction tape, close the top cover by replacing it to its original position.

Ensure that it is firmly in place after closing.

Note:

If the top cover is closed with the unit switched **ON**, the carrier will automatically travel to the left edge, then return to its previous position.

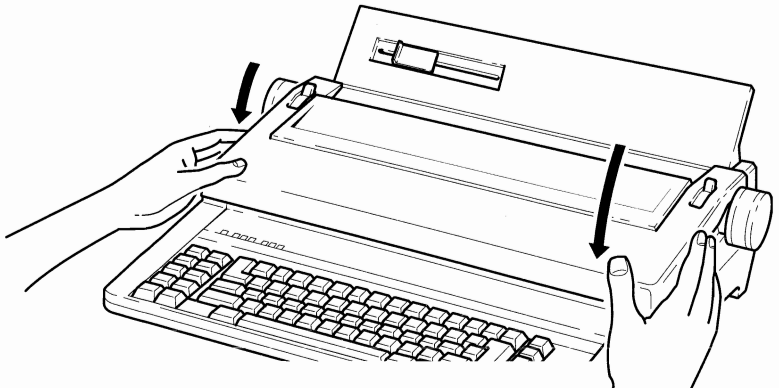

Power Switch

Your typewriter is now ready to be powered up. You'll find the power cord at the back of the typewriter. Simply unwrap it and plug it in.

The Power Switch is located at the left rear side of the typewriter under the platen knob.

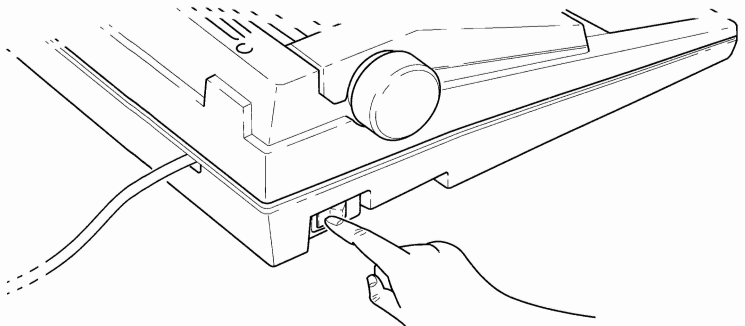

Set the Power Switch to the **ON** position. The following should occur:

1. The daisy wheel rotates and stops.
2. The carrier moves automatically to the far left end of the platen and then to the preset or specified left margin.

Notes:

1. Whenever you lift up the top cover, for example to change the cassette ribbon, the power to the typewriter will automatically go off. For this reason there is no danger in changing the cassette daisy wheel or cassette ribbon and correction tape even with the Power **ON**.
2. If any of the above didn't happen, take a look at the section on troubleshooting on page 46.

Cassette Daisy Wheel

Brother's slip-in, slip-out cassette daisy wheels are known the world over for their beautiful true letter quality type print. Here's your chance to discover it for yourself.

Your typewriter comes with a cassette daisy wheel already installed. You may, at some point, wish to exchange it for one with a different typeface, or to place a new one in. With the Brother typewriter, this is a very simple task.

Removing the cassette daisy wheel

To remove the cassette daisy wheel, pull the motor lock lever toward you to release it, then grasp the 'ear' of the cassette daisy wheel between your thumb and forefinger and simply pull it out.

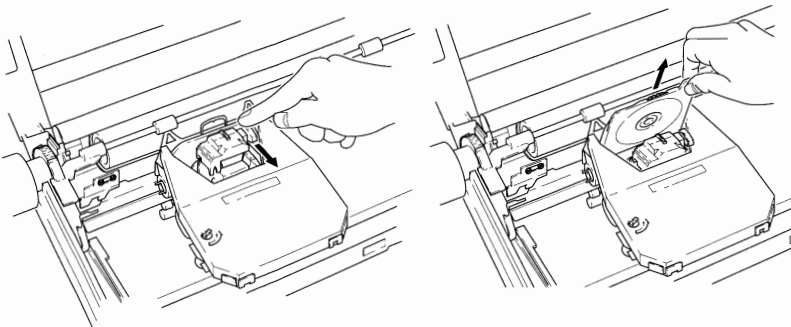

Note:

The cassette ribbon need not be removed in order to remove the cassette daisy wheel.

Inserting the new cassette daisy wheel

Grasping the 'ear' of the new cassette daisy wheel, slip it into the cassette guide slot and slide it in as far as it will go.

Now press the motor lock lever back toward the platen until it clicks into place. Do not force the lever. If you have any difficulty, recheck the cassette daisy wheel to ensure that it is properly set and try again.

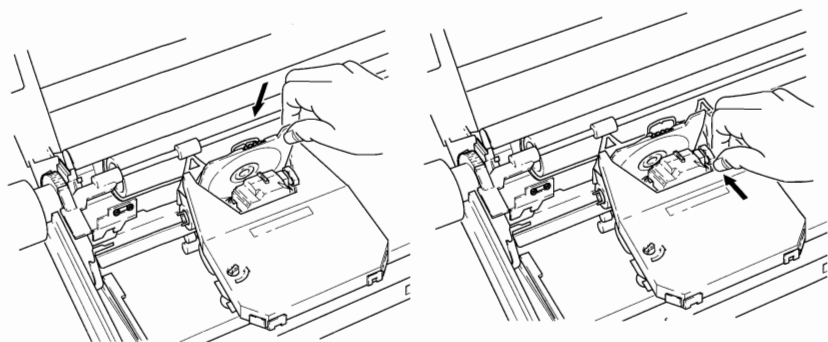

Notes:

1. Be sure that the 'ear' of the cassette daisy wheel is to the right during insertion. Putting it in backwards can damage both the cassette daisy wheel and the motor mechanism.
2. If the cassette daisy wheel is not properly locked into position, characters will not be properly typed.
3. There is a wide selection of Brother cassette daisy wheels available.

Cassette Ribbon

The wide range of Brother cassette ribbons available have two unique features in common: they are clean and trouble free. Clean means that the ink goes where it is supposed to go, on the paper, and not on your hands!

Removing the old cassette ribbon

First, use the **[SPACEBAR]** or **[BKSP]** key to move the carrier to the center of the platen. To remove the cassette ribbon, hold the cassette with both hands and raise the front end (that near to the platen). Then, when the ribbon is clear, simply lift the cassette up and out.

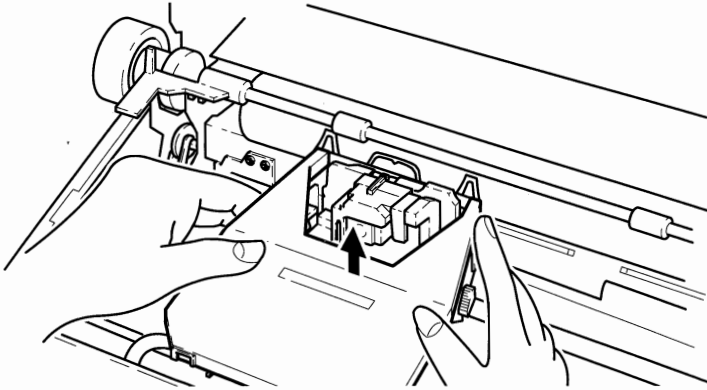

Inserting the new cassette ribbon

Remove the stopper from the new cassette ribbon and turn the ribbon feed knob counter clockwise to tighten the ribbon.

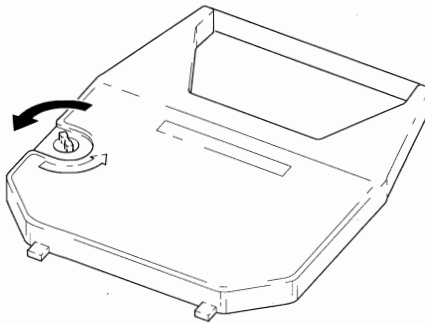

Now locate the lugs on the back edge of the cassette into the locating holes in the cassette ribbon table, and slide the ribbon between the ribbon guides.

With the ribbon set between the ribbon guides, press the cassette down until it locks into place. Turn the ribbon feed knob again slightly counter clockwise to tighten the ribbon.

Notes:

1. A window is provided in the cassette to allow you to check on the remaining amount of ribbon.
2. Brother cassette ribbons are available in four different types:
 - Correctable film ribbon (standard with this model)
 - One-time film ribbon
 - Multistrike film ribbon
 - Nylon ribbon

The correctable film ribbon is also available in red, blue, green and brown.

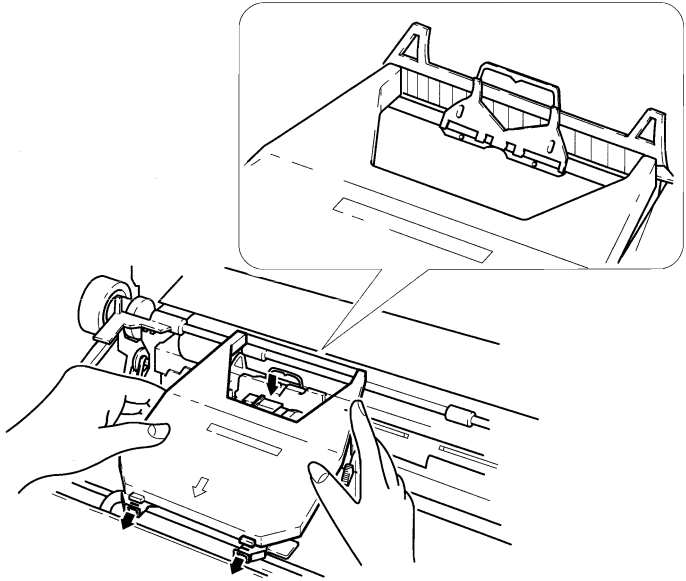

Correction Tape

The correction tape guarantees a faultless document every time. What's more, the bottom of your typewriter will never be full of pieces of old correction paper and lumps of dried up correction fluid!

Removing the old correction tape

If you need to replace the correction tape, first make sure that the carrier is in the center of the platen by using the [SPACEBAR] or [BKSP] key. Then remove the cassette ribbon.

Now just pull out the left and right spools of the old correction tape from the carrier.

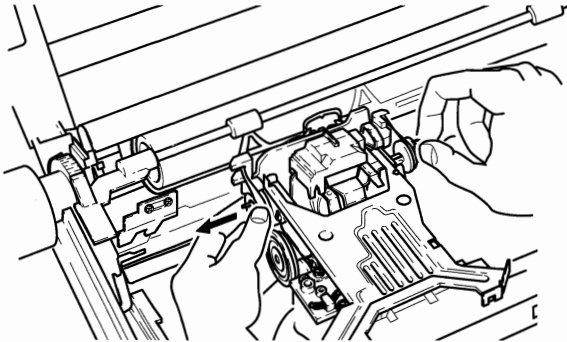

Installing the new correction tape

First install the left spool, then thread the tape across the left and right guide rollers and install the right spool. Make sure that the active (non-shiny) side of the correction tape is facing towards the platen.

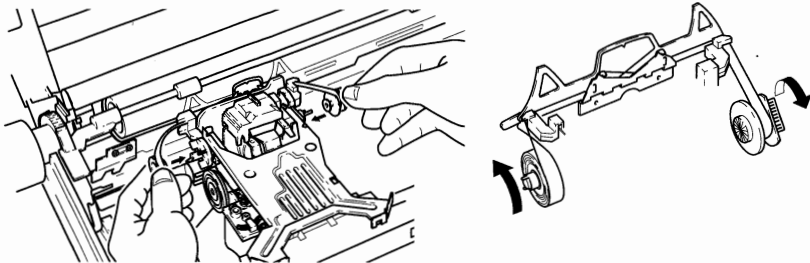

Take up the slack by turning the right spool counter clockwise until the white portion of the tape begins to wind onto the right spool.

Note:

Brother correction tapes are available in two types:

Liftoff correction tape (standard with this typewriter)

This is used together with the correctable film ribbon.

Coverup correction tape

This is used together with the multi-strike film ribbon, one-time film ribbon or the nylon ribbon.

Basic Typing Functions

Having set up your typewriter, you are now ready to insert a sheet of paper and begin typing.

Automatic Paper Insertion



Inserting a sheet of paper into a typewriter has never been simpler: just three easy steps and you're off! Most types of smooth finish paper can be used with your typewriter. Rag content and other types of rough paper, however, are not recommended.

First, ensure that the power switch is **ON**, and that the **PAPER RELEASE LEVER** is set to the back position.

Place the paper guide in the desired position, then, holding the sheet as straight as possible, insert the paper into the slot behind the paper rest with the left edge against the paper guide.

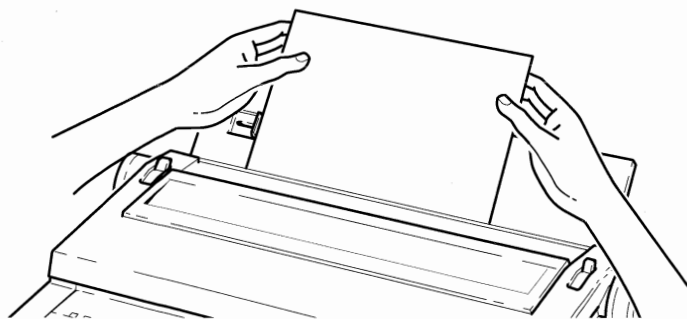

Now press the **[PINS]** key. The carrier will first move to the left end of the platen and then back to the center of the margin scale, the paper bail will lift, and the platen will rotate to feed in the sheet of paper automatically.

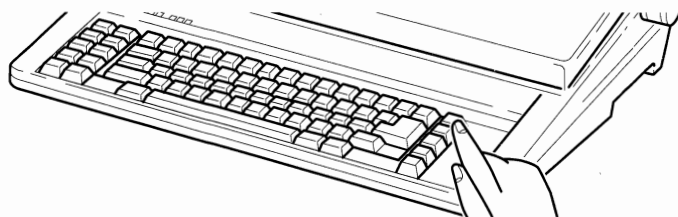

Hold down the [CODE] key and press the [EXPR] key, or simply press the [RETURN] key to move the carrier to the left margin position. If you press the [RETURN] key, the paper will advance according to the line spacing.

Notes:

1. The paper is automatically fed approximately 1 inch from the top edge of the paper.
2. For even more precise settings, you can also move the paper up or down half a line at a time with the [INDEX] and [R INDEX] keys.
3. If the paper is crooked or not properly aligned after automatic insertion, it may be adjusted manually. First turn the platen or use the [INDEX] key to feed more paper through, then pull the paper release lever forward. This will lift the paper bail and release the paper so that it may be moved manually. Align the paper until it is straight, then return the paper release lever to its back position and turn the platen knob or use the [INDEX] and [R INDEX] keys to return the paper to the position where you wish to begin typing. For finer adjustment, use these keys with the [CODE] key held down.

Manual Paper Insertion

You may need to use the manual method for unusual settings or for when you need to make a precise alignment in the middle of a document.

First insert the sheet of paper into the slot behind the paper rest while keeping the left edge of the paper in line with the paper guide. Set the paper release lever in its back position. Use both hands and try to keep the sheet as straight as possible.

Pull the paper bail lever forward to raise the paper bail and avoid it catching on the paper. Then turn the platen knob until the top edge of the paper is brought under the paper bail to the position desired, and release the paper bail lever. If the sheet is not straight, set the paper release lever to its forward position and straighten the sheet with both hands. Return the paper release lever to its back position and turn the platen knob until the sheet comes out to the desired position.

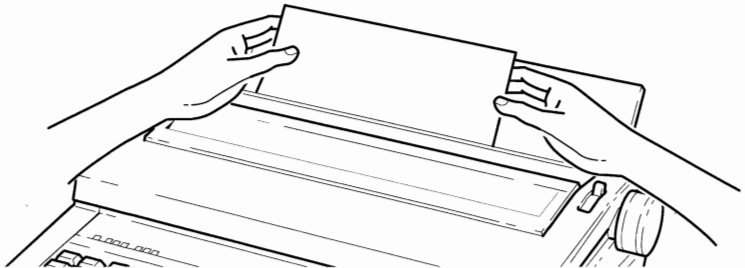

Setting Start Position

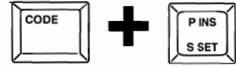

Automatic paper insertion normally sets the paper so that typing will start approximately one inch (25.4 mm) from the top of the page. However, you can change this position using the **START SET** function, so that auto-insertion will set the paper to a start position anywhere between one and six inches (25.4 and 152.4 mm) from the top of the page.

To set the start position, insert a sheet of paper and press the **[PINS]** key to auto-insert the page. Now, use the **[INDEX]** and **[R INDEX]** keys to adjust the position of the page to where you wish to begin typing. Then, hold down the **[CODE]** key and press the **[S SET]** key to save that setting as the start line.

Paper Thickness Control

The paper thickness control is located on the right side of the cassette ribbon table.

The lever is normally pushed right down in its standard position. Pulling up the lever increases the space between the carrier print head and the platen, thus enabling you to insert thicker paper and envelopes.

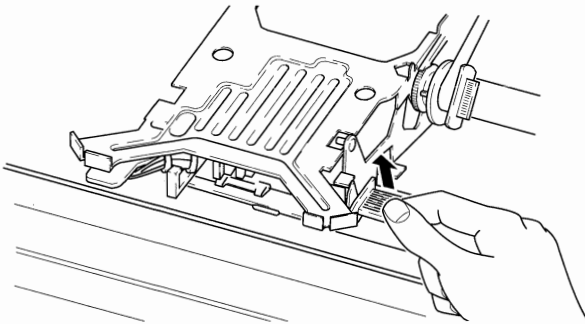

Setting Impact



Typing impact may be adjusted according to the quality and thickness of the paper you wish to use, or to the number of carbon copies you are making.

Select the desired impact force by holding down the **[CODE]** key and pressing the **[8]** key for **LIGHT** impact, the **[9]** key for **MEDIUM** impact, or the **[0]** key for **HEAVY** impact.

Note:

Your typewriter is able to make up to 4 carbon copies in addition to the original document.
Download from www.Somanuals.com. All Manuals Search And Download.

The Keyboard (Version 1)

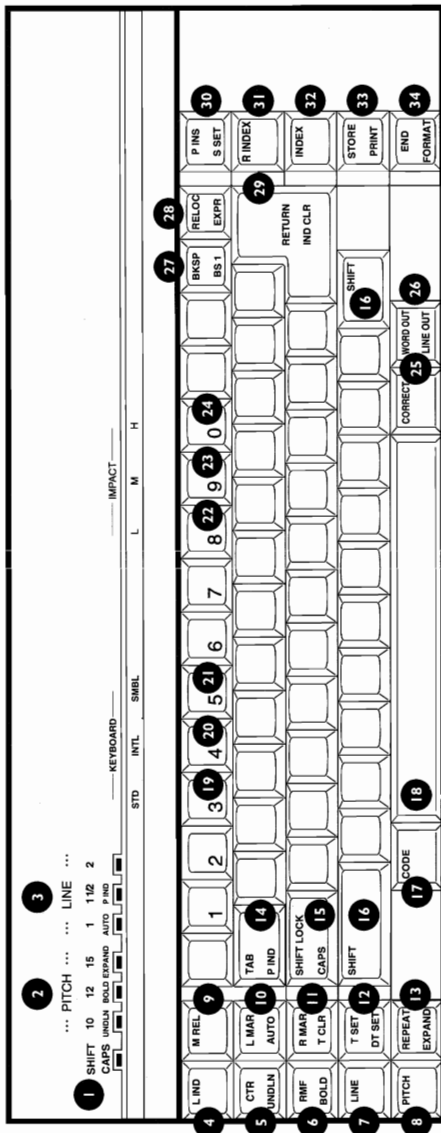

INDICATORS

1. Shift/Caps*

2.

10 Pitch/Underline*

12 Pitch/Bold*

15 Pitch/Expand*

3.

Single Line Spacing/

Carrier Return*

1 1/2 Line Spacing/Paragraph Indent*

1 1/2 Line Spacing/Paragraph Indent*

Double Line Spacing

KEYS

4 Line Indent

5 Centering/Auto Underline*

6 Right Margin Flush/Bold*

7 Line Spacing

8 Pitch

9 Margin Release

10 Left Margin/Auto Carrier Return*

11 Right Margin/Tab Clear*

12 Tab Set/Decimal Tab Set*

13 Repeat/Expand*

14 Tab/Paragraph Indent*

15 Caps Lock

16 Shift

17 [CODE]

18 Space Bar

19 Keyboard Standard*

20 Keyboard International*

21 Keyboard Symbol*

22 Light Impact*

23 Medium Impact*

24 Heavy Impact*

25 Correction/Manual Correction*

26 Word Out/Line Out*

27 Backspace/Micro Backspace*

28 Relocate/Express Backspace*

29 Return/Paragraph Indent Clear*

30 Paper Insert/Start Set*

31 Reverse Index/Micro Reverse Index*

32 Index/Micro Index*

33 Store/Print*

34 End/Format*

*: Key functions or indicators shown with an asterisk are selected while pressing the [CODE] key

The Keyboard (Version 2)

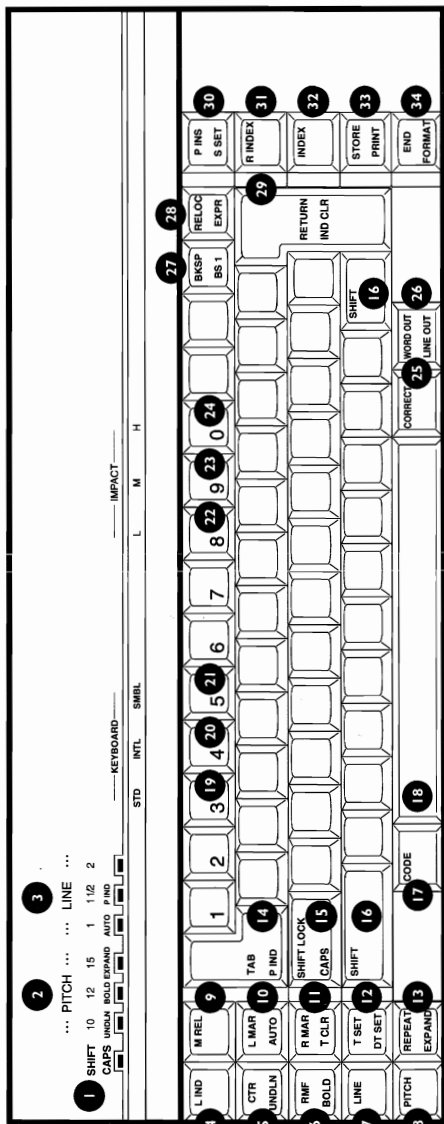

INDICATORS

1. Shift/Caps*

2.

10 Pitch/Underline*

12 Pitch/Bold*

15 Pitch/Expand*

3.

Single Line Spacing/

Auto Carrier Return*

1 1/2 Line Spacing/Paragraph Indent*

Double Line Spacing

KEYS

4 Line Indent

5 Centering/Auto Underline*

6 Right Margin Flush/Bold*

7 Line Spacing

8 Pitch

9 Margin Release

10 Left Margin/Auto Carrier Return*

11 Right Margin/Tab Clear*

12 Tab Set/Decimal Tab Set*

13 Repeat/Expand*

14 Tab/Paragraph Indent*

15 Caps Lock

16 Shift

17 [CODE]

18 Space Bar

19 Keyboard Standard*

20 Keyboard International*

21 Keyboard Symbol*

22 Light Impact*

23 Medium Impact*

24 Heavy Impact*

25 Correction/Manual Correction*

26 Word Out/Line Out*

27 Backspace/Micro Backspace*

28 Relocate/Express backspace*

29 Return/Paragraph Indent Clear*

30 Paper Insert/Start Set*

31 Reverse Index/Micro Reverse Index*

32 Index/Micro Index*

33 Store/Print*

34 End/Format*

*. Key functions or indicators shown with an asterisk are selected while pressing the [CODE] key

Symbol Keyboards

Version 1

	± 1	× 2	÷ 3	. 4	- 5	# 6	≤ 7	≥ 8	∫ 9	√ 0		
	Γ γ	Δ δ	← ε	Θ θ	→ τ	Υ υ	Ξ ξ	Ι ι	↓ ο	ρ	Π π	{ }
	∇ α	Σ σ	Φ φ	< ∆	∧ λ	Π η	> †	§ K	Ω ω			
	≈ 	≡ X	Ψ ψ	∞ 	∞ β	~ ν	∂ μ		-	≡ 		

BOX MEANS DEAD KEY

USED WITH CODE KEY

Version 2

± 1	× 2	÷ 3	. 4	- 5	# 6	≤ 7	≥ 8	∫ 9	√ 0			
	Γ γ	Δ δ	← ε	Θ θ	→ τ	Υ υ	Ξ ξ	Ι ι	↓ ο	ρ	Π π	{ }
	∇ α	Σ σ	Φ φ	< ∆	∧ λ	Π η	> †	§ K	Ω ω			
	≈ 	≡ X	Ψ ψ	∞ 	∞ β	~ ν	∂ μ		-	≡ 		

USED WITH CODE KEY

BOX MEANS DEAD KEY

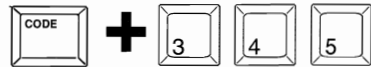

Selecting Keyboard

A wide variety of daisy wheels is available for your typewriter. As well as having different typefaces, some of these daisy wheels have different sets of characters to suit different languages and applications. The typewriter has a choice of three keyboard settings to allow it to work properly with different types of daisywheel.

I (Standard)

This is probably the keyboard that you'll be using most of the time, with "ENGLISH" daisywheels. When an English daisy wheel is used with keyboard I selected, the characters shown on the left side of the keytop are printed.

II (International)

This Keyboard should be used when an optional "INTERNATIONAL" daisy wheel has been inserted. You will notice that some of the keytops have characters printed on the right as well as on the left. When an international daisy wheel is used and keyboard II is selected, the characters shown on the right side of each key top are printed instead of the characters shown on the left side.

III (Symbol)

This Keyboard is for when you need to type mathematical formulas or numbers which require special symbols, using the optional "SYMBOL" daisy wheel. The symbol keyboard arrangement is shown below.

Select the desired keyboard by holding down the [CODE] key and pressing the **3** **4** or **5** key.

Notes:

1. Be sure that the proper daisy wheel is used for the keyboard selected. For instance, when using II, an international cassette daisy wheel should be inserted, and the symbol cassette daisy wheel for III.

Dead Keys

The dead keys are used for diacritical marks (e.g. accents) that may be placed over typed characters. The carrier does not move when a dead key is typed, so the character beneath the accent can be typed afterwards without having to backspace. When typed in the underline mode, the typed mark will not be underlined.

CODE Key



The [CODE] key is used to access any function labelled in green. In addition, while the [CODE] key is held down, the legends printed in green above the indicator LEDs are valid.

Extra characters

The extra characters printed in green on the bottom half of some of the keys are typed by holding down the [CODE] key and pressing those keys.

Setting Line Space



Your typewriter offers you three choices of line spacing: single line spacing, one and a half line spacing, and double line spacing. Select the desired line spacing by pressing the [LINE] key. Each time the [LINE] key is pressed, line spacing will change to the next setting in the order 1 - 1 1/2 - 2 and the LED for the selected line space will light.

Single line spacing places 1/6 inch of space between lines.

One and a half line spacing places 1/4 inch of space between lines.

Double line spacing places 1/3 inch of space between lines.

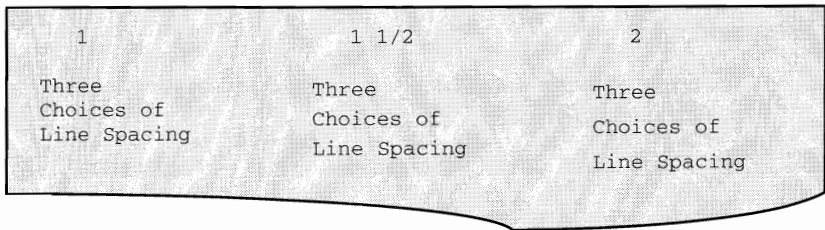

Setting Typing Pitch



Your typewriter offers you three choices of pitch:

Pica, or 10 pitch (10 characters per inch)

Elite or 12 pitch (12 characters per inch)

Micron or 15 pitch (15 characters per inch)

Select the desired pitch by pressing the **[PITCH]** key. Each time the **[PITCH]** key is pressed, pitch will change to the next setting in the order 10-12-15 and the LED for the selected pitch setting will light.

10 pitch allows 117 characters to be typed per line.

12 pitch allows 140 characters to be typed per line.

15 pitch allows 175 characters to be typed per line.

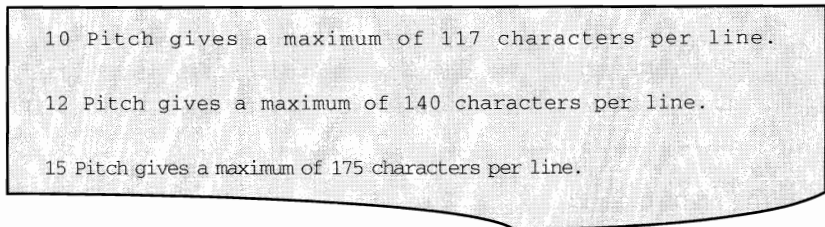

Margins



As you learned earlier, when the typewriter is switched **ON**, the carrier moves automatically to the far left and then 10 spaces to the right. This is the preset left margin in 10 pitch.

Preset margins

The preset left margin will vary as will the right margin depending on the typing pitch as shown in the following table .

Pitch	Left margin	Right margin
10	10	75
12	12	90
15	15	112

Margin release



The print carrier will normally not move outside the margins. However, on occasion, you may wish to type outside the margins. It will also be necessary to move the carrier past the margins if you want to set margins outside the ones currently set.

To move to the left of the left margin, use the **[BKSP]** key to reach the left margin, press the **[M REL]** key and then continue to press the **[BKSP]** key to where you wish to begin typing.

To move past the right margin, press the **[M REL]** key when the margin is reached, then continue typing.

Setting margins

If you do not wish to use the standard margins, you can set your own margins very easily.

Setting left margin



To set a new left margin, move the carrier to the new left margin position using the **[SPACEBAR]** or **[BKSP]** key. If the new margin position is to the left of the old margin, you will need to use the **[M REL]** key before you can move outside the old margin.

Press the **[L MAR]** key. The left margin is now set.

Setting right margin



To set a new right margin, move the carrier to the new right margin position using the **[SPACEBAR]** or **[BKSP]** key.

Then press the **[R MAR]** key. The right margin is now set.

If you wish to move beyond the existing right margin to set a new one, press **[MREL]** to release the margin when you reach it. However, you should first ensure that the automatic carrier return is switched off. If it is not, you cannot move beyond the existing right margin using the **[SPACEBAR]** as the carrier will return automatically.

To switch off automatic carrier return, hold down the **[CODE]** key and press the **[L MAR]** key until the **AUTO** LED above the  key is off.

The minimum width between left and right margins depends on the typing pitch, as shown in the following table.

Pitch	Min Margin Width	Expand mode
10	20 characters	10 characters
12	24 characters	12 characters
15	30 characters	15 characters

Setting And Using Tabs

Tabs allow you to move the typing position quickly and automatically to a preset position. As their name suggests, they are useful for typing tables, and are also used for indenting paragraphs.

Normal tabs



Normal (left-aligned) tabs are set by moving the carrier to the position at which a tab is required and pressing the **[T SET]** key. To use the tab stop, press the **[TAB]** key, and the carrier will move to the tab position automatically.

Notes:

1. When a tab is to be set in the same position as a decimal tab (see below), the decimal tab in that position will be changed to a normal tab when the **[T SET]** key is pressed.
2. Tab positions are set according to the absolute position of the carrier (in units of 1/60 in.) based on the left edge, so they do not change even when the margins or pitch have been changed.
3. A maximum of 24 tabs, including decimal tabs, can be set on your typewriter.

TAB	TAB	TAB
Low-profile keyboard Impact selection Backspace 1 Right margin flush Auto centering	1, 1.5, 2, line space Auto paper insert Express backspace Bold Typing	Auto relocation 10, 12, 15 pitches Caps lock Decimal tab Auto underlining Word Out

Decimal tabs



This function allows you to type columns of numbers aligned on a decimal point. Decimal tabs are set by moving the carrier to the position at which a decimal tab is desired and holding down the **[CODE]** key then pressing the **[DT SET]** key. When a decimal tab is set, the **LINE LEDs** will blink. To move the carrier to the decimal tab stop, press the **[TAB]** key.

Notes:

1. When a decimal tab is set in the same position as a normal tab, the normal tab in that position will be changed to a decimal tab when the **[CODE]** + **[DT SET]** keys are pressed.
2. Decimal tab positions are set according to the absolute position of the carrier (in units of 1/60 in.) based on the left edge, so they do not change even when the margins or pitch have been changed.
3. A maximum of 24 decimal tabs, including normal tabs, can be set on your typewriter.

D.TAB	D.TAB	D.TAB
65	29.84	1939.60
104	34.97	3636.88
169	64.81	5576.48

Tab clear

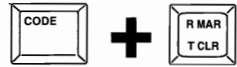

To clear a normal or decimal tab, move the carrier to the position of that tab using the [TAB] key, hold down the [CODE] key and press the [T CLR] key.

All tab clear



Pressing the [REPEAT] key after pressing the [CODE] + [T CLR] keys will clear all normal and decimal tabs, regardless of the position of the carrier.

Notes:

1. If you have selected paragraph indent mode (as described later) and subsequently clear the paragraph indent tab, the tab will be cleared but the typewriter will remain in paragraph indent mode until it is cancelled by holding down [CODE] and pressing [IND CLR].
2. If you move to a decimal tab and clear that tab before typing anything, the tab will be cleared, but any text or numbers subsequently typed will still be printed at the decimal tab position, unless you move to another tab position or press [RETURN].

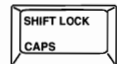

Using Shift and Caps Keys

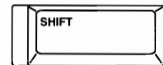

Your typewriter normally prints lower case letters and numerals, plus the punctuation marks and symbols shown on the lower part of other keys. However, you will often want to type upper case letters (for beginning a sentence, etc.) and the symbols shown on the upper part of other keys.

The [SHIFT] and [CAPS LOCK] keys allow you to do this.

Shift

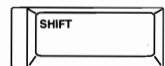

If you hold down either of the [SHIFT] keys, the **SHIFT LED** will light, and you may type upper case letters and the upper characters shown on other keys. Releasing this key automatically returns the keyboard to the lower case mode.

BROTHER ELECTRONIC TYPEWRITER
 Congratulations on becoming the proud owner of a
 Brother Typewriter

Shift lock

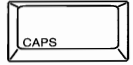

The **SHIFT** function can be locked on by pressing the **[CAPS LOCK]** key, when the **SHIFT LED** will stay lit even if you release the key. To return to lower case typing, press either of the **[SHIFT]** keys.

Caps

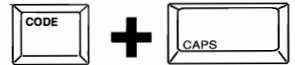

If you want to type upper case letters but want the lower characters on other keys (e.g. numerals), hold down the **[CODE]** key and press the **[CAPS LOCK]** key. The **CAPS LOCK LED** will light while holding down the **[CODE]** key as a reminder that you are in the caps lock mode. To return the keyboard to normal mode, hold down the **[CODE]** key and press the **[CAPS LOCK]** key again.

While the keyboard is in **CAPS** mode you can still access upper characters on non-letter keys by pressing the **[SHIFT]** key or the **[CAPS LOCK]** key. However, pressing the **[CAPS LOCK]** key overrides the **[CAPS]** mode because it sets all keys to upper case or upper character.

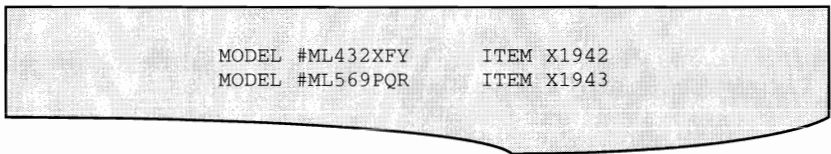

Some keys have characters printed on them in green. These characters are printed by holding down the **[CODE]** key and pressing the appropriate character key.

Backspacing

Your typewriter has three different backspace functions.

Simple backspace



Press the **[BKSP]** key to move the carrier to the left one space at a time. Hold down the **[BKSP]** key to move the carrier continuously to the left.

Express backspace



Holding down the **[CODE]** key and pressing the **[EXPR]** key will bring the carrier immediately back to the left margin.

Backspace I

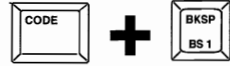

Holding down the [CODE] key and pressing the [BS I] key will move the carrier to the left by 1/60 of an inch. As the distance backspaced remains constant at 1/60 of an inch regardless of the typing pitch being used, backspacing in this case varies by pitch as shown in the following table:

Pitch	Spacing
10	1/6 of a character pitch
12	1/5 of a character pitch
15	1/4 of a character pitch

This function is useful in numerous different ways, including positioning a character or word when the paper has been reinserted into the typewriter, or for typing a character or word into a limited space on the document. See "Insertion And Deletions" in the next section for more information.

Repeat Function



The following functions may be repeated by pressing the [REPEAT] key after pressing the relevant function key.

ALL CHARACTER KEYS

[P IND]

[RETURN]

[BKSP]

[SPACEBAR]

[Permanent Space ([CODE] + [SPACEBAR])]

[INDEX]

[R INDEX]

[CORRECT]

[T CLR]

Auto repeat

In addition to the [REPEAT] key function, the following keys automatically repeat if held down, without using the [REPEAT] key.

[SPACEBAR]

[Permanent space ([CODE] + [SPACEBAR])]

[BKSP]

[CORRECT]

[INDEX]

[R INDEX]

Advanced Typing

This section takes a look at the more advanced features of your typewriter.

Bold

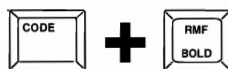

Place your typewriter in the bold typing mode by holding down the [CODE] key and pressing the [BOLD] key. All characters subsequently typed will be printed in bold.

The **BOLD** LED will light while holding down the [CODE] key as a reminder that you are in the bold mode.

Holding down the [CODE] key and pressing the [BOLD] key once again will clear the bold function and return the typewriter to the regular mode.

Note:

This bold function can be performed in the centering, right margin flush, and decimal tab modes.

Automatic Underline



To underline a character, word or sentence, hold down the [CODE] key and press the [UNDLN] key to place your typewriter in the automatic underline mode. While your typewriter is in this mode, all characters and spaces typed will be underlined.

The **UNDLN** LED will light while holding down the [CODE] key as a reminder that you are in the automatic underline mode.

Release the automatic underline mode by holding down the [CODE] key and pressing the [UNDLN] key once again.

Note:

The auto underline function can be performed in the centering, right margin flush, and decimal tab modes.

Expand

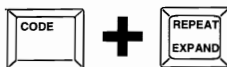

The expand function doubles the amount of space between characters typed in any pitch. To place your typewriter in the expand mode, hold down the [CODE] key and press the [EXPAND] key.

The EXPAND LED will light while holding down the [CODE] key as a reminder that you are in the expand mode.

Your typewriter is released from the expand mode by holding down the [CODE] key and pressing the [EXPAND] key once again.

This letter was typed to show you just some of the many outstanding feats this electronic typewriter can perform.

In fact, you have seen some of these features already in this letter; **Bold**, Underline, and E x p a n d typing can be easily done with this typewriter.

Carrier Return

Your typewriter features both manual and automatic carrier return.

Manual carrier return

Pressing the [RETURN] key returns the carrier to the left margin and advances the paper by the number of lines set with the [LINE] key (1, 1 1/2, 2).

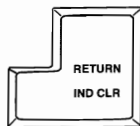

Hot zone

The Hot Zone is an area that begins 6 spaces (regardless of pitch) before the right margin and extends to the right margin. A buzzer will sound as the carrier enters the hot zone to inform you of the fact. Once the buzzer has sounded to warn you, you have the six spaces of the hot zone to end your line by splitting the last word with a hyphen or by moving the word to the next line, if necessary. If you continue to type, the carrier will stop at the right margin and the keyboard, except for the carrier return, will lock. This is to keep you from typing on past the margin, unless, of course, you use the margin release function to continue.

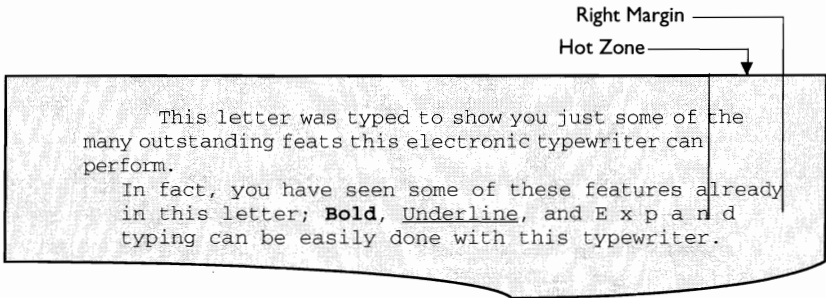

Automatic carrier return



Automatic carrier return saves you having to press the [RETURN] key every time you reach the end of a line. This function works by automatically returning the carrier to the left margin whenever you end a word by pressing the [SPACEBAR] or split a word by pressing the  key with the carrier in the hot zone.

Automatic carrier return is switched on by holding down the [CODE] key and pressing the [AUTO] key. The **AUTO** LED will light while holding down the [CODE] key as a reminder that you are in the automatic carrier return mode.

Holding down the [CODE] key and pressing the [AUTO] key once again releases your typewriter from the automatic carrier return mode.

Note:

If you type up to the right margin with no spaces or hyphens in the hot zone, the carrier will stop at the right margin and will not return automatically. You can use neither the [SPACEBAR] nor the  at the right margin. Press the [RETURN] key to return the carrier or the [M REL] key to continue typing beyond the margin.

Permanent spaces and hyphens

In the automatic carrier return mode, if you wish to type a space or hyphen in the hot zone without the carrier returning automatically, you may use the permanent space and hyphen functions.

To type a permanent space or hyphen, hold down the [CODE] key and press either the [SPACEBAR] or the  key.

Centering



To type centered text, return the carrier to the left margin and press the **[CTR]** key. The carrier will move to a position halfway between the left and right margins and place the machine in the centering mode.

When you type now, the characters will not be printed on the page, but the carrier will move half a space to the left for every character and space you type (except for the first character and the dead characters). In the expand mode the carrier moves one full space to the left for every character and space you type.

When you have finished typing the line, press the **[RETURN]** key or the **[TAB]** key to print the line. After printing, the machine will leave the centering mode. If the **[RETURN]** key was pressed, the carrier will then line feed and return to the left margin. If the **[TAB]** key was pressed, the carrier will remain on the same line, moving to the nearest tab to the right, or, if there is no tab, to the right margin.

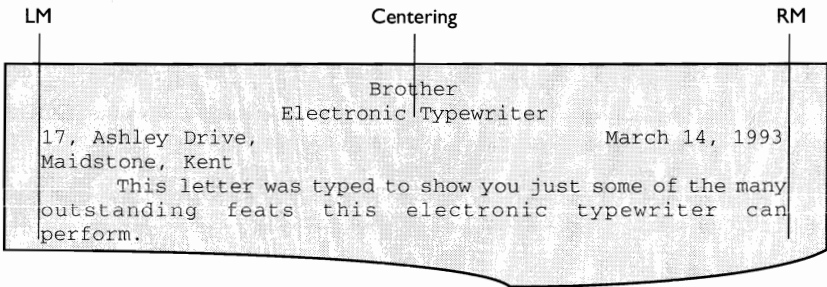

Notes:

1. Corrections in the centering mode may be accomplished by pressing the **[CORRECT]**, **[WORD OUT]** or **[CODE] + [LINE OUT]** keys. This will wipe out all of the data entered since the **[CTR]** key was pressed and return the carrier to the center position.
2. To leave the centering mode before any data has been input, pressing the **[CORRECT]**, **[WORD OUT]** or **[CODE] + [LINE OUT]** keys will release your typewriter from the centering mode and return the carrier to the left margin.

Right Margin Flush



Right margin flush automatically aligns text flush with the right margin. To type text right margin flush, press the **[RMF]** key while the carrier is anywhere to the left of the right

margin. The carrier will move to the right margin, then move one space to the left for every character you subsequently type (two in the expanded mode).

When you have finished typing the line, press the **[RETURN]** key or the **[TAB]** key to print the line. After printing, the machine will leave the right margin flush mode. If the **[RETURN]** key was pressed, the carrier will line feed and return to the left margin. If the **[TAB]** key was pressed, the carrier will remain at the right margin after printing.

Notes:

1. Corrections in the right margin flush mode may be accomplished by pressing the **[CORRECT]**, **[WORD OUT]** or **[CODE] + [LINE OUT]** keys. This will wipe out all of the data entered since the **[RMF]** key was pressed and return the carrier to the right margin.
2. To leave the right margin flush mode before anything has been typed, pressing the **[CORRECT]** or **[CODE] + [LINE OUT]** keys will release your typewriter from the right margin flush mode and relocate the carrier to its previous position.

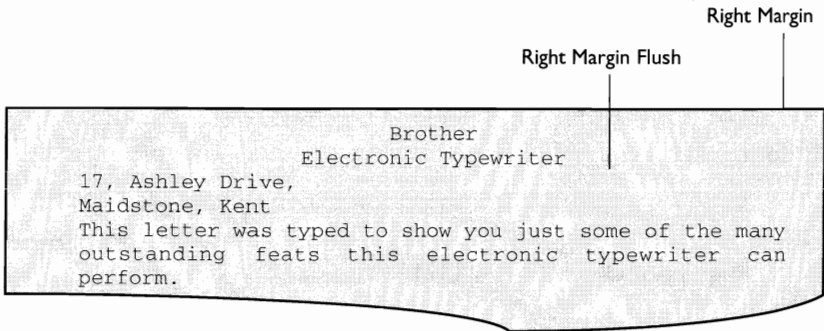

Indentation

Line indentation



The **[L IND]** key allows you to indent the first line of your paragraphs in one step without spacing or setting a tab. With the carrier at the left margin, press the **[L IND]** key and the carrier will automatically move over five spaces and wait for you to begin typing. Each time you press the **[L IND]** key, the carrier will move 5 spaces to the right.

Paragraph indentation



The paragraph indent function will indent an entire paragraph to the position of the next tab, without you having to use the **[TAB]** key at the beginning of each line. First set a tab at the position where you wish the paragraph to begin and move the carrier back to the

left margin, then hold down the [CODE] key and press the [P IND] key. The carrier will move over to the next tab and wait. Thereafter, whenever the carrier return is pressed, the carrier will return to that first tab position rather than the left margin.

Line Indent

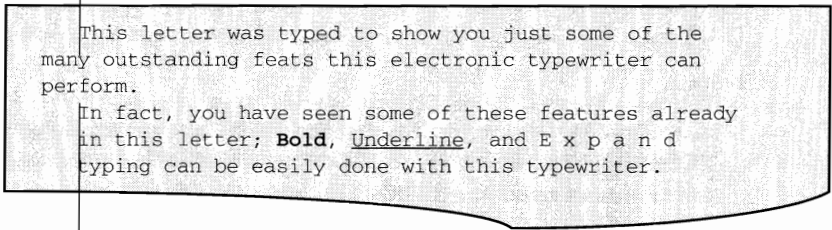

Paragraph Indent

Note:

If you want to type to the left of the paragraph indent point during the paragraph indent mode, simply use the [BKSP] or [CODE] + [EXPR] key to move the carrier to the place where you want to begin typing. To get back to the paragraph indent point after typing from the left margin, press the [RETURN] key.

Indent clear

To clear the paragraph indent mode, hold down the [CODE] key and press the [IND CLR] key. The carrier will now return to the left margin when you press the [RETURN] key.

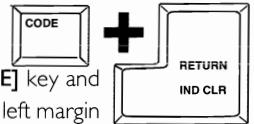

Corrections

Correcting mistakes with your typewriter is made simple by the correction memory and correction tape that allow you to erase incorrect text automatically without having to use messy correction fluid.

Automatic correction

Your typewriter has a one-line correction memory, and automatic correction may be performed anywhere on the current typing line. You can correct character-by-character, all or part of a word, and all or part of a line, automatically.

Character correction



To use automatic correction, move to the character you wish to correct, using the [SPACEBAR] or [BKSP] key.

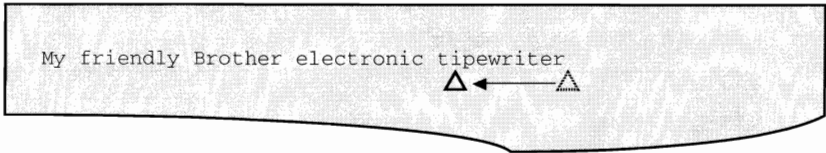

When the carrier is directly over the character to be corrected press the [CORRECT] key. The character will be erased and the carrier will remain in that position.

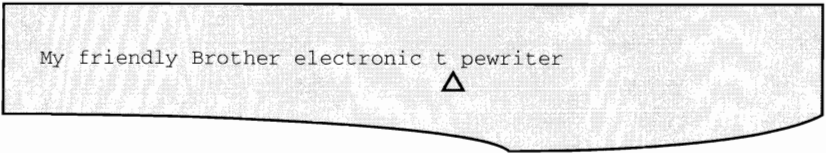

If you want to erase more characters to the left of the one you just erased, press the [CORRECT] key again.

You may type the correct character(s), or move on, as necessary.

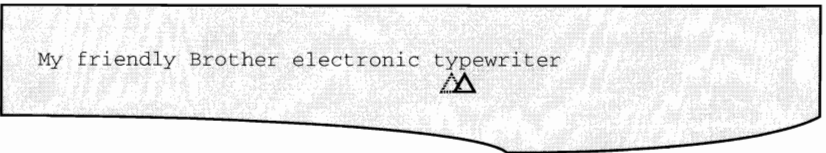

Notes:

1. The automatic correction function works on bold, subscript, superscript, dead, and underlined characters.
2. If you superimpose two characters for any reason, the automatic correction works on only the second character. The first character should be corrected manually.

Word out



The word out function will remove a whole or partial word from your document. First use the [SPACEBAR] or [BKSP] key to move to the word you wish to correct. If you want to erase the whole word, position the carrier on the last character of the word or the space after it. If you want to erase part of the word to the left of the carrier, position the carrier on the last character you wish to correct.

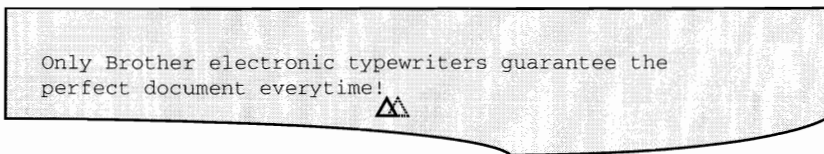

Press the [WORD OUT] key. The typewriter will erase the character at the current carrier position and all characters to the left of it until a space between words is reached.

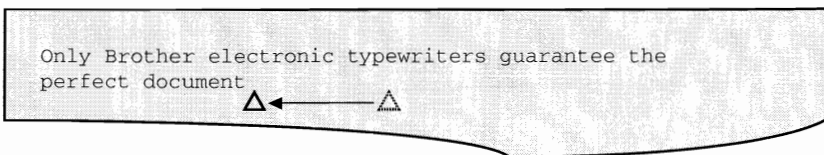

After erasing the word, the carrier will remain at the position of the last character removed and await your corrected input.

Note:

To stop the word out function, simply press the [CORRECT] key.

Line out



This function allows you to erase all or part of the current typing line.

First move the carrier to the position of the last character of the line or portion of the line to be erased, using the [SPACEBAR] or [BKSP] key.

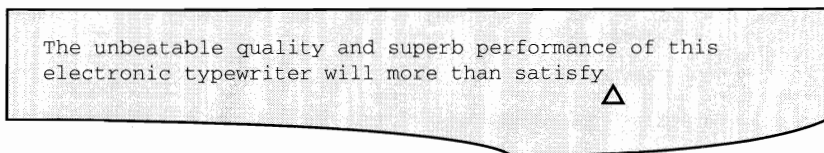

Hold down the **[CODE]** key and press the **[LINE OUT]** key. The typewriter will erase the character at the current carrier position and everything to the left of it.

The carrier will stop at the beginning of the line and await your corrected input.

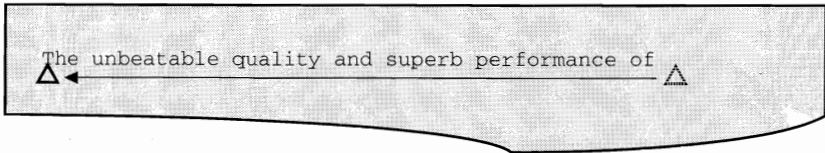

Note:

To stop the line out function, simply press the **[CORRECT]** key.

Insertions and Deletions

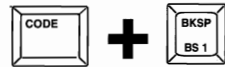

Instead of simply replacing incorrect characters or words, you may wish to insert extra characters, or delete them, or even replace words with different ones. In this case you may find that there is too much or too little space available for the correction to be inserted without running into the next word or leaving a big gap. Using the **[BS 1]** key allows you to balance the spacing of your corrections so that it is not apparent that insertions or deletions have been made.

Insertions

If you try to insert an extra character into a word, you will be left with no space between it and the next word. You can even this up by moving the whole word half a space to the left so that there is a half space on either side of the word.

First use the **[SPACEBAR]** or **[BKSP]** key to move to the last character of the word you wish to correct.

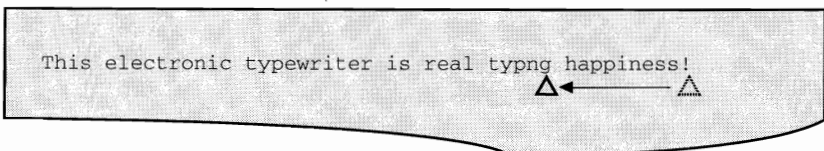

Press the **[WORD OUT]** key to delete the whole word. The carrier will remain at the position of the last character removed.

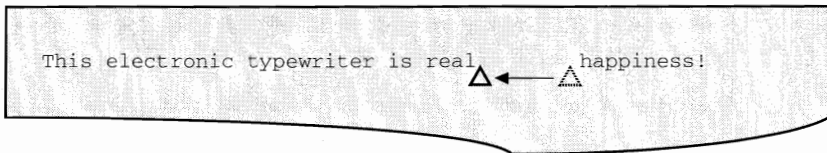

Now hold down the **CODE** key and press the **[BS I]** key. Each time the **[BS I]** key is pressed, the carrier moves 1/60 of an inch to the left.

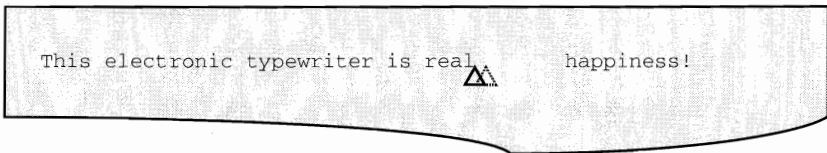

The number of times you need to press the **[BS I]** key for a half space depends on the typing pitch

Pitch	No. of presses
10	3
12	2 or 3
15	2

You may now type in the correct word.

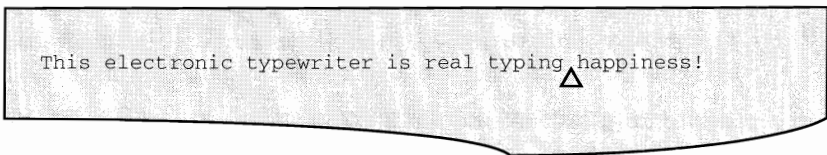

Deletions

If you try to delete a character from a word you will be left with an extra space after the word. You can even this up using the **[BS I]** key so that you have one-and-a-half spaces on either side of the word. First use the **[SPACEBAR]** or **[BKSP]** key to move to the last character of the word you wish to correct.

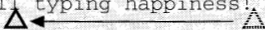
This electronic typewriter is reall typing happiness! 

Press the **[WORD OUT]** key to delete the whole word. The carrier will remain at the position of the last character removed.

This electronic typewriter is  typing happiness!

Now press the **[SPACEBAR]** to move the carrier to the second character of the deleted word. Then backspace half a space using **CODE + [BS I]**.

This electronic typewriter is  typing happiness!

You may now type in the correct word.

This electronic typewriter is real typing happiness! 

The above examples only show the insertion or deletion of a single character. If you wish to insert or delete more than one character, or replace several words with other words, you can use the same principle by deleting several words and using the **[BS I]** key to expand or reduce the spaces between the replacement words.

Relocation



After making automatic corrections, the [RELOC] key allows you to return automatically to where you left off typing before making the correction. However, the [RELOC] key cannot be used if you move off the current typing line, for example to make manual corrections.

Manual correction

You can only perform automatic correction on the current typing line. When you move onto a new line, the correction memory is cleared. Manual correction may be performed at any place on the page.

First move the carrier to the character to be corrected using the [INDEX], [R INDEX], [SPACEBAR], or [BKSP] keys as necessary.

The unbeatable quality and suberb performance
of this electronic typewriter will more than
satisfy your every typing need.

The diagram shows a typewriter keyboard with a cursor (triangle) positioned over the character 'u' in the word 'suberb'. An arrow points from the cursor to the 'u', and another arrow points from the 'u' to the 'e', indicating the movement of the carrier to the character to be corrected.

Hold down the [CODE] key and press the [CORRECT] key. Then press the key for the incorrect character.

That character will be erased and the carrier will remain in that position for you to type in a new character, or move on, as necessary.

The unbeatable quality and su erb performance

The diagram shows the typewriter keyboard with the cursor (triangle) still positioned over the 'u' in 'suberb'. The character 'u' has been erased, leaving a space, and the carrier remains in that position.

Type in the correct character.

The unbeatable quality and superb performance

The diagram shows the typewriter keyboard with the cursor (triangle) still positioned over the 'u' in 'suberb'. The character 'u' has been replaced by the correct character 's', resulting in the word 'superb'.

If you want to correct another character, you must move to that character and use [CODE] + [CORRECT] again.

After finishing your corrections, use the [INDEX], [R INDEX], [SPACEBAR] and [BKSP] keys to return to your original typing position.

Notes:

1. If the [SPACEBAR] is pressed after the [CORRECT] key has been pressed, the correction function is cleared and the carrier will move to the right one space.
2. You cannot use the [RELOC] key to return to your original typing position after making manual corrections.

Subscript and Superscript



As well as moving the paper up and down, the [INDEX] and [R INDEX] keys can be used to place your typewriter in the subscript and superscript modes. The platen will rotate slightly up or down to allow typing of super and subscript characters 1/12 of an inch higher or lower than the base line (see micro indexing below).

To put your typewriter in the superscript mode, press the [R INDEX] key. Any characters you subsequently type will be printed as superscript, until you press the [INDEX] key to move the paper back to the original typing line.

Subscript mode is the reverse of superscript. Press the [INDEX] key to enter subscript typing and the [R INDEX] key to return to the original typing line.

With the Reverse Index key or Index key, you can type 2^3 or H_2O

Notes:

1. Superscript and subscript characters will be typed with an underline, if your typewriter is in the automatic underline mode, and in bold if bold mode is selected.
2. If you press the [INDEX] or [R INDEX] key more than once, the line correction memory will be cleared.
3. If you hold down the [INDEX] or [R INDEX] key, the paper will advance or reverse continuously.

Micro index/micro reverse index

Holding down the [CODE] key and pressing the [INDEX] or [R INDEX] keys will also place your typewriter in the subscript or superscript mode, but the characters typed in this mode will only be 1/48 of an inch above or below the base line.

Note:

The micro [INDEX] and micro [R INDEX] functions will clear the line correction memory.

Memory

Your typewriter is equipped with a memory function to store text for printing out later. You can also store a custom line format, and switch between this and the default line format. The memory is only active when the typewriter is switched on, and memory settings are lost when it is switched off or disconnected from the mains.

Storing a line format



When you switch on your typewriter, it starts off with the following default line format:

Pitch:	Pica (10 pitch)
Line Space:	1
Keyboard:	1
Impact:	Medium
Left Margin:	10
Right Margin:	75
Tabs:	Every 10 Spaces
Hot zone:	6 characters
Start Position:	Approximately 1 inch from top of page

If you change any of these settings, you may wish to save your new line format. To do this, first press the [STORE] key to put the machine into store mode. The three PITCH LEDs will flash to indicate that store mode has been entered.

Now hold down the [CODE] key and press the [FORMAT] key. The three PITCH LEDs will flash again to indicate that your line format has been stored.

Now press the [END] key to take the machine out of store mode. The three PITCH LEDs will flash once more.

Calling a line format from memory



Once you have stored a line format in memory, you can alternate between your custom line format and the default line format by pressing **[CODE]** + **[FORMAT]**.

The first time you press **[CODE]** + **[FORMAT]** the format will revert to the default format. The next time you press **[CODE]** + **[FORMAT]**, your custom format will be recalled. You can toggle between your custom format and the default format as often as you wish, until the machine is switched off, when your custom format will be lost.

Notes:

1. You can change the format at any time, regardless of the carrier position.
2. Whenever you press **[CODE]** + **[FORMAT]**, the carrier will immediately move to the new left margin.
3. The line correction memory will be cleared.

Text memory

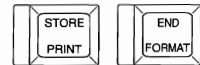

This function allows you to store up to 5500 characters of text in memory, and print it out later. This can be useful if, for example, you wish to send the same letter to several different addresses, as you can type each address then print out the body of the text from the memory.

Only a single document may be stored. You may make later additions to the end of the document, within the 5500 character limit, but once the text has been stored, it is not possible to make changes to it.

The store mode is selected by pressing the **[STORE]** key, after which the three **PITCH LEDs** will blink to confirm that your typewriter has entered the store mode.

Now, using the typewriter as normal, type the text which you wish to store.

When you have finished typing, press the **[END]** key. Your typewriter will now leave the store mode, and the three **PITCH LEDs** will blink again for confirmation.

If you need to add additional text to the end of the file after you have finished, press the **[STORE]** key again and continue typing. This additional text will be added to the end of the file. Remember to press the **[END]** key to exit the store mode.

Correction in store mode

When you are typing in the store mode, automatic corrections can be made to the line you are typing as normal. The only difference is that when the stored text is printed out

from memory, the typewriter does not make the mistakes you made. It prints the text correctly the first time.

It is important to note that each line of text is stored if the [RETURN], [END] or [PINS] key is pressed, when the [INDEX] or [R INDEX] key is pressed twice in a row or when the [CODE] + [IND CLR] keys are pressed in the paragraph indent mode. The three PITCH LEDs will blink to indicate the entry of data into the memory.

After a line of text is stored, any (manual) corrections you subsequently make to it will not be stored in memory, so try to make sure each line is correct before it is stored.

Notes:

1. The text memory stores no line format information except the pitch of the typed text. Margins, line spacing and print impact must be set before you print the text from memory.
2. When you use the [TAB] key in store mode, the carrier movement from the end of the previous word to the tab position is stored as spaces in memory. Therefore, the text will print from memory with the original tab positions, even if you change the tab positions on the typewriter before printing.
3. When the memory is full, a buzzer will sound to warn you of the fact. No more data can be stored, but normal typing may be continued.
4. When there is data previously stored into the memory, any new text stored will be added on to the end of that text.

Printing text from memory



Data stored in the text memory may be printed directly from memory using the print mode. First set the margins, line spacing, and impact, then hold down the [CODE] key and press the [PRINT] key to print the stored text. When the printout is complete, your typewriter will automatically leave the print mode.

Printing may be stopped in progress by pressing the [END] key. Printing will cease immediately and the carrier will return.

Notes:

1. Printing may be temporarily suspended while in progress by pressing the [SPACEBAR]. The carrier will complete the line being printed when the [SPACEBAR] was pressed, carrier return, and then pause (the three PITCH LEDs will blink during the pause interval). Printing may be resumed by holding down the CODE key and pressing the [PRINT] key again.

2. Holding down the [CODE] key and pressing the [PRINT] key will print the entirety of the text stored in memory and may not be used to print only a portion of the file. Printing will start at the beginning of the file and continue to the end unless stopped in progress.
3. For printing from memory, you must set the left and right margins so that the distance between them is equal to or greater than that when you originally typed the text. If it is not, printing will stop when the right margin is reached.

Removing text from memory

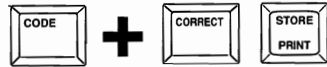

The text memory may be erased by pressing [CODE] + [CORRECT] followed by the [STORE] key. This will erase the entire content of the text memory and place your typewriter into the store mode, ready to store new text.

You must always clear the previously stored text before you begin new text. If you do not, the text you enter will be added to the end of the previously stored text.

Clearing the memory

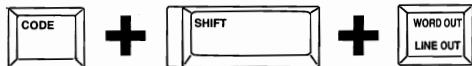

To clear the memory, hold down the [CODE] and [SHIFT] keys and press the [WORD OUT] key. This will clear the text memory and also reset the line format to the default values.

Note:

Switching the typewriter off will also clear the memory and reset the line format to the default values.

Maintenance and Troubleshooting

Your Brother electronic typewriter has been precision manufactured to give you years of trouble-free use with the minimum of routine maintenance. In the unlikely event that your typewriter fails to work correctly, the troubleshooting guide will help you to find the cause of the problem. If the steps suggested in the troubleshooting guide fail to cure the problem, please do not attempt to repair the typewriter yourself. Instead, please contact your nearest Brother dealer.

Maintenance

Environment

Your typewriter dislikes direct sunlight, excessive heat from heaters or radiators, dust and humidity.

Keep it in a cool dry, dust-free environment, and keep it covered when not in use. Do not obstruct the ventilation slots at the back of the typewriter, and do not cover them with a dust cover when the power is switched on.

You should mount the typewriter on a flat, stable surface, with easy access to a power socket.

Cleaning

The keyboard and print mechanism of your typewriter dislike dirt and foreign objects such as pins, paperclips, food and hair.

Maintenance simply consists of keeping your typewriter clean inside and outside, removing any foreign debris, and keeping the machine covered when not in use.

You should clean the typewriter with a soft cloth, and you may clean the keyboard with a proprietary keyboard cleaner, used sparingly. You should not use water, alcohol, thinners or any other solvents.

Do not attempt to push anything into the ventilation slots at the back of the typewriter, or into any other openings in the case.

Should the platen become dirty, you can remove it from the typewriter in order to clean it. First center the printing carrier, then simply lift the cover, pinch the black tabs to the left and right of the platen and lift it out. Put it back in the same way.

Supplies

For best results, use only Brother brand cassette daisy wheels, cassette ribbons and correction ribbons.

After all, only the best is good enough for your Brother typewriter!

Troubleshooting

PROBLEM	POSSIBLE CAUSE	ACTION
1. Nothing works!	<ol style="list-style-type: none"> 1. Typewriter not plugged in 2. Typewriter not switched on 3. Cover not properly closed 	<p>Plug it in!</p> <p>Switch it on!</p> <p>Close it!</p>
2. It still doesn't work!	<ol style="list-style-type: none"> 1. Mains socket not working 2. Blown fuse in plug 	<p>Check using another appliance</p> <p>Check and replace if necessary. Contact your dealer if problem recurs</p>
3. Characters do not print or are faint	<ol style="list-style-type: none"> 1. Daisy wheel inserted incorrectly 2. Cassette ribbon has run out 3. Cassette ribbon inserted incorrectly 4. Impact setting too light 5. Paper thickness lever in up position 	<p>Re-insert correctly</p> <p>Replace</p> <p>Re-insert correctly</p> <p>Change setting</p> <p>Push it down</p>
4. Characters are missing	<ol style="list-style-type: none"> 1. Daisy wheel has broken petal 	<p>Replace daisy wheel</p>
5. Correction does not work	<ol style="list-style-type: none"> 1. Correction tape has run out 2. Correction tape installed incorrectly or back to front 3. Wrong type of correction tape 	<p>Replace</p> <p>Re-install correctly</p> <p>Use correct type to suit the cassette ribbon</p>
6. PITCH LEDs are blinking	<ol style="list-style-type: none"> 1. You have paused printing from memory. 	<p>Press [CODE] + [PRINT] to resume</p>

* For additional assistance in operating, maintaining or servicing your unit, please contact your Authorized Brother Dealer.

Specifications

Printing Method	Cassette daisy wheel (96 characters)
Printing Speed	16 characters per second
Typing Pitches	10 (maximum 117 characters per line) 12 (maximum 140 characters per line) 15 (maximum 175 characters per line)
Line Spacing	Single (6 lines per inch) 1 1/2 (4 lines per inch) Double (3 lines per inch)
Paper Capacity	15 inches
Typing Capacity	11.7 inches
Correction Memory	One line
Copy Capacity	Original + 4 copies
Cassette ribbon	Correctable film ribbon (standard equipment) One-time film ribbon Multi-strike film ribbon Nylon ribbon
Correction tape	Lift-off correction tape (standard equipment) Cover-up correction tape
Text Memory	5.5K (approx. 5500 characters)
Power Consumption	52 W
Dimensions	18.35" (W) x 16.15" (D) x 5.35" (H)
Weight	16.75 lb

Specifications are subject to change without notice.

Keyboard Layout (Version 1)

SHIFT AND CAPS INDICATOR*

Lights when the shift key is pressed or the shift lock key has been pressed./* Indicates if the CAPS key has been pressed.

LINE SPACING, AUTO AND PARAGRAPH INDICATORS* Indicate the line spacing of AUTO CARRIER RETURN AND INDENT modes.

MARGIN RELEASE KEY
Releases the margin stops.

LEFT MARGIN KEY/ AUTO CARRIER RETURN*
Sets a new left margin at the current carrier position./*Selects auto carrier return.

PITCH, UNDERLINE, BOLD AND EXPAND INDICATORS*
Indicate the typing pitch./*Show the status of UNDERLINE, BOLD or EXPAND modes.

KEYBOARD STATUS*
*Used to select International or

LINE INDENT
Activates the line indent mode.

CENTRING/ UNDERLINE*
Activates the centring mode./*Activates automatic underline.

RIGHT MARGIN FLUSH/BOLD*
Activates the RIGHT MARGIN FLUSH mode./*Activates bold printing.

LINE SPACING
Press repeatedly to cycle through the three line space settings.

RIGHT MARGIN KEY/ TAB CLEAR*
Sets a new right margin at the current carrier position./*Clears a tab.

PITCH KEY
Press repeatedly to cycle through the three typing pitch settings.

REPEAT/EXPAND*
Activates the REPEAT function./*Activates EXPANDED printing.

TAB/PARAGRAPH INDENT*
Moves the printing carrier to the next tab position./*Indents the paragraph.

SHIFT LOCK/CAPS LOCK*
Locks the keyboard into shift mode./*Locks the keyboard into CAPS mode.

SHIFT
Puts the keyboard into the shift mode as long as this key is held down.

CODE
Used to function green, a character green or keyboard

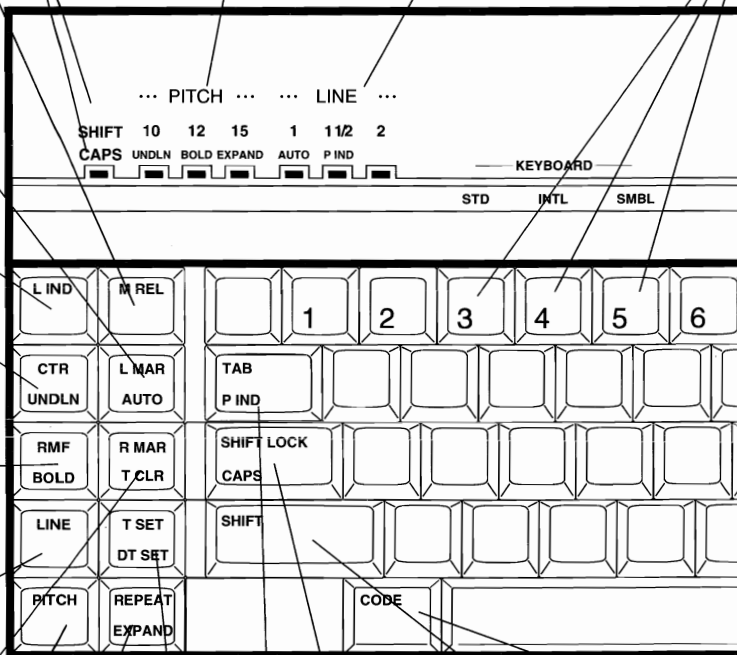

*Note: The functions identified by a

BACKSPACE/MICRO BACKSPACE*

Backspaces one character/

*Backspaces 1/60 inch.

IMPACT SELECTION*

*Used to select typing impact, light, medium or heavy.

RELOCATE/EXPRESS BACKSPACE*

Relocates the carrier to the original typing position after making corrections on the current typing line/**Moves the carrier to the left margin.

PAPER INSERT/START SET

Advances the platen to insert paper automatically/**Moves the paper to the start position.

REVERSE INDEX/ REVERSE MICRO INDEX*

This key moves up the page (moves the paper down) by 1/12 inch/**1/48 inch.

INDEX/MICRO INDEX

This key moves down the page (moves the paper up) by 1/12 inch/**1/48 inch.

STORE/PRINT
Stores a line format or text in memory/
*Prints text from memory.

END/FORMAT*
Ends use of the memory mode/
*Switches the line format between the default format and the current format.

AUTOMATIC/MANUAL CHARACTER CORRECTION*
Use for automatic character correction/Used for manual correction.

CARRIER RETURN/INDENT CLEAR*
Returns the printing carrier and advances one line/**Clears the paragraph indent mode.

WORD OUT/LINE OUT*
Used to delete a word/
*Used to delete a line.

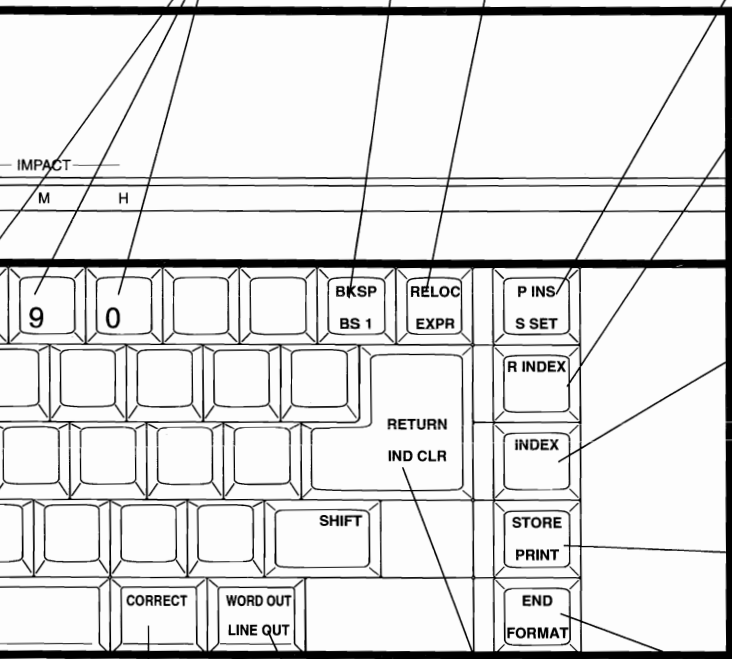

AR
e carrier one
the right each
pressed.

with the [CODE] key held down

Keyboard Layout (Version 2)

SHIFT AND CAPS INDICATOR*

Lights when the shift key is pressed or the shift lock key has been pressed./* Indicates if the CAPS key has been pressed.

LINE SPACING, AUTO AND PARAGRAPH INDICATORS* Indicate the line spacing of AUTO CARRIER RETURN AND INDENT modes.

MARGIN RELEASE KEY
Releases the margin stops.

LEFT MARGIN KEY/ AUTO CARRIER RETURN*
Sets a new left margin at the current carrier position./*Selects auto carrier return.

PITCH, UNDERLINE, BOLD AND EXPAND INDICATORS*
Indicate the typing pitch./*Show the status of UNDERLINE, BOLD or EXPAND modes.

KEYBOARD
*Used to select International

LINE INDENT
Activates the line indent mode.

CENTRING/ UNDERLINE*
Activates the centring mode./*Activates automatic underline.

RIGHT MARGIN FLUSH/BOLD*
Activates the RIGHT MARGIN FLUSH mode./*Activates bold printing.

LINE SPACING
Press repeatedly to cycle through the three line space settings.

RIGHT MARGIN KEY/ TAB CLEAR*
Sets a new right margin at the current carrier position./*Clears a tab.

PITCH KEY
Press repeatedly to cycle through the three typing pitch settings.

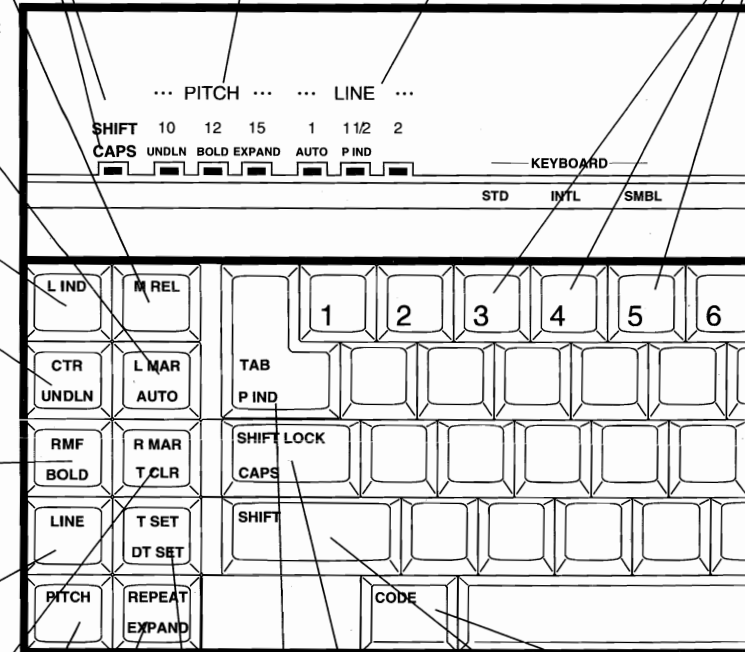

TAB SET/DECIMAL TAB SET*
Sets a tab./*Sets a decimal tab.

SHIFT LOCK/CAPS LOCK*
Locks the keyboard into shift mode./*Locks the keyboard into CAPS mode.

SHIFT
Puts the keyboard into the shift mode as long as this key is held down.

CODE
Used to function green, character green, keyboard

REPEAT/EXPAND*
Activates the REPEAT function./*Activates EXPANDED printing.

TAB/PARAGRAPH INDENT*
Moves the printing carrier to the next tab position./*Indents the paragraph.

*Note: The functions identified by :

BACKSPACE/MICRO BACKSPACE*

Backspaces one character/
*Backspaces 1/60 inch.

IMPACT SELECTION*

*Used to select typing impact, light, medium or heavy.

RELOCATE/EXPRESS BACKSPACE*

Relocates the carrier to the original typing position after making corrections on the current typing line/*Moves the carrier to the left margin.

PAPER INSERT/START SET

Advances the platen to insert paper automatically/*Moves the paper to the start position.

REVERSE INDEX/ REVERSE MICRO INDEX*

This key moves up the page (moves the paper down) by 1/12 inch/*1/48 inch.

INDEX/MICRO INDEX

This key moves down the page (moves the paper up) by 1/12 inch/*1/48 inch.

STORE/PRINT
Stores a line format or text in memory/
*Prints text from memory.

END/FORMAT*
Ends use of the memory mode/
*Switches the line format between the default format and the current format.

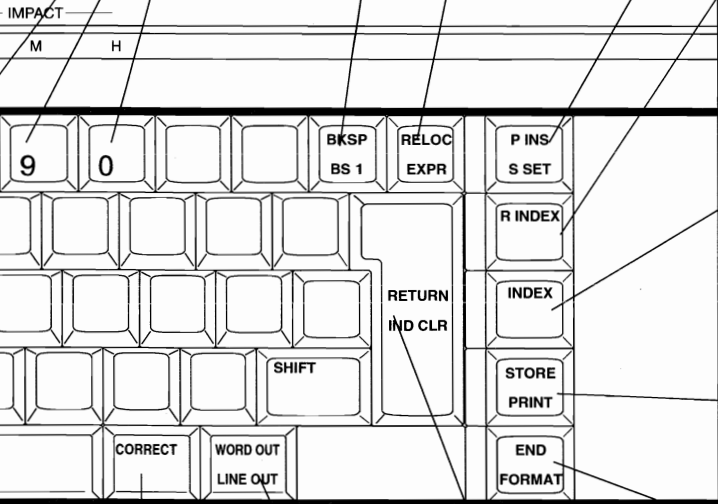

AUTOMATIC/MANUAL CHARACTER CORRECTION*
Use for automatic character correction/Used for manual correction.

CARRIER RETURN/INDENT CLEAR*
Returns the printing carrier and advances one line/*Clears the paragraph indent mode.

WORD OUT/LINE OUT*
Used to delete a word/
*Used to delete a line.

R
carrier one
the right each
pressed.

with the [CODE] key held down

Index

A

Acoustic cover	5
All tab clear	23
Advanced typing	27
Auto carrier return	29
Auto paper insert	13
Auto repeat	26
Auto underline	27
Automatic correction	32

B

Backspacing	24
Basic typing functions	13
Bold	27

C

Caps	24
Carrier return	28
Cassette daisy wheel, removing	7
Cassette daisy wheel, inserting	8
Cassette daisy wheel	7
Cassette ribbon, removing	9
Cassette ribbon, inserting	9
Cassette ribbon	8
Centering	30
Character correction	33
Cleaning	44
Code key	18
Correction in store mode	41
Correction tape, removing	11
Correction tape, inserting	11
Correction tape	10
Corrections	32

D

Dead keys	18
Decimal tabs	22
Deletions	36

E

Environment	44
Expand	28
Express backspace	24
Extra characters	18

G

General view	3
--------------------	---

H

Hot zone	28
----------------	----

I

Indent clear	32
Indentation	31
Insertions	35
Insertions and deletions	35

K

Keyboard (Version 1)	16
Keyboard (Version 2)	16a
Keyboard Layouts	48, 50
Keyboard Symbol	16b

L

Left margin, setting	20
Line format memory	41
Line indentation	31
Line out	34

M	
Maintenance	44
Manual carrier return	28
Manual correction	38
Manual paper insert	14
Margin release	20
Margin scale	5
Margins	20
Memory	40
Micro backspace	25
Micro index/reverse micro index	40
N	
Normal tabs	21
P	
Paper support	4
Paper thickness control	15
Paragraph indentation	31
Permanent spaces and hyphens	29
Power switch	6
Preset margins	20
Printing text from memory	42
R	
Relocation	38
Removing text from memory	43
Repeat function	25
Right margin, setting	20
Right margin flush	30
S	
Selecting keyboard	17
Setting and using tabs	21
Setting impact	15
Setting left margin	20
Setting line space	18
Setting margins	20
Setting right margin	20
Setting start position	15

Setting typing pitch	19
Setting up the typewriter	3
Shift	23
Shift lock	24
Simple backspace	24
Specifications	47
Storing a line format	40
Subscript and superscript	39
Supplies	45

T

Tab clear	23
Tabs, normal	21
Tabs, decimal	22
Text memory	41
Top cover, opening	5
Top cover, closing	6
Top cover	5
Troubleshooting	46

W

Word out	34
----------------	----

IMPORTANT!

REMOVE THE PACKING PIECES AS SHOWN BEFORE USING THE TYPEWRITER

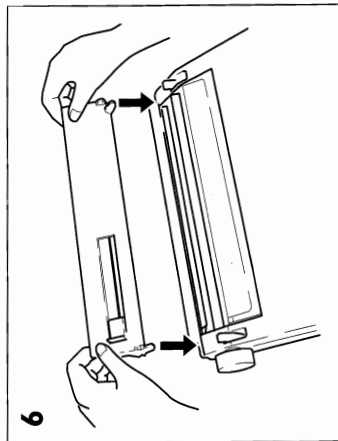
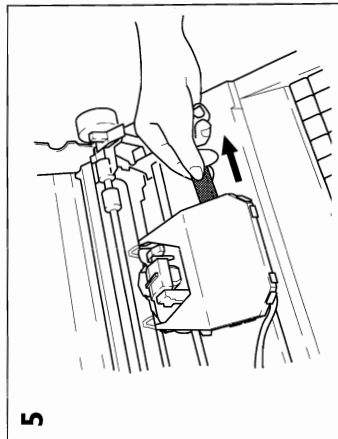
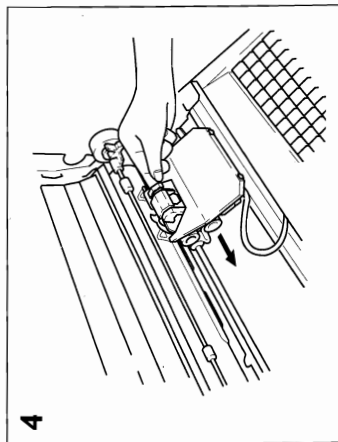
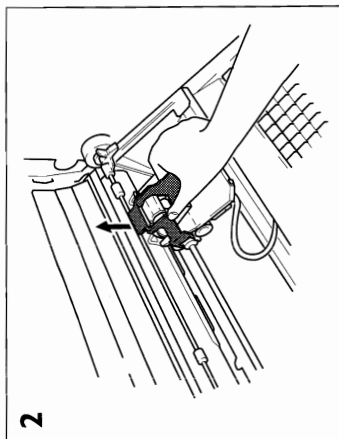
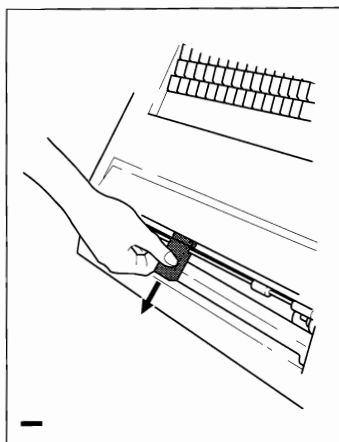

Free Manuals Download Website

<http://myh66.com>

<http://usermanuals.us>

<http://www.somanuals.com>

<http://www.4manuals.cc>

<http://www.manual-lib.com>

<http://www.404manual.com>

<http://www.luxmanual.com>

<http://aubethermostatmanual.com>

Golf course search by state

<http://golfingnear.com>

Email search by domain

<http://emailbydomain.com>

Auto manuals search

<http://auto.somanuals.com>

TV manuals search

<http://tv.somanuals.com>