

BUSH HOG®

COMMERCIAL SERIES

Zero Turn Mower Operator's Manual



BUSH HOG®
Performance You Can Count OnSM

ASSEMBLY ● OPERATION ● MAINTENANCE

CONGRATULATIONS!

You have invested in the best mower of its type on the market today.

The care you give your Bush Hog mower will greatly determine your satisfaction with its performance and its service life. We urge a careful study of this manual to provide you with a thorough understanding of your new implement before operating, as well as suggestions for operation and maintenance.

If your manual should become lost or destroyed, Bush Hog will be glad to provide you with a new copy. Order from Bush Hog, P. O. Box 1039, Selma, Alabama 36702-1039. Most of our manuals can also be downloaded from our website at www.bushhog.com.

As an authorized Bush Hog dealer, we stock genuine Bush Hog parts which are manufactured with the same precision and skill as our original equipment. Our trained service personnel are well informed on methods required to service Bush Hog equipment, and are ready and able to help you.

Should you require additional information or assistance, please contact us.

YOUR AUTHORIZED
BUSH HOG DEALER

BECAUSE BUSH HOG MAINTAINS AN ONGOING PROGRAM OF PRODUCT IMPROVEMENT, WE RESERVE THE RIGHT TO MAKE IMPROVEMENTS IN DESIGN OR CHANGES IN SPECIFICATIONS WITHOUT INCURRING ANY OBLIGATION TO INSTALL THEM ON UNITS PREVIOUSLY SOLD.

BECAUSE OF THE POSSIBILITY THAT SOME PHOTOGRAPHS IN THIS MANUAL WERE TAKEN OF PROTOTYPE MODELS, PRODUCTION MODELS MAY VARY IN SOME DETAIL. IN ADDITION, SOME PHOTOGRAPHS MAY SHOW SHIELDS REMOVED FOR PURPOSES OF CLARITY. **NEVER OPERATE** THIS IMPLEMENT WITHOUT ALL SHIELDS IN PLACE.

COMMERCIAL SERIES ZERO TURN RIDING MOWER

TABLE OF CONTENTS

SECTION	PAGE	SECTION	PAGE
Warranty	2	Battery	16
Dealer Preparation Check List	3	Tires	16
Safety Alert Symbols	4	Mower Blades	16
Safety Precautions	5	Motion Control Adjustment	17
Federal Laws and Regulations	8	Drive Adjustments	17
I INTRODUCTION AND DESCRIPTION	9	Test Drive Operations	17
Introduction	9	Leveling The Deck	18
Description	9	Counterbalance Spring	18
Specifications	10	Deck Belt Adjustment	18
II OPERATION	11	Deck Belt Replacement	18
General Safety	11	Start Up Maintenance	19
Pre-Operation Checklist	11	Troubleshooting	120
Operation	12	IV ASSEMBLY	21
Mowing Recommendations	14	Wiring Schematics	22
III MAINTENANCE	15	Safety Decals	24
Maintenance Schedule	15	Torque Specifications	26
Engine	16	Optional Equipment List	27
		Slope Angle Guide	28

RETAIL CUSTOMER'S RESPONSIBILITY UNDER THE BUSH HOG WARRANTY

It is the Retail Customer and/or Operator's responsibility to read the Operator's Manual, to operate, lubricate, maintain and store the product in accordance with all instructions and safety procedures. Failure of the operator to read the Operator's Manual is a misuse of this equipment.

It is the Retail Customer and/or Operator's responsibility to inspect the product and to have any part(s) repaired or replaced when continued operation would cause damage or excessive wear to other parts or cause a safety hazard.

It is the Retail Customer's responsibility to deliver the product to the authorized Bush Hog Dealer, from whom he purchased it, for service or replacement of defective parts which are covered by warranty. Repairs to be submitted for warranty consideration must be made within forty-five (45) days of failure.

It is the Retail Customer's responsibility for any cost incurred by the Dealer for traveling to or hauling of the product for the purpose of performing a warranty obligation or inspection.



COMMERCIAL ZERO TURN RIDING MOWER LIMITED WARRANTY



Bush Hog warrants to the original purchaser of this new Zero Turn Riding Mower, purchased from an authorized Bush Hog dealer, that the equipment be free from defects in material and workmanship for a period of three (3) years from date of retail sale. The three year limited warranty (third year parts only) includes drive train, electromagnetic clutch, deck and cutter spindles. See dealer for complete details. The obligation of Bush Hog to the purchaser under this warranty is limited to the repair or replacement of defective parts. **NOTE: This warranty covers parts and labor for the first two years and parts only during the third year.**

Replacement or repair parts installed in the equipment covered by this limited warranty are warranted for ninety (90) days from the date of purchase of such part or to the expiration of the applicable new equipment warranty period, whichever occurs later. Warranted parts shall be provided at no cost to the user at an authorized Bush Hog dealer during regular working hours. Bush Hog reserves the right to inspect any equipment or parts which are claimed to have been defective in material or workmanship.

DISCLAIMER OF IMPLIED WARRANTIES & CONSEQUENTIAL DAMAGES

Bush Hog's obligation under this limited warranty, to the extent allowed by law, is in lieu of all warranties, implied or expressed, **INCLUDING IMPLIED WARRANTIES OF MERCHANTABILITY AND FITNESS FOR A PARTICULAR PURPOSE** and any liability for incidental and consequential damages with respect to the sale or use of the items warranted. Such incidental and consequential damages shall include but not be limited to: transportation charges other than normal freight charges; cost of installation other than cost approved by Bush Hog; duty; taxes; charges for normal service or adjustment; loss of crops or any other loss of income; rental of substitute equipment, expenses due to loss, damage, detention or delay in the delivery of equipment or parts resulting from acts beyond the control of Bush Hog.

THIS LIMITED WARRANTY SHALL NOT APPLY:

1. To transportation to and from dealership or service calls made by dealers, ie, driving time, towing, pickup and delivery.
2. To vendor items which carry their own warranties, such as engines, batteries, tires, and tubes.
3. If the unit has been subjected to misapplication, abuse, misuse, negligence, fire or other accident.
4. If parts not made or supplied by Bush Hog have been used in connection with the unit, if, in the sole judgement of Bush Hog such use affects its performance, stability or reliability.
5. If the unit has been altered or repaired outside of an authorized Bush Hog dealership in a manner which, in the sole judgement of Bush Hog, affects its performance, stability or reliability.
6. To normal maintenance service and normal replacement items such as gearbox lubricant, hydraulic fluid, worn blades, or to normal deterioration of such things as belts and exterior finish due to use or exposure.
7. To expendable or wear items such as teeth, chains, sprockets, belts, springs and any other items that in the company's sole judgement is a wear item.

NO EMPLOYEE OR REPRESENTATIVE OF BUSH HOG IS AUTHORIZED TO CHANGE THIS LIMITED WARRANTY IN ANY WAY OR GRANT ANY OTHER WARRANTY UNLESS SUCH CHANGE IS MADE IN WRITING AND SIGNED BY BUSH HOG'S SERVICE MANAGER, POST OFFICE BOX 1039, SELMA, ALABAMA 36702-1039.



Record the model number, serial number and date purchased. This information will be helpful to your dealer if parts or service are required.

MODEL NUMBER _____

MAKE CERTAIN THE WARRANTY REGISTRATION CARD HAS BEEN FILED WITH BUSH HOG/
SELMA, ALABAMA

SERIAL NUMBER _____

DATE OF RETAIL SALE _____

DEALER PREPARATION CHECK LIST

COMMERCIAL ZERO TURN RIDING MOWER

BEFORE DELIVERING MACHINE — The following check list should be completed.
Use the Operator's Manual as a guide.

- 1. Engine has been serviced.
- 2. Battery fluid level is checked.
- 3. Low oil pressure warning buzzer checked for operation.
- 4. Operator interlock switches checked for operation.
- 5. Assembly completed.
- 6. All fittings lubricated.
- 7. Hydraulic Reservoir filled with oil.
- 8. All shields in place and in good condition.
- 9. Roll-over Protective Structure is installed and retractable seat belt functions properly.
- 10. All fasteners torqued to specifications given in Torque Chart.
- 11. All decals in place and readable. (See decal page.)
- 12. Overall condition good (i.e. paint, welds)
- 13. Parking brake checked and adjusted, if necessary.
- 14. Steering checked and adjusted, if necessary.
- 15. Check tire pressure.
- 16. Operators manual has been delivered to owner and he has been instructed on the safe and proper use of the cutter.

Dealer's Signature _____

Purchaser's Signature _____

THIS CHECKLIST TO REMAIN IN OWNER'S MANUAL

It is the responsibility of the dealer to complete the procedures listed above before delivery of this implement to the customer.

WARRANTY REGISTRATION AND DELIVERY REPORT

It is the responsibility of the Dealer to do the following:

- Complete the Warranty Registration and Delivery Report
- Return the pre-addressed card copy to Bush Hog, L.L.C.
- Retain pink copy for dealership records

Safety Alert Symbol



This Safety Alert Symbol means: “**ATTENTION! BECOME ALERT! YOUR SAFETY IS INVOLVED!**”

This symbol is used to call attention to safety precautions that should be followed by the operator to avoid accidents. When you see this symbol, carefully read the message that follows and heed its advice. Failure to comply with safety precautions could result in death or serious bodily injury.

Safety Signs Signal Words

The signal words **DANGER**, **WARNING**, and **CAUTION** are used on the equipment safety signs. These words are intended to alert the viewer to the existence and the degree of hazard seriousness.



DANGER

White letters on **RED**

This signal word indicates a potentially hazardous situation which, if not avoided, will result in death or serious injury.



WARNING

Black letters on **ORANGE**

This signal word indicates a potentially hazardous situation which, if not avoided, could result in death or serious injury

It may also be used to alert against unsafe practices.



CAUTION

Black letters on **YELLOW**

This signal word indicates a potentially hazardous situation exist which, if not avoided, may result in minor or moderate injury.

It may also be used to alert against unsafe practices.

IMPORTANT SAFETY PRECAUTIONS

This symbol is used to call attention to safety precautions that should be followed by the operator to avoid accidents. When you see this symbol, carefully read the message that follows and heed its advice. Failure to comply with safety precautions could result in serious bodily injury.



In addition to the design and configuration of equipment, hazard control and accident prevention are dependent upon the awareness, concern, prudence and proper training of personnel in the operation, transport, maintenance and storage of equipment. Lack of attention to safety can result in accident, personal injury, reduction of efficiency and worst of all—loss of life. Watch for safety hazards and correct deficiencies promptly. Use the following safety precautions as a general guide to safe operations when using this machine. Additional safety precautions are used throughout this manual for specific operating and maintenance procedures. Read this manual and review the safety precautions often until you know the limitations.

ACCIDENT PATTERNS TO AVOID

1. CONTACT WITH THE ROTATING BLADE - This accident usually happens when the operator is clearing the discharge chute of grass, (especially when the grass is wet), or when the operator adjusts the machine without turning it off and waiting for the blades to completely stop.
2. PROPELLED OBJECTS - Sticks, rocks, wires, and other objects can be propelled out through the discharge chute or from under the mower housing. Bystanders are particularly vulnerable.
3. GRASS DISCHARGE CHUTE - The mower shall not be operated without the grass discharge chute in its lowered position.
4. OVERTURNING - This happens when riding mowers are used on steep slopes, embankments or hills. The operator in these cases can come in contact with blades or sustain injuries during a fall.
5. MOWER RUNNING OVER THE VICTIM - This usually happens when a riding mower is driven in reverse. The accident victims are most often young children whom, unseen by the operator of the mower, were in the area being mowed.

WE SHARE YOUR DESIRE TO PROTECT YOURSELF, YOUR FAMILY, YOUR FRIENDS AND YOUR NEIGHBORS FROM ACCIDENTAL INJURY. OBSERVING AND ENFORCING THE FOLLOWING GUIDE LINES WILL HELP TO INSURE THE SAFETY OF EVERYONE.

SAFETY INSTRUCTIONS AND RECOMMENDATIONS

1. PEOPLE WHO OPERATE, SERVICE, OR ARE OTHERWISE ASSOCIATED with the Zero Turning Riding Mower should be trained in its proper use and warned of its dangers. Before operating, adjusting, or servicing the Zero Turning Riding Mower they should read and understand this entire manual and the engine manual.
2. AVOID CONTACT WITH MOVING PARTS. Keep hands and feet from under mowing deck and away from blades at all times. Turn engine (motor) off if you must unclog the chute.
3. AVOID HILLS AND SLOPES. Use **EXTREME** caution when mowing and/or turning on slopes as loss of traction and/or tip-over could occur. Drive slower on slopes. **DO NOT** mow slopes greater than 15 degrees. Watch for ditches, holes, rocks, dips and rises, which change the operating angle. Keep away from drop-offs and steep banks. Avoid sudden starts when mowing uphill - mower may tip backwards. Loss of traction may occur going downhill - weight transfer to the front wheels may cause drive wheels to slip and cause loss of braking. **DO NOT** mow slopes when grass is wet - slippery conditions affect steering and reduce traction and braking. The operator is responsible for safe operation on slopes.
4. DISENGAGE POWER TO MOWER BEFORE BACKING UP. Do not mow in reverse unless absolutely necessary and then only after turning around and observing the entire area behind the mower. Go slowly. Most "running over victim" accidents occur in reverse.
5. BEGINNING OPERATORS SHOULD LEARN HOW TO STEER the Zero Turning Riding Mower before attempting to mow. Start with slow engine speed and drive without the blades engaged in open area until comfortable with the machine.

SAFETY CONTINUED

6. **KNOW HOW TO STOP QUICKLY.** Know the location and operation of every control, especially how to brake and how to disengage the mower blades.
7. **DO NOT MOVE THE CONTROL LEVERS** from forward position to reverse position rapidly. The speed and/or direction of travel is affected instantly by movement of the Control Levers.
8. **DO NOT ALLOW CHILDREN TO OPERATE MOWER.** Do not allow others who have not had instructions to operate mower. Do not operate the mower when children or others are in the area.
9. **ALWAYS TURN ENGINE OFF AND REMOVE KEY** before leaving mower to prevent children and inexperienced operators from starting the engine. Never leave the mower unattended with engine running. Always wait for all moving parts and all sounds to stop before leaving operator's seat. Always set the parking brake on an unattended mower.
10. **WEAR STURDY, ROUGH-SOLED WORK SHOES AND CLOSE-FITTING TROUSERS AND SHIRTS.** Never operate mower in bare feet, sandals or sneakers.
11. **WEAR PERSONAL PROTECTIVE EQUIPMENT** such as, but not limited to, protection for eyes, ears, feet, hands and head when operating or repairing equipment. Do not wear loose clothing or jewelry that may catch on equipment moving parts.
12. **NEVER CARRY PASSENGERS.**
13. **KNOW THE AREA YOU ARE TO MOW.** Watch for hidden dangers such as rocks, roots, sticks, holes, bumps, and drop-offs, etc. Before mowing, pick up all debris in area to be mowed. Sharp and hard objects can be propelled at a high speed and can act like shrapnel. Walk through tall grass **BEFORE MOWING** to make sure there are no hidden dangers. Mow higher than desired in tall grass to expose any hidden objects and/or obstacles, clean the area, and then mow to the desired height.
14. **BE SURE THE AREA IS CLEAR** of other people before mowing. Stop machine if anyone enters the area.
15. **NEVER REFUEL A MOWER INDOORS.** Allow the engine time to cool before refueling. Unseen vapors may be ignited by a spark. Always clean up spilled gasoline. Never run the engine indoors in a garage or any other closed building. Allow engine to cool before storing in any enclosure. The engine exhaust and gasoline fumes are dangerous.
16. **NEVER REMOVE THE FUEL CAP** or add gasoline to a running or hot engine or an engine that has not been allowed to cool for several minutes after running. Always make sure the gas cap is in place.
17. **DO NOT SMOKE AROUND THE MOWER** or the gasoline storage container. Gasoline fumes can easily ignite.
18. **KEEP GASOLINE IN A WELL-VENTILATED AREA** away from your living quarters and in tightly capped safety cans. Never store mower with gasoline in the tank inside a building where fumes may reach open flame or spark.
19. **DISENGAGE BLADES, STOP ENGINE, ENGAGE PARKING BRAKE AND REMOVE IGNITION KEY** before any servicing. Be sure all moving parts and all sounds have stopped. Let engine cool and disconnect the spark plugs so the engine cannot start by accident.
20. **KEEP ALL NUTS, BOLTS, AND SCREWS TIGHT** to be sure equipment is in safe working condition, especially blade bolts.
21. **VEHICLE SHOULD BE STOPPED AND INSPECTED FOR DAMAGE** after striking a foreign object and the damage should be repaired before restarting and operating the equipment. Stop immediately and check for damage or loose parts if mower should start vibrating.
22. **DISENGAGE BLADES BEFORE DRIVING ACROSS WALKS** or projecting objects or transporting.
23. **KEEP SAFETY DEVICES AND GUARDS IN PLACE.** If any of the safety switches become inoperable, have them repaired immediately.
24. **DO NOT STEP OR STAND ON THE MOWER HOUSING.** Step or stand only on the tread areas on the deck.
25. **WATCH OUT FOR TRAFFIC** near roadways and when crossing roads.
26. **THIS MACHINE IS NOT MEANT FOR HIGHWAY OR STREET USE.** It is not a recreational vehicle and it should not be operated as such.
27. **WHEN FEASIBLE, DO NOT USE MOWER WHEN GRASS IS WET OR SLIPPERY.**
28. **MOW ONLY IN DAYLIGHT OR GOOD ARTIFICIAL LIGHT.**

SAFETY CONTINUED

29. ALWAYS DISENGAGE THE MOWER BLADE CLUTCH when transporting.
30. Do not operate the mower under influence of drugs or alcohol.
31. Do not change the engine governor settings or overspeed the engine. Operating an engine at excessive speed may increase the hazard of personal injury.

TOWING

1. Use for towing only if equipped with a Bush Hog hitch kit. Do not attach towed equipment except at the hitch point.
2. Never allow children or others in or on towed equipment.
3. On slopes, the weight of the towed equipment may cause loss of traction and loss of control.
4. Travel slowly and allow extra distance to stop.

SLOPE OPERATION

DANGER

POTENTIAL HAZARD

Mowing on wet grass or steep slopes can cause sliding and loss of control.

WHAT CAN HAPPEN

Wheels dropping over edges, ditches, steep banks, or water can cause injury, or death by drowning.

HOW TO AVOID THE HAZARD

Do not mow slopes when grass is wet.
Do not mow near drop-offs or near water.
Do not mow slopes greater than 15 degrees.
Reduce speed and use extreme caution on slopes.
Avoid sudden turns or rapid speed changes.

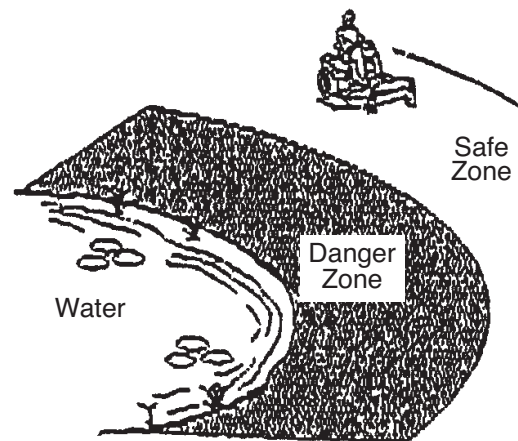

1. Use EXTREME caution when mowing and/or turning on slopes as loss of traction and/or tip-over could occur. The operator is responsible for safe operation.
2. See inside of the back cover to determine the approximate slope angle of the area to be mowed.
3. Use a walk behind mower and/or a hand trimmer near drop-offs, ditches, steep banks or water. This area can be dangerous.
4. Progressively greater care is needed as the slope increases.
5. Always avoid sudden starting or stopping on a slope. If tires lose traction, disengage the blades and proceed slowly down the slope.
6. Avoid sudden starts when mowing uphill. Mower may tip backwards.
7. Be aware that loss of traction may occur going downhill. Weight transfer to the front wheels may cause drive wheels to slip and cause loss of braking and steering.
8. Watch for ditches, holes, rocks, dips, and rises that change the operating angle, as rough terrain could overturn the machine. Tall grass can hide obstacles.
9. Remove or mark obstacles such as rocks, tree limbs, etc. from the mowing area. Tall grass can hide obstacles.
10. Use extreme care with grass catches or attachments. These can change the stability of the machine and cause loss of control.
11. Follow the manufacturer's recommendations for counterweights to improve stability.
12. Check carefully for overhead clearances (ie. branches, doorways, and electrical wires) before driving under objects and do not contact them.

SLOPE ANGLE GUIDE LOCATED INSIDE REAR COVER

IMPORTANT FEDERAL LAWS AND REGULATIONS* CONCERNING EMPLOYERS, EMPLOYEES AND OPERATIONS.

*(This section is intended to explain in broad terms the concept and effect of the following federal laws and regulations. It is not intended as a legal interpretation of the laws and should not be considered as such).

U.S. Public Law 91-596 (The Williams-Steiger Occupational and Health Act of 1970) OSHA

This Act Seeks:

“...to assure so far as possible every working man and woman in the nation safe and healthful working conditions and to preserve our human resources...”

DUTIES

Sec. 5 (a) Each employer—

- (1) shall furnish to each of his employees employment and a place of employment which are free from recognized hazards that are causing or are likely to cause death or serious physical harm to his employees;
- (2) shall comply with occupational safety and health standards promulgated under this Act.
 - (b) Each employee shall comply with occupational safety and health standards and all rules, regulations and orders issued pursuant to this Act which are applicable to his own actions and conduct.

OSHA Regulations

Current OSHA regulations state in part: “At the time of initial assignment and at least annually thereafter, the employer shall instruct every employee in the safe operation and servicing of all equipment with which the employee is, or will be involved.” These will include (but are not limited to) instructions to:

Keep all guards in place when the machine is in operation;

Permit no riders on equipment;

Stop engine, disconnect the power source, and wait for all machine movement to stop before servicing, adjusting, cleaning or unclogging the equipment, except where the machine must be running to be properly serviced or maintained, in which case the employer shall instruct employees as to all steps and procedures which are necessary to safely service or maintain the equipment.

Make sure everyone is clear of machinery before starting the engine, engaging power, or operating the machine.

Child Labor Under 16 Years Old

Some regulations specify that no one under the age of 16 may operate power machinery. It is your responsibility to know what these regulations are in your own area or situation. (Refer to U.S. Dept. of Labor, Employment Standard Administration, Wage & Home Division, Child Labor Bulletin #102.)

SECTION I

INTRODUCTION AND DESCRIPTION



INTRODUCTION

We are pleased to have you as a Bush Hog customer. Your Bush Hog Zero Turn Riding Mower has been carefully designed to give maximum service with minimum down time. This manual is provided to give you the necessary operating and maintenance instructions for keeping your mower in top operating condition. Please read this manual thoroughly. Understand what each control is for and how to use it. Observe all safety precautions decal on the machine and noted throughout the manual for safe operation of the implement. If any assistance or additional information is needed, contact your authorized Bush Hog dealer.

NOTE:

All references made to right, left, front, rear, top or bottom is as viewed facing the direction of forward travel.

DESCRIPTION

The Zero Turn is intended for use on large lawns and other frequently maintained areas where a

smooth, even cut is desired and superior maneuverability is needed. The tractor unit consists of either a 21 hp or 25 hp Kawasaki or a 23 hp Kohler twin cylinder engine. The engine has a pressurized oil lubrication system with spin-on type filter, fused electronic ignition, electric start and a 12.5 gallon fuel system.

Two hydrostatic pumps and two wheel motors are used for propelling and steering. The pumps are belt driven by the engine output shaft. One lever for each drive controls both speed and direction. This independent control of each drive wheel coupled with continuously variable speed selection gives the Zero Turn mower exceptional maneuverability.

The mower attachment is available in 49" or 55" and 61" cutting widths. The mower has three cutting blades, driven by an electromagnetic clutch through a single v-belt.

CONTROLS

OPERATOR INTERLOCK SYSTEM

Your Bush Hog Zero Turn Riding Mower is equipped with an Operator Interlock System that is designed to help prevent possible serious injuries. Understanding and maintaining this system is vital for safe operation.

To Start Engine:

1. Blades (PTO) must be disengaged.
2. Control levers in neutral (swung out).
3. Parking brake set.

The Engine Will Kill If:

1. The operator leaves the seat with:
 - a. The control levers out of neutral (swung in).
 - b. The blades are engaged.
 - c. The parking brake is off.
 - d. All of the above.
2. The park brake is on before the control levers are swung in.

DO NOT OPERATE MOWER IF SAFETY SWITCHES ARE NOT OPERATING PROPERLY.

WARNING

DO NOT OPERATE MACHINE UNLESS INTERLOCK SYSTEM FUNCTIONS PROPERLY. FAILURE TO HEED THIS WARNING MAY RESULT IN SERIOUS INJURY, DEATH OR EQUIPMENT DAMAGE.

TRACTOR SPECIFICATIONS

Tread Width -49" Deck models - Outside Tires 50"
 55" Deck models - Outside Tires 52"
 61" Deck models - Outside Tires 55"

Height - To top of seat back 50"

Fuel Tank - 12.5 gallons

Hydrostatic Fluid Reservoir Approx. 1 gallon

Hydrostatic Pumps- All Models . . (2) Hydro-Gear pumps

Engines - 23 h.p. Kohler Command Pro
 25 h.p. Kawasaki
 21 h.p. Kawasaki

Tires - Front (49" & 55" Decks) 13 x 5.0 - 6
 (61" Deck) 13 x 6.5 - 6
 Drive - 49" Decks 23 x 8.5 -12
 55" Decks 24 x 9.5 - 12
 61" Decks 24 x 12 - 12

CONTROL LOCATIONS

- ① Ignition Key -Starts and stops engine.
- ② Engine Throttle - Controls engine speed.
- ③ Two Steering/Speed Control Levers - In front of seat at side. (See page 21)
- ④ PTO Switch - Engages electric clutch which engages mower blades.
- ⑤ Parking Brake Lever - Engages parking brake. (See page 21)
- ⑥ Cutting Height Adjust Pin - Sets cutting height to desired position. (See page 12)
- ⑦ Choke - Aids in starting engine.
- ⑧ Light Switch (Optional)
- ⑨ Hour Meter / Tachometer
- ⑩ Warning Lights / Audible Alert for high engine temperature (Kohler models only) and oil pressure.
- ⑪ Fuel Tank Site Lines - Monitor amount of fuel in tank. (See page 14)
- ⑫ DC Power Outlet (See page 14)

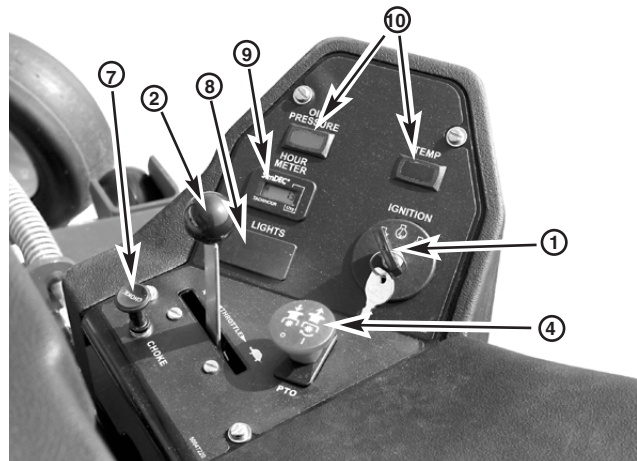

DECK SPECIFICATIONS

ITEM

Cutting width	49"	55"	61"
Cutting Height.....	1-1/2" to 5" in 1/4" increments		
Blades	17"	19"	21"
Overall width including chute	61"	67"	73"
Material thickness - Deck	10 GA.	7 GA.	7 GA.
Spindle bearing.....	25 mm.....		

SECTION II OPERATION

GENERAL SAFETY

Only qualified people familiar with this operator's manual should operate this machine. Operator should wear hard hat, safety glasses, and safety shoes. Avoid loose fitting clothing or jewelry. The operator should read, understand and practice all safety messages shown on the caution, warning and danger decals affixed to the machine to avoid serious injury or death. Before beginning operation, clear work area of any objects that may be picked up and thrown by mower. Check for ditches, stumps, holes or other obstacles that could upset power unit or damage mower. Tall grass can hide obstacles. Always push steering levers apart, set parking brake, disengage PTO, turn off engine, and allow blades to come to a complete stop before leaving operator's seat. Do not operate without all shields in place and in good condition.

PRE-OPERATION CHECKLIST

1. Make sure fuel tank is full. Use regular unleaded gasoline. See engine manual for more details.



WARNING

**AVOID SERIOUS INJURY OR DEATH:
GASOLINE IS EXTREMELY FLAMMABLE AND
EXPLOSIVE UNDER CERTAIN CONDITIONS.**

- REFUEL IN A WELL VENTILATED AREA WITH ENGINE STOPPED.
 - DO NOT SMOKE OR ALLOW FLAMES OR SPARKS IN THE REFUELING AREA OR WHERE GASOLINE IS BEING STORED.
 - DO NOT OVERFILL FUEL TANK. AFTER REFUELING, MAKE CERTAIN THE TANK CAP IS CLOSED PROPERLY AND SECURELY.
 - BE CAREFUL NOT TO SPILL FUEL WHEN REFUELING. FUEL VAPOR OR SPILLED FUEL MAY IGNITE. IF ANY FUEL IS SPILLED, MAKE SURE THE AREA IS DRY BEFORE STARTING THE ENGINE.
 - KEEP OUT OF REACH OF CHILDREN
2. Make sure dirt and foreign matter are kept out of fuel tank. Use a clean funnel and fuel can.
 3. **Do not mix oil with gasoline.**
 4. Do not use white, high test or premium gasoline. Do not use de-icers, carburetor cleaners or other such additives.
 5. Check the crankcase oil level. Make sure the engine is off. The mower should be parked on a level area. Do not overfill. (See your engine manual for more detailed instructions.)
 6. Check the hydrostatic transmission oil level. (See "Maintenance" section of this manual.)
 7. Check battery fluid level.

8. Inspect V-belts
9. **Check tire pressure** (Use low pressure gauge):
Front Tires - 15 psi, Drive Tires - 15 psi
10. Make sure underside of mower deck is free of grass.
11. Make sure mower blades are sharp and secured tightly.
12. Clean the air intake screen on the engine if necessary.
13. Perform any other maintenance as it becomes necessary. (See "Maintenance" section)
14. Check low oil pressure warning buzzer for operation. (It should "sound-off" whenever ignition key is in the "on" position, but engine is not running.)
15. Check parking brake operation by disengaging hydrostatic pumps (freewheeling position), and placing the brake lever in the "on" position. Attempt to rock tractor by hand. Both drive wheels should be locked. When the brake handle is in the "off" position, both drive wheels should turn freely. If there is a problem in either position, refer to adjustment procedure in the maintenance section.
16. Seat Adjustments: The high-back full suspension seat has a variable rate suspension system, adjustable lumbar support and sliding seat to accommodate different operators.

Operator Weight Adjustment Knob - Turn the knob until the indicator position closely matches your weight to give the most comfortable ride.

Adjustable Lumbar Knob (Under left arm rest) - Turn knob clockwise or counter-clockwise to achieve desired support.

Back Angle Adjustment Knob (Under right arm rest) - Turn knob clockwise or counter-clockwise to achieve desired support.

Lever Release Seat Slides - Pull the lever outward to release the latch. Slide the seat forward or rearward to your most comfortable position and release the lever.



WARNING

**ENGINE EXHAUST GASES CONTAIN
POISONOUS CARBON MONOXIDE.**

- NEVER RUN ENGINE IN A CLOSED BUILDING OR CONFINED AREA.
- AVOID INHALING EXHAUST GASES.

OPERATION

1. OPEN FUEL TANK SELECTOR VALVE left or right tank.
2. MOVE CONTROL LEVERS TO neutral "OUT" position by pushing each one straight sideways.
3. SET PARKING BRAKE. Pull rearward to set.
4. DISENGAGE MOWER BLADE CLUTCH by moving clutch switch to "OFF" (down) position.
5. SET ENGINE CHOKE CONTROL for cold starts to full position.
6. SET ENGINE THROTTLE TO 1/2 throttle.
7. TURN IGNITION KEY to "START" position and release to "RUN" as soon as engine starts. NOTE: Prolonged cranking will damage starter motor and shorten the battery life.
8. ADJUST ENGINE THROTTLE AND CHOKE for desired engine smoothness and speed. NOTE: When mowing, always run engine at full throttle.
9. RELEASE PARKING BRAKE. Push brake lever forward to release.

CAUTION

If the operator is inexperienced with the zero turn mower lever steering/speed control, he/she should follow these recommendations: Disengage the mower blades. Go very slowly until thoroughly familiar with the machine. Keep away from fences, buildings, and other obstructions. While becoming familiar with the machine, move the Control Levers smoothly and slowly. Practice until operation is smooth and efficient.

10. A roll-over protection system (ROPS) is installed on your machine. Operate unit with the ROPS in the raised and locked position and use seat belt. There is no roll-over protection when the ROPS is down. If it is necessary to lower the ROPS, do not wear seat belt. Raise the ROPS as soon as clearance permits.

WARNING

MAKE SURE SEAT FRAME RETENTION CLICK-PINS ARE IN PLACE AFTER LIFTING SEAT PAN FOR SERVICE.

11. TO DRIVE: Adjust seat forward or backward for operator comfort. Move the Control Levers to the "IN" position. Move Control Levers forward to move forward. Move levers slowly forward to increase speed. To reverse direction, move the Control Lever on the side to which you want to turn slightly rearward of the other Control Lever. To turn on a zero radius axis, go slowly and pull one Control Lever back and push the other

Control Lever forward, depending on which direction you wish to turn.

WARNING

**AVOID SERIOUS INJURY OR DEATH:
DO NOT MOVE STEERING LEVERS FROM FORWARD TO REVERSE OR REVERSE TO FORWARD POSITION RAPIDLY. A SUDDEN CHANGE IN DIRECTION MAY CAUSE LOSS OF CONTROL AND/OR DAMAGE TO EQUIPMENT. FOR SMOOTH, SAFE OPERATION, MOVE THE CONTROL LEVERS IN A GENTLE, SLOW MOTION, ESPECIALLY ON GRADES.**

12. BRAKING: To brake mower, gently move Control Levers in the direction opposite to travel. If the parking brake is engaged with the Control Levers in the "IN" position the engine will stop.
13. CUTTING HEIGHT ADJUSTMENT:
 1. Stop engine and move the control levers to the neutral position and engage the parking brake.
 2. Disengage the blades.
 3. Depress the deck lift foot pedal raising the deck to the transport position and place the pedal in the locked position.
 4. Insert height adjustment pin into the hole corresponding to the desired cutting height. See decal on the side of the deck lift plate.
 5. Depress the deck lift pedal and lower the deck to the selected mowing height.
 6. To transport, depress the lift foot pedal and lock in position, then move the height adjustment pin to the 5" position.
 7. The cutting height adjustment is only a recommended guide. During normal mowing cut only 1/3 of the grass blade. Set cutting height to achieve your desired results.

CUTTING HEIGHT ADJUSTMENT DECAL

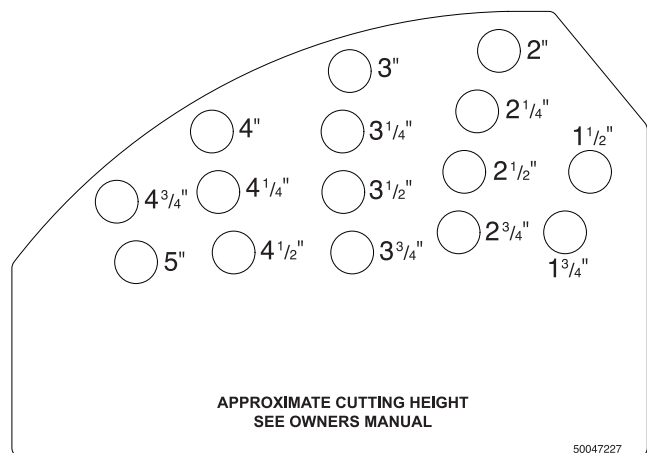

ANTI-SCALP ROLLER OR CASTER ADJUSTMENT:

1. Stop engine and move the control levers to the neutral position and engage the parking brake.

2. Disengage the blades.

3. The Anti-Scalp deck rollers are adjustable up and down to provide improved deck flotation and scalping protection at various cutting heights. They are not intended to ride continuously on the ground. Rollers should maintain .375" minimum clearance to ground. DO NOT adjust rollers to support deck. (Refer to photographs)

14. ENGAGE MOWER BLADES by pulling up on the PTO clutch switch. The engine will not start if the PTO clutch is engaged. If the engine is running while the PTO clutch is engaged and the operator leaves the seat, the engine will stop.

15. TO STOP:

- A. Slow engine speed with throttle to slowest position
- B. Disengage the mower blade clutch by moving the PTO clutch switch to the "OFF" position.
- C. Move Control Levers to neutral position and then to the "OUT" position.
- D. Set the parking brake.
- E. Turn ignition key to "OFF" position.
- F. Remove the key and wait for all movement and sound to cease before dismounting.

ANTI-SCALP ROLLER



Roller Height Adjustment Holes

WARNING

Use **EXTREME** caution when mowing and/or turning on slopes as loss of traction and/or tip-over could occur. Drive slower on slopes. DO NOT mow slopes greater than 15 degrees. Watch for ditches, holes, rocks, dips and rises, which change the operating angle. Keep away from drop-offs and steep banks. Avoid sudden starts when mowing uphill - mower may tip backwards. Loss of traction may occur going downhill - weight transfer to the front wheels may cause drive wheels to slip and cause loss of braking. DO NOT mow slopes when grass is wet - slippery conditions affect steering and reduce traction and braking. The operator is responsible for safe OPERATION ON SLOPES.

CASTER ASSEMBLY (Optional on 61" Decks Only)

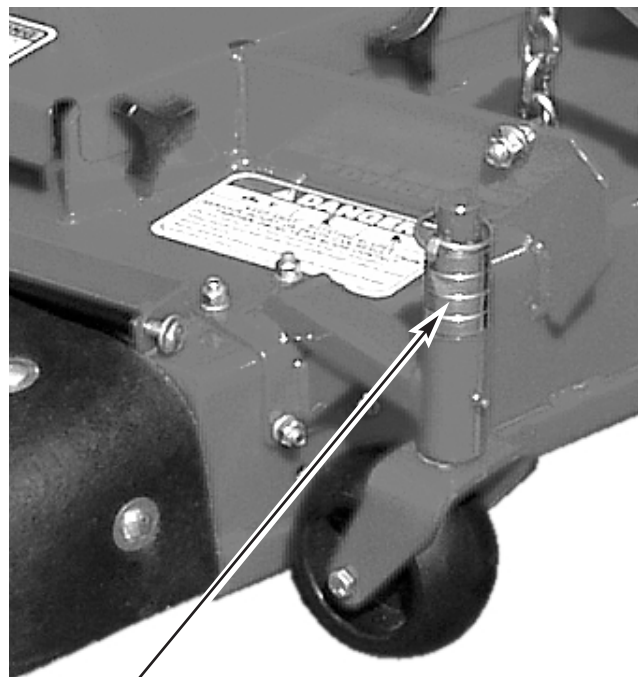

Spacers may be positioned above and/or below the caster arm to adjust position.

⚠ WARNING

AVOID SERIOUS INJURIES TO OTHERS: ALWAYS REMOVE THE KEY FROM THE IGNITION SWITCH WHENEVER THE MOWER IS UNATTENDED TO PREVENT CHILDREN OR UNAUTHORIZED PERSONS FROM STARTING THE ENGINE.

16. PUMP BYPASS-TO MOVE THE TRACTOR WITHOUT POWER: The pump bypass valves are located on the front sides of each pump. Turn the control clockwise two complete turns to release the pump for free wheeling; turn them counter-clockwise for operation.

Pumps as seen from above. Use a rod through the hex head, or a 5/8" wrench to open or close the valve.

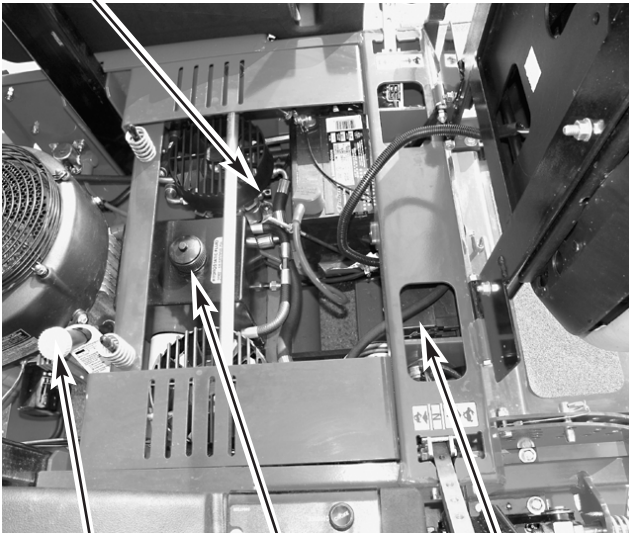

Engine Oil Filler Cap

Hydrostatic Fluid Reservoir Cap

Electrical Fuses

NOTE: To move the tractor without power, the pumps must be unlocked and in the free wheel position. Failure to do so could possibly damage the hydraulic motors. Never pull at more than 2 MPH.

17. FUEL SHUT-OFF VALVE: Located on the front panel below the operator is the fuel directional valve. This valve has three positions for operations and each position is made in 1/4 turn increments. This directional valve has a shut off position and can be used when the machine will not be used for a few days or when the unit is transported to and from a work site.

<u>Fuel Flow</u>	
Off	
Right Tank	
Left Tank	

<u>Valve Position</u>
Down
Right
Left

MOWING RECOMMENDATIONS

1. Keep mower blades sharp.
2. Make sure deck and discharge chute are clean.

⚠ WARNING

TO AVOID SERIOUS INJURY FROM BLADE CONTACT, POWER MUST BE OFF TO CLEAN DISCHARGE CHUTE

⚠ DANGER

KEEP HANDS AND FEET AWAY FROM UNDERNEATH MOWER TO AVOID SERIOUS INJURY OR DEATH.

⚠ WARNING

ROTARY MOWERS CAN DISCHARGE OBJECTS AT HIGH SPEEDS. TO AVOID SERIOUS INJURIES OR DEATH:

- OPERATE ONLY WITH SIDE BANDS IN GOOD REPAIR AND CHUTE OR GRASS CATCHER ATTACHMENT INSTALLED.
- KEEP CHILDREN, PETS, AND BYSTANDERS AWAY FROM THE WORK AREA.
- DO NOT OPERATE MOWER IN THE VICINITY OF OTHER PERSONS.
- DISCHARGE AWAY FROM BUILDINGS, WALLS OR OTHER STRUCTURES.

Fuel Tank Site Lines Operator Weight Adjustment Knob Seat Slide Release Lever



Cutting Height Adjustment Pin

Fuel Tank Selector Valve

DC Power Outlet

SECTION III MAINTENANCE

CAUTION

BEFORE PERFORMING ANY MAINTENANCE, TURN OFF ENGINE, REMOVE KEY AND DISCONNECT SPARK PLUGS. USE EXTREME CARE WHEN WORKING ON MACHINERY. DO NOT WEAR WATCH OR JEWELRY. DO NOT WEAR LOOSE FITTING CLOTHES, AND OBSERVE ALL COMMON SAFETY PRACTICES WITH TOOLS.

IMPORTANT:

BEFORE PERFORMING ANY SERVICE, MAINTENANCE OR REPAIR ON THE ENGINE, REFER TO THE RESPECTIVE ENGINE MANUFACTURERS' MANUAL FOR SPECIFIC INFORMATION CONCERNING YOUR PARTICULAR BRAND OF ENGINE.

MAINTENANCE SCHEDULE

SERVICE

WHEN

Check crankcase oil level _____	before each use
Check air intake screen _____	after each use
Clean grass from under deck _____	after each use
Check tire pressure _____	every 10 hours
Sharpen mower blades _____	every 10 hours
Clean air filter element _____	every 8 hours
Check 20W50 motor oil in hydrostatic system _____	every 10 hours
Check drive belts _____	every 50 hours (20 hr break-in)
Grease blade spindles _____	every 50 hours
Grease front wheels _____	every 50 hours
Grease caster wheel pivots _____	every 50 hours
Grease pusher bar pivots _____	every 50 hours
Change engine crankcase oil and filter _____	every 50 hours (5 hrs break-in)
Change hydrostatic oil filter (See your Bush Hog Dealer) Important: Substitution of an improper filter will cause hydrostatic failure which will not be covered under warranty _____	every 500 hours (50 hrs break-in)
Replace air filter element _____	annually or 500 hours
Check spark plugs _____	annually or 100 hours
Service battery _____	annually or 500 hours

Perform these maintenance procedures more frequently under extremely dusty, dirty conditions.

Replace decals when illegible. Write parts dept. for free replacement.

WARNING: Make sure seat frame retention click-pins are in place after lifting seat pan for service.

1. ENGINE:

For complete maintenance and operating information for your engine, please refer to your engine operating and maintenance instructions furnished by the engine manufacturer and included in your Zero Turn mower information packet.

NOTE

Air intake screen must be kept clean. If plugged, engine may be seriously damaged by over heating.

2. TACHOMETER / HOURMETER

The tachometer / hourmeter includes a FlashAlert feature to remind you to change engine oil and filter at recommended intervals. The tachometer displays engine rpm when the engine is running and elapsed time in hours when the engine is turned off.

Oil Change Flash Alert - Break-in interval at 5 hours with 1 hour before and after flash. Normal interval at 50 hours with 2 hour before and after flash.

3. BATTERY:

When taking the battery out of the mower for servicing, make sure to reconnect the cables to the battery exactly as they were prior to removal.

Keep the battery clean. Remove the corrosion around the battery terminals by applying a solution of one part baking soda to four parts water. Coat all exposed terminal surfaces with a light layer of grease or petroleum jelly to prevent corrosion.

NOTE

At temperatures below 32 degrees F (0 deg C) the full charge state must be maintained to prevent cell electrolyte from freezing and causing permanent battery damage.

WARNING

AVOID SERIOUS INJURY OR DEATH:

- **THE BATTERY CONTAINS SULFURIC ACID. AVOID CONTACT WITH SKIN, EYES OR CLOTHING. EYES - FLUSH WITH WATER AND GET PROMPT MEDICAL ATTENTION. ANTIDOTE: INTERNAL - DRINK LARGE QUANTITIES OF WATER OR MILK. FOLLOW WITH MILK OF MAGNESIA, BEATEN EGG OR VEGETABLE OIL. CALL A PHYSICIAN IMMEDIATELY.**
- **BATTERIES PRODUCE EXPLOSIVE GASES. KEEP SPARKS, FLAMES AND SMOKING MATERIALS AWAY. VENTILATE WHEN CHARGING IN AN ENCLOSED SPACE. WEAR EYE PROTECTION WHEN WORKING NEAR BATTERIES.**
- **KEEP OUT OF REACH OF CHILDREN.**

4. TIRES:

Correct tire pressure is essential for efficient operation of the mower. Check tire air pressure periodically. Inflate front and rear tires to **15 psi**.

Lug bolts should be checked regularly for tightness. Torque lug bolts to 50 ft./lbs. The center hub nut should be torqued to 175 - 200 ft./lbs. and cotter key installed.

5. MOWER BLADES:

Check sharpness of mower blades after every 10 hours of operation. To sharpen blades proceed as follows:

WARNING

WHEN IT IS NECESSARY TO RAISE THE DECK OR MOWER FOR SERVICE OR MAINTENANCE, TO AVOID SERIOUS INJURY OR DEATH, STOP ENGINE, SET PARKING BRAKE, REMOVE IGNITION KEY AND SPARK PLUG WIRES AND SECURELY SUPPORT THE DECK OR MOWER BEFORE WORKING UNDERNEATH.

- A. Lift deck and secure in raised position.
- B. Remove bolt, cup washer, and blade from shaft.
- C. Blades should be discarded when worn excessively. See sketch.



D. Sharpen blade with a hand file, electric grinder or blade sharpener. Wear gloves and eye protection when sharpening. Grind blade at original bevel.

E. Check balance of blade by positioning the blade on a nail or blade balance pedestal. Grind the blade on the end that is heavier until both sides balance.

F. Install blades with the concave side of the cup washer against blade. Be sure blades are installed with uplifts and cutting edges in the proper directions. **Tighten retaining bolt to 76 ft./lbs.**

WARNING

WHEN IT IS NECESSARY TO RAISE THE DECK OR MOWER FOR SERVICE OR MAINTENANCE, TO AVOID SERIOUS INJURY OR DEATH, STOP ENGINE, SET PARKING BRAKE, REMOVE IGNITION KEY AND SPARK PLUG WIRES AND SECURELY SUPPORT THE DECK OR MOWER BEFORE WORKING UNDERNEATH.

6. CLEANING GRASS BUILD UP UNDER DECK

Depress the deck lift foot pedal and lock in position, then move the height adjustment pin to the 5" position.

Lift the front of the unit and support unit securely.

Clean out any grass build up from underside of deck and in deck discharge chute.

MOTION CONTROL LEVER ADJUSTMENT

1. There are three lever height positions available. Place the levers in the position that provides the most comfortable operating position for you.
2. Align the levers front/rear position. With the levers in the neutral position, loosen the hardware and adjust the levers by tilting forward or backward until properly aligned. Tighten hardware.



Lever Position Adjustment Bolts

MOTION CONTROL STEERING ADJUSTMENT

1. Raise the drive wheels of the Zero Turn off of the ground. Safely block the frame in this position so it is secure. This adjustment must be made with the drive wheels turning.
2. Remove the electrical connection from the seat switch and **temporarily** install a jumper wire across the terminals of the wiring harness.
3. Loosen the jamnuts on the hex turnbuckle, which connects the lever control arm to the pump control arm. Note: the nuts to the front of the hex turnbuckle have left-handed threads.
4. Start the engine. Run the engine at full throttle and release brake.
5. Position the control levers in the neutral position. If the drive wheels creep (rotate) in the neutral position then lengthen or shorten the turnbuckle assembly. Make the adjustment to stop the wheel from rotating.

6. Re-tighten the nuts at the end of the hex turnbuckles and repeat the procedure for the opposite side of the unit.
7. Shut the unit off. Remove the jumper wire from the wiring harness and **replace** the connectors into the seat switch. Never operate the mower unless all safety switches are operating properly.

DRIVE ADJUSTMENTS

Steering and motion controls should be uniform in all forward and reverse speeds. From the reverse position the levers should automatically return to neutral when released.

CAUTION

STOP THE ENGINE BEFORE MAKING ADJUSTMENTS.

TEST DRIVE OPERATIONS

Check air pressure in tires. Equal tire pressure is critical for proper drive operation.

1. Raise drive wheels off ground. Safely block the frame in this position.
2. Put control levers in neutral lock position (control levers swung outward).
3. Start engine. Wheels should not rotate. If one or both drive wheels are turning, perform procedures under "Motion Control Adjustment" for side(s) that wheel turns.

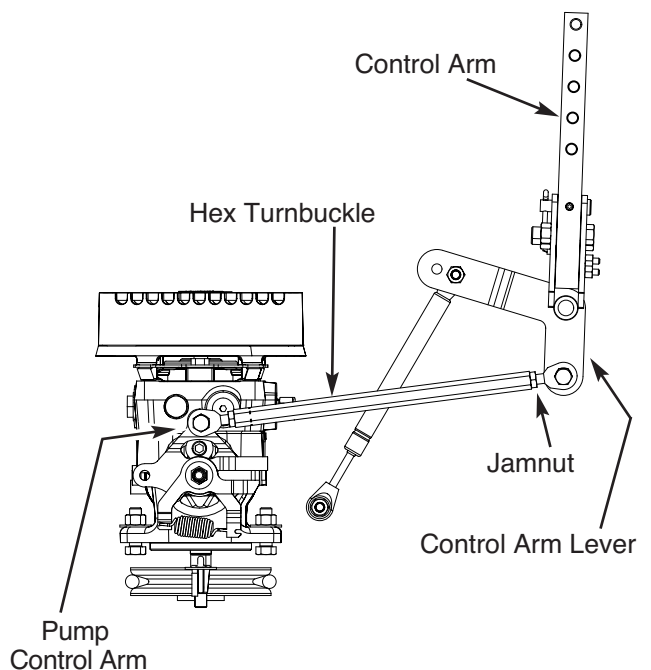

LEVELING THE DECK



STOP THE ENGINE, SET PARKING BRAKE, REMOVE IGNITION KEY AND SPARK PLUG WIRES FOR SAFETY.



1. Set all tire pressures to the correct specifications.
2. Place machine on a level slab of concrete.
3. Depress the deck lift pedal raising the deck to the full lift height position and move the height adjustment pin to the 5" position.
4. Place a level on the deck, from front to rear. If the level is too short to reach all the way from front to rear, lay a straight edge on the deck first, then place the level on the straight edge.
5. Lay a .125" spacer beneath the front of the level.
6. Adjustment may be made by loosening the upper chain fasteners and moving the fasteners in the provided slot. Adjust fasteners until the level's bubble is centered. Repeat for the other side.

COUNTERBALANCE SPRING

Raise the cutter deck to the transport position. Adjust the spring with the nut to the following lengths:

49" Deck - Spring Length of 14-1/2"

55" Deck - Spring Length of 15"

61" Deck - Spring Length of 14-1/2"

The springs may be tightened or loosened from this point according to personal preference. (Measure from inside of hook to inside of hook)

DECK BELT ADJUSTMENT

Belt adjustment should be checked every 50 hours to get maximum life and cutting performance from the mower. Belt tension is adjusted by increasing or decreasing the length of the spring on the movable idler. For proper belt tension on the 49", 55" and 61" mowers, the spring length should be set to 7-1/2" inside hook to inside hook with the deck in 3" cutting height position. To adjust the spring length, loosen or tighten the 3/8" hex nuts on the eye bolt until the correct spring length is reached.

DECK BELT REPLACEMENT

USE ONLY GENUINE BUSH HOG REPLACEMENT PARTS

- A. Remove the deck shield assembly.
- B. Relieve the spring tension by loosening the two 3/8" hex nuts on the eye bolt.
- C. Remove old belt.
- D. Install new belt. Be sure that the belt is properly positioned in all sheave grooves.
- E. Adjust tension on the belt by adjusting the length of the spring on the moveable idler. **The correct spring length is 7-1/2"** for the 49", 55" and 61" decks.
- F. Replace the deck shield assembly.

DECK SPINDLE BELT ROUTING DIAGRAM

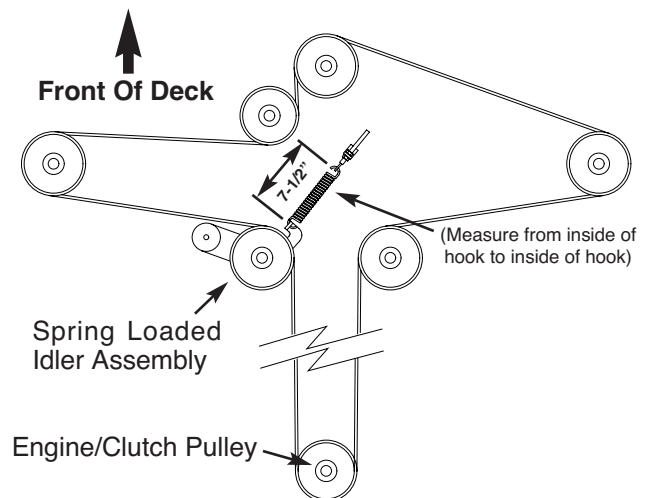

TO AVOID SERIOUS BURN INJURIES:

- ALLOW ENGINE, OIL AND HYDRAULIC FLUIDS TO COOL BEFORE SERVICING TRANSMISSION OR ENGINE SYSTEM



TO AVOID CLEANING SOLVENT FIRES:

- AVOID USING FLAMMABLE SOLVENTS.
- AVOID AREAS WITH IGNITION SOURCES WHEN USING FLAMMABLE SOLVENTS.



WARNING

HIGH PRESSURE HYDRAULIC FLUID LEAKS CAN PENETRATE SKIN CAUSING SERIOUS INJURY AND GANGRENE.

INJECTED FLUID MUST BE SURGICALLY REMOVED WITHIN A FEW HOURS BY A DOCTOR FAMILIAR WITH THIS TYPE OF INJURY.

TO AVOID SERIOUS INJURY FROM PRESSURE LEAKS:

- **USE CARDBOARD AND NOT HANDS TO SEARCH FOR LEAKS.**
- **RELIEVE HYDRAULIC PRESSURE BEFORE WORKING ON SYSTEM.**
- **CHECK HYDRAULIC HOSES, LINES, AND CONNECTIONS FOR TIGHTNESS AND GOOD CONDITION BEFORE APPLYING SYSTEM PRESSURE.**

START-UP MAINTENANCE

HYDROSTATIC FLUID

Bush Hog recommends the use of 20W50 motor oil in the hydrostatic reservoir.

START-UP PROCEDURE



WARNING

TO AVOID INJURY FROM EQUIPMENT GROUND TRAVEL AND MOVEMENT DURING START-UP PROCEDURE:

DO NOT START OR JOG ENGINE UNTIL:

- **PUMP IS IN NEUTRAL POSITION**
- **DRIVE WHEELS ARE RAISED OFF THE GROUND.**
- **EQUIPMENT IS SECURELY BLOCKED-UP TO KEEP WHEELS FROM GROUND CONTACT.**
- **PTO AND OTHER WORK FUNCTIONS ARE DISCONNECTED.**
- **KEEP HANDS, HAIR AND CLOTHING AWAY FROM ROTATING BLADES.**

The following start-up procedure should always be followed when starting a new installation or when restarting and installation in which the pump or motor has been removed from the system.

Prior to starting the pump, make certain all system components (reservoir, fittings, etc.) are clean prior to filling with fluid.

Fill the reservoir with recommended fluid which should be filtered prior to entering the reservoir.

Start the engine and idle at the lowest possible RPM.

With the bypass valve closed, slowly move the displacement control in both the forward and reverse directions. As air is purged from the unit, the oil level in the reservoir will drop and bubbles may appear in the fluid. Refill the reservoir as necessary.

Place the steering levers in the neutral position and

open the bypass valve. Slowly move the steering levers in both the forward and reverse directions to purge the air from the closed circuit.

Close the bypass valve and run the unit in both directions for several minutes until any remaining air is purged from the unit. Refill the reservoir as necessary.

Stop the engine, check for and correct any fluid leaks, and check the reservoir level. Add fluid if necessary. The transmission is now ready for operation.

HYDROSTATIC MAINTENANCE

Check the reservoir daily for proper fluid level. Oil level should be to the bottom of the slot on the reservoir baffle.

The pump and motor units normally do not require regular fluid changes. The system filter should be changed after the first 50 hours of break-in, then every 250 hours thereafter. The fluid and filter should be changed and the system cleaned if the fluid becomes contaminated with foreign matter (water, dirt, etc.).

PARKING BRAKE ADJUSTMENT

Check to make sure brake is adjusted properly.

Force on the brake handle to lock the brake in place should be 30 pounds. To adjust the brake tension, shorten or lengthen the horizontal brake linkage.

If further adjustment is needed at each individual wheel brake:

1. Engage the brake lever (lever up).
2. Remove the wheel from the side needing adjusting.
3. With the brake engaged the spring length should be 3-1/2" (measured to the inside of the spring loops).
4. If the spring length is different, shorten or lengthen the vertical brake linkage.
5. Reinstall the wheel and torque the lug nuts.

Pump Drive Belt Tension Adjustment

1. Stop engine and remove key.
2. The pump drive belt tension is adjusted through a spring loaded idler pulley.
3. Adjust the eye bolt so the spring length is 6" (measured to the inside of the spring loops).

TROUBLESHOOTING CHECK LIST

1. ENGINE IDLES POORLY:

Carburetor maladjustment _____ readjust carburetor
Improper spark plug gap _____ check and re-gap plug

2. ENGINE BACKFIRES:

Carburetor maladjustment _____ readjust carburetor

3. ENGINE RUNS BUT POWER UNIT WON'T MOVE FORWARD

Drive belt loose or broken _____ re-tension or replace
Pump shift arm disconnected _____ reconnect
Hydrostatic reservoir oil low _____ add oil
Pump bypass valve open _____ put in closed position
Hydrostatic oil filter plugged _____ replace filter
Bad pump or motor _____ consult dealer

4. POWER UNIT LOSES POWER OR HYDROSTAT SYSTEM OVERHEATS

Hydrostatic oil reservoir too low _____ add oil
Pump or motor damaged _____ consult dealer
Hydrostatic oil reservoir blowing oil out cap _____ overfilled or water contaminated

5. ENGINE STALLS WHEN BLADES ARE ENGAGED

Operator not on seat _____ sit on seat
Faulty interlock system _____ consult dealer
Bad blade spindle bearing _____ consult dealer
Deck drive belt not properly routed _____ reroute
Blades blocked by foreign material _____ clean under deck

•See engine manual for engine adjustments

ENGINE ELECTRICAL TROUBLE

1. ENGINE WILL NOT TURN OVER:

Dead battery
Bad ground connection
Bad terminal connection at battery
Wiring harness plugs are not attached properly at
the key switch or the PTO switch
Bad parking brake switch
Bad PTO switch

2. ENGINE WILL TURN OVER, BUT WILL NOT START:

A. If there is spark at the plug:

No fuel
Bad fuel solenoid in engine

B. If there is no spark at the plug:

Make sure safety interlock system is sequenced:
PTO switch is off
Control levers in neutral position
Parking brake is on
Operator in seat
Check safety interlock switches:
Seat switch
Neutral switch
Bad ignition module on engine

POOR CUTTING PERFORMANCE

* ENGINE SPEED IS TOO SLOW:

Always mow at full throttle.

* BELT SLIPPAGE:

Tighten deck adjusting spring to 7-1/2".

* DECK IS PLUGGED WITH GRASS:

Clean underneath the mower.

* BLADES ARE NOT SHARP:

Sharpen the blades or replace.

* CUTTING HEIGHT:

Normal mowing - cut only 1/3 of the grass blade.

* FINISHED CUT IS UNEVEN:

Groundspeed is too fast.

* BLADES ARE WORN DOWN TOO FAR:

Replace your blades.

SECTION IV ASSEMBLY

MOUNTING THE CONTROL LEVERS

Mount the control levers to the 3/4" x 3/4" square bars positioning the control levers to the preferred height and mount with 3/8" x 1" fasteners, lock washers, and flat washers. Move the control levers forward or rearward for operator comfort.

MOUNTING THE SEAT

Mount either the suspension seat or the non-suspension seat by aligning the four 5/16" studs with the mounting holes on the seat frame. Remove the fasteners from the operator's manual package and secure the seat with the 5/16" flange locknuts.

Attach the seat safety wires to the seat switch.

ROPS

Mount the ROPS frame to the formed channels with the 1/2" x 4-1/4" fasteners and locknuts. NOTE: If mounting a canopy position the upper structure to fold to the front. If a canopy will not be mounted position the upper structure to fold toward the rear.

MOUNTING DISCHARGE CHUTE

Align mounting holes on the discharge chute with mounts on the deck weldment. Insert discharge chute pin along with 3/8" flatwasher and 1/8" x 1" cotter pin.

BATTERY

Attach the positive lead to the battery.

Additional wire tie straps are shipped to secure the wiring harness as needed.

ITEMS TO CHECK:

Check oil level in the engine (see engine manual)

Check the fluid level in the hydrostatic oil reservoir.

Check tightness of all fasteners, including bolts, lug nuts, and setscrews.

Check tire pressure.

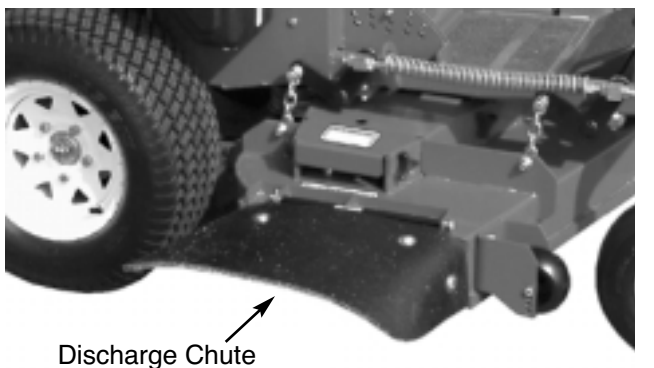
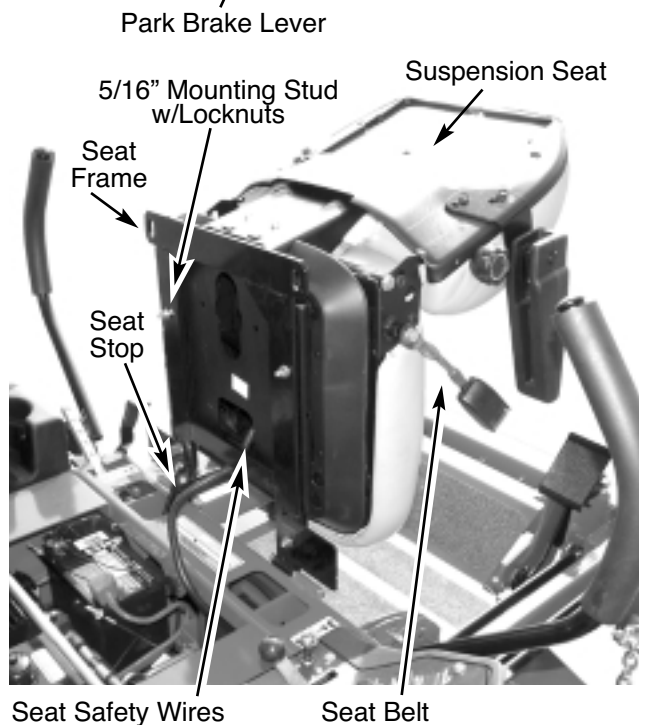
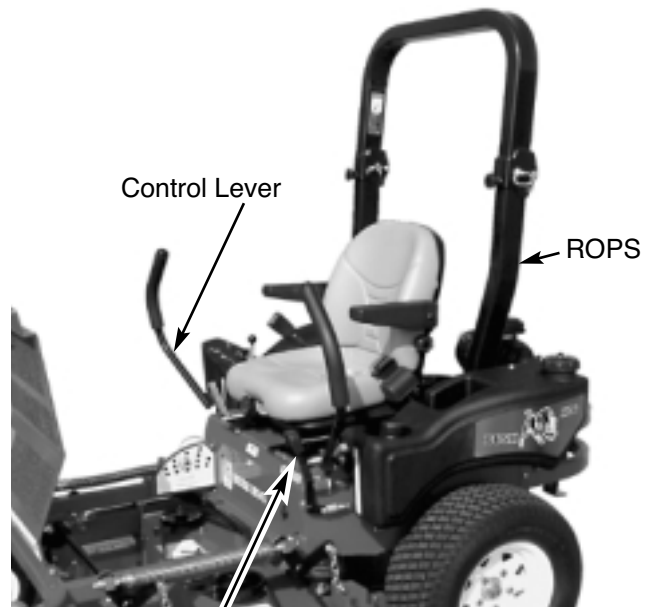

KAWASAKI ENGINE WIRING HARNESS

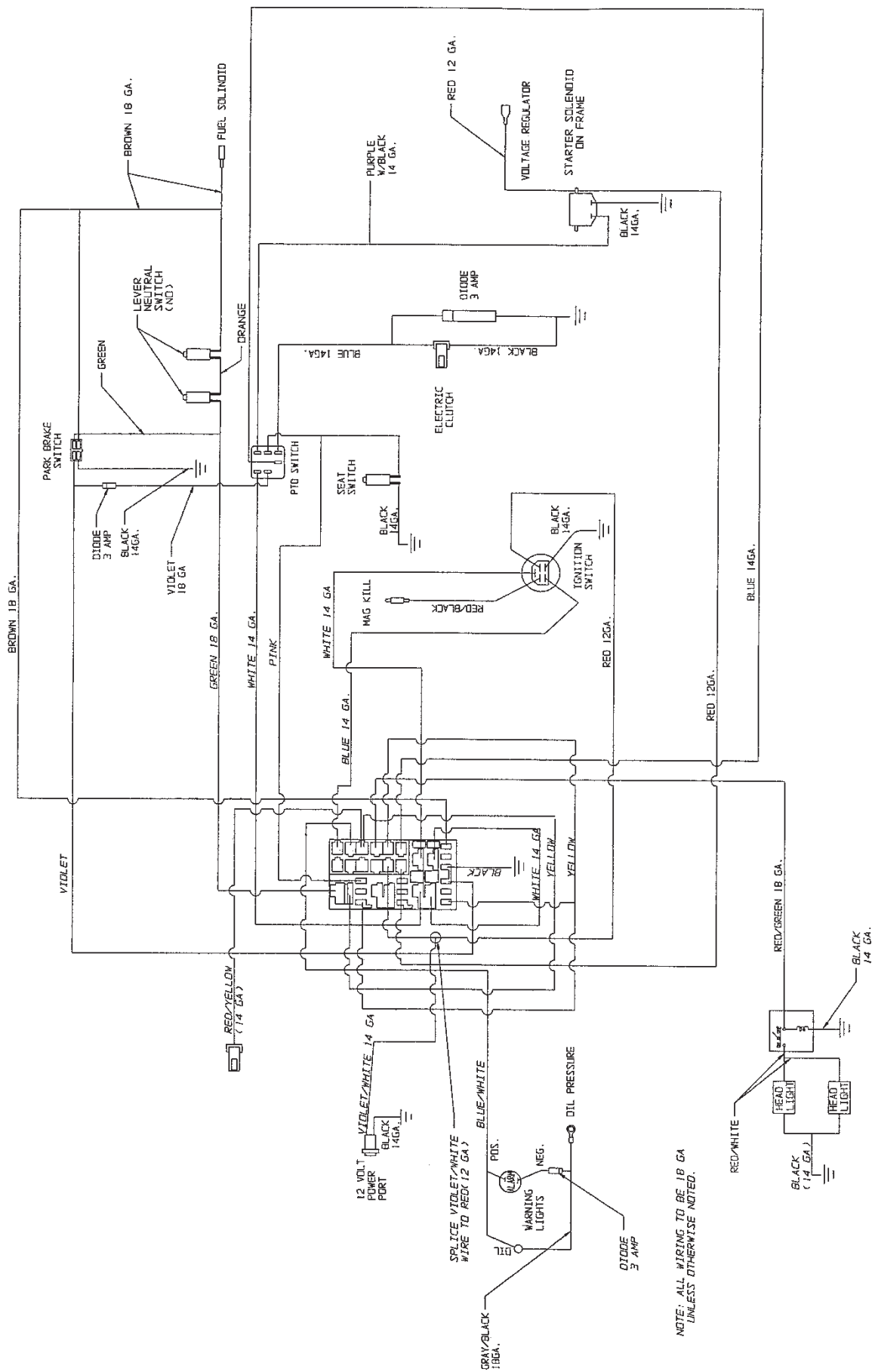

NOTE: ALL WIRING TO BE 18 GA UNLESS OTHERWISE NOTED.

KOHLER ENGINE WIRING HARNESS

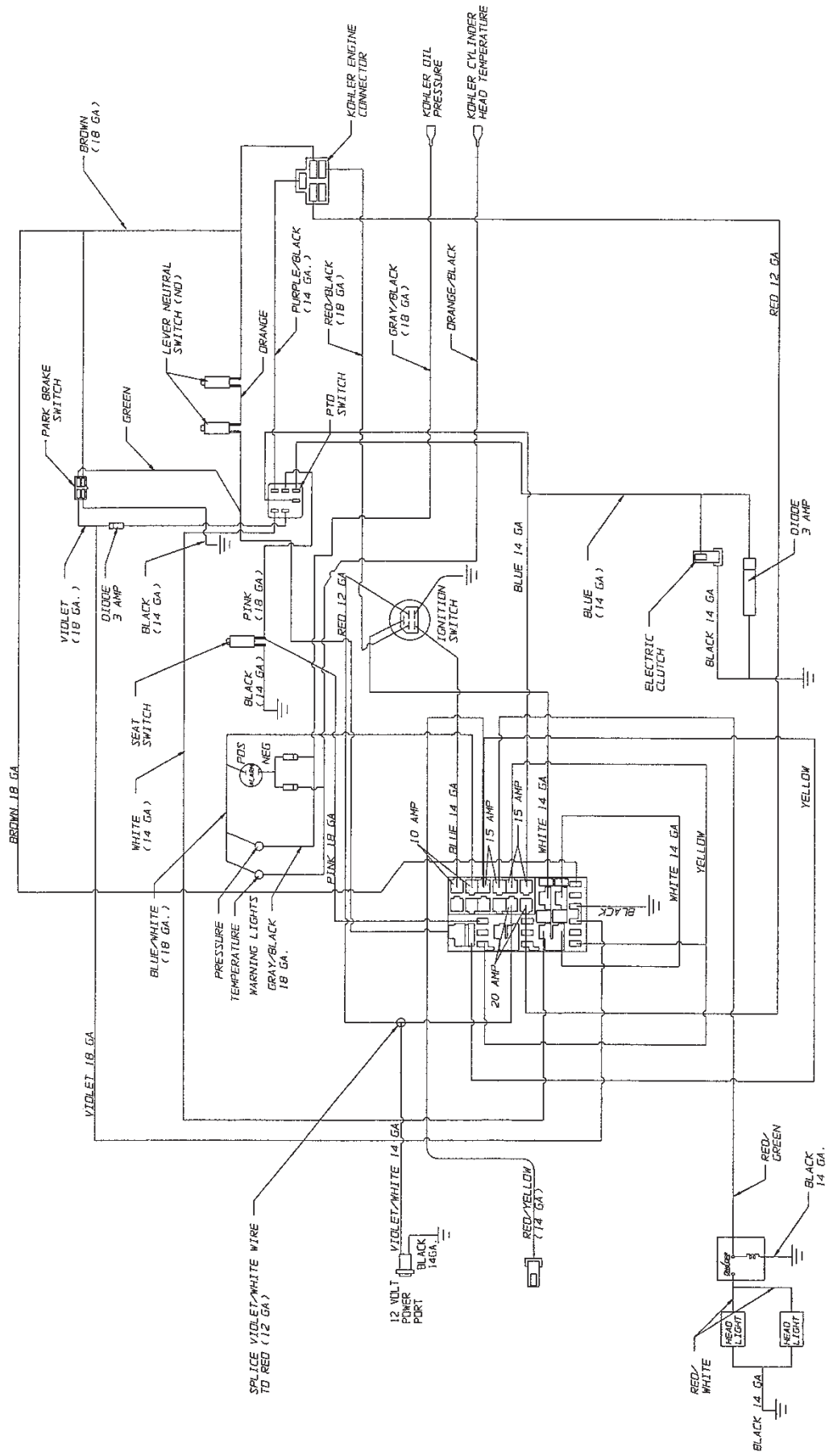

SAFETY DECALS

To promote safe operation, Bush Hog supplies safety decals on all products manufactured. Because damage can occur to safety decals either through shipment, use or reconditioning, Bush Hog will, upon request, provide safety decals for any of our products in the field at no charge. Contact your authorized Bush Hog dealer for more information.

CAUTION

- ★ SHUT OFF ENGINE BEFORE REFUELING
- ★ NEVER FILL FUEL TANK INDOORS OR WHEN ENGINE IS HOT.
- ★ WIPE UP ALL SPILLED GASOLINE BEFORE STARTING ENGINE.
- ★ DO NOT SMOKE WHILE REFUELING.

94131

DANGER

KEEP AWAY!

SHIELD MISSING FROM THIS AREA

TO AVOID SERIOUS INJURY OR DEATH, DO NOT OPERATE WITHOUT THIS AND ALL OTHER SHIELDS IN PLACE AND IN GOOD CONDITION.

50012616

WARNING

ROTATING DRIVE PARTS BENEATH

- ENTANGLEMENT WITH ROTATING DRIVE PARTS CAN CAUSE INJURY OR DEATH.
- DO NOT OPERATE WITHOUT THIS AND ALL OTHER SHIELDS IN PLACE AND IN GOOD CONDITION.

50012615

WARNING

SERIOUS INJURY OR DEATH MAY RESULT FROM MACHINE ROLLOVER

- Failure to follow these instructions could result in serious injury or death.
- Do not operate machine on steep slopes or near drop offs.
- Avoid sharp and/or quick turns.
- Do not exceed the machine weight rating of the rops.
- Always use seat belt.
- Do not jump if machine tips.
- If ROPS is foldable
 - Always keep the ROPS fully extended.
 - WHEN ROPS MUST BE DOWN:
 - Do not use seat belt.
 - Drive with extra care.
- If equipped with seat platform, Do not operate machine without seat platform pins in place.

50048632

DANGER

KEEP AWAY - ROTATING BLADES

SERIOUS INJURY OR DEATH CAN RESULT FROM THROWN OBJECTS OR BLADE CONTACT

- * DO NOT STAND ON OR NEAR MACHINE WHEN IN OPERATION.
- * KEEP HANDS AND FEET AWAY FROM UNDERNEATH CUTTER TO AVOID SERIOUS INJURY.
- * NEVER OPERATE WITHOUT DISCHARGE CHUTE OR VACUUM BLOWER ASSEMBLY IN PLACE.

85020

WARNING

- OPERATE CONTROLS SMOOTHLY AND SLOWLY, ESPECIALLY ON SLOPES.
- DO NOT OPERATE ON STEEP SLOPES: SEE OPERATORS MANUAL FOR DETAILS.
- DO NOT MOW WHERE MACHINE COULD SLIP OR TIP.
- MOVE VERY SLOWLY WHEN ATTACHMENT IS REMOVED.
- ALWAYS LOOK BEHIND MACHINE BEFORE BACKING.
- BACK UP SLOPES. GO FORWARD DOWN SLOPES.

50029501

DANGER

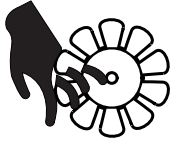

ROTATING BLADES-KEEP AWAY

- KEEP HANDS, HAIR AND CLOTHING AWAY FROM ROTATING BLADES.

50031003

WARNING

TO AVOID SERIOUS INJURY OR DEATH

DO NOT OPERATE MOWER WITHOUT DISCHARGE SHIELD OR DEFLECTOR IN PLACE AND GOOD REPAIR.

83056

WARNING



TO AVOID SERIOUS INJURY OR DEATH,

- * DO NOT ALTER ELECTRICAL SYSTEM. WRONG WIRING CONNECTIONS WILL DAMAGE ELECTRICAL COMPONENTS AND MAY MAKE THE SAFETY SWITCHES INOPERATIVE.
- * ALWAYS REMOVE JEWELRY BEFORE ATTEMPTING REPAIR OR REPLACEMENT OF ELECTRICAL COMPONENTS.

94132

WARNING

TO AVOID SERIOUS INJURY OR DEATH,

- ★ READ OPERATOR'S MANUAL BEFORE OPERATING & FOLLOW ALL PRECAUTIONS. (CONTACT DEALER FOR MANUALS)
- ★ LOWER IMPLEMENT, STOP ENGINE AND REMOVE KEY BEFORE DISMOUNTING.
- ★ NO RIDERS. DO NOT OPERATE MOWER IN VICINITY OF OTHER PERSONS.
- ★ ALLOW NO CHILDREN OR UNQUALIFIED PERSONS TO OPERATE EQUIPMENT.
- ★ CLEAR MOWING AREA OF DEBRIS.
- ★ KEEP SHIELDS AND GUARDS IN PLACE. KEEP CLEAR OF DRIVES AND BELTS.
- ★ SECURELY SUPPORT MOWER & REMOVE KEY BEFORE WORKING UNDERNEATH.
- ★ KNOW HOW TO STOP TRACTOR AND EQUIPMENT QUICKLY IN AN EMERGENCY.
- ★ BE CAREFUL ON UNEVEN TERRAIN. DECREASE SPEED WHEN TURNING.

94134

TORQUE SPECIFICATIONS

Proper torque for American fasteners used on Bush Hog equipment.
Recommended Torque in Foot Pounds (Newton Meters).*

AMERICAN

Bolt Head Markings

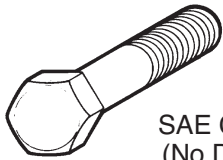

SAE Grade 2
(No Dashes)

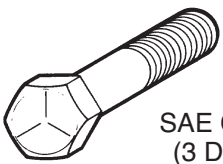

SAE Grade 5
(3 Dashes)

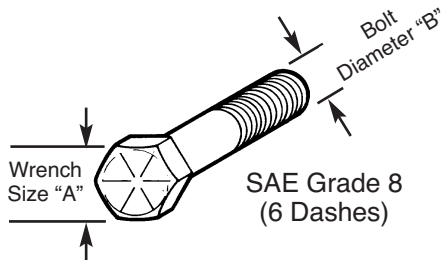

SAE Grade 8
(6 Dashes)

WRENCH SIZE (IN.) "A"	BOLT DIAMETER (IN.) "B" AND THREAD SIZE	SAE GRADE 2	SAE GRADE 5	SAE GRADE 8
7/16	1/4 - 20 UNC	6 (7)	8 (11)	12 (16)
7/16	1/4 - 28 UNF	6 (8)	10 (13)	14 (18)
1/2	5/16 - 18 UNC	11 (15)	17 (23)	25 (33)
1/2	5/16 - 24 UNF	13 (17)	19 (26)	27 (37)
9/16	3/8 - 16 UNC	20 (27)	31 (42)	44 (60)
9/16	3/8 - 24 UNF	23 (31)	35 (47)	49 (66)
5/8	7/16 - 14 UNC	32 (43)	49 (66)	70 (95)
5/8	7/16 - 20 UNF	36 (49)	55 (75)	78 (106)
3/4	1/2 - 13 UNC	49 (66)	76 (103)	106 (144)
3/4	1/2 - 20 UNF	55 (75)	85 (115)	120 (163)
7/8	9/16 - 12 UNC	70 (95)	109 (148)	153 (207)
7/8	9/16 - 18 UNF	79 (107)	122 (165)	172 (233)
15/16	5/8 - 11 UNC	97 (131)	150 (203)	212 (287)
15/16	5/8 - 18 UNF	110 (149)	170 (230)	240 (325)
1-1/8	3/4 - 10 UNC	144 (195)	266 (360)	376 (509)
1-1/8	3/4 - 16 UNF	192 (260)	297 (402)	420 (569)
1-5/16	7/8 - 9 UNC	166 (225)	430 (583)	606 (821)
1-5/16	7/8 - 14 UNF	184 (249)	474 (642)	668 (905)
1-1/2	1 - 8 UNC	250 (339)	644 (873)	909 (1232)
1-1/2	1 - 12 UNF	274 (371)	705 (955)	995 (1348)
1-1/2	1 - 14 UNF	280 (379)	721 (977)	1019 (1381)
1-11/16	1-1/8 - 7 UNC	354 (480)	795 (1077)	1288(1745)
1-11/16	1-1/8 - 12 UNF	397 (538)	890 (1206)	1444 (1957)
1-7/8	1-1/4 - 7 UNC	500 (678)	1120 (1518)	1817 (2462)
1-7/8	1-1/4 - 12 UNF	553 (749)	1241 (1682)	2013 (2728)
2-1/16	1-3/8 - 6 UNC	655 (887)	1470 (1992)	2382 (3228)
2-1/16	1-3/8 - 12 UNF	746 (1011)	1672 (2266)	2712 (3675)
2-1/4	1-1/2 - 6 UNC	870 (1179)	1950 (2642)	3161 (4283)
2-1/4	1-1/2 - 12 UNF	979 (1327)	2194 (2973)	3557 (4820)

METRIC

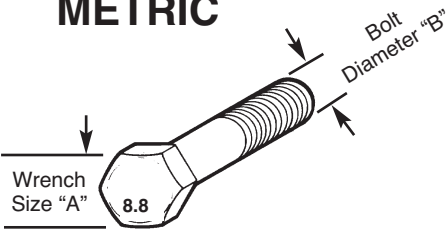

Numbers appearing on bolt heads indicate ASTM class.

Proper torque for metric fasteners used on Bush Hog equipment.
Recommended torque in foot pounds (newton Meters).*

WRENCH SIZE (mm) "A"	BOLT DIA. (mm) "B"	ASTM 4.6	ASTM 8.8	ASTM 9.8	ASTM 10.9
8	5	1.8 (2.4)		5.1 (6.9)	6.5 (8.8)
10	6	3 (4)		8.7 (12)	11.1 (15)
13	8	7.3 (10)		21.1 (29)	27 (37)
16	10	14.5 (20)		42 (57)	53 (72)
18	12	25 (34)	74 (100)	73 (99)	93 (126)
21	14	40 (54)	118 (160)	116 (157)	148 (201)
24	16	62 (84)	167 (226)	181 (245)	230 (312)
30	20	122 (165)	325 (440)		449 (608)
33	22		443 (600)		611 (828)
36	24	211 (286)	563 (763)		778 (1054)
41	27		821 (1112)		1138 (1542)
46	30	418 (566)	1119 (1516)		1547 (2096)

*Use 75% of the specified torque value for plated fasteners. Use 85% of the specified torque values for lubricated fasteners.

PROFESSIONAL SERIES ZERO TURN RIDING MOWERS

Optional Equipment:

Caster Bundle (Available for 61" deck only)

Canopy Kit

Light Kit

Rear Hitch Kit

Mulching Kit 49"

Mulching Kit 55"

Mulching Kit 61"

Striping Kit

Grass Catcher 49", 55" & 61"

SLOPE ANGLE GUIDE

ALIGN THIS EDGE WITH A VERTICAL SURFACE
(TREE, BUILDING, FENCE POST, POLE, ETC.)

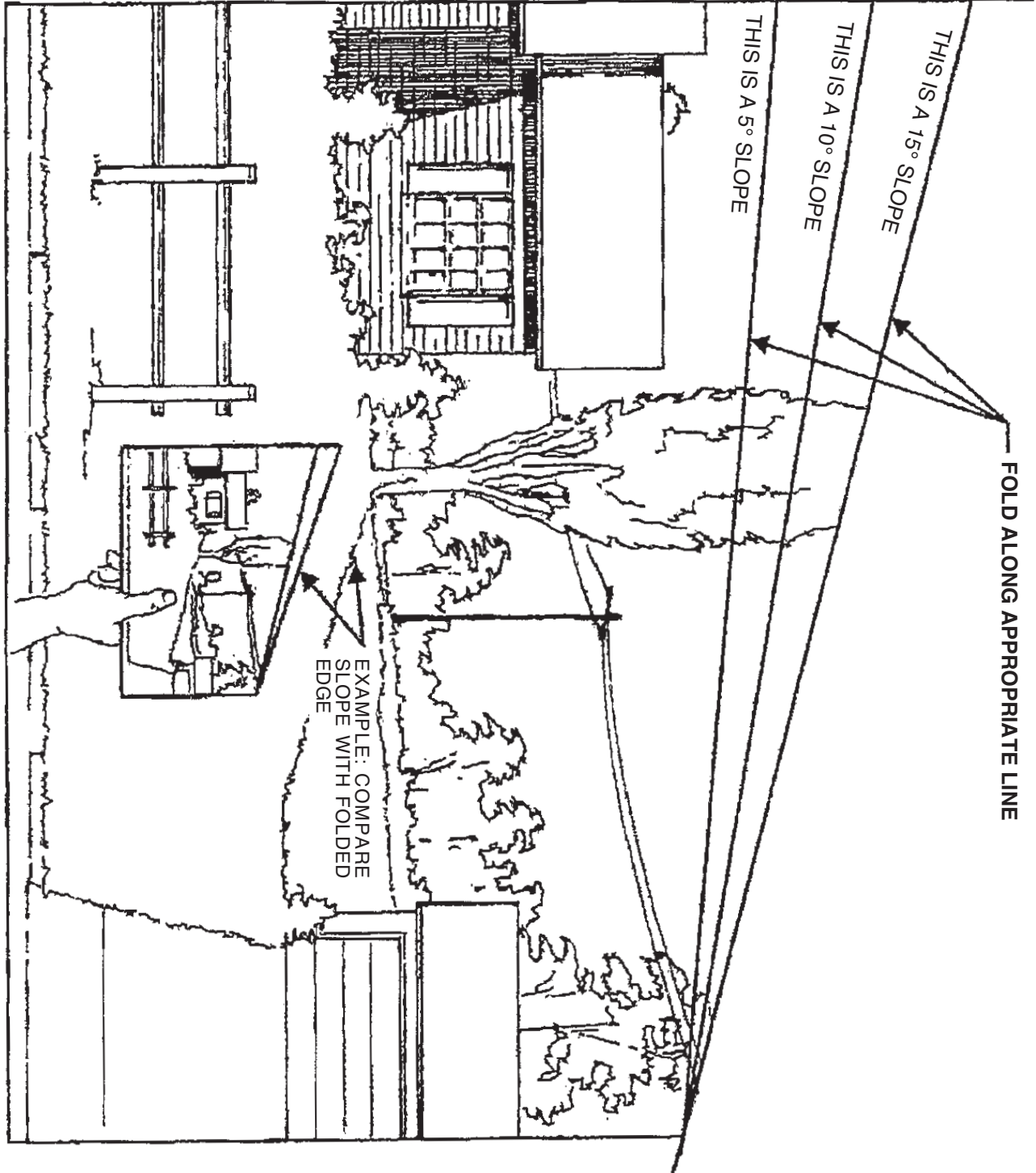

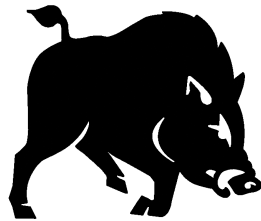

BUSH HOG[®]
Performance You Can Count OnSM

P.O. Box 1039 • Selma, AL 36702-1039
Telephone (334) 874-2700 • www.bushhog.com

Free Manuals Download Website

<http://myh66.com>

<http://usermanuals.us>

<http://www.somanuals.com>

<http://www.4manuals.cc>

<http://www.manual-lib.com>

<http://www.404manual.com>

<http://www.luxmanual.com>

<http://aubethermostatmanual.com>

Golf course search by state

<http://golfingnear.com>

Email search by domain

<http://emailbydomain.com>

Auto manuals search

<http://auto.somanuals.com>

TV manuals search

<http://tv.somanuals.com>