

2010 Cadillac DTS Owner Manual

In Brief	1-1	Theft-Deterrent Systems	3-18
Instrument Panel	1-2	Starting and Operating Your Vehicle	3-22
Initial Drive Information	1-4	Mirrors	3-36
Vehicle Features	1-15	Object Detection Systems	3-40
Performance and Maintenance	1-21	Universal Home Remote System	3-48
Seats and Restraint System	2-1	Storage Areas	3-55
Head Restraints	2-2	Sunroof	3-57
Front Seats	2-3	Instrument Panel	4-1
Rear Seats	2-10	Instrument Panel Overview	4-3
Safety Belts	2-12	Climate Controls	4-36
Child Restraints	2-33	Warning Lights, Gauges, and Indicators	4-45
Airbag System	2-58	Driver Information Center (DIC)	4-61
Restraint System Check	2-75	Audio System(s)	4-88
Features and Controls	3-1	Driving Your Vehicle	5-1
Keys	3-3	Your Driving, the Road, and the Vehicle	5-2
Doors and Locks	3-9	Towing	5-24
Windows	3-14		

2010 Cadillac DTS Owner Manual

Service and Appearance Care	6-1	Maintenance Schedule	7-1
Service	6-3	Maintenance Schedule	7-2
Fuel	6-5	Customer Assistance Information	8-1
Checking Things Under the Hood	6-12	Customer Assistance and Information	8-2
Headlamp Aiming	6-44	Reporting Safety Defects	8-16
Bulb Replacement	6-47	Vehicle Data Recording and Privacy	8-18
Windshield Wiper Blade Replacement	6-48	Index	i-1
Tires	6-50		
Appearance Care	6-96		
Vehicle Identification	6-104		
Electrical System	6-105		
Capacities and Specifications	6-114		

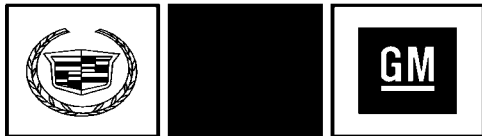

GENERAL MOTORS, GM, the GM Emblem, CADILLAC, the CADILLAC Crest & Wreath, and the name DTS are registered trademarks of General Motors.

This manual describes features that may or may not be on your specific vehicle either because they are options that you did not purchase or due to changes subsequent to the printing of this owner manual. Please refer to the purchase documentation relating to your specific vehicle to confirm each of the features found on your vehicle. For vehicles first sold in Canada, substitute the name "General Motors of Canada Limited" for Cadillac Motor Division wherever it appears in this manual.

Keep this manual in the vehicle for quick reference.

Litho in U.S.A.
Part No. 25897010 B Second Printing

Canadian Owners

Propriétaires Canadiens

A French language copy of this manual can be obtained from your dealer or from:

On peut obtenir un exemplaire de ce guide en français auprès du concessionnaire ou à l'adresse suivante:

Helm, Incorporated
P.O. Box 07130
Detroit, MI 48207

1-800-551-4123

Numéro de poste 6438 de langue française

www.helminc.com

Index

To quickly locate information about the vehicle, use the index in the back of the manual. It is an alphabetical list of what is in the manual and the page number where it can be found.

©2009 General Motors. All Rights Reserved.

Safety Warnings and Symbols

Warning messages found on vehicle labels and in this manual describe hazards and what to do to avoid or reduce them.

Danger indicates a hazard with a high level of risk which will result in serious injury or death.

Warning or **Caution** indicates a hazard that could result in injury or death.



WARNING:

These mean there is something that could hurt you or other people.

Notice: This means there is something that could result in property or vehicle damage. This would not be covered by the vehicle's warranty.

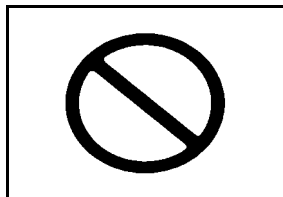

A circle with a slash through it is a safety symbol which means "Do Not," "Do not do this," or "Do not let this happen."

Vehicle Symbols

The vehicle has components and labels that use symbols instead of text. Symbols are shown along with the text describing the operation or information relating to a specific component, control, message, gauge, or indicator.

 : This symbol is shown when you need to see your owner manual for additional instructions or information.

 : This symbol is shown when you need to see a service manual for additional instructions or information.

Vehicle Symbol Chart

Here are some additional symbols that may be found on the vehicle and what they mean. For more information on the symbol, refer to the index.

 : Airbag Readiness Light

 : Air Conditioning

 : Antilock Brake System (ABS)

 : Audio Steering Wheel Controls or OnStar®

 : Brake System Warning Light

 : Charging System

 : Cruise Control

 : Engine Coolant Temperature

 : Exterior Lamps

 : Fog Lamps

 : Fuel Gauge

 : Fuses

 : Headlamp High/Low-Beam Changer

 : LATCH System Child Restraints

 : Malfunction Indicator Lamp

 : Oil Pressure

 : Outside Power Foldaway Mirrors

 : Power

 : Remote Vehicle Start

 : Safety Belt Reminders

 : Tire Pressure Monitor

 : Traction Control

 : Windshield Washer Fluid

Section 1 In Brief

Instrument Panel	1-2	Vehicle Features	1-15
Initial Drive Information	1-4	Radio(s)	1-15
Remote Keyless Entry (RKE) System	1-4	Satellite Radio	1-17
Remote Vehicle Start	1-5	Portable Audio Devices	1-17
Door Locks	1-5	Steering Wheel Controls	1-17
Trunk Release	1-6	Bluetooth®	1-18
Windows	1-6	Navigation System	1-18
Seat Adjustment	1-7	Driver Information Center (DIC)	1-19
Heated and Ventilated Seats	1-8	Cruise Control	1-20
Head Restraint Adjustment	1-8	Power Outlets	1-20
Safety Belt	1-9	Performance and Maintenance	1-21
Sensing System for Passenger Airbag	1-9	Traction Control System (TCS)	1-21
Mirror Adjustment	1-10	StabiliTrak®	1-21
Steering Wheel Adjustment	1-11	Tire Pressure Monitor	1-21
Interior Lighting	1-12	Tire Sealant and Compressor Kit	1-22
Exterior Lighting	1-12	Engine Oil Life System	1-22
Windshield Wiper/Washer	1-13	Driving for Better Fuel Economy	1-23
Climate Controls	1-14	Roadside Service	1-23
		OnStar®	1-24

Instrument Panel

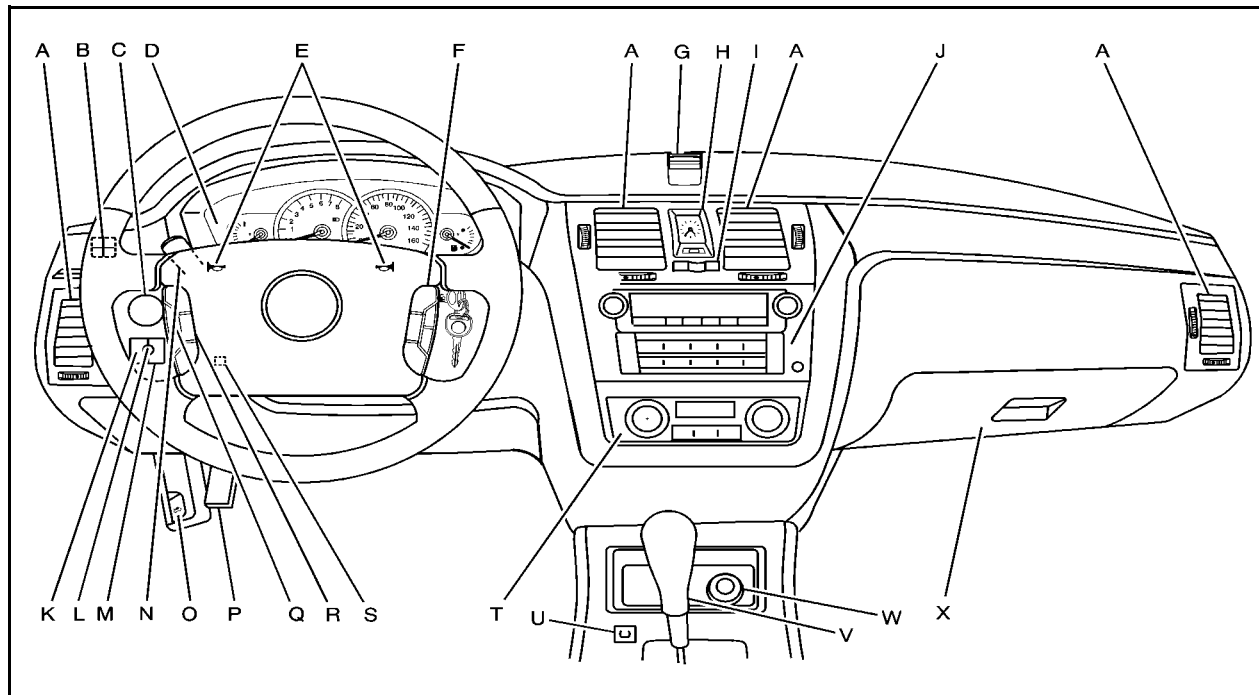

Console-Shift Model shown, Column-Shift Model similar

- A. *Outlet Adjustment on page 4-41.*
- B. *Driver Information Center (DIC) Buttons. See Driver Information Center (DIC) on page 4-61.*
- C. *Exterior Lamps on page 4-25.*
- D. *Instrument Panel Cluster on page 4-46.*
- E. *Horn on page 4-3.*
- F. *Audio Steering Wheel Controls on page 4-120.*
- G. *Ultrasonic Front and Rear Parking Assist (UFRPA) on page 3-40 and Adaptive Cruise Control on page 4-14 (If Equipped).*
- H. *Analog Clock on page 4-35.*
 - I. *Hazard Warning Flashers on page 4-3.*
 - J. *Audio System(s) on page 4-88.*
- K. *Trunk Release Button. See Trunk on page 3-12.*
- L. *Instrument Panel Brightness on page 4-30.*
- M. *Lane Departure Warning (LDW) on page 3-46.*
- N. *Turn Signal/Multifunction Lever on page 4-5.*
- O. *Hood Release on page 6-13.*
- P. *Parking Brake on page 3-30.*
- Q. *Heated Steering Wheel on page 4-4 (If Equipped).*
- R. *Cruise Control on page 4-11 or Adaptive Cruise Control on page 4-14.*
- S. *Tilt Wheel on page 4-3. Power Tilt Wheel and Telescopic Steering Column on page 4-4 (If Equipped).*
- T. *Dual Climate Control System on page 4-36.*
- U. *Traction Control System Button (Console-Shift Vehicles). See Traction Control System (TCS) on page 5-6.*
- V. *Shift Lever. See Automatic Transmission Operation on page 3-27.*
- W. *Accessory Power Outlet(s) on page 4-34.*
- X. *Glove Box on page 3-55. Valet Lockout Switch on page 3-18.*

Initial Drive Information



This section provides a brief overview about some of the important features that may or may not be on your specific vehicle.

For more detailed information, refer to each of the features which can be found later in this owner manual.

Remote Keyless Entry (RKE) System

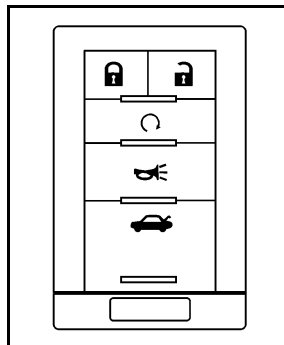
The RKE transmitter is used to remotely lock and unlock the doors from up to 60 m (195 feet) away from the vehicle.





Press  to unlock the driver door. Press  again within five seconds to unlock all remaining doors.

Press  to lock all doors.

Lock and unlock feedback can be personalized.

Press and hold  for approximately one second to open the trunk.

Press  and release to locate the vehicle.

Press  and hold for more than two seconds to sound the panic alarm.



Press  again to cancel the panic alarm.

See *Keys* on page 3-3 and *Remote Keyless Entry (RKE) System Operation* on page 3-4.

Remote Vehicle Start

With this feature the engine can be started from outside of the vehicle.

Starting the Vehicle

1. Aim the RKE transmitter at the vehicle.
2. Press .
3. Immediately after completing Step 2, press and hold  until the turn signal lamps flash.

When the vehicle starts, the parking lamps will turn on and remain on as long as the engine is running. The doors will be locked and the climate control system may come on.

The engine will continue to run for 10 minutes. Repeat the steps for a 10-minute time extension. Remote start can be extended only once.

Canceling a Remote Start

To cancel a remote start:

- Aim the RKE transmitter at the vehicle and press and hold  until the parking lamps turn off.
- Turn on the hazard warning flashers.
- Turn the ignition on and then back off.

See *Remote Vehicle Start on page 3-7*.

Door Locks

From the outside, unlock the door using either the key or the RKE transmitter.

From the inside, use the power door lock switches or manual lock knobs located at the top of the door panel near the window.

Power Door Locks

On vehicles with power door locks, the switches are located on the front doors.

 **(Unlock):** Press to unlock the doors.

 **(Lock):** Remove the key from the ignition and press to lock the doors.

For more information, see:

- *Door Locks on page 3-9.*
- *Power Door Locks on page 3-10.*
- *Remote Keyless Entry (RKE) System Operation on page 3-4.*

Trunk Release

In addition to the trunk release button on the RKE transmitter, there is a remote release  button located to the left of the steering wheel, next to the instrument panel brightness control. Press to open the trunk.

See *Trunk on page 3-12.*

Windows

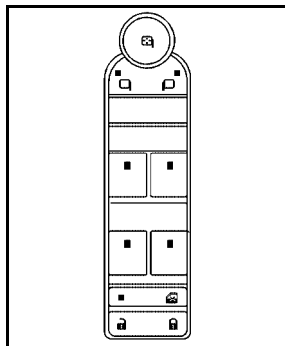

On vehicles with power windows, the switches are on the driver door armrest. Each passenger door has a switch that controls only that window.

Press the switch to lower the window. Pull the switch up to raise it.

For more information, see *Power Windows on page 3-15.*

Seat Adjustment

Power Seats

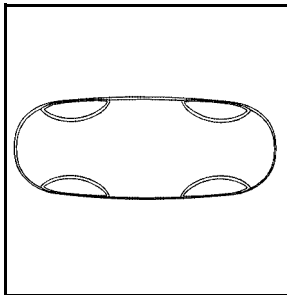

The power seat controls are on the outboard side of the seat.

Move the seat forward or rearward by moving the control forward or rearward.

Raise or lower the front or rear part of the seat cushion by moving the front or rear of the control up or down.

See *Power Seats on page 2-3*.

Power Reclining Seatbacks

The control is located on the outboard side of the seat.

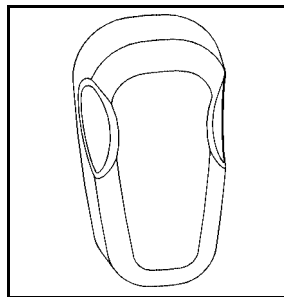

To raise or recline the seatback, tilt the top of the control forward or rearward.

See *Power Reclining Seatbacks on page 2-8*.

Power Lumbar Adjustment

The control is located on the outboard side of the seat.

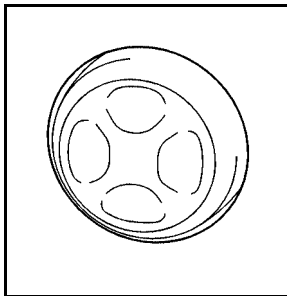

Press the front or rear of the control to increase or decrease lumbar support.

See *Power Lumbar* on page 2-4.

Heated and Ventilated Seats

On vehicles with heated and ventilated seats, the controls are located on the front doors and the ignition must be on to use the feature.

 : Press to heat the seat and seatback.

 : Press to heat the seatback.

 : Press to ventilate the seat and seatback.

For more information see *Heated and Ventilated Seats* on page 2-5.

Head Restraint Adjustment

The vehicle's front seats have adjustable head restraints in the outboard seating positions.

Do not drive until the head restraints for all occupants are installed and adjusted properly.

For more information see *Head Restraints* on page 2-2.

Safety Belt

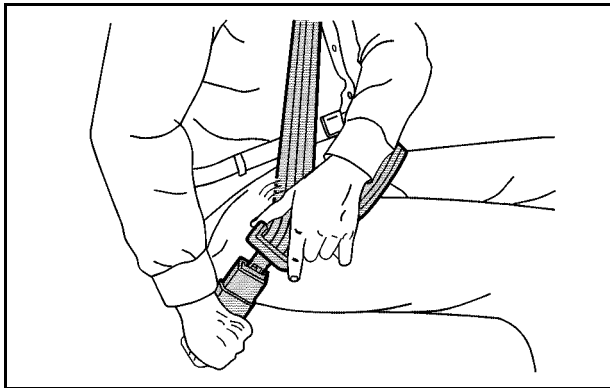

Refer to the following sections for important information on how to use safety belts properly.

- *Safety Belts: They Are for Everyone on page 2-12.*
- *How to Wear Safety Belts Properly on page 2-17.*
- *Lap-Shoulder Belt on page 2-26.*
- *Lap Belt on page 2-32.*
- *Lower Anchors and Tethers for Children (LATCH) on page 2-45.*

Sensing System for Passenger Airbag

The passenger sensing system will turn off the right front passenger frontal airbag and seat-mounted side impact airbag under certain conditions. The driver airbags and roof-rail airbags are not affected by this.

The passenger airbag status indicator will be visible on the overhead console when the vehicle is started.

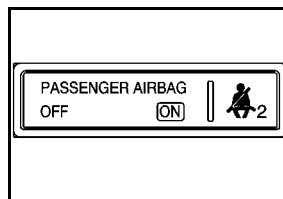

United States

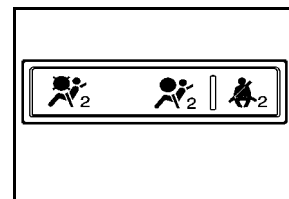

Canada

See *Passenger Sensing System* on page 2-68 for important information.

Mirror Adjustment

Exterior Mirrors

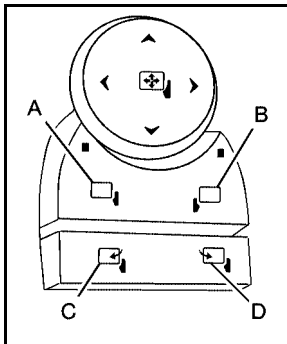

Controls for the outside power folding mirrors are located on the driver door armrest.

Press the selector switch (A) or (B) to choose either the left or right outside mirror. Then press the control pad to move the mirror to the desired direction.

To fold the mirrors:

Press the selector switch (C) to fold the mirrors out, then press (D) to fold the mirror toward the vehicle.

The vehicle may also have an automatic dimming feature on the driver side mirror that adjusts for the glare of headlamps behind you. This feature is controlled by the on and off settings on the automatic dimming inside rearview mirror.

For more information, see:

- *Outside Power Foldaway Mirrors on page 3-37*
- *Automatic Dimming Rearview Mirror on page 3-36*

Interior Mirror

The vehicle has an automatic dimming inside rearview mirror. Automatic dimming reduces the glare of lights from behind the vehicle. The dimming feature comes on and the indicator light illuminates each time the vehicle is started.

See *Automatic Dimming Rearview Mirror on page 3-36*.

Steering Wheel Adjustment

This feature allows the position of the steering wheel to be adjusted.

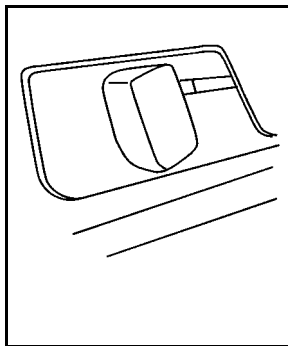

The adjustment lever is located on the left side of the steering column.

1. Pull the lever to move the steering wheel up or down.
2. Release the lever to lock the wheel in place.

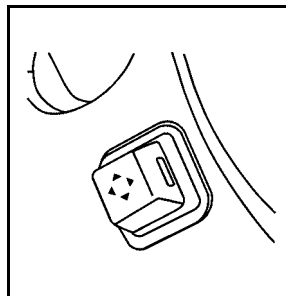

For vehicles with a power tilt wheel control:

- Push the control up or down to tilt the steering wheel up or down.
- Push the control forward or rearward to move the steering wheel toward the front or rear of the vehicle.

See *Tilt Wheel* on page 4-3 or *Power Tilt Wheel and Telescopic Steering Column* on page 4-4 (If Equipped).

Interior Lighting

Courtesy Lamps

The courtesy lamps are located on the headliner above the rear seat. These lamps come on by turning the instrument panel brightness knob fully clockwise or when any door is opened and it is dark outside.

Reading Lamps

The reading lamps are located on the overhead console on the headliner and in the rear door opening. These lamps come on automatically when any door is opened and it is dark outside.

For manual operation, press the button to turn them on or off.

If the reading lamps are left on, they automatically shut off 10 minutes after the ignition has been turned off.

For more information, see:

- *Instrument Panel Brightness on page 4-30.*
- *Entry Lighting on page 4-31.*
- *Parade Dimming on page 4-31.*
- *Footwell Lamps on page 4-32.*

Exterior Lighting

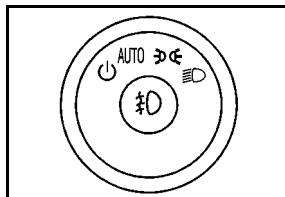



This control is located on the instrument panel, to the left of the steering wheel.

: Turns off the exterior lamps, except Daytime Running Lamps (DRL).

AUTO: Automatic operation of the headlamps at normal brightness, other exterior lamps and IntelliBeam™ .

: Manual operation of the parking lamps and other exterior lamps.

: Manual operation of the headlamps and other exterior lamps.

 : Press to turn on the fog lamps.

For more information, see:

- *Exterior Lamps on page 4-25.*
- *Daytime Running Lamps (DRL) on page 4-29.*
- *Fog Lamps on page 4-30.*
- *Wiper Activated Headlamps on page 4-28.*

Windshield Wiper/Washer

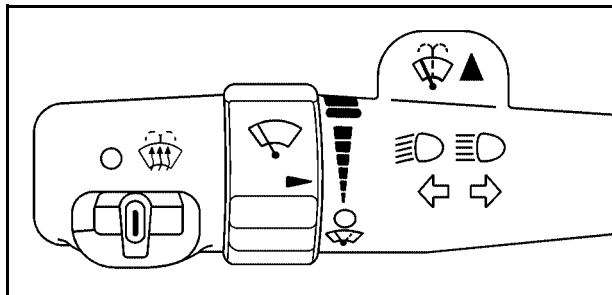

The windshield wiper lever is located on the left side of the steering column.

☂: Use for a single wiping cycle.

☂: Delays wiping cycle.

▬: Slow wipes.

▬: Fast wipes.

○: Turns the wipers off.

☂: Press and release this paddle, located at the top of the turn signal/multifunction lever, to spray washer fluid on the windshield.

See *Windshield Wipers* on page 4-10 and *Windshield Washer* on page 4-11.

Climate Controls

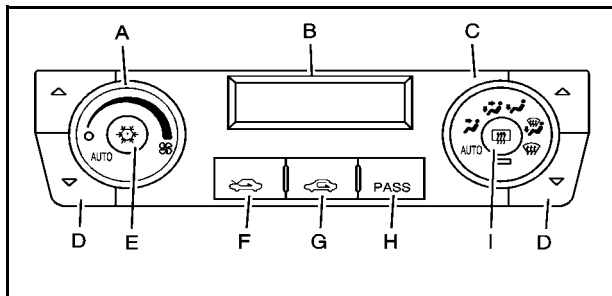

Dual Climate Control System

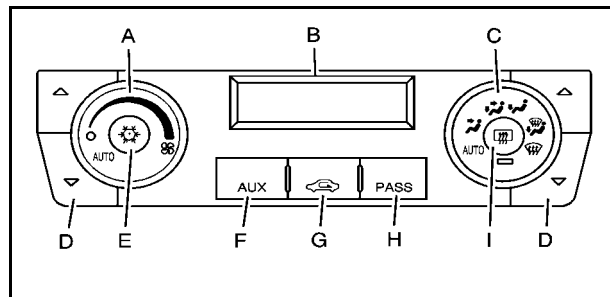

**Dual Climate Control System for Vehicles
with Rear Climate Control**

- | | |
|---|--|
| A. Fan Control | E. Air Conditioning |
| B. Display | F. Outside Air or AUX |
| C. Air Delivery
Mode Control | G. Air Recirculation |
| D. Driver and
Passenger
Temperature
Controls | H. PASS (Passenger
Climate Control) |
| | I. Rear Window
Defogger |

See *Dual Climate Control System* on page 4-36.
For vehicles with rear climate control, see *Rear Climate
Control System* on page 4-42.

Vehicle Features

Radio(s)

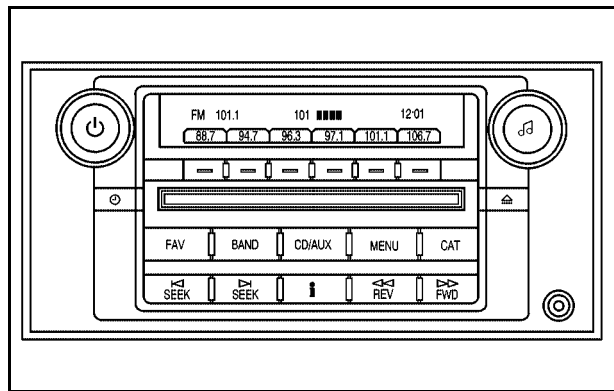

Radio with CD

 : Press to turn the system on and off. Turn to increase or decrease the volume.

BAND: Press to switch between AM, FM, or XM™. The selection displays.

 : Turn to select radio stations.

 **SEEK**  : Press to seek or scan stations.

i (XM™ Satellite Radio Service, MP3/WMA, and RDS Features): Press this button to display additional text information related to the current FM-RDS or XM station, or MP3/WMA song. When information is not available, No Info displays.

For more information about these and other radio features, see *Audio System(s)* on page 4-88.

Storing a Favorite Station

For vehicles with an XM radio, a maximum of 36 stations can be stored as favorites using the six softkeys located below the radio station frequency tabs and by using the radio FAV button. Press FAV to go through up to six pages of favorites, each having six favorite stations available per page. Each page of favorites can contain any combination of AM, FM, or XM stations.

See *Radio(s) (MP3)* on page 4-93.

Setting the Clock

The vehicle has an analog clock as well as the digital radio clock. At the time of new vehicle delivery, the digital radio clock display should be disabled. To use the digital radio clock and the analog clock, see detailed instructions in *Setting the Clock on page 4-89* for your specific audio system.



The radio clock and analog clock are not synchronized. Occasionally you might need to set the digital radio clock using the procedure below to synchronize both clocks.

Enabling/Disabling the Digital Radio Clock (Single CD Player)

1. Turn the radio on.
2. Press the  button until the clock and date setting menus appear.
3. Press the pushbutton located under the forward arrow tab until the menu for default clock and date settings appear.

4. Press the pushbutton located under the currently displayed status of either ON or OFF. The ON display indicates the radio clock display is disabled and the OFF display indicates the radio clock display is enabled. Press this pushbutton to toggle the radio clock display on or off.

Setting the Time and Date (Single CD Player)

1. Turn the radio on.
2. Press  and HR, MIN, MM, DD, YYYY (hour, minute, month, day, and year) displays.
3. Press the pushbutton located below any one of the tabs that you want to change.
4. Increase or decrease the time or date by turning  clockwise or counterclockwise.

Satellite Radio

XM is a satellite radio service that is based in the 48 contiguous United States and 10 Canadian provinces. XM satellite radio has a wide variety of programming and commercial-free music, coast-to-coast, and in digital-quality sound.

A fee is required to receive the XM service.

For more information, refer to:

- www.xmradio.com or call 1-800-929-2100 (U.S.)
- www.xmradio.ca or call 1-877-438-9677 (Canada)

See “XM Satellite Radio Service” under *Radio(s)* (MP3) on page 4-93.

Portable Audio Devices

This vehicle may have an auxiliary input, located on the audio faceplate. External devices such as iPod®, laptop computers, MP3 players, CD changers, etc. can be connected to the auxiliary port using a 3.5 mm (1/8 in) input jack.

See “Using the Auxiliary Input Jack” under *Radio(s)* (MP3) on page 4-93.

Steering Wheel Controls

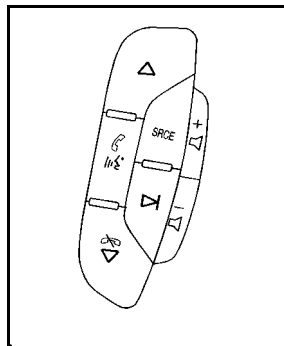

If equipped, these controls are located on the right side of the steering wheel.

△ : Press to go to the next radio station stored as a favorite, or the next track if a CD/DVD is playing.

🔇 : Press to silence the vehicle speakers only. Press again to turn the sound on. Press and hold longer than two seconds to interact with OnStar® or Bluetooth® systems.

+ - : Increases or decreases volume.

🔍 ▽ : Press to go to the previous radio station stored as a favorite, the next track if a CD/DVD is playing, to reject an incoming call, or end a current call.

SRCE : Press to switch between the radio, CD, and for vehicles with, DVD, front auxiliary, and rear auxiliary.

▷ : Press seek the next radio station, or to select tracks on a CD or DVD.

For more information, see *Audio Steering Wheel Controls* on page 4-120.

Bluetooth®

For vehicles with an in-vehicle Bluetooth system, it allows users with a Bluetooth enabled cell phone to make and receive hands-free calls using the vehicle's audio system and controls.

The Bluetooth enabled cell phone must be paired with the in-vehicle Bluetooth system before it can be used in the vehicle. Not all phones will support all functions. For more information visit www.gm.com/bluetooth.

For more information, see *Bluetooth®* on page 4-110.

Navigation System

The vehicle's navigation system provides detailed maps of most major freeways and roads throughout the United States and Canada. After a destination has been set, the system provides turn-by-turn instructions for reaching the destination. In addition, the system can help locate a variety of points of interest (POI), such as banks, airports, restaurants, and more.

See the vehicle's Navigation System manual for more information.

Driver Information Center (DIC)

The DIC display is located at the bottom of the instrument panel cluster. It shows the status of many vehicle systems and enables access to the personalization menu.

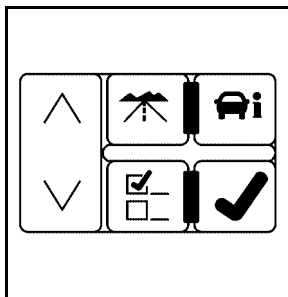



The DIC buttons are located on the instrument panel to the left of the steering wheel.

 : Press to scroll through the trip and fuel displays.

 : Press to scroll through the vehicle information displays.

 : Press to customize the feature settings on your vehicle. See *DIC Vehicle Customization on page 4-79* for more information.

 : Press to reset certain DIC features and to acknowledge DIC warning messages and clear them from the DIC display.

 : Press to scroll up and down the menu items.

For more information, see *Driver Information Center (DIC) on page 4-61*.

Vehicle Customization

Some vehicle features can be programmed by using the DIC buttons on the instrument panel to the left of the steering wheel. These features include:

- Language
- Door Lock and Unlock Settings
- Lighting
- Chime Volume
- Memory Settings
- Remote Start

See *DIC Vehicle Customization on page 4-79*.

Cruise Control

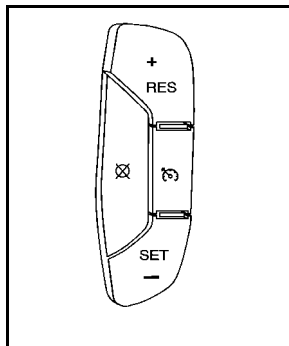

The cruise control buttons are located on the left side of the steering wheel.

 : Turns on the cruise control system.

+ RES: Press to accelerate or resume speed.

SET- : Press to set the speed.

 : Press to cancel cruise control.

For more information, see *Cruise Control on page 4-11*.
For vehicles with adaptive cruise control, see *Adaptive Cruise Control on page 4-14*.

Power Outlets

The accessory power outlets can be used to plug in electrical equipment, such as a cellular telephone.

If the vehicle has a center console, the power outlet is located inside the lower storage area. Some vehicles may have an outlet on the right front lower part of the driver's seat and under the climate control system next to the ashtray.

There are two accessory power outlets in the rear seat area located on the door armrests next to the ashtrays.



To use the outlet, remove the cover.

See *Accessory Power Outlet(s) on page 4-34*.

Performance and Maintenance

Traction Control System (TCS)

The traction control system limits wheel spin. The system turns on automatically every time the vehicle is started.

- To turn off traction control, press and release  in front of the shift lever.  illuminates and the appropriate DIC message is displayed. See *DIC Warnings and Messages* on page 4-66.
- Press and release the button again to turn on traction control.

For more information, see *Traction Control System (TCS)* on page 5-6.

StabiliTrak[®]

The vehicle may have the StabiliTrak system that assists with directional control of the vehicle in difficult driving conditions. The system turns on automatically every time the vehicle is started. The system cannot be turned off.

For more information, see *StabiliTrak[®] System* on page 5-5.

Tire Pressure Monitor

This vehicle may have a Tire Pressure Monitor System (TPMS).

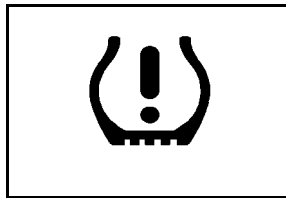

The Tire Pressure Monitor alerts you when a significant reduction in pressure occurs in one or more of the vehicle's tires by illuminating the low tire pressure warning light on the instrument cluster.

If the warning light comes on, stop as soon as possible and inflate the tires to the recommended pressure shown on the tire loading information label located on the driver side center pillar (B pillar). See *Loading the Vehicle* on page 5-18. The warning light will remain on until the tire pressure is corrected.

You may notice during cooler conditions that the low tire pressure warning light will appear when the vehicle is first started and then turn off as you drive. This may be an early indicator that your tire pressures are getting low and the tires need to be inflated to the proper pressure.

The Tire Pressure Monitor can alert you about low tire pressure, but it does not replace normal monthly tire maintenance. It is the driver's responsibility to maintain correct tire pressures.

See *Tire Pressure Monitor System on page 6-62* and *Tire Pressure Monitor Operation on page 6-63*.

Tire Sealant and Compressor Kit

This vehicle may come with a jack and spare tire or a tire sealant and compressor kit. The kit can be used to seal small punctures in the tread area of the tire.

See *Tire Sealant and Compressor Kit on page 6-77* for complete operating information.

Engine Oil Life System

The engine oil life system calculates engine oil life based on vehicle use and displays a DIC message when it is necessary to change the engine oil and filter. The oil life system should be reset to 100% only following an oil change.

Resetting the Oil Life System

1. Turn the ignition to ON/RUN, with the engine off.
2. Press the DIC INFO button until OIL LIFE REMAINING displays.
3. Press and hold the DIC INFO RESET button until 100% displays.
4. Turn the key to LOCK/OFF.

See *Engine Oil Life System on page 6-18*.

Driving for Better Fuel Economy

Driving habits can affect fuel mileage. Here are some driving tips to get the best fuel economy possible.

- Avoid fast starts and accelerate smoothly.
- Brake gradually and avoid abrupt stops.
- Avoid idling the engine for long periods of time.
- When road and weather conditions are appropriate, use cruise control, if equipped.
- Always follow posted speed limits or drive more slowly when conditions require.
- Keep vehicle tires properly inflated.
- Combine several trips into a single trip.
- Replace the vehicle's tires with the same TPC Spec number molded into the tire's sidewall near the size.
- Follow recommended scheduled maintenance.

Roadside Service

U.S. or Canada: **1-800-882-1112**

TTY Users: **1-888-889-2438**

As the owner of a new Cadillac, you are automatically enrolled in the Roadside Service program which is available 24 hours a day, 365 days a year.

Roadside Service and OnStar

If you have a current OnStar subscription, press the OnStar button and the current GPS location will be sent to an OnStar Advisor who will assess your problem, contact Roadside Service, and relay exact location to get you the help you need.

Online Owner Center

The Online Owner Center is a complimentary service that includes online service reminders, vehicle maintenance tips, online owner manual, special privileges and more.

Sign up today at: **www.gmownercenter.com/cadillac** (U.S.) or **www.gm.ca** (Canada).

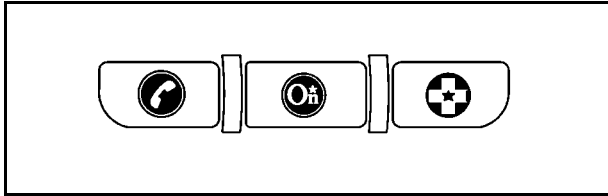

OnStar® uses several innovative technologies and live advisors to provide a wide range of safety, security, navigation, diagnostics, and calling services.

Automatic Crash Response

In a crash, built in sensors can automatically alert an OnStar advisor who is immediately connected to the vehicle to see if you need help.

How OnStar Service Works

On : This blue button connects you to a specially trained OnStar advisor to verify your account information and to answer questions.

+ : Push this red emergency button to get priority help from specially trained OnStar emergency advisors.



☎ : Push this button for hands-free, voice-activated calling and to give voice commands for turn-by-turn navigation.

Crisis Assist, Stolen Vehicle Assistance, Vehicle Diagnostics, Remote Door Unlock, Roadside Assistance, Turn-by-Turn Navigation and Hands-Free Calling are available on most vehicles. Not all OnStar services are available on all vehicles. For more information see the OnStar Owner's Guide or visit www.onstar.com (U.S.) or www.onstar.ca (Canada), contact OnStar at 1-888-4-ONSTAR (1-888-466-7827) or TTY 1-877-248-2080, or press **On** to speak with an OnStar advisor 24 hours a day, 7 days a week.

For a full description of OnStar services and system limitations, see the OnStar Owner's Guide in the glove box.

OnStar service is subject to the OnStar terms and conditions included in the OnStar Subscriber Information.

OnStar service cannot work unless the vehicle is in a place where OnStar has an agreement with a wireless service provider for service in that area. OnStar service also cannot work unless the vehicle is in a place where the wireless service provider OnStar has hired for that area has coverage, network capacity and reception when the service is needed, and technology that is compatible with the OnStar service. Not all services are available everywhere, particularly in remote or enclosed areas, or at all times.

The OnStar system can record and transmit vehicle information. This information is automatically sent to an OnStar call center when  is pressed,  is pressed, or if the airbags or ACR system deploy.

This information usually includes the vehicle's GPS location and, in the event of a crash, additional information regarding the crash that the vehicle was involved in (e.g. the direction from which the vehicle was hit). When the virtual advisor feature of OnStar hands-free calling is used, the vehicle also sends OnStar the vehicle's GPS location so they can provide services where it is located.

Location information about the vehicle is only available if the GPS satellite signals are unobstructed and available.

The vehicle must have a working electrical system, including adequate battery power, for the OnStar equipment to operate. There are other problems OnStar cannot control that may prevent OnStar from providing OnStar service at any particular time or place. Some examples are damage to important parts of the vehicle in a crash, hills, tall buildings, tunnels, weather or wireless phone network congestion.



OnStar Steering Wheel Controls

This vehicle may have a Talk/Mute button that can be used to interact with OnStar hands-free calling. See *Audio Steering Wheel Controls* on page 4-120 for more information.

On some vehicles, the mute button can be used to dial numbers into voice mail systems, or to dial phone extensions. See the OnStar Owner's Guide for more information.

Your Responsibility

Increase the volume of the radio if the OnStar advisor cannot be heard.

If the light next to the OnStar buttons is red, the system may not be functioning properly. Press  and request a vehicle diagnostic. If the light appears clear (no light is appearing), your OnStar subscription has expired and all services have been deactivated. Press  to confirm that the OnStar equipment is active.

Section 2 Seats and Restraint System

Head Restraints	2-2	Child Restraint Systems	2-41
Front Seats	2-3	Where to Put the Restraint	2-44
Power Seats	2-3	Lower Anchors and Tethers for Children (LATCH)	2-45
Power Lumbar	2-4	Securing a Child Restraint in a Rear Seat Position	2-51
Massaging Lumbar	2-4	Securing a Child Restraint in the Center Front Seat Position	2-53
Heated and Ventilated Seats	2-5	Securing a Child Restraint in the Right Front Seat Position	2-54
Memory Seat, Mirrors and Steering Wheel	2-6	Airbag System	2-58
Power Reclining Seatbacks	2-8	Where Are the Airbags?	2-61
Center Seat	2-9	When Should an Airbag Inflate?	2-63
Rear Seats	2-10	What Makes an Airbag Inflate?	2-65
Heated Seats	2-10	How Does an Airbag Restrain?	2-65
Rear Seat Pass-Through Door	2-11	What Will You See After an Airbag Inflates? ...	2-66
Power Lumbar	2-11	Passenger Sensing System	2-68
Safety Belts	2-12	Servicing Your Airbag-Equipped Vehicle	2-73
Safety Belts: They Are for Everyone	2-12	Adding Equipment to Your Airbag-Equipped Vehicle	2-74
How to Wear Safety Belts Properly	2-17	Restraint System Check	2-75
Lap-Shoulder Belt	2-26	Checking the Restraint Systems	2-75
Safety Belt Use During Pregnancy	2-31	Replacing Restraint System Parts After a Crash	2-76
Lap Belt	2-32		
Safety Belt Extender	2-33		
Child Restraints	2-33		
Older Children	2-33		
Infants and Young Children	2-37		

Head Restraints

The front seats have adjustable head restraints in the outboard seating positions.

WARNING:

With head restraints that are not installed and adjusted properly, there is a greater chance that occupants will suffer a neck/spinal injury in a crash. Do not drive until the head restraints for all occupants are installed and adjusted properly.

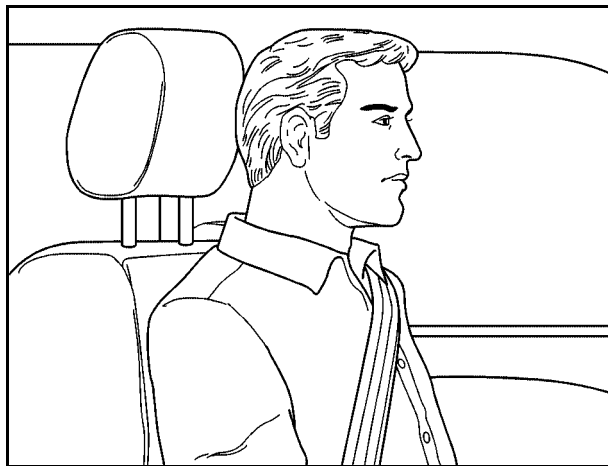

Adjust the head restraint so that the top of the restraint is at the same height as the top of the occupant's head. This position reduces the chance of a neck injury in a crash.

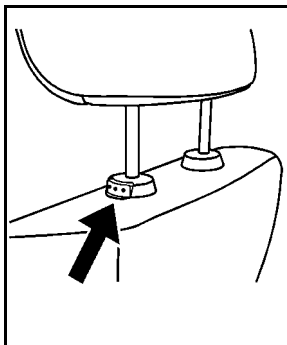

Pull the head restraint up to raise it. To lower the head restraint, press the button, located on the top of the seatback, and push the restraint down.

Push down on the head restraint after the button is released to make sure that it is locked in place.

The head restraints are not designed to be removed.

Front Seats

Power Seats

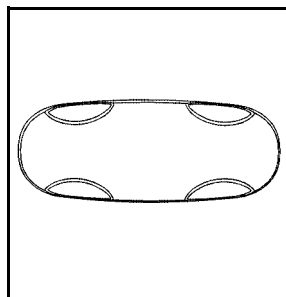

The power seat controls are located on the outboard side of the seats.

- Move the seat forward or rearward by sliding the control forward or rearward.
- Raise or lower the front part of the seat cushion by moving the front of the control up or down.
- Raise or lower the rear part of the seat cushion by moving the rear of the control up or down.

The front seats also have power reclining seatbacks. See *Power Reclining Seatbacks* on page 2-8.

On vehicles with the memory feature, memory settings can be programmed and recalled for seat positions. See *Memory Seat, Mirrors and Steering Wheel* on page 2-6.

Power Lumbar

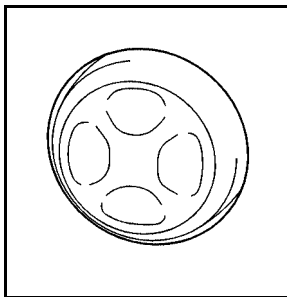

The power lumbar controls are located on the outboard side of the front seats.

Press the front or rear of the lumbar control to increase or decrease support. Press the top or bottom of the control to raise or lower the support mechanism.

Massaging Lumbar

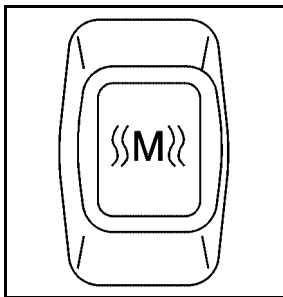

On vehicles with this feature, the switch is located on the outboard side of the front seats behind the lumbar switch.

Press the switch to turn the massaging lumbar feature on. The ignition must be on for this feature to work. The massage cycle will run for up to 10 minutes. To stop massage, press the massaging lumbar switch again or press the power lumbar switch.

Heated and Ventilated Seats

On vehicles with heated and ventilated seats, the ignition must be on to use the feature.

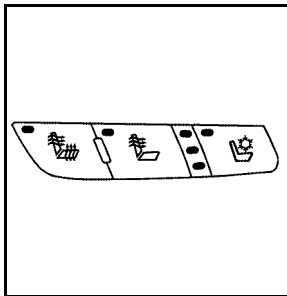

The buttons are located on the front doors.

Driver's Side Buttons shown

 **(Heated Seat Cushion and Seatback):** Press this button to heat the seat cushion and seatback.

 **(Heated Seatback):** Press this button to heat the seatback.

 **(Ventilated Seat Cushion and Seatback):** Press this button to cool the seat cushion and seatback.

Press each button to turn on the desired feature. A light on that button will display indicating which feature is on.

There are three temperature settings for each feature. A column of three lights next to the buttons will display which setting the feature is in: high, medium or low. Three lights indicate the highest setting, two lights indicate medium and one light indicates the lowest setting.

When you press a button, the feature will turn on at the highest setting. Each time you press the button, the feature will decrease one temperature setting.

To turn the feature off, keep pressing the button until the display lights turn off.

If your vehicle has remote vehicle start and is started using the remote keyless entry transmitter, the front heated seats will be turned on to the high setting if it is cold outside. See "Remote Vehicle Start" under *Remote Keyless Entry (RKE) System Operation on page 3-4*. When the key is inserted into the ignition and the ignition is turned on, the heated seat feature will turn off. To turn the heated seat feature back on, press the desired button.

Memory Seat, Mirrors and Steering Wheel

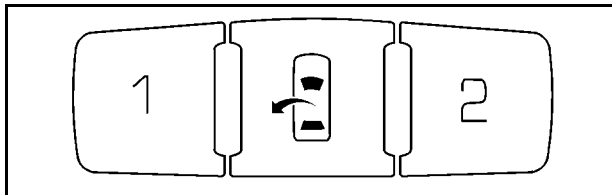

On vehicles with the memory package, the controls are located on the driver door panel. The controls are used to program and recall memory settings for the driver seat, outside mirror, and steering wheel position if the vehicle has the power tilt wheel and telescopic steering feature.

To save positions in memory:

1. Adjust the driver seat, including the seatback recliner and lumbar, both outside mirrors, and the steering wheel to a comfortable position.
2. Press and hold button 1 until two beeps sound through the driver side front speaker to let you know that the position has been stored.

A second seating, mirror, and steering wheel position can be programmed by repeating the previous steps and pressing button 2 for a second driver.

To recall memory positions, the vehicle must be in P (Park). Press and release either button 1 or button 2 corresponding to the desired driving position. The seat, outside mirrors, and steering wheel will move to the position previously stored for the identified driver. You will hear a single beep.

If you use the RKE transmitter to enter the vehicle and the remote recall memory feature is on, automatic seat and mirror movement will occur. See “MEMORY SEAT RECALL” under *DIC Vehicle Customization on page 4-79* for more information.

To stop recall movement of the memory feature at any time, press one of the power seat controls, memory buttons, power tilt wheel control, or power mirror buttons.

If something has blocked the driver seat and/or the steering column while recalling a memory position, the driver seat and/or the steering column recall may stop. If this happens remove the obstruction, then press the appropriate control for the area that is not recalling for two seconds. Try recalling the memory position again by pressing the appropriate memory button. If the memory position is still not recalling, see your dealer for service.

Easy Exit Recall

The control for this feature is located on the driver door panel between buttons 1 and 2.

With the vehicle in P (Park), the exit position can be recalled by pressing the exit button. You will hear a single beep. The driver seat will move back, and if the vehicle has the power tilt wheel and telescopic steering feature, the power telescopic steering column will move up and forward.

If the easy exit seat feature is on in the DIC, automatic seat and power telescopic steering column movement will occur when the key is removed from the ignition. See “EASY EXIT RECALL” under *DIC Vehicle Customization on page 4-79* for more information.

Further programming for automatic seat and steering wheel movement can be done using the Driver Information Center (DIC). You can select or not select the following:

- The easy exit recall feature
- The memory seat recall feature

For programming information, see *DIC Vehicle Customization on page 4-79*.

Power Reclining Seatbacks

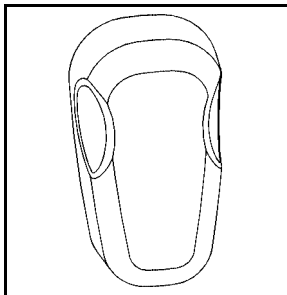

The seats have power reclining seatbacks. Use the vertical power seat control located on the outboard side of the seat.

- Press the control toward the rear of the vehicle to recline the seatback.
- Press the control toward the front of the vehicle to raise the seatback.

WARNING:

Sitting in a reclined position when the vehicle is in motion can be dangerous. Even when buckled up, the safety belts cannot do their job when reclined like this.

The shoulder belt cannot do its job because it will not be against your body. Instead, it will be in front of you. In a crash, you could go into it, receiving neck or other injuries.

The lap belt cannot do its job either. In a crash, the belt could go up over your abdomen. The belt forces would be there, not at your pelvic bones. This could cause serious internal injuries.

For proper protection when the vehicle is in motion, have the seatback upright. Then sit well back in the seat and wear the safety belt properly.

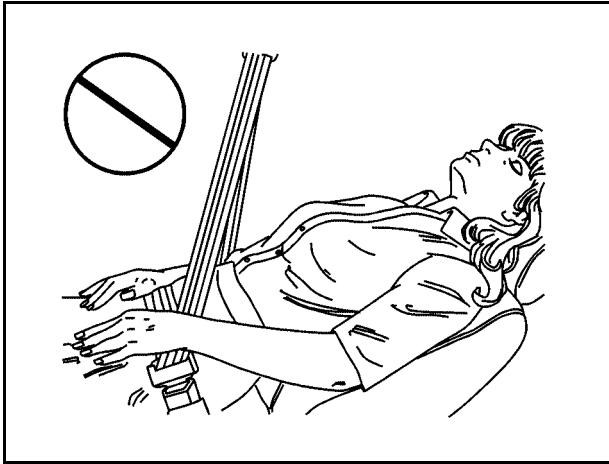

Do not have a seatback reclined if the vehicle is moving.

Center Seat

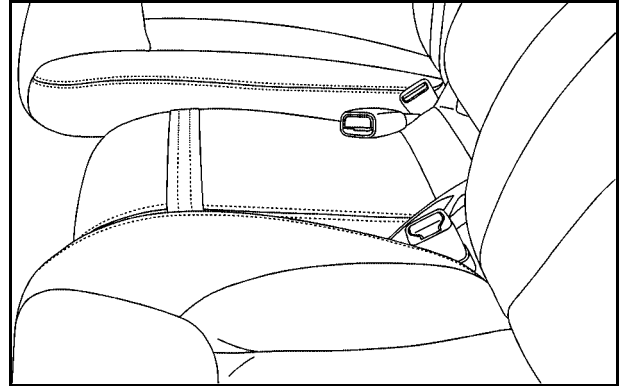

The vehicle may have a front center seat. This seat can be converted to a storage area by lowering the seatback. See *Center Flex Storage Unit* on page 3-56.

Rear Seats

Heated Seats

Your vehicle may have heated rear seats.

To operate the rear heated seats, the ignition must be on.

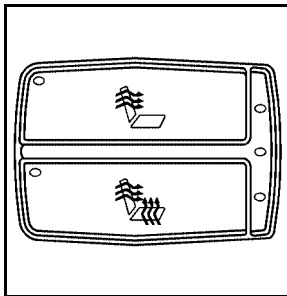

The buttons are located on the rear doors.

 **(Heated Seatback):** Press to turn on the heated seatback.

 **(Heated Seat and Seatback):** Press to turn on the heated seat and seatback.

Press a button to turn on the desired feature. A light on that button will display to show which feature is on.

Each feature has three temperature settings indicated by three lights next to the buttons. The highest setting shows three lights, two is medium and one is the lowest.

When you press a button, the feature will turn on at the highest setting. Each time you press the button, the feature will go down one temperature setting.

To turn the feature off, keep pressing the button until the display lights turn off.

Rear Seat Pass-Through Door

Your vehicle has a pass-through door that provides access to the trunk from the rear seats. See “Rear Seat Pass-Through Door” under *Trunk on page 3-12*.

Power Lumbar

Your vehicle may be equipped with four-way lumbar support, without the massage feature, for the outboard rear seat positions.

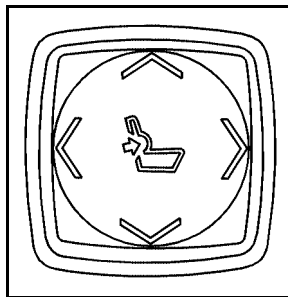

The rear lumbar support controls are located on the rear doors in front of the heated seat buttons.

To turn on the lumbar support feature, press the front of the control to increase support or rearward to decrease support. The lumbar control can also be moved up and down to adjust the location of the support.

Safety Belts

Safety Belts: They Are for Everyone

This section of the manual describes how to use safety belts properly. It also describes some things not to do with safety belts.

WARNING:

Do not let anyone ride where a safety belt cannot be worn properly. In a crash, if you or your passenger(s) are not wearing safety belts, the injuries can be much worse. You can hit things inside the vehicle harder or be ejected from the vehicle. You and your passenger(s) can be seriously injured or killed. In the same crash, you might not be, if you are buckled up. Always fasten your safety belt, and check that your passenger(s) are restrained properly too.

WARNING:

It is extremely dangerous to ride in a cargo area, inside or outside of a vehicle. In a collision, people riding in these areas are more likely to be seriously injured or killed. Do not allow people to ride in any area of your vehicle that is not equipped with seats and safety belts. Be sure everyone in your vehicle is in a seat and using a safety belt properly.

This vehicle has indicators as a reminder to buckle the safety belts. See *Safety Belt Reminders on page 4-48* for additional information.

In most states and in all Canadian provinces, the law requires wearing safety belts. Here is why:

You never know if you will be in a crash. If you do have a crash, you do not know if it will be a serious one.

A few crashes are mild, and some crashes can be so serious that even buckled up, a person would not survive. But most crashes are in between. In many of them, people who buckle up can survive and sometimes walk away. Without safety belts, they could have been badly hurt or killed.

After more than 40 years of safety belts in vehicles, the facts are clear. In most crashes buckling up does matter ... a lot!

Why Safety Belts Work

When you ride in or on anything, you go as fast as it goes.

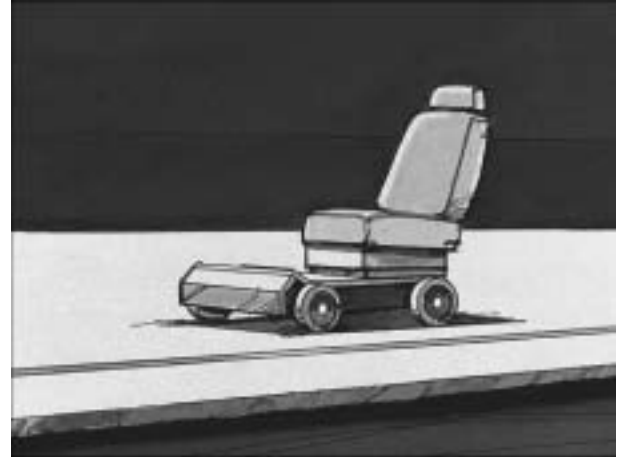

Take the simplest vehicle. Suppose it is just a seat on wheels.



Put someone on it.

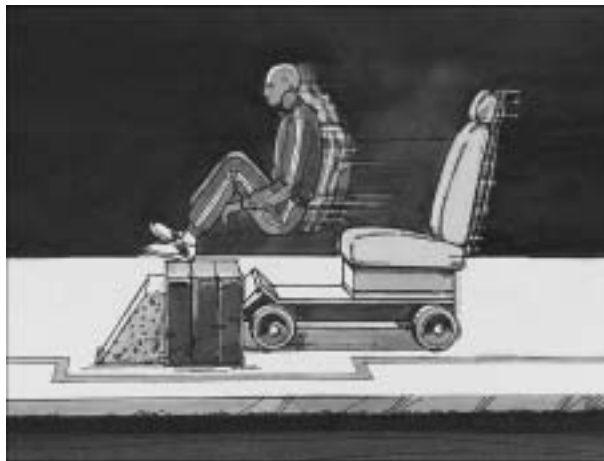

Get it up to speed. Then stop the vehicle. The rider does not stop.



The person keeps going until stopped by something.
In a real vehicle, it could be the windshield...



or the instrument panel...



or the safety belts!

With safety belts, you slow down as the vehicle does. You get more time to stop. You stop over more distance, and your strongest bones take the forces. That is why safety belts make such good sense.

Questions and Answers About Safety Belts

Q: Will I be trapped in the vehicle after a crash if I am wearing a safety belt?

A: You *could* be — whether you are wearing a safety belt or not. But your chance of being conscious during and after an accident, so you *can* unbuckle and get out, is *much* greater if you are belted. And you can unbuckle a safety belt, even if you are upside down.

Q: If my vehicle has airbags, why should I have to wear safety belts?

A: Airbags are supplemental systems only; so they work *with* safety belts — not instead of them. Whether or not an airbag is provided, all occupants still have to buckle up to get the most protection. That is true not only in frontal collisions, but especially in side and other collisions.

Q: If I am a good driver, and I never drive far from home, why should I wear safety belts?

A: You may be an excellent driver, but if you are in a crash — even one that is not your fault — you and your passenger(s) can be hurt. Being a good driver does not protect you from things beyond your control, such as bad drivers.

Most accidents occur within 25 miles (40 km) of home. And the greatest number of serious injuries and deaths occur at speeds of less than 40 mph (65 km/h).

Safety belts are for everyone.

How to Wear Safety Belts Properly

This section is only for people of adult size.

Be aware that there are special things to know about safety belts and children. And there are different rules for smaller children and infants. If a child will be riding in the vehicle, see *Older Children on page 2-33* or *Infants and Young Children on page 2-37*. Follow those rules for everyone's protection.

It is very important for all occupants to buckle up. Statistics show that unbelted people are hurt more often in crashes than those who are wearing safety belts.

Occupants who are not buckled up can be thrown out of the vehicle in a crash. And they can strike others in the vehicle who are wearing safety belts.

First, before you or your passenger(s) wear a safety belt, there is important information you should know.

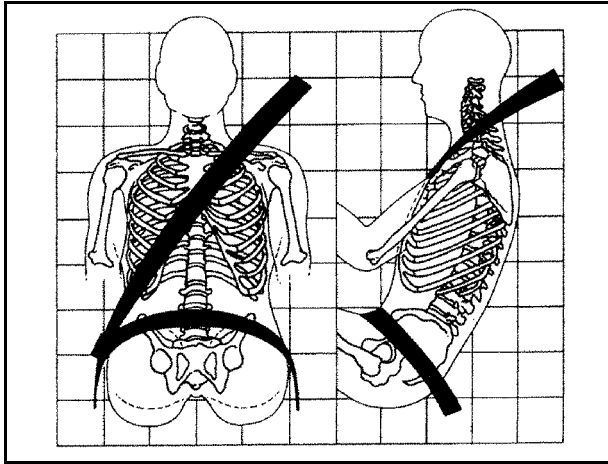

Sit up straight and always keep your feet on the floor in front of you. The lap part of the belt should be worn low and snug on the hips, just touching the thighs.

In a crash, this applies force to the strong pelvic bones and you would be less likely to slide under the lap belt. If you slid under it, the belt would apply force on your abdomen. This could cause serious or even fatal injuries. The shoulder belt should go over the shoulder and across the chest. These parts of the body are best able to take belt restraining forces.

The shoulder belt locks if there is a sudden stop or crash.

Q: What is wrong with this?

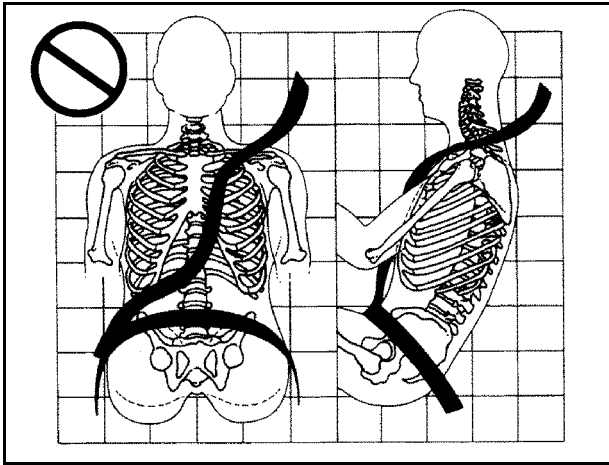

A: The shoulder belt is too loose. It will not give as much protection this way.

⚠ WARNING:

You can be seriously hurt if your shoulder belt is too loose. In a crash, you would move forward too much, which could increase injury. The shoulder belt should fit snugly against your body.

Q: What is wrong with this?

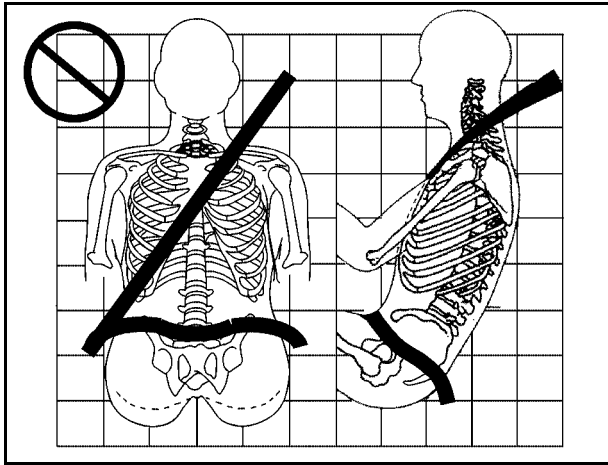

A: The lap belt is too loose. It will not give nearly as much protection this way.

⚠ WARNING:

You can be seriously hurt if your lap belt is too loose. In a crash, you could slide under the lap belt and apply force on your abdomen. This could cause serious or even fatal injuries. The lap belt should be worn low and snug on the hips, just touching the thighs.

Q: What is wrong with this?

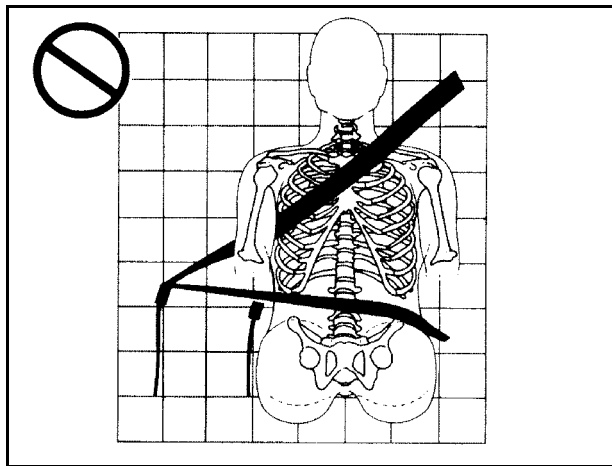

A: The belt is buckled in the wrong buckle.

⚠ WARNING:

You can be seriously injured if your belt is buckled in the wrong place like this. In a crash, the belt would go up over your abdomen. The belt forces would be there, not on the pelvic bones. This could cause serious internal injuries. Always buckle your belt into the buckle nearest you.

Q: What is wrong with this?

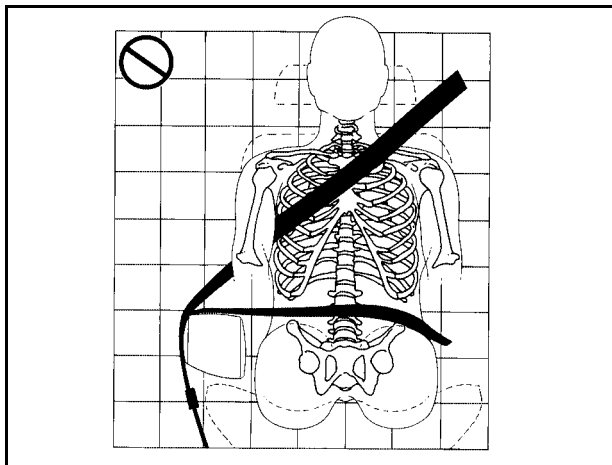

A: The belt is over an armrest.

⚠ WARNING:

You can be seriously injured if your belt goes over an armrest like this. The belt would be much too high. In a crash, you can slide under the belt. The belt force would then be applied on the abdomen, not on the pelvic bones, and that could cause serious or fatal injuries. Be sure the belt goes under the armrests.

Q: What is wrong with this?

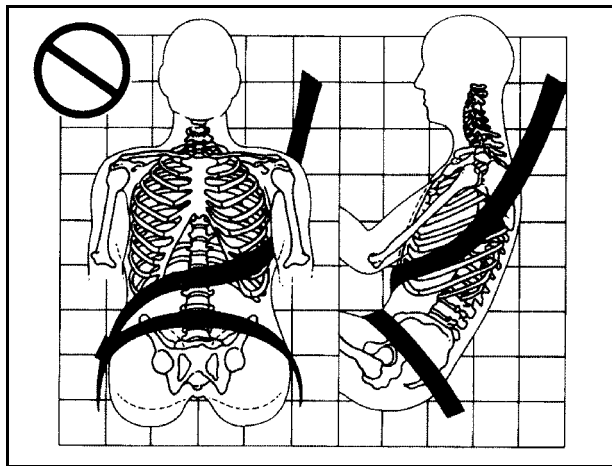

A: The shoulder belt is worn under the arm. It should be worn over the shoulder at all times.

⚠ WARNING:

You can be seriously injured if you wear the shoulder belt under your arm. In a crash, your body would move too far forward, which would increase the chance of head and neck injury. Also, the belt would apply too much force to the ribs, which are not as strong as shoulder bones. You could also severely injure internal organs like your liver or spleen. The shoulder belt should go over the shoulder and across the chest.

Q: What is wrong with this?

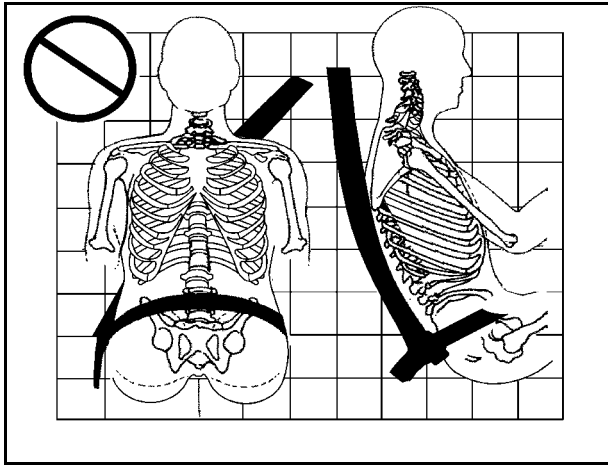

A: The belt is behind the body.

⚠ WARNING:

You can be seriously injured by not wearing the lap-shoulder belt properly. In a crash, you would not be restrained by the shoulder belt. Your body could move too far forward increasing the chance of head and neck injury. You might also slide under the lap belt. The belt force would then be applied right on the abdomen. That could cause serious or fatal injuries. The shoulder belt should go over the shoulder and across the chest.

Q: What is wrong with this?

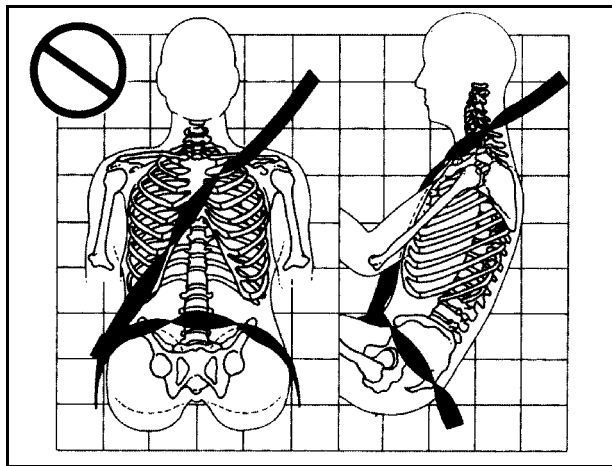

A: The belt is twisted across the body.

⚠ WARNING:

You can be seriously injured by a twisted belt. In a crash, you would not have the full width of the belt to spread impact forces. If a belt is twisted, make it straight so it can work properly, or ask your dealer to fix it.

Lap-Shoulder Belt

All seating positions in the vehicle have a lap-shoulder except for the center front passenger position (if equipped), which has a lap belt. See *Lap Belt on page 2-32* for more information.

The following instructions explain how to wear a lap-shoulder belt properly.

1. Adjust the seat, if the seat is adjustable, so you can sit up straight. To see how, see "Seats" in the Index.
2. Pick up the latch plate and pull the belt across you. Do not let it get twisted.

The lap-shoulder belt may lock if you pull the belt across you very quickly. If this happens, let the belt go back slightly to unlock it. Then pull the belt across you more slowly.

If the shoulder portion of a passenger belt is pulled out all the way, the child restraint locking feature may be engaged. If this happens, just let the belt go back all the way and start again.

Engaging the child restraint locking feature in the right front seating position may affect the passenger sensing system. See *Passenger Sensing System on page 2-68* for more information.

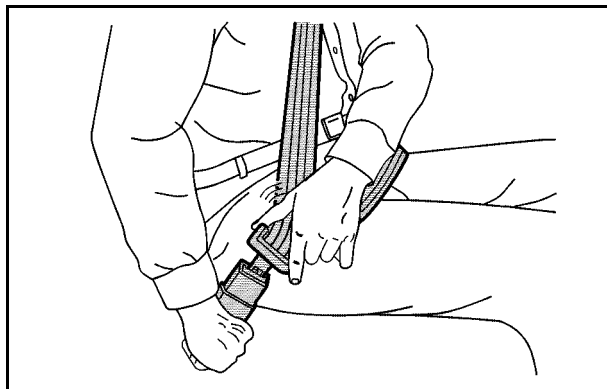

3. Push the latch plate into the buckle until it clicks. If the latch plate will not go fully into the buckle, check if the correct buckle is being used. Pull up on the latch plate to make sure it is secure. If the belt is not long enough, see *Safety Belt Extender on page 2-33*. Position the release button on the buckle so that the safety belt could be quickly unbuckled if necessary.

4. If equipped with a shoulder belt height adjuster, move it to the height that is right for you. See "Shoulder Belt Height Adjustment" later in this section for instructions on use and important safety information.

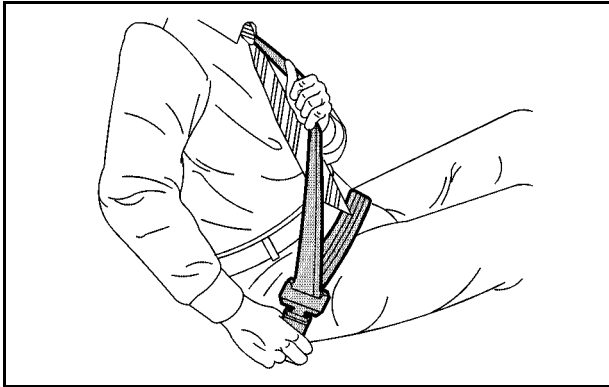

5. To make the lap part tight, pull up on the shoulder belt.

It may be necessary to pull stitching on the safety belt through the latch plate to fully tighten the lap belt on smaller occupants.

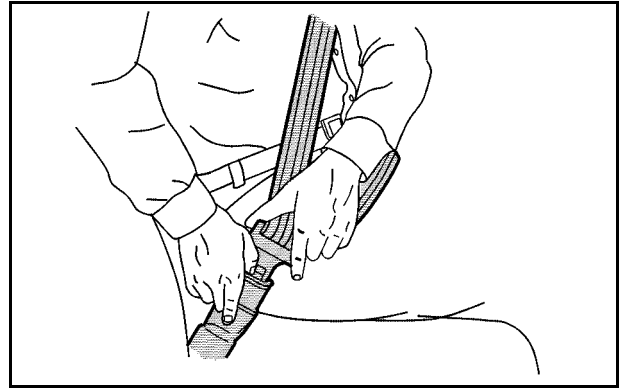

To unlatch the belt, push the button on the buckle. The belt should return to its stowed position. Slide the latch plate up the safety belt webbing when the safety belt is not in use. The latch plate should rest on the stitching near the guide loop on the side wall.

Before a door is closed, be sure the safety belt is out of the way. If a door is slammed against a safety belt, damage can occur to both the belt and the vehicle.

Shoulder Belt Height Adjuster

The vehicle has a shoulder belt height adjuster for the driver and right front passenger seating positions.

Adjust the height so that the shoulder portion of the belt is centered on the shoulder. The belt should be away from the face and neck, but not falling off the shoulder. Improper shoulder belt height adjustment could reduce the effectiveness of the safety belt in a crash.

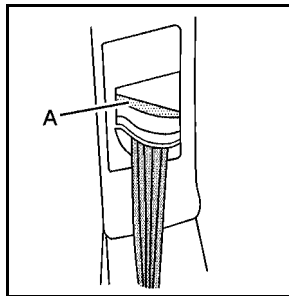

Press the release button (A) and move the height adjuster to the desired position. The adjuster can be moved up by pushing up on the shoulder belt guide.

After the adjuster is set to the desired position, try to move it down without pressing the release button to make sure it has locked into position.

Safety Belt Pretensioners

This vehicle has safety belt pretensioners for front outboard occupants. Although the safety belt pretensioners cannot be seen, they are part of the safety belt assembly. They can help tighten the safety belts during the early stages of a moderate to severe frontal or near frontal crash if the threshold conditions for pretensioner activation are met. And, if your vehicle has side impact airbags, safety belt pretensioners can help tighten the safety belts in a side crash.

Pretensioners work only once. If the pretensioners activate in a crash, they will need to be replaced, and probably other new parts for the vehicle's safety belt system. See *Replacing Restraint System Parts After a Crash* on page 2-76.

Rear Safety Belt Comfort Guides

This vehicle may have rear shoulder belt comfort guides for each outside passenger position in the rear seat. If not, they are available through your dealer. The guides may provide added safety belt comfort for older children who have outgrown booster seats and for some adults. When installed the comfort guide positions the shoulder belt away from the neck and head.

Here is how to install a comfort guide to the safety belt:



1. Remove the guide from its storage pocket on the rear side of the seatback.

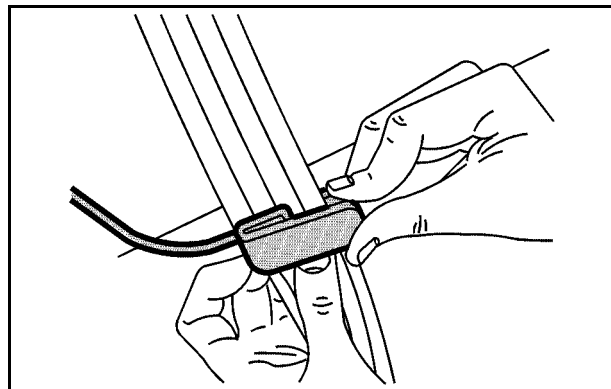

2. Place the guide over the belt, and insert the two edges of the belt into the slots of the guide.

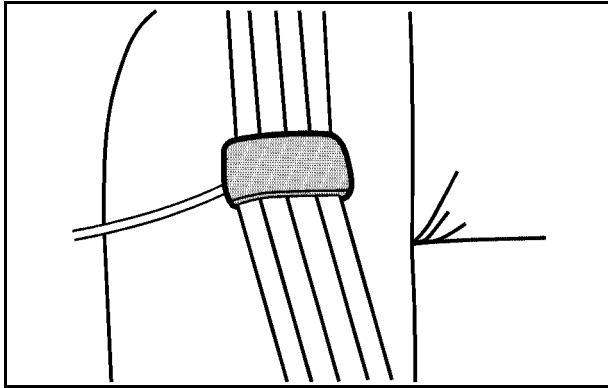

⚠ WARNING:

A safety belt that is not properly worn may not provide the protection needed in a crash. The person wearing the belt could be seriously injured. The shoulder belt should go over the shoulder and across the chest. These parts of the body are best able to take belt restraining forces.

3. Be sure that the belt is not twisted and it lies flat. The elastic cord must be under the belt and the guide on top.

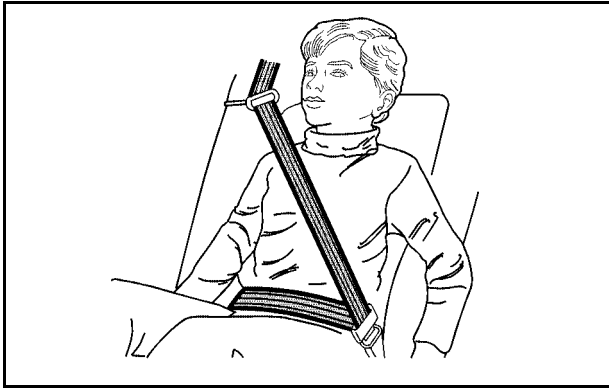

4. Buckle, position, and release the safety belt as described earlier in this section. Make sure that the shoulder belt crosses the shoulder.

To remove and store the comfort guide, squeeze the belt edges together so that the safety belt can be removed from the guide. Slide the guide into its storage pocket on the side of the seatback.

Safety Belt Use During Pregnancy

Safety belts work for everyone, including pregnant women. Like all occupants, they are more likely to be seriously injured if they do not wear safety belts.

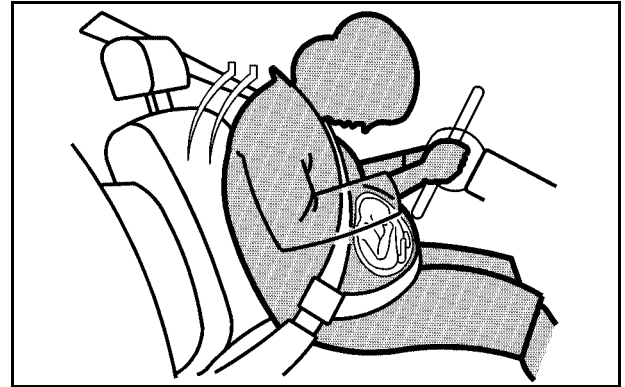

A pregnant woman should wear a lap-shoulder belt, and the lap portion should be worn as low as possible, below the rounding, throughout the pregnancy.

The best way to protect the fetus is to protect the mother. When a safety belt is worn properly, it is more likely that the fetus will not be hurt in a crash. For pregnant women, as for anyone, the key to making safety belts effective is wearing them properly.

Lap Belt

This part is only for the lap belt. To learn how to wear a lap-shoulder belt, see *Lap-Shoulder Belt* on page 2-26.

The vehicle may have a center seating position. When you sit in the center front seating position, you have a lap safety belt, which has no retractor.

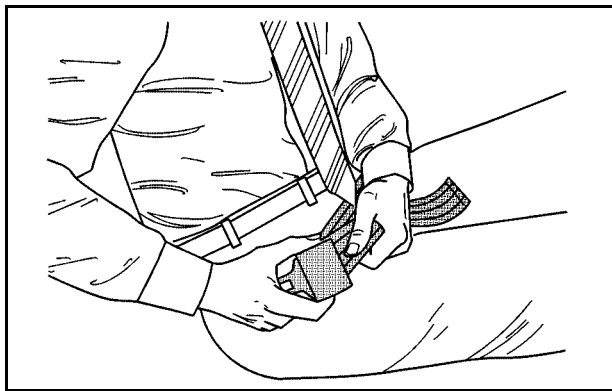

To make the belt longer, tilt the latch plate and pull it along the belt.

Buckle, position and release it the same way as the lap part of a lap-shoulder belt.

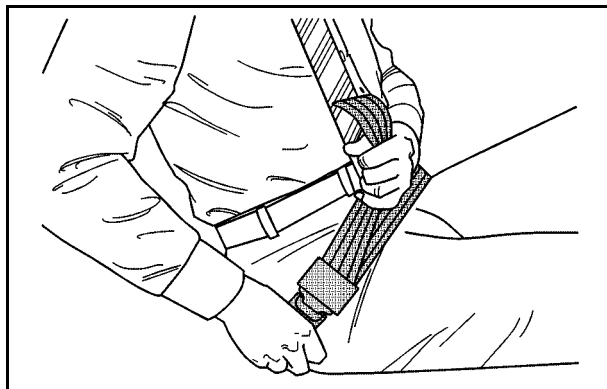

To make the belt shorter, pull its free end as shown until the belt is snug.

If the belt is not long enough, see *Safety Belt Extender* on page 2-33.

Make sure the release button on the buckle is positioned so you would be able to unbuckle the safety belt quickly if necessary.

If you find that the latch plate will not go fully into the buckle, see if you are using the correct buckle. Be sure that the latch plate clicks when inserted into the buckle.

Safety Belt Extender

If the vehicle's safety belt will fasten around you, you should use it.

But if a safety belt is not long enough, your dealer will order you an extender. When you go in to order it, take the heaviest coat you will wear, so the extender will be long enough for you. To help avoid personal injury, do not let someone else use it, and use it only for the seat it is made to fit. The extender has been designed for adults. Never use it for securing child seats. To wear it, attach it to the regular safety belt. For more information, see the instruction sheet that comes with the extender.

Child Restraints

Older Children

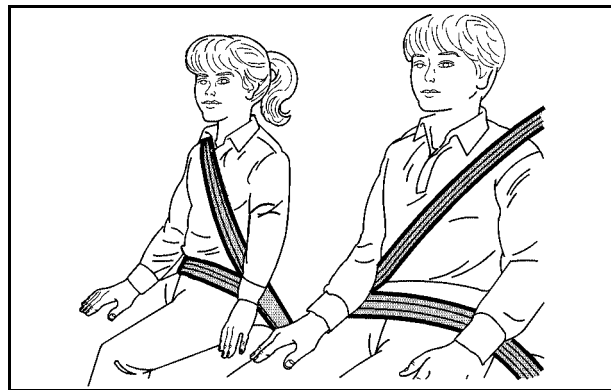

Older children who have outgrown booster seats should wear the vehicle's safety belts.

The manufacturer's instructions that come with the booster seat, state the weight and height limitations for that booster. Use a booster seat with a lap-shoulder belt until the child passes the below fit test:

- Sit all the way back on the seat. Do the knees bend at the seat edge? If yes, continue. If no, return to the booster seat.
- Buckle the lap-shoulder belt. Does the shoulder belt rest on the shoulder? If yes, continue. If no, try using the rear safety belt comfort guide. See "Rear Safety Belt Comfort Guides" under *Lap-Shoulder Belt on page 2-26* for more information. If the shoulder belt still does not rest on the shoulder, then return to the booster seat.
- Does the lap belt fit low and snug on the hips, touching the thighs? If yes, continue. If no, return to the booster seat.
- Can proper safety belt fit be maintained for length of trip? If yes, continue. If no, return to the booster seat.

If you have the choice, a child should sit in a position with a lap-shoulder belt and get the additional restraint a shoulder belt can provide.

Q: What is the proper way to wear safety belts?

A: An older child should wear a lap-shoulder belt and get the additional restraint a shoulder belt can provide. The shoulder belt should not cross the face or neck. The lap belt should fit snugly below the hips, just touching the top of the thighs. This applies belt force to the child's pelvic bones in a crash. It should never be worn over the abdomen, which could cause severe or even fatal internal injuries in a crash.

Also see "Rear Safety Belt Comfort Guides" under *Lap-Shoulder Belt on page 2-26*.

According to accident statistics, children and infants are safer when properly restrained in the rear seating positions than in the front seating positions.

In a crash, children who are not buckled up can strike other people who are buckled up, or can be thrown out of the vehicle. Older children need to use safety belts properly.

⚠ WARNING:

Never do this.

Never allow two children to wear the same safety belt. The safety belt can not properly spread the impact forces. In a crash, the two children can be crushed together and seriously injured. A safety belt must be used by only one person at a time.

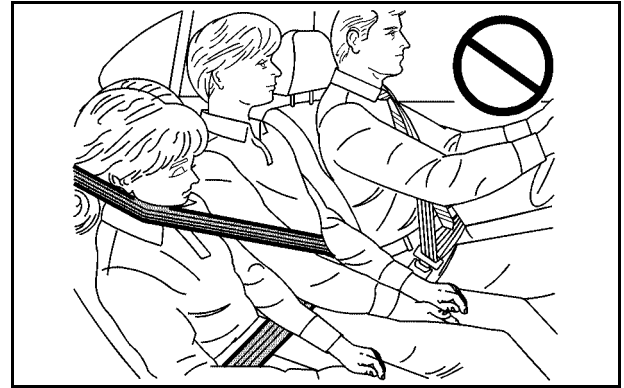

⚠ WARNING:

Never do this.

Never allow a child to wear the safety belt with the shoulder belt behind their back. A child can be seriously injured by not wearing the lap-shoulder belt properly. In a crash, the child would not be restrained by the shoulder belt. The child could move too far forward increasing the chance of head and neck injury. The child might also slide under the lap belt. The belt force would then be applied right on the abdomen. That could cause serious or fatal injuries. The shoulder belt should go over the shoulder and across the chest.



Infants and Young Children

Everyone in a vehicle needs protection! This includes infants and all other children. Neither the distance traveled nor the age and size of the traveler changes the need, for everyone, to use safety restraints. In fact, the law in every state in the United States and in every Canadian province says children up to some age must be restrained while in a vehicle.

WARNING:

Children can be seriously injured or strangled if a shoulder belt is wrapped around their neck and the safety belt continues to tighten. Never leave children unattended in a vehicle and never allow children to play with the safety belts.

Airbags plus lap-shoulder belts offer protection for adults and older children, but not for young children and infants. Neither the vehicle's safety belt system nor its airbag system is designed for them. Every time infants and young children ride in vehicles, they should have the protection provided by appropriate child restraints.

Children who are not restrained properly can strike other people, or can be thrown out of the vehicle.

⚠ WARNING:

Never do this.

Never hold an infant or a child while riding in a vehicle. Due to crash forces, an infant or a child will become so heavy it is not possible to hold it during a crash. For example, in a crash at only 40 km/h (25 mph), a 5.5 kg (12 lb) infant will suddenly become a 110 kg (240 lb) force on a person's arms. An infant should be secured in an appropriate restraint.

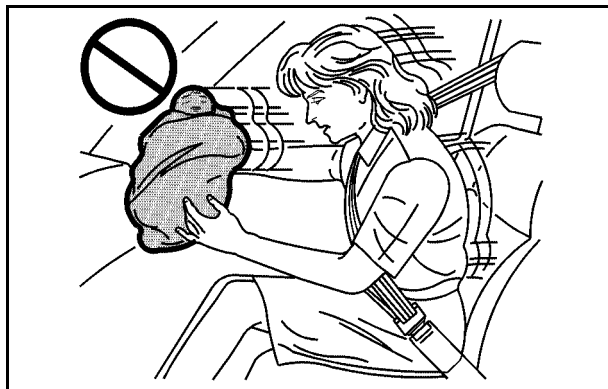

⚠ WARNING:

Never do this.

Children who are up against, or very close to, any airbag when it inflates can be seriously injured or killed. Never put a rear-facing child restraint in the right front seat. Secure a rear-facing child restraint in a rear seat. It is also better to secure a forward-facing child restraint in a rear seat. If you must secure a forward-facing child restraint in the right front seat, always move the front passenger seat as far back as it will go.

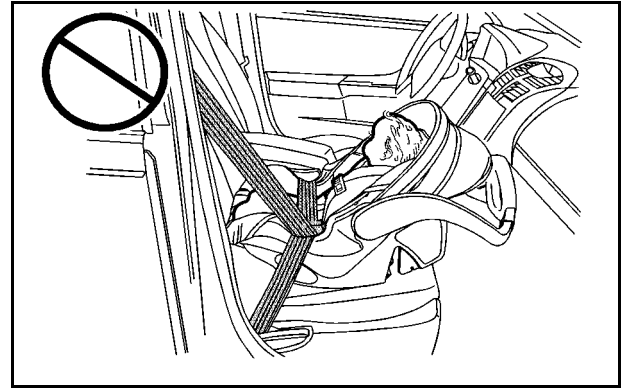

Q: What are the different types of add-on child restraints?

A: Add-on child restraints, which are purchased by the vehicle's owner, are available in four basic types. Selection of a particular restraint should take into consideration not only the child's weight, height, and age but also whether or not the restraint will be compatible with the motor vehicle in which it will be used.

For most basic types of child restraints, there are many different models available. When purchasing a child restraint, be sure it is designed to be used in a motor vehicle. If it is, the restraint will have a label saying that it meets federal motor vehicle safety standards.

The restraint manufacturer's instructions that come with the restraint state the weight and height limitations for a particular child restraint. In addition, there are many kinds of restraints available for children with special needs.

 **WARNING:**

To reduce the risk of neck and head injury during a crash, infants need complete support. This is because an infant's neck is not fully developed and its head weighs so much compared with the rest of its body. In a crash, an infant in a rear-facing child restraint settles into the restraint, so the crash forces can be distributed across the strongest part of an infant's body, the back and shoulders. Infants should always be secured in rear-facing child restraints.

⚠ WARNING:

A young child's hip bones are still so small that the vehicle's regular safety belt may not remain low on the hip bones, as it should. Instead, it may settle up around the child's abdomen. In a crash, the belt would apply force on a body area that is unprotected by any bony structure. This alone could cause serious or fatal injuries. To reduce the risk of serious or fatal injuries during a crash, young children should always be secured in appropriate child restraints.

Child Restraint Systems

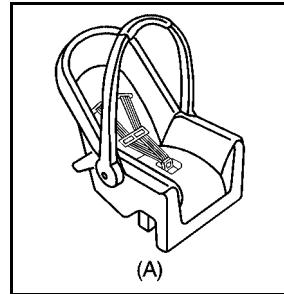

A rear-facing infant seat (A) provides restraint with the seating surface against the back of the infant.

The harness system holds the infant in place and, in a crash, acts to keep the infant positioned in the restraint.

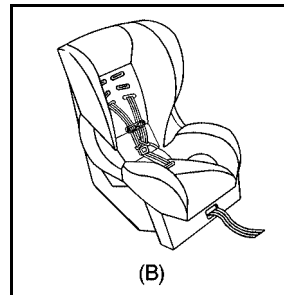

A forward-facing child seat (B) provides restraint for the child's body with the harness.

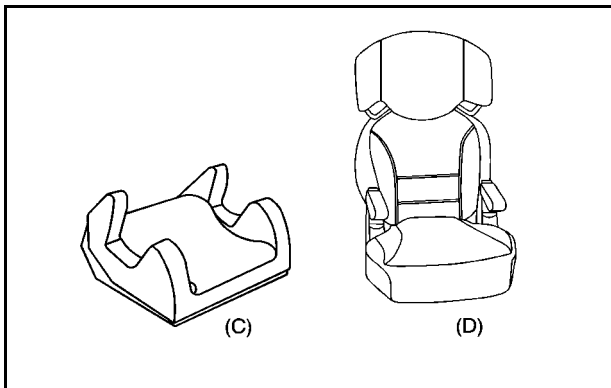

A booster seat (C-D) is a child restraint designed to improve the fit of the vehicle's safety belt system. A booster seat can also help a child to see out the window.

Securing an Add-On Child Restraint in the Vehicle

WARNING:

A child can be seriously injured or killed in a crash if the child restraint is not properly secured in the vehicle. Secure the child restraint properly in the vehicle using the vehicle's safety belt or LATCH system, following the instructions that came with that child restraint and the instructions in this manual.

To help reduce the chance of injury, the child restraint must be secured in the vehicle. Child restraint systems must be secured in vehicle seats by lap belts or the lap belt portion of a lap-shoulder belt, or by the LATCH system. See *Lower Anchors and Tethers for Children (LATCH)* on page 2-45 for more information. A child can be endangered in a crash if the child restraint is not properly secured in the vehicle.

When securing an add-on child restraint, refer to the instructions that come with the restraint which may be on the restraint itself or in a booklet, or both, and to this manual. The child restraint instructions are important, so if they are not available, obtain a replacement copy from the manufacturer.

Keep in mind that an unsecured child restraint can move around in a collision or sudden stop and injure people in the vehicle. Be sure to properly secure any child restraint in the vehicle — even when no child is in it.

Securing the Child Within the Child Restraint

WARNING:

A child can be seriously injured or killed in a crash if the child is not properly secured in the child restraint. Secure the child properly following the instructions that came with that child restraint.

Where to Put the Restraint

According to accident statistics, children and infants are safer when properly restrained in a child restraint system or infant restraint system secured in a rear seating position.

We recommend that children and child restraints be secured in a rear seat, including: an infant or a child riding in a rear-facing child restraint; a child riding in a forward-facing child seat; an older child riding in a booster seat; and children, who are large enough, using safety belts.

A label on your sun visor says, "Never put a rear-facing child seat in the front." This is because the risk to the rear-facing child is so great, if the airbag deploys.

WARNING:

A child in a rear-facing child restraint can be seriously injured or killed if the right front passenger airbag inflates. This is because the back of the rear-facing child restraint would be very close to the inflating airbag. A child in a forward-facing child restraint can be seriously injured or killed if the right front passenger airbag inflates and the passenger seat is in a forward position.

Even if the passenger sensing system has turned off the right front passenger frontal airbag, no system is fail-safe. No one can guarantee that an airbag will not deploy under some unusual circumstance, even though it is turned off.

Secure rear-facing child restraints in a rear seat, even if the airbag is off. If you secure a forward-facing child restraint in the right front seat, always move the front passenger seat as far back as it will go. It is better to secure the child restraint in a rear seat.

See *Passenger Sensing System* on page 2-68 for additional information.

 **WARNING:**

A child in a child restraint in the center front seat can be badly injured or killed by the frontal airbags if they inflate. Never secure a child restraint in the center front seat. It is always better to secure a child restraint in a rear seat.

Do not use child restraints in the center front seat position.

When securing a child restraint in a rear seating position, study the instructions that came with your child restraint to make sure it is compatible with this vehicle.

Wherever a child restraint is installed, be sure to secure the child restraint properly.

Keep in mind that an unsecured child restraint can move around in a collision or sudden stop and injure people in the vehicle. Be sure to properly secure any child restraint in your vehicle — even when no child is in it.

Lower Anchors and Tethers for Children (LATCH)

The LATCH system holds a child restraint during driving or in a crash. This system is designed to make installation of a child restraint easier. The LATCH system uses anchors in the vehicle and attachments on the child restraint that are made for use with the LATCH system.

Make sure that a LATCH-compatible child restraint is properly installed using the anchors, or use the vehicle's safety belts to secure the restraint, following the instructions that came with that restraint, and also the instructions in this manual. When installing a child restraint with a top tether, you must also use either the lower anchors or the safety belts to properly secure the child restraint. A child restraint must never be installed using only the top tether and anchor.

In order to use the LATCH system in your vehicle, you need a child restraint that has LATCH attachments. The child restraint manufacturer will provide you with instructions on how to use the child restraint and its attachments. The following explains how to attach a child restraint with these attachments in your vehicle.

Not all vehicle seating positions or child restraints have lower anchors and attachments or top tether anchors and attachments.

Lower Anchors

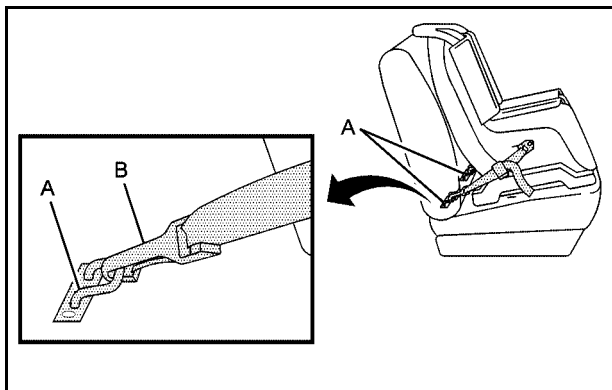

Lower anchors (A) are metal bars built into the vehicle. There are two lower anchors for each LATCH seating position that will accommodate a child restraint with lower attachments (B).

Top Tether Anchor

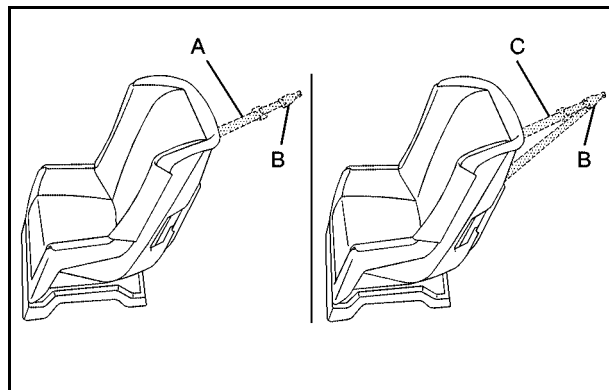

A top tether (A, C) anchors the top of the child restraint to the vehicle. A top tether anchor is built into the vehicle. The top tether attachment (B) on the child restraint connects to the top tether anchor in the vehicle in order to reduce the forward movement and rotation of the child restraint during driving or in a crash.

Your child restraint may have a single tether (A) or a dual tether (C). Either will have a single attachment (B) to secure the top tether to the anchor.

Some child restraints that have top tethers are designed for use with or without the top tether being attached. Others require the top tether always to be attached. In Canada, the law requires that forward-facing child restraints have a top tether, and that the tether be attached. Be sure to read and follow the instructions for your child restraint.

If the child restraint does not have a top tether, one can be obtained, in kit form, for many child restraints. Ask the child restraint manufacturer whether or not a kit is available.

Lower Anchor and Top Tether Anchor Locations

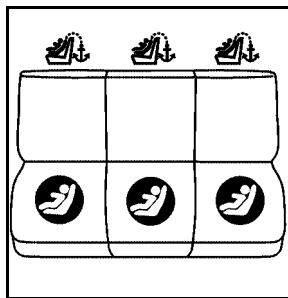

Rear Seat

 (Top Tether Anchor):
Seating positions with top tether anchors.

 (Lower Anchor):
Seating positions with two lower anchors.



To assist you in locating the lower anchors, each seating position with lower anchors has two labels, near the crease between the seatback and the seat cushion.

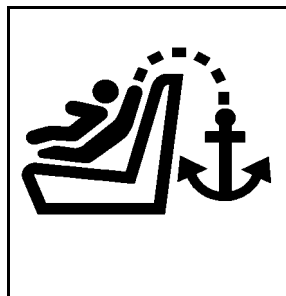

To assist you in locating the top tether anchors, the top tether anchor symbol is located on the cover.

The top tether anchors are located under the covers on the rear seatback filler panel. Pull open the cover to access the anchors. Be sure to use an anchor located on the same side of the vehicle as the seating position where the child restraint will be placed.

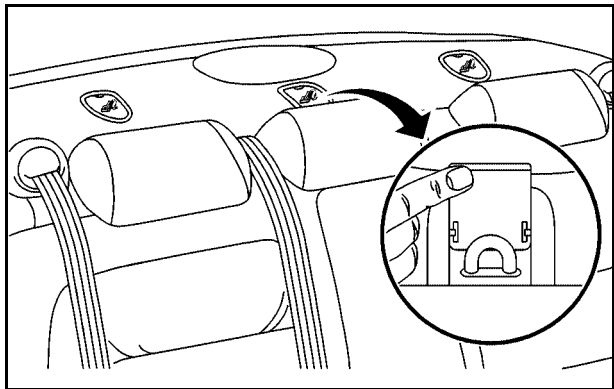

Do not secure a child restraint in a position without a top tether anchor if a national or local law requires that the top tether be attached, or if the instructions that come with the child restraint say that the top tether must be attached.

Accident statistics show that children are safer if they are restrained in the rear rather than the front seat. See *Where to Put the Restraint on page 2-44* for additional information.

Securing a Child Restraint Designed for the LATCH System

WARNING:

If a LATCH-type child restraint is not attached to anchors, the child restraint will not be able to protect the child correctly. In a crash, the child could be seriously injured or killed. Install a LATCH-type child restraint properly using the anchors, or use the vehicle's safety belts to secure the restraint, following the instructions that came with the child restraint and the instructions in this manual.

 **WARNING:**

Do not attach more than one child restraint to a single anchor. Attaching more than one child restraint to a single anchor could cause the anchor or attachment to come loose or even break during a crash. A child or others could be injured. To reduce the risk of serious or fatal injuries during a crash, attach only one child restraint per anchor.

 **WARNING:**

Children can be seriously injured or strangled if a shoulder belt is wrapped around their neck and the safety belt continues to tighten. Buckle any unused safety belts behind the child restraint so children cannot reach them. Pull the shoulder belt all the way out of the retractor to set the lock, if your vehicle has one, after the child restraint has been installed.

Notice: Do not let the LATCH attachments rub against the vehicle's safety belts. This may damage these parts. If necessary, move buckled safety belts to avoid rubbing the LATCH attachments.

Do not fold the empty rear seat with a safety belt buckled. This could damage the safety belt or the seat. Unbuckle and return the safety belt to its stowed position, before folding the seat.

1. Attach and tighten the lower attachments to the lower anchors. If the child restraint does not have lower attachments or the desired seating position does not have lower anchors, secure the child restraint with the top tether and the safety belts. Refer to your child restraint manufacturer instructions and the instructions in this manual.
 - 1.1. Find the lower anchors for the desired seating position.
 - 1.2. Put the child restraint on the seat.
 - 1.3. Attach and tighten the lower attachments on the child restraint to the lower anchors.

2. If the child restraint manufacturer recommends that the top tether be attached, attach and tighten the top tether to the top tether anchor, if equipped. Refer to the child restraint instructions and the following steps:

- 2.1. Find the top tether anchor.
- 2.2. Pull open the top tether anchor cover to expose the anchor.
- 2.3. If you have an adjustable headrest or head restraint, raise the headrest or head restraint.
- 2.4. Route, attach and tighten the top tether according to your child restraint instructions and the following instructions:

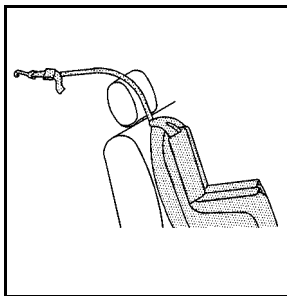

If the position you are using has a fixed headrest or head restraint and you are using a single tether, route the tether over the headrest or head restraint.

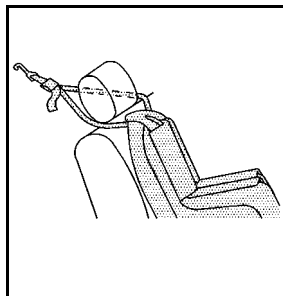

If the position you are using has a fixed or adjustable headrest or head restraint and you are using a dual tether, route the tether around the headrest or head restraint.

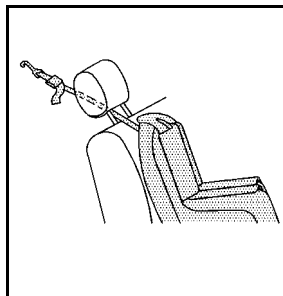

If the position you are using has an adjustable headrest or head restraint and you are using a single tether, route the tether under the headrest or head restraint and in between the headrest or head restraint posts.

3. Push and pull the child restraint in different directions to be sure it is secure.

Securing a Child Restraint in a Rear Seat Position

When securing a child restraint in a rear seating position, study the instructions that came with the child restraint to make sure it is compatible with this vehicle.

If the child restraint has the LATCH system, see *Lower Anchors and Tethers for Children (LATCH)* on page 2-45 for how and where to install the child restraint using LATCH. If a child restraint is secured in the vehicle using a safety belt and it uses a top tether, see *Lower Anchors and Tethers for Children (LATCH)* on page 2-45 for top tether anchor locations.

Do not secure a child seat in a position without a top tether anchor if a national or local law requires that the top tether be anchored, or if the instructions that come with the child restraint say that the top strap must be anchored.

In Canada, the law requires that forward-facing child restraints have a top tether, and that the tether be attached.

If the child restraint does not have the LATCH system, you will be using the safety belt to secure the child restraint in this position. Be sure to follow the instructions that came with the child restraint. Secure the child in the child restraint when and as the instructions say.

If more than one child restraint needs to be installed in the rear seat, be sure to read *Where to Put the Restraint* on page 2-44.

1. Put the child restraint on the seat.
2. Pick up the latch plate, and run the lap and shoulder portions of the vehicle's safety belt through or around the restraint. The child restraint instructions will show you how.

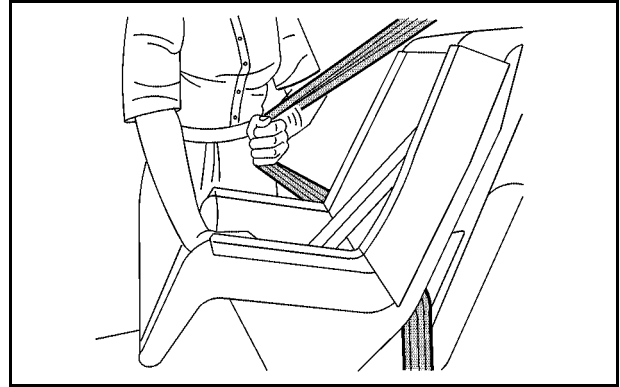
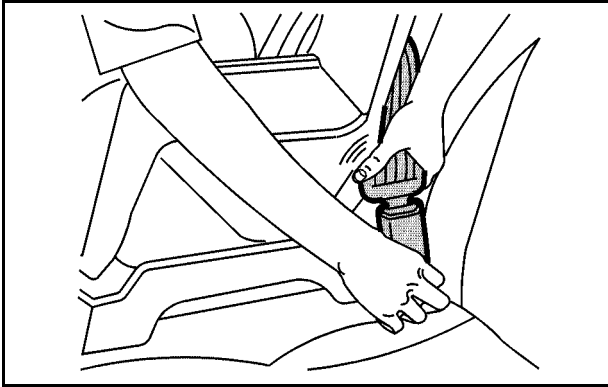

3. Push the latch plate into the buckle until it clicks.
Position the release button on the buckle so that the safety belt could be quickly unbuckled if necessary.

4. Pull the rest of the shoulder belt all the way out of the retractor to set the lock.

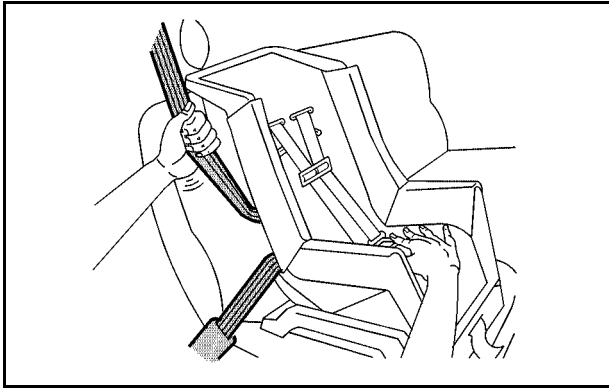

5. To tighten the belt, push down on the child restraint, pull the shoulder portion of the belt to tighten the lap portion of the belt and feed the shoulder belt back into the retractor. When installing a forward-facing child restraint, it may be helpful to use your knee to push down on the child restraint as you tighten the belt.

6. If the child restraint has a top tether, follow the child restraint manufacturer's instructions regarding the use of the top tether. See *Lower Anchors and Tethers for Children (LATCH)* on page 2-45 for more information.
7. Push and pull the child restraint in different directions to be sure it is secure.

To remove the child restraint, unbuckle the vehicle safety belt and let it return to the stowed position. If the top tether is attached to a top tether anchor, disconnect it.

Securing a Child Restraint in the Center Front Seat Position

WARNING:

A child in a child restraint in the center front seat can be badly injured or killed by the frontal airbags if they inflate. Never secure a child restraint in the center front seat. It is always better to secure a child restraint in a rear seat.

Do not use child restraints in the center front seat position.

Securing a Child Restraint in the Right Front Seat Position

This vehicle has airbags. A rear seat is a safer place to secure a forward-facing child restraint. See *Where to Put the Restraint* on page 2-44.

In addition, the vehicle has a passenger sensing system which is designed to turn off the right front passenger frontal airbag and seat-mounted side impact airbag under certain conditions. See *Passenger Sensing System* on page 2-68 and *Passenger Airbag Status Indicator* on page 4-49 for more information, including important safety information.

A label on the sun visor says, "Never put a rear-facing child seat in the front." This is because the risk to the rear-facing child is so great, if the airbag deploys.

WARNING:

A child in a rear-facing child restraint can be seriously injured or killed if the right front passenger airbag inflates. This is because the back of the rear-facing child restraint would be very close to the inflating airbag. A child in a forward-facing child restraint can be seriously injured or killed if the right front passenger airbag inflates and the passenger seat is in a forward position.

Even if the passenger sensing system has turned off the right front passenger frontal airbag, no system is fail-safe. No one can guarantee that an airbag will not deploy under some unusual circumstance, even though it is turned off.

Secure rear-facing child restraints in a rear seat, even if the airbag is off. If you secure a forward-facing child restraint in the right front seat, always move the front passenger seat as far back as it will go. It is better to secure the child restraint in a rear seat.

See *Passenger Sensing System* on page 2-68 for additional information.

If the child restraint has the LATCH system, see *Lower Anchors and Tethers for Children (LATCH)* on page 2-45 for how and where to install the child restraint using LATCH. If a child restraint is secured using a safety belt and it uses a top tether, see *Lower Anchors and Tethers for Children (LATCH)* on page 2-45 for top tether anchor locations.

Do not secure a child seat in a position without a top tether anchor if a national or local law requires that the top tether be anchored, or if the instructions that come with the child restraint say that the top strap must be anchored.

In Canada, the law requires that forward-facing child restraints have a top tether, and that the tether be attached.

You will be using the lap-shoulder belt to secure the child restraint in this position. Follow the instructions that came with the child restraint.

1. Move the seat as far back as it will go before securing the forward-facing child restraint.

When the passenger sensing system has turned off the right front passenger frontal airbag and seat-mounted side impact airbag, the off indicator on the passenger airbag status indicator should light and stay lit when you start the vehicle. See *Passenger Airbag Status Indicator* on page 4-49.

2. Put the child restraint on the seat.
3. Pick up the latch plate, and run the lap and shoulder portions of the vehicle's safety belt through or around the restraint. The child restraint instructions will show you how.

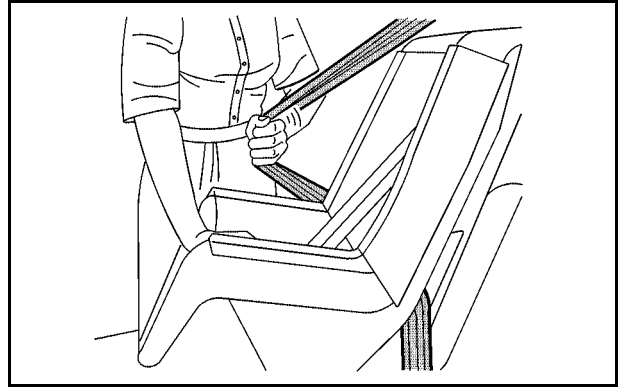
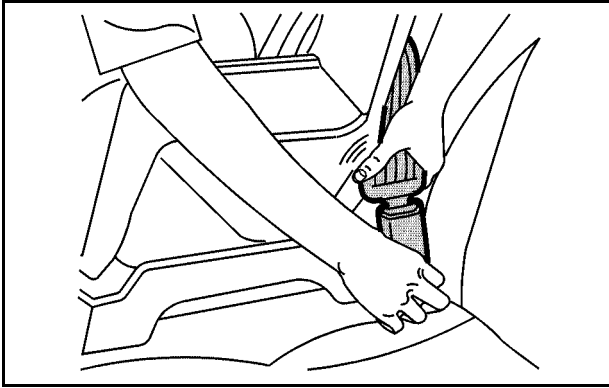

4. Push the latch plate into the buckle until it clicks.
Position the release button on the buckle so that the safety belt could be quickly unbuckled if necessary.

5. Pull the rest of the shoulder belt all the way out of the retractor to set the lock.

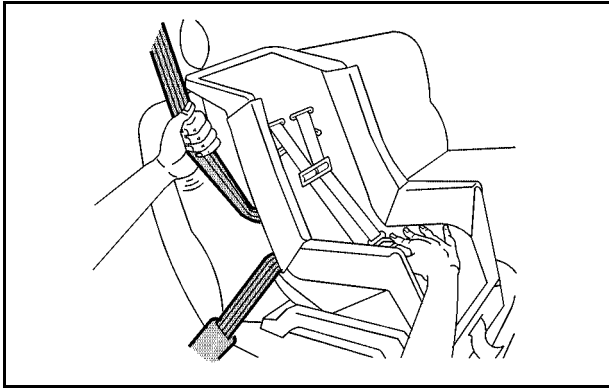

If the airbags are off, the off indicator in the passenger airbag status indicator will come on and stay on when the vehicle is started.

If a child restraint has been installed and the on indicator is lit, see "If the On Indicator is Lit for a Child Restraint" under *Passenger Sensing System* on page 2-68 for more information.

To remove the child restraint, unbuckle the vehicle safety belt and let it return to the stowed position.

6. To tighten the belt, push down on the child restraint, pull the shoulder portion of the belt to tighten the lap portion of the belt and feed the shoulder belt back into the retractor. When installing a forward-facing child restraint, it may be helpful to use your knee to push down on the child restraint as you tighten the belt.
7. Push and pull the child restraint in different directions to be sure it is secure.

Airbag System

The vehicle has the following airbags:

- A frontal airbag for the driver.
- A frontal airbag for the right front passenger.
- A seat-mounted side impact airbag for the driver.
- A seat-mounted side impact airbag for the right front passenger.

The vehicle may also have the following airbags:

- A roof-rail airbag for the driver and the passenger seated directly behind the driver.
- A roof-rail airbag for the right front passenger and the passenger seated directly behind the right front passenger.

All of the airbags in your vehicle will have the word AIRBAG embossed in the trim or on an attached label near the deployment opening.

For frontal airbags, the word AIRBAG will appear on the middle part of the steering wheel for the driver and on the instrument panel for the right front passenger.

With seat-mounted side impact airbags, the word AIRBAG will appear on the side of the seatback closest to the door.

With roof-rail airbags, the word AIRBAG will appear along the headliner or trim.

Airbags are designed to supplement the protection provided by safety belts. Even though today's airbags are also designed to help reduce the risk of injury from the force of an inflating bag, all airbags must inflate very quickly to do their job.

Here are the most important things to know about the airbag system:

 **WARNING:**

You can be severely injured or killed in a crash if you are not wearing your safety belt — even if you have airbags. Airbags are designed to work with safety belts, but do not replace them. Also, airbags are not designed to deploy in every crash. In some crashes safety belts are your only restraint. See *When Should an Airbag Inflate?* on page 2-63.

Wearing your safety belt during a crash helps reduce your chance of hitting things inside the vehicle or being ejected from it. Airbags are “supplemental restraints” to the safety belts. Everyone in your vehicle should wear a safety belt properly — whether or not there is an airbag for that person.

 **WARNING:**

Airbags inflate with great force, faster than the blink of an eye. Anyone who is up against, or very close to, any airbag when it inflates can be seriously injured or killed. Do not sit unnecessarily close to the airbag, as you would be if you were sitting on the edge of your seat or leaning forward. Safety belts help keep you in position before and during a crash. Always wear your safety belt, even with airbags. The driver should sit as far back as possible while still maintaining control of the vehicle.

Occupants should not lean on or sleep against the door or side windows in seating positions with seat-mounted side impact airbags and/or roof-rail airbags.

⚠ WARNING:

Children who are up against, or very close to, any airbag when it inflates can be seriously injured or killed. Airbags plus lap-shoulder belts offer protection for adults and older children, but not for young children and infants. Neither the vehicle's safety belt system nor its airbag system is designed for them. Young children and infants need the protection that a child restraint system can provide. Always secure children properly in your vehicle. To read how, see *Older Children on page 2-33* or *Infants and Young Children on page 2-37*.



There is an airbag readiness light on the instrument panel, which shows the airbag symbol.

The system checks the airbag electrical system for malfunctions. The light tells you if there is an electrical problem. See *Airbag Readiness Light on page 4-48* for more information.

Where Are the Airbags?



The driver frontal airbag is in the middle of the steering wheel.



The right front passenger frontal airbag is in the instrument panel on the passenger's side.



Driver Side shown, Passenger Side similar

The seat-mounted side impact airbags for the driver and right front passenger are in the side of the seatbacks closest to the door.



Driver Side shown, Passenger Side similar

If the vehicle has roof-rail airbags for the driver, right front passenger, and second row outboard passengers, they are in the ceiling above the side windows.

 **WARNING:**

If something is between an occupant and an airbag, the airbag might not inflate properly or it might force the object into that person causing severe injury or even death. The path of an inflating airbag must be kept clear. Do not put anything between an occupant and an airbag, and do not attach or put anything on the steering wheel hub or on or near any other airbag covering.

Do not use seat accessories that block the inflation path of a seat-mounted side impact airbag.

Never secure anything to the roof of a vehicle with roof-rail airbags by routing a rope or tie down through any door or window opening. If you do, the path of an inflating roof-rail airbag will be blocked.

When Should an Airbag Inflate?

Frontal airbags are designed to inflate in moderate to severe frontal or near-frontal crashes to help reduce the potential for severe injuries mainly to the driver's or right front passenger's head and chest. However, they are only designed to inflate if the impact exceeds a predetermined deployment threshold. Deployment thresholds are used to predict how severe a crash is likely to be in time for the airbags to inflate and help restrain the occupants.

Whether your frontal airbags will or should deploy is not based on how fast your vehicle is traveling. It depends largely on what you hit, the direction of the impact, and how quickly your vehicle slows down.

Frontal airbags may inflate at different crash speeds. For example:

- If the vehicle hits a stationary object, the airbags could inflate at a different crash speed than if the vehicle hits a moving object.
- If the vehicle hits an object that deforms, the airbags could inflate at a different crash speed than if the vehicle hits an object that does not deform.
- If the vehicle hits a narrow object (like a pole), the airbags could inflate at a different crash speed than if the vehicle hits a wide object (like a wall).
- If the vehicle goes into an object at an angle, the airbags could inflate at a different crash speed than if the vehicle goes straight into the object.

Thresholds can also vary with specific vehicle design.

Frontal airbags are not intended to inflate during vehicle rollovers, rear impacts, or in many side impacts.

Your vehicle has a seat position sensor which enables the sensing system to monitor the position of the right front passenger's seat. The passenger seat position sensor and passenger safety belt buckle switch provide information that is used to determine if the airbags should deploy at a reduced level or at full deployment.

In addition, your vehicle has a dual-stage driver airbag. Dual-stage airbags adjust the restraint according to crash severity. Your vehicle has electronic frontal

sensors, which help the sensing system distinguish between a moderate frontal impact and a more severe frontal impact. For moderate frontal impacts, dual-stage airbags inflate at a level less than full deployment. For more severe frontal impacts, full deployment occurs.

Your vehicle also has a dual-depth passenger airbag that adjusts the restraint according to crash severity, seat location, and safety belt status using electronic frontal sensor(s) and other special sensors which enable the sensing system to monitor the position of the front passenger seat. The passenger airbag inflates to a reduced depth when the passenger seat is in a forward position. For more rearward front seating positions, the passenger airbag may inflate to an increased depth (a full deployment), based on safety belt status and the crash severity measured early in the event. (Always wear your safety belt, even with frontal airbags.)

Your vehicle has seat-mounted side impact airbags. Your vehicle may have roof-rail airbags. See *Airbag System on page 2-58*. Seat-mounted side impact and roof-rail airbags are intended to inflate in moderate to severe side crashes. Seat-mounted side impact and roof-rail airbags will inflate if the crash severity is above the system's designed threshold level. The threshold level can vary with specific vehicle design.

Seat-mounted side impact and roof-rail airbags are not intended to inflate in frontal impacts, near-frontal impacts, rollovers, or rear impacts. A seat-mounted side impact airbag is intended to deploy on the side of the vehicle that is struck. Both roof-rail airbags will deploy when either side of the vehicle is struck.

In any particular crash, no one can say whether an airbag should have inflated simply because of the damage to a vehicle or because of what the repair costs were. For frontal airbags, inflation is determined by what the vehicle hits, the angle of the impact, and how quickly the vehicle slows down. For seat-mounted side impact and roof-rail airbags, deployment is determined by the location and severity of the side impact.

What Makes an Airbag Inflate?

In a deployment event, the sensing system sends an electrical signal triggering a release of gas from the inflator. Gas from the inflator fills the airbag causing the bag to break out of the cover and deploy. The inflator, the airbag, and related hardware are all part of the airbag module.

Frontal airbag modules are located inside the steering wheel and instrument panel. For vehicles with seat-mounted side impact airbags, there are airbag modules in the side of the front seatbacks closest to the door. For vehicles with roof-rail airbags, there are airbag modules in the ceiling of the vehicle, near the side windows that have occupant seating positions.

How Does an Airbag Restrain?

In moderate to severe frontal or near frontal collisions, even belted occupants can contact the steering wheel or the instrument panel. In moderate to severe side collisions, even belted occupants can contact the inside of the vehicle.

Airbags supplement the protection provided by safety belts. Frontal airbags distribute the force of the impact more evenly over the occupant's upper body, stopping the occupant more gradually. Seat-mounted side impact and roof-rail airbags distribute the force of the impact more evenly over the occupant's upper body.

But airbags would not help in many types of collisions, primarily because the occupant's motion is not toward those airbags. See *When Should an Airbag Inflate?* on page 2-63 for more information.

Airbags should never be regarded as anything more than a supplement to safety belts.

What Will You See After an Airbag Inflates?

After the frontal airbags and seat-mounted side impact airbags inflate, they quickly deflate, so quickly that some people may not even realize an airbag inflated. Roof-rail airbags may still be at least partially inflated for some time after they deploy. Some components of the airbag module may be hot for several minutes. For location of the airbag modules, see *What Makes an Airbag Inflate?* on page 2-65.

The parts of the airbag that come into contact with you may be warm, but not too hot to touch. There may be some smoke and dust coming from the vents in the deflated airbags. Airbag inflation does not prevent the driver from seeing out of the windshield or being able to steer the vehicle, nor does it prevent people from leaving the vehicle.

WARNING:

When an airbag inflates, there may be dust in the air. This dust could cause breathing problems for people with a history of asthma or other breathing trouble. To avoid this, everyone in the vehicle should get out as soon as it is safe to do so. If you have breathing problems but cannot get out of the vehicle after an airbag inflates, then get fresh air by opening a window or a door. If you experience breathing problems following an airbag deployment, you should seek medical attention.

The vehicle has a feature that may automatically unlock the doors, turn on the interior lamps and hazard warning flashers, and shut off the fuel system after the airbags inflate. You can lock the doors, turn off the interior lamps and hazard warning flashers by using the controls for those features.

 **WARNING:**

A crash severe enough to inflate the airbags may have also damaged important functions in the vehicle, such as the fuel system, brake and steering systems, etc. Even if the vehicle appears to be drivable after a moderate crash, there may be concealed damage that could make it difficult to safely operate the vehicle.

Use caution if you should attempt to restart the engine after a crash has occurred.

In many crashes severe enough to inflate the airbag, windshields are broken by vehicle deformation. Additional windshield breakage may also occur from the right front passenger airbag.

- Airbags are designed to inflate only once. After an airbag inflates, you will need some new parts for the airbag system. If you do not get them, the airbag system will not be there to help protect you in another crash. A new system will include airbag modules and possibly other parts. The service manual for your vehicle covers the need to replace other parts.
- The vehicle has a crash sensing and diagnostic module which records information after a crash. See *Vehicle Data Recording and Privacy on page 8-18* and *Event Data Recorders on page 8-19*.
- Let only qualified technicians work on the airbag systems. Improper service can mean that an airbag system will not work properly. See your dealer for service.

Passenger Sensing System

The vehicle has a passenger sensing system for the right front passenger position. The passenger airbag status indicator will be visible on the overhead console when the vehicle is started.

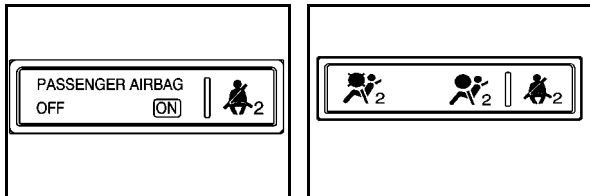

United States

Canada

The words ON and OFF, or the symbol for on and off, are visible during the system check. If you are using remote start, if equipped, to start the vehicle from a distance, you may not see the system check. When the system check is complete, either the word ON or OFF, or the symbol for on or off, will be visible. See *Passenger Airbag Status Indicator* on page 4-49.

The passenger sensing system turns off the right front passenger frontal airbag and seat-mounted side impact airbag under certain conditions. The driver airbags and the roof-rail airbags are not affected by the passenger sensing system.

The passenger sensing system works with sensors that are part of the right front passenger seat. The sensors are designed to detect the presence of a properly-seated occupant and determine if the right front passenger frontal airbag and seat-mounted side impact airbag should be enabled (may inflate) or not.

According to accident statistics, children are safer when properly secured in a rear seat in the correct child restraint for their weight and size.

We recommend that children be secured in a rear seat, including: an infant or a child riding in a rear-facing child restraint; a child riding in a forward-facing child seat; an older child riding in a booster seat; and children, who are large enough, using safety belts.

A label on the sun visor says, "Never put a rear-facing child seat in the front." This is because the risk to the rear-facing child is so great, if the airbag deploys.

 **WARNING:**

A child in a rear-facing child restraint can be seriously injured or killed if the right front passenger airbag inflates. This is because the back of the rear-facing child restraint would be very close to the inflating airbag. A child in a forward-facing child restraint can be seriously injured or killed if the right front passenger airbag inflates and the passenger seat is in a forward position.

Even if the passenger sensing system has turned off the right front passenger frontal airbag and seat-mounted side impact airbag (if equipped), no system is fail-safe. No one can guarantee that an airbag will not deploy under some unusual circumstance, even though the airbag(s) are off.

Secure rear-facing child restraints in a rear seat, even if the airbag(s) are off. If you secure a forward-facing child restraint in the right front seat,

(Continued)

WARNING: (Continued)

always move the front passenger seat as far back as it will go. It is better to secure the child restraint in a rear seat.

The passenger sensing system is designed to turn off the right front passenger airbag and seat-mounted side impact airbag if:

- The right front passenger seat is unoccupied.
- The system determines that an infant is present in a rear-facing infant seat.
- The system determines that a small child is present in a child restraint.
- The system determines that a small child is present in a booster seat.
- A right front passenger takes his/her weight off of the seat for a period of time.
- The right front passenger seat is occupied by a smaller person, such as a child who has outgrown child restraints.
- Or, if there is a critical problem with the airbag system or the passenger sensing system.

When the passenger sensing system has turned off the right front passenger frontal airbag and seat-mounted side impact airbag, the off indicator will light and stay lit to remind you that the airbags are off. See *Passenger Airbag Status Indicator on page 4-49*.

The passenger sensing system is designed to turn on (may inflate) the right front passenger frontal airbag and seat-mounted side impact airbag anytime the system senses that a person of adult size is sitting properly in the right front passenger seat.

When the passenger sensing system has allowed the airbags to be enabled, the on indicator will light and stay lit to remind you that the airbags are active.

For some children who have outgrown child restraints and for very small adults, the passenger sensing system may or may not turn off the right front passenger frontal airbag and seat-mounted side impact airbag, depending upon the person's seating posture and body build. Everyone in the vehicle who has outgrown child restraints should wear a safety belt properly — whether or not there is an airbag for that person.

 **WARNING:**

If the airbag readiness light ever comes on and stays on, it means that something may be wrong with the airbag system. To help avoid injury to yourself or others, have the vehicle serviced right away. See *Airbag Readiness Light on page 4-48* for more information, including important safety information.

If the On Indicator is Lit for a Child Restraint

If a child restraint has been installed and the on indicator is lit:

1. Turn the vehicle off.
2. Remove the child restraint from the vehicle.
3. Remove any additional items from the seat such as blankets, cushions, seat covers, seat heaters, or seat massagers.
4. Reinstall the child restraint following the directions provided by the child restraint manufacturer and refer to *Securing a Child Restraint in the Right Front Seat Position on page 2-54*.

5. If, after reinstalling the child restraint and restarting the vehicle, the on indicator is still lit, turn the vehicle off. Then slightly recline the vehicle seatback and adjust the seat cushion, if adjustable, to make sure that the vehicle seatback is not pushing the child restraint into the seat cushion.

Also make sure the child restraint is not trapped under the vehicle head restraint. If this happens, adjust the head restraint. See *Head Restraints on page 2-2*.

6. Restart the vehicle.

If the on indicator is still lit, secure the child in the child restraint in a rear seat position in the vehicle, and check with your dealer.

If the Off Indicator is Lit for an Adult-Size Occupant



If a person of adult-size is sitting in the right front passenger seat, but the off indicator is lit, it could be because that person is not sitting properly in the seat.

If this happens, use the following steps to allow the system to detect that person and enable the right front passenger frontal airbag and seat-mounted side impact airbag:

1. Turn the vehicle off.
2. Remove any additional material from the seat, such as blankets, cushions, seat covers, seat heaters, or seat massagers.
3. Place the seatback in the fully upright position.
4. Have the person sit upright in the seat, centered on the seat cushion, with legs comfortably extended.
5. Restart the vehicle and have the person remain in this position for two to three minutes after the on indicator is lit.

Additional Factors Affecting System Operation

Safety belts help keep the passenger in position on the seat during vehicle maneuvers and braking, which helps the passenger sensing system maintain the passenger airbag status. See “Safety Belts” and “Child Restraints” in the Index for additional information about the importance of proper restraint use.

A thick layer of additional material, such as a blanket or cushion, or aftermarket equipment such as seat covers, seat heaters, and seat massagers can affect how well the passenger sensing system operates. We recommend that you not use seat covers or other aftermarket equipment except when approved by GM for your specific vehicle. See *Adding Equipment to Your Airbag-Equipped Vehicle* on page 2-74 for more information about modifications that can affect how the system operates.

WARNING:

Stowing of articles under the passenger seat or between the passenger seat cushion and seatback may interfere with the proper operation of the passenger sensing system.

Servicing Your Airbag-Equipped Vehicle

Airbags affect how the vehicle should be serviced. There are parts of the airbag system in several places around the vehicle. Your dealer and the service manual have information about servicing the vehicle and the airbag system. To purchase a service manual, see *Service Publications Ordering Information* on page 8-17.

WARNING:

For up to 10 seconds after the ignition is turned off and the battery is disconnected, an airbag can still inflate during improper service. You can be injured if you are close to an airbag when it inflates. Avoid yellow connectors. They are probably part of the airbag system. Be sure to follow proper service procedures, and make sure the person performing work for you is qualified to do so.

Adding Equipment to Your Airbag-Equipped Vehicle

Q: Is there anything I might add to or change about the vehicle that could keep the airbags from working properly?

A: Yes. If you add things that change your vehicle's frame, bumper system, height, front end or side sheet metal, they may keep the airbag system from working properly. Changing or moving any parts of the front seats, safety belts, the airbag sensing and diagnostic module, steering wheel, instrument panel, roof-rail airbag modules, ceiling headliner or pillar garnish trim, overhead console, front sensors, side impact sensors, or airbag wiring can affect the operation of the airbag system.

In addition, your vehicle has a passenger sensing system for the right front passenger's position, which includes sensors that are part of the passenger's seat. The passenger sensing system may not operate properly if the original seat trim is replaced with non-GM covers, upholstery or trim, or with GM covers, upholstery or trim designed for a different vehicle. Any object, such as an aftermarket seat heater or a comfort enhancing pad or device,

installed under or on top of the seat fabric, could also interfere with the operation of the passenger sensing system. This could either prevent proper deployment of the passenger airbag(s) or prevent the passenger sensing system from properly turning off the passenger airbag(s). See *Passenger Sensing System on page 2-68*.

If you have any questions about this, you should contact Customer Assistance before you modify your vehicle. The phone numbers and addresses for Customer Assistance are in Step Two of the Customer Satisfaction Procedure in this manual. See *Customer Satisfaction Procedure on page 8-2*.

Q: Because I have a disability, I have to get my vehicle modified. How can I find out whether this will affect my airbag system?

A: If you have questions, call Customer Assistance. The phone numbers and addresses for Customer Assistance are in Step Two of the Customer Satisfaction Procedure in this manual. See *Customer Satisfaction Procedure on page 8-2*.

In addition, your dealer and the service manual have information about the location of the airbag sensors, sensing and diagnostic module and airbag wiring.

Restraint System Check

Checking the Restraint Systems

Safety Belts

Now and then, check that the safety belt reminder light, safety belts, buckles, latch plates, retractors, and anchorages are all working properly.

Look for any other loose or damaged safety belt system parts that might keep a safety belt system from doing its job. See your dealer to have it repaired. Torn or frayed safety belts may not protect you in a crash. They can rip apart under impact forces. If a belt is torn or frayed, get a new one right away.

Make sure the safety belt reminder light is working. See *Safety Belt Reminders on page 4-48* for more information.

Keep safety belts clean and dry. See *Care of Safety Belts on page 6-99*.

Airbags

The airbag system does not need regularly scheduled maintenance or replacement. Make sure the airbag readiness light is working. See *Airbag Readiness Light on page 4-48* for more information.

Notice: If an airbag covering is damaged, opened, or broken, the airbag may not work properly. Do not open or break the airbag coverings. If there are any opened or broken airbag covers, have the airbag covering and/or airbag module replaced. For the location of the airbag modules, see *What Makes an Airbag Inflate? on page 2-65*. See your dealer for service.

Replacing Restraint System Parts After a Crash

WARNING:

A crash can damage the restraint systems in your vehicle. A damaged restraint system may not properly protect the person using it, resulting in serious injury or even death in a crash. To help make sure your restraint systems are working properly after a crash, have them inspected and any necessary replacements made as soon as possible.

If the vehicle has been in a crash, do you need new safety belts or LATCH system (if equipped) parts?

After a very minor crash, nothing may be necessary. But the safety belt assemblies that were used during any crash may have been stressed or damaged. See your dealer to have the safety belt assemblies inspected or replaced.

If the vehicle has the LATCH system and it was being used during a crash, you may need new LATCH system parts.

New parts and repairs may be necessary even if the safety belt or LATCH system (if equipped), was not being used at the time of the crash.

If an airbag inflates, you will need to replace airbag system parts. See the part on the airbag system earlier in this section.

Have the safety belt pretensioners checked if the vehicle has been in a crash, if the airbag readiness light stays on after the vehicle is started, or while you are driving. See *Airbag Readiness Light on page 4-48*.

Section 3 Features and Controls

Keys	3-3	Starting and Operating Your Vehicle	3-22
Remote Keyless Entry (RKE) System	3-4	New Vehicle Break-In	3-22
Remote Keyless Entry (RKE) System Operation	3-4	Ignition Positions	3-23
Remote Vehicle Start	3-7	Retained Accessory Power (RAP)	3-24
Doors and Locks	3-9	Starting the Engine	3-24
Door Locks	3-9	Engine Coolant Heater	3-26
Central Door Unlocking System	3-10	Automatic Transmission Operation	3-27
Power Door Locks	3-10	Performance Shifting	3-29
Programmable Automatic Door Locks	3-10	Parking Brake	3-30
Rear Door Security Locks	3-10	Shifting Into Park	3-31
Lockout Protection	3-11	Shifting Out of Park	3-32
Trunk	3-12	Parking Over Things That Burn	3-33
Windows	3-14	Engine Exhaust	3-34
Power Windows	3-15	Running the Vehicle While Parked	3-35
Sun Visors	3-17	Mirrors	3-36
Theft-Deterrent Systems	3-18	Automatic Dimming Rearview Mirror	3-36
Valet Lockout Switch	3-18	Compass	3-36
Content Theft-Deterrent	3-19	Outside Power Foldaway Mirrors	3-37
PASS-Key® III+ Electronic Immobilizer	3-21	Outside Automatic Dimming Mirror	3-38
PASS-Key® III+ Electronic Immobilizer Operation	3-21	Park Tilt Mirrors	3-39
		Outside Convex Mirror	3-39
		Outside Heated Mirrors	3-39

Section 3 Features and Controls

Object Detection Systems	3-40	Storage Areas	3-55
Ultrasonic Front and Rear Parking Assist (UFRPA)	3-40	Glove Box	3-55
Side Blind Zone Alert (SBZA)	3-43	Cupholders	3-55
Lane Departure Warning (LDW)	3-46	Front Storage Area	3-56
Universal Home Remote System	3-48	Center Console Storage	3-56
Universal Home Remote System Operation (With Three Round LED)	3-49	Center Flex Storage Unit	3-56
		Floor Mats	3-57
		Rear Seat Armrest	3-57
		Convenience Net	3-57
		Sunroof	3-57

Keys

⚠ WARNING:

Leaving children in a vehicle with the ignition key is dangerous for many reasons, children or others could be badly injured or even killed. They could operate the power windows or other controls or even make the vehicle move. The windows will function with the keys in the ignition and children could be seriously injured or killed if caught in the path of a closing window. Do not leave the keys in a vehicle with children.

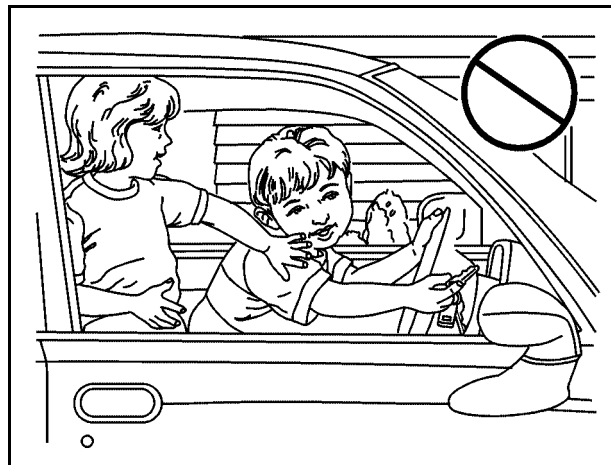

The master key is used for the driver door, ignition, and glove box.

The valet key is used for the driver door and ignition.

Notice: If you ever lock your keys in the vehicle, you may have to damage the vehicle to get in. Be sure you have spare keys.

In an emergency, contact Roadside Assistance. See *Roadside Service* on page 8-7.

Remote Keyless Entry (RKE) System

See *Radio Frequency Statement on page 8-20* for information regarding Part 15 of the Federal Communications Commission (FCC) Rules and RSS-210/211 of Industry Canada.

Changes or modifications to this system by other than an authorized service facility could void authorization to use this equipment.

If there is a decrease in the RKE operating range, try this:

- Check the distance. The transmitter may be too far from the vehicle. Stand closer during rainy or snowy weather.
- Check the location. Other vehicles or objects may be blocking the signal. Take a few steps to the left or right, hold the transmitter higher, and try again.
- Check the transmitter's battery. See "Battery Replacement" later in this section.
- If the transmitter is still not working correctly, see your dealer or a qualified technician for service.

Remote Keyless Entry (RKE) System Operation

The Remote Keyless Entry (RKE) transmitter functions work up to 60 m (195 feet) away from the vehicle.

There are other conditions which can affect the performance of the transmitter. See *Remote Keyless Entry (RKE) System on page 3-4*.

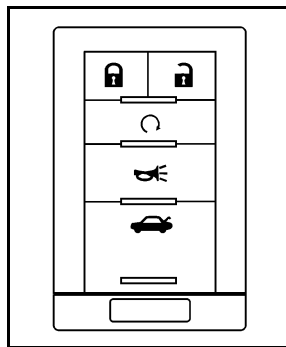



**With Remote Start
(Without Remote Start
Similar)**



⌚ (Remote Vehicle Start): Press to start the engine from outside the vehicle using the RKE transmitter. See *Remote Vehicle Start on page 3-7* for additional information.

 **(Lock):** Press to lock all the doors. If enabled through the Driver Information Center (DIC), the parking lamps may flash once to indicate locking has occurred.

The horn may chirp when  is pressed again within five seconds. See *DIC Vehicle Customization on page 4-79* for additional information.



Pressing  may arm the content theft-deterrent system. See *Content Theft-Deterrent on page 3-19*.

 **(Unlock):** Press once to unlock the driver door.

If  is pressed again within five seconds, all remaining doors unlock. The interior lamps come on and stay on for 20 seconds or until the ignition is turned on. If enabled through the DIC, the parking lamps flash twice to indicate unlocking has occurred. See *DIC Vehicle Customization on page 4-79*. Pressing  may disarm the content theft-deterrent system. See *Content Theft-Deterrent on page 3-19*.

 **(Remote Trunk Release):** Press and hold for about one second to unlock the trunk. The transmission must be in P (Park).

 **(Vehicle Locator/Panic Alarm):** Press and release to locate the vehicle. The turn signal lamps flash and the horn sounds three times.

Press and hold  for more than two seconds to activate the panic alarm. The turn signal lamps flash and the horn sounds repeatedly for 30 seconds. The alarm turns off when the ignition is moved to ON/RUN or  is pressed again. The ignition must be in LOCK/OFF for the panic alarm to work.

The vehicle comes with two transmitters. Each transmitter will have a number on top of it, "1" or "2". These numbers correspond to the driver of the vehicle. For example, the memory seat position for driver 1 will be recalled when using the transmitter labeled "1", if enabled through the DIC. See *Memory Seat, Mirrors and Steering Wheel on page 2-6* and *DIC Vehicle Customization on page 4-79* for more information.

Programming Transmitters to the Vehicle

Only RKE transmitters programmed to the vehicle will work. If a transmitter is lost or stolen, a replacement can be purchased and programmed through your dealer. When the replacement transmitter is programmed to the vehicle, all remaining transmitters must also be programmed. Any lost or stolen transmitters no longer work once the new transmitter is programmed. Each vehicle can have up to eight transmitters programmed to it. See RELEARN REMOTE KEY under *DIC Operation and Displays on page 4-61*.

Battery Replacement

Replace the battery if the REPLACE BATTERY IN REMOTE KEY message displays in the DIC. See "REPLACE BATTERY IN REMOTE KEY" under *DIC Warnings and Messages on page 4-66* for additional information.

Notice: When replacing the battery, do not touch any of the circuitry on the transmitter. Static from your body could damage the transmitter.

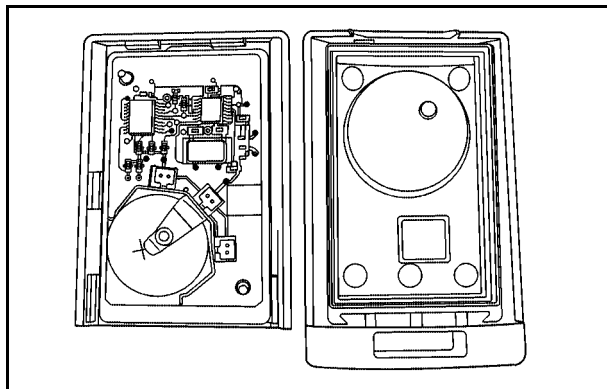

To replace the battery:

1. Separate the transmitter with a flat, thin object inserted into the notch, located above the metal base.
2. Remove the old battery. Do not use a metal object.
3. Insert the new battery, positive side facing up. Replace with a CR2032 or equivalent battery.
4. Reassemble the transmitter.

Remote Vehicle Start

The remote vehicle starting feature allows you to start the engine from outside of the vehicle. It also starts up the vehicle's automatic climate control system. When the remote start system is active, the climate control system will heat and cool the inside of the vehicle according to the previous settings of the system before turning the vehicle off. The rear window defogger will be turned on by the climate control system when it is cold outside. If the vehicle has heated seats, they will also turn on when it is cold outside. See *Heated and Ventilated Seats on page 2-5* for additional information. Cooled seats are not activated during a remote start. Normal operation of the climate control system will return after the key is turned to ON/RUN. See *Dual Climate Control System on page 4-36*.

Laws in some communities may restrict the use of remote starters. For example, some laws may require a person using remote start to have the vehicle in view when doing so. Check local regulations for any requirements on remote starting of vehicles.

Do not use the remote start feature if your vehicle is low on fuel. Your vehicle may run out of fuel.

If your vehicle has the remote start feature, the RKE transmitter functions will have an increased range of operation. However, the range may be less while the vehicle is running.

There are other conditions which can affect the performance of the transmitter, see *Remote Keyless Entry (RKE) System Operation on page 3-4* for additional information.

Ⓚ (Remote Start): This button will be on the RKE transmitter if you have remote start.

To start the vehicle using the remote start feature:

1. Aim the transmitter at the vehicle.
2. Press and release the transmitter's lock button, then immediately press and hold the transmitter's remote start button until the turn signal lights flash or if the vehicle's lights are not visible, press and hold the remote start button for at least four seconds. Pressing the remote start button again after the vehicle has started will turn off the ignition.

When the vehicle starts, the parking lamps will turn on and remain on while the vehicle is running. The vehicle's doors will be locked.

3. If it is the first remote start since the vehicle has been driven, repeat these steps, while the engine is still running, to extend the engine running time by 10 minutes. Remote start can be extended one time.

After entering the vehicle during a remote start, insert and turn the key to ON/RUN to drive the vehicle.

If the vehicle is left running it will automatically shut off after 10 minutes unless a time extension has been done.

To manually shut off a remote start:

- Aim the RKE transmitter at the vehicle and press the remote start button until the parking lamps turn off.
- Turn on the hazard warning flashers.
- Turn the ignition switch on and then off.

The remote vehicle start feature provides two separate starts, each with 10 minutes of engine running, or it provides one start with 10 minutes of engine running that may be extended 10 more minutes. If you press and release the transmitter lock button and then press and hold the remote start button on the RKE transmitter again before the first 10 minutes of engine running time has expired, 10 minutes are added to the remaining minutes. For example, if the lock button and then the remote start buttons are pressed again after five minutes of the engine run time, 10 minutes are added and you now have 15 minutes of engine running. The added ten minutes are considered a second remote vehicle start.

Once two remote starts or a single start with a time extension have been used, the vehicle must be started with the ignition key before you can use the remote start feature again.

The remote vehicle start feature will not operate if the key is in the ignition, the hood is not closed, or if there is an emission control system malfunction.

The engine will turn off during a remote vehicle start if the coolant temperature gets too high, or the oil pressure is too low.

Your vehicle was shipped from the factory with the remote vehicle start system enabled. The system may be disabled through the Driver Information Center (DIC). See "REMOTE START" under *DIC Vehicle Customization on page 4-79* for additional information.

See *Engine Exhaust on page 3-34* for important safety information when using remote start in a closed garage.

Remote Start Ready

If your vehicle does not have the remote vehicle start feature, it may have the remote start ready feature. This feature allows your dealer to add the manufacturer's remote vehicle start feature. See your dealer if you would like to add the manufacturer's remote vehicle start feature to your vehicle.

Doors and Locks

Door Locks

WARNING:

Unlocked doors can be dangerous.

- Passengers, especially children, can easily open the doors and fall out of a moving vehicle. When a door is locked, the handle will not open it. The chance of being thrown out of the vehicle in a crash is increased if the doors are not locked. So, all passengers should wear safety belts properly and the doors should be locked whenever the vehicle is driven.
- Young children who get into unlocked vehicles may be unable to get out. A child can be overcome by extreme heat and can suffer permanent injuries or even death from heat stroke. Always lock the vehicle whenever leaving it.

(Continued)

WARNING: (Continued)

- Outsiders can easily enter through an unlocked door when you slow down or stop your vehicle. Locking your doors can help prevent this from happening.

There are several ways to lock and unlock your vehicle.

Because the vehicle has the theft-deterrent system, you must unlock the doors with the key or RKE transmitter to avoid setting off the alarm.

From the outside, use either the key or the RKE transmitter.

From the inside, use the power door lock switches or manual lock knobs. The manual lock knobs are located at the top of the door panel near the window.

Push the manual lock knob down to lock the door.
To unlock the door, pull up on the knob.

Central Door Unlocking System

The vehicle has a central door unlocking mode. When unlocking the driver door, the other doors can be unlocked at the same time by turning the key clockwise in the door lock cylinder twice.

Power Door Locks

With power door locks, the switches on the front doors can be used to lock and unlock the vehicle.

 **(Unlock):** Press to unlock the doors.

 **(Lock):** Remove the key from the ignition and press to lock the doors.

Programmable Automatic Door Locks

The vehicle is programmed so that, when the doors are closed, the ignition is on, and the shift lever is moved out of P (Park), all the doors will lock. The doors will unlock every time the vehicle is stopped and the shift lever is moved into P (Park).

If someone needs to get out while the vehicle is not in P (Park), have the person use the manual lock knob or power door lock switch. When the door is closed again, it will not lock automatically. Use the manual lock knob or power door lock switch to lock the door.

The door locks can be programmed through prompts displayed on the Driver Information Center (DIC). These prompts allow the driver to choose various lock and unlock settings. For programming information, see *DIC Vehicle Customization on page 4-79*.

Rear Door Security Locks

Rear door security locks prevent passengers from opening the rear doors from the inside.

The rear door security locks are located on the inside edge of each rear door. The rear doors must be opened to access them.

To assist in finding the lock, the vehicle has the following:

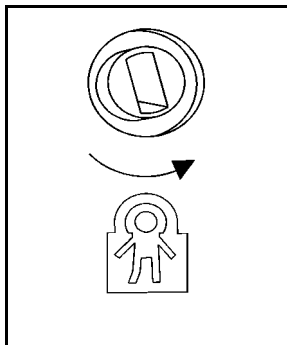

To use the lock:

1. Insert the key into the security lock slot and turn it so the slot is in the horizontal position.
2. Close the door.
3. Do the same for the other rear door.

To open a rear door when the security lock is on, do the following:

1. Unlock the door using the Remote Keyless Entry (RKE) transmitter, if the vehicle has one, the power door lock switch, or by lifting the rear door manual lock.
2. Open the door from the outside.

To cancel the rear door security lock:

1. Unlock the door and open it from the outside.
2. Insert the key into the security lock slot and turn it so the slot is in the vertical position.
3. Do the same for the other rear door.

Lockout Protection

If the key is in the ignition and the power door lock switch is used to lock the doors, all doors will lock and then the driver door will unlock. It is always recommended that the ignition key is removed from the vehicle when locking the doors.

The lockout protection feature can be overridden by holding the power door lock switch for three seconds or longer.

Trunk

WARNING:

Exhaust gases can enter the vehicle if it is driven with the liftgate, trunk/hatch open, or with any objects that pass through the seal between the body and the trunk/hatch or liftgate. Engine exhaust contains Carbon Monoxide (CO) which cannot be seen or smelled. It can cause unconsciousness and even death.

If the vehicle must be driven with the liftgate, or trunk/hatch open:

- Close all of the windows.
- Fully open the air outlets on or under the instrument panel.
- Adjust the Climate Control system to a setting that brings in only outside air and set the fan speed to the highest setting. See Climate Control System in the Index.
- If the vehicle is equipped with a power liftgate, disable the power liftgate function.

For more information about carbon monoxide, see *Engine Exhaust* on page 3-34.

Remote Trunk Release

 **(Remote Trunk Release):** The remote trunk release button is located to the left of the steering wheel next to the instrument panel brightness control. Press the button to open the trunk. The vehicle must be in P (Park) or N (Neutral) and the valet lockout switch must be off to use this button.

You can also press the button with the trunk symbol on the RKE transmitter to open the trunk. To disable this feature, see *Valet Lockout Switch* on page 3-18.

The trunk can be accessed using the Rear Seat Pass-Through. See "Rear Seat Pass-Through" following this section.

Emergency Trunk Release Handle

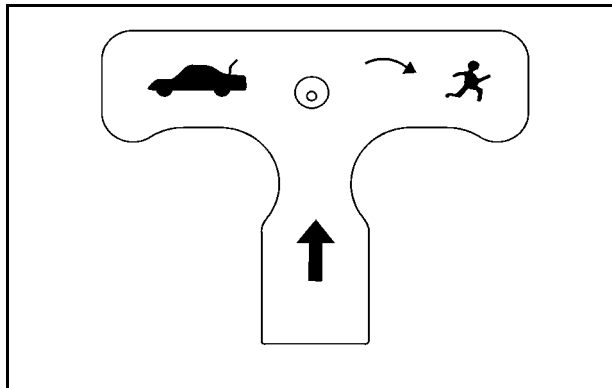

Notice: Do not use the emergency trunk release handle as a tie-down or anchor point when securing items in the trunk as it could damage the handle. The emergency trunk release handle is only intended to aid a person trapped in a latched trunk, enabling them to open the trunk from the inside.

There is a glow-in-the-dark emergency trunk release handle located inside the trunk near the latch. This handle will glow following exposure to light. Pull the release handle to open the trunk from the inside.

Rear Seat Pass-Through

The vehicle has a small door in the rear seat. This door allows access to the trunk from inside the vehicle.

The rear seat armrest must be down for the pass-through door to open. To release the pass-through door, move the release up. To close the door, raise it and push it until it latches.

Windows

WARNING:

Leaving children, helpless adults, or pets in a vehicle with the windows closed is dangerous. They can be overcome by the extreme heat and suffer permanent injuries or even death from heat stroke. Never leave a child, a helpless adult, or a pet alone in a vehicle, especially with the windows closed in warm or hot weather.

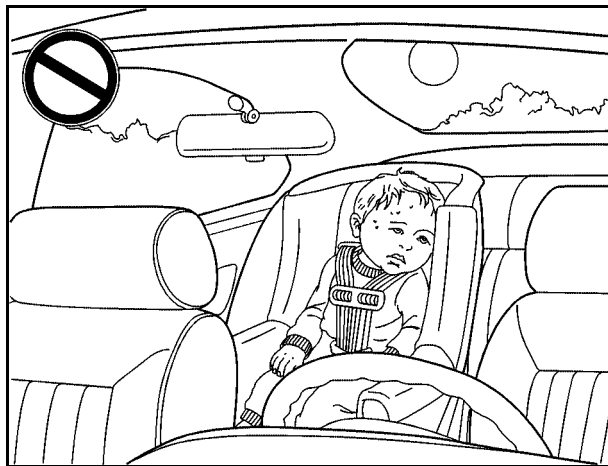

Power Windows

WARNING:

Leaving children in a vehicle with the keys is dangerous for many reasons, children or others could be badly injured or even killed. They could operate the power windows or other controls or even make the vehicle move. The windows will function and they could be seriously injured or killed if caught in the path of a closing window. Do not leave keys in a vehicle with children.

When there are children in the rear seat use the window lockout button to prevent unintentional operation of the windows.

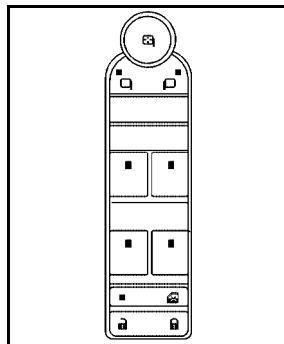

The power window switches are located on the driver door.

In addition, each door has a switch for its own window. The front power window switch operates with two positions for both up and down movement and the rear power window switch operates with one position for up and two positions for down movement. Press the switch to the first position to lower the window to the desired level. Pull the switch up to raise the window.

The vehicle has Retained Accessory Power (RAP) that allows you to use the power windows once the ignition has been turned off. For more information, see *Retained Accessory Power (RAP)* on page 3-24.

Express-Down/Up Windows

Windows with the express feature allow the windows to be raised and lowered all the way without holding the switch.

Press or pull the switch fully and release it to activate the express feature.

The express mode can be canceled at any time by briefly pressing or pulling the switch.

Express Window Anti-Pinch Feature

If any object is in the path of the window when the express-up is active, the window will stop at the obstruction and auto-reverse to a preset factory position. Weather conditions such as severe icing may also cause the window to auto-reverse. The window will return to normal operation once the obstruction or condition is removed.

Express Window Anti-Pinch Override

WARNING:

If express override is activated, the window will not reverse automatically. You or others could be injured and the window could be damaged. Before you use express override, make sure that all people and obstructions are clear of the window path.

In an emergency, the anti-pinch feature can be overridden in a supervised mode. Hold the window switch all the way up to the second position. The window will rise for as long as the switch is held. Once the switch is released, the express mode is re-activated.

In this mode, the window can still close on an object in its path. Use care when using the override mode.

Programming the Power Windows

If the battery on the vehicle has been recharged, disconnected, or is not working, you will need to reprogram each front power window for the express-up feature to work. Before reprogramming, replace or recharge the vehicle's battery.

To program each front window, follow these steps:

1. With the ignition in ACC/ACCESSORY, ON/RUN, or when Retained Accessory Power (RAP) is active, close all doors.
2. Press and hold the power window switch until the window is fully open.
3. Pull the power window switch up until the window is fully closed.
4. Continue holding the switch up for approximately two seconds after the window is completely closed.

The window is now reprogrammed. Repeat the process for the other windows.

Window Lockout

 **(Window Lockout):** The rear window lockout button is located on the driver door near the window switches.

Press the right side of the button to disable the rear window controls. The light on the button will illuminate, indicating the feature is in use. The rear windows still can be raised or lowered using the driver window switches when the lockout feature is active.

To restore power to the rear windows, press the button again. The light on the button will go out.

Sun Visors

Swing down the visor to block out glare. The visors also have side-to-side slide capability.

Lighted Visor Vanity Mirror

Pull the visor down and lift the cover to view the mirror. The light will come on when the cover is opened. It will go out when you close the cover. If your vehicle has the adjustable lighting feature, slide the switch up or down to brighten or dim the light.

Rear Power Sunshade

If your vehicle has a rear power sunshade, it helps to reduce the amount of heat and light entering the rear window.

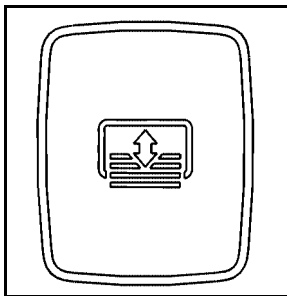

The switch is located on the overhead console.

The rear power sunshade is located in the rear shelf. It only works while the ignition is on or while the Retained Accessory Power (RAP) is active. See *Retained Accessory Power (RAP)* on page 3-24.

To raise the power sunshade, press and release the switch. To close the power sunshade, press and release the switch again.

Never store objects on the rear shelf because they may get caught in the sunshade or be tossed about in your vehicle.

Theft-Deterrent Systems

Vehicle theft is big business, especially in some cities. This vehicle has theft-deterrent features, however, they do not make it impossible to steal.

Valet Lockout Switch

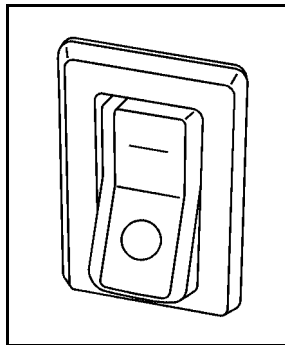

The valet lockout switch is located inside the glove box.

○ **(Off):** Press this side of the button to turn the lockout feature off. When the lockout feature is off, you can open the trunk using either the keyless entry transmitter or the trunk release button located near the headlamp switch on the instrument panel.

— **(On):** Press this side of the button to turn the lockout feature on. When the lockout feature is turned on, the trunk cannot be unlocked with the keyless entry transmitter or the trunk release button located near the headlamp switch on the instrument panel.

If the valet lockout feature is on it will also disable the Universal Home Remote transmitter, if equipped.

Locking the glove box with your key will also help to secure your vehicle.

See *Remote Keyless Entry (RKE) System Operation on page 3-4* and *Trunk on page 3-12* for additional information.

Content Theft-Deterrent



The security light is located on the instrument panel cluster.

To arm the system:

1. Open the door.
2. Lock the door using the power door lock switch with the door open or the Remote Keyless Entry (RKE) transmitter. The security light will flash.
3. Close all the doors. The security light will come on and stay on for approximately 30 seconds.

If a door or the trunk is opened without a key or a RKE transmitter the horn will sound and the lamps will flash for about 30 seconds.

The theft-deterrent system will not arm if you lock the doors with a key or use the manual door lock. It arms only if you use a power door lock with the door open or the RKE transmitter.

To avoid arming the alarm by accident:

- Lock the vehicle with the door key or the manual door lock.
- Always unlock a door with a key or use the RKE transmitter system. Pressing the unlock button on the RKE transmitter, or unlocking a door with the key disarms the content theft-deterrent system. Unlocking a door any other way will activate the alarm when a door or the trunk is opened.

If you activate the alarm by accident, unlock the driver's door with your key. You can also turn off the alarm by using the unlock button on the RKE transmitter system, or by starting the car with a valid key.

Changes or modifications made to this system by other than an authorized service facility could void authorization to use the theft system.

Testing the Alarm

1. From inside the vehicle, roll down the window, then get out of the vehicle, keeping the door open.
2. From outside of the vehicle, with the door open, lock the vehicle using the power door lock or the RKE system and close the door. Wait 30 seconds until the security lamp goes off.
3. Reach in and unlock the door using the manual lock and open the door. The horn will sound and the hazard lights will flash.

You can turn off the alarm by unlocking the driver's door with your key, using the unlock button on the RKE transmitter or by starting the car with a valid key.

If the alarm does not sound when it should, check to see if the horn works. The horn fuse may be blown. To replace the fuse, see *Fuses and Circuit Breakers* on page 6-106. If the fuse does not need to be replaced, you may need to have your vehicle serviced.

To reduce the possibility of theft, always arm the theft-deterrent system when leaving your vehicle.

PASS-Key® III+ Electronic Immobilizer

See *Radio Frequency Statement on page 8-20* for information regarding Part 15 of the Federal Communications Commission (FCC) Rules and RSS-210/211 of Industry Canada.

PASS-Key® III+ Electronic Immobilizer Operation

Your vehicle has PASS-Key® III+ (Personalized Automotive Security System) theft-deterrent system. PASS-Key® III+ is a passive theft-deterrent system.

The system is automatically armed when the key is removed from the ignition.

The system is automatically disarmed when the key is turned to ON/RUN, ACC/ACCESSORY or START from the LOCK/OFF position.

You do not have to manually arm or disarm the system.

The security light will come on if there is a problem with arming or disarming the theft-deterrent system.

When the PASS-Key® III+ system senses that someone is using the wrong key, it prevents the vehicle from starting. Anyone using a trial-and-error method to start the vehicle will be discouraged because of the high number of electrical key codes.

If the engine does not start and the security light comes on when trying to start the vehicle, there may be a problem with your theft-deterrent system. Turn the ignition off and try again.

If the engine still does not start, and the key appears to be undamaged, try another ignition key. At this time, you may also want to check the fuse, see *Fuses and Circuit Breakers on page 6-106*. If the engine still does not start with the other key, your vehicle needs service. If your vehicle does start, the first key may be faulty. See your dealer who can service the PASS-Key® III+ to have a new key made. In an emergency, contact Roadside Assistance.

It is possible for the PASS-Key® III+ decoder to “learn” the transponder value of a new or replacement key. Up to 10 keys may be programmed for the vehicle. The following procedure is for programming additional keys only. If all the currently programmed keys are lost or do not operate, you must see your dealer or a locksmith who can service PASS-Key® III+ to have keys made and programmed to the system.

See your dealer or a locksmith who can service PASS-Key® III+ to get a new key blank that is cut exactly as the ignition key that operates the system.

To program the new key:

1. Verify that the new key has a ⊕ stamped on it.
2. Insert the original, already programmed, key in the ignition and start the engine. If the engine will not start, see your dealer for service.
3. After the engine has started, turn the key to LOCK/OFF, and remove the key.
4. Insert the new key to be programmed and turn it to the ON/RUN position within five seconds of turning the original key to LOCK/OFF.

The security light will turn off once the key has been programmed.

5. Repeat Steps 1 through 4 if additional keys are to be programmed.

If you lose or damage your PASS-Key® III+ key, see your dealer or a locksmith who can service PASS-Key® III+ to have a new key made.

Do not leave the key or device that disarms or deactivates the theft deterrent system in the vehicle.

Starting and Operating Your Vehicle

New Vehicle Break-In

Notice: The vehicle does not need an elaborate break-in. But it will perform better in the long run if you follow these guidelines:

- Do not drive at any one constant speed, fast or slow, for the first 500 miles (805 km). Do not make full-throttle starts. Avoid downshifting to brake or slow the vehicle.
- Avoid making hard stops for the first 200 miles (322 km) or so. During this time the new brake linings are not yet broken in. Hard stops with new linings can mean premature wear and earlier replacement. Follow this breaking-in guideline every time you get new brake linings.
- Do not tow a trailer during break-in. See *Towing a Trailer on page 5-26* for the trailer towing capabilities of your vehicle and more information.

Following break-in, engine speed and load can be gradually increased.

Ignition Positions

The ignition switch has four different positions:

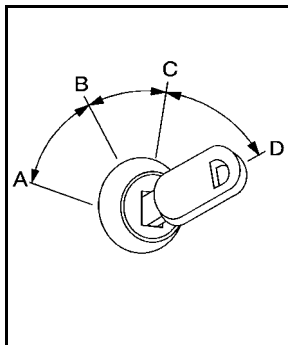

In order to shift out of P (Park), ignition must be in the ON/RUN or ACC/ACCESSORY and the brake pedal must be applied.

Notice: Using a tool to force the key to turn in the ignition could cause damage to the switch or break the key. Use the correct key, make sure it is all the way in, and turn it only with your hand. If the key cannot be turned by hand, see your dealer.

A (LOCK/OFF): This is the only position in which the ignition key can be inserted or removed. This position locks the ignition and transmission and steering column.

The steering can bind with the wheels turned off center. If this happens, move the steering wheel from right to left while turning the key to ACC/ACCESSORY. If this doesn't work, the vehicle needs service.

B (ACC/ACCESSORY): This position lets the radio and windshield wipers operate while the engine is off. To use ACC/ACCESSORY, turn the key clockwise.

C (ON/RUN): This position is where the key returns to after the vehicle is started. This position displays some of the warning and indicator lights.

The battery could be drained if you leave the key in the ACC/ACCESSORY or ON/RUN position with the engine off. You may not be able to start the vehicle if the battery is allowed to drain for an extended period of time.

D (START): This position starts the engine.

A warning chime will sound and the Driver Information Center (DIC) will display DRIVER DOOR OPEN when the driver door is opened if the ignition is in LOCK/OFF, ACC/ACCESSORY and the key is in the ignition. See *DIC Warnings and Messages on page 4-66* for more information.

Retained Accessory Power (RAP)

These vehicle accessories can be used for up to 10 minutes after the ignition key is turned off:

- Audio System
- Audio Steering Wheel Controls
- Power Windows
- Sunroof (if equipped)

Power to these accessories will work up to 10 minutes or until the driver's door is opened. For an additional 10 minutes of power, close all the doors and turn the key to ON/RUN and then back to LOCK/OFF.

Starting the Engine

Move the shift lever to P (Park) or N (Neutral). The engine will not start in any other position. To restart the engine when the vehicle is already moving, use N (Neutral) only.

Notice: Do not try to shift to P (Park) if the vehicle is moving. If you do, you could damage the transmission. Shift to P (Park) only when the vehicle is stopped.

Starting Procedure

1. With your foot off the accelerator pedal, turn the ignition to START. When the engine starts, let go of the key. The idle speed will slow down as the engine warms. Do not race the engine immediately after starting it. Operate the engine and transmission gently to allow the oil to warm up and lubricate all moving parts.

The vehicle has a Computer-Controlled Cranking System. This feature assists in starting the engine and protects components. If the ignition key is turned to the START position, and then released when the engine begins cranking, the engine will continue cranking for a few seconds or until the vehicle starts. If the engine does not start and the key is held in START, cranking will be stopped after 15 seconds to prevent cranking motor damage. To prevent gear damage, this system also prevents cranking if the engine is already running. Engine cranking can be stopped by turning the ignition switch to the ACC/ACCESSORY or LOCK/OFF position.

Notice: Cranking the engine for long periods of time, by returning the key to the START position immediately after cranking has ended, can overheat and damage the cranking motor, and drain the battery. Wait at least 15 seconds between each try, to let the cranking motor cool down.

2. If the engine does not start after 5-10 seconds, especially in very cold weather (below 0°F or -18°C), it could be flooded with too much gasoline. Try pushing the accelerator pedal all the way to the floor and holding it there as you hold the key in START for up to a maximum of 15 seconds. Wait at least 15 seconds between each try, to allow the cranking motor to cool down. When the engine starts, let go of the key and accelerator. If the vehicle starts briefly but then stops again, repeat these steps. This clears the extra gasoline from the engine. Do not race the engine immediately after starting it. Operate the engine and transmission gently until the oil warms up and lubricates all moving parts.

Notice: The engine is designed to work with the electronics in the vehicle. If you add electrical parts or accessories, you could change the way the engine operates. Before adding electrical equipment, check with your dealer. If you do not, the engine might not perform properly. Any resulting damage would not be covered by the vehicle warranty.

Engine Coolant Heater

The engine coolant heater can provide easier starting and better fuel economy during engine warm-up in cold weather conditions at or below 0°F (-18°C). Vehicles with an engine coolant heater should be plugged in at least four hours before starting.

To Use the Engine Coolant Heater

1. Turn off the engine.
2. Open the hood and unwrap the electrical cord.
The electrical cord is located on the driver side of the engine, behind the transmission dipstick/fluid fill location and next to the engine.
3. Plug it into a normal, grounded 110-volt AC outlet.

WARNING:

Plugging the cord into an ungrounded outlet could cause an electrical shock. Also, the wrong kind of extension cord could overheat and cause a fire. You could be seriously injured. Plug the cord into a properly grounded three-prong 110-volt AC outlet. If the cord will not reach, use a heavy-duty three-prong extension cord rated for at least 15 amps.

4. Before starting the engine, be sure to unplug and store the cord as it was before to keep it away from moving engine parts and prevent damage.

The length of time the heater should remain plugged in depends on several factors. Ask a dealer in the area where you will be parking the vehicle for the best advice on this.

Automatic Transmission Operation

The automatic transmission may have a shift lever located either on the steering column or on the console between the seats.



P R N D 3 2 1

There are several different positions for the shift lever.

P (Park): This position locks the front wheels. It is the best position to use when you start the engine because the vehicle cannot move easily.

WARNING:

It is dangerous to get out of the vehicle if the shift lever is not fully in P (Park) with the parking brake firmly set. The vehicle can roll.

Do not leave the vehicle when the engine is running unless you have to. If you have left the engine running, the vehicle can move suddenly. You or others could be injured. To be sure the vehicle will not move, even when you are on fairly level ground, always set the parking brake and move the shift lever to P (Park). See *Shifting Into Park* on page 3-31. If you are pulling a trailer, see *Towing a Trailer* on page 5-26.

Make sure the shift lever is fully in P (Park) before starting the engine. The vehicle has an automatic transmission shift lock control system. You have to fully apply the regular brakes before you can shift from P (Park) while the ignition key is in ON/RUN. If you cannot shift out of P (Park), ease pressure on the shift lever. Push the shift lever all the way into P (Park) as you maintain brake application. Then move the shift lever into another gear. See *Shifting Out of Park* on page 3-32.

R (Reverse): Use this gear to back up.

Notice: Shifting to R (Reverse) while the vehicle is moving forward could damage the transmission. The repairs would not be covered by the vehicle warranty. Shift to R (Reverse) only after the vehicle is stopped.

Also use this gear to rock the vehicle back and forth to get out of snow, ice or sand without damaging the transmission. See *If Your Vehicle is Stuck in Sand, Mud, Ice, or Snow on page 5-17* for additional information.

N (Neutral): In this position, the engine does not connect with the wheels. To restart when you are already moving, use N (Neutral) only. Also, use N (Neutral) when the vehicle is being towed.

 **WARNING:**

Shifting into a drive gear while the engine is running at high speed is dangerous. Unless your foot is firmly on the brake pedal, the vehicle could move very rapidly. You could lose control and hit people or objects. Do not shift into a drive gear while the engine is running at high speed.

Notice: Shifting out of P (Park) or N (Neutral) with the engine running at high speed may damage the transmission. The repairs would not be covered by the vehicle warranty. Be sure the engine is not running at high speed when shifting the vehicle.

D (Drive): This position is for normal driving. It provides the best fuel economy for the vehicle. If you need more power for passing, and you are:

- Going less than 35 mph (55 km/h), push the accelerator pedal about halfway down.
- Going about 35 mph (55 km/h) or more, push the accelerator all the way down.

The transmission will shift down to the next gear and have more power.

Downshifting the transmission in slippery road conditions could result in skidding, see Skidding under *Loss of Control on page 5-10*.

Notice: Driving the vehicle if you notice that it is moving slowly or not shifting gears as you increase speed may damage the transmission. Have the vehicle serviced right away. You can drive in 2 (Second) when you are driving less than 35 mph (55 km/h) and D (Drive) for higher speeds until then.

D (Drive) can be used for towing. You may want to shift the transmission to 3 (Third) or, if necessary, to a lower gear if the transmission shifts too often under heavy loads and/or hilly conditions.

See *Towing a Trailer on page 5-26* for more information.

3 (Third): This position is also used for normal driving. However, it reduces vehicle speed more than D (Drive) without using the brakes. You might choose 3 (Third) instead of D (Drive) when driving on hilly, winding roads, when towing a trailer, so there is less shifting between gears and when going down a steep hill.

2 (Second): This position reduces vehicle speed more than 3 (Third) without using the brakes. You can use 2 (Second) on hills. It can help control vehicle speed as you go down steep mountain roads, but then you would also want to use the brakes off and on.

Notice: Do not shift into 2 (Second) unless you are going slower than 65 mph (105 km/h), or you can damage the engine and/or transmission.

1 (First): This position reduces vehicle speed even more than 2 (Second) without using the brakes. You can use it on very steep hills, or in deep snow or mud. If the shift lever is put in 1 (First) while the vehicle is moving forward, the transmission will not shift into first gear until the vehicle is going slowly enough.

Notice: Spinning the tires or holding the vehicle in one place on a hill using only the accelerator pedal may damage the transmission. The repair will not be covered by the vehicle warranty. If you are stuck, do not spin the tires. When stopping on a hill, use the brakes to hold the vehicle in place.

Performance Shifting

If the vehicle has this feature, it can detect a change in driving patterns. If you make an aggressive driving maneuver, the vehicle's transmission automatically shifts to the lowest possible gear to maximize vehicle performance. The vehicle will automatically return to normal operation when you return to normal driving patterns.

Parking Brake

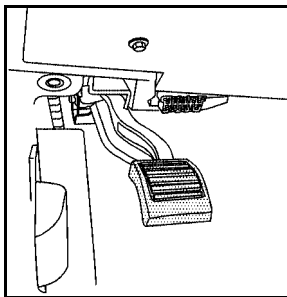

The parking brake pedal is located to the left of the regular brake pedal, near the driver door.

To set the parking brake, hold the regular brake pedal down, then push the parking brake pedal down.

If the ignition is on, the brake system warning light on the instrument panel cluster should come on. If it does not, you need to have the vehicle serviced.

A warning chime will sound if the parking brake is set, the ignition is on, and the vehicle speed is greater than 5 mph (8 km/h). The brake light will come on and stay on until the parking brake is released. See *Brake System Warning Light on page 4-51* for more information.

To release the parking brake, hold the regular brake pedal down, then push the parking brake pedal down. When you lift your foot off the parking brake pedal, the pedal will follow your foot to the released position.

Notice: Driving with the parking brake on can overheat the brake system and cause premature wear or damage to brake system parts. Make sure that the parking brake is fully released and the brake warning light is off before driving.

If you are towing a trailer and are parking on any hill, see *Towing a Trailer on page 5-26*.

Shifting Into Park

WARNING:

It can be dangerous to get out of the vehicle if the shift lever is not fully in P (Park) with the parking brake firmly set. The vehicle can roll. If you have left the engine running, the vehicle can move suddenly. You or others could be injured. To be sure the vehicle will not move, even when you are on fairly level ground, use the steps that follow. If you are pulling a trailer, see *Towing a Trailer on page 5-26*.

Steering Column Shift Lever

If the vehicle has a steering column shift lever, use this procedure to shift the vehicle into P (Park):

1. Hold the brake pedal down.
2. Move the shift lever into P (Park) by pulling the shift lever toward you and moving it up as far as it will go.

3. With your foot still holding the brake pedal down, set the parking brake. See *Parking Brake on page 3-30* for more information.
4. Turn the ignition key to LOCK/OFF.
5. Remove the key and take it with you. If you can leave the vehicle with the ignition key in your hand, the vehicle is in P (Park).

Console Shift Lever

If the vehicle is equipped with a console shift lever, use this procedure to shift the vehicle into P (Park):

1. Hold the brake pedal down.
2. Move the shift lever into P (Park) by pushing the lever all the way toward the front of the vehicle and then to the left.
3. While keeping the brake pedal applied, set the parking brake. See *Parking Brake on page 3-30* for more information.
4. Turn the ignition key to LOCK/OFF.
5. Remove the key and take it with you. If you can leave the vehicle with the ignition key in your hand, the vehicle is in P (Park).

Leaving the Vehicle With the Engine Running

WARNING:

It can be dangerous to leave the vehicle with the engine running. The vehicle could move suddenly if the shift lever is not fully in P (Park) with the parking brake firmly set. And, if you leave the vehicle with the engine running, it could overheat and even catch fire. You or others could be injured. Do not leave the vehicle with the engine running.

If you have to leave the vehicle with the engine running, be sure your vehicle is in P (Park) and the parking brake is firmly set before you leave it. See *Parking Brake on page 3-30* for more information.

Torque Lock

Torque lock is when the weight of the vehicle puts too much force on the parking pawl in the transmission. This happens when parking on a hill and shifting the transmission into P (Park) is not done properly and then it is difficult to shift out of P (Park).

To prevent torque lock, set the parking brake and then shift into P (Park). To find out how, see “Shifting Into Park” in this section.

If torque lock does occur, your vehicle may need to be pushed uphill by another vehicle to relieve the parking pawl pressure, so you can shift out of P (Park).

Shifting Out of Park

Automatic Transmission Shift Lock

This vehicle has an electronic shift lock release system. The shift lock release is designed to:

- Prevent ignition key removal unless the shift lever is in P (Park)
- Prevent movement of the shift lever out of P (Park), unless the ignition is in ON/RUN or ACC/ACCESSORY and the regular brake pedal is applied.

The shift lock is always functional except in the case of an uncharged or low voltage (less than 9 volt) battery.

If the vehicle has an uncharged battery or a battery with low voltage, try charging or jump starting the battery. See *Jump Starting on page 6-40*.

Console Shift

If the console shift cannot be moved out of P (Park)

1. Apply the regular brakes.
2. Turn the ignition to ON/RUN or ACC/ACCESSORY position. See *Ignition Positions on page 3-23* for more information.
3. Push the shift lever all the way into P (Park).
4. Then, shift into the desired gear.

If you still cannot move the shift lever from P (Park), consult your dealer or a professional towing service.

Column Shift

If the column shift cannot be moved out of P (Park)

1. Apply the regular brakes.
2. Turn the ignition key to the ON/RUN or ACC/ACCESSORY position. See *Ignition Positions on page 3-23* for more information.

3. Shift out of the P (Park) position to the N (Neutral) position.

4. Move the column shift to the desired gear.

If you still cannot move the shift lever from P (Park), consult your dealer or a professional towing service.

Parking Over Things That Burn

WARNING:

Things that can burn could touch hot exhaust parts under the vehicle and ignite. Do not park over papers, leaves, dry grass, or other things that can burn.

Engine Exhaust

WARNING:

Engine exhaust contains Carbon Monoxide (CO) which cannot be seen or smelled. Exposure to CO can cause unconsciousness and even death.

Exhaust may enter the vehicle if:

- The vehicle idles in areas with poor ventilation (parking garages, tunnels, deep snow that may block underbody airflow or tail pipes).
- The exhaust smells or sounds strange or different.
- The exhaust system leaks due to corrosion or damage.

(Continued)

WARNING: (Continued)

- The vehicle's exhaust system has been modified, damaged or improperly repaired.
- There are holes or openings in the vehicle body from damage or after-market modifications that are not completely sealed.

If unusual fumes are detected or if it is suspected that exhaust is coming into the vehicle:

- Drive it only with the windows completely down.
- Have the vehicle repaired immediately.

Never park the vehicle with the engine running in an enclosed area such as a garage or a building that has no fresh air ventilation.

Running the Vehicle While Parked

It is better not to park with the engine running. But if you ever have to, here are some things to know.

WARNING:

Idling a vehicle in an enclosed area with poor ventilation is dangerous. Engine exhaust may enter the vehicle. Engine exhaust contains Carbon Monoxide (CO) which cannot be seen or smelled. It can cause unconsciousness and even death. Never run the engine in an enclosed area that has no fresh air ventilation. For more information, see *Engine Exhaust on page 3-34*.

WARNING:

It can be dangerous to get out of the vehicle if the automatic transmission shift lever is not fully in P (Park) with the parking brake firmly set. The vehicle can roll. Do not leave the vehicle when the engine is running unless you have to. If you have left the engine running, the vehicle can move suddenly. You or others could be injured. To be sure the vehicle will not move, even when you are on fairly level ground, always set the parking brake after you move the shift lever to P (Park).

Follow the proper steps to be sure the vehicle will not move. See *Shifting Into Park on page 3-31*.

If parking on a hill and pulling a trailer, see *Towing a Trailer on page 5-26*.

Mirrors

Automatic Dimming Rearview Mirror

The vehicle has an automatic dimming inside rearview mirror with a compass display. Automatic dimming reduces the glare of lights from behind the vehicle. The dimming feature comes on and the indicator light illuminates each time the vehicle is started.

⏻ (On/Off): Press and hold ⏻ for about three seconds to turn the dimming feature and compass display on or off.

AUTO ☰D (Vehicles with Intellibeam™): Press and hold for approximately three seconds to turn the compass display on or off. See *Exterior Lamps on page 4-25* for more information.

Cleaning the Mirror

Do not spray glass cleaner directly on the mirror. Use a soft towel dampened with water.

Compass

Compass Operation

Press ⏻ or **AUTO ☰D**, depending on the vehicle, to turn the compass on or off.

When the ignition and the compass feature are on, after a few seconds, the mirror will display the compass heading. The compass automatically calibrates as the vehicle is driven.

Compass Calibration

If after a few seconds, the display does not show the correct direction, (for example, N for North), there may be a strong magnetic field interfering with the compass. Interference can be caused by a magnetic antenna mount, magnetic note pad holder or a similar magnetic item.

The compass can be placed in calibration mode manually by pressing and holding ⏻ or **AUTO ☰D**, depending on the vehicle, until a C is shown in the compass display.

The compass can be calibrated by driving the vehicle in circles at 5 mph (8 km/h) or less until the display reads a direction.



Compass Variance

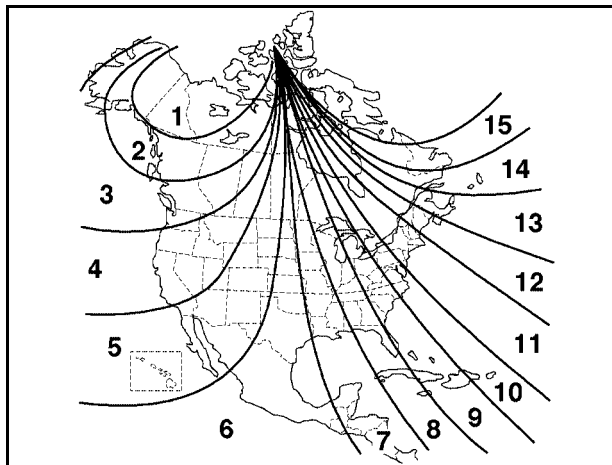

The compass is set to zone eight. If you do not live in zone eight or drive out of the area, the compass variance needs to be changed to the appropriate zone.

To adjust for compass variance:

1. Find the current location and variance zone number on the following zone map.



2. Press and hold  or **AUTO**  until a zone number displays.

3. Once the zone number displays, press  or **AUTO**  repeatedly until the correct zone number displays. Stop pressing the button and the mirror will return to normal operation. If C appears in the compass window, the compass may need calibration. See "Compass Calibration" listed previously.

Outside Power Foldaway Mirrors

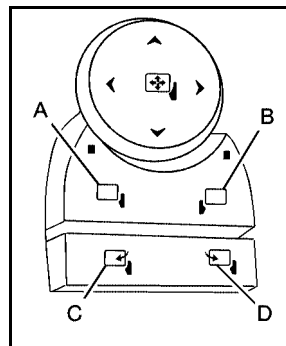

Controls for the outside power mirrors are located on the driver door armrest.

Press the selector switch (A) or (B) to choose either the left or right outside mirror. Then press the control pad to move the mirror to the desired direction.

Mirror Adjustment

1. Press (C) to unfold the mirrors out to the driving position.
2. Press (D) to fold the mirrors toward the vehicle.

Resetting the Power Foldaway Mirrors

Reset the power foldaway mirrors if:

- The mirrors are accidentally obstructed while folding.
- They are accidentally manually folded/unfolded.
- The mirrors do not stay in the unfolded position.
- The mirrors vibrate at normal driving speeds.

Fold and unfold the mirrors one time using the mirror controls to reset them to their normal position. A noise may be heard during the resetting of the power foldaway mirrors. This sound is normal after a manual folding operation.

Turn Signal Indicator (If Equipped)

The vehicle may have a turn signal indicator lamp that is built into the mirror. The turn signal lamp flashes with the use of the vehicle's turn signal and hazard flashers.

Outside Automatic Dimming Mirror

If the vehicle has this feature, the driver side mirror adjusts for the glare of headlamps behind you. This feature is controlled by the on and off settings on the automatic dimming rearview mirror.

Side Blind Zone Alert (SBZA)

If the vehicle has the Side Blind Zone Alert (SBZA) system, see *Side Blind Zone Alert (SBZA)* on *page 3-43* for more information.

Park Tilt Mirrors

If your vehicle is equipped with memory mirrors, it is capable of performing the park tilt mirror feature. This feature allows the driver and passenger side mirror to tilt to a factory programmed position when the vehicle is in R (Reverse). This feature may be useful in allowing you to view the curb when you are parallel parking.

When the vehicle is shifted out of R (Reverse) and either a five-second delay has occurred, or the ignition is turned to LOCK/OFF, the driver and passenger side mirror will return to its original position.

This feature can be enabled/disabled through the Driver Information Center (DIC). See *DIC Vehicle Customization on page 4-79* for more information.

Outside Convex Mirror

WARNING:

A convex mirror can make things, like other vehicles, look farther away than they really are. If you cut too sharply into the right lane, you could hit a vehicle on the right. Check the inside mirror or glance over your shoulder before changing lanes.

The passenger side mirror is convex shaped. A convex mirror's surface is curved so more can be seen from the driver seat.

Outside Heated Mirrors

 **(Rear Window Defogger):** Press to heat the mirrors. See "Rear Window Defogger" under *Dual Climate Control System on page 4-36* for more information.

Object Detection Systems

Ultrasonic Front and Rear Parking Assist (UFRPA)

For vehicles with the Ultrasonic Front and Rear Parking Assist (UFRPA) system, it operates at speeds less than 8 km/h (5mph), and assists the driver with parking and avoiding objects. It can determine how close objects are to the front bumper, up to 1.2 m (4 ft.) in front of the vehicle and the rear bumper, up to 2.5 m (8 ft.) behind the vehicle. The distance sensors are located on the front and rear bumper.

WARNING:

The Ultrasonic Front and Rear Park Assist (UFRPA) system does not replace driver vision. It cannot detect:

- objects that are below the bumper, underneath the vehicle, or if they are too close or far from the vehicle
- children, pedestrians, bicyclists, or pets.

If you do not use proper care before moving forward and while backing; vehicle damage, injury, or death could occur. Even with UFRPA, always check in front of the vehicle before moving forward and behind the vehicle before backing up. While moving forward and backing, be sure to look for objects and check the vehicle's mirrors.

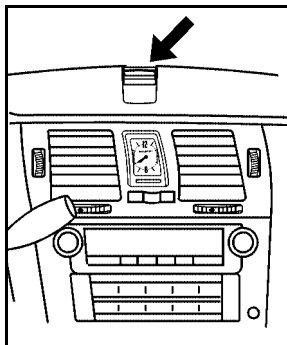

Front Parking Assist Display

The front display is located on top of the instrument panel to the right of the driver. The front display will have either three or six lights to provide distance and system information. With Adaptive Cruise control (ACC), it will have three lights along with the ACC lights. Without ACC, it will have six lights. High-toned beeps from the front speakers are for objects detected near the front bumper.

The rear display is located near the rear window and can be seen by looking over your right shoulder. The rear display uses three color-coded lights to provide distance and system information. Low-toned beeps from the rear speakers are for the rear bumper.

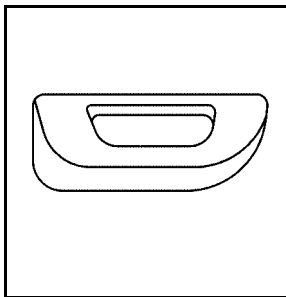

Rear Parking Assist Display

How the System Works

UFRPA comes on automatically when the shift lever is moved out of P (Park). The system does not work at a forward or reverse speed greater than 5 mph (8 km/h).

To be detected, objects must be at least 25.4 cm (10 in.) off the ground and below hood or trunk level. Objects must also be within 1.2 m (4 ft.) in front of the vehicle and 2.5 m (8 ft.) from the rear bumper. This distance may be less during warmer or humid weather.

When backing up, if objects are detected at the same time near both the front and rear bumpers, both color-coded light displays will notify you of objects close to each bumper. If there are objects detected near both bumpers, the beeps will only be sounded to notify that objects are close to the rear bumper. However, if while the vehicle is backing up and an object comes within 0.3 m (1 ft.) of the front bumper, and at the same time there is another object further than 0.3 m (1 ft.) from the rear bumper, then the beeps will only be sounded to notify you of the closer object that is near the front bumper.

The system can be disabled using the Driver Information Center (DIC). See "Parking Assist" under *DIC Operation and Displays* on page 4-61 for more information.

Moving Forward

When the vehicle is started, the front display will briefly illuminate to let you know the system is working.

The following describes what will occur with the front display as you get closer to a object detected in the front of the vehicle:

Description	Metric	English
amber/amber lights ACC — one amber light	1.2 m	4 ft
four amber lights ACC — two amber lights	1.0 m	40 in
four amber/ two red lights ACC — two amber lights/one red light	0.6 m	23 in
four amber/ two red lights flashing and beep for five seconds ACC — two amber lights/one red light flashing and beep for five seconds	0.3 m	1 ft

Backing

Ultrasonic Rear Parking Assist (URPA) comes on automatically when the shift lever is moved into R (Reverse). The rear display will then briefly illuminate to let you know the system is working.

The following describes what will occur with the rear display as you get closer to an object detected in the rear of your vehicle:

Description	Metric	English
amber light	2.5 m	8 ft.
amber/amber lights	1.0 m	40 in.
amber/amber/red lights and continuous beeping for five seconds	0.6 m	23 in.
amber/amber/red lights flashing and continuous beeping for five seconds	0.3 m	1 ft.

The system can be disabled through the Driver Information Center (DIC). See “Parking Assist” under *DIC Operation and Displays on page 4-61* for more information.

When the System Does Not Seem to Work Properly

If the URPA system will not activate due to a temporary condition, the message PARK ASSIST OFF will be displayed on the DIC and a red light will be shown on the rear URPA display when the shift lever is moved into R (Reverse). This occurs under the following conditions:

- The driver disables the system.
- The ultrasonic sensors are not clean. Keep the vehicle's rear bumper free of mud, dirt, snow, ice and slush. For cleaning instructions, see *Washing Your Vehicle on page 6-100*.
- A trailer was attached to the vehicle, or a bicycle or an object was hanging out of the trunk during the last drive cycle, the red light may illuminate in the rear display. Once the attached object is removed, URPA will return to normal operation.
- A tow bar is attached to the vehicle.
- The vehicle's bumper is damaged. Take the vehicle to your dealer to repair the system.
- Other conditions may affect system performance, such as vibrations from a jackhammer or the compression of air brakes on a very large truck.

If the system is still disabled after driving forward at least 25 km/h (15 mph), take the vehicle to your dealer.

Side Blind Zone Alert (SBZA)

The vehicle may have a Side Blind Zone Alert (SBZA) system. Read this entire section before using the system.

WARNING:

SBZA is only a lane changing aid and does not replace driver vision. SBZA does not detect:

- Vehicles outside the side blind zones which may be rapidly approaching.
- Pedestrians, bicyclists, or animals.

Failure to use proper care when changing lanes may result in damage to the vehicle, injury, or death. Always check the outside and rearview mirrors, glance over your shoulder, and use the turn signal before changing lanes.

When the system detects a vehicle in the side blind zone, amber SBZA displays will light up in the side mirrors. This indicates that it may be unsafe to change lanes. Before making a lane change, always check the

SBZA display, check the outside and rearview mirrors, look over your shoulder for vehicles and hazards, and use the turn signal.

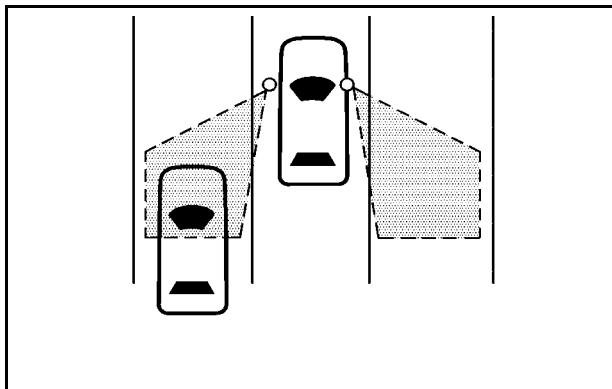

SBZA Detection Zones

The SBZA sensor covers a zone of approximately one lane over from both sides of the vehicle, 3.5 m (11 ft). This zone starts at each side mirror and goes back approximately 5 m (16 ft). The height of the zone is approximately between 0.5 m (1.5 ft) and 2.0 m (6 ft) off the ground.

The SBZA detection zones do not change if the vehicle is towing a trailer. So be extra careful when changing lanes while towing a trailer.

How the System Works

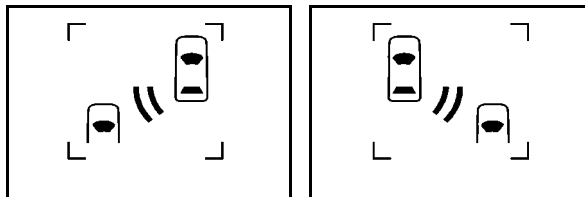

Left Side Mirror Display Right Side Mirror Display

When the vehicle is started, both outside mirror displays will briefly come on to indicate that the system is operating. While driving forward, the left or right side mirror SBZA display will light up if a vehicle is detected in that blind zone. If you activate a turn signal and a vehicle has been detected on the same side, the SBZA display will flash to give you extra warning not to change lanes.

SBZA displays do not come on while the vehicle is approaching or passing other vehicles. At speeds greater than 20 mph (32 km/h), SBZA displays may come on when a vehicle you have passed remains in or drops back into the detection zone.

SBZA can be disabled through the Driver Information Center (DIC). See *Driver Information Center (DIC)* on page 4-61 for more information. If the SBZA is disabled by the driver, the SBZA mirror displays will not light up during normal driving.

When the System Does Not Seem To Work Properly

Occasional missed alerts can occur under normal circumstances and will increase in wet conditions. The system does not need to be serviced due to an occasional missed alert. The number of missed alerts will increase with increased rainfall or road spray.

If the SBZA displays do not light up when the system is on and vehicles are in the blind zone, the system may need service. Take the vehicle to your dealer.

SBZA is designed to ignore stationary objects; however, the system may occasionally light up due to guard rails, signs, trees, shrubs, and other stationary objects. This is normal system operation, the vehicle does not need service.

SBZA does not operate when the left or right corners of the rear bumper are covered with mud, dirt, snow, ice, slush, or in heavy rainstorms. For cleaning instructions, see *Washing Your Vehicle* on page 6-100. If the DIC still displays the SIDE BLIND ZONE SYSTEM UNAVAILABLE message after cleaning the bumper, see your dealer.

The SBZA displays may remain on if a trailer is attached to the vehicle, or a bicycle or object is extending out to either side of the vehicle.

When SBZA is disabled for any reason other than the driver turning it off, the driver will not be able to turn SBZA back on using the DIC. The SIDE BLIND ZONE ALERT ON option will not be selectable if the conditions for normal system operation are not met. Until normal operating conditions for SBZA are met, you should not rely upon SBZA while driving.

SBZA Error Messages

The following messages may appear in the DIC:

SIDE BLIND ZONE ALERT SYSTEM OFF: This message indicates that the driver has turned the system off.

SIDE BLIND ZONE SYSTEM UNAVAILABLE: This message indicates that the SBZA system is disabled because the sensor is blocked and cannot detect vehicles in the blind zone. The sensor may be blocked by mud, dirt, snow, ice, slush, or even heavy rainstorms. This message may also activate during heavy rain or due to road spray. The vehicle does not need service. For cleaning, see *Washing Your Vehicle* on page 6-100.

SERVICE SIDE BLIND ZONE ALERT SYSTEM: If this message appears, both SBZA displays will remain on indicating there is a problem with the SBZA system. If these displays remain on after continued driving, the system needs service. Take the vehicle to your dealer.

FCC Information

See *Radio Frequency Statement on page 8-20* for FCC information.

Frequency of operation: 24.05GHz – 24.25GHz

Field Strength: Not greater than 2.5V/m peak (0.25V/m average) at a distance of 3 m.

The manufacturer is not responsible for any radio or TV interference caused by unauthorized modifications to this equipment. Such modifications could void the user's authority to operate the equipment.

Lane Departure Warning (LDW)

The vehicle may have a Lane Departure Warning (LDW) system. Read this entire section before using the system.

WARNING:

The Lane Departure Warning (LDW) system does not steer the vehicle and is only an aid to help you stay in your driving lane. The LDW system may not:

- Provide you with enough time to avoid a lane change collision.
- Be loud enough for you to hear the warning beeps.
- Work properly under bad weather conditions or if the windshield is not kept clean.
- Detect lane markings and will not detect road edges.
- Warn you that your vehicle is crossing a lane marking if the system does not detect the lane marking.

(Continued)

WARNING: (Continued)

LDW will indicate the system is working whenever it detects either the left or right lane marking. So if you depart on the side of the lane that LDW is not detecting, LDW will not warn you.

If you do not carefully maintain your vehicle position within the lane, vehicle damage, injury, or death could occur. Even with LDW, always keep your attention on the road and maintain proper vehicle position within the lane. Always keep the windshield clean and do not use LDW in bad weather conditions.

When the vehicle crosses a detected lane marking, the LDW symbol will flash and you will hear three beeps. LDW will not warn you if the turn signal is on or if you make a sharp maneuver. Before making a lane change, check the vehicle's mirrors, glance over your shoulder for vehicles and hazards, and start the turn signal before changing lanes.

How the System Works

LDW uses a camera located between the inside rearview mirror and the windshield to detect the lane markings.

 **(Lane Departure Warning):** To turn LDW on and off, press the LDW control, located by the exterior headlamp control. An indicator on the control will light to indicate that LDW is on.

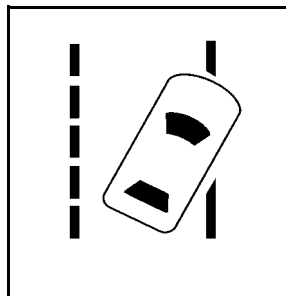

When the vehicle is started, the LDW symbol, located in the instrument panel cluster, will briefly come on to indicate that the light is operational.

LDW only operates at speeds of 35 mph (56 km) or greater. If LDW is turned on when traveling at these speeds, the LDW symbol will appear green if the system detects a left or right lane marking.

This symbol will change to amber and flash and three beeps will sound if you cross a detected lane marking without using the turn signal.

If the LDW symbol does not appear, LDW is not currently operating and will not warn you.

To change the volume of the warning chime, see Chime Volume under *DIC Vehicle Customization on page 4-79* for more information.

When the System Does Not Seem To Work Properly

The LDW symbol will not appear when the system is having difficulty seeing the lines on the road or if the view of the camera on the windshield is blocked with mud, dirt, snow, ice, or slush, if the windshield is damaged, or when weather limits visibility, such as while driving in fog, rain, or snow conditions. This is normal operation, the vehicle does not need service. For cleaning instructions, see *Washing Your Vehicle on page 6-100*.

LDW warnings may occasionally occur due to tar marks, shadows, cracks in the road, or other road imperfections. This is normal system operation, the vehicle does not need service.

LDW Error Message

SERVICE LANE DEPARTURE SYSTEM: This message may appear in the DIC to indicate that LDW is not working properly. If this message remains on after continued driving, the system needs service. Take your vehicle to your dealer.

LANE DEPARTURE SYSTEM UNAVAILABLE : This message may appear in the DIC if LDW does not activate due to a temporary condition.

Universal Home Remote System

See *Radio Frequency Statement on page 8-20* for information regarding Part 15 of the Federal Communications Commission (FCC) Rules and RSS-210/211 of Industry Canada.

Universal Home Remote System Operation (With Three Round LED)

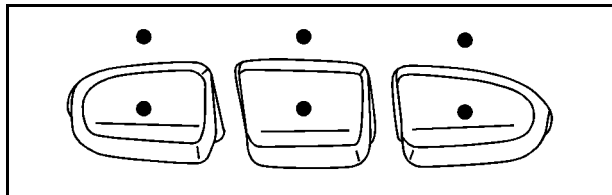

This vehicle may have the Universal Home Remote System. If there are three round Light Emitting Diode (LED) indicator lights above the Universal Home Remote buttons, follow the instructions below.

This system provides a way to replace up to three remote control transmitters used to activate devices such as garage door openers, security systems, and home automation devices.

Do not use this system with any garage door opener that does not have the stop and reverse feature. This includes any garage door opener model manufactured before April 1, 1982.

Read the instructions completely before attempting to program the transmitter. Because of the steps involved, it may be helpful to have another person assist with programming the transmitter.

Be sure to keep the original remote control transmitter for use in other vehicles, as well as, for future programming. Only the original remote control transmitter is needed for Fixed Code programming. The programmed buttons should be erased when the vehicle is sold or the lease ends. See "Erasing Universal Home Remote Buttons" later in this section.

Park the vehicle outside of the garage when programming a garage door. Be sure that people and objects are clear of the garage door or gate that is being programmed.

Programming Universal Home Remote — Rolling Code

For questions or help programming the Universal Home Remote System, call 1-866-572-2728 or go to learcar2u.com.

Most garage door openers sold after 1996 are Rolling Code units.

Programming a garage door opener involves time-sensitive actions, so read the entire procedure before starting. Otherwise, the device will time out and the procedure will have to be repeated.

To program up to three devices:

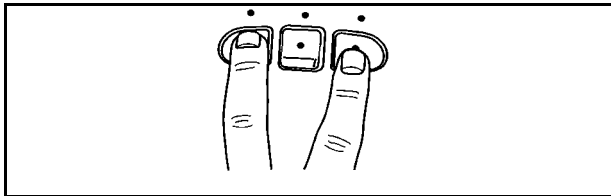

1. From inside the vehicle, press the two outside buttons at the same time for one to two seconds, and immediately release them.

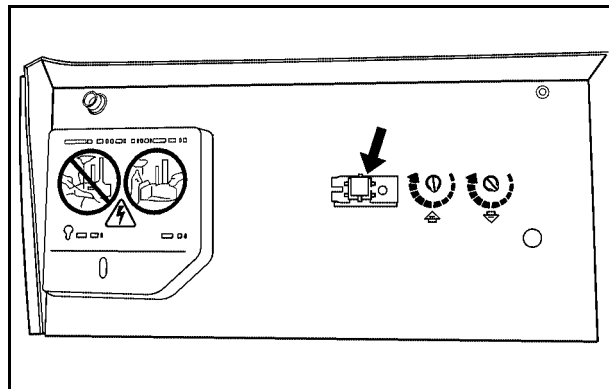

2. Locate in the garage, the garage door opener receiver (motor-head unit). Locate the “Learn” or “Smart” button. It can usually be found where the hanging antenna wire is attached to the motor-head unit and may be a colored button. Press this button. After pressing this button, complete the following steps in less than 30 seconds.

3. Immediately return to the vehicle. Press and hold the Universal Home Remote button that will be used to control the garage door until the garage door moves. The indicator light, above the selected button, should slowly blink. This button may need to be held for up to 20 seconds.
4. Immediately, within one second, release the button when the garage door moves. The indicator light will blink rapidly until programming is complete.
5. Press and release the same button again. The garage door should move, confirming that programming is successful and complete.

To program another Rolling Code device such as an additional garage door opener, a security device, or home automation device, repeat Steps 1 through 5, choosing a different function button in Step 3 than what was used for the garage door opener.

If these instructions do not work, the garage door opener is probably a Fixed Code unit. Follow the Programming instructions that follow for a Fixed Code garage door opener.

Programming Universal Home Remote — Fixed Code

For questions or help programming the Universal Home Remote System, call 1-866-572-2728 or go to learcar2u.com.

Most garage door openers sold before 1996 are Fixed Code units.

Programming a garage door opener involves time-sensitive actions, so read the entire procedure before starting. Otherwise, the device will time out and the procedure will have to be repeated.

To program up to three devices:

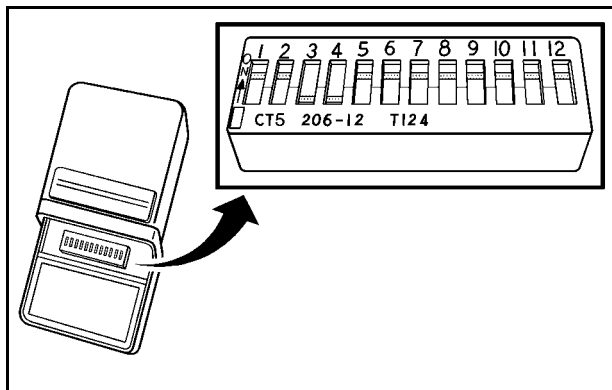

1. To verify that the garage door opener is a Fixed Code unit, remove the battery cover on the hand held transmitter supplied by the manufacturer of the garage door opener motor. If there are a row of dip switches similar to the graphic above, the garage door opener is a Fixed Code unit. If you do not see a row of dip switches, return to the previous section for Programming Universal Home Remote – Rolling Code.

Your hand held transmitter can have between eight to 12 dip switches depending on the brand of transmitter.

The garage door opener receiver (motor head unit) could also have a row of dip switches that can be used when programming the Universal Home Remote. If the total number of switches on the motor head and hand held transmitter are different, or if the dip switch settings are different, use the dip switch settings on the motor head unit to program the Universal Home Remote. The motor head dip switch settings can also be used when the original hand held transmitter is not available.

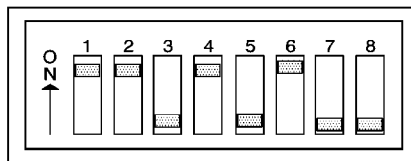

Switch Number	1	2	3	4	5	6	7	8
Switch Position	On	On	Off	On	Off	On	Off	Off
Your Universal Home Remote Button	Left	Left	Right	Left	Right	Left	Right	Right

Example of Eight Dip Switches with Two Positions

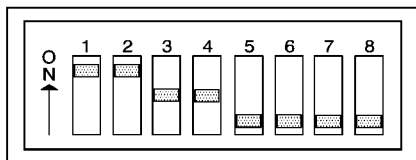

Switch Number	1	2	3	4	5	6	7	8
Switch Position	On	On	Neutral	Neutral	Off	Off	Off	Off
Your Universal Home Remote Button	Left	Left	Middle	Middle	Right	Right	Right	Right

Example of Eight Dip Switches with Three Positions

The panel of switches might not appear exactly as they do in the examples above, but they should be similar.

The switch positions on the hand-held transmitter could be labeled, as follows:

- A switch in the up position could be labeled as “Up,” “+,” or “On.”
- A switch in the down position could be labeled as “Down,” “-,” or “Off.”
- A switch in the middle position could be labeled as “Middle,” “0,” or “Neutral.”

2. Write down the eight to 12 switch settings from left to right as follows:

- When a switch is in the up position, write “Left.”
- When a switch is in the down position, write “Right.”
- If a switch is set between the up and down position, write “Middle.”

The switch settings written down in Step 2 now become the button strokes to be entered into the Universal Home Remote in Step 4. Be sure to enter the switch settings written down in Step 2, in order from left to right, into the Universal Home Remote, when completing Step 4.

3. From inside your vehicle, first firmly press all three buttons at the same time for about three seconds. Release the buttons to put the Universal Home Remote into programming mode.

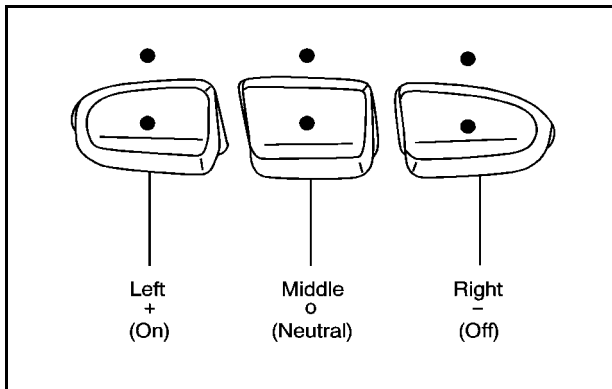

4. The indicator lights will blink slowly. Enter each switch setting from Step 2 into your vehicle's Universal Home Remote. You will have two and one-half minutes to complete Step 4. Now press one button on the Universal Home Remote for each switch setting as follows:
- If you wrote "Left," press the left button in the vehicle.
 - If you wrote "Right," press the right button in the vehicle.
 - If you wrote "Middle," press the middle button in the vehicle.

5. After entering all of the switch positions, again, firmly press and release all three buttons at the same time. The indicator lights will turn on.
6. Press and hold the button that will be used to control the garage door until the garage door moves. The indicator light above the selected button should slowly blink. This button may need to be held for up to 55 seconds.
7. Immediately release the button when the garage door moves. The indicator light will blink rapidly until programming is complete.
8. Press and release the same button again. The garage door should move, confirming that programming is successful and complete.

To program another Fixed Code device such as an additional garage door opener, a security device, or home automation device, repeat Steps 1-8, choosing a different button in Step 6 than what was used for the garage door opener.

Using Universal Home Remote

Press and hold the appropriate button for at least half of a second. The indicator light will come on while the signal is being transmitted.

Reprogramming Universal Home Remote Buttons

Any of the three buttons can be reprogrammed by repeating the instructions.

Erasing Universal Home Remote Buttons

The programmed buttons should be erased when the vehicle is sold or the lease ends.

To erase either Rolling Code or Fixed Code on the Universal Home Remote device:

1. Press and hold the two outside buttons at the same time for approximately 20 seconds, until the indicator lights, located directly above the buttons, begin to blink rapidly.
2. Once the indicator lights begin to blink, release both buttons. The codes from all buttons will be erased.

For help or information on the Universal Home Remote System, call the customer assistance phone number under *Customer Assistance Offices on page 8-6*.

Storage Areas

Glove Box

Lift up the glove box handle to open it. Use the key to lock and unlock the glove box.

Cupholders

There are cupholders located in the full floor console, or in the front of the center seat console. Cupholders are also located in the rear armrest. Slide the cover back to access the full floor console cupholder. Fold open the front of the console to access the center seat console cupholder.

Front Storage Area

To access the front storage area, push down and then release. Push up and forward to remove.

Center Console Storage

If the vehicle has a full floor console it has two storage areas. Lift the left lever located in the front of the armrest lid to access the upper storage tray. Lift the right lever to access the lower storage area. If the vehicle has a center seat console it will have two storage areas. Press the button located on the front of the armrest and lift the armrest cover to access the upper storage area. Pull the strap located behind the cup holder to access the lower storage area.

Center Flex Storage Unit

This vehicle may have a center flex storage unit that includes a front center seat with a lap belt and an underseat storage compartment. The center seatback can also be used as an armrest. Cupholders are also located at the front edge of the storage unit and can be accessed by folding the compartment forward.

Pull the handle rearward to open a storage compartment and access the accessory power outlet. Pull out to remove.

When not being used, the center seat lap belt can be stored in the underseat storage compartment.

Floor Mats

The driver's side floor mat is held in place by two hooks.

Remove the floor mat by pulling up on the rear of the mat to disconnect it from the hooks.

Reinstall the floor mat by lining up the openings in the floor mat over the hooks and push it down into place.

Properly place the driver's side floor mat on the floor so that it does not block the movement of the accelerator pedal.

Rear Seat Armrest

This vehicle has a rear seat armrest with cupholders. Pull the tab on the armrest forward, to access it.

Convenience Net

Use the convenience net, located in the rear, to store small loads as far forward as possible. The net should not be used to store heavy loads.

Sunroof

The vehicle may have a power sunroof.

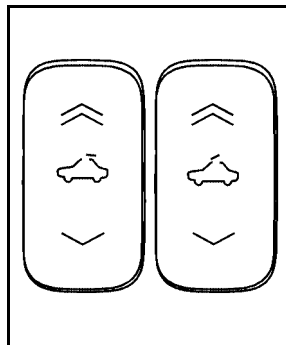

The switches that operate the sunroof are located on the overhead console.

To open or close the sunroof, the ignition must be turned to ON/RUN or Retained Accessory Power (RAP) must be active. See *Retained Accessory Power (RAP)* on page 3-24.

Express Open: The express open feature will operate from the closed or partially open position. To express open the power sunroof, fully press the driver side switch rearward once. To stop the sunroof glass in a desired position other than to the express-open position, press the switch again, in either direction, to stop the movement. If the sunshade is in the closed position, it will open with the sunroof, or it can be opened manually.

Vent Open: From the closed position, press and hold the passenger side switch forward to vent the sunroof. The rear of the sunroof panel will tilt upward to the full vent position. The sunshade must be opened manually.

Close: To close the sunroof, operate the controls according to one of the following:

- From the open position, press and hold the driver side sunroof switch forward. The sunshade must be closed manually.
- From the vent position, press and hold the passenger side sunroof switch rearward.

Dirt and debris may collect on the sunroof seal or in the tracks that could cause an issue with sunroof operation, noise or plug the water drainage system. Periodically open the sunroof and remove any obstacles or loose debris. Wipe the sunroof seal and roof sealing area using a clean cloth, mild soap, and water. Do not remove grease from sunroof.

Section 4 Instrument Panel

Instrument Panel Overview	4-3	Parade Dimming	4-31
Hazard Warning Flashers	4-3	Reading Lamps	4-31
Horn	4-3	Footwell Lamps	4-32
Tilt Wheel	4-3	Battery Load Management	4-32
Power Tilt Wheel and Telescopic Steering		Electric Power Management	4-32
Column	4-4	Inadvertent Power Battery Saver	4-33
Heated Steering Wheel	4-4	Battery Run-Down Protection	4-33
Turn Signal/Multifunction Lever	4-5	Accessory Power Outlet(s)	4-34
Turn and Lane-Change Signals	4-5	Ashtray(s)	4-35
Headlamp High/Low-Beam Changer	4-6	Analog Clock	4-35
Forward Collision Alert (FCA) System	4-6	Climate Controls	4-36
Flash-to-Pass	4-10	Dual Climate Control System	4-36
Windshield Wipers	4-10	Outlet Adjustment	4-41
Windshield Washer	4-11	Rear Climate Control System	4-42
Cruise Control	4-11	Passenger Compartment Air Filter	4-43
Adaptive Cruise Control	4-14	Warning Lights, Gauges, and Indicators	4-45
Exterior Lamps	4-25	Instrument Panel Cluster	4-46
Wiper Activated Headlamps	4-28	Speedometer and Odometer	4-47
Headlamps on Reminder	4-28	Tachometer	4-47
Daytime Running Lamps (DRL)	4-29	Safety Belt Reminders	4-48
Fog Lamps	4-30	Airbag Readiness Light	4-48
Cornering Lamps	4-30	Passenger Airbag Status Indicator	4-49
Exterior Lighting Battery Saver	4-30	Charging System Light	4-50
Instrument Panel Brightness	4-30	Brake System Warning Light	4-51
Courtesy Lamps	4-31	Antilock Brake System (ABS) Warning Light	4-52
Entry Lighting	4-31		

Section 4 Instrument Panel

Traction Control System (TCS) Warning Light	4-52	Driver Information Center (DIC)	4-61
StabiliTrak® Indicator Light	4-53	DIC Operation and Displays	4-61
Lane Departure Warning (LDW) Light	4-53	DIC Warnings and Messages	4-66
Engine Coolant Temperature Warning Light	4-54	DIC Vehicle Customization	4-79
Engine Coolant Temperature Gauge	4-54	Audio System(s)	4-88
Tire Pressure Light	4-55	Setting the Clock	4-89
Malfunction Indicator Lamp	4-55	Radio(s) (MP3)	4-93
Oil Pressure Light	4-58	Using an MP3	4-103
Security Light	4-59	XM Radio Messages	4-108
Fog Lamp Light	4-59	Navigation/Radio System	4-110
Lights On Reminder	4-59	Bluetooth®	4-110
Cruise Control Light	4-59	Theft-Deterrent Feature	4-120
Highbeam On Light	4-60	Audio Steering Wheel Controls	4-120
Fuel Gauge	4-60	Radio Reception	4-121
		Backglass Antenna	4-122
		XM™ Satellite Radio Antenna System	4-122

Instrument Panel Overview

Hazard Warning Flashers

 (**Hazard Warning Flasher**): Press this button located on the instrument panel, to make the front and rear turn signal lamps flash on and off. This warns others that you are having trouble.

Press  again to turn the flashers off.

Horn

Press near or on the horn symbols on the steering wheel pad to sound the horn.

Tilt Wheel

This feature allows the position of the steering wheel to be adjusted.

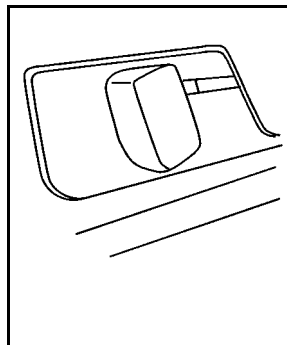

The adjustment lever is located on the left side of the steering column.

1. Pull the lever to move the steering wheel up or down.
 2. Release the lever to lock the wheel in place.
- Do not adjust the steering wheel while driving.

Power Tilt Wheel and Telescopic Steering Column

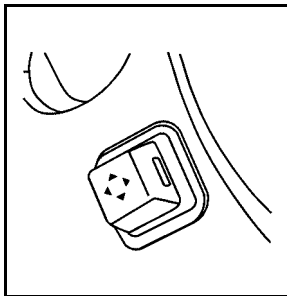

If the vehicle has this feature, the power tilt and telescope wheel control is located on the outboard side of the steering column.

Press the control up or down to tilt the steering wheel up or down.

Press the control forward or rearward and the steering wheel moves toward the front or rear of the vehicle.

To set the memory position, see *DIC Vehicle Customization* on page 4-79 and *Memory Seat, Mirrors and Steering Wheel* on page 2-6.

Heated Steering Wheel

The vehicle may have a heated steering wheel.

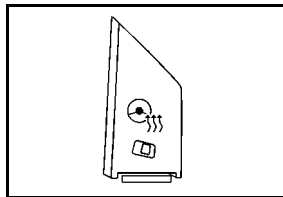

The button for this feature is located on the steering wheel.

Press to turn the heated steering wheel on or off. A light on the button displays while the feature is turned on.

Heating will begin in about three minutes.

Turn Signal/Multifunction Lever

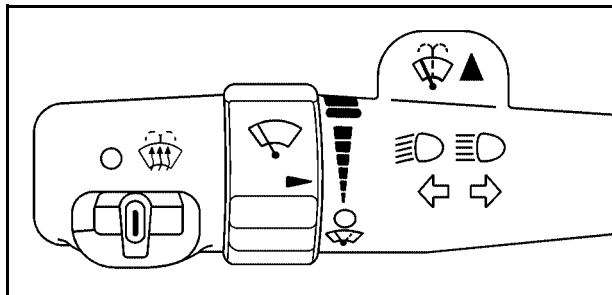

The lever on the left side of the steering column includes the following:

↔ : Turn and Lane-Change Signals

☰☷ : Headlamp High/Low-Beam Changer

☂ : Windshield Wipers

☂ : Windshield Washer

Flash-To-Pass Feature.

Information for these features is on the pages following.

Turn and Lane-Change Signals

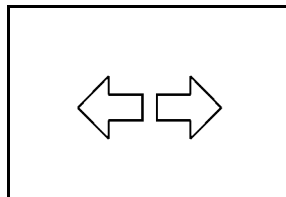

An arrow on the instrument panel cluster flashes in the direction of the turn or lane change.

For vehicles with the side blind zone alert system, an arrow in the outside mirror flashes when the turn signal is used. See *Side Blind Zone Alert (SBZA)* on page 3-43 for more information.

Move the lever all the way up or down to signal a turn.

Raise or lower the lever until the arrow starts to flash to signal a lane change. Hold it there until the lane change is complete. If the lever is briefly pressed and released, the turn signal will flash three times.

The lever returns to its starting position when it is released.

If after signaling a turn or lane change the arrow flashes rapidly or does not come on, a signal bulb may be burned out.

Have the bulbs replaced. If the bulb is not burned out, check the fuse. See *Fuses and Circuit Breakers* on page 6-106.

Turn Signal On Chime

If the turn signal is left on, a warning chime sounds and the Driver Information Center (DIC) will display TURN SIGNAL ON after driving about a mile as a reminder to turn it off. See *DIC Warnings and Messages on page 4-66*.

Headlamp High/Low-Beam Changer

Push forward to change the headlamps from low beam to high. Pull the lever back and then release it to change from high beam to low.

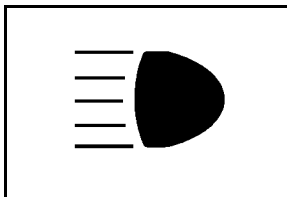

This light on the instrument panel cluster will be on, indicating high-beam usage.

Forward Collision Alert (FCA) System

If your vehicle has this feature, be sure to read this entire section before using it.

The system operates on a radio frequency subject to Federal Communications Commission (FCC) Rules and with Industry Canada.

This device complies with Part 15 of the FCC Rules. Operation is subject to the following two conditions:

1. This device may not cause interference.
2. This device must accept any interference received, including interference that may cause undesired operation of the device.

This device complies with RSS-210 of Industry Canada. Operation is subject to the following two conditions:

1. This device may not cause interference.
2. This device must accept any interference received, including interference that may cause undesired operation of the device.

Changes or modifications to this system by other than an authorized service facility could void authorization to use this equipment.

The Forward Collision Alert (FCA) system provides an audible and visual alert if you approach a vehicle too quickly that is directly ahead. FCA also provides a visual alert with no audible alert if you are following another vehicle much too closely. The FCA alert symbol is located on top of the instrument panel to the right of the driver. FCA uses the Adaptive Cruise Control radar to detect a vehicle directly ahead, in your path, within a distance of 328 ft (100 m) and operates at speeds above 20 mph (32 km/h).

⚠ WARNING:

FCA is only a warning system and does not apply the brakes. When you are approaching a vehicle or object too rapidly or when you are following a vehicle too closely that is ahead of you, FCA may
(Continued)

WARNING: (Continued)

not provide you with enough time to avoid a collision. FCA is not designed to warn the driver of pedestrians or animals. Your complete attention is always required while driving and you should be ready to take action and apply the brakes. For more information, see *Defensive Driving on page 5-2*.

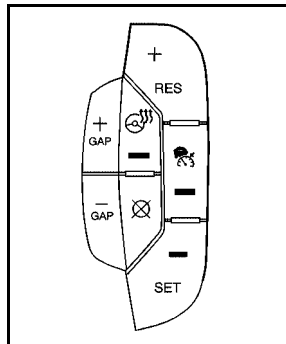

The FCA control is located on the steering wheel.

To enable or disable FCA, press the Adaptive Cruise Control button. See *Adaptive Cruise Control* on page 4-14.

FCA is enabled when the green light on the button is lit. FCA is disabled when the indicator light is amber.

WARNING:

- On winding roads, FCA may not detect a vehicle ahead. You could crash into a vehicle ahead of you. Do not rely on FCA on winding roads.
- When weather limits visibility, such as in fog, rain, or snow, FCA performance is limited. There may not be enough warning distance to the vehicle in front of you. Do not rely on FCA in low visibility conditions.

WARNING:

When FCA is enabled, the Adaptive Cruise Control switch is on. If you press another Adaptive Cruise Control button, you might go into cruise when you do not want to. You could be startled and even lose control. Be careful not to press adaptive cruise buttons unless you want to use cruise control.

Alerting the Driver



The FCA alert symbol will flash and a warning beep will sound when driver action may be required.

The alert symbol will flash when:

- Your vehicle is approaching another vehicle too quickly.
- Your vehicle is following a vehicle ahead of you much too closely.

See *Defensive Driving on page 5-2* for more information.

Detecting the Vehicle Ahead

The vehicle ahead symbol, located next to the FCA symbol, will only appear when a vehicle ahead of you is detected in your path. If this symbol does not appear, or disappears briefly, FCA will not respond to vehicles you may see ahead. The symbol may disappear on curves, highway exit ramps, or hills. Also, when another vehicle enters the same lane as you, the FCA system will not detect the vehicle until it is completely in your driving lane.

WARNING:

When the Adaptive Cruise Control radar is blocked by snow, ice, or dirt, it may not detect a vehicle ahead. FCA may not help you avoid a collision under these conditions. Do not use FCA
(Continued)

WARNING: (Continued)

when the radar is blocked by snow, ice, or dirt. Keep your radar clean. See "Cleaning the System" under *Adaptive Cruise Control on page 4-14*.

WARNING:

FCA may not detect and warn soon enough to stationary or slow-moving vehicles or other objects ahead of you. You could crash into an object ahead of you. Do not rely on FCA when approaching stationary or slow-moving vehicles or other objects.

Unnecessary Alerts

FCA may occasionally provide alerts that you consider unnecessary. It could respond to a turning vehicle ahead of you, guard rails, signs, and other stationary objects. This is normal operation, your vehicle does not need service.

Other Messages

There are three messages that may appear on the Driver Information Center (DIC). They are CLEAN RADAR, RADAR CRUISE NOT READY and SERVICE RADAR CRUISE. See *DIC Warnings and Messages on page 4-66*.

Cleaning the System

The radar can become blocked by snow, ice, or dirt. If so, you may need to turn off the engine and clean the lens. See "Cleaning the System" under *Adaptive Cruise Control on page 4-14*.

Flash-to-Pass

This feature lets you use the high-beam headlamps to signal the driver in front of you that you want to pass.

The flash-to-pass feature will only work with the headlamps on. It does not work with Daytime Running Lamps (DRL).

Pull and hold the turn signal lever toward you to use.

If the headlamps are on low beam, pulling the turn signal towards you will flash the high beams.

Windshield Wipers

The windshield wiper lever is located on the left side of the steering column.

Turn the band with the wiper symbol on it to control the windshield wipers.

 **(Mist):** For a single wiping cycle, hold it on mist until the wipers start, then release. The wipers stop after one wipe. Several wipes, hold the band longer.

 **(Delay):** Use to set the delay time between wipe cycles. The wiper speed can be set for a long or short delay between wipes. The closer the band is set to the top of the lever, the shorter the delay.

 **(Low Speed):** Slow wipes.

 **(High Speed):** Fast wipes.

 **(Off):** Turns the wipers off.

Clear ice and snow from the wiper blades before using them. If frozen to the windshield, carefully loosen or thaw them. Damaged blades should be replaced.

Heavy snow or ice can overload the wiper motor. A circuit breaker will stop the motor until it cools.

The vehicle has wiper-activated headlamps. After the windshield wipers have completed eight wipe cycles within four minutes, the headlamps automatically turn on. See *Wiper Activated Headlamps on page 4-28* for more information.

Windshield Washer

WARNING:

In freezing weather, do not use your washer until the windshield is warmed. Otherwise the washer fluid can form ice on the windshield, blocking your vision.

 **(Washer Fluid):** Press and release this paddle, located at the top of the turn signal/multifunction lever, to spray washer fluid on the windshield. The wipers will clear the windshield and either stop or return to the preset speed. For more washer cycles, press and hold the paddle.

Cruise Control

With cruise control, a speed of approximately 40 km/h (25 mph) or more can be maintained without keeping your foot on the accelerator. Cruise control does not work at speeds below about 40 km/h (25 mph). A cruise control light appears in the instrument panel cluster when the cruise control is on.

When the brakes are applied, the cruise control shuts off.

WARNING:

Cruise control can be dangerous where you cannot drive safely at a steady speed. So, do not use the cruise control on winding roads or in heavy traffic.

Cruise control can be dangerous on slippery roads. On such roads, fast changes in tire traction can cause excessive wheel slip, and you could lose control. Do not use cruise control on slippery roads.

If your vehicle is in cruise control when the Traction Control System (TCS) begins to limit wheel spin, the cruise control automatically turns off. See *Traction Control System (TCS)* on page 5-6. When road conditions let you safely use it again, the cruise control can be turned back on.

Setting Cruise Control

WARNING:

If you leave your cruise control on when you are not using cruise, you might hit a button and go into cruise when you do not want to. You could be startled and even lose control. Keep the cruise control switch off until you want to use cruise control.

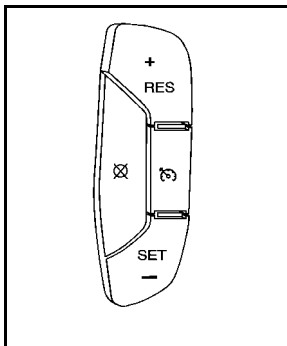

The cruise control buttons are located on left side of the steering wheel.

 **(On):** Turns on the cruise control system.

+ RES (Resume/Accelerate): Press to make the vehicle accelerate or resume to a previously set speed.

SET- (Set): Press to set the speed.

 **(Cancel):** Press to cancel cruise control.

Cruise control will not work if the parking brake is set, or if the master cylinder brake fluid level is low.

If the brakes are applied, the cruise control shuts off.

The cruise light on the instrument panel cluster comes on after the cruise control has been set to the desired speed.

1. Press .
2. Get up to the desired speed.
3. Press the SET- button located on the steering wheel and release it.
4. Take your foot off the accelerator.

Resuming a Set Speed

Suppose the cruise control is set at a desired speed and then the brakes are applied. This shuts off the cruise control. But it does not need to be reset.

Once the vehicle is traveling approximately 40 km/h (25 mph) or more, press the +RES (resume/accelerate) button to return to the desired preset speed. The cruise light displays again.

The vehicle returns to and stays at the preset speed. If you press and hold the +RES button, the vehicle speed increases until the button is released or the brake is applied. Do not hold in the +RES button, if you do not want the vehicle speed to increase.

Increasing Speed While Using Cruise Control

There are two ways to go to a higher speed:

- Use the accelerator pedal to get to the higher speed. Press the SET– button, then release the button and the accelerator pedal. The vehicle now cruises at the higher speed.
- Press the +RES button. Hold it there until the desired speed is reached, and then release the button. To increase the vehicle speed in very small amounts, briefly press the +RES button and then release it. Each time this is done, the vehicle accelerates approximately 1.6 km/h (1 mph).

The accelerate feature only works after the cruise control speed is set by pressing the SET– button.

Reducing Speed While Using Cruise Control

There are two ways to reduce the vehicle speed while using cruise control:

- Press the SET– button until the lower speed desired is reached, then release it.
- To slow down in very small amounts, push the SET– button briefly. Each time this is done, the vehicle slows down approximately 1.6 km/h (1 mph).

Passing Another Vehicle While Using Cruise Control

Use the accelerator pedal to increase the vehicle speed. When you take your foot off the pedal, the vehicle slows down to the previous cruise control speed.

Using Cruise Control on Hills

How well your cruise control works on hills depends upon the vehicle speed, load, and the steepness of the hills. When going up steep hills, you might have to step on the accelerator pedal to maintain the vehicle's speed. When going downhill, you might have to brake or shift to a lower gear to keep the vehicle's speed down. Applying the brake or shifting into a lower gear ends cruise control. If you need to apply the brake or

shift to a lower gear due to the grade of the downhill slope, you might not want to attempt to use the cruise control feature.

Ending Cruise Control

To turn off the cruise control, step lightly on the brake pedal, or press the cancel button on the steering wheel.

Erasing Speed Memory

The cruise control set speed memory is erased when the cruise control or the ignition is turned off.

Adaptive Cruise Control

For vehicles with this feature, be sure to read this entire section before using it.

The system operates on a radio frequency subject to Federal Communications Commission (FCC) Rules and with Industry Canada.

This device complies with Part 15 of the FCC Rules. Operation is subject to the following two conditions:

1. This device may not cause interference.
2. This device must accept any interference received, including interference that may cause undesired operation of the device.

This device complies with RSS-210 of Industry Canada. Operation is subject to the following two conditions:

1. This device may not cause interference.
2. This device must accept any interference received, including interference that may cause undesired operation of the device.

Changes or modifications to this system by other than an authorized service facility could void authorization to use this equipment.

Adaptive Cruise Control (ACC) is an enhancement to traditional cruise control. It allows you to keep cruise control engaged in moderate traffic conditions without having to constantly reset your cruise control. ACC uses radar to detect a vehicle directly ahead in your path, within a distance of 100 m (330 ft), and operates at speeds above 40 km/h (25 mph). When it is engaged by the driver, the system can apply limited braking or acceleration of the vehicle automatically to maintain a selected follow distance to the vehicle ahead. Braking is limited to 2.45 m/sec² (0.25 g's) of deceleration, which is comparable to moderate application of the vehicle's brakes. To disengage ACC, apply the brake. If no vehicle is in your path, the vehicle will react like traditional cruise control.

 **WARNING:**

Adaptive Cruise Control will not apply hard braking or bring the vehicle to a complete stop. It will not respond to stopped vehicles, pedestrians or animals. When you are approaching a vehicle or object, Adaptive Cruise Control may not have time to slow your vehicle enough to avoid a collision. Your complete attention is always required while driving and you should be ready to take action and apply the brakes. For more information, see *Defensive Driving on page 5-2*.

 **WARNING:**

- On winding roads, Adaptive Cruise Control may not detect a vehicle ahead. You could crash into a vehicle ahead of you. Do not use Adaptive Cruise Control on winding roads.

(Continued)

WARNING: (Continued)

- Adaptive Cruise Control may not have time to slow your vehicle enough to avoid a crash when you are driving in conditions where vehicles may suddenly slow or stop ahead of you, enter your lane, or cross your vehicle's path. If you are driving in these conditions, do not use Adaptive Cruise Control. The warning beep and alert symbol may indicate that you are driving in conditions where Adaptive Cruise Control should not be used. See "Alerting the Driver" in this section.
- On slippery roads, fast changes in tire traction can cause needless wheel spinning, and you could lose control. Do not use cruise control on slippery roads.
- When weather limits visibility, such as when in fog, rain, or snow conditions, Adaptive Cruise Control performance is limited. There may not be enough distance to adapt to the changing traffic conditions. Do not use cruise control when visibility is low.

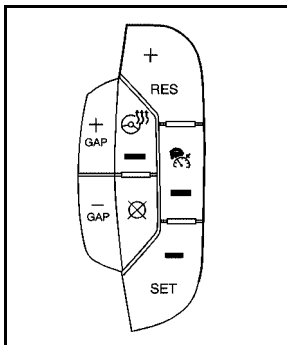

The ACCs are located on the steering wheel.

The cruise control buttons are located on left side of the steering wheel.

 **(On):** Press to turn the system on.

+ Res (Resume/Accelerate): Press to make the vehicle resume to a previously set speed or to increase the set speed when ACC is already active.

Set- : Press to set the speed or to decrease the set speed when ACC is already active.

 **(Cancel):** Press to cancel ACC.

+GAP (Increase Following Distance): Press to increase the distance between your vehicle and other vehicles.

-GAP (Decrease Following Distance): Press to decrease the distance between your vehicle and other vehicles.

ACC will not work if the master cylinder brake fluid level is low.

Engaging ACC With the Set Button

WARNING:

If you leave your Adaptive Cruise Control switch on when you are not using cruise, you might hit a button and go into cruise when you do not want to. You could be startled and even lose control. Keep the Adaptive Cruise Control switch off until you want to use cruise control.

The set speed is selected by the driver. This is the speed your vehicle will travel if there is no vehicle detected in its path.

To set ACC, do the following:

1. Press the  button.
2. Get up to the speed desired.
3. Press in the SET- button and release it.
4. Take your foot off the accelerator pedal.

Once ACC is set, it may immediately apply the brakes if it detects a vehicle ahead is too close or moving slower than your vehicle.

The on symbol is located on the display at the top of the instrument panel to the right of the driver. When the on symbol is lit on the display, it indicates that ACC is active.

A message on the DIC will also display when ACC is set. See *DIC Warnings and Messages on page 4-66*.

Keep in mind speed limits, surrounding traffic speeds, and weather conditions when adjusting your set speed.

If the vehicle is in ACC when the traction control system begins to limit wheel spin, the ACC will automatically disengage. See *Traction Control System (TCS) on page 5-6* and *StabiliTrak® System on page 5-5*. When road conditions allow you to safely use it again, the ACC can be turned back on.

Increasing Set Speed While Using ACC

There are two ways to increase the set speed:

- Use the accelerator to get to the higher speed. Press the SET- button and then release the button and the accelerator pedal. The vehicle will now cruise at the higher speed.
- Press the +RES button. Hold it there until the desired set speed is displayed on the Driver Information Center (DIC), then release the switch. To increase the set speed in very small amounts, move the switch briefly to +RES. Each time this is done, the set speed increases by 1 km/h (1 mph).

Your vehicle will not reach the set speed until the system determines there is not a vehicle in front of you. At that point, your vehicle speed will increase to the set speed.

Decreasing Set Speed While Using ACC

Press the SET- button until you reach the lower speed desired, then release it.

To slow down in very small amounts, briefly press the SET- button. Each time this is done, the set speed decreases by 1 km/h (1 mph) slower.

Resuming a Set Speed

Suppose the ACC is set at a desired speed and then the brakes are applied. This will turn off the ACC. But it does not need to be reset.

Once the vehicle speed reaches about 40 km/h (25 mph) or more, press the +RES button. ACC will be engaged with the previously chosen set speed.

Selecting the Follow Distance (GAP)

When the system detects a slower moving vehicle, it will adjust your vehicle's speed and maintain the follow distance (gap) you select.

Use the plus and minus buttons on the steering wheel to adjust the follow distance.

Press the plus button to increase the distance or the minus button to decrease the distance. The first button press shows the current follow distance setting on the DIC. The current follow distance setting will be maintained until it is changed.

There are six follow distances to choose from. The follow distance selection ranges from near to far (one second to two seconds follow time). The distance maintained for a selected follow distance will vary based on vehicle speed. The faster the vehicle speed the further back your vehicle will follow. Consider traffic and weather conditions when selecting the follow distance. The range of selectable distances may not be appropriate for all drivers and driving conditions. If you prefer to travel at a follow distance farther than ACC allows, disengage the system and drive manually.

Alerting the Driver

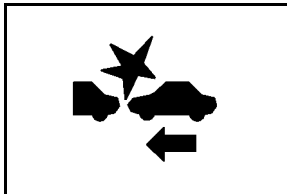

The ACC alert symbol is located on the display at the top of the instrument panel to the right of the driver.

The alert symbol flashes and a warning beep sounds when driver action may be required. If ACC is engaged, the alert symbol will flash when:

- ACC cannot apply sufficient braking because you are approaching a vehicle too rapidly.
- The vehicle speed drops below about 32 km/h (20 mph).

- A temporary condition prohibits ACC from operating. See *DIC Warnings and Messages on page 4-66* for more information.
- A malfunction is detected in the system. See *DIC Warnings and Messages on page 4-66* for more information.

See *Defensive Driving on page 5-2*.

WARNING:

Adaptive Cruise Control has only limited braking ability to slow your vehicle. In some cases, Adaptive Cruise Control may not have time to slow your vehicle enough to avoid a collision. Be ready to take action and apply the brakes yourself. See *Defensive Driving on page 5-2*.

Approaching and Following a Vehicle

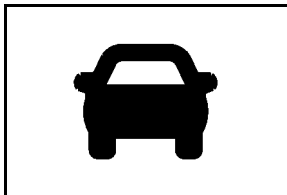

The vehicle ahead symbol is located on the top of the instrument panel to the right of the driver.

The vehicle ahead symbol only appears when a vehicle is detected in your path.

If this symbol does not appear, or disappears briefly, ACC will not respond to vehicles you may see ahead.

WARNING:

When the Adaptive Cruise Control radar is blocked by snow, ice, or dirt, it may not detect a vehicle ahead. Adaptive Cruise Control may not have time to slow your vehicle enough to avoid a collision. Do not use Adaptive Cruise Control when the radar is blocked by snow, ice, or dirt. Keep your radar clean. See “Cleaning the System” later in this section.

ACC automatically slows your vehicle down when approaching a slower moving vehicle. It then adjusts your vehicle speed to follow the vehicle in front at the selected follow distance. Your vehicle speed increases or decreases to follow the vehicle in front of you, but will not exceed the set speed. It may apply limited braking, if necessary. When braking is active, your brake lights will come on. Braking may feel or sound different than if you were applying the brakes yourself. This is normal.

Stationary or Very Slow-Moving Objects

WARNING:

Adaptive Cruise Control may not detect and react to stationary or slow-moving vehicles or other objects ahead of you. You could crash into an object ahead of you. Do not use Adaptive Cruise Control when approaching stationary or slow-moving vehicles or other objects.

WARNING:

Adaptive Cruise Control may not detect and react to stationary or slow-moving vehicles or other objects ahead of you. Your vehicle may accelerate toward objects, such as a stopped vehicle that suddenly appears after the lead vehicle changes lanes. Your complete attention is always required while driving and you should be ready to take action and apply the brakes.

Low-Speed Deactivation

If your vehicle speed falls below 32 km/h (20 mph) while following a vehicle ahead, ACC will begin to disengage. The Driver Alert symbol will flash and the warning beep will sound. The driver must take action since ACC will not slow the vehicle to a stop.

Passing a Vehicle/ACC Override

To increase speed to pass a vehicle, use the accelerator pedal. While you are doing this, the system will not automatically apply the brakes. A message will appear on the DIC. See *DIC Warnings and Messages on page 4-66*. Once you remove your foot from the accelerator pedal, ACC will return to normal operation and be able to apply the brakes, if needed.

WARNING:

If you rest your foot on the accelerator pedal, the system will not automatically apply the brakes. You could crash into a vehicle ahead of you. Do not rest your foot on the accelerator pedal when using Adaptive Cruise Control.

Curves in the Road

WARNING:

Due to Adaptive Cruise Control limitations in curves, it may respond to a vehicle in another lane, or may not have time to react to a vehicle in your lane. You could crash into a vehicle ahead of you, or lose control of your vehicle. Give extra attention in curves and be ready to use the brakes if necessary. Select an appropriate speed while driving in curves.

ACC may operate differently in a sharp curve. It may reduce your vehicle speed if the curve is too sharp.

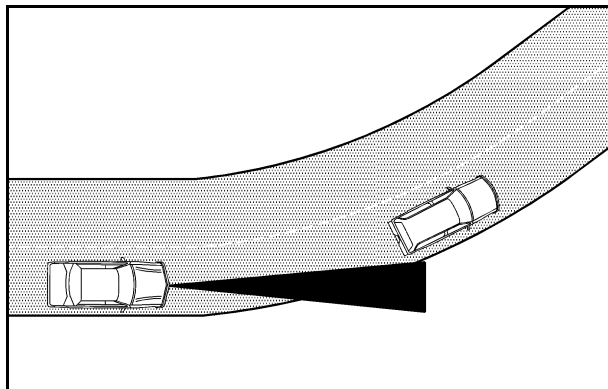

When following a vehicle and entering a curve, ACC could lose track of the vehicle in your lane and accelerate your vehicle. When this happens the Vehicle Ahead symbol will not appear.

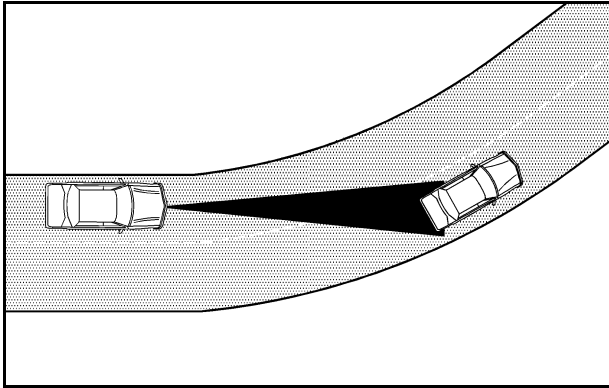

ACC may detect a vehicle that is not in your lane and apply the brakes.

ACC may, occasionally, provide a driver alert and/or braking that you consider unnecessary. It could respond to signs, guardrails, and other stationary objects when entering or exiting a curve. This is normal operation. Your vehicle does not need service.

Highway Exit Ramps

WARNING:

Adaptive Cruise Control may lose track of the vehicle ahead and accelerate up to your set speed while entering or on highway exit ramps. You could be startled by this acceleration and even lose control of the vehicle. Disengage Adaptive Cruise Control before entering a highway exit ramp. Do not use Adaptive Cruise Control while entering or on exit ramps.

Other Vehicle Lane Changes

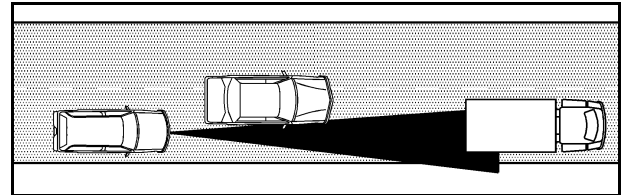

If another vehicle enters the same lane as you, ACC will not detect the vehicle until it is completely in the lane. Be ready to take action and apply the brakes yourself.

Using ACC on Hills and When Towing a Trailer

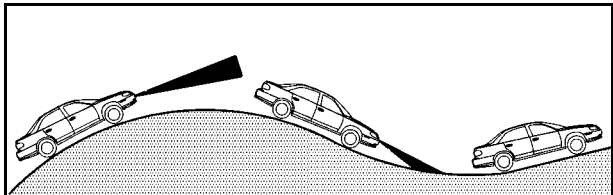

How well ACC will work on hills and when towing a trailer depends on your vehicle's speed, vehicle load, traffic conditions and the steepness of the hills. It may not detect a vehicle in your lane while driving on hills. When going up steep hills, you may want to use the accelerator pedal to maintain your vehicle's speed. When going downhill, especially when towing a trailer, you may want to brake to keep your speed down. Applying the brake disengages the system. You may choose not to use ACC on steep hills, especially when towing a trailer.

Disengaging ACC

To turn off the system, apply the brake pedal, press the cancel button, or press the ACC button.

Erasing Set Speed Memory

Press the ACC button or turn the ignition off.

Other Messages

There are three additional messages that may appear on the DIC. They are SERVICE RADAR CRUISE, RADAR CRUISE NOT READY and CLEAN RADAR. These messages will appear to indicate a problem with the ACC. See *DIC Warnings and Messages on page 4-66* for more information.

Cleaning the System

The radar can become blocked by snow, ice, or dirt. If so, you may need to turn off the engine and clean the lens. Remember, do not use ACC in icy conditions, or when visibility is low, such as in fog, rain or snow.

The emblem/lens is located in the center of the grille.

To clean the emblem/lens, wipe the surface with a soft cloth. After cleaning the emblem/lens, try to engage the ACC. If you are unable to do so, see your dealer.

Exterior Lamps

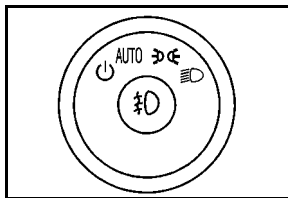

The exterior lamps control is located on the instrument panel to the left of the steering wheel.

It controls the following systems:

- Headlamps
- Taillamps
- Parking Lamps
- License Plate Lamps
- Instrument Panel Lights
- Fog Lamps

The exterior lamps control has four positions:

OFF (Power symbol): Turns off the exterior lamps except for Daytime Running Lamps (DRL).

AUTO (Automatic): Automatically turns on the headlamps at normal brightness, together with the following:

- Parking Lamps
- Instrument Panel Lights
- IntelliBeam™

PARKING LAMPS (Parking lamp symbol): Turns on the parking lamps together with the following:

- Instrument Panel Lights
- License Plate Lamps
- Taillamps
- Side Marker Lamps

The parking brake indicator light comes on and stays on while the parking lamps are on with the engine off and the ignition in ACC/ACCESSORY or ON/RUN.

HEADLAMPS (Headlamp symbol): Turns on the headlamps together with the previously listed lamps. A warning chime sounds if the driver's door is opened while the ignition switch is off and the headlamps are on.

FOG LAMPS (Fog lamp symbol): Press the exterior lamps control to turn on the fog lamps. See *Fog Lamps on page 4-30*.

IntelliBeam™ Intelligent High-Beam Headlamp Control System

For vehicles with this feature, be sure to read this entire section before using it.

IntelliBeam is an enhancement to the vehicle's headlamp system. Using a digital light sensor on the rearview mirror, this system turns the vehicle's high-beam headlamps on and off according to surrounding traffic conditions.

The IntelliBeam system turns the high-beam headlamps on when it is dark enough, there is no other traffic present, and the IntelliBeam system is enabled.

Turning On and Enabling IntelliBeam™

Press and release the IntelliBeam button on the inside rear view mirror. The IntelliBeam indicator on the mirror turns on to indicate the system is on. Once the system has been turned on, it remains on each time the vehicle is started, but the IntelliBeam system must be enabled.

To enable the IntelliBeam system, turn the exterior lamp control to AUTO, with the turn signal/multifunction lever in its neutral position. The High-Beam On Light appears on the instrument panel cluster when the high-beams are on. See *Highbeam On Light on page 4-60*.

Driving with IntelliBeam™

IntelliBeam only activates the high-beams when driving over 20 mph (32 km/h).

The high-beam headlamps remain on, under the automatic control of IntelliBeam, until any of the following situations occur:

- The system detects an approaching vehicle's headlamps.
- The system detects a preceding vehicle's taillamps.
- The outside light is bright enough that high-beam headlamps are not required.
- The vehicle's speed drops below 15 mph (24 km/h).
- The headlamp stalk is moved forward to the high-beam position or the flash-to-pass feature is used. See *Headlamp High/Low-Beam Changer on page 4-6* and *Flash-to-Pass on page 4-10*.

When either of these conditions occur, the IntelliBeam feature is disabled and the IntelliBeam light in the mirror turns off until the high-beam stalk is returned to the neutral position.

- If IntelliBeam was using low-beams prior to this action, the IntelliBeam feature is temporarily disabled until the stalk is returned to the neutral position.

- The exterior lamp control is turned to any setting except AUTO.

When this occurs, IntelliBeam is disabled until the control is turned back to the AUTO position.

- The IntelliBeam system is turned off at the inside rearview mirror.

IntelliBeam might not turn off the high-beams if the system cannot detect other vehicle's lamps because of any of the following:

- The other vehicle's lamp(s) are missing, damaged, obstructed from view, or otherwise undetected.
- The other vehicle's lamp(s) are covered with dirt, snow, and/or road spray.
- The other vehicle's lamp(s) cannot be detected due to dense exhaust, smoke, fog, snow, road spray, mist, or other airborne obstructions.
- Your vehicle's windshield is dirty, cracked, or obstructed by something that blocks the view of the IntelliBeam light sensor.
- Your vehicle's windshield is covered with ice, dirt, haze, or other obstructions.
- Your vehicle is loaded such that the front end of the vehicle points upward, causing the IntelliBeam sensor to aim high and not detect headlamps and taillamps.
- You are driving on winding or hilly roads.

You might need to manually disable or cancel the high-beam headlamps by turning the low-beam headlamps on, if any of the above conditions exist.

Disabling and Resetting IntelliBeam™ at the Rearview Mirror

IntelliBeam can be disabled by using the controls on the inside rearview mirror.

AUTO  (On/Off): Press this button on the inside rearview mirror to disable the system. The IntelliBeam indicator turns off and does not come back on until the IntelliBeam button is pressed again.

When IntelliBeam has turned on the high-beams, pull or push the high-beam stalk. This will disable IntelliBeam. The IntelliBeam indicator on the mirror turns off. To turn IntelliBeam back on, press the IntelliBeam button on the mirror.

A different sensitivity setting is available for dealer diagnostics. This is done by pushing and holding this button for 20 seconds until the IntelliBeam indicator light flashes three times. If you accidentally activate this, the vehicle's setting automatically is reset when the ignition is turned off and then on again.

Cleaning the IntelliBeam™ Light Sensor

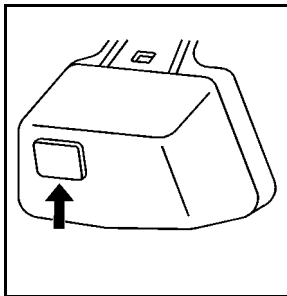

The light sensor is located on the inside of the vehicle in front of the inside rearview mirror.

Clean the light sensor window, periodically, using glass cleaner on a soft cloth. Gently wipe the sensor window. Do not spray glass cleaner directly on the surface of the sensor window.

Wiper Activated Headlamps

This feature activates the headlamps and parking lamps after the windshield wipers are turned on and have completed eight wipe cycles within four minutes.

When the ignition is turned to LOCK/OFF, the wiper-activated headlamps immediately turn off. The wiper-activated headlamps also turn off if the windshield wipers are turned off.

Headlamps on Reminder

A warning chime will sound if the exterior lamp control is left on in either the headlamp or parking lamp position and the driver's door is opened with the ignition off.

Daytime Running Lamps (DRL)

Daytime Running Lamps (DRL) can make it easier for others to see the front of your vehicle during the day. Fully functional daytime running lamps are required on all vehicles first sold in Canada.

The DRL system makes the turn signal lamps come on when the following conditions are met:

- It is still daylight and the ignition is on.
- The exterior lamp control is in the off position.
- The transmission is not in P (Park) (United States only).
- The light sensor is covered or not detecting light. See "Sensors" under *Dual Climate Control System* on page 4-36.

When DRL are on, no other exterior lamps such as the parking lamps, taillamps, etc. will be on when the DRL are being used. The instrument panel will not be lit up either.

When automatic lighting is on and it is dark enough outside, the turn signal lamps turn off and normal low-beam headlamp operation occurs.

When automatic lighting is on and it is bright enough outside, the regular lamps go off, and the DRL takes over. If the vehicle is started in a dark garage, the automatic headlamp system comes on immediately. Once you leave the garage, it will take approximately one minute for the automatic headlamp system to change to DRL if there is light outside. During that delay, the instrument panel cluster may not be as bright as usual. Make sure the instrument panel brightness knob is in the full bright position. See *Instrument Panel Brightness* on page 4-30.

Turning on automatic lighting or the headlamps will deactivate the DRL. If the parking lamps or the fog lamps were turned on instead, the DRL will still deactivate.

To idle the vehicle with the DRL off at night, turn off automatic lighting and shift the transmission into P (Park). Placing the vehicle in P (Park) disables the DRL. The DRL will stay off until the vehicle is shifted out of P (Park).

To drive the vehicle with the DRL off, turn off automatic lighting and manually turn on the parking lamps or fog lamps, if the vehicle has them.

The regular headlamp system should be turned on when needed.

Fog Lamps

The fog lamps button is on the exterior lamps control to the left of the steering column.

 **(Fog Lamps):** Press the exterior lamps button to turn the fog lamps on or off. A light comes on in the instrument panel cluster when the fog lamps are in use. See *Instrument Panel Cluster on page 4-46*. The ignition must be in the ON/RUN position for the fog lamps to work.

The fog lamps will go off when the headlamps are changed to high-beam.

Some localities have laws that require the headlamps to be on along with the fog lamps.

Cornering Lamps

The cornering lamps come on when the headlamps or parking lamps are on and you signal a turn with the multifunction lever. They provide more light for cornering.

Exterior Lighting Battery Saver

If the exterior lamp button has been left on, the exterior lamps will turn off about 10 minutes after the ignition is turned to LOCK/OFF and a door has been opened. This protects against draining the battery if the headlamps or parking lamps are accidentally left on. If you need to leave the lamps on for more than 10 minutes, use the exterior lamp control to turn the lamps back on after the ignition is turned to LOCK/OFF and any door is opened.

Instrument Panel Brightness

 **(Instrument Panel Brightness):** This feature controls the brightness of the instrument panel and footwell lights, if equipped.

The button for this control is located below the exterior lamps control.

Push the button in and release to extend the button. Turn the button clockwise or counterclockwise to brighten or dim the lights.

Courtesy Lamps

The courtesy lamps are located on the headliner above the rear seat. These lamps come on by turning the instrument panel brightness knob fully clockwise or when any door is opened and it is dark outside. Puddle lamps are located on the bottom of the front and rear door trim.

Professional vehicles have an additional dome lamp and also opera lamps.

Entry Lighting

This feature turns on the courtesy lamps and the backlighting for the door switches and the exterior lamp control when a door is opened or if the remote keyless entry transmitter unlock button is pressed. If activated due to the transmitter, the lighting remains active for about 40 seconds. Since the entry lighting system uses the light sensor, it must be dark outside in order for the courtesy lamps to turn on. The courtesy lamps turn off approximately 25 seconds after the last door is closed. They will dim to off if the ignition key is turned to ON/RUN, or immediately deactivate if the power locks are activated.

Parade Dimming

This feature prohibits dimming of the digital displays and backlighting during daylight hours when the key is in the ignition and the headlamps are on. This feature is fully automatic. When the light sensor reads darkness outside and the parking lamps are active, the digital displays can be adjusted by turning the instrument panel brightness knob counterclockwise to dim and clockwise to brighten lighting.

Reading Lamps

The reading lamps are located on the overhead console on the headliner and in the rear door opening. These lamps come on automatically when any door is opened and it is dark outside.

For manual operation, press the button to turn them on. Press it again to turn them off.

If the reading lamps are left on, they automatically shut off 10 minutes after the ignition has been turned off.

Footwell Lamps

For vehicles with footwell lamps, they are located under the instrument panel and at the rear of the front seats. These lamps provide soft light to the front and rear floor areas. They dim with the instrument panel cluster lights.

Footwell lighting brightness can be adjusted with the instrument panel brightness control located below the exterior lamps control. See *Instrument Panel Brightness on page 4-30*. The footwell lights will turn off before the instrument panel lights are at their lowest level of brightness.

Battery Load Management

This feature monitors the vehicle's electrical load and determines when the battery is in a heavy discharge condition. During times of high electrical loading, the engine may idle at a higher revolutions per minute (rpm) setting than normal to make sure the battery charges. High electrical loads may occur when several of the following are on: headlamps, high beams, fog lamps, rear window defogger, the climate control fan at high speeds, heated seats and engine cooling fans.

If the battery continues to discharge, even with the engine idling at a higher rpm setting, some electrical loads will automatically be reduced. When this occurs, the rear window defogger may take slightly longer to clear the glass, the heated seats may not get as warm as they usually do and the climate control fan may cut back to a lower speed. For more battery saving information, see "Battery Saver Active Message" under *DIC Warnings and Messages on page 4-66*.

Electric Power Management

The vehicle has Electric Power Management (EPM) that estimates the battery's temperature and state of charge. It then adjusts the voltage for best performance and extended life of the battery.

When the battery's state of charge is low, the voltage is raised slightly to quickly bring the charge back up. When the state of charge is high, the voltage is lowered slightly to prevent overcharging. If the vehicle has a voltmeter gauge or a voltage display on the Driver Information Center (DIC), you may see the voltage move up or down. This is normal. If there is a problem, an alert will be displayed.

The battery can be discharged at idle if the electrical loads are very high. This is true for all vehicles. This is because the generator (alternator) may not be spinning fast enough at idle to produce all the power that is needed for very high electrical loads.

A high electrical load occurs when several of the following are on, such as: headlamps, high beams, fog lamps, rear window defogger, climate control fan at high speed, heated seats, engine cooling fans, trailer loads, and loads plugged into accessory power outlets.

EPM works to prevent excessive discharge of the battery. It does this by balancing the generator's output and the vehicle's electrical needs. It can increase engine idle speed to generate more power, whenever needed. It can temporarily reduce the power demands of some accessories.

Normally, these actions occur in steps or levels, without being noticeable. In rare cases at the highest levels of corrective action, this action may be noticeable to the driver. If so, a Driver Information Center (DIC) message might be displayed, such as BATTERY SAVER ACTIVE, BATTERY VOLTAGE LOW, or LOW BATTERY. If this message is displayed, it is recommended that the driver reduce the electrical loads as much as possible. See *DIC Warnings and Messages on page 4-66*.

Inadvertent Power Battery Saver

This feature is designed to protect your vehicle's battery against drainage from the interior lamps, trunk lamp, glove box lamp, or the garage door opener. When the ignition is turned off, the power to these features will automatically turn off after 10 minutes. Power will be restored for an additional 10 minutes if any door or trunk is opened, or the courtesy lamp switch is turned on.

Battery Run-Down Protection

This feature helps prevent the battery from being drained, if the interior courtesy lamps, reading/map lamps, visor vanity lamps or trunk lamp are accidentally left on. If any of these lamps are left on, they automatically turn off after 10 minutes, if the ignition is off. The lamps will not come back on again until one of the following occurs:

- The ignition is turned on.
- The exterior lamps control is turned off, then on again.

The headlamps will timeout after 10 minutes, if they are manually turned on with the ignition on or off.

Accessory Power Outlet(s)

The accessory power outlets can be used to plug in electrical equipment, such as a cellular telephone.

If the vehicle has a center console, the power outlet is located inside the lower storage area. Some vehicles may have an outlet on the right front lower part of the driver's seat and under the climate control system next to the ashtray. See *Center Console Storage* on page 3-56.

There are two accessory power outlets in the rear seat area located on the door armrests next to the ashtrays.

There may be a small cap that must be removed to access the accessory power outlet. When not using the outlet be sure to cover it with the protective cap.

The accessory power outlet can be used at any time.

Notice: Leaving electrical equipment plugged in for an extended period of time while the vehicle is off will drain the battery. Power is always supplied to the outlets. Always unplug electrical equipment when not in use and do not plug in equipment that exceeds the maximum 20 ampere rating.

Certain accessory power plugs may not be compatible to the accessory power outlet and could result in blown vehicle or adapter fuses. If you experience a problem see your dealer for additional information on the accessory power outlets.

Notice: Adding any electrical equipment to the vehicle can damage it or keep other components from working as they should. The repairs would not be covered by the vehicle warranty. Do not use equipment exceeding maximum amperage rating of 20 amperes. Check with your dealer before adding electrical equipment.

Follow the proper installation instructions that are included with any electrical equipment you install.

Notice: Improper use of the power outlet can cause damage not covered by the vehicle warranty. Do not hang any type of accessory or accessory bracket from the plug because the power outlets are designed for accessory power plugs only.

Ashtray(s)

Notice: If papers, pins, or other flammable items are put in the ashtray, hot cigarettes or other smoking materials could ignite them and possibly damage the vehicle. Never put flammable items in the ashtray.

Front Ashtray

With the full floor console, the ashtray is located below the climate control system. To open, push down and then release the cover. To clean the ashtray, push the lip of the ashtray to remove it. Push the opposite side of the ashtray's lip to install.

For vehicles without the floor console, pull the tray located below the climate controls to reveal the ashtray. The ashtray can be removed by pulling on the ledge located at the top of the ashtray.

Rear Ashtray

The ashtrays are located on the door armrests. To use an ashtray, lift the lid.

Analog Clock

The analog clock is located on the instrument panel above the radio. The clock is not connected with any other vehicle system and runs by itself. To adjust the clock:

1. Locate the adjustment button directly below the clock face.
2. Push and hold the adjustment button to advance the clock hands. Holding the button down will cause the clock to advance faster. Release the button before reaching the desired time.
3. Push and release the button to increase the time by one minute increments until the desired time is reached.

Climate Controls

Dual Climate Control System

The heating, cooling, and ventilation for the vehicle can be controlled with this system.

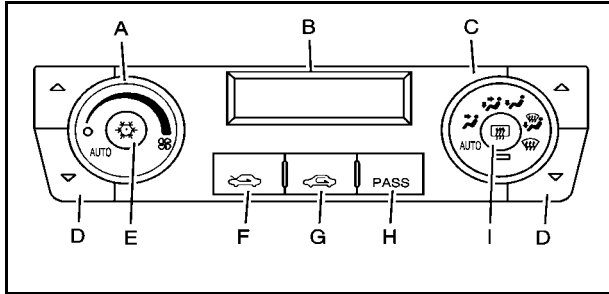

Dual Climate Control System

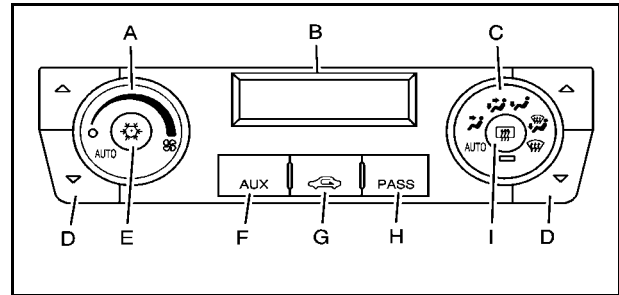

Dual Climate Control System for Vehicles with Rear Climate Control

- | | |
|--|-------------------------------------|
| A. Fan Control | F. Outside Air or AUX |
| B. Display | G. Recirculation |
| C. Air Delivery Mode | H. PASS (Passenger Climate Control) |
| D. Driver and Passenger Temperature Controls | I. Rear Window Defogger |
| E. Air Conditioning | |

Automatic Operation

AUTO  (Automatic Fan): When this position is selected on the fan control, the system adjusts the fan speed. If the OnStar[®] system is activated when this position is selected, the climate control fan speed will lower.

AUTO (Automatic Mode):

1. Turn the fan control to the AUTO position.
2. Turn the mode control to the AUTO position.
3. Adjust the temperature to a comfortable setting between 21°C (68°F) and 26°C (78°F).

Choosing the coldest or warmest temperature setting will not cause the system to heat or cool any faster. In cold weather, the system will start at reduced fan speeds to avoid blowing cold air into the vehicle until warmer air is available.



The system starts out blowing air at the floor but may change modes automatically as the vehicle warms up to maintain the chosen temperature setting. The length of time needed to warm the interior depends on the outside temperature and temperature of the vehicle.

4. Wait 20 to 30 minutes for the system to stabilize in order for the system to regulate automatically. Then adjust the temperature as necessary to find your comfort setting.

Do not cover the solar sensor located in the center of the instrument panel near the windshield. For more information on the solar sensor, see “Sensors” later in this section.

After the vehicle is started, the display shows the interior temperature settings and the outside temperature.

If the AUTO position is selected on the fan or mode control, the system automatically controls the air conditioning compressor. The A/C compressor will run automatically even at cool outside temperatures in order to dehumidify the air. The A/C indicator light is lit when the system is operating automatically, even at near freezing outside temperatures. Press  on the fan control to turn off the A/C. For improved window clearing performance in defog or defrost modes, the A/C compressor runs automatically.

 (AUTO RECIRCULATION): If the AUTO position is selected on either the fan or mode control, the system automatically controls the air inlet to supply fresh outside air or recirculate the interior air to cool the car faster. The light on the recirculation button will come on when the system changes to recirculation. Outside air can be forced by pressing  when the light is lit.

For vehicles without rear climate controls, press  to force outside air. The next time AUTO fan or mode is selected, the air inlet will reset back to AUTO operation.

Manual Operation

 **(Off):** Turns the entire climate control system off. Outside air still enters the vehicle and is directed to the floor. The airflow direction and temperature can be adjusted, as indicated below.

If the temperature is adjusted while the system is off, the display will light to show the current settings.

 **(Driver's Temperature Controls):** Press the up or down buttons next to the fan control to manually increase or decrease the temperature inside the vehicle.

 **(Passenger's Temperature Controls):** Press the up or down buttons next to the air delivery mode control to manually increase or decrease the temperature for the front passenger. If the passenger climate control system is off, pressing one of these buttons turns it on.

 **(Fan Control):** Turn clockwise or counterclockwise to increase or decrease the fan speed. Turning this control completely counterclockwise will turn on the automatic fan operation. If the airflow seems low when the fan speed is at the highest setting, the passenger compartment air filter may need to be replaced. See *Passenger Compartment Air Filter on page 4-43*.

Air Delivery Mode Control: Turn clockwise or counterclockwise to change the current airflow mode.

Select one of the following:

AUTO: Turns on the automatic delivery mode operation.

 **(Vent):** Air is directed to the instrument panel outlets.

 **(Bi-Level):** Air is divided between the instrument panel and the floor outlets. In automatic operation, cooler air is directed to the upper outlets and warmer air to the floor outlets.

 **(Floor):** Air is directed to the floor outlets with some air directed to the side window outlets and the windshield.

If recirculation is selected, it only stays on for three minutes to reduce windshield fogging.



 **(Floor/Defog):** This mode clears the windows of fog or moisture. Air is directed to the floor outlets, with some air going to the side window outlets and windshield. When selected, the system turns off recirculation and runs the air conditioning compressor unless the outside temperature is at or below freezing. The recirculation mode cannot be selected while in the floor/defog mode.

 **(Defrost):** This mode clears the windshield of fog or frost more quickly. Air is directed to the windshield and side window outlets. When selected, the system automatically turns off recirculation and runs the air conditioning compressor, unless the outside temperature is at or below freezing. Recirculation cannot be selected while in the defrost mode. Do not drive the vehicle until all the windows are clear.

For professional vehicles, air will be allowed to flow through the rear outlets. For quicker defrost, press the AUX button on the front climate control system so that the light is not lit.

 **(Air Conditioning):** Press to turn the air conditioning system on or off and override the automatic system. When in AUTO, the air conditioning compressor comes on automatically, as necessary. To avoid window fogging on rainy and humid days at temperatures above freezing, run the air conditioning.

The air conditioning system removes moisture from the air, so a small amount of water may drip under the vehicle while idling or after turning off the engine. This is normal.

 **(Outside Air):** Press to turn the outside air mode on or off. An indicator light comes on to show it is on. Air is pulled from outside the vehicle. Pressing  will cancel this mode.

 **(Recirculation):** Press to turn the recirculation mode on or off. An indicator light below the button comes on to show that this mode is on. This mode recirculates and helps to quickly cool the air inside the vehicle. It can be used to prevent outside air and odors from entering the vehicle. This mode cannot be selected while in the defog or defrost modes. If you try to select the recirculation mode, the indicator light flashes three times and turns off.

Operation in this mode during periods of high humidity and cool outside temperatures may result in increased window fogging. If window fogging is experienced, select the defrost mode.

AUX: For vehicles with a rear climate control system, press to turn the rear climate control fan on for automatic operation. After the AUX button is pressed, the indicator light comes on. Press the button again to turn the auxiliary fan off. See *Rear Climate Control System on page 4-42*.

PASS (Passenger Climate Control): Press to turn the passenger climate control systems on or off. When the passenger climate control system is on, the passenger temperature setting is displayed. The temperature selected by the front passenger also controls the rear system air temperature unless the rear seat passengers select their own comfort setting.

If the PASS button is pressed to turn the passenger temperature setting off, the driver's temperature knob will control the temperature for the entire vehicle.

Rear Window Defogger

The rear window defogger uses a warming grid to remove fog or frost from the rear window.

 **(Rear Defogger):** Press to turn the rear window defogger on or off. Be sure to clear as much snow from the rear window as possible. The rear window defogger will turn off approximately 20 minutes after the button is pressed if the vehicle is moving at slower vehicle speeds. At higher vehicle speeds, the rear defogger may stay on continuously. Each additional press will run the defogger for approximately 10 minutes.

The heated outside rearview mirrors will turn on to help clear fog or frost from the surface of the mirror when the rear window defogger is on.

Notice: Do not use a razor blade or sharp object to clear the inside rear window. Do not adhere anything to the defogger grid lines in the rear glass. These actions may damage the rear defogger. Repairs would not be covered by your warranty.

Sensors

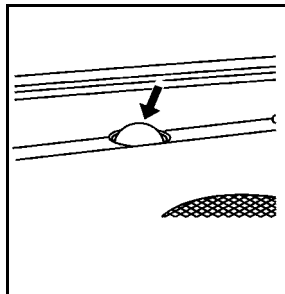

The solar sensor, located in the defrost grille, middle of the instrument panel, monitors the solar radiation. Do not cover the solar sensor or the system will not work properly.

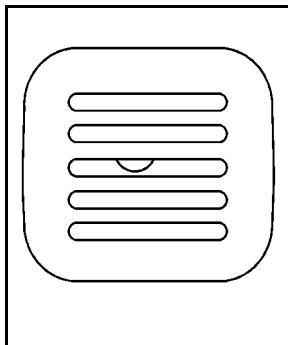

There is also an interior temperature sensor located next to the steering wheel that measures the temperature of the air inside the vehicle.

There is also an exterior temperature sensor located behind the front grille. This sensor reads the outside air temperature and helps maintain the temperature inside the vehicle. Any cover on the front of the vehicle could cause a false reading in the displayed temperature.

In order to prevent false temperature readings at startup, the displayed temperature will not change until the following occurs:

- Vehicle speed is above 16 km/h (10 mph) for 5 minutes.
- Vehicle speed is above 51 km/h (32 mph) for 2 and a half minutes.

The climate control system uses the information from these sensors to maintain your comfort setting by adjusting the outlet temperature, fan speed, and the air delivery mode. The system may also supply cooler air to the side of the vehicle facing the sun. The recirculation mode will also be used as needed to maintain cool outlet temperatures.

Outlet Adjustment

For the front outlets, use the thumbwheel located below each outlet to change the direction of the airflow. Use the thumbwheel located next to the outlets to shut the airflow or to open the outlets and re-direct the air.

For the rear outlets, slide the lever left or right and up or down to change the direction of the airflow.

Operation Tips

- Clear away any ice, snow or leaves from the air inlets at the base of the windshield that may block the flow of air into your vehicle.
- Use of non-GM approved hood deflectors may adversely affect the performance of the system.
- Keep the path under the front seats clear of objects to help circulate the air inside of your vehicle more effectively.

Rear Climate Control System

For vehicles with a rear climate control system, the rear seat passengers can adjust the direction of the airflow, fan speed and temperature for the rear seating area. This system also works with the main climate control system in the vehicle.

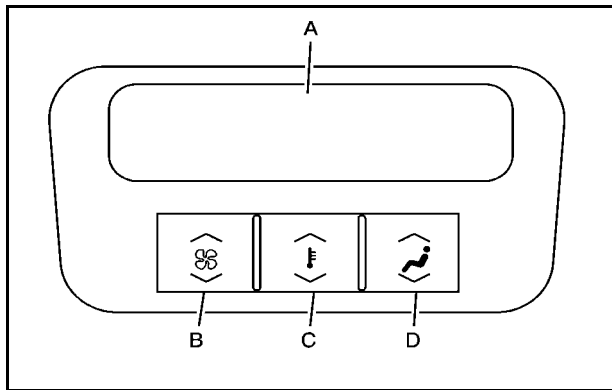

The rear climate control system is located on the back of the center console.

- A. Display
- B. Fan Control
- C. Temperature Control
- D. Air Delivery Mode Control

AUX (Auxiliary): Press the AUX button located on the front climate control panel to turn the rear climate control system on or off. When turned on the rear system operates in automatic mode and the temperature settings selected for the front climate control panel will also be selected for the rear passengers.

To adjust the rear climate control system, the rear passenger can select a different temperature, mode or fan speed. Whenever the rear passengers have adjusted settings on the rear climate control system, the AUX light is lit on the front climate control system.

When the front climate control system is turned off or in defrost mode, the rear climate control system is turned off. The rear system will turn back on once another front mode is selected.

For more information on how to use the front climate control system, see *Dual Climate Control System on page 4-36*. For more information on the air outlets, see *Outlet Adjustment on page 4-41*.

Automatic Operation

^ FAN V (Fan Control): Press until AUTO appears on the display to place the system in automatic mode. When automatic operation is active, the system automatically controls the fan speed.

If in auto fan mode, pressing the up arrow button will cancel automatic operation and places the system in manual mode. If in auto mode, pressing the down arrow will turn the rear climate control system off.

^  v (Air Delivery Mode Control): Press until AUTO appears on the display to place the system in automatic mode. When automatic operation is active, the system controls the air delivery mode.

Manual Operation

^  v (Fan Control): Press to increase or decrease the fan speed.

^  v (Temperature Control): Press to increase or decrease the temperature for the rear seat passengers. Once the rear temperature setting is changed from following the front temperature setting, it will no longer follow changes to the front temperature setting until the front climate control AUX button resets it.

^  v (Air Delivery Mode Control): Press these buttons to change the air delivery mode. If in AUTO air delivery mode, pressing the up arrow button will cancel automatic operation and place the system in manual mode.

 (Vent): Air is directed to the upper outlets.

 (Bi-Level): Air is divided between the upper outlets and the floor outlets.

 (Floor): Air is directed to the floor outlets.

Passenger Compartment Air Filter

The passenger compartment air filter traps most of the pollen from the air entering the vehicle. The filter may need to be changed periodically. For how often to change the passenger compartment air filter, see *Scheduled Maintenance* on page 7-3.

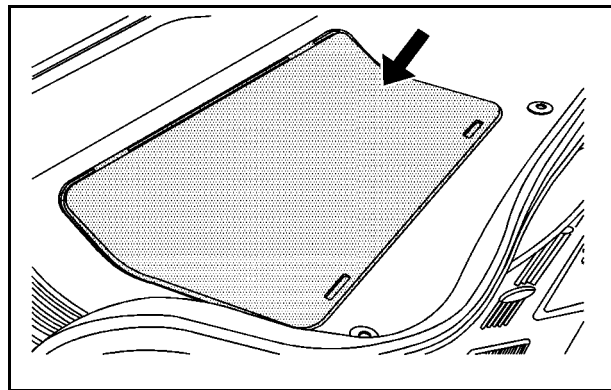

The access panel for the passenger compartment air filter is located under the hood near the windshield, on the passenger's side of the vehicle.

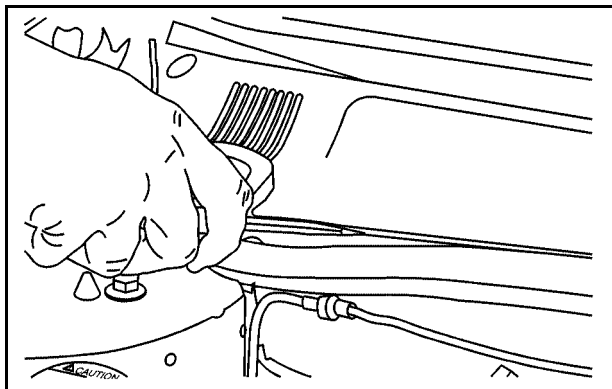

To access the passenger compartment air filter:

1. Use a tool to remove the cover. If the vehicle has tabs that allow the cover to be unlatched with your fingers, a tool will not be needed for this step.

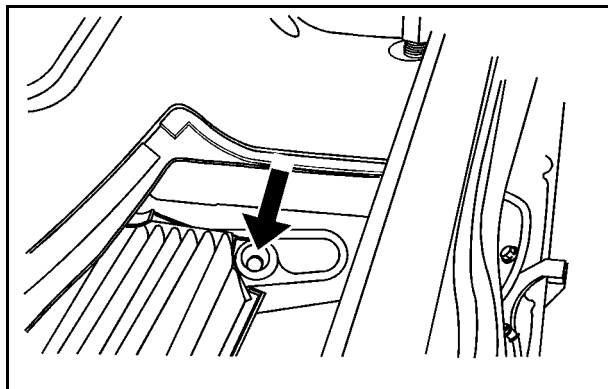

2. Then, insert a tool behind the push pin located on the inboard side of the air filter compartment to carefully pry the pin out.

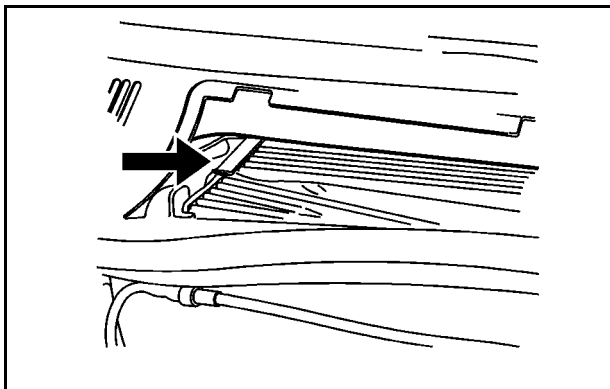

3. To remove the air filter, insert a tool between the air filter and the compartment wall on the outboard side of the vehicle. Then, push in to flatten the pin holding the air filter in place. Gently remove the air filter and any loose debris that may be inside the air filter compartment.
4. Insert the new air filter by pushing until you hear a click. Then, reinstall the push pin and snap the cover into place.

Warning Lights, Gauges, and Indicators

Warning lights and gauges can signal that something is wrong before it becomes serious enough to cause an expensive repair or replacement. Paying attention to the warning lights and gauges could prevent injury.

Warning lights come on when there might be or there is a problem with one of the vehicle's functions. Some warning lights come on briefly when the engine is started to indicate they are working.

Gauges can indicate when there might be or there is a problem with one of the vehicle's functions. Often gauges and warning lights work together to indicate a problem with the vehicle.

When one of the warning lights comes on and stays on while driving, or when one of the gauges shows there could be a problem, check the section that explains what to do. Follow this manual's advice. Waiting to do repairs can be costly and even dangerous.

Instrument Panel Cluster

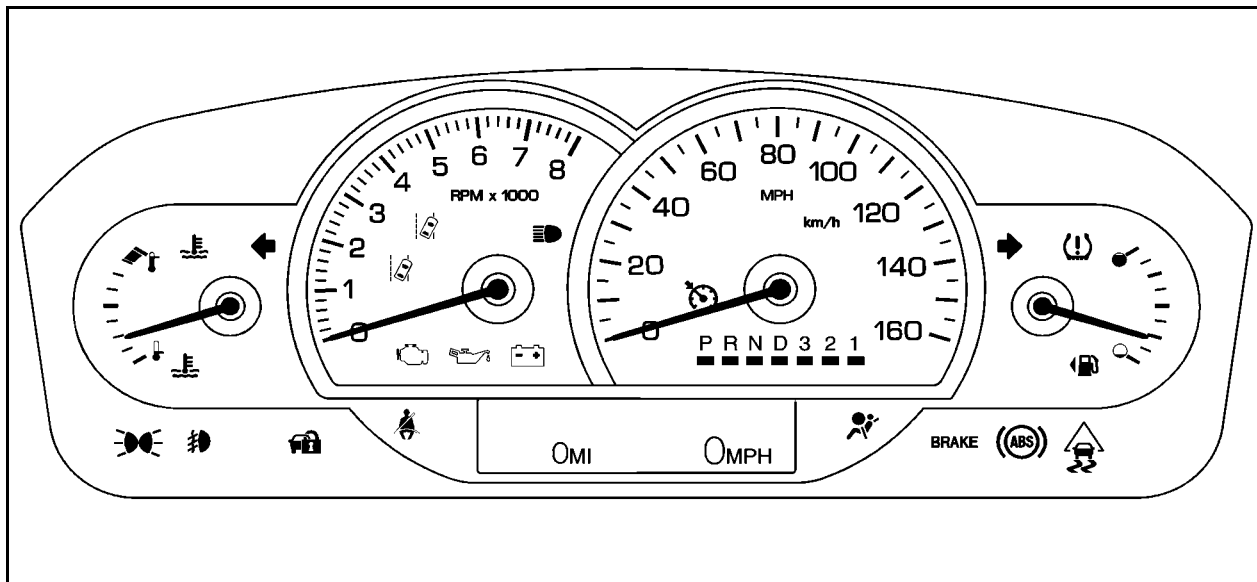

United States version shown, Canada similar

Speedometer and Odometer

The speedometer shows the speed in both miles per hour (mph) and kilometers per hour (km/h). See "MPH (km)" under *DIC Operation and Displays* on page 4-61 for more information.

The odometer mileage can be checked without the vehicle running. The vehicle's odometer works together with the driver information center. Trip A and Trip B can be set on the odometer. See "Trip Fuel" under *DIC Operation and Displays* on page 4-61 for more information.

If the vehicle ever needs a new odometer installed, the new one is set to the correct mileage total of the old odometer.

Tachometer

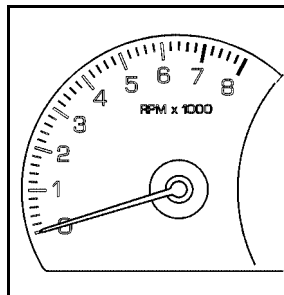

This gauge indicates the engine speed in revolutions per minute (rpm).

Safety Belt Reminders

Safety Belt Reminder Light

When the engine is started, a chime sounds for several seconds to remind a driver to fasten the safety belt, unless the driver safety belt is already buckled.



The safety belt light comes on and stays on for several seconds, then flashes for several more.

This chime and light are repeated if the driver remains unbuckled and the vehicle is in motion. If the driver safety belt is already buckled, neither the chime nor the light comes on.

Airbag Readiness Light

The system checks the airbag's electrical system for possible malfunctions. If the light stays on it indicates there is an electrical problem. The system check includes the airbag sensor, the pretensioners, the airbag modules, the wiring and the crash sensing and diagnostic module. For more information on the airbag system, see *Airbag System on page 2-58*.



The airbag readiness light flashes for a few seconds when the engine is started. If the light does not come on then, have it fixed immediately.

WARNING:

If the airbag readiness light stays on after the vehicle is started or comes on while driving, it means the airbag system might not be working properly. The airbags in the vehicle might not inflate in a crash, or they could even inflate without a crash. To help avoid injury, have the vehicle serviced right away.

If there is a problem with the airbag system, an airbag Driver Information Center (DIC) message can also come on. See *DIC Warnings and Messages* on page 4-66 for more information.

Passenger Airbag Status Indicator

The vehicle has the passenger sensing system. See *Passenger Sensing System* on page 2-68 for important safety information. The overhead console has a passenger airbag status indicator.



United States

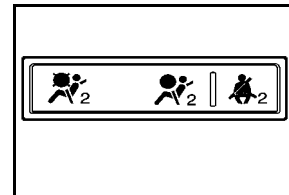

Canada

When the vehicle is started, the passenger airbag status indicator will light ON and OFF, or the symbol for on and off, for several seconds as a system check.

If you are using remote start to start the vehicle from a distance, if equipped, you may not see the system check.

Then, after several more seconds, the status indicator will light either ON or OFF, or either the on or off symbol, to let you know the status of the right front passenger frontal and seat-mounted side impact airbags.

If the word ON or the on symbol is lit on the passenger airbag status indicator, it means that the right front passenger frontal airbag and seat-mounted side impact airbag are enabled (may inflate).

If the word OFF or the off symbol is lit on the passenger airbag status indicator, it means that the passenger sensing system has turned off the right front passenger frontal and seat-mounted side impact airbag.

If, after several seconds, both status indicator lights remain on, or if there are no lights at all, there may be a problem with the lights or the passenger sensing system. See your dealer for service.

WARNING:

If the airbag readiness light ever comes on and stays on, it means that something may be wrong with the airbag system. To help avoid injury to yourself or others, have the vehicle serviced right away. See *Airbag Readiness Light on page 4-48* for more information, including important safety information.

Charging System Light

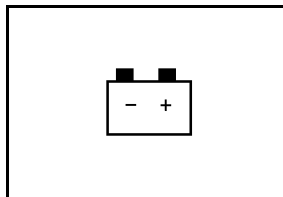

This light comes on briefly when the ignition key is turned to START, but the engine is not running, as a check to show it is working.

If it does not, have the vehicle serviced by your dealer.

The light should go out once the engine starts. If it stays on, or comes on while driving, there could be a problem with the charging system. A charging system message in the Driver Information Center (DIC) can also appear. See *DIC Warnings and Messages on page 4-66* for more information. This light could indicate that there are problems with a generator drive belt, or that there is an electrical problem. Have it checked right away. If the vehicle must be driven a short distance with the light on, turn off accessories, such as the radio and air conditioner.

Brake System Warning Light

The vehicle's hydraulic brake system is divided into two parts. If one part is not working, the other part can still work and stop the vehicle. For good braking both parts need to be working.

If the warning light comes on, there is a brake problem. Have the brake system inspected right away.



United States

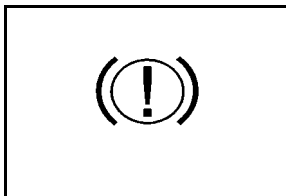

Canada

This light comes on briefly when the engine is turned on. If it does not come on then, have it fixed so it will be ready to warn if there is a problem.

When the ignition is on, the brake system warning light also comes on when the parking brake is set. The light will stay on if the parking brake does not release fully. If it stays on after the parking brake is fully released, it means there is a brake problem.

If the light comes on while driving, pull off the road and stop carefully. The pedal may be harder to push, or the pedal may go closer to the floor. It may take longer to stop. If the light is still on, have the vehicle towed for service. See *Towing Your Vehicle* on page 5-24.

WARNING:

The brake system might not be working properly if the brake system warning light is on. Driving with the brake system warning light on can lead to a crash. If the light is still on after the vehicle has been pulled off the road and carefully stopped, have the vehicle towed for service.

Antilock Brake System (ABS) Warning Light

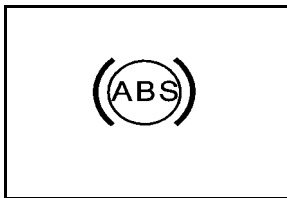

For vehicles with the Antilock Brake System (ABS), this light comes on briefly when the engine is started.

If it does not, have the vehicle serviced by your dealer. If the system is working normally the indicator light then goes off.

If the ABS light stays on, turn the ignition off. If the light comes on while driving, stop as soon as it is safely possible and turn the ignition off. Then start the engine again to reset the system. If the ABS light stays on, or comes on again while driving, the vehicle needs service. If the regular brake system warning light is not on, the vehicle still has brakes, but not antilock brakes. If the regular brake system warning light is also on, the vehicle does not have antilock brakes and there is a problem with the regular brakes. See *Brake System Warning Light on page 4-51*.

For vehicles with a Driver Information Center (DIC), see *DIC Warnings and Messages on page 4-66* for all brake related DIC messages.

Traction Control System (TCS) Warning Light



This warning light comes on briefly while starting the engine.

If it does not, have the vehicle serviced by your dealer. If the system is working normally the indicator light will then go off.

If it stays on, or comes on while driving, there may be a problem with the traction control system and the vehicle needs service. When this warning light is on, the system will not limit wheel spin.

If the traction control system warning light comes on and stays on when the system is turned on, the vehicle needs service. See *Traction Control System (TCS) on page 5-6* for more information.

StabiliTrak® Indicator Light

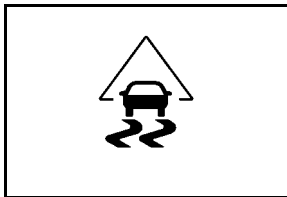

For vehicles with the StabiliTrak® system, this light comes on briefly while starting the engine.

If it does not, have the vehicle serviced by your dealer. If the system is working normally the indicator light then goes off.

If the light comes on and stays on while driving, there could be a problem with the StabiliTrak® system and the vehicle might need service. When this warning light is on, the StabiliTrak® system is off and does not limit wheel spin.

The light flashes if the system is active and is working to assist the driver with directional control of the vehicle in difficult driving conditions.

See *StabiliTrak® System on page 5-5* for more information.

Lane Departure Warning (LDW) Light

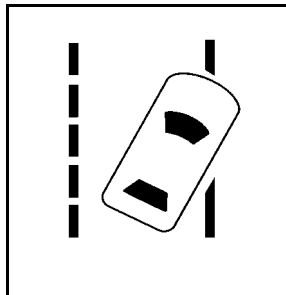

For vehicles with the lane departure warning system, this light briefly comes on green while starting the vehicle.

If it does not, have the vehicle serviced by your dealer. If the system is working normally the indicator light then goes off.

This light also comes on green if the system detects a left or right lane marking. It flashes, changes to amber, and three beeps sound, if a detected lane marking is crossed without using a turn signal. For more information, see the Index in the Navigation Manual.

Engine Coolant Temperature Warning Light

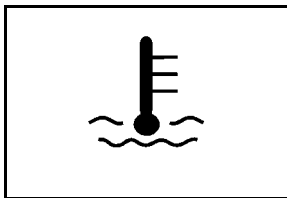

The engine coolant temperature warning light comes on when the engine is very hot.

This light also comes on briefly when the vehicle is started.

If the light does not go out or comes on and stays on while driving, there may be a problem with the cooling system. Driving with engine coolant temperature light on could cause the vehicle to overheat, see *Overheated Engine Protection Operating Mode on page 6-32*. See *Engine Overheating on page 6-29* and *DIC Warnings and Messages on page 4-66* for more information.

Engine Coolant Temperature Gauge

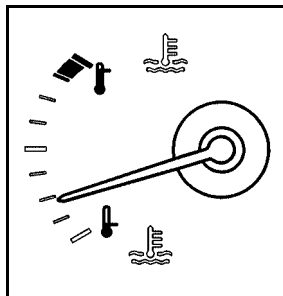

This gauge shows the engine coolant temperature.

It indicates when the engine has warmed up and if the cooling system is operating properly. If the gauge pointer moves into the shaded area, the engine coolant is too hot and the engine coolant temperature warning light comes on. See *Engine Overheating on page 6-29* for more information.

Tire Pressure Light

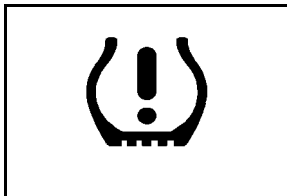

For vehicles with a tire pressure monitoring system, this light comes on briefly when the engine is started. It provides information about tire pressures and the Tire Pressure Monitoring System.

When the Light is On Steady

This indicates that one or more of the tires is significantly underinflated.

A tire pressure message in the Driver Information Center (DIC), can accompany the light. See *Driver Information Center (DIC) on page 4-61* for more information. Stop and check the tires as soon as it is safe to do so. If underinflated, inflate to the proper pressure. See *Inflation - Tire Pressure on page 6-59* for more information.

When the Light Flashes First and Then is On Steady

This indicates that there may be a problem with the Tire Pressure Monitor System. The light flashes for about a minute and stays on steady for the remainder of the ignition cycle. This sequence repeats with every ignition cycle. See *Tire Pressure Monitor Operation on page 6-63* for more information.

Malfunction Indicator Lamp

Check Engine Light

A computer system called OBD II (On-Board Diagnostics-Second Generation) monitors operation of the fuel, ignition, and emission control systems. It ensures that emissions are at acceptable levels for the life of the vehicle, helping to produce a cleaner environment.

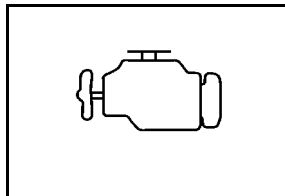

This light should come on when the ignition is on, but the engine is not running, as a check to show it is working. If it does not, have the vehicle serviced by your dealer.

If the check engine light comes on and stays on, while the engine is running, this indicates that there is an OBD II problem and service is required.

Malfunctions often are indicated by the system before any problem is apparent. Being aware of the light can prevent more serious damage to the vehicle. This system assists the service technician in correctly diagnosing any malfunction.

Notice: If the vehicle is continually driven with this light on, after a while, the emission controls might not work as well, the vehicle's fuel economy might not be as good, and the engine might not run as smoothly. This could lead to costly repairs that might not be covered by the vehicle warranty.

Notice: Modifications made to the engine, transmission, exhaust, intake, or fuel system of the vehicle or the replacement of the original tires with other than those of the same Tire Performance Criteria (TPC) can affect the vehicle's emission controls and can cause this light to come on. Modifications to these systems could lead to costly repairs not covered by the vehicle warranty. This could also result in a failure to pass a required Emission Inspection/Maintenance test. See *Accessories and Modifications on page 6-3*.

This light comes on during a malfunction in one of two ways:

Light Flashing: A misfire condition has been detected. A misfire increases vehicle emissions and could damage the emission control system on the vehicle. Diagnosis and service might be required.

To prevent more serious damage to the vehicle:

- Reduce vehicle speed.
- Avoid hard accelerations.
- Avoid steep uphill grades.
- If towing a trailer, reduce the amount of cargo being hauled as soon as it is possible.

If the light continues to flash, when it is safe to do so, stop the vehicle. Find a safe place to park the vehicle. Turn the key off, wait at least 10 seconds, and restart the engine. If the light is still flashing, follow the previous steps and see your dealer for service as soon as possible.

Light On Steady: An emission control system malfunction has been detected on the vehicle. Diagnosis and service might be required.

An emission system malfunction might be corrected by doing the following:

- Make sure the fuel cap is fully installed. See *Filling the Tank on page 6-8*. The diagnostic system can determine if the fuel cap has been left off or improperly installed. A loose or missing fuel cap allows fuel to evaporate into the atmosphere. A few driving trips with the cap properly installed should turn the light off.
- If the vehicle has been driven through a deep puddle of water, the vehicle's electrical system might be wet. The condition is usually corrected when the electrical system dries out. A few driving trips should turn the light off.

- Make sure to fuel the vehicle with quality fuel. Poor fuel quality causes the engine not to run as efficiently as designed and can cause: stalling after start-up, stalling when the vehicle is changed into gear, misfiring, hesitation on acceleration, or stumbling on acceleration. These conditions might go away once the engine is warmed up.

If one or more of these conditions occurs, change the fuel brand used. It will require at least one full tank of the proper fuel to turn the light off.

See *Gasoline Octane on page 6-5*.

If none of the above have made the light turn off, your dealer can check the vehicle. The dealer has the proper test equipment and diagnostic tools to fix any mechanical or electrical problems that might have developed.

Emissions Inspection and Maintenance Programs

Some state/provincial and local governments have or might begin programs to inspect the emission control equipment on the vehicle. Failure to pass this inspection could prevent getting a vehicle registration.

Here are some things to know to help the vehicle pass an inspection:

- The vehicle will not pass this inspection if the check engine light is on with the engine running, or if the key is in ON/RUN and the light is not on.
- The vehicle will not pass this inspection if the OBD II (on-board diagnostic) system determines that critical emission control systems have not been completely diagnosed by the system. The vehicle would be considered not ready for inspection. This can happen if the battery has recently been replaced or if the battery has run down. The diagnostic system is designed to evaluate critical emission control systems during normal driving. This can take several days of routine driving. If this has been done and the vehicle still does not pass the inspection for lack of OBD II system readiness, your dealer can prepare the vehicle for inspection.

Oil Pressure Light

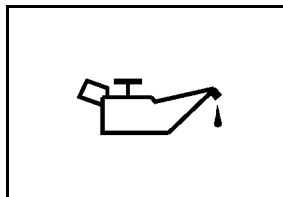

WARNING:

Do not keep driving if the oil pressure is low. The engine can become so hot that it catches fire. Someone could be burned. Check the oil as soon as possible and have the vehicle serviced.

Notice: Lack of proper engine oil maintenance can damage the engine. The repairs would not be covered by the vehicle warranty. Always follow the maintenance schedule in this manual for changing engine oil.

This light comes on briefly while starting the engine. If it does not, have the vehicle serviced by your dealer. If the system is working normally the indicator light then goes off.

If the light comes on and stays on, it means that oil is not flowing through the engine properly. The vehicle could be low on oil and it might have some other system problem.

Security Light



For information regarding this light and the vehicle's security system, see *Content Theft-Deterrent* on page 3-19.

Fog Lamp Light

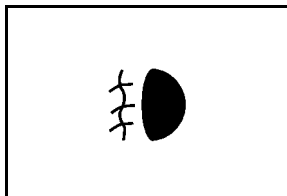

The fog lamp light comes on when the fog lamps are in use.

The light goes out when the fog lamps are turned off. See *Fog Lamps* on page 4-30 for more information.

Lights On Reminder

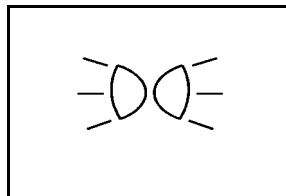

This light comes on whenever the parking lamps are on.

See *Exterior Lamps* on page 4-25 for more information.

Cruise Control Light

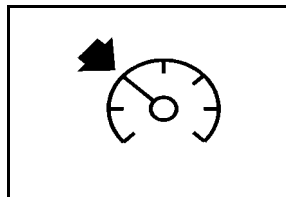

This light comes on whenever the cruise control is set.

The light goes out when the cruise control is turned off. See *Cruise Control* on page 4-11 and *Adaptive Cruise Control* on page 4-14 for more information.

Highbeam On Light

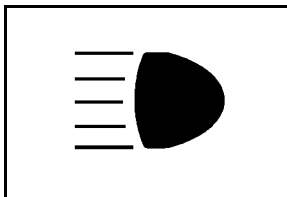

This light comes on when the high-beam headlamps are in use.

See *Headlamp High/Low-Beam Changer* on page 4-6 for more information.

Fuel Gauge

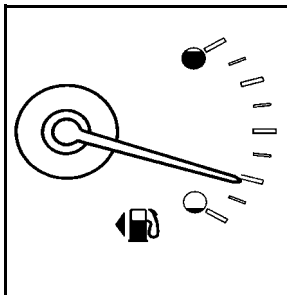

The fuel gauge shows approximately how much fuel is in the tank. It works only when the engine is on.

An arrow on the fuel gauge indicates the side of the vehicle the fuel door is on.

If the fuel supply gets low, the FUEL LEVEL LOW message appears in the Driver Information Center and a single chime sounds. See *DIC Warnings and Messages* on page 4-66 for more information.

Here are a few situations that may occur with the fuel gauge. All of these situations are normal and do not indicate that anything is wrong with the fuel gauge:

- At the gas station the gas pump shuts off before the gauge reads full.
- The gauge may change when the vehicle is turning, stops quickly or accelerates quickly.
- It takes a little more or less fuel to fill the tank than the gauge indicated. For example, the gauge may have indicated that the tank was half full, but it actually took a little more or less than half the tank's capacity to fill the tank.

Driver Information Center (DIC)

The Driver Information Center (DIC) gives you the status of many of your vehicle's systems. The DIC is also used to display warning/status messages. All messages will appear in the DIC display located at the bottom of the instrument panel cluster, below the tachometer and speedometer. The DIC buttons are located on the instrument panel, to the left of the steering wheel.

The DIC comes on when the ignition is on. After a short delay, the DIC will display the information that was last displayed before the engine was turned off.

The top line of the DIC display shows the vehicle system information and the warning/status messages. The bottom line of the DIC display shows the odometer on the left side. The bottom line of the DIC display also shows a digital speedometer on the right side.

If a problem is detected, a warning message will appear on the display. Be sure to take any message that appears on the display seriously and remember that clearing the message will only make the message disappear, not correct the problem.

DIC Operation and Displays

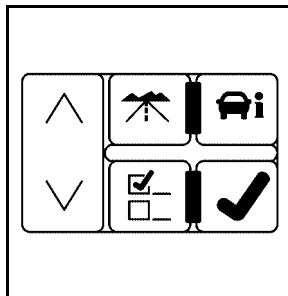

The Driver Information Center (DIC) has different displays which can be accessed by pressing the DIC buttons located on the instrument panel, to the left of the steering wheel.

 **Trip/Fuel:** Press this button to scroll through the trip and fuel displays. See "Trip/Fuel Display Menu Items" following for more information on these displays.

 **Vehicle Information:** Press this button to scroll through the vehicle information displays. See "Vehicle Information Display Menu Items" following for more information on these displays.

 **Customization:** Press this button to scroll through each of the customization features. See *DIC Vehicle Customization on page 4-79* for more information on the customization features.

✓ **Set/Reset** : Press this button to reset certain DIC features and to acknowledge DIC warning messages and clear them from the DIC display.

∧ ∨ **Menu Up/Down**: Press this button to scroll up and down the menu items.

Trip/Fuel Display Menu Items

 **(Trip/Fuel)**: The following display menu items can be displayed by pressing the trip/fuel button:

TRIP A or TRIP B

These displays show the current distance traveled since the last reset for each trip odometer in either kilometers (km) or miles (mi). Both odometers can be used at the same time. Each trip odometer can be reset to zero separately by pressing and holding the set/reset button for a few seconds while the desired trip odometer is displayed.

FUEL RANGE

This display shows the approximate number of remaining kilometers (km) or miles (mi) you can drive without refilling the fuel tank. This estimate is based on the current driving conditions and will change if the driving conditions change. For example, if you are driving in traffic and making frequent stops, the display may read one number, but if you enter the freeway, the number may change even though you still have the same amount of fuel in the fuel tank. This is because different driving conditions produce different fuel economies. Generally, freeway driving produces better fuel economy than city driving.

Once the range drops below an estimated 64 km (40 miles) remaining, the display will show FUEL RANGE LOW.

If your vehicle is low on fuel, the FUEL LEVEL LOW message will be displayed. See “FUEL LEVEL LOW” under *DIC Warnings and Messages on page 4-66* for more information.

AVERAGE ECONOMY (AFE)

This display shows the approximate average liters per 100 kilometers (L/100 km) or miles per gallon (mpg). This number is calculated based on the number of L/100 km (mpg) recorded since the last time this display was reset. To reset this display, press the set/reset button. The display will return to zero.

INST (Instantaneous) ECONOMY (IFE)

This display shows the current fuel economy in either liters per 100 kilometers (L/100 km) or miles per gallon (mpg). This number reflects only the fuel economy that the vehicle has right now and will change frequently as driving conditions change. Unlike average economy, this display cannot be reset.

FUEL USED

This display shows the number of liters (L) or gallons (gal) of fuel used since the last reset of this display. To reset this display, press the set/reset button. The display will return to zero.

TIMER ON/OFF

This display can be used like a stopwatch. You can record the time it takes to travel from one point to another. To access the timer, press the trip/fuel button until 00:00:00 TIMER OFF displays.

To turn on the timer, press the set/reset button until TIMER ON displays. The timer will then start.

To turn off the timer, press the set/reset button again until TIMER OFF displays. The timer will stop and display the end timing value.

To reset the timer, press and hold the set/reset button after the timer has been stopped. The display will return to zero.

AVERAGE SPEED

This display shows the average speed of the vehicle in either kilometers per hour (km/h) or miles per hour (mph). This average is calculated based on the various vehicle speeds recorded since the last reset of this display. To reset this display, press the set/reset button. The display will return to zero.

BATTERY VOLTAGE

This display shows the current battery voltage. If the voltage is in the normal range, the value will display. For example, the display may read BATTERY VOLTAGE 13.2 VOLTS. If the voltage is low, the display will show LOW. If the voltage is high, the display will show HIGH. Your vehicle's charging system regulates voltage based on the state of the battery. The battery voltage may fluctuate when viewing this information on the DIC. This is normal. See *Charging System Light on page 4-50* for more information.

If there is a problem with the battery charging system, the DIC will display a message. See *DIC Warnings and Messages on page 4-66* and *Electric Power Management on page 4-32* for more information.

Blank Display

This display shows no information.

Vehicle Information Display Menu Items

 **(Vehicle Information):** The following display menu items can be displayed by pressing the vehicle information button:

OIL LIFE REMAINING

If the vehicle has this display, it shows the estimated oil life remaining. If you see 99% OIL LIFE REMAINING on the display, that means that 99% of the current oil life remains.

When the oil life is depleted, the CHANGE ENGINE OIL SOON message will appear on the display. You should change the oil as soon as possible. In addition to the engine oil life system monitoring the oil life, additional maintenance is recommended in the Maintenance Schedule in this manual. See *Scheduled Maintenance on page 7-3* and *Engine Oil on page 6-15*.

Remember, you must reset the OIL LIFE yourself after each oil change. It will not reset itself. Also, be careful not to reset the OIL LIFE accidentally at any time other than when the oil has just been changed. It cannot be reset accurately until the next oil change. To reset the engine oil life system, See *Engine Oil Life System on page 6-18*. The display will show 100% when the system is reset.

UNITS

This display allows you to select between English or Metric units of measurement. Once in this display, press the set/reset button to select between ENGLISH or METRIC units.

PARKING ASSIST

If your vehicle has the Ultrasonic Front and Rear Parking Assist (UFRPA) system, this display allows the system to be turned on or off. Once in this display, press the set/reset button to select between ON or OFF. If you choose ON, the system will be turned on. If you choose OFF, the system will be turned off. The UFRPA system automatically turns back on after each vehicle start. When the UFRPA system is turned off and the vehicle is shifted out of P (Park), the DIC will display the PARKING ASSIST OFF message as a reminder that the system has been turned off. See *DIC Warnings and Messages on page 4-66* and *Ultrasonic Front and Rear Parking Assist (UFRPA) on page 3-40* for more information.

SIDE BLIND ZONE ALERT

If your vehicle has the Side Blind Zone Alert (SBZA) system, this display allows the system to be turned on or off. Once in this display, press the set/reset button to select between ON or OFF. If you choose ON, the system will be turned on. If you choose OFF, the system will be turned off. When the SBZA system is turned off, the DIC will display the SIDE BLIND ZONE ALERT SYSTEM OFF message as a reminder that the system has been turned off. See *DIC Warnings and Messages on page 4-66* and *Side Blind Zone Alert (SBZA) on page 3-43* for more information.

FRONT TIRES or REAR TIRES

On vehicles with the Tire Pressure Monitor System (TPMS), the pressure for each tire can be viewed in the DIC. The tire pressure will be shown in either pounds per square inch (psi) or kilopascals (kPa). Press the vehicle information button until the DIC displays FRONT TIRES PSI (kPa) LEFT ## RIGHT ##. Press the vehicle information button again until the DIC displays REAR TIRES PSI (kPa) LEFT ## RIGHT ##.

If a low tire pressure condition is detected by the system while driving, a message advising you to add air to a specific tire will appear in the display. See *Inflation - Tire Pressure on page 6-59* and *DIC Warnings and Messages on page 4-66* for more information.

If the tire pressure display shows dashes instead of a value, there may be a problem with your vehicle. If this consistently occurs, see your dealer for service.

SPEED LIMIT: XXX MPH (SPEED LIMIT: XXX Km/h) or ADVISORY: XXX MPH (ADVISORY: XXX Km/h)

This display will show the speed limit or the advised speed as determined by the information on the map disc in the navigation system. If there is no map disc in the navigation system, this display will not be available.

The speed limit and speed advisory displays on the DIC are for reference only. There may be segments of road where speed data has not been captured or times where incorrect speed data, or no speed data, will be displayed by the DIC due to the navigation system not correctly matching the vehicle's position to the actual road. Be aware of this and obey posted speed limits wherever you drive.

SPEED ALERT

This display will allow you to customize the speed alert warning. You can choose to have no warning display, or to have it display at the limit, at 5 km/h (mph) over the limit, or at 10 km/h (mph) over the limit. The DIC will toggle between OFF, AT LIMIT, +5 , +10 (Km/h or MPH). Press the reset button to make your selection.

RELEARN REMOTE KEY

This display allows you to match Remote Keyless Entry (RKE) transmitters to your vehicle. This procedure will erase all previously learned transmitters. Therefore, they must be relearned as additional transmitters.

To match an RKE transmitter to your vehicle:

1. Press the vehicle information button until PRESS ✓ TO RELEARN REMOTE KEY displays.
2. Press the set/reset button until REMOTE KEY LEARNING ACTIVE is displayed.
3. Press and hold the lock and unlock buttons on the first transmitter at the same time for about 15 seconds.

On vehicles with memory recall seats, the first transmitter learned will match driver 1 and the second will match driver 2.

A chime will sound indicating that the transmitter is matched.

4. To match additional transmitters at this time, repeat Step 3.

Each vehicle can have a maximum of eight transmitters matched to it.

5. To exit the programming mode, you must cycle the key to LOCK/OFF.

Blank Display

This display shows no information.

DIC Warnings and Messages

These messages appear if there is a problem detected in one of your vehicle's systems.

You must acknowledge a message to clear it from the screen for further use. To clear a message, press the set/reset button.

Be sure to take any message that appears on the screen seriously and remember that clearing the message will only make the message disappear, not the problem.

ADVISORY XXX MPH (km/h)

This message displays when the Speed Alert has been turned on through the DIC Information Menu and the vehicle is at or above the advised speed. See *DIC Operation and Displays on page 4-61*.

AUTOMATIC LIGHT CONTROL OFF

This message displays when the automatic headlamps are turned off. See *Exterior Lamps on page 4-25* for more information.

AUTOMATIC LIGHT CONTROL ON

This message displays when the automatic headlamps are turned on. See *Exterior Lamps on page 4-25* for more information.

BATTERY SAVER ACTIVE

This message displays when the system detects that the battery voltage is dropping beyond a reasonable level. The battery saver system starts reducing certain features of the vehicle that you may be able to notice. At the point that the features are disabled, this message is displayed. It means that the vehicle is trying to save the charge in the battery.

Turn off all unnecessary accessories to allow the battery to recharge.

The normal battery voltage range is 11.5 to 15.5 volts. You can monitor battery voltage on the Driver Information Center (DIC) by pressing the trip/fuel button until BATTERY VOLTAGE is displayed.

CHANGE ENGINE OIL SOON

This message displays when service is required for your vehicle. See your dealer. See *Engine Oil on page 6-15* and *Scheduled Maintenance on page 7-3* for more information.

When you reset the CHANGE ENGINE OIL SOON message by clearing it from the display, you still must reset the engine oil life system separately. For more information on resetting the engine oil life system, see *Engine Oil Life System on page 6-18*.

CHECK TIRE PRESSURE or ADD AIR TO TIRE

On vehicles with the Tire Pressure Monitor System (TPMS), this message displays when the pressure in one or more of the vehicle's tires is low. This message also displays LEFT FRONT, RIGHT FRONT, LEFT REAR, or RIGHT REAR to indicate which tire needs to be checked. The low tire pressure warning light will also come on. See *Tire Pressure Light on page 4-55*. If a tire pressure message appears on the DIC, stop as soon as you can. Have the tire pressures checked and set to those shown on the Tire Loading Information label. See *Tires on page 6-50*, *Loading the Vehicle on page 5-18*, and *Inflation - Tire Pressure on page 6-59*. You can receive more than one tire pressure message at a time. To read the other messages that may have been sent at the same time, press the set/reset button. The DIC also shows the tire pressure values. See *DIC Operation and Displays on page 4-61*.

CLEAN RADAR

This message displays when the Adaptive Cruise Control (ACC) system and the Forward Collision Alert (FCA) system are disabled because the radar is blocked and cannot detect vehicles in your path. It may also activate during heavy rain or due to road spray. To clean the system, see “Cleaning the System” under *Adaptive Cruise Control on page 4-14*.

CRUISE SET TO XXX MPH (km/h)

This message displays whenever the cruise control is set. See *Cruise Control on page 4-11* and *Adaptive Cruise Control on page 4-14* for more information.

If your vehicle has Adaptive Cruise Control (ACC), after a few seconds, this message clears and the message “SET SPD XX” displays at the bottom of the DIC. See “SET SPD (Speed)” later in this section.

DRIVER DOOR OPEN

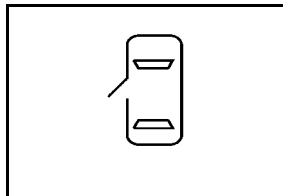

This symbol appears with this message.

This message displays when the driver door is not closed completely. Make sure that the door is closed completely.

ENGINE HOT – A/C (Air Conditioning) OFF

This message displays when the engine coolant becomes hotter than the normal operating temperature. See *Engine Coolant Temperature Gauge on page 4-54*. To avoid added strain on a hot engine, the air conditioning compressor automatically turns off. When the coolant temperature returns to normal, the air conditioning compressor turns back on. You can continue to drive your vehicle.

If this message continues to appear, have the system repaired by your dealer as soon as possible to avoid damage to the engine.

ENGINE OVERHEATED IDLE ENGINE

Notice: If you drive your vehicle while the engine is overheating, severe engine damage may occur. If an overheat warning appears on the instrument panel cluster and/or DIC, stop the vehicle as soon as possible. Do not increase the engine speed above normal idling speed. See *Engine Overheating on page 6-29* for more information.

This message displays when the engine coolant temperature is too hot. Stop and allow the vehicle to idle until it cools down. See *Engine Coolant Temperature Warning Light on page 4-54*.

See *Overheated Engine Protection Operating Mode on page 6-32* for information on driving to a safe place in an emergency.

ENGINE OVERHEATED STOP ENGINE

Notice: If you drive your vehicle while the engine is overheating, severe engine damage may occur. If an overheat warning appears on the instrument panel cluster and/or DIC, stop the vehicle as soon as possible. See *Engine Overheating on page 6-29* for more information.

This message displays when the engine has overheated. Immediately look for a safe place to pull your vehicle over and turn the engine off right away to avoid severe engine damage. See *Engine Overheating on page 6-29* and *Overheated Engine Protection Operating Mode on page 6-32*. A chime also sounds when this message is displayed.

ENGINE POWER REDUCED

This message displays when the engine power is being reduced to protect the engine from damage. There could be several malfunctions that might cause this message. Reduced engine power can affect the vehicle's ability to accelerate. If this message is on, but there is no reduction in performance, proceed to your destination. The performance may be reduced the next time the vehicle is driven. The vehicle may be driven at a reduced speed while this message is on, but acceleration and speed may be reduced. Anytime this message stays on, the vehicle should be taken to your dealer for service as soon as possible.

FOLLOWING GAP

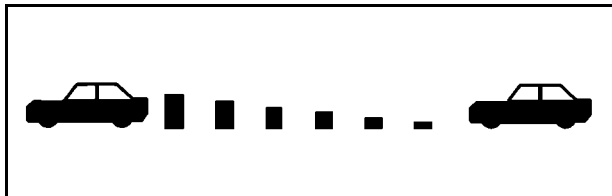

This symbol appears with this message.

If your vehicle has Adaptive Cruise Control (ACC), this message displays to show the follow distance that has been set. There are six follow distances to choose from. Each follow distance is shown on the DIC by displaying from one to six bars between two car symbols. See *Adaptive Cruise Control on page 4-14* for more information.

FUEL LEVEL LOW

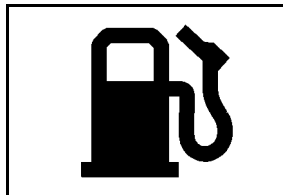

This symbol appears with this message.

This message displays when your vehicle is low on fuel. Refill the fuel tank as soon as possible. A single chime sounds when this message is displayed. See *Filling the Tank on page 6-8*.

HOOD OPEN



This symbol appears with this message.

This message displays when the hood is not closed completely. Make sure that the hood is closed completely. See *Hood Release on page 6-13*.

ICE POSSIBLE DRIVE WITH CARE

This message displays when the outside temperature is cold enough to create icy road conditions. Adjust your driving accordingly.

LANE DEPARTURE SYSTEM UNAVAILABLE

If your vehicle has the Lane Departure Warning (LDW) system, this message may display if the LDW system does not activate due to a temporary condition. See *Lane Departure Warning (LDW)* on page 3-46 for more information.

LEFT REAR DOOR OPEN

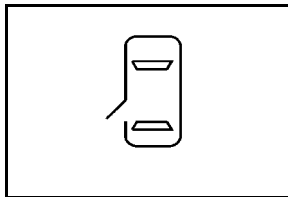

This symbol appears with this message.

This message displays when the driver side rear door is not closed completely. Make sure that the door is closed completely.

NO CRUISE BRAKING GAS PEDAL APPLIED

This message displays when the Adaptive Cruise Control (ACC) is engaged and you are pressing the accelerator pedal enough to disable ACC automatic braking. See *Adaptive Cruise Control* on page 4-14 for more information.

OIL PRESSURE LOW STOP ENGINE

Notice: If you drive your vehicle while the engine oil pressure is low, severe engine damage may occur. If a low oil pressure warning appears on the instrument panel cluster and/or DIC, stop the vehicle as soon as possible. Do not drive the vehicle until the cause of the low oil pressure is corrected. See *Engine Oil* on page 6-15 for more information.

This message displays when the vehicle's engine oil pressure is low. The oil pressure light also appears on the instrument panel cluster. See *Oil Pressure Light* on page 4-58.

A multiple chime sounds when this message is displayed. See *Engine Oil on page 6-15* for more information.

Stop the vehicle immediately, as engine damage can result from driving a vehicle with low oil pressure. Have the vehicle serviced by your dealer as soon as possible when this message is displayed.

PARKING ASSIST OFF

If your vehicle has the Ultrasonic Front and Rear Parking Assist (UFRPA) system, after the vehicle is shifted out of P (Park), this message displays to remind the driver that the UFRPA system has been turned off. Press the set/reset button to acknowledge this message and clear it from the DIC display. To turn the UFRPA system back on, see "PARKING ASSIST" under *DIC Operation and Displays on page 4-61*. See *Ultrasonic Front and Rear Parking Assist (UFRPA) on page 3-40* for more information.

PASSENGER DOOR OPEN

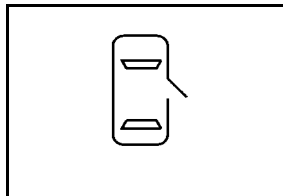

This symbol appears with this message.

This message displays when the passenger side front door is not closed completely. Make sure that the door is closed completely.

RADAR CRUISE NOT READY

This message displays when the Adaptive Cruise Control (ACC) system will not activate due to a temporary condition. Your vehicle does not require service. If this message appears when you attempt to activate the system, continue driving for several minutes and then try activating the system again. See *Adaptive Cruise Control on page 4-14* for more information.

REMOTE KEY LEARNING ACTIVE

This message displays while you are matching a Remote Keyless Entry (RKE) transmitter to your vehicle. See "Matching Transmitter(s) to Your Vehicle" under *Remote Keyless Entry (RKE) System Operation on page 3-4* and *DIC Operation and Displays on page 4-61* for more information.

REPLACE BATTERY IN REMOTE KEY

This message displays when the battery in the Remote Keyless Entry (RKE) transmitter needs to be replaced. To replace the battery, see "Battery Replacement" under *Remote Keyless Entry (RKE) System Operation on page 3-4*.

RIGHT REAR DOOR OPEN

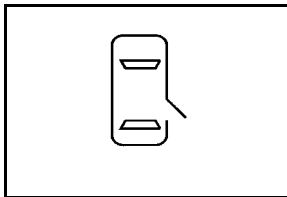

This symbol appears with this message.

This message displays when the passenger side rear door is not closed completely. Make sure that the door is closed completely.

SERVICE AIR BAG

This message displays when there is a problem with the airbag system. Have your vehicle serviced by your dealer immediately. See *Airbag Readiness Light on page 4-48* for more information.

SERVICE A/C SYSTEM

This message displays when the air delivery mode door or the electronic sensors that control the air conditioning and heating systems are no longer working. Have the climate control system serviced by your dealer if you notice a drop in heating and air conditioning efficiency.

SERVICE BATTERY CHARGING SYSTEM

This message displays when a problem with the charging system has been detected. The charging system light also displays on the instrument panel cluster. See *Charging System Light on page 4-50* for more information. Have your vehicle serviced by your dealer.

SERVICE BRAKE ASSIST

This message displays if there is a problem with the brake system. The brake system warning light and the antilock brake system warning light may also be displayed on the instrument panel cluster. See *Brake System Warning Light on page 4-51* and *Antilock Brake System (ABS) Warning Light on page 4-52* for more information. If this happens, stop as soon as possible and turn off the vehicle. Restart the vehicle and check for the message on the DIC display. If the message is displayed or appears again when you begin driving, the brake system needs service. See your dealer as soon as possible. See *Brakes on page 6-35* for more information.

SERVICE BRAKE SYSTEM

This message displays if the ignition is on to inform the driver that the brake fluid level is low. Have the brake system serviced by your dealer as soon as possible.

SERVICE LANE DEPARTURE SYSTEM

If your vehicle has the Lane Departure Warning (LDW) system, this message may display to indicate that the LDW system is not working properly. If this message remains on after continued driving, the system needs service. See your dealer. See *Lane Departure Warning (LDW) on page 3-46* for more information.

SERVICE PARKING ASSIST

If your vehicle has the Ultrasonic Front and Rear Parking Assist (UFRPA) system, this message displays if there is a problem with the UFRPA system. Do not use this system to help you park. See *Ultrasonic Front and Rear Parking Assist (UFRPA) on page 3-40* for more information. See your dealer for service.

SERVICE POWER STEERING

Your vehicle may have a speed variable assist steering system. See *Steering on page 5-8*.

This message displays if a problem is detected with the speed variable assist steering system. When this message is displayed, you may notice that the effort required to steer the vehicle decreases or feels lighter, but you will still be able to steer the vehicle.

SERVICE RADAR CRUISE

This message displays when the Adaptive Cruise Control (ACC) system and the Forward Collision Alert (FCA) system are disabled and need service. See your dealer.

SERVICE SIDE BLIND ZONE ALERT SYSTEM

If your vehicle has the Side Blind Zone Alert (SBZA) system and this message displays, both SBZA displays will remain on indicating there is a problem with the SBZA system. If these displays remain on after continued driving, the system needs service. See your dealer. See *Side Blind Zone Alert (SBZA) on page 3-43* for more information.

SERVICE STABILITRAK

Your vehicle may have a vehicle stability enhancement system called StabiliTrak[®]. See *StabiliTrak[®] System on page 5-5*.

This message displays if there has been a problem detected with the StabiliTrak system.

If this message comes on while you are driving, pull off the road as soon as possible and stop carefully. Try resetting the system by turning the ignition off then back on. If this message still stays on or comes back on again while you are driving, your vehicle needs service. Have the StabiliTrak system inspected by your dealer as soon as possible.

SERVICE SUSPENSION SYS (System)

This message displays when the magnetic ride control or automatic leveling control system is not operating properly. Have your vehicle serviced by your dealer.

SERVICE THEFT DETERRENT SYSTEM

This message displays when there is a problem with the theft-deterrent system programmed in the key. A fault has been detected in the system which means that the system is disabled and it is not protecting the vehicle. The vehicle usually restarts; however, you may want to take the vehicle to your dealer before turning off the engine. See *PASS-Key[®] III+ Electronic Immobilizer Operation on page 3-21* for more information.

SERVICE TIRE MONITOR SYSTEM

On vehicles with the Tire Pressure Monitor System (TPMS), this message displays if a part on the TPMS is not working properly. The tire pressure light also flashes and then remains on during the same ignition cycle. See *Tire Pressure Light on page 4-55*. Several conditions may cause this message to appear. See *Tire Pressure Monitor Operation on page 6-63* for more information. If the warning comes on and stays on, there may be a problem with the TPMS, see your dealer.

SERVICE TRACTION CONTROL

This message displays when there is a problem with the Traction Control System (TCS). When this message is displayed, the system will not limit wheel spin. Adjust your driving accordingly. See your dealer for service. See *Traction Control System (TCS) on page 5-6* for more information.

SERVICE TRANSMISSION

This message displays when there is a problem with the vehicle's transmission. Have your vehicle serviced by your dealer.

SERVICE VEHICLE SOON

This message displays when a non-emissions related malfunction occurs. Have your vehicle serviced by your dealer as soon as possible.

SET SPD (Speed)

If your vehicle has Adaptive Cruise Control (ACC), this message displays whenever the cruise control is set. First, the "CRUISE SET TO XXX MPH (km/h)" message appears. After a few seconds, the "CRUISE SET TO XXX MPH (km/h)" message clears and the message "SET SPD XX" displays at the bottom of the DIC. See "CRUISE SET TO XXX MPH (km/h)" earlier in this section and *Adaptive Cruise Control on page 4-14* for more information.

SIDE BLIND ZONE ALERT SYSTEM OFF

If your vehicle has the Side Blind Zone Alert (SBZA) system, this message displays when the SBZA system has been turned off. See *Side Blind Zone Alert (SBZA) on page 3-43* and *DIC Operation and Displays on page 4-61* for more information.

SIDE BLIND ZONE SYSTEM UNAVAILABLE

If your vehicle has the Side Blind Zone Alert (SBZA) system, this message displays when the SBZA system is disabled because the sensor is blocked and cannot detect vehicles in your blind zone. The sensor may be blocked by mud, dirt, snow, ice, or slush. This message may also display during heavy rain or due to road spray. It may also come on when driving in isolated areas with no guardrails, trees, or road signs and light traffic. Your vehicle does not need service. For cleaning instructions, see *Washing Your Vehicle on page 6-100*. See *Side Blind Zone Alert (SBZA) on page 3-43* for more information.

SPEED LIMIT XXX MPH (km/h)

This message displays when the Speed Alert has been turned on through the DIC Information Menu and the vehicle is at or above the speed limit. See *DIC Operation and Displays on page 4-61* for more information.

SPEED LIMITED TO XXX MPH (km/h)

This message displays when your vehicle speed is limited to 128 km/h (80 mph) because the vehicle detects a problem in the speed variable assist steering, magnetic ride control, or automatic leveling control systems. Have your vehicle serviced by your dealer.

STABILITRAK NOT READY

If your vehicle has StabiliTrak, this message may display and the Traction Control System and StabiliTrak Warning Light on the instrument panel cluster may be on after first driving the vehicle and exceeding 30 km/h (19 mph) for 30 seconds. The StabiliTrak system is not functional until the light has turned off. See *StabiliTrak® System on page 5-5* for more information.

STARTING DISABLED SERVICE THROTTLE

This message displays when your vehicle's throttle system is not functioning properly. Have your vehicle serviced by your dealer.

THEFT ATTEMPTED

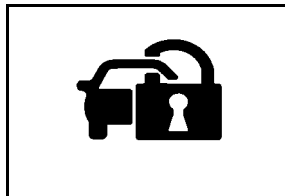

This symbol appears with this message.

This message displays if the content theft-deterrent system has detected a break-in attempt while you were away from your vehicle. See *Content Theft-Deterrent on page 3-19* for more information.

TIGHTEN GAS CAP

This message displays when the fuel cap has not been fully tightened. Recheck the fuel cap to ensure that it is on and tightened properly.

TIRE LEARNING ACTIVE

This message displays when the Tire Pressure Monitor System (TPMS) is re-learning the tire positions on your vehicle. The tire positions must be re-learned after rotating the tires or after replacing a tire or sensor. See *Tire Inspection and Rotation on page 6-67*, *Tire Pressure Monitor System on page 6-62*, and *Inflation - Tire Pressure on page 6-59* for more information.

TRACTION CONTROL OFF

This message displays when the Traction Control System (TCS) is turned off. Adjust your driving accordingly. See *Traction Control System (TCS) on page 5-6* for more information.

TRACTION CONTROL ON

This message displays when the Traction Control System (TCS) is turned on. See *Traction Control System (TCS) on page 5-6* for more information.

TRANSMISSION HOT IDLE ENGINE

Notice: If you drive your vehicle while the transmission fluid is overheating and the transmission temperature warning is displayed on the instrument panel cluster and/or DIC, you can damage the transmission. This could lead to costly repairs that would not be covered by your warranty. Do not drive your vehicle with overheated transmission fluid or while the transmission temperature warning is displayed.

This message displays when the transmission fluid in your vehicle is too hot. Stop the vehicle and allow it to idle until the transmission cools down or until this message is removed.

TRUNK OPEN

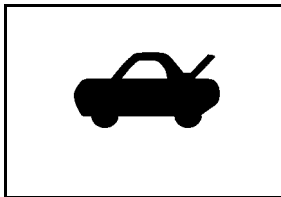

This symbol appears with this message.

This message displays when the trunk is not closed completely. Make sure that the trunk is closed completely.

TURN SIGNAL ON

This message displays as a reminder to turn off the turn signal if you drive your vehicle for more than about 1 mile (1.6 km) with a turn signal on. A multiple chime sounds when this message is displayed.

WASHER FLUID LOW ADD FLUID

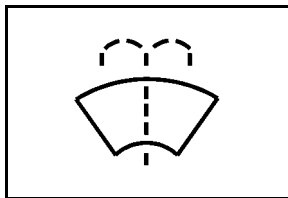

This symbol appears with this message.

This message displays when your vehicle is low on windshield washer fluid. Refill the windshield washer fluid reservoir as soon as possible. See *Windshield Washer Fluid on page 6-33* for more information.

DIC Vehicle Customization

Your vehicle has customization capabilities that allow you to program certain features to one preferred setting. Customization features can only be programmed to one setting on the vehicle and cannot be programmed to a preferred setting for two different drivers.

All of the customization options may not be available on your vehicle. Only the options available will be displayed on the DIC.

The default settings for the customization features were set when your vehicle left the factory, but may have been changed from their default state since then.

The customization preferences are automatically recalled.

To change customization preferences, use the following procedure.

Entering the Feature Settings Menu

1. Turn the ignition on and place the vehicle in P (Park).
To avoid excessive drain on the battery, it is recommended that the headlamps are turned off.
2. Press the customization button to enter the feature settings menu.

If the menu is not available, FEATURE SETTINGS AVAILABLE IN PARK will display. Before entering the menu, make sure the vehicle is in P (Park).

Feature Settings Menu Items

The following are customization features that allow you to program settings to the vehicle:

DISPLAY IN ENGLISH

This feature will only display if a language other than English has been set. This feature allows you to change the language in which the DIC messages appear to English.

Press the customization button until the PRESS ✓ TO DISPLAY IN ENGLISH screen appears on the DIC display. Press the set/reset button once to display all DIC messages in English.

DISPLAY LANGUAGE

This feature allows you to select the language in which the DIC messages will appear.

Press the customization button until the DISPLAY LANGUAGE screen appears on the DIC display. Press the set/reset button once to access the settings for this feature. Then press the menu up/down button to scroll through the following settings:

ENGLISH (default): All messages will appear in English.

DEUTSCH: All messages will appear in German.

FRANCAIS: All messages will appear in French.

ESPANOL: All messages will appear in Spanish.

JAPANESE: All messages will appear in Japanese.

ARABIC: All messages will appear in Arabic.

NO CHANGE: No change will be made to this feature. The current setting will remain.

To select a setting, press the set/reset button while the desired setting is displayed on the DIC.

AUTO DOOR LOCK

This feature allows you to select when the vehicle's doors will automatically lock. See *Programmable Automatic Door Locks* on page 3-10 for more information.

Press the customization button until AUTO DOOR LOCK appears on the DIC display. Press the set/reset button once to access the settings for this feature. Then press the menu up/down button to scroll through the following settings:

SHIFT OUT OF PARK (default): The doors automatically lock when the doors are closed and the vehicle is shifted out of P (Park).

AT VEHICLE SPEED: The doors automatically lock when the vehicle speed is above 5 mph (8 km/h) for three seconds.

NO CHANGE: No change will be made to this feature. The current setting will remain.

To select a setting, press the set/reset button while the desired setting is displayed on the DIC.

AUTO DOOR UNLOCK

This feature allows you to select whether or not to turn off the automatic door unlocking feature. It also allows you to select which doors and when the doors will automatically unlock. See *Programmable Automatic Door Locks* on page 3-10 for more information.

Press the customization button until AUTO DOOR UNLOCK appears on the DIC display. Press the set/reset button once to access the settings for this feature. Then press the menu up/down button to scroll through the following settings:

OFF: None of the doors will automatically unlock.

DRIVER AT KEY OUT: Only the driver's door will unlock when the key is taken out of the ignition.

DRIVER IN PARK: Only the driver's door will unlock when the vehicle is shifted into P (Park).

ALL AT KEY OUT: All of the doors will unlock when the key is taken out of the ignition.

ALL IN PARK (default): All of the doors will unlock when the vehicle is shifted into P (Park).

NO CHANGE: No change will be made to this feature. The current setting will remain.

To select a setting, press the set/reset button while the desired setting is displayed on the DIC.

REMOTE DOOR LOCK

This feature allows you to select the type of feedback you will receive when locking the vehicle with the Remote Keyless Entry (RKE) transmitter. You will not receive feedback when locking the vehicle with the RKE transmitter if the doors are open. See *Remote Keyless Entry (RKE) System Operation on page 3-4* for more information.

Press the customization button until REMOTE DOOR LOCK appears on the DIC display. Press the set/reset button once to access the settings for this feature. Then press the menu up/down button to scroll through the following settings:

OFF: There will be no feedback when you press the lock button on the RKE transmitter.

LIGHTS ONLY: The exterior lamps will flash when you press the lock button on the RKE transmitter.

HORN ONLY: The horn will sound on the second press of the lock button on the RKE transmitter.

HORN & LIGHTS (default): The exterior lamps will flash when you press the lock button on the RKE transmitter, and the horn will sound when the lock button is pressed again within five seconds of the previous command.

NO CHANGE: No change will be made to this feature. The current setting will remain.

To select a setting, press the set/reset button while the desired setting is displayed on the DIC.

REMOTE DOOR UNLOCK

This feature allows you to select the type of feedback you will receive when unlocking the vehicle with the Remote Keyless Entry (RKE) transmitter. You will not receive feedback when unlocking the vehicle with the RKE transmitter if the doors are open. See *Remote Keyless Entry (RKE) System Operation on page 3-4* for more information.

Press the customization button until REMOTE DOOR UNLOCK appears on the DIC display. Press the set/reset button once to access the settings for this feature. Then press the menu up/down button to scroll through the following settings:

LIGHTS OFF: The exterior lamps will not flash when you press the unlock button on the RKE transmitter.

LIGHTS ON (default): The exterior lamps will flash when you press the unlock button on the RKE transmitter.

NO CHANGE: No change will be made to this feature. The current setting will remain.

To select a setting, press the set/reset button while the desired setting is displayed on the DIC.

DELAY DOOR LOCK

This feature allows you to select whether or not the locking of the vehicle's doors will be delayed. When locking the doors with the power door lock switch and a door is open, this feature will delay locking the doors until five seconds after the last door is closed. You will hear three chimes to signal that the delayed locking feature is in use. The key must be out of the ignition for this feature to work. You can temporarily override delayed locking by pressing the power door lock switch twice or the lock button on the RKE transmitter twice.

Press the customization button until DELAY DOOR LOCK appears on the DIC display. Press the set/reset button once to access the settings for this feature. Then press the menu up/down button to scroll through the following settings:

OFF: There will be no delayed locking of the vehicle's doors.

ON (default): The doors will not lock until five seconds after the last door is closed.

NO CHANGE: No change will be made to this feature. The current setting will remain.

To select a setting, press the set/reset button while the desired setting is displayed on the DIC.

EXIT LIGHTING

This feature allows you to select the amount of time you want the exterior lamps to remain on when it is dark enough outside. This happens after the key is turned from ON/RUN to LOCK/OFF.

Press the customization button until EXIT LIGHTING appears on the DIC display. Press the set/reset button once to access the settings for this feature. Then press the menu up/down button to scroll through the following settings:

OFF: The exterior lamps will not turn on.

30 SECONDS (default): The exterior lamps will stay on for 30 seconds.

1 MINUTE: The exterior lamps will stay on for one minute.

2 MINUTES: The exterior lamps will stay on for two minutes.

NO CHANGE: No change will be made to this feature. The current setting will remain.

To select a setting, press the set/reset button while the desired setting is displayed on the DIC.

APPROACH LIGHTING

This feature allows you to select whether or not to have the exterior lights turn on briefly during low light periods after unlocking the vehicle using the Remote Keyless Entry (RKE) transmitter.

Press the customization button until APPROACH LIGHTING appears on the DIC display. Press the set/reset button once to access the settings for this feature. Then press the menu up/down button to scroll through the following settings:

OFF: The exterior lights will not turn on when you unlock the vehicle with the RKE transmitter.

ON (default): If it is dark enough outside, the exterior lights will turn on briefly when you unlock the vehicle with the RKE transmitter.

The lights will remain on for 20 seconds or until the lock button on the RKE transmitter is pressed, or the vehicle is no longer off. See *Remote Keyless Entry (RKE) System Operation on page 3-4* for more information.

NO CHANGE: No change will be made to this feature. The current setting will remain.

To select a setting, press the set/reset button while the desired setting is displayed on the DIC.

CHIME VOLUME

This feature allows you to select the volume level of the chime.

Press the customization button until CHIME VOLUME appears on the DIC display. Press the set/reset button once to access the settings for this feature. Then press the menu up/down button to scroll through the following settings:

NORMAL: The chime volume will be set to a normal level.

LOUD: The chime volume will be set to a loud level.

NO CHANGE: No change will be made to this feature. The current setting will remain.

There is no default for chime volume. The volume will stay at the last known setting.

To select a setting, press the set/reset button while the desired setting is displayed on the DIC.

PARK TILT MIRRORS

If your vehicle has this feature, it allows you to select whether or not the outside mirror(s) will automatically tilt down when the vehicle is shifted into R (Reverse). See *Park Tilt Mirrors* on page 3-39 for more information.

Press the customization button until PARK TILT MIRRORS appears on the DIC display. Press the set/reset button once to access the settings for this feature. Then press the menu up/down button to scroll through the following settings:

OFF (default): Neither outside mirror will be tilted down when the vehicle is shifted into R (Reverse).

DRIVER MIRROR: The driver's outside mirror will be tilted down when the vehicle is shifted into R (Reverse).

PASSENGER MIRROR: The passenger's outside mirror will be tilted down when the vehicle is shifted into R (Reverse).

BOTH MIRRORS: The driver's and passenger's outside mirrors will be tilted down when the vehicle is shifted into R (Reverse).

NO CHANGE: No change will be made to this feature. The current setting will remain.

To select a setting, press the set/reset button while the desired setting is displayed on the DIC.

EASY EXIT RECALL

If your vehicle has this feature, it allows you to select your preference for the automatic easy exit seat feature. See *Memory Seat, Mirrors and Steering Wheel* on page 2-6 for more information.

Press the customization button until EASY EXIT RECALL appears on the DIC display. Press the set/reset button once to access the settings for this feature. Then press the menu up/down button to scroll through the following settings:

DOOR BUTTON ONLY: No automatic seat exit recall will occur. The recall will only occur after pressing the easy exit seat button.

BUTTON AND KEY OUT (default): If the features are enabled through the EASY EXIT SETUP menu, the driver's seat will move back, and if the vehicle has the power tilt wheel and telescopic steering feature, the power steering column will move up and forward when the key is removed from the ignition or after pressing the easy exit seat button.

The automatic easy exit seat movement will only occur one time after the key is removed from the ignition. If the automatic movement has already occurred, and you put the key back in the ignition and remove it again, the seat and steering column will stay in the original exit position, unless a memory recall took place prior to removing the key again.

NO CHANGE: No change will be made to this feature. The current setting will remain.

To select a setting, press the set/reset button while the desired setting is displayed on the DIC.

EASY EXIT SETUP

If your vehicle has this feature, it allows you to select which areas will recall with the automatic easy exit seat feature. It also allows you to turn off the automatic easy exit feature. See *Memory Seat, Mirrors and Steering Wheel on page 2-6* and "EASY EXIT RECALL" earlier for more information.

Press the customization button until EASY EXIT SETUP appears on the DIC display. Press the set/reset button once to access the settings for this feature. Then press the menu up/down button to scroll through the following settings:

OFF: No automatic seat exit will recall.

SEAT ONLY: The driver's seat will recall.

TILT ONLY: The steering wheel tilt feature will recall.

TELESCOPE ONLY: The steering column telescope feature will recall.

SEAT/TILT: The driver's seat and the steering wheel tilt feature will recall.

SEAT/TELESCOPE: The driver's seat and the steering column telescope feature will recall.

TILT/TELESCOPE: The steering wheel tilt and steering column telescope features will recall.

ALL (default): The driver's seat and the steering wheel tilt and steering column telescope features will recall, if your vehicle has this option.

NO CHANGE: No change will be made to this feature. The current setting will remain.

To select a setting, press the set/reset button while the desired setting is displayed on the DIC.

MEMORY SEAT RECALL

If your vehicle has this feature, it allows you to select your preference for the remote memory seat recall feature. See *Memory Seat, Mirrors and Steering Wheel on page 2-6* for more information.

Press the customization button until MEMORY SEAT RECALL appears on the DIC display. Press the set/reset button once to access the settings for this feature. Then press the menu up/down button to scroll through the following settings:

OFF (default): No remote memory seat recall will occur.

ON: The driver's seat and outside mirrors will automatically move to the stored driving position when the unlock button on the Remote Keyless Entry (RKE) transmitter is pressed. The steering column will also move on vehicles with the power tilt and telescopic steering feature. See *Power Tilt Wheel and Telescopic Steering Column* on page 4-4 for more information. See "RELEARN REMOTE KEY" under *DIC Operation and Displays* on page 4-61 for more information on matching transmitters to driver ID numbers.

NO CHANGE: No change will be made to this feature. The current setting will remain.

To select a setting, press the set/reset button while the desired setting is displayed on the DIC.

REMOTE START

If your vehicle has this feature, it allows you to turn the remote start off or on. The remote start feature allows you to start the engine from outside of the vehicle using the Remote Keyless Entry (RKE) transmitter. See *Remote Vehicle Start* on page 3-7 for more information.

Press the customization button until REMOTE START appears on the DIC display. Press the set/reset button once to access the settings for this feature. Then press the menu up/down button to scroll through the following settings:

OFF: The remote start feature will be disabled.

ON (default): The remote start feature will be enabled.

NO CHANGE: No change will be made to this feature. The current setting will remain.

To select a setting, press the set/reset button while the desired setting is displayed on the DIC.

FACTORY SETTINGS

This feature allows you to set all of the customization features back to their factory default settings.

Press the customization button until FACTORY SETTINGS appears on the DIC display. Press the set/reset button once to access the settings for this feature. Then press the menu up/down button to scroll through the following settings:

RESTORE ALL (default): The customization features will be set to their factory default settings.

DO NOT RESTORE: The customization features will not be set to their factory default settings.

To select a setting, press the set/reset button while the desired setting is displayed on the DIC.

Exiting the Feature Settings Menu

The feature settings menu will be exited when any of the following occurs:

- The vehicle is shifted out of P (Park).
- The vehicle is no longer in ON/RUN.
- The trip/fuel or vehicle information DIC buttons are pressed.
- The end of the feature settings menu is reached and exited.
- A 40 second time period has elapsed with no selection made.

Audio System(s)

Determine which radio the vehicle has and read the following pages to become familiar with its features.

WARNING:

Taking your eyes off the road for extended periods could cause a crash resulting in injury or death to you or others. Do not give extended attention to entertainment tasks while driving.

This system provides access to many audio and non audio listings.

To minimize taking your eyes off the road while driving, do the following while the vehicle is parked:

- Become familiar with the operation and controls of the audio system.
- Set up the tone, speaker adjustments, and preset radio stations.

For more information, see *Defensive Driving on page 5-2*.

Notice: Contact your dealer before adding any equipment.

Adding audio or communication equipment could interfere with the operation of the vehicle's engine, radio, or other systems, and could damage them. Follow federal rules covering mobile radio and telephone equipment.

The vehicle has Retained Accessory Power (RAP). With RAP, the audio system can be played even after the ignition is turned off. See *Retained Accessory Power (RAP)* on page 3-24 for more information.

Setting the Clock

Radio with a Single CD or a Six-Disc CD Player

The vehicle has an analog clock as well as the digital radio clock. At the time of new vehicle delivery, the digital radio clock display should be disabled. If you decide to use the digital radio clock as well as the analog clock, you can change the setting to enable the radio clock display.

Enabling/Disabling the Digital Radio Clock

For the Single CD Player

To turn the radio clock display on or off:

1. Turn the radio on.
2. Press the \odot button until the clock and date setting menus appear.
3. Press the pushbutton located under the forward arrow tab until the menu for default clock and date settings appear.
4. Press the pushbutton located under the currently displayed status of either ON or OFF. The ON display indicates the radio clock display is disabled and the OFF display indicates the radio clock display is enabled. Press this pushbutton to toggle the radio clock display on or off.



If the radio clock display is turned on, the screen displays Radio Clock ON for 10 seconds, then returns to the original clock display menu.

If the radio clock display is turned off, the screen displays Radio Clock OFF for 10 seconds. The menus for clock and date settings are removed, and ON displays as a current status indicating that the clock display can be turned on, if desired.

The radio clock and analog clock are not synchronized. Occasionally you might need to set the digital radio clock using the procedure below to synchronize both clocks.

For a Six-Disc CD Player

To turn the radio clock display on or off:

1. Turn the radio on.
2. Press the MENU button until  is displayed
3. Press the pushbutton located under  until the clock and date settings appear.
4. Press the pushbutton located under the forward arrow tab until the menu for default clock and date settings appear.
5. Press the pushbutton located under the currently displayed status of either ON or OFF. The ON display indicates the radio clock display is disabled and the OFF display indicates the radio clock display is enabled. Press this pushbutton to toggle the radio clock display on or off.





If the radio clock display is turned on, the screen displays Radio Clock ON for 10 seconds, then returns to the original clock display menu.

If the radio clock display is turned off, the screen displays Radio Clock OFF for 10 seconds. The menus for clock and date settings are removed, and ON displays as a current status indicating that the clock display can be turned on, if desired.

Setting the Time and Date





For the Single CD Player

This type of radio has a  button for setting the time and date. To set the time and date:

1. Turn the radio on.
2. Press  and HR, MIN, MM, DD, YYYY (hour, minute, month, day, and year) displays.
3. Press the pushbutton located under any one of the tabs that you want to change. Every time the pushbutton is pressed again, the time or the date if selected, increases by one.
 - Another way to increase the time or date, is to press the right SEEK arrow or the  FWD button.
 - To decrease the time or date, press the left SEEK arrow or the  REV button. You can also turn the  knob, located on the upper right side of the radio faceplate, to adjust the selected setting.

For a Six-Disc CD Player

This type of radio has a MENU button for setting the time and date. To set the time and date:

1. Turn the radio on.
2. Press the MENU button until  option is displayed.
3. Press the pushbutton located under  and the HR, MIN, MM, DD, YYYY (hour, minute, month, day, and year) displays.
4. Press the pushbutton located under any one of the tabs that you want to change. Every time the pushbutton is pressed again, the time or the date if selected, increases by one.
 - Another way to increase the time or date, is to press the right SEEK arrow or the  FWD button.
 - To decrease the time or date, press the left SEEK arrow or the  REV button. You can also turn the  knob, located on the upper right side of the radio faceplate, to adjust the selected setting.

Changing the Time and Date Default Setting

For the Single CD Player

To change the time and date default setting:

1. Change the time default setting from 12 hour to 24 hour or the date default setting from month/day/year to day/month/year, by pressing the \ominus button.
2. Once the clock and date settings display along with the forward arrow tab, press the pushbutton located under the forward arrow tab until the time 12H and 24H, and the date MM/DD/YYYY (month, day, and year) and DD/MM/YYYY (day, month, and year) displays.
3. Press the pushbutton located under the desired option, then press the \ominus button again to apply the selected default, or let the screen time out.

For the Six-Disc CD Player

To change the time and date default setting:

1. Change the time default setting from 12 hour to 24 hour or the date default setting from month/day/year to day/month/year, by pressing the MENU button.
2. Once \ominus displays, press the pushbutton located under \ominus until the time and date settings display along with a forward arrow.
3. Press the pushbutton located under the forward arrow tab until the time 12H and 24H, and the date MM/DD/YYYY (month, day, and year) and DD/MM/YYYY (day, month, and year) displays.
4. Press the pushbutton located under the desired option, then press the MENU button again to apply the selected default, or let the screen time out.

Radio(s) (MP3)

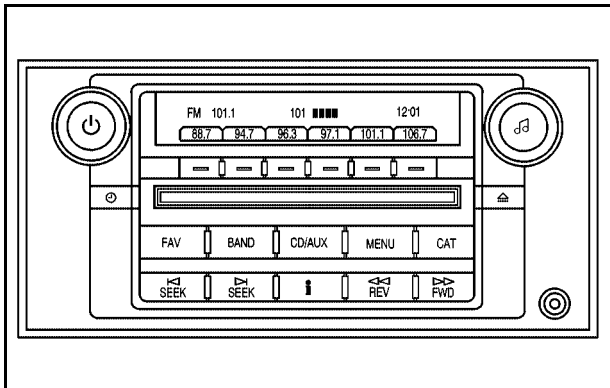

Radio with CD shown, Radio with Six-Disc CD similar

Radio Data System (RDS)

The audio system has RDS. The RDS feature is available for use only on FM stations that broadcast RDS information. This system relies upon receiving specific information from these stations and only works when the information is available. While the radio is tuned to an FM-RDS station, the station name or call letters display. In rare cases, a radio station can broadcast incorrect information that causes the radio features to work improperly. If this happens, contact the radio station.

Playing the Radio

Power/Volume: Press to turn the system on and off.

Turn to increase or decrease the volume.

Speed Compensated Volume (SCV): Radios with SCV automatically adjusts the radio volume to compensate for road and wind noise while driving. That way, the volume level should sound about the same while driving. To activate SCV:

1. Set the radio volume to the desired level.
2. Press the MENU button to display the radio setup menu.
3. Press the pushbutton under the AUTO VOLUM (automatic volume) tab on the radio display.
4. Press the pushbutton under the desired Speed Compensated Volume setting (OFF, Low, Med, or High) to select the level of radio volume compensation. The display times out after approximately 10 seconds. Each higher setting allows for more radio volume compensation at faster vehicle speeds.

AudioPilot®: If the vehicle has the Bose® audio system, it has AudioPilot noise compensation technology.

To use AudioPilot:

1. Set the radio volume to the desired level.
2. Press the MENU button to display the radio setup menu.
3. Press the pushbutton located under the AUTO VOLUM tab on the radio display.
4. Press the ON or OFF button to turn this feature on or off.

When turned ON, AudioPilot continuously adjusts the audio system equalization, to compensate for background noise, so that the music always sounds the same at the set volume level.

The feature is most effective at lower radio volume settings where background noise can affect how well you hear the music being played through the vehicle's audio system. At high volume settings there might be little or no adjustments by AudioPilot. For more information on AudioPilot, visit bose.com/audiopilot.

Finding a Station

BAND: Press to switch between AM, FM, or XM™. The selection displays.

🎵 **(Tune):** Turn to select radio stations.

◀ **SEEK** ▶ : Press the arrows to go to the next or to the previous station and stay there.

To scan stations, press and hold either arrow for three seconds until a beep sounds. The radio goes to a station, plays for a few seconds, then goes to the next station. Press either arrow again to stop scanning.

The radio only seeks and scans stations with a strong signal that are in the selected band.

i (Information) (XM™ Satellite Radio Service, MP3/WMA, and RDS Features): Press this button to display additional text information related to the current FM-RDS or XM station, or MP3/WMA song. A choice of additional information such as: Channel, Song, Artist, CAT (category) can display. Continue pressing the information button to highlight the desired label, or press the pushbutton positioned under any one of the tabs and the information about that tab displays.

When information is not available, No Info displays.

Storing a Radio Station as a Favorite

Drivers are encouraged to set up their radio station favorites while the vehicle is in P (Park). Tune to favorite stations using the presets, favorites button, and steering wheel controls, if the vehicle has this feature. See *Defensive Driving on page 5-2*.





FAV (Favorites): A maximum of 36 stations can be programmed as favorites using the six pushbuttons positioned below the radio station frequency tabs and by using the radio favorites page button. Press the FAV button to go through up to six pages of favorites, each having six favorite stations available per page. Each page of favorites can contain any combination of AM, FM, or XM stations. To store a station as a favorite:

1. Tune to the desired radio station.
2. Press the FAV button to display the page where you want the station stored.
3. Press and hold one of the six pushbuttons until a beep sounds. When that pushbutton is pressed and released, the station that was set, returns.
4. Repeat the steps for each pushbutton radio station you want stored as a favorite.

The number of favorites pages can be setup using the MENU button. To setup the number of favorites pages:

1. Press the MENU button to display the radio setup menu.
2. Press the pushbutton located below the FAV 1-6 label.
3. Select the desired number of favorites pages by pressing the pushbutton located below the displayed page numbers.
4. Press the FAV button, or let the menu time out, to return to the original main radio screen showing the radio station frequency labels and to begin the process of programming your favorites for the chosen amount of numbered pages.

Setting the Tone (Bass/Midrange/Treble)

BASS/MID/TREB (Bass, Midrange, or Treble): To adjust bass, midrange, or treble, press the  knob until the tone control labels display. Continue pressing to highlight the desired label, or press the pushbutton positioned under the desired label. Turn the  knob to adjust the highlighted setting. The highlighted setting can also be adjusted by pressing either SEEK arrow,  FWD, or  REV button until the desired levels are obtained. If a station's frequency is weak or has static, decrease the treble.

To quickly adjust bass, midrange, or treble to the middle position, press the pushbutton positioned under the BASS, MID, or TREB label for more than two seconds. A beep sounds and the level adjusts to the middle position.

To quickly adjust all tone and speaker controls to the middle position, press the  knob for more than two seconds until a beep sounds.

EQ (Equalization): For the non-Bose[®] amplified radio, perform the following steps to setup the equalization settings:

1. Press the  knob until the equalization label displays.
2. Press the pushbutton located under the equalization label to get choices of POP, ROCK, CTRY (country), TALK, JAZZ, and CLAS (classical), to display.
3. Press the pushbutton located under the desired setting.





For the Bose amplified radio, perform the following steps to setup the equalization settings:

1. Press the  knob until the DSP label displays.
2. Press the pushbutton located under the DSP label to get choices of Norm, Driv, Rear, and Surround, to display.
3. Press the pushbutton located under the desired setting.

To select Surround, press either the fourth or fifth pushbutton located under the displayed Surround until Centerpoint displays.

To return to the manual mode, press the tune knob. Select either BASS, MID, or TREB and start to manually adjust the settings by turning the  knob.

Adjusting the Speakers (Balance/Fade)

BAL/FADE (Balance/Fade): To adjust balance or fade, press the  knob until the speaker control labels display. Continue pressing to highlight the desired label, or press the pushbutton positioned under the desired label. Turn the  knob to adjust the highlighted setting. The highlighted setting can be adjusted by pressing either SEEK arrow,  FWD, or  REV buttons until the desired levels are obtained.

To quickly adjust balance or fade to the middle position, press the pushbutton positioned under the BAL or FADE label for more than two seconds. A beep sounds and the level adjusts to the middle position.

To quickly adjust all speaker and tone controls to the middle position, press the  knob for more than two seconds until a beep sounds.

Digital Signal Processing (DSP)

This feature is used to provide a choice of four different listening experiences. DSP can be used while listening to the audio system or a CD. To change the DSP mode, press the  knob until the DSP control label displays.

Press the pushbutton located under the DSP label until the control labels display. Continue by pressing the desired button below the control labels on the display.

For more information on the control label displays, see the following:

- **Norm (Normal):** Select this screen button to adjust the audio for normal mode. This provides the best sound quality for all seating positions.
- **Driv (Driver):** Select this screen button to adjust the audio for the driver to receive the best possible sound quality.
- **Rear:** Select this screen button to adjust the audio for the rear seat passengers to receive the best possible sound quality.
- **Surround (Centerpoint[®]):** Select this screen button to enable Bose[®] Centerpoint signal processing circuitry. Centerpoint produces a full vehicle surround sound listening experience from a CD, MP3/WMA, or XM stereo digital audio source and delivers five independent audio channels from conventional two channel stereo recordings. (Not available for AM, FM, or auxiliary sources.)

DSP is only available on vehicles that have the Bose Premium audio system.

Finding a Category (CAT) Station

CAT (Category): The CAT button is used to find XM stations while the radio is in the XM mode. To find XM channels within a desired category, perform the following:

1. Press the BAND button until the XM frequency displays. Press the CAT button to display the category tabs. Continue pressing the CAT button until the desired category name displays. Another way to select a category is to press the ◀◀ REV or ▶▶ FWD button until the desired category is selected.
2. Press either of the two pushbuttons below the desired category tab to immediately tune to the first XM station associated with that category.
3. Turn the ⏪ knob, press the pushbuttons below the displayed right or left arrows, or press either SEEK arrow to go to the previous or the next XM station within the selected category.
4. To exit the category search mode, press the FAV button or BAND button to display your favorites again.

Undesired XM categories can be removed through the setup menu. To remove an undesired category:

1. Press the MENU button to display the radio setup menu.
2. Press the pushbutton located below the XM CAT tab.
3. Turn the ⏪ knob to display the category to be removed.
4. Press the pushbutton located under the Remove tab until the category name along with the word Removed displays.
5. Repeat the steps to remove more categories.

Removed categories can be restored by pressing the pushbutton under the Add label when a removed category is displayed or by pressing the pushbutton under the Restore All label.

The radio does not let you remove or add categories while the vehicle is moving faster than 5 mph (8 km/h).

The CAT button also toggles between compressed and uncompressed audio when a mixed disc is present. See "Compressed Audio" later in this section.

Radio Message

Locked: This message displays when the THEFTLOCK® system has locked up the radio. Take the vehicle to your dealer for service.

If any error occurs repeatedly or if an error cannot be corrected, contact your dealer.

XM™ Satellite Radio Service

XM is a satellite radio service that is based in the 48 contiguous United States and 10 Canadian provinces. XM Satellite Radio has a wide variety of programming and commercial-free music, coast-to-coast, and in digital-quality sound. A service fee is required to receive the XM service. For more information, contact XM at www.xmradio.com or call 1-800-929-2100 in the U.S. and www.xmradio.ca or call 1-877-438-9677 in Canada.

Radio Messages for XM™ Only

See *XM Radio Messages on page 4-108* later in this section for further detail.

Playing a CD (Single CD Player)

Insert a CD partway into the slot, label side up. The player pulls it in and the CD should begin playing.

If the ignition or radio is turned off with a CD in the player, it stays in the player. When the ignition or radio is turned on, the CD starts playing where it stopped, if it was the last selected audio source.

When a CD is inserted, the CD symbol displays. As each new track starts to play the track number displays.

Care of CDs

If playing a CD-R, the sound quality can be reduced due to CD-R quality, the method of recording, the quality of the music that has been recorded, and the way the CD-R has been handled. Handle them carefully. Store CD-R(s) in their original cases or other protective cases and away from direct sunlight and dust. The CD player scans the bottom surface of the disc. If the surface of a CD is damaged, such as cracked, broken, or scratched, the CD does not play properly or not at all. Do not touch the bottom side of a CD while handling it; this could damage the surface. Pick up CDs by grasping the outer edges or the edge of the hole and the outer edge.

If the surface of a CD is soiled, take a soft, lint free cloth or dampen a clean, soft cloth in a mild, neutral detergent solution mixed with water, and clean it. Make sure the wiping process starts from the center to the edge.

Care of The CD Player

Do not add any label to a CD, it could get caught in the CD player. If a CD is recorded on a personal computer and a description label is needed, try labeling the top of the recorded CD with a marking pen.

The use of CD lens cleaners for CDs is not advised, due to the risk of contaminating the lens of the CD optics with lubricants internal to the CD player mechanism.

Notice: If a label is added to a CD, or more than one CD is inserted into the slot at a time, or an attempt is made to play scratched or damaged CDs, the CD player could be damaged. While using the CD player, use only CDs in good condition without any label, load one CD at a time, and keep the CD player and the loading slot free of foreign materials, liquids, and debris.

If an error displays, see "CD Messages" later in this section.

Playing a CD(s) (Six-Disc CD Player)

LOAD  : Press to load CDs into the CD player. The CD player holds up to six CDs.

To insert one CD:

1. Press and release the load button.
2. Wait for the message to insert the disc.
3. Load a CD. Insert the CD partway into the slot, label side up. The player pulls the CD in.

To insert multiple CDs:

1. Press and hold the LOAD button for five seconds. A beep sounds and Load All Discs displays.
2. Follow the displayed instruction on when to insert the discs. The CD player takes up to six CDs.
3. Press the Load button again to cancel loading more CDs.

Eject  : Press to eject the CD. If the CD is not removed, after several seconds, the CD automatically pulls back into the player.

For the Radio with Six-Disc CD player, press and hold for two seconds to eject all discs, if one or more discs are loaded.

Tune  : Turn to select tracks on the CD currently playing.

◀ **SEEK** ▶ : Press the left arrow to go to the start of the current track, if more than ten seconds have played. Press the right arrow to go to the next track. If either arrow is held or pressed multiple times, the player continues moving backward or forward through the CD.

◀◀ **REV (Fast Reverse)**: Press and hold to reverse playback quickly within a track. You will hear sound at a reduced volume. Release to resume playing the track. The elapsed time of the track displays.

▶▶ **FWD (Fast Forward)**: Press and hold to advance playback quickly within a track. You will hear sound at a reduced volume. Release to resume playing the track. The elapsed time of the track displays.

RDM (Random): With the random setting, CD tracks can be played in random, rather than sequential order. This feature is not available in playlist mode. To use random, do the following:

1. To play tracks in random order from the CD that is currently playing, press the pushbutton positioned under the RDM label. The random icon displays.
2. Press the same pushbutton again to turn off random play. The random icon is no longer highlighted.

RDM (Random) (Radio with Six-Disc CD Player):

With the random setting, CD tracks can be played in random, rather than sequential order, on one CD or all CDs in a six-disc CD player. To use random:

- Press the pushbutton positioned under the RDM tab until Randomize Current Disc displays to play the tracks in random order from the CD that is currently playing. Press again to turn off random play.
- Press the pushbutton positioned under the RDM tab until Randomize All Discs displays to play tracks from all CDs loaded in a six-disc CD player in random order. Press again to turn off random play.

i (Information): Press to switch the display between the track number, elapsed time of the track, and the time. When the ignition is off, press to display the time (if the clock display is enabled). See “Enabling/Disabling the Digital Radio Clock” under, *Setting the Clock on page 4-89* for more information.

BAND: Press to listen to the radio when a CD is playing. The CD remains inside the radio for future listening.

CD/AUX (CD/Auxiliary): Press to play a CD when listening to the radio. The CD icon and track number displays when a CD is in the player. Press again and the system automatically searches for an auxiliary input device, such as a portable audio player. If a portable audio player is not connected, "No Aux Input Device Found" displays.

Playing an MP3/WMA CD-R or CD-RW Disc

Radios with the MP3 feature are capable of playing an MP3/WMA CD-R or CD-RW disc. For more information on how to play an MP3/WMA CD-R or CD-RW disc, see *Using an MP3* on page 4-103 later in this section.

CD Messages

DISC ERROR: If this message displays and/or the CD ejects, it could be for one of the following reasons:

- The radio system does not support the playlist format, the compressed audio format, or the data file format.
- It is very hot. When the temperature returns to normal, the CD should play.
- You are driving on a very rough road. When the road becomes smoother, the CD should play.
- The CD is dirty, scratched, wet, or upside down.
- The air is very humid. If so, wait about an hour and try again.
- There could have been a problem while burning the CD.
- The label could be caught in the CD player.

If the CD is not playing correctly, for any other reason, try a known good CD.

If any error occurs repeatedly or if an error cannot be corrected, contact your dealer. If the radio displays an error message, write it down and provide it to your dealer when reporting the problem.

Using the Auxiliary Input Jack

The radio system has an auxiliary input jack located on the lower right side of the faceplate. This is not an audio output; do not plug the headphone set into the front auxiliary input jack. You can however, connect an external audio device such as an iPod™, laptop computer, MP3 player, CD changer, or cassette tape player, etc. to the auxiliary input jack for use as another source for audio listening.

Drivers are encouraged to set up any auxiliary device while the vehicle is in P (Park). See *Defensive Driving on page 5-2* for more information on driver distraction.

To use a portable audio player, connect a 3.5 mm (1/8 inch) cable to the radio's front auxiliary input jack. When connecting an auxiliary device, the radio automatically detects the device and "Aux Input Device" displays. The device begins playing audio over the vehicle speakers. If an auxiliary device has already been connected, the device does not begin playing audio until the radio's CD/AUX button is pressed.

 (**Power/Volume**): Turn to increase or decrease the volume of the portable player. You might need to do additional volume adjustments from the portable device.

BAND: Press to listen to the radio when a portable audio device is playing. The portable audio device continues playing, so you might want to stop it or power it off.

CD/AUX (CD/Auxiliary): Press to play a CD when a portable audio device is playing. Press again and the system begins playing audio from the connected portable audio player. If a portable audio player is not connected, "No Aux Input Device Found" displays.

Using an MP3

MP3/WMA CD-R or CD-RW Disc

The radio plays MP3 and WMA files that were recorded on a CD-R or CD-RW disc. The files can be recorded with the following fixed bit rates: 32 kbps, 40 kbps, 56 kbps, 64 kbps, 80 kbps, 96 kbps, 112 kbps, 128 kbps, 160 kbps, 192 kbps, 224 kbps, 256 kbps, and 320 kbps or a variable bit rate. Song title, artist name, and album can display when files are recorded using ID3 tags version 1 and 2.

Compressed Audio





The radio also plays discs that contain both uncompressed CD audio (.CDA files) and MP3/WMA files. By default the radio reads only the uncompressed audio and ignores the MP3/WMA files. Pressing the CAT button toggles between compressed and uncompressed audio format.

MP3/WMA Format

If you burn your own MP3/WMA disc on a personal computer:

- Make sure the MP3/WMA files are recorded on a CD-R or CD-RW disc.
- Do not mix standard audio and MP3/WMA files on one disc.
- The CD player is able to read and play a maximum of 50 folders, 50 playlists, and 255 files.
- Create a folder structure that makes it easy to find songs while driving. Organize songs by albums using one folder for each album. Each folder or album should contain 18 songs or less.
- Avoid subfolders. The system can support up to 8 subfolders deep, however, keep the total number of folders to a minimum in order to reduce the complexity and confusion in trying to locate a particular folder during playback.
- Make sure playlists have a .m3u or .wpl extension (other file extensions might not work).

- Minimize the length of the file, folder or playlist names. Long file, folder, or playlist names, or a combination of a large number of files and folders, or playlists can cause the player to be unable to play up to the maximum number of files, folders, playlists, or sessions. If you wish to play a large number of files, folders, playlists, or sessions, minimize the length of the file, folder, or playlist name. Long names also take up more space on the display, potentially getting cut off.
- Finalize the audio disc before you burn it. Trying to add music to an existing disc can cause the disc not to function in the player.

Playlists can be changed by using the   and   folder buttons, the  knob, or the SEEK arrows. An MP3/WMA CD-R or CD-RW that was recorded using no file folders can also be played. If a CD-R or CD-RW contains more than the maximum of 50 folders, 50 playlists, and 255 files, the player lets you access and navigate up to the maximum, but all items over the maximum cannot be accessed.

Root Directory

The root directory of the CD-R or CD-RW is treated as a folder. If the root directory has compressed audio files, the directory displays as F1 ROOT. All files contained directly under the root directory are accessed prior to any root directory folders. However, playlists (Px) are always accessed before root folders or files.

Empty Directory or Folder

If a root directory or a folder exists somewhere in the file structure that contains only folders/subfolders and no compressed files directly beneath them, the player advances to the next folder in the file structure that contains compressed audio files. The empty folder does not display.

No Folder



When the CD contains only compressed files, the files are located under the root folder. The next and previous folder functions do not display on a CD that was recorded without folders or playlists.

When displaying the name of the folder the radio displays ROOT.

When the CD contains only playlists and compressed audio files, but no folders, all files are located under the root folder. The folder down and the folder up buttons search playlists (Px) first and then goes to the root folder. When the radio displays the name of the folder the radio displays ROOT.

Order of Play

Tracks recorded to the CD-R or CD-RW play in the following order:

- Play begins from the first track in the first playlist and continues sequentially through all tracks in each playlist. When the last track of the last playlist has played, play continues from the first track of the first playlist.
 - Playlists can be changed by pressing the <  and  folder buttons, the  knob, or the SEEK arrows.
- Play begins from the first track in the first folder and continues sequentially through all tracks in each folder. When the last track of the last folder has played, play continues from the first track of the first folder.

When play enters a new folder, the display does not automatically show the new folder name unless the folder mode has been chosen as the default display. The new track name displays.







File System and Naming

The song name that displays is the song name that is contained in the ID3 tag. If the song name is not present in the ID3 tag, then the radio displays the file name without the extension (such as .mp3) as the track name.

Track names longer than 32 characters or four pages are shortened. Parts of words on the last page of text and the extension of the filename does not display.

Preprogrammed Playlists

Preprogrammed playlists that were created using WinAmp™, MusicMatch™, or Real Jukebox™ software can be accessed, however, they cannot be edited using the radio. These playlists are treated as special folders containing compressed audio song files. Playlists must have a file extension of PLS, M3U, or WPL.

Playlists can be changed by using the   and   folder buttons, the  knob, or the SEEK arrows. Tracks cannot be changed. Songs are played sequentially; press the  REV or  FWD to reverse or advance through the currently playing song.



Playing an MP3/WMA

Insert a CD-R or CD-RW partway into the slot (Single CD Player), or press the load button and wait for the message to insert disc (Six-Disc CD Player), label side up. The player pulls it in, and the CD-R or CD-RW should begin playing.

 (**Eject**): Press this button to eject CD-R(s) or CD-RW(s). To eject the CD-R or CD-RW that is currently playing, press and release this button. A beep sounds and Ejecting Disc displays. Once the disc is ejected, Remove Disc displays. The CD-R or CD-RW can be removed. If it is not removed, after several seconds, the CD-R or CD-RW automatically pulls back into the player and begins playing.

For the Six-Disc CD player, press and hold this button for two seconds to eject all discs.

 (**Tune**): Turn this knob to select MP3/WMA files on the CD-R currently playing.

 **SEEK**  : Press the left SEEK arrow to go to the start of the current MP3/WMA file, if more than ten seconds have played. Press the right SEEK arrow to go to the next MP3/WMA file. If either SEEK arrow is held or pressed multiple times, the player continues moving backward or forward through MP3/WMA files on the CD.

 **(Previous Folder):** Press the pushbutton positioned under the Folder tab to go to the first track in the previous folder.

 **(Next Folder):** Press the pushbutton positioned under the Folder tab to go to the first track in the next folder.

 **REV (Fast Reverse):** Press and hold to reverse playback quickly within an MP3/WMA file. Sound is heard at a reduced volume. Release this button to resume playing the file. The elapsed time of the file displays.

 **FWD (Fast Forward):** Press and hold to advance playback quickly within an MP3/WMA file. Sound is heard at a reduced volume. Release this button to resume playing the file. The elapsed time of the file displays.

RDM (Random): With the random setting, MP3/WMA files on the CD-R can be played in random, rather than sequential order, on one CD-R/CD-RW or all discs in a six-disc CD player. To use random:

1. Press the pushbutton positioned under the RDM label until Random Current Disc displays to play MP3/WMA files from the CD-R or CD-RW in random order. Press the same pushbutton again to turn off random play.

2. Press the pushbutton positioned under the RDM label until Randomize All Discs displays to play songs from all CDs loaded in a six-disc CD player in random order. Press the same pushbutton again to turn off random play.

 **(Music Navigator):** Use the music navigator feature to play MP3/WMA files on the CD-R or CD-RW in order by artist or album. Press the pushbutton located below the music navigator label. The player scans the disc to sort the files by artist and album ID3 tag information. It may take several minutes to scan the disc depending on the number of MP3/WMA files recorded to the CD-R or CD-RW. The radio might begin playing while it is scanning the disc in the background. When the scan is finished, the CD-R or CD-RW begins playing again.

Once the disc has scanned, the player defaults to playing MP3/WMA files in order by artist. The current artist playing is shown on the second line of the display between the arrows. Once all songs by that artist have played, the player moves to the next artist in alphabetical order on the CD-R or CD-RW and begins playing MP3/WMA files by that artist. If you want to listen to MP3/WMA files by another artist, press the pushbutton located below either arrow button. The CD goes to the next or previous artist in alphabetical order. Continue pressing either button until the desired artist displays.

To change from playback by artist to playback by album, press the pushbutton located below the Sort By label. From the sort screen, push one of the buttons below the album button. Press the pushbutton below the Back label to return to the main music navigator screen. Now the album name displays on the second line between the arrows and songs from the current album begins to play. Once all songs from that album have played, the player moves to the next album in alphabetical order on the CD-R or CD-RW and begins playing MP3/WMA files from that album.

To exit music navigator mode, press the button below the Back label to return to normal MP3/WMA playback.

BAND: Press to listen to the radio when a CD is playing. The inactive CD remains inside the radio for future listening.

CD/AUX (CD/Auxiliary): Press to play a CD when listening to the radio. The CD icon and a message showing disc and/or track number displays when a CD is in the player. Press this button again and the system automatically searches for an auxiliary input device such as a portable audio player. If a portable audio player is not connected, "No Aux Input Device Found" displays.

XM Radio Messages

XL (Explicit Language Channels): These channels, or any others, can be blocked at a customer's request, by calling 1-800-852-XXM (9696).

XM Updating: The encryption code in the receiver is being updated, and no action is required. This process should take no longer than 30 seconds.

No XM Signal: The system is functioning correctly, but the vehicle is in a location that is blocking the XM™ signal. When the vehicle is moved into an open area, the signal should return.

Loading XM: The audio system is acquiring and processing audio and text data. No action is needed. This message should disappear shortly.

Channel Off Air: This channel is not currently in service. Tune in to another channel.

Channel Unauth: This channel is blocked or cannot be received with your XM Subscription package.

Channel Unavail: This previously assigned channel is no longer assigned. Tune to another station. If this station was one of the presets, choose another station for that preset button.

No Artist Info: No artist information is available at this time on this channel. The system is working properly.

No Title Info: No song title information is available at this time on this channel. The system is working properly.

No CAT Info: No category information is available at this time on this channel. The system is working properly.

No Information: No text or informational messages are available at this time on this channel. The system is working properly.

CAT Not Found: There are no channels available for the selected category. The system is working properly.

XM Theftlocked: The XM receiver in the vehicle could have previously been in another vehicle. For security purposes, XM receivers cannot be swapped between vehicles. If this message is received after having the vehicle serviced, check with your dealer.

XM Radio ID: If tuned to channel 0, this message alternates with the XM™ Radio 8 digit radio ID label. This label is needed to activate the service.

Unknown: If this message is received when tuned to channel 0, there could be a receiver fault. Consult with your dealer.

Check Antenna: If this message does not clear within a short period of time, the receiver or antenna could have a fault. Consult with your dealer.

Check XM Receiver: If this message does not clear within a short period of time, the receiver could have a fault. Consult with your dealer.

XM Not Available: If this message does not clear within a short period of time, the receiver could have a fault. Consult with your dealer.

Navigation/Radio System

For vehicles with a navigation radio system, see the separate Navigation System manual.

Bluetooth®

Vehicles with a Bluetooth system can use a Bluetooth capable cell phone with a Hands Free Profile to make and receive phone calls. The system can be used while the key is in ON/RUN or ACC/ACCESSORY position. The range of the Bluetooth system can be up to 9.1 m (30 ft). Not all phones support all functions, and not all phones are guaranteed to work with the in-vehicle Bluetooth system. See www.gm.com/bluetooth for more information on compatible phones.

Voice Recognition

The Bluetooth system uses voice recognition to interpret voice commands to dial phone numbers and name tags.

Noise: Keep interior noise levels to a minimum. The system may not recognize voice commands if there is too much background noise.

When to Speak: A short tone sounds after the system responds indicating when it is waiting for a voice command. Wait until the tone and then speak.



How to Speak: Speak clearly in a calm and natural voice.



Audio System

When using the in-vehicle Bluetooth system, sound comes through the vehicle's front audio system speakers and overrides the audio system. Use the audio system volume knob, during a call, to change the volume level. The adjusted volume level remains in memory for later calls. To prevent missed calls, a minimum volume level is used if the volume is turned down too low.

Bluetooth Controls

Use the buttons located on the steering wheel to operate the in-vehicle Bluetooth system. See *Audio Steering Wheel Controls on page 4-120* for more information.

  **(Push To Talk)** : Press to answer incoming calls, to confirm system information, and to start speech recognition.

  **(Phone On Hook)**: Press to end a call, reject a call, or to cancel an operation.

Pairing

A Bluetooth enabled cell phone must be paired to the in-vehicle Bluetooth system first and then connected to the vehicle before it can be used. See the cell phone manufacturers user guide for Bluetooth functions before pairing the cell phone. If a Bluetooth phone is not connected, calls will be made using OnStar® Hands-Free Calling, if available. Refer to the OnStar owner's guide for more information.

Pairing Information:

- Up to five cell phones can be paired to the in-vehicle Bluetooth system.
- The pairing process is disabled when the vehicle is moving.
- The in-vehicle Bluetooth system automatically links with the first available paired cell phone in the order the phone was paired.
- Only one paired cell phone can be connected to the in-vehicle Bluetooth system at a time.
- Pairing should only need to be completed once, unless changes to the pairing information have been made or the phone is deleted.

To link to a different paired phone, see Linking to a Different Phone later in this section.

Pairing a Phone

1. Press and hold  for two seconds. The system responds with "Ready" followed by a tone.
2. Say "Bluetooth". The system responds with "Bluetooth ready" followed by a tone.
3. Say "Pair". The system responds with instructions and a four digit PIN number. The PIN number will be used in Step 4.
4. Start the Pairing process on the cell phone that will be paired to the vehicle. Reference the cell phone manufacturers user guide for information on this process.

Locate the device named "General Motors" in the list on the cellular phone and follow the instructions on the cell phone to enter the four digit PIN number that was provided in Step 3.
5. The system prompts for a name for the phone. Use a name that best describes the phone. This name will be used to indicate which phone is connected. The system then confirms the name provided.
6. The system responds with "<Phone name> has been successfully paired" after the pairing process is complete.
7. Repeat Steps 1 through 7 for additional phones to be paired.

Listing All Paired and Connected Phones

1. Press and hold  for two seconds. The system responds with “Ready” followed by a tone.
2. Say “Bluetooth”. The system responds with “Bluetooth ready” followed by a tone.
3. Say “List”. The system lists all the paired Bluetooth devices. If a phone is connected to the vehicle, the system will say “Is connected” after the connected phone.

Deleting a Paired Phone

1. Press and hold  for two seconds. The system responds with “Ready” followed by a tone.
2. Say “Bluetooth”. The system responds with “Bluetooth ready” followed by a tone.
3. Say “Delete”. The system asks which phone to delete followed by a tone.
4. Say the name of the phone to be deleted. If the phone name is unknown, use the “List” command for a list of all paired phones. The system responds with “Would you like to delete <phone name>? Yes or No” followed by a tone.
5. Say “Yes” to delete the phone. The system responds with “OK, deleting <phone name>”.

Linking to a Different Phone

1. Press and hold  for two seconds. The system responds with “Ready” followed by a tone.
2. Say “Bluetooth”. The system responds with “Bluetooth ready” followed by a tone.
3. Say “Change phone”. The system responds with “Please wait while I search for other phones”.
 - If another phone is found, the response will be “<Phone name> is now connected”.
 - If another phone is not found, the original phone remains connected.

Storing Name Tags



The system can store up to thirty phone numbers as name tags that are shared between the Bluetooth and OnStar systems.

The system uses the following commands to store and retrieve phone numbers:

- Store
- Digit Store
- Directory

Using the Store Command



The store command allows a phone number to be stored without entering the digits individually.

1. Press and hold   for two seconds. The system responds with “Ready” followed by a tone.
2. Say “Store”. The system responds with “Store, number please” followed by a tone.
3. Say the complete phone number to be stored at once with no pauses.
 - If the system recognizes the number it responds with “OK, Storing” and repeats the phone number.
 - If the system is unsure it recognizes the phone number, it responds with “Store” and repeats the number followed by “Please say yes or no”. If the number is correct, say “Yes”. If the number is not correct, say “No”. The system will ask for the number to be re-entered.
4. After the system stores the phone number, it responds with “Please say the name tag” followed by a tone.

5. Say a name tag for the phone number. The name tag is recorded and the system responds with “About to store <name tag>. Does that sound OK?”.
 - If the name tag does not sound correct, say “No” and repeat Step 5.
 - If the name tag sounds correct, say “Yes” and the name tag is stored. After the number is stored the system returns to the main menu.

Using the Digit Store Command



The digit store command allows a phone number to be stored by entering the digits individually.

1. Press and hold   for two seconds. The system responds with “Ready” followed by a tone.
2. Say “Digit Store”. The system responds with “Please say the first digit to store” followed by a tone.

3. Say the first digit to be stored. The system will repeat back the digit it heard followed by a tone. Continue entering digits until the number to be stored is complete.
 - If an unwanted number is recognized by the system, say “Clear” at any time to clear the last number.
 - To hear all of the numbers recognized by the system, say “Verify” at any time and the system will repeat them.
4. After the complete number has been entered, say “Store”. The system responds with “Please say the name tag” followed by a tone.
5. Say a name tag for the phone number. The name tag is recorded and the system responds with “About to store <name tag>. Does that sound OK?”.
 - If the name tag does not sound correct, say “No” and repeat Step 5.
 - If the name tag sounds correct, say “Yes” and the name tag is stored. After the number is stored the system returns to the main menu.

Using the Directory Command

The directory command lists all of the name tags stored by the system. To use the directory command:

1. Press and hold   for two seconds. The system responds with “Ready” followed by a tone.
2. Say “Directory”. The system responds with “Directory” and then plays back all of the stored name tags. When the list is complete, the system returns to the main menu.

Deleting Name Tags



The system uses the following commands to delete name tags:

- Delete
- Delete all name tags

Using the Delete Command

The delete command allows specific name tags to be deleted.

To use the delete command:

1. Press and hold   for two seconds. The system responds with “Ready” followed by a tone.
2. Say “Delete”. The system responds with “Delete, please say the name tag” followed by a tone.

3. Say the name tag to be deleted. The system responds with "Would you like to delete, <name tag>? Please say yes or no".
 - If the name tag is correct, say "Yes" to delete the name tag. The system responds with "OK, deleting <name tag>, returning to the main menu."
 - If the name tag is incorrect, say "No". The system responds with "No. OK, let's try again, please say the name tag."

Using the Delete All Name Tags Command

The delete all name tags command deletes all stored phone book name tags and route name tags for OnStar (if present).

To use the delete all name tags command:

1. Press and hold  $\#^*$ for two seconds. The system responds with "Ready" followed by a tone.
2. Say "Delete all name tags". The system responds with "You are about to delete all name tags stored in your phone directory and your route destination directory. Are you sure you want to do this? Please say yes or no."
 - Say "Yes" to delete all name tags.
 - Say "No" to cancel the function and return to the main menu.

Making a Call

Calls can be made using the following commands:

- Dial
- Digit Dial
- Call
- Re-dial

Using the Dial Command

1. Press and hold  $\#^*$ for two seconds. The system responds with "Ready" followed by a tone.
2. Say "Dial". The system responds with "Dial using <phone name>". "Number please" followed by a tone.
3. Say the entire number without pausing.
 - If the system recognizes the number, it responds with "OK, Dialing" and dials the number.
 - If the system does not recognize the number, it confirms the numbers followed by a tone. If the number is correct, say "Yes". The system responds with "OK, Dialing" and dials the number. If the number is not correct, say "No". The system will ask for the number to be re-entered.

Using the Digit Dial Command

1. Press and hold  for two seconds. The system responds with “Ready” followed by a tone.
2. Say “Digit Dial”. The system responds with “Digit dial using <phone name>, please say the first digit to dial” followed by a tone.
3. Say the digit to be dialed one at a time. Following each digit, the system will repeat back the digit it heard followed by a tone.
4. Continue entering digits until the number to be dialed is complete. After the whole number has been entered, say “Dial”. The system responds with “OK, Dialing” and dials the number.
 - If an unwanted number is recognized by the system, say “Clear” at any time to clear the last number.
 - To hear all of the numbers recognized by the system, say “Verify” at any time and the system will repeat them.

Using the Call Command

1. Press and hold  for two seconds. The system responds with “Ready” followed by a tone.
2. Say “Call”. The system responds with “Call using <phone name>. Please say the name tag” followed by a tone.

3. Say the name tag of the person to call.
 - If the system clearly recognizes the name tag it responds with “OK, calling, <name tag>” and dials the number.
 - If the system is unsure it recognizes the right name tag, it confirms the name tag followed by a tone. If the name tag is correct, say “Yes”. The system responds with “OK, calling, <name tag>” and dials the number. If the name tag is not correct, say “No”. The system will ask for the name tag to be re-entered.

Once connected, the person called will be heard through the audio speakers.





Using the Re-dial Command

1. Press and hold  for two seconds. The system responds with “Ready” followed by a tone.
2. After the tone, say “Re-dial”. The system responds with “Re-dial using <phone name>” and dials the last number called from the connected Bluetooth phone.

Once connected, the person called will be heard through the audio speakers.







Receiving a Call

When an incoming call is received, the audio system mutes and a ring tone is heard in the vehicle.

- Press   and begin speaking to answer the call.
- Press   to ignore a call.





Call Waiting

Call waiting must be supported on the Bluetooth phone and enabled by the wireless service carrier to work.

- Press   to answer an incoming call when another call is active. The original call is placed on hold.
- Press   again to return to the original call.
- To ignore the incoming call, continue with the original call with no action.
- Press   to disconnect the current call and switch to the call on hold.

Three-Way Calling

Three-Way Calling must be supported on the Bluetooth phone and enabled by the wireless service carrier to work.

1. While on a call press  . The system responds with “Ready” followed by a tone.
2. Say “Three-way call”. The system responds with “Three-way call, please say dial or call”.
3. Use the dial or call command to dial the number of the third party to be called.
4. Once the call is connected, press   to link all the callers together.



Ending a Call

Press   to end a call.



Muting a Call

During a call, all sounds from inside the vehicle can be muted so that the person on the other end of the call cannot hear them.

To Mute a call

1. Press  . The system responds with “Ready” followed by a tone.
2. Say “Mute Call”. The system responds with “Call muted”.

To Cancel Mute



1. Press  . The system responds with “Ready” followed by a tone.
2. After the tone, say “Mute Call”. The system responds with “Resuming call”.

Transferring a Call

Audio can be transferred between the in-vehicle Bluetooth system and the cell phone.



To Transfer Audio to the Cell Phone

During a call with the audio in the vehicle:

1. Press  . The system responds with “Ready” followed by a tone.
2. Say “Transfer Call.” The system responds with “Transferring call” and the audio will switch from the vehicle to the cell phone.



To Transfer Audio to the In-Vehicle Bluetooth System

The cellular phone must be paired and connected with the Bluetooth system before a call can be transferred. The connection process can take up to two minutes after the key is turned to the ON/RUN or ACC/ACCESSORY position.

During a call with the audio on the cell phone, press   for more than two seconds. The audio switches from the cell phone to the vehicle.

Voice Pass-Thru



Voice Pass-Thru allows access to the voice recognition commands on the cell phone. See the cell phone manufacturers user guide to see if the cell phone supports this feature. This feature can be used to verbally access contacts stored in the cell phone.

1. Press and hold   for two seconds. The system responds with “Ready” followed by a tone.
2. Say “Bluetooth”. The system responds with “Bluetooth ready” followed by a tone.
3. Say “Voice”. The system responds with “OK, accessing <phone name>”.
 - The cell phone's normal prompt messages will go through its cycle according to the phone's operating instructions.



Dual Tone Multi-Frequency (DTMF) Tones

The in-vehicle Bluetooth system can send numbers and numbers stored as name tags during a call. This is used when calling a menu driven phone system. Account numbers can be programmed into the phonebook for retrieval during menu driven calls.

Sending a Number During a Call

1. Press  . The system responds with “Ready” followed by a tone.
2. Say “Dial”. The system responds with “Say a number to send tones” followed by a tone.
3. Say the number to send.
 - If the system clearly recognizes the number it responds with “OK, Sending Number” and the dial tones are sent and the call continues.
 - If the system is not sure it recognized the number properly, it responds “Dial Number, Please say yes or no?” followed by a tone. If the number is correct, say “Yes”. The system responds with “OK, Sending Number” and the dial tones are sent and the call continues.

Sending a Stored Name Tag During a Call

1. Press  . The system responds with “Ready” followed by a tone.
2. Say “Send name tag.” The system responds with “Say a name tag to send tones” followed by a tone.
3. Say the name tag to send.
 - If the system clearly recognizes the name tag it responds with “OK, Sending <name tag>” and the dial tones are sent and the call continues.
 - If the system is not sure it recognized the name tag properly, it responds “Dial <name tag>, Please say yes or no?” followed by a tone. If the name tag is correct, say “Yes”. The system responds with “OK, Sending <name tag>” and the dial tones are sent and the call continues.

Clearing the System

Unless information is deleted out of the in-vehicle Bluetooth system, it will be retained indefinitely. This includes all saved name tags in the phonebook and phone pairing information. For information on how to delete this information, see the above sections on Deleting a Paired Phone and Deleting Name Tags.

Other Information

The Bluetooth® word mark and logos are owned by the Bluetooth® SIG, Inc. and any use of such marks by General Motors is under license. Other trademarks and trade names are those of their respective owners.

See *Radio Frequency Statement on page 8-20* for FCC information.

Theft-Deterrent Feature

THEFTLOCK® is designed to discourage theft of the vehicle's radio by learning a portion of the Vehicle Identification Number (VIN). The radio does not operate if it is stolen or moved to a different vehicle.

Audio Steering Wheel Controls

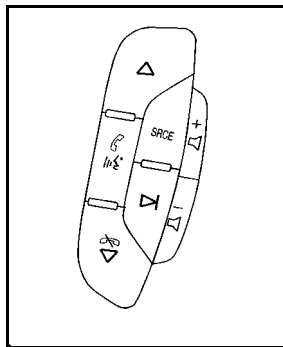

Vehicles with audio steering wheel controls could differ depending on the vehicle's options. Some audio controls can be adjusted at the steering wheel.

△ (Next): Press to go to the next radio station stored as a favorite, or the next track if a CD/DVD is playing.



▽ (Previous/End): Press to go to the previous radio station stored as a favorite, the next track if a CD/DVD is playing, to reject an incoming call, or end a current call.



☎ (Mute/Push to Talk): Press to silence the vehicle speakers only. Press again to turn the sound on.

For vehicles with Bluetooth or OnStar® systems press and hold for longer than two seconds to interact with those systems. See *Bluetooth® on page 4-110* or the *OnStar Owner's Guide* for more information.

SRCE (Source): Press to switch between the radio (AM, FM, XM), CD, and for vehicles with, DVD, front auxiliary, and rear auxiliary.

For vehicles with the navigation system, press and hold this button for longer than two seconds to initiate voice recognition. See "Voice Recognition" in the Navigation System manual for more information.

+  -  **(Volume):** Press to increase or to decrease the radio volume.

 **(Seek):** Press to go to the next radio station while in AM, FM, or XM™. Press  to go to the next track or chapter while sourced to the CD or DVD slot. Press the  if multiple discs are loaded to go to the next disc while sourced to a CD player.

Radio Reception

Frequency interference and static can occur during normal radio reception if items such as cell phone chargers, vehicle convenience accessories, and external electronic devices are plugged into the accessory power outlet. If there is interference or static, unplug the item from the accessory power outlet.

AM

The range for most AM stations is greater than for FM, especially at night. The longer range can cause station frequencies to interfere with each other. For better radio reception, most AM radio stations boost the power levels during the day, and then reduce these levels during the night. Static can also occur when things like storms and power lines interfere with radio reception. When this happens, try reducing the treble on the radio.

FM Stereo

FM signals only reach about 10 to 40 miles (16 to 65 km). Although the radio has a built-in electronic circuit that automatically works to reduce interference, some static can occur, especially around tall buildings or hills, causing the sound to fade in and out.

XM™ Satellite Radio Service

XM Satellite Radio Service gives digital radio reception from coast-to-coast in the 48 contiguous United States, and in Canada. Just as with FM, tall buildings or hills can interfere with satellite radio signals, causing the sound to fade in and out. In addition, traveling or standing under heavy foliage, bridges, garages, or tunnels may cause loss of the XM signal for a period of time.

Cellular Phone Usage

Cellular phone usage may cause interference with the vehicle's radio. This interference may occur when making or receiving phone calls, charging the phone's battery, or simply having the phone on. This interference causes an increased level of static while listening to the radio. If static is received while listening to the radio, unplug the cellular phone and turn it off.

Backglass Antenna

The AM-FM antenna is integrated with the rear window defogger, located in the rear window. Make sure that the inside surface of the rear window is not scratched and that the lines on the glass are not damaged. If the inside surface is damaged, it could interfere with radio reception. For proper radio reception, the antenna connector needs to be properly attached to the post on the glass.

If a cellular telephone antenna needs to be attached to the glass, make sure that the grid lines for the AM-FM antenna are not damaged. There is enough space between the grid lines to attach a cellular telephone antenna without interfering with radio reception.

Notice: Using a razor blade or sharp object to clear the inside rear window can damage the rear window antenna and/or the rear window defogger. Repairs would not be covered by the vehicle warranty. Do not clear the inside rear window with sharp objects.

Notice: Do not apply aftermarket glass tinting with metallic film. The metallic film in some tinting materials will interfere with or distort the incoming radio reception. Any damage caused to your backglass antenna due to metallic tinting materials will not be covered by the vehicle warranty.

XM™ Satellite Radio Antenna System

The XM Satellite Radio antenna is located on the roof of the vehicle. Keep the antenna clear of obstructions for clear radio reception.

If the vehicle has a sunroof, the performance of the XM system may be affected if the sunroof is open.

Section 5 Driving Your Vehicle

Your Driving, the Road, and the Vehicle	5-2	Driving at Night	5-11
Defensive Driving	5-2	Driving in Rain and on Wet Roads	5-12
Drunk Driving	5-2	Before Leaving on a Long Trip	5-13
Control of a Vehicle	5-3	Highway Hypnosis	5-13
Braking	5-3	Hill and Mountain Roads	5-14
Antilock Brake System (ABS)	5-4	Winter Driving	5-15
Braking in Emergencies	5-5	If Your Vehicle is Stuck in Sand, Mud, Ice, or Snow	5-17
StabiliTrak [®] System	5-5	Rocking Your Vehicle to Get It Out	5-17
Traction Control System (TCS)	5-6	Loading the Vehicle	5-18
Magnetic Ride Control [™]	5-7	Towing	5-24
Steering	5-8	Towing Your Vehicle	5-24
Off-Road Recovery	5-9	Recreational Vehicle Towing	5-24
Passing	5-10	Towing a Trailer	5-26
Loss of Control	5-10		

Your Driving, the Road, and the Vehicle

Defensive Driving

Defensive driving means “always expect the unexpected.” The first step in driving defensively is to wear your safety belt — See *Safety Belts: They Are for Everyone* on page 2-12.

WARNING:

Assume that other road users (pedestrians, bicyclists, and other drivers) are going to be careless and make mistakes. Anticipate what they might do and be ready. In addition:

- Allow enough following distance between you and the driver in front of you.
- Focus on the task of driving.

Driver distraction can cause collisions resulting in injury or possible death. These simple defensive driving techniques could save your life.

Drunk Driving

WARNING:

Drinking and then driving is very dangerous. Your reflexes, perceptions, attentiveness, and judgment can be affected by even a small amount of alcohol. You can have a serious — or even fatal — collision if you drive after drinking. Do not drink and drive or ride with a driver who has been drinking. Ride home in a cab; or if you are with a group, designate a driver who will not drink.

Death and injury associated with drinking and driving is a global tragedy.

Alcohol affects four things that anyone needs to drive a vehicle: judgment, muscular coordination, vision, and attentiveness.

Police records show that almost 40 percent of all motor vehicle-related deaths involve alcohol. In most cases, these deaths are the result of someone who was drinking and driving. In recent years, more than 17,000 annual motor vehicle-related deaths have been associated with the use of alcohol, with about 250,000 people injured.

For persons under 21, it is against the law in every U.S. state to drink alcohol. There are good medical, psychological, and developmental reasons for these laws.

The obvious way to eliminate the leading highway safety problem is for people never to drink alcohol and then drive.

Medical research shows that alcohol in a person's system can make crash injuries worse, especially injuries to the brain, spinal cord, or heart. This means that when anyone who has been drinking — driver or passenger — is in a crash, that person's chance of being killed or permanently disabled is higher than if the person had not been drinking.

Control of a Vehicle

The following three systems help to control the vehicle while driving — brakes, steering, and accelerator. At times, as when driving on snow or ice, it is easy to ask more of those control systems than the tires and road can provide. Meaning, you can lose control of the vehicle. See *Traction Control System (TCS) on page 5-6*.

Adding non-dealer/non-retailer accessories can affect vehicle performance. See *Accessories and Modifications on page 6-3*.

Braking

See *Brake System Warning Light on page 4-51*.

Braking action involves perception time and reaction time. Deciding to push the brake pedal is perception time. Actually doing it is reaction time.

Average reaction time is about three-fourths of a second. But that is only an average. It might be less with one driver and as long as two or three seconds or more with another. Age, physical condition, alertness, coordination, and eyesight all play a part. So do alcohol, drugs, and frustration. But even in three-fourths of a second, a vehicle moving at 100 km/h (60 mph) travels 20 m (66 feet). That could be a lot of distance in an emergency, so keeping enough space between the vehicle and others is important.

And, of course, actual stopping distances vary greatly with the surface of the road, whether it is pavement or gravel; the condition of the road, whether it is wet, dry, or icy; tire tread; the condition of the brakes; the weight of the vehicle; and the amount of brake force applied.

Avoid needless heavy braking. Some people drive in spurts, heavy acceleration followed by heavy braking, rather than keeping pace with traffic. This is a mistake. The brakes might not have time to cool between hard stops. The brakes will wear out much faster with a lot of heavy braking.

Keeping pace with the traffic and allowing realistic following distances eliminates a lot of unnecessary braking. That means better braking and longer brake life.

If the engine ever stops while the vehicle is being driven, brake normally but do not pump the brakes. If the brakes are pumped, the pedal could get harder to push down. If the engine stops, there will still be some power brake assist but it will be used when the brake is applied. Once the power assist is used up, it can take longer to stop and the brake pedal will be harder to push.

Adding non-dealer/non-retailer accessories can affect vehicle performance. See *Accessories and Modifications on page 6-3*.

Antilock Brake System (ABS)

This vehicle has the Antilock Brake System (ABS), an advanced electronic braking system that helps prevent a braking skid.

When the engine is started and the vehicle begins to drive away, ABS checks itself. A momentary motor or clicking noise might be heard while this test is going on, and it might even be noticed that the brake pedal moves a little. This is normal.

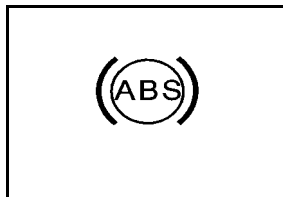

If there is a problem with ABS, this warning light stays on. See *Antilock Brake System (ABS) Warning Light on page 4-52*.

Let us say the road is wet and you are driving safely. Suddenly, an animal jumps out in front of you. You slam on the brakes and continue braking. Here is what happens with ABS:

A computer senses that the wheels are slowing down. If one of the wheels is about to stop rolling, the computer will separately work the brakes at each front wheel and at both rear wheels.

ABS can change the brake pressure to each wheel, as required, faster than any driver could. This can help the driver steer around the obstacle while braking hard.

As the brakes are applied, the computer keeps receiving updates on wheel speed and controls braking pressure accordingly.

Remember: ABS does not change the time needed to get a foot up to the brake pedal or always decrease stopping distance. If you get too close to the vehicle in front of you, there will not be enough time to apply the brakes if that vehicle suddenly slows or stops. Always leave enough room up ahead to stop, even with ABS.

Using ABS

Do not pump the brakes. Just hold the brake pedal down firmly and let antilock work. The antilock pump or motor operating might be heard and the brake pedal might be felt to pulsate, but this is normal.

Braking in Emergencies

ABS allows the driver to steer and brake at the same time. In many emergencies, steering can help more than even the very best braking.

Brake Assist

This vehicle has a Brake Assist feature designed to assist the driver in stopping or decreasing vehicle speed in emergency driving conditions. This feature uses the stability system hydraulic brake control module to supplement the power brake system under conditions where the driver has quickly and forcefully applied the brake pedal in an attempt to quickly stop or slow down the vehicle. The stability system hydraulic brake control module increases brake pressure at each corner of the

vehicle until the ABS activates. Minor brake pedal pulsations or pedal movement during this time is normal and the driver should continue to apply the brake pedal as the driving situation dictates. The Brake Assist feature will automatically disengage when the brake pedal is released or brake pedal pressure is quickly decreased.

StabiliTrak[®] System

The vehicle may have the StabiliTrak system which combines antilock brake, traction and stability control systems and helps the driver maintain directional control of the vehicle in most driving conditions. This is accomplished by selectively applying any one of the vehicle's brakes and reducing engine power.

The StabiliTrak system comes on automatically whenever the vehicle is started. The system cannot be turned off.



This light will flash when the system is operating.

The STABILITRAK NOT READY message may be displayed in the Driver Information Center (DIC) and the Traction Control System (TCS)/StabiliTrak warning light on the instrument panel cluster comes on after first driving the vehicle and exceeding 19 mph (30 km/h) for 30 seconds. The StabiliTrak system is off until the light has turned off. This could take up to 15 minutes.

The TCS/StabiliTrak warning light on the instrument panel cluster will flash when the system is operating. See *Traction Control System (TCS) Warning Light on page 4-52* and *StabiliTrak® Indicator Light on page 4-53* for more information. The system may be heard or felt while it is working. This is normal.

The SERVICE STABILITRAK message is displayed and the TCS/StabiliTrak warning light on the instrument panel cluster comes on if there is a problem with the system. When this light and the SERVICE STABILITRAK message are on, the system is not working. Adjust your driving accordingly.

Traction Control System (TCS)

The vehicle has a Traction Control System (TCS) that limits wheel spin. This is especially useful in slippery road conditions. The system operates only if it senses that the front wheels are spinning too much or beginning to lose traction. When this happens, the

system works the front brakes and reduces engine power (by closing the throttle and managing engine spark) to limit wheel spin.



The TCS and StabiliTrak® light will flash when the system is limiting wheel spin.

The system may be heard or felt while it is working, but this is normal. See *Traction Control System (TCS) Warning Light on page 4-52* for more information.

If the vehicle is in cruise control when TCS begins to limit wheel spin, the cruise control will automatically disengage. The cruise control may be re-engaged when road conditions allow. See *Cruise Control on page 4-11*.

The SERVICE TRACTION CONTROL message in the DIC and the TCS/StabiliTrak warning light comes on if there is a problem with the traction control system. See *DIC Warnings and Messages on page 4-66*.

When this light and the SERVICE TRACTION CONTROL message are on, the system will not limit wheel spin. Adjust your driving accordingly.

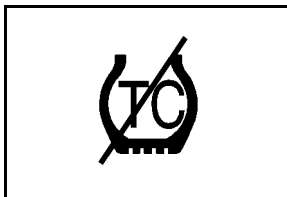

To turn the system off or on, press and release this button located in front of the shift lever.

TCS automatically comes on whenever the vehicle is started. To limit wheel spin, especially in slippery road conditions, always leave the system turned on. TCS can be turned off if needed.

The system can be turned on or off at any time by pressing the TCS button. The DIC will display TRACTION CONTROL OFF when the button is pressed, and part of the traction control system is disabled. The vehicle will still have brake-traction control, but will not be able to use the engine speed management system. System noises may be heard as a result of the brake-traction control working. If the controller detects excessive wheel spin in this mode, the TCS/StabiliTrak light may blink.

It is recommended to leave the system on for normal driving conditions, but it may be necessary to turn the system off if the vehicle is stuck in sand, mud, ice or snow, and you want to “rock” the vehicle to attempt to free it. See *If Your Vehicle is Stuck in Sand, Mud, Ice, or Snow* on page 5-17.

Adding non-dealer/non-retailer accessories can affect the vehicle's performance. See *Accessories and Modifications* on page 6-3 for more information.

Magnetic Ride Control™

The vehicle may have Magnetic Ride Control that automatically adjusts the ride of the vehicle. The controller receives input from the system to determine the proper ride. If the controller detects a problem within the system, the Driver Information Center (DIC) displays a SERVICE SUSPENSION SYS message. See *DIC Warnings and Messages* on page 4-66 for more information. If this message appears, have the vehicle serviced at your dealer.

Electronically Controlled Air Ride Suspension

Professional Vehicles may have Electronically Controlled Air Suspension. The air ride controller receives input from the system to determine the proper ride. If the controller detects a problem with the system, the DIC will display a SERVICE SUSPENSION SYS message. If this message appears, have the vehicle serviced at your dealer.

Steering

Power Steering

If power steering assist is lost because the engine stops or the system is not functioning, the vehicle can be steered but it will take more effort.

Magnetic Speed Variable Assist Steering System

This system continuously adjusts the effort felt when steering at all vehicle speeds. It provides ease when parking, yet a firm, solid feel at highway speeds.

Steering Tips

It is important to take curves at a reasonable speed.

Traction in a curve depends on the condition of the tires and the road surface, the angle at which the curve is banked, and vehicle speed. While in a curve, speed is the one factor that can be controlled.

If there is a need to reduce speed, do it before entering the curve, while the front wheels are straight.

Try to adjust the speed so you can drive through the curve. Maintain a reasonable, steady speed. Wait to accelerate until out of the curve, and then accelerate gently into the straightaway.

Steering in Emergencies

There are times when steering can be more effective than braking. For example, you come over a hill and find a truck stopped in your lane, or a car suddenly pulls out from nowhere, or a child darts out from between parked cars and stops right in front of you. These problems can be avoided by braking — if you can stop in time. But sometimes you cannot stop in time because there is no room. That is the time for evasive action — steering around the problem.

The vehicle can perform very well in emergencies like these. First apply the brakes. See *Braking on page 5-3*. It is better to remove as much speed as possible from a collision. Then steer around the problem, to the left or right depending on the space available.

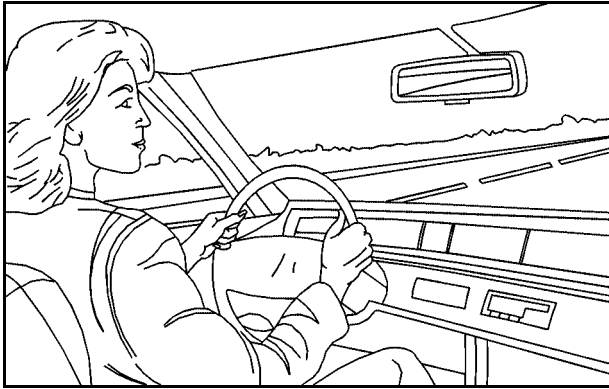

An emergency like this requires close attention and a quick decision. If holding the steering wheel at the recommended 9 and 3 o'clock positions, it can be turned a full 180 degrees very quickly without removing either hand. But you have to act fast, steer quickly, and just as quickly straighten the wheel once you have avoided the object.

The fact that such emergency situations are always possible is a good reason to practice defensive driving at all times and wear safety belts properly.

Off-Road Recovery

The vehicle's right wheels can drop off the edge of a road onto the shoulder while driving.

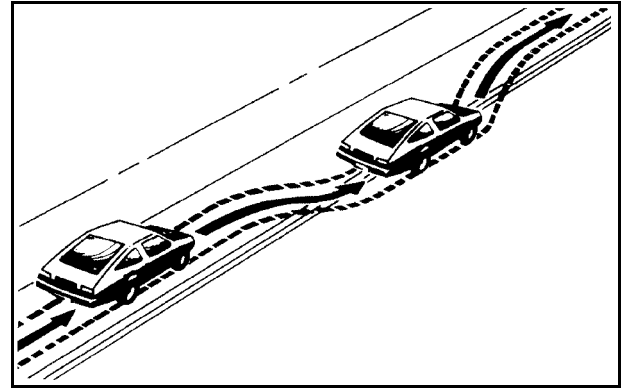

If the level of the shoulder is only slightly below the pavement, recovery should be fairly easy. Ease off the accelerator and then, if there is nothing in the way, steer so that the vehicle straddles the edge of the pavement. Turn the steering wheel 8 to 13 cm (3 to 5 inches), about one-eighth turn, until the right front tire contacts the pavement edge. Then turn the steering wheel to go straight down the roadway.

Passing

Passing another vehicle on a two-lane road can be dangerous. To reduce the risk of danger while passing:

- Look down the road, to the sides, and to crossroads for situations that might affect a successful pass. If in doubt, wait.
- Watch for traffic signs, pavement markings, and lines that could indicate a turn or an intersection. Never cross a solid or double-solid line on your side of the lane.
- Do not get too close to the vehicle you want to pass. Doing so can reduce your visibility.
- Wait your turn to pass a slow vehicle.
- When you are being passed, ease to the right.

Loss of Control

Let us review what driving experts say about what happens when the three control systems — brakes, steering, and acceleration — do not have enough friction where the tires meet the road to do what the driver has asked.

In any emergency, do not give up. Keep trying to steer and constantly seek an escape route or area of less danger.

Skidding

In a skid, a driver can lose control of the vehicle. Defensive drivers avoid most skids by taking reasonable care suited to existing conditions, and by not overdriving those conditions. But skids are always possible.

The three types of skids correspond to the vehicle's three control systems. In the braking skid, the wheels are not rolling. In the steering or cornering skid, too much speed or steering in a curve causes tires to slip and lose cornering force. And in the acceleration skid, too much throttle causes the driving wheels to spin.

Remember: Any traction control system helps avoid only the acceleration skid. If the traction control system is off, then an acceleration skid is best handled by easing your foot off the accelerator pedal.

If the vehicle starts to slide, ease your foot off the accelerator pedal and quickly steer the way you want the vehicle to go. If you start steering quickly enough, the vehicle may straighten out. Always be ready for a second skid if it occurs.

If the vehicle has StabiliTrak[®], the system may be active. See *StabiliTrak[®] System on page 5-5*.

Of course, traction is reduced when water, snow, ice, gravel, or other material is on the road. For safety, slow down and adjust your driving to these conditions.

It is important to slow down on slippery surfaces because stopping distance will be longer and vehicle control more limited.

While driving on a surface with reduced traction, try your best to avoid sudden steering, acceleration, or braking, including reducing vehicle speed by shifting to a lower gear. Any sudden changes could cause the tires to slide. You may not realize the surface is slippery until the vehicle is skidding. Learn to recognize warning clues — such as enough water, ice, or packed snow on the road to make a mirrored surface — and slow down when you have any doubt.

Remember: Antilock brakes help avoid only the braking skid.

Driving at Night

Night driving is more dangerous than day driving because some drivers are likely to be impaired — by alcohol or drugs, with night vision problems, or by fatigue.

Night driving tips include:

- Drive defensively.
- Do not drink and drive.
- Reduce headlamp glare by adjusting the inside rearview mirror.

- Slow down and keep more space between you and other vehicles because headlamps can only light up so much road ahead.
- Watch for animals.
- When tired, pull off the road.
- Do not wear sunglasses.
- Avoid staring directly into approaching headlamps.
- Keep the windshield and all glass on your vehicle clean — inside and out.
- Keep your eyes moving, especially during turns or curves.

No one can see as well at night as in the daytime.

But, as we get older, these differences increase.

A 50-year-old driver might need at least twice as much light to see the same thing at night as a 20-year-old.

Driving in Rain and on Wet Roads

Rain and wet roads can reduce vehicle traction and affect your ability to stop and accelerate. Always drive slower in these types of driving conditions and avoid driving through large puddles and deep-standing or flowing water.

WARNING:

Wet brakes can cause crashes. They might not work as well in a quick stop and could cause pulling to one side. You could lose control of the vehicle.

After driving through a large puddle of water or a car/vehicle wash, lightly apply the brake pedal until the brakes work normally.

Flowing or rushing water creates strong forces. Driving through flowing water could cause your vehicle to be carried away. If this happens, you and other vehicle occupants could drown. Do not ignore police warnings and be very cautious about trying to drive through flowing water.

Hydroplaning

Hydroplaning is dangerous. Water can build up under your vehicle's tires so they actually ride on the water. This can happen if the road is wet enough and you are going fast enough. When your vehicle is hydroplaning, it has little or no contact with the road.

There is no hard and fast rule about hydroplaning. The best advice is to slow down when the road is wet.

Other Rainy Weather Tips

Besides slowing down, other wet weather driving tips include:

- Allow extra following distance.
- Pass with caution.
- Keep windshield wiping equipment in good shape.
- Keep the windshield washer fluid reservoir filled.
- Have good tires with proper tread depth. See *Tires on page 6-50*.
- Turn off cruise control.

Before Leaving on a Long Trip

To prepare your vehicle for a long trip, consider having it serviced by your dealer before departing.

Things to check on your own include:

- *Windshield Washer Fluid*: Reservoir full? Windows clean — inside and outside?
- *Wiper Blades*: In good shape?
- *Fuel, Engine Oil, Other Fluids*: All levels checked?
- *Lamps*: Do they all work and are lenses clean?
- *Tires*: Are treads good? Are tires inflated to recommended pressure?
- *Weather and Maps*: Safe to travel? Have up-to-date maps?

Highway Hypnosis

Always be alert and pay attention to your surroundings while driving. If you become tired or sleepy, find a safe place to park your vehicle and rest.

Other driving tips include:

- Keep the vehicle well ventilated.
- Keep interior temperature cool.
- Keep your eyes moving — scan the road ahead and to the sides.
- Check the rearview mirror and vehicle instruments often.

Hill and Mountain Roads

Driving on steep hills or through mountains is different than driving on flat or rolling terrain. Tips for driving in these conditions include:

- Keep the vehicle serviced and in good shape.
- Check all fluid levels and brakes, tires, cooling system, and transmission.
- Going down steep or long hills, shift to a lower gear.

WARNING:

If you do not shift down, the brakes could get so hot that they would not work well. You would then have poor braking or even none going down a hill. You could crash. Shift down to let the engine assist the brakes on a steep downhill slope.

WARNING:

Coasting downhill in N (Neutral) or with the ignition off is dangerous. The brakes will have to do all the work of slowing down and they could get so hot that they would not work well. You would then have poor braking or even none going down a hill. You could crash. Always have the engine running and the vehicle in gear when going downhill.

- Stay in your own lane. Do not swing wide or cut across the center of the road. Drive at speeds that let you stay in your own lane.
- Top of hills: Be alert — something could be in your lane (stalled car, accident).
- Pay attention to special road signs (falling rocks area, winding roads, long grades, passing or no-passing zones) and take appropriate action.

Winter Driving

Driving on Snow or Ice

Drive carefully when there is snow or ice between the tires and the road, creating less traction or grip. Wet ice can occur at about 0°C (32°F) when freezing rain begins to fall, resulting in even less traction. Avoid driving on wet ice or in freezing rain until roads can be treated with salt or sand.

Drive with caution, whatever the condition. Accelerate gently so traction is not lost. Accelerating too quickly causes the wheels to spin and makes the surface under the tires slick, so there is even less traction.

Try not to break the fragile traction. If you accelerate too fast, the drive wheels will spin and polish the surface under the tires even more.

The *Traction Control System (TCS)* on page 5-6 improves the ability to accelerate on slippery roads, but slow down and adjust your driving to the road conditions. When driving through deep snow, turn off the traction control system to help maintain vehicle motion at lower speeds.

The *Antilock Brake System (ABS)* on page 5-4 improves vehicle stability during hard stops on a slippery roads, but apply the brakes sooner than when on dry pavement.

Allow greater following distance on any slippery road and watch for slippery spots. Icy patches can occur on otherwise clear roads in shaded areas. The surface of a curve or an overpass can remain icy when the surrounding roads are clear. Avoid sudden steering maneuvers and braking while on ice.

Turn off cruise control, if equipped, on slippery surfaces.

Blizzard Conditions

Being stuck in snow can be in a serious situation. Stay with the vehicle unless there is help nearby. If possible, use the *Roadside Service on page 8-7*. To get help and keep everyone in the vehicle safe:

- Turn on the *Hazard Warning Flashers on page 4-3*.
- Tie a red cloth to an outside mirror.

WARNING:

Snow can trap engine exhaust under the vehicle. This may cause exhaust gases to get inside. Engine exhaust contains carbon monoxide (CO) which cannot be seen or smelled. It can cause unconsciousness and even death.

If the vehicle is stuck in the snow:

- Clear away snow from around the base of your vehicle, especially any that is blocking the exhaust pipe.
- Check again from time to time to be sure snow does not collect there.

(Continued)

WARNING: (Continued)

- Open a window about 5 cm (two inches) on the side of the vehicle that is away from the wind to bring in fresh air.
- Fully open the air outlets on or under the instrument panel.
- Adjust the Climate Control system to a setting that circulates the air inside the vehicle and set the fan speed to the highest setting. See Climate Control System in the Index.

For more information about carbon monoxide, see *Engine Exhaust on page 3-34*.

Snow can trap exhaust gases under your vehicle. This can cause deadly CO (carbon monoxide) gas to get inside. CO could overcome you and kill you. You cannot see it or smell it, so you might not know it is in your vehicle. Clear away snow from around the base of your vehicle, especially any that is blocking the exhaust.

To save fuel, run the engine for only short periods as needed to warm the vehicle and then shut the engine off and close the window most of the way to save heat.

Repeat this until help arrives but only when you feel really uncomfortable from the cold. Moving about to keep warm also helps.

If it takes some time for help to arrive, now and then when you run the engine, push the accelerator pedal slightly so the engine runs faster than the idle speed. This keeps the battery charged to restart the vehicle and to signal for help with the headlamps. Do this as little as possible to save fuel.

If Your Vehicle is Stuck in Sand, Mud, Ice, or Snow

Slowly and cautiously spin the wheels to free the vehicle when stuck in sand, mud, ice, or snow. See *Rocking Your Vehicle to Get It Out* on page 5-17.

If the vehicle has a traction system, it can often help to free a stuck vehicle. Refer to the vehicle's traction system in the Index. If stuck too severely for the traction system to free the vehicle, turn the traction system off and use the rocking method.

WARNING:

If the vehicle's tires spin at high speed, they can explode, and you or others could be injured. The vehicle can overheat, causing an engine compartment fire or other damage. Spin the wheels as little as possible and avoid going above 55 km/h (35 mph) as shown on the speedometer.

For information about using tire chains on the vehicle, see *Tire Chains* on page 6-75.

Rocking Your Vehicle to Get It Out

Turn the steering wheel left and right to clear the area around the front wheels. Turn off any traction or stability system. Shift back and forth between R (Reverse) and a forward gear, spinning the wheels as little as possible. To prevent transmission wear, wait until the wheels stop spinning before shifting gears. Release the accelerator pedal while shifting, and press lightly on the accelerator pedal when the transmission is in gear. Slowly spinning the wheels in the forward and reverse directions causes a rocking motion that could free the vehicle. If that does not get the vehicle out after a few tries, it might need to be towed out. If the vehicle does need to be towed out, see *Towing Your Vehicle* on page 5-24.

Loading the Vehicle

It is very important to know how much weight your vehicle can carry. This weight is called the vehicle capacity weight and includes the weight of all occupants, cargo, and all nonfactory-installed options. Two labels on your vehicle show how much weight it may properly carry, the Tire and Loading Information label and the Certification label.

WARNING:

Do not load the vehicle any heavier than the Gross Vehicle Weight Rating (GVWR), or either the maximum front or rear Gross Axle Weight Rating (GAWR). If you do, parts on the vehicle can break, and it can change the way the vehicle handles. These could cause you to lose control and crash. Also, overloading can shorten the life of the vehicle.

Tire and Loading Information Label

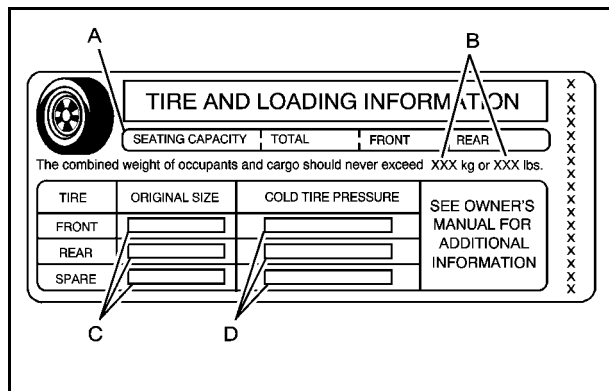

The diagram shows a rectangular label titled "TIRE AND LOADING INFORMATION". On the left side, there is a tire icon with callout 'A' pointing to it. Below the title, there are four columns: "SEATING CAPACITY", "TOTAL", "FRONT", and "REAR". Callout 'B' points to the "TOTAL" column. Below these columns, there is a line of text: "The combined weight of occupants and cargo should never exceed XXX kg or XXX lbs." Below this text is a table with three columns: "TIRE", "ORIGINAL SIZE", and "COLD TIRE PRESSURE". The rows are "FRONT", "REAR", and "SPARE". Callout 'C' points to the "FRONT" row, and callout 'D' points to the "COLD TIRE PRESSURE" column. To the right of the table is a box that says "SEE OWNER'S MANUAL FOR ADDITIONAL INFORMATION". The right edge of the label has a vertical line of 'X' characters.

TIRE	ORIGINAL SIZE	COLD TIRE PRESSURE		SEE OWNER'S MANUAL FOR ADDITIONAL INFORMATION
FRONT				
REAR				
SPARE				

Label Example

A vehicle specific Tire and Loading Information label is attached to the vehicle's center pillar (B-pillar). With the driver's door open, you will find the label attached below the door lock post (striker). The Tire and Loading Information label shows the number of occupant seating positions (A), and the maximum vehicle capacity weight (B) in kilograms and pounds.

The Tire and Loading Information label also shows the tire size of the original equipment tires (C) and the recommended cold tire inflation pressures (D). For more information on tires and inflation see *Tires on page 6-50* and *Inflation - Tire Pressure on page 6-59*.

There is also important loading information on the Certification label. It tells you the Gross Vehicle Weight Rating (GVWR) and the Gross Axle Weight Rating (GAWR) for the front and rear axle; see "Certification Label" later in this section.

If you have a Professional Vehicle, a Tire and Loading Information label specific to your vehicle will be provided and installed by the final body manufacturer. The Tire and Loading Information label, should be attached to the B-pillar of your vehicle. See the final stage manufacturer's manual or contact them directly. The label shows the original tires installed on your professional vehicle and the recommended cold tire inflation pressures for those tires. The label also tells you the professional vehicle's capacity weight.

Steps for Determining Correct Load Limit

1. Locate the statement "The combined weight of occupants and cargo should never exceed XXX kg or XXX lbs" on your vehicle's placard.
2. Determine the combined weight of the driver and passengers that will be riding in your vehicle.
3. Subtract the combined weight of the driver and passengers from XXX kg or XXX lbs.
4. The resulting figure equals the available amount of cargo and luggage load capacity. For example, if the "XXX" amount equals 1400 lbs and there will be five 150 lb passengers in your vehicle, the amount of available cargo and luggage load capacity is 650 lbs ($1400 - 750 (5 \times 150) = 650$ lbs).

5. Determine the combined weight of luggage and cargo being loaded on the vehicle. That weight may not safely exceed the available cargo and luggage load capacity calculated in Step 4.
6. If your vehicle will be towing a trailer, the load from your trailer will be transferred to your vehicle. Consult this manual to determine how this reduces the available cargo and luggage load capacity of your vehicle.

If your vehicle can tow a trailer, see “Towing a Trailer” for important information on towing a trailer, towing safety rules, and trailering tips.

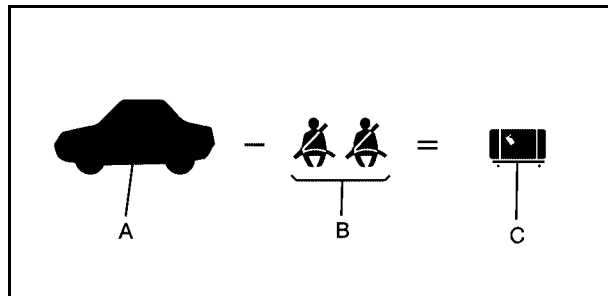

Example 1

Item	Description	Total
A	Vehicle Capacity Weight for Example 1 =	1,000 lbs (453 kg)
B	Subtract Occupant Weight @ 150 lbs (68 kg) × 2 =	300 lbs (136 kg)
C	Available Occupant and Cargo Weight =	700 lbs (317 kg)

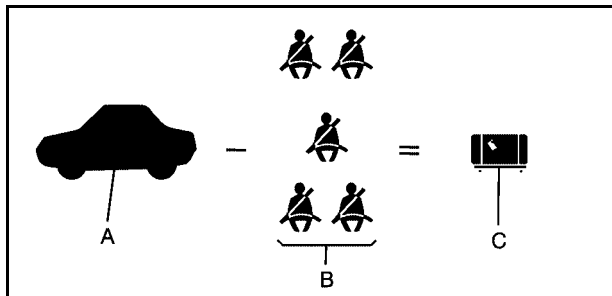

Example 2

Item	Description	Total
A	Vehicle Capacity Weight for Example 2 =	1,000 lbs (453 kg)
B	Subtract Occupant Weight @ 150 lbs (68 kg) × 5 =	750 lbs (340 kg)
C	Available Cargo Weight =	250 lbs (113 kg)

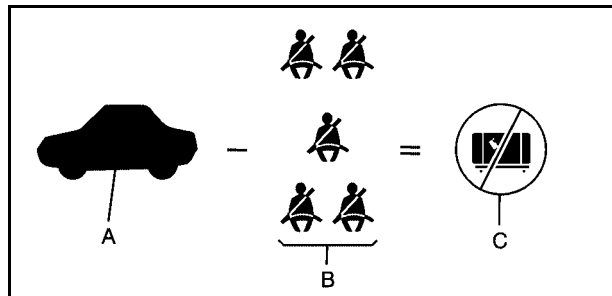

Example 3

Item	Description	Total
A	Vehicle Capacity Weight for Example 3 =	1,000 lbs (453 kg)
B	Subtract Occupant Weight @ 200 lbs (91 kg) × 5 =	1,000 lbs (453 kg)
C	Available Cargo Weight =	0 lbs (0 kg)

Refer to your vehicle's Tire and Loading Information label for specific information about your vehicle's capacity weight and seating

positions. The combined weight of the driver, passengers, and cargo should never exceed your vehicle's capacity weight.

Certification Label

The image shows a GM Certification Label with the following text and fields:

GM MFD BY GENERAL MOTORS CORP

DATE	GVWR	GAWR FRT	GAWR RR

THIS VEHICLE CONFORMS TO ALL APPLICABLE U.S. FEDERAL MOTOR VEHICLE SAFETY, BUMPER, AND TRAFFIC PREVENTION STANDARDS IN EFFECT ON THE DATE OF MANUFACTURE SHOWN ABOVE.

200 PASS CAR

EXAMPLE

A vehicle specific Certification label is attached to the rear edge of the driver's door. This label shows the gross weight capacity of your vehicle, called the Gross Vehicle Weight Rating (GVWR). The GVWR includes the weight of the vehicle, all occupants, fuel, and cargo. Never exceed the GVWR for your vehicle, or the Gross Axle Weight Rating (GAWR) for either the front or rear axle.

If your vehicle is a Professional Vehicle, the vehicle specific Certification label is provided by the final stage manufacturer. The coach-builder should be consulted if the final stage manufacturer's label is not present. The Gross Vehicle Weight Rating GVWR label should be on the driver's door edge.

If you do have a heavy load, you should spread it out. See "Steps for Determining Correct Load Limit" earlier in this section.

WARNING:

Do not load the vehicle any heavier than the Gross Vehicle Weight Rating (GVWR), or either the maximum front or rear Gross Axle Weight Rating (GAWR). If you do, parts on the vehicle can break, and it can change the way the vehicle handles. These could cause you to lose control and crash. Also, overloading can shorten the life of the vehicle.

Notice : Overloading the vehicle may cause damage. Repairs would not be covered by the vehicle warranty. Do not overload the vehicle.

If you put things inside your vehicle, like suitcases, tools, packages, or anything else, they will go as fast as the vehicle goes. If you have to stop or turn quickly, or if there is a crash, they will keep going.

 **WARNING:**

Things you put inside your vehicle can strike and injure people in a sudden stop or turn, or in a crash.

- Put things in the trunk of your vehicle. In a trunk, put them as far forward as you can. Try to spread the weight evenly.
- Never stack heavier things, like suitcases, inside the vehicle so that some of them are above the tops of the seats.
- Do not leave an unsecured child restraint in your vehicle.
- When you carry something inside the vehicle, secure it whenever you can.

Automatic Level Control

This feature keeps the rear of your vehicle level as the load changes. It is automatic, you do not need to adjust anything.

This type of level control is fully automatic and will provide a better leveled riding position as well as better handling under a variety of passenger and loading conditions. An air compressor connected to the rear shocks will raise or lower the rear of the vehicle to maintain proper vehicle height. The system is activated when the ignition key is turned to ON/RUN and will automatically adjust vehicle height thereafter. The system may exhaust (lower vehicle height) for up to ten minutes after the ignition key has been turned to LOCK/OFF. You may hear the air compressor operating when the height is being adjusted.

Towing

Towing Your Vehicle

Consult your dealer or a professional towing service if the disabled vehicle must be towed. See *Roadside Service on page 8-7*.

To tow the vehicle behind another vehicle for recreational purposes (such as behind a motorhome), see "Recreational Vehicle Towing" following.

Recreational Vehicle Towing

Recreational vehicle towing means towing the vehicle behind another vehicle – such as behind a motorhome. The two most common types of recreational vehicle towing are known as dinghy towing and dolly towing. Dinghy towing is towing the vehicle with all four wheels on the ground. Dolly towing is towing the vehicle with two wheels on the ground and two wheels up on a device known as a dolly.

Here are some important things to consider before recreational vehicle towing:

- What's the towing capacity of the towing vehicle? Be sure to read the tow vehicle manufacturer's recommendations.
- How far will the vehicle be towed? Some vehicles have restrictions on how far and how long they can tow.
- Does the vehicle have the proper towing equipment? See your dealer or trailering professional for additional advice and equipment recommendations.
- Is the vehicle ready to be towed? Just as preparing the vehicle for a long trip, make sure the vehicle is prepared to be towed. See *Before Leaving on a Long Trip on page 5-13*.

Dinghy Towing

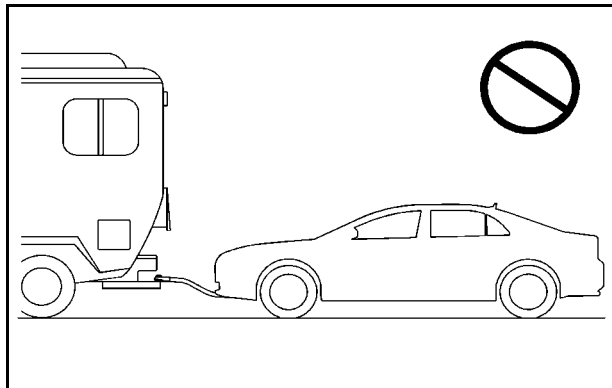

Notice: If the vehicle is towed with all four wheels on the ground, the drivetrain components could be damaged. The repairs would not be covered by the vehicle warranty. Do not tow the vehicle with all four wheels on the ground.

The vehicle was not designed to be towed with all four wheels on the ground. Use a dolly if the vehicle must be towed. See "Dolly Towing" later in this section for more information.

Dolly Towing

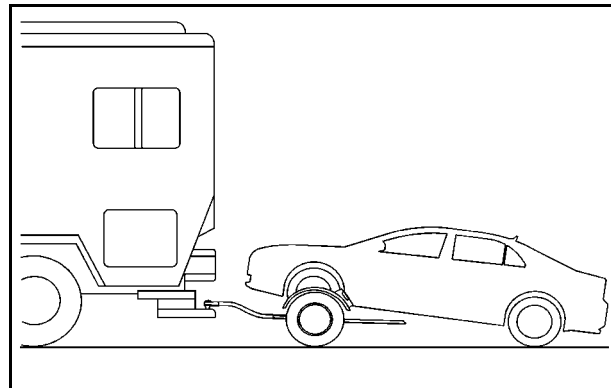

The vehicle can be towed using a dolly. To tow the vehicle using a dolly, follow these steps:

1. Put the front wheels on a dolly.
2. Put the gear shift lever in P (Park).
3. Set the parking brake.
4. Clamp the steering wheel in a straight-ahead position with a clamping device designed for towing.

5. Remove the key from the ignition.
6. Secure the vehicle to the dolly.
7. Release the parking brake.

Towing a Trailer

The Cadillac Professional Vehicle cannot tow a trailer.

WARNING:

The driver can lose control when pulling a trailer if the correct equipment is not used or the vehicle is not driven properly. For example, if the trailer is too heavy, the brakes may not work well — or even at all. The driver and passengers could be seriously injured. The vehicle may also be damaged; the resulting repairs would not be covered by the vehicle warranty. Pull a trailer only if all the steps in this section have been followed. Ask your dealer for advice and information about towing a trailer with the vehicle.

Notice: Pulling a trailer improperly can damage the vehicle and result in costly repairs not covered by the vehicle warranty. To pull a trailer correctly, follow the advice in this section and see your dealer for important information about towing a trailer with the vehicle.

The vehicle can tow a trailer if it is equipped with the proper trailer towing equipment. To identify the trailering capacity of the vehicle, read the information in “Weight of the Trailer” that appears later in this section. Trailering is different than just driving the vehicle by itself. Trailering means changes in handling, acceleration, braking, durability and fuel economy. Successful, safe trailering takes correct equipment, and it has to be used properly.

The following information has many time-tested, important trailering tips and safety rules. Many of these are important for the safety of the driver and the passengers. So please read this section carefully before pulling a trailer.

Load-pulling components such as the engine, transmission, axles, wheel assemblies and tires are forced to work harder against the drag of the added weight. The engine is required to operate at relatively higher speeds and under greater loads, generating extra heat. The trailer also adds considerably to wind resistance, increasing the pulling requirements.

Pulling A Trailer

Here are some important points:

- There are many different laws, including speed limit restrictions, having to do with trailering. Make sure the rig will be legal, not only where you live but also where you will be driving. A good source for this information can be state or provincial police.
- Do not tow a trailer at all during the first 1,000 miles (1600 km) the new vehicle is driven. The engine, transmission or other parts could be damaged. The repairs would not be covered by the vehicle's warranty.
- Then, during the first 500 miles (800 km) that a trailer is towed, do not drive over 50 mph (80 km/h) and do not make starts at full throttle. This helps the engine and other parts of the vehicle wear in at the heavier loads.
- Vehicles can tow in D (Drive). Shift the transmission to a lower gear if the transmission shifts too often under heavy loads and/or hilly conditions.
- Obey speed limit restrictions when towing a trailer. Do not drive faster than the maximum posted speed for trailers, or no more than 55 mph (90 km/h), to save wear on the vehicle's parts.

- Do not tow a trailer when the outside temperature is above 100°F (38°C).
- If the vehicle has the Side Blind Zone Alert (SBZA) system and it doesn't seem to be working properly while pulling a trailer, turn the system off. See *Side Blind Zone Alert (SBZA) on page 3-43* for more information.

Three important considerations have to do with weight:

- The weight of the trailer
- The weight of the trailer tongue
- The total weight on the vehicle's tires

Weight of the Trailer

How heavy can a trailer safely be?

It should never weigh more than 1,000 lbs (454 kg). But even that can be too heavy.

It depends on how the rig is used. For example, speed, altitude, road grades, outside temperature and how much the vehicle is used to pull a trailer are all important. It can depend on any special equipment on the vehicle, and the amount of tongue weight the vehicle can carry. See "Weight of the Trailer Tongue" later in this section for more information.

Maximum trailer weight is calculated assuming only the driver is in the tow vehicle and it has all the required trailering equipment. The weight of additional optional equipment, passengers and cargo in the tow vehicle must be subtracted from the maximum trailer weight.

Ask your dealer for trailering information or advice, or write us at our Customer Assistance Offices. See *Customer Assistance Offices on page 8-6* for more information.

Weight of the Trailer Tongue

The tongue load (A) of any trailer is an important weight to measure because it affects the total gross weight of the vehicle. The Gross Vehicle Weight (GVW) includes the curb weight of the vehicle, any cargo carried in it, and the people who will be riding in the vehicle. If there are a lot of options, equipment, passengers or cargo in the vehicle, it will reduce the tongue weight the vehicle can carry, which will also reduce the trailer weight the vehicle can tow. If towing a trailer, the tongue load must be added to the GVW because the vehicle will be carrying that weight, too. See *Loading the Vehicle on page 5-18* for more information about the vehicle's maximum load capacity.

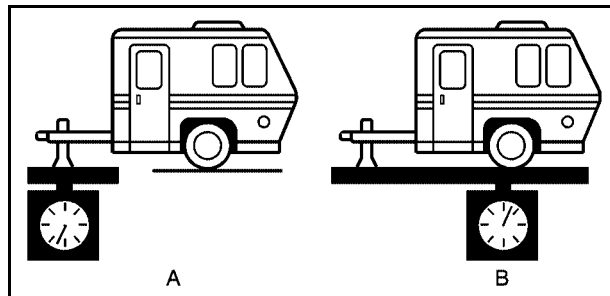

Using a weight-carrying hitch, the trailer tongue (A) should weigh 10 to 15 percent of the total loaded trailer weight (B).

After loading the trailer, weigh the trailer and then the tongue, separately, to see if the weights are proper. If they are not, adjustments might be made by moving some items around in the trailer.

Total Weight on the Vehicle's Tires

Be sure the vehicle's tires are inflated to the upper limit for cold tires. These numbers can be found on the Certification/Tire label. See *Loading the Vehicle on page 5-18*. Make sure not to go over the GVW limit for the vehicle, including the weight of the trailer tongue.

Hitches

It is important to have the correct hitch equipment. Crosswinds, large trucks going by and rough roads are a few reasons why the right hitch is needed. Here are some rules to follow:

- The rear bumper on the vehicle is not intended for hitches. Do not attach rental hitches or other bumper-type hitches to it. Use only a frame-mounted hitch that does not attach to the bumper.
- Will any holes be made in the body of the vehicle when the trailer hitch is installed? If there are, then be sure to seal the holes later when the hitch is removed. If the holes are not sealed, dirt, water, and deadly carbon monoxide (CO) from the exhaust can get into the vehicle. See *Engine Exhaust on page 3-34* for more information.

Safety Chains

Always attach chains between the vehicle and the trailer. Cross the safety chains under the tongue of the trailer to help prevent the tongue from contacting the road if it becomes separated from the hitch. Instructions about safety chains may be provided by the hitch manufacturer or by the trailer manufacturer. Follow the manufacturer's recommendation for attaching safety chains and do not attach them to the bumper. Always leave just enough slack so the rig can turn. Never allow safety chains to drag on the ground.

Trailer Brakes

Because the vehicle has StabiliTrak[®], do not tap into the vehicle's hydraulic brake system. If you do, both brake systems will not work well, or at all.

Be sure to read and follow the instructions for the trailer brakes so they are installed, adjusted and maintained properly.

Driving with a Trailer

Towing a trailer requires a certain amount of experience. Get to know the rig before setting out for the open road. Get acquainted with the feel of handling and braking with the added weight of the trailer. And always keep in mind that the vehicle you are driving is now longer and not as responsive as the vehicle is by itself.

Before starting, check all trailer hitch parts and attachments, safety chains, electrical connectors, lamps, tires and mirror adjustments. If the trailer has electric brakes, start the vehicle and trailer moving and then apply the trailer brake controller by hand to be sure the brakes are working. This checks the electrical connection at the same time.

During the trip, check occasionally to be sure that the load is secure, and that the lamps and any trailer brakes are still working.

Following Distance

Stay at least twice as far behind the vehicle ahead as you would when driving the vehicle without a trailer. This can help to avoid situations that require heavy braking and sudden turns.

Passing

More passing distance is needed when towing a trailer. Because the rig is longer, it is necessary to go much farther beyond the passed vehicle before returning to the lane.

Backing Up

Hold the bottom of the steering wheel with one hand. Then, to move the trailer to the left, move that hand to the left. To move the trailer to the right, move your hand to the right. Always back up slowly and, if possible, have someone guide you.

Making Turns

Notice: Making very sharp turns while trailering could cause the trailer to come in contact with the vehicle. The vehicle could be damaged. Avoid making very sharp turns while trailering.

When turning with a trailer, make wider turns than normal. Do this so the trailer will not strike soft shoulders, curbs, road signs, trees or other objects. Avoid jerky or sudden maneuvers. Signal well in advance.

Turn Signals When Towing a Trailer

The arrows on the instrument panel flash whenever signaling a turn or lane change. Properly hooked up, the trailer lamps also flash, telling other drivers the vehicle is turning, changing lanes or stopping.

When towing a trailer, the arrows on the instrument panel flash for turns even if the bulbs on the trailer are burned out. For this reason you may think other drivers are seeing the signal when they are not. It is important to check occasionally to be sure the trailer bulbs are still working.

Driving on Grades

Notice: Do not tow on steep continuous grades exceeding 6 miles (9.6 km). Extended, higher than normal engine and transmission temperatures may result and damage the vehicle. Frequent stops are very important to allow the engine and transmission to cool.

Reduce speed and shift to a lower gear *before* starting down a long or steep downgrade. If the transmission is not shifted down, the brakes might have to be used so much that they would get hot and no longer work well.

On a long uphill grade, shift down and reduce the vehicle's speed to around 45 mph (70 km/h) to reduce the possibility of the engine and the transmission overheating. If the engine does overheat, see *Engine Overheating on page 6-29*.

Parking on Hills

WARNING:

Parking the vehicle on a hill with the trailer attached can be dangerous. If something goes wrong, the rig could start to move. People can be injured, and both the vehicle and the trailer can be damaged. When possible, always park the rig on a flat surface.

If parking the rig on a hill:

1. Press the brake pedal, but do not shift into P (Park) yet. Turn the wheels into the curb if facing downhill or into traffic if facing uphill.
2. Have someone place chocks under the trailer wheels.
3. When the wheel chocks are in place, release the brake pedal until the chocks absorb the load.
4. Reapply the brake pedal. Then apply the parking brake and shift the transmission into P (Park).
5. Release the brake pedal.

Leaving After Parking on a Hill

1. Apply and hold the brake pedal while you:
 - start the engine,
 - shift into a gear, and
 - release the parking brake.
2. Let up on the brake pedal.
3. Drive slowly until the trailer is clear of the chocks.
4. Stop and have someone pick up and store the chocks.

Maintenance When Trailer Towing

The vehicle needs service more often when pulling a trailer. See *Scheduled Maintenance on page 7-3* for more information. Things that are especially important in trailer operation are automatic transmission fluid, engine oil, belts, cooling system and brake system. It is a good idea to inspect these before and during the trip.

Check periodically to see that all hitch nuts and bolts are tight.

Engine Cooling When Trailer Towing

The cooling system may temporarily overheat during severe operating conditions. See *Engine Overheating on page 6-29*.

Changing a Tire When Trailer Towing

If the vehicle gets a flat tire while towing a trailer, be sure to secure the trailer and disconnect it from the vehicle before changing the tire.

Section 6 Service and Appearance Care

Service	6-3	Overheated Engine Protection	
Accessories and Modifications	6-3	Operating Mode	6-32
California Proposition 65 Warning	6-4	Power Steering Fluid	6-32
California Perchlorate Materials		Windshield Washer Fluid	6-33
Requirements	6-4	Brakes	6-35
Doing Your Own Service Work	6-4	Battery	6-38
Adding Equipment to the Outside		Jump Starting	6-40
of the Vehicle	6-5	Headlamp Aiming	6-44
Fuel	6-5	Bulb Replacement	6-47
Gasoline Octane	6-5	High Intensity Discharge (HID) Lighting	6-47
Gasoline Specifications	6-6	Windshield Wiper Blade Replacement	6-48
California Fuel	6-6	Tires	6-50
Additives	6-6	Tire Sidewall Labeling	6-51
Fuels in Foreign Countries	6-7	Tire Terminology and Definitions	6-56
Filling the Tank	6-8	Inflation - Tire Pressure	6-59
Filling a Portable Fuel Container	6-11	High-Speed Operation	6-61
Checking Things Under the Hood	6-12	Tire Pressure Monitor System	6-62
Hood Release	6-13	Tire Pressure Monitor Operation	6-63
Engine Compartment Overview	6-14	Tire Inspection and Rotation	6-67
Engine Oil	6-15	When It Is Time for New Tires	6-69
Engine Oil Life System	6-18	Buying New Tires	6-70
Engine Air Cleaner/Filter	6-19	Different Size Tires and Wheels	6-71
Automatic Transmission Fluid	6-21	Uniform Tire Quality Grading	6-72
Cooling System	6-24	Wheel Alignment and Tire Balance	6-73
Engine Coolant	6-26	Wheel Replacement	6-74
Engine Overheating	6-29		

Section 6 Service and Appearance Care

Tire Chains	6-75	Finish Care	6-101
If a Tire Goes Flat	6-76	Windshield and Wiper Blades	6-101
Tire Sealant and Compressor Kit	6-77	Aluminum or Chrome-Plated Wheels and Trim	6-102
Tire Sealant and Compressor Kit Storage	6-84	Tires	6-102
Changing a Flat Tire	6-85	Sheet Metal Damage	6-103
Removing the Spare Tire and Tools	6-86	Finish Damage	6-103
Removing the Flat Tire and Installing the Spare Tire	6-88	Underbody Maintenance	6-103
Storing a Flat or Spare Tire and Tools	6-93	Chemical Paint Spotting	6-103
Spare Tire	6-95	Vehicle Identification	6-104
Appearance Care	6-96	Vehicle Identification Number (VIN)	6-104
Interior Cleaning	6-96	Service Parts Identification Label	6-104
Fabric/Carpet	6-97	Electrical System	6-105
Leather	6-98	Add-On Electrical Equipment	6-105
Instrument Panel, Vinyl, and Other Plastic Surfaces	6-99	Headlamp Wiring	6-105
Wood Panels	6-99	Windshield Wiper Fuses	6-105
Speaker Covers	6-99	Power Windows and Other Power Options ...	6-106
Care of Safety Belts	6-99	Fuses and Circuit Breakers	6-106
Weatherstrips	6-99	Underhood Fuse Block	6-106
Washing Your Vehicle	6-100	Rear Underseat Fuse Block	6-109
Cleaning Exterior Lamps/Lenses	6-100	Capacities and Specifications	6-114

Service

For service and parts needs, visit your dealer. You will receive genuine GM parts and GM-trained and supported service people.

Genuine GM parts have one of these marks:

ACDelco[®]

GM Parts[®]

GM | Goodwrench[®]

GM Accessories[®]

Accessories and Modifications

When non-dealer/non-retailer accessories are added to the vehicle, they can affect vehicle performance and safety, including such things as airbags, braking, stability, ride and handling, emissions systems, aerodynamics, durability, and electronic systems like antilock brakes, traction control, and stability control. Some of these accessories could even cause malfunction or damage not covered by the vehicle warranty.

Damage to vehicle components resulting from the installation or use of non-GM certified parts, including control module modifications, is not covered under the terms of the vehicle warranty and may affect remaining warranty coverage for affected parts.

GM Accessories are designed to complement and function with other systems on the vehicle. Your GM dealer can accessorize the vehicle using genuine GM Accessories. When you go to your GM dealer and ask for GM Accessories, you will know that GM-trained and supported service technicians will perform the work using genuine GM Accessories.

Also, see *Adding Equipment to Your Airbag-Equipped Vehicle* on page 2-74.

California Proposition 65 Warning

Most motor vehicles, including this one, contain and/or emit chemicals known to the State of California to cause cancer and birth defects or other reproductive harm. Engine exhaust, many parts and systems, many fluids, and some component wear by-products contain and/or emit these chemicals.

California Perchlorate Materials Requirements

Certain types of automotive applications, such as airbag initiators, seat belt pretensioners, and lithium batteries contained in remote keyless transmitters, may contain perchlorate materials. Special handling may be necessary. For additional information, see www.dtsc.ca.gov/hazardouswaste/perchlorate.

Doing Your Own Service Work

WARNING:

You can be injured and the vehicle could be damaged if you try to do service work on a vehicle without knowing enough about it.

- Be sure you have sufficient knowledge, experience, the proper replacement parts, and tools before attempting any vehicle maintenance task.
- Be sure to use the proper nuts, bolts, and other fasteners. English and metric fasteners can be easily confused. If the wrong fasteners are used, parts can later break or fall off. You could be hurt.

If doing some of your own service work, use the proper service manual. It tells you much more about how to service the vehicle than this manual can. To order the proper service manual, see *Service Publications Ordering Information on page 8-17*.

This vehicle has an airbag system. Before attempting to do your own service work, see *Servicing Your Airbag-Equipped Vehicle* on page 2-73.

Keep a record with all parts receipts and list the mileage and the date of any service work performed. See *Maintenance Record* on page 7-13.

Adding Equipment to the Outside of the Vehicle

Things added to the outside of the vehicle can affect the airflow around it. This can cause wind noise and can affect fuel economy and windshield washer performance. Check with your dealer before adding equipment to the outside of the vehicle.

Fuel

Use of the recommended fuel is an important part of the proper maintenance of this vehicle. To help keep the engine clean and maintain optimum vehicle performance, we recommend the use of gasoline advertised as TOP TIER Detergent Gasoline.

Look for the TOP TIER label on the fuel pump to ensure gasoline meets enhanced detergency standards developed by auto companies. A list of marketers providing TOP TIER Detergent Gasoline can be found at www.toptiergas.com.



**TOP
TIER**[™]
Detergent Gasoline



**CATEGORIE
SUPERIEURE**[™]
Essences Détergentes

Gasoline Octane

Use premium unleaded gasoline with a posted octane rating of 91 or higher. You can also use regular unleaded gasoline rated at 87 octane or higher, but the vehicle's acceleration could be slightly reduced, and a slight audible knocking noise, commonly referred to as spark knock, might be heard. If the octane is less than 87, you might notice a heavy knocking noise when you drive. If this occurs, use a gasoline rated at 87 octane or higher as soon as possible.

Otherwise, you could damage the engine. If heavy knocking is heard when using gasoline rated at 87 octane or higher, the engine needs service.

Gasoline Specifications

At a minimum, gasoline should meet ASTM specification D 4814 in the United States or CAN/CGSB-3.5 or 3.511 in Canada. Some gasolines contain an octane-enhancing additive called methylcyclopentadienyl manganese tricarbonyl (MMT). We recommend against the use of gasolines containing MMT. See *Additives on page 6-6* for additional information.

California Fuel

If the vehicle is certified to meet California Emissions Standards, it is designed to operate on fuels that meet California specifications. See the underhood emission control label. If this fuel is not available in states adopting California emissions standards, the vehicle will operate satisfactorily on fuels meeting federal specifications, but emission control system performance might be affected. The malfunction indicator lamp could turn on and the vehicle might fail a smog-check test.

See *Malfunction Indicator Lamp on page 4-55*. If this occurs, return to your authorized dealer for diagnosis. If it is determined that the condition is caused by the type of fuel used, repairs might not be covered by the vehicle warranty.

Additives

To provide cleaner air, all gasolines in the United States are now required to contain additives that help prevent engine and fuel system deposits from forming, allowing the emission control system to work properly. In most cases, nothing should have to be added to the fuel. However, some gasolines contain only the minimum amount of additive required to meet U.S. Environmental Protection Agency regulations. To help keep fuel injectors and intake valves clean, or if the vehicle experiences problems due to dirty injectors or valves, look for gasoline that is advertised as TOP TIER Detergent Gasoline.

For customers who do not use TOP TIER Detergent Gasoline regularly, one bottle of GM Fuel System Treatment PLUS, added to the fuel tank at every engine oil change, can help clean deposits from fuel injectors and intake valves. GM Fuel System Treatment PLUS is the only gasoline additive recommended by General Motors.

Also, your dealer has additives that will help correct and prevent most deposit-related problems.

Gasolines containing oxygenates, such as ethers and ethanol, and reformulated gasolines might be available in your area. We recommend that you use these gasolines, if they comply with the specifications described earlier. However, E85 (85% ethanol) and other fuels containing more than 10% ethanol must not be used in vehicles that were not designed for those fuels.

Notice: This vehicle was not designed for fuel that contains methanol. Do not use fuel containing methanol. It can corrode metal parts in the fuel system and also damage plastic and rubber parts. That damage would not be covered under the vehicle warranty.

Some gasolines that are not reformulated for low emissions can contain an octane-enhancing additive called methylcyclopentadienyl manganese tricarbonyl

(MMT); ask the attendant where you buy gasoline whether the fuel contains MMT. We recommend against the use of such gasolines. Fuels containing MMT can reduce the life of spark plugs and the performance of the emission control system could be affected. The malfunction indicator lamp might turn on. If this occurs, return to your dealer for service.

Fuels in Foreign Countries

If you plan on driving in another country outside the United States or Canada, the proper fuel might be hard to find. Never use leaded gasoline or any other fuel not recommended in the previous text on fuel. Costly repairs caused by use of improper fuel would not be covered by the vehicle warranty.

To check the fuel availability, ask an auto club, or contact a major oil company that does business in the country where you will be driving.

Filling the Tank

WARNING:

Fuel vapor burns violently and a fuel fire can cause bad injuries. To help avoid injuries to you and others, read and follow all the instructions on the fuel pump island. Turn off the engine when refueling. Do not smoke near fuel or when refueling the vehicle. Do not use cellular phones. Keep sparks, flames, and smoking materials away from fuel. Do not leave the fuel pump unattended when refueling the vehicle. This is against the law in some places. Do not re-enter the vehicle while pumping fuel. Keep children away from the fuel pump; never let children pump fuel.

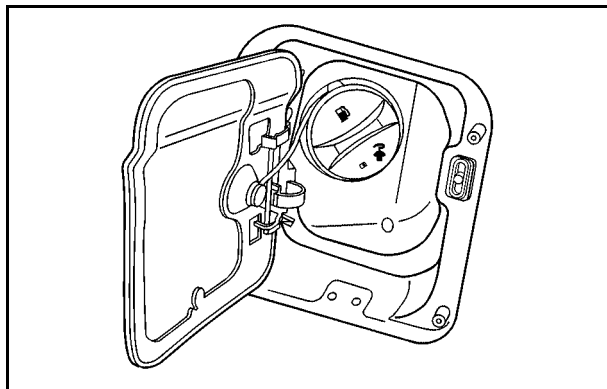

The tethered fuel cap is located behind a hinged fuel door on the driver side of the vehicle.

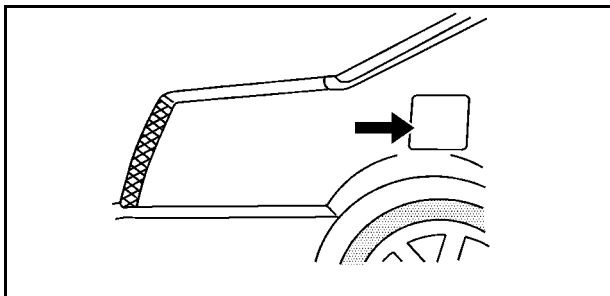

To open the fuel door, push the rearward center edge in and release and it will open.

To remove the fuel cap, turn it slowly counterclockwise. The fuel cap has a spring in it; if the cap is released too soon, it will spring back to the right.

While refueling, hang the tethered fuel cap from the hook on the fuel door.

⚠ WARNING:

Fuel can spray out on you if you open the fuel cap too quickly. If you spill fuel and then something ignites it, you could be badly burned. This spray can happen if the tank is nearly full, and is more likely in hot weather. Open the fuel cap slowly and wait for any hiss noise to stop. Then unscrew the cap all the way.

Be careful not to spill fuel. Do not top off or overfill the tank and wait a few seconds after you have finished pumping before removing the nozzle. Clean fuel from painted surfaces as soon as possible. See *Washing Your Vehicle* on page 6-100.

When replacing the fuel cap, turn it clockwise until it clicks. Make sure the cap is fully installed. The diagnostic system can determine if the fuel cap has been left off or improperly installed. This would allow fuel to evaporate into the atmosphere. See *Malfunction Indicator Lamp* on page 4-55.

The TIGHTEN GAS CAP message displays on the Driver Information Center (DIC) if the fuel cap is not properly installed. See *DIC Warnings and Messages* on page 4-66 for more information.

 **WARNING:**

If a fire starts while you are refueling, do not remove the nozzle. Shut off the flow of fuel by shutting off the pump or by notifying the station attendant. Leave the area immediately.

Notice: If you need a new fuel cap, be sure to get the right type. Your dealer can get one for you. If you get the wrong type, it may not fit properly. This may cause the malfunction indicator lamp to light and may damage the fuel tank and emissions system. See *Malfunction Indicator Lamp* on page 4-55.

Filling a Portable Fuel Container

WARNING:

Never fill a portable fuel container while it is in the vehicle. Static electricity discharge from the container can ignite the fuel vapor. You can be badly burned and the vehicle damaged if this occurs. To help avoid injury to you and others:

- Dispense fuel only into approved containers.
- Do not fill a container while it is inside a vehicle, in a vehicle's trunk, pickup bed, or on any surface other than the ground.

(Continued)

WARNING: (Continued)

- Bring the fill nozzle in contact with the inside of the fill opening before operating the nozzle. Contact should be maintained until the filling is complete.
- Do not smoke while pumping fuel.
- Do not use a cellular phone while pumping fuel.

Checking Things Under the Hood

WARNING:

An electric fan under the hood can start up and injure you even when the engine is not running. Keep hands, clothing, and tools away from any underhood electric fan.

WARNING:

Things that burn can get on hot engine parts and start a fire. These include liquids like fuel, oil, coolant, brake fluid, windshield washer and other fluids, and plastic or rubber. You or others could be burned. Be careful not to drop or spill things that will burn onto a hot engine.

Hood Release

To lift the hood:

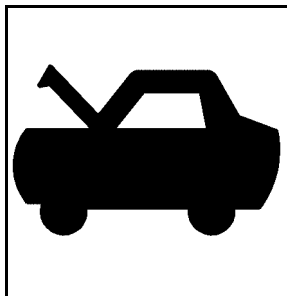

1. Pull the hood release lever with this symbol on it. It is located on the lower left side of the instrument panel.

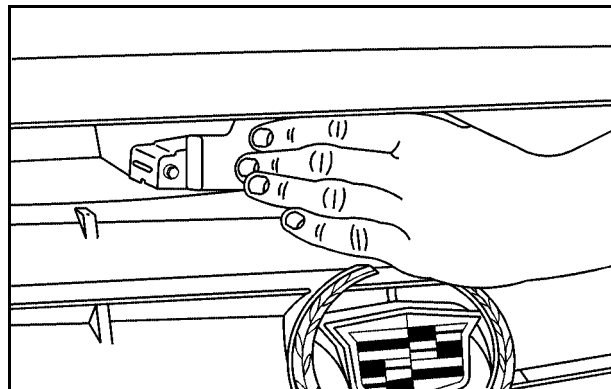

2. Then go to the front of the vehicle and find the secondary hood release lever, located near the center of the hood. Move the release lever up and to the right to raise the hood.

Before closing the hood, be sure all filler caps are on properly. Then pull the hood down and close it firmly.

Engine Compartment Overview

When you open the hood, here is what you will see:

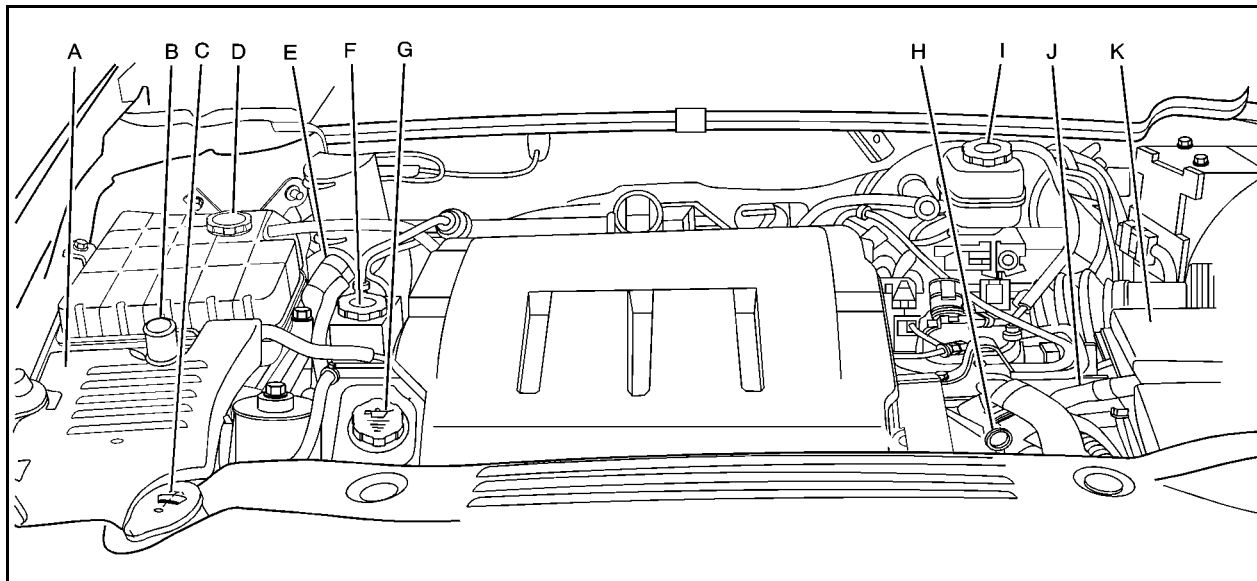

4.6L L37 Engine shown, 4.6L LD8 Engine similar

- A. *Underhood Fuse Block on page 6-106.*
- B. Remote Positive (+) Terminal. See *Jump Starting on page 6-40.*
- C. Windshield Washer Fluid Reservoir. See “Adding Washer Fluid” under *Windshield Washer Fluid on page 6-33.*
- D. Engine Coolant Surge Tank and Pressure Cap. See *Engine Coolant on page 6-26.*
- E. Remote Negative (–) Terminal. See *Jump Starting on page 6-40.*
- F. *Power Steering Fluid on page 6-32.*
- G. Engine Oil Fill Cap. See “When to Add Engine Oil” under *Engine Oil on page 6-15.*
- H. Engine Oil Dipstick. See “Checking Engine Oil” under *Engine Oil on page 6-15.*
- I. Brake Master Cylinder Reservoir. See “Brake Fluid” under *Brakes on page 6-35.*
- J. Automatic Transmission Fluid Cap and Dipstick (Out of View). See *Automatic Transmission Fluid on page 6-21.*
- K. *Engine Air Cleaner/Filter on page 6-19.*

Engine Oil

Checking Engine Oil

It is a good idea to check the engine oil level at each fuel fill. In order to get an accurate reading, the oil must be warm and the vehicle must be on level ground.

The engine oil dipstick handle is a yellow loop. See *Engine Compartment Overview on page 6-14* for the location of the engine oil dipstick.

1. Turn off the engine and give the oil several minutes to drain back into the oil pan. If this is not done, the oil dipstick might not show the actual level.
2. Pull out the dipstick and clean it with a paper towel or cloth, then push it back in all the way. Remove it again, keeping the tip down, and check the level.

When to Add Engine Oil

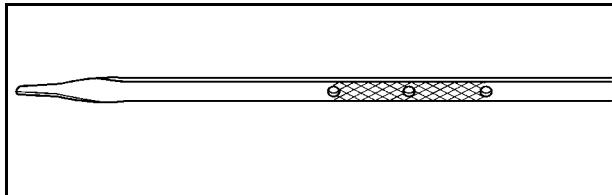

If the oil is below the cross-hatched area at the tip of the dipstick, add at least one quart/liter of the recommended oil. This section explains what kind of oil to use. For engine oil crankcase capacity, see *Capacities and Specifications on page 6-114*.

Notice: Do not add too much oil. If the engine has so much oil that the oil level gets above the cross-hatched area that shows the proper operating range, the engine could be damaged.

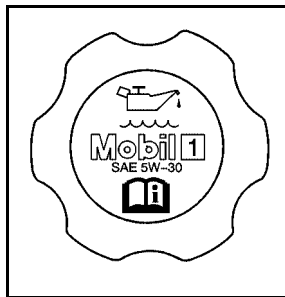

See *Engine Compartment Overview on page 6-14* for the location of the engine oil fill cap.

Add enough oil to put the level somewhere in the proper operating range in the cross-hatched area. Push the dipstick all the way back in when through.

What Kind of Engine Oil to Use

Look for three things:

- GM4718M

This vehicle's engine requires a special oil meeting GM Standard GM4718M. Oils meeting this standard may be identified as synthetic. However, not all synthetic oils will meet this GM standard. Use only an oil that meets GM Standard GM4718M.

Notice: Using oils that do not have the GM4718M Standard designation can cause engine damage not covered by the vehicle warranty.

- SAE 5W-30

SAE 5W-30 is best for the vehicle. These numbers on an oil container show its viscosity, or thickness. Do not use other viscosity oils such as SAE 20W-50.

- American Petroleum Institute (API) starburst symbol



Oils meeting these requirements should have the starburst symbol on the container. This symbol indicates that the oil has been certified by the American Petroleum Institute (API).

This vehicle's engine was filled at the factory with a Mobil 1[®] synthetic oil meeting all requirements for this vehicle.

Substitute Engine Oil: When adding oil to maintain engine oil level, oil meeting GM Standard GM4718M might not be available. You can add substitute oil designated SAE 5W-30 with the starburst symbol at all temperatures. Substitute oil not meeting GM Standard GM4718M should not be used for an oil change.

Engine Oil Additives / Engine Oil Flushes

Do not add anything to the oil. The recommended oils with the starburst symbol that meet GM standards are all that is needed for good performance and engine protection.

Engine oil system flushes are not recommended and could cause engine damage not covered by the vehicle warranty.

Engine Oil Life System

When to Change Engine Oil

This vehicle has a computer system that indicates when to change the engine oil and filter. This is based on engine revolutions and engine temperature, and not on mileage. Based on driving conditions, the mileage at which an oil change is indicated can vary considerably. For the oil life system to work properly, the system must be reset every time the oil is changed.

When the system has calculated that oil life has been diminished, it indicates that an oil change is necessary. A CHANGE ENGINE OIL SOON message in the Driver Information Center (DIC) comes on. Change the oil as

soon as possible within the next 600 miles (1 000 km). It is possible that, if driving under the best conditions, the oil life system might not indicate that an oil change is necessary for over a year. However, the engine oil and filter must be changed at least once a year and at this time the system must be reset. Your dealer has trained people who will perform this work using genuine parts and reset the system. It is also important to check the oil regularly and keep it at the proper level.

If the system is ever reset accidentally, the oil must be changed at 3,000 miles (5 000 km) since the last oil change. Remember to reset the oil life system whenever the oil is changed.

How to Reset the Engine Oil Life System

The Engine Oil Life System calculates when to change the engine oil and filter based on vehicle use. Whenever the oil is changed, reset the system so it can calculate when the next oil change is required. If a situation occurs where the oil is changed prior to a CHANGE ENGINE OIL SOON message in the Driver Information Center (DIC) being turned on, reset the system.

After the oil has been changed, the CHANGE ENGINE OIL SOON message must be reset:

1. Turn the ignition to ON/RUN, with the engine off.
2. Press the DIC INFO button until OIL LIFE REMAINING displays. See *DIC Operation and Displays on page 4-61*.
3. Press and hold the DIC INFO RESET button until 100% displays.
4. Turn the key to LOCK/OFF.

If the CHANGE ENGINE OIL SOON message comes back on when the vehicle is started, the engine oil life system has not reset. Repeat the procedure.

What to Do with Used Oil

Used engine oil contains certain elements that can be unhealthy for your skin and could even cause cancer. Do not let used oil stay on your skin for very long. Clean your skin and nails with soap and water, or a good hand cleaner. Wash or properly dispose of clothing or rags containing used engine oil. See the manufacturer's warnings about the use and disposal of oil products.

Used oil can be a threat to the environment. If you change your own oil, be sure to drain all the oil from the filter before disposal. Never dispose of oil by putting it in the trash, pouring it on the ground, into sewers, or into streams or bodies of water. Recycle it by taking it to a place that collects used oil.

Engine Air Cleaner/Filter

See *Engine Compartment Overview on page 6-14* for the location of the engine air cleaner/filter.

When to Inspect the Engine Air Cleaner/Filter

Inspect the air cleaner/filter at the Maintenance II intervals and replace it at the first oil change after each 50,000 mile (80 000 km) interval. See *Scheduled Maintenance on page 7-3* for more information. If you are driving in dusty/dirty conditions, inspect the filter at each engine oil change.

How to Inspect the Engine Air Cleaner/Filter

To inspect the air cleaner/filter, remove the filter from the vehicle and lightly shake the filter to release loose dust and dirt. If the filter remains caked with dirt, a new filter is required.

To inspect or replace the filter:

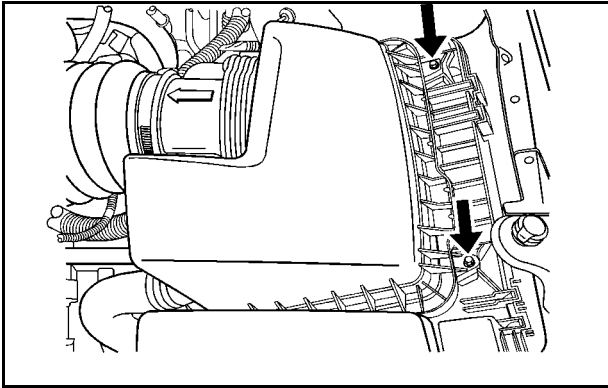

1. Remove the two screws on the top of the engine air cleaner/filter cover.
2. Lift up the outboard side of the cover at an angle while pulling toward you. This is necessary due to the two hinges located on the inboard side of the cover.
3. Remove the engine air cleaner/filter and any loose debris that may be found in the air cleaner base.
4. Inspect or replace the air filter element.

To reinstall the cover:

1. Align the two hinges located on the inboard side of the cover.
2. Push the cover slightly down and towards the engine to engage the tabs in the hinges and align the two screws.
3. Tighten the two screws on the top of the engine air cleaner/filter cover.

⚠ WARNING:

Operating the engine with the air cleaner/filter off can cause you or others to be burned. The air cleaner not only cleans the air; it helps to stop flames if the engine backfires. Use caution when working on the engine and do not drive with the air cleaner/filter off.

Notice: If the air cleaner/filter is off, dirt can easily get into the engine, which could damage it. Always have the air cleaner/filter in place when you are driving.

Automatic Transmission Fluid

When to Check and Change Automatic Transmission Fluid

A good time to check the automatic transmission fluid level is when the engine oil is changed.

Change the fluid and filter at the intervals listed in *Scheduled Maintenance on page 7-3*, and be sure to use the transmission fluid listed in *Recommended Fluids and Lubricants on page 7-9*.

How to Check Automatic Transmission Fluid

Because this operation can be a little difficult, you may choose to have this done at the dealer service department.

If you do it yourself, be sure to follow all the instructions here or you could get a false reading on the dipstick.

Notice: Too much or too little fluid can damage the transmission. Too much can mean that some of the fluid could come out and fall on hot engine parts or exhaust system parts, starting a fire. Too little fluid could cause the transmission to overheat. **Be sure to get an accurate reading if checking the transmission fluid.**

Wait at least 30 minutes before checking the transmission fluid level if you have been driving:

- When outside temperatures are above 32°C (90°F).
- At high speed for quite a while.
- In heavy traffic — especially in hot weather.
- While pulling a trailer.

To get the right reading, the fluid should be at normal operating temperature, which is 82°C to 93°C (180°F to 200°F).

Get the vehicle warmed up by driving about 24 km (15 miles) when outside temperatures are above 10°C (50°F). If it is colder than 10°C (50°F), you may have to drive longer.

Checking the Fluid Level

Prepare the vehicle as follows:

1. Park the vehicle on a level place. Keep the engine running.
2. With the parking brake applied, place the shift lever in P (Park).
3. With your foot on the brake pedal, move the shift lever through each gear range, pausing for about three seconds in each range. Then, position the shift lever in P (Park).
4. Let the engine run at idle for three to five minutes.

Then, without shutting off the engine, follow these steps:

1. Locate the transmission fluid cap which is located next to the radiator hose and below the engine air cleaner/filter assembly on the driver side of the vehicle. The cap is marked TRANS FLUID. See *Engine Compartment Overview on page 6-14* for more information on location.
2. After removing the engine air cleaner/filter assembly to reach the transmission fluid cap, turn the cap counterclockwise to remove. Pull out the dipstick and wipe it with a clean rag or paper towel.
3. Push it back in all the way, wait three seconds, and then pull it back out again.

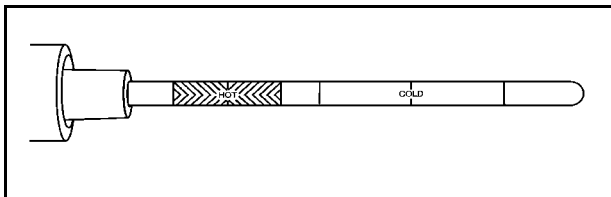

4. Check both sides of the dipstick and read the lower level. The fluid level must be in the cross-hatched area.
5. If the fluid level is in the acceptable range, push the dipstick back in all the way and turn the handle clockwise.
6. Reinstall the engine air cleaner/filter assembly.

How to Add Automatic Transmission Fluid

Refer to the Maintenance Schedule to determine what kind of transmission fluid to use. See *Recommended Fluids and Lubricants on page 7-9*.

If the fluid level is low, add only enough of the proper fluid to bring the level into the cross-hatched area on the dipstick.

1. Pull out the dipstick.
2. Using a long-neck funnel, add enough fluid at the dipstick hole to bring it to the proper level.

It does not take much fluid, generally less than one pint (0.5 L). Do not overfill.

Notice: Use of the incorrect automatic transmission fluid may damage the vehicle, and the damages may not be covered by the vehicle's warranty. Always use the automatic transmission fluid listed in *Recommended Fluids and Lubricants on page 7-9*.

3. After adding fluid, recheck the fluid level as described under "How to Check Automatic Transmission Fluid," earlier in this section.
4. When the correct fluid level is obtained, push the dipstick back in all the way and turn the handle clockwise.

Cooling System

The cooling system allows the engine to maintain the correct working temperature.

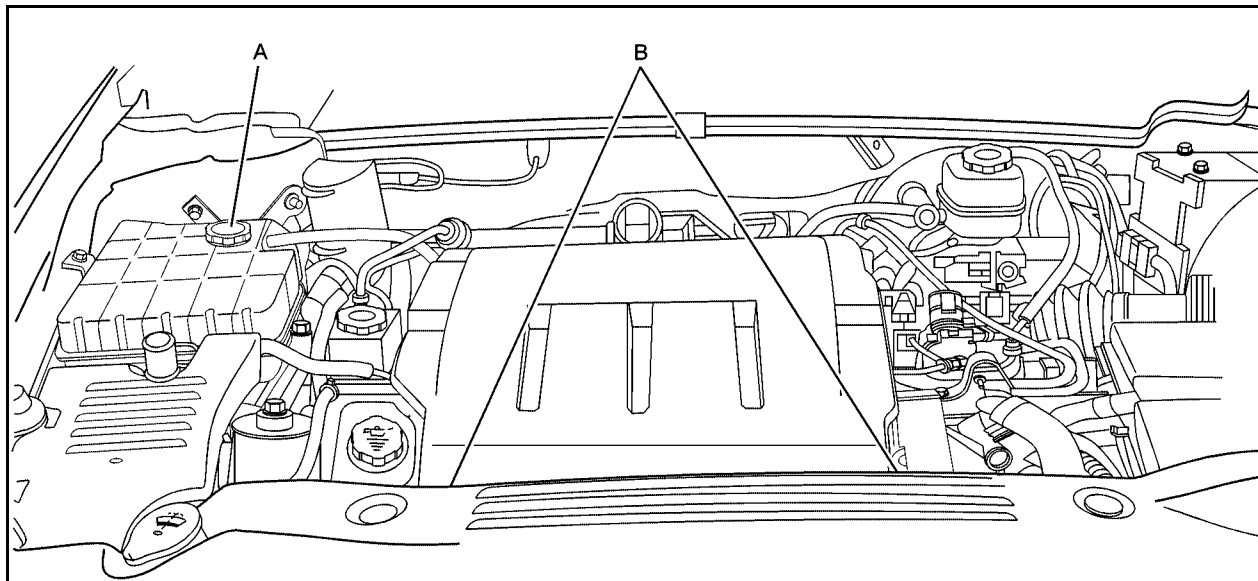

4.6L L37 Engine shown, 4.6L LD8 Engine similar

A. Coolant Surge Tank with Pressure Cap

B. Electric Engine Cooling Fans

 **WARNING:**

An electric engine cooling fan under the hood can start up even when the engine is not running and can cause injury. Keep hands, clothing, and tools away from any underhood electric fan.

 **WARNING:**

Heater and radiator hoses, and other engine parts, can be very hot. Do not touch them. If you do, you can be burned.

(Continued)

WARNING: (Continued)

Do not run the engine if there is a leak. If you run the engine, it could lose all coolant. That could cause an engine fire, and you could be burned. Get any leak fixed before you drive the vehicle.

Notice: Using coolant other than DEX-COOL[®] can cause premature engine, heater core, or radiator corrosion. In addition, the engine coolant could require changing sooner, at 50 000 km (30,000 miles) or 24 months, whichever occurs first. Any repairs would not be covered by the vehicle warranty. Always use DEX-COOL[®] (silicate-free) coolant in the vehicle.

Engine Coolant

The cooling system in the vehicle is filled with DEX-COOL[®] engine coolant. This coolant is designed to remain in the vehicle for five years or 150,000 miles (240 000 km), whichever occurs first.

The following explains the cooling system and how to check and add coolant when it is low. If there is a problem with engine overheating, see *Engine Overheating on page 6-29*.

What to Use

WARNING:

Adding only plain water to the cooling system can be dangerous. Plain water, or some other liquid such as alcohol, can boil before the proper coolant mixture will. The vehicle's coolant warning system is set for the proper coolant mixture. With plain water or the wrong mixture, the engine could get too hot but you would not get the overheat warning. The engine could catch fire and you or others could be burned. Use a 50/50 mixture of clean, drinkable water and DEX-COOL[®] coolant.

Use a 50/50 mixture of clean, drinkable water and DEX-COOL[®] coolant. If using this mixture, nothing else needs to be added. This mixture:

- Gives freezing protection down to -34°F (-37°C), outside temperature.
- Gives boiling protection up to 265°F (129°C), engine temperature.
- Protects against rust and corrosion.
- Will not damage aluminum parts.
- Helps keep the proper engine temperature.

Notice: If an improper coolant mixture is used, the engine could overheat and be badly damaged. The repair cost would not be covered by the vehicle warranty. Too much water in the mixture can freeze and crack the engine, radiator, heater core, and other parts.

Notice: If extra inhibitors and/or additives are used in the vehicle's cooling system, the vehicle could be damaged. Use only the proper mixture of the engine coolant listed in this manual for the cooling system. See *Recommended Fluids and Lubricants on page 7-9* for more information.

Checking Coolant

The vehicle must be on a level surface when checking the coolant level.

Check to see if coolant is visible in the coolant recovery tank. If the coolant inside the coolant recovery tank is boiling, do not do anything else until it cools down. If coolant is visible but the coolant level is not at or above the FULL COLD mark, add a 50/50 mixture of clean, drinkable water and DEX-COOL[®] coolant at the coolant recovery tank, but be sure the cooling system is cool before this is done. See *Engine Coolant on page 6-26* for more information.

How to Add Coolant to the Surge Tank

WARNING:

You can be burned if you spill coolant on hot engine parts. Coolant contains ethylene glycol and it will burn if the engine parts are hot enough. Do not spill coolant on a hot engine.

Notice: This vehicle has a specific coolant fill procedure. Failure to follow this procedure could cause the engine to overheat and be severely damaged.

WARNING:

An electric engine cooling fan under the hood can start up even when the engine is not running and can cause injury. Keep hands, clothing, and tools away from any underhood electric fan.

WARNING:

Steam and scalding liquids from a hot cooling system can blow out and burn you badly. They are under pressure, and if you turn the surge tank pressure cap — even a little — they can come out at high speed. Never turn the cap when the cooling system, including the surge tank pressure cap, is hot. Wait for the cooling system and surge tank pressure cap to cool if you ever have to turn the pressure cap.

If no coolant is visible in the surge tank, add coolant as follows:

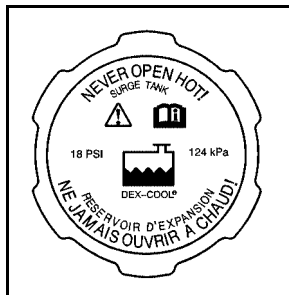

1. Remove the coolant surge tank pressure cap when the cooling system, including the coolant surge tank pressure cap and upper radiator hose, is no longer hot.

Turn the pressure cap slowly counterclockwise. If you hear a hiss, wait for that to stop. A hiss means there is still some pressure left.

2. Keep turning the cap and remove it.

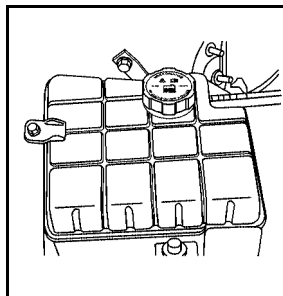

3. Fill the coolant surge tank with the proper mixture to the **FULL COLD** mark on the side of the coolant surge tank.

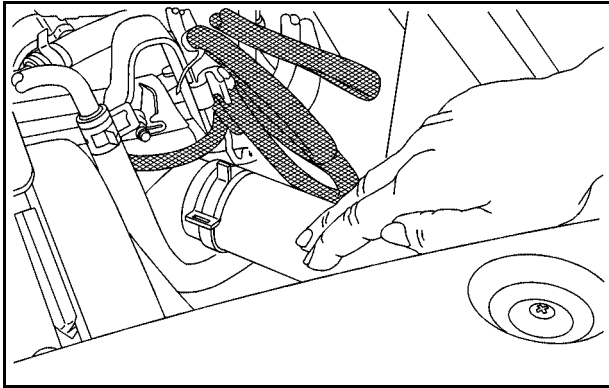

4.6L L37 Engine shown, 4.6L LD8 Engine similar

4. With the coolant surge tank cap off, start the engine and let it run until you can feel the upper radiator hose getting hot. Watch out for the engine cooling fans.

By this time, the coolant level inside the coolant surge tank may be lower. If the level is lower, add more of the proper mixture to the coolant surge tank until the level reaches the FULL COLD mark on the side of the coolant surge tank.

5. Replace the cap. Be sure the cap is hand-tight and fully seated.

Notice: If the pressure cap is not tightly installed, coolant loss and possible engine damage may occur. Be sure the cap is properly and tightly secured.

If coolant is needed, add the proper DEX-COOL[®] coolant mixture at the coolant recovery tank.

Engine Overheating

The vehicle has several indicators to warn of engine overheating.

There is an engine temperature warning light and/or gauge on the instrument panel cluster. See *Engine Coolant Temperature Warning Light on page 4-54* and *Engine Coolant Temperature Gauge on page 4-54*.

The vehicle may also display a ENGINE OVERHEATED IDLE ENGINE message or an ENGINE OVERHEATED STOP ENGINE message displayed in the Driver Information Center (DIC). See *DIC Warnings and Messages on page 4-66* for more information. You will also hear a chime.

You may decide not to lift the hood when this warning appears, but instead get service help right away. See *Roadside Service* on page 8-7.

If you do decide to lift the hood, make sure the vehicle is parked on a level surface.

Then check to see if the engine cooling fans are running. If the engine is overheating, both fans should be running. If they are not, do not continue to run the engine and have the vehicle serviced.

Notice: Engine damage from running the engine without coolant is not covered by the warranty.

Notice: If the engine catches fire while driving with no coolant, the vehicle can be badly damaged. The costly repairs would not be covered by the vehicle warranty. See *Overheated Engine Protection Operating Mode* on page 6-32 for information on driving to a safe place in an emergency.

If Steam Is Coming From The Engine Compartment

WARNING:

Steam from an overheated engine can burn you badly, even if you just open the hood. Stay away from the engine if you see or hear steam coming from it. Turn it off and get everyone away from the vehicle until it cools down. Wait until there is no sign of steam or coolant before you open the hood.

If you keep driving when the vehicle's engine is overheated, the liquids in it can catch fire. You or others could be badly burned. Stop the engine if it overheats, and get out of the vehicle until the engine is cool.

See *Overheated Engine Protection Operating Mode* on page 6-32 for information on driving to a safe place in an emergency.

If No Steam Is Coming From The Engine Compartment

If an engine overheat warning is displayed but no steam can be seen or heard, the problem may not be too serious. Sometimes the engine can get a little too hot when the vehicle:

- Climbs a long hill on a hot day.
- Stops after high-speed driving.
- Idles for long periods in traffic.
- Tows a trailer.

If the overheat warning is displayed with no sign of steam:

1. Turn the air conditioning off.
2. Turn the heater on to the highest temperature and to the highest fan speed. Open the windows as necessary.
3. In heavy traffic, let the engine idle in N (Neutral) while stopped. If it safe to do so, pull off the road, shift to P (Park) or N (Neutral) and let the engine idle.

If the temperature overheat gauge is no longer in the overheat zone or an overheat warning no longer displays, the vehicle can be driven. Continue to drive the vehicle slow for about 10 minutes. Keep a safe vehicle distance from the car in front of you. If the warning does not come back on, continue to drive normally.

If the warning continues, pull over, stop, and park the vehicle right away.

If there is no sign of steam, idle the engine for three minutes while parked. If the warning is still displayed, turn off the engine until it cools down. Also, see "Overheated Engine Protection Operating Mode" next in this section.

Overheated Engine Protection Operating Mode

If an overheated engine condition exists and the message ENGINE OVERHEATED STOP ENGINE is displayed, an overheat protection mode which alternates firing groups of cylinders helps prevent engine damage. In this mode, you will notice a loss in power and engine performance. This operating mode allows your vehicle to be driven to a safe place in an emergency. Driving extended miles (km) and/or towing a trailer in the overheat protection mode should be avoided.

Notice: After driving in the overheated engine protection operating mode, to avoid engine damage, allow the engine to cool before attempting any repair. The engine oil will be severely degraded. Repair the cause of coolant loss, change the oil and reset the oil life system. See *Engine Oil* on page 6-15.

Power Steering Fluid

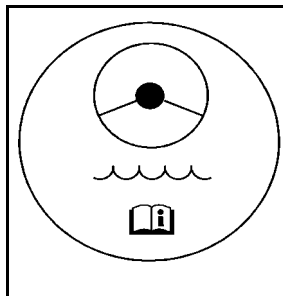

The power steering fluid reservoir is located next to the underhood fuse block on the passenger side of the vehicle. See *Engine Compartment Overview* on page 6-14 for more information on location.

When to Check Power Steering Fluid

It is not necessary to regularly check power steering fluid unless you suspect there is a leak in the system or you hear an unusual noise. A fluid loss in this system could indicate a problem. Have the system inspected and repaired.

How to Check Power Steering Fluid

To check the power steering fluid:

1. Turn the key off and let the engine compartment cool down.
2. Wipe the cap and the top of the reservoir clean.
3. Unscrew the cap and wipe the dipstick with a clean rag.
4. Replace the cap and completely tighten it.
5. Remove the cap again and look at the fluid level on the dipstick.

The level should be at the FULL COLD mark.
If necessary, add only enough fluid to bring the level up to the mark.

What to Use

To determine what kind of fluid to use, see *Recommended Fluids and Lubricants on page 7-9*. Always use the proper fluid.

Notice: Use of the incorrect fluid may damage the vehicle and the damages may not be covered by the vehicle's warranty. Always use the correct fluid listed in *Recommended Fluids and Lubricants on page 7-9*.

Windshield Washer Fluid

What to Use

When the vehicle needs windshield washer fluid, be sure to read the manufacturer's instructions before use. If the vehicle will be operating in an area where the temperature may fall below freezing, use a fluid that has sufficient protection against freezing.

Adding Washer Fluid

The WASHER FLUID LOW ADD FLUID message will be displayed on the Driver Information Center (DIC) when the fluid is low. See *DIC Warnings and Messages* on page 4-66 for more information.

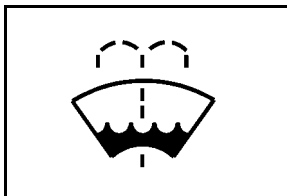

Open the cap with the washer symbol on it. Add washer fluid until the tank is full. See *Engine Compartment Overview* on page 6-14 for reservoir location.

Notice:

- **When using concentrated washer fluid, follow the manufacturer's instructions for adding water.**
- **Do not mix water with ready-to-use washer fluid. Water can cause the solution to freeze and damage the washer fluid tank and other parts of the washer system. Also, water does not clean as well as washer fluid.**
- **Fill the washer fluid tank only three-quarters full when it is very cold. This allows for fluid expansion if freezing occurs, which could damage the tank if it is completely full.**
- **Do not use engine coolant (antifreeze) in the windshield washer. It can damage the vehicle's windshield washer system and paint.**

Brakes

Brake Fluid

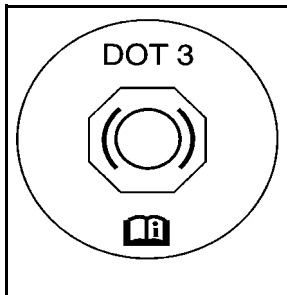

The brake master cylinder reservoir is filled with DOT 3 brake fluid. See *Engine Compartment Overview* on page 6-14 for reservoir location and access.

There are only two reasons why the brake fluid level in the reservoir might go down:

- The brake fluid level goes down because of normal brake lining wear. When new linings are installed, the fluid level goes back up.
- A fluid leak in the brake hydraulic system can also cause a low fluid level. Have the brake hydraulic system fixed, since a leak means that sooner or later the brakes will not work well.

Do not top off the brake fluid. Adding fluid does not correct a leak. If fluid is added when the linings are worn, there will be too much fluid when new brake linings are installed. Add or remove brake fluid, as necessary, only when work is done on the brake hydraulic system.

WARNING:

If too much brake fluid is added, it can spill on the engine and burn, if the engine is hot enough. You or others could be burned, and the vehicle could be damaged. Add brake fluid only when work is done on the brake hydraulic system.

If the ignition is on and the brake fluid is low, the **SERVICE BRAKE SYSTEM** message displays in the Driver Information Center (DIC). See *DIC Warnings and Messages* on page 4-66.

What to Add

Use only new DOT 3 brake fluid from a sealed container. See *Recommended Fluids and Lubricants* on page 7-9.

Always clean the brake fluid reservoir cap and the area around the cap before removing it. This helps keep dirt from entering the reservoir.

WARNING:

With the wrong kind of fluid in the brake hydraulic system, the brakes might not work well. This could cause a crash. Always use the proper brake fluid.

Notice:

- **Using the wrong fluid can badly damage brake hydraulic system parts. For example, just a few drops of mineral-based oil, such as engine oil, in the brake hydraulic system can damage brake hydraulic system parts so badly that they will have to be replaced. Do not let someone put in the wrong kind of fluid.**
- **If brake fluid is spilled on the vehicle's painted surfaces, the paint finish can be damaged. Be careful not to spill brake fluid on the vehicle. If you do, wash it off immediately. See *Washing Your Vehicle* on page 6-100.**

Brake Wear

This vehicle has disc brakes. Disc brake pads have built-in wear indicators that make a high-pitched warning sound when the brake pads are worn and new pads are needed. The sound can come and go or be heard all the time the vehicle is moving, except when applying the brake pedal firmly.

WARNING:

The brake wear warning sound means that soon the brakes will not work well. That could lead to an accident. When the brake wear warning sound is heard, have the vehicle serviced.

Notice: Continuing to drive with worn-out brake pads could result in costly brake repair.

Some driving conditions or climates can cause a brake squeal when the brakes are first applied or lightly applied. This does not mean something is wrong with the brakes.

Properly torqued wheel nuts are necessary to help prevent brake pulsation. When tires are rotated, inspect brake pads for wear and evenly tighten wheel nuts in the proper sequence to torque specifications in *Capacities and Specifications on page 6-114*.

Brake linings should always be replaced as complete axle sets.

Brake Pedal Travel

See your dealer if the brake pedal does not return to normal height, or if there is a rapid increase in pedal travel. This could be a sign that brake service might be required.

Brake Adjustment

Every time the brakes are applied, with or without the vehicle moving, the brakes adjust for wear.

Replacing Brake System Parts

The braking system on a vehicle is complex. Its many parts have to be of top quality and work well together if the vehicle is to have really good braking. The vehicle was designed and tested with top-quality brake parts. When parts of the braking system are replaced — for example, when the brake linings wear down and new ones are installed — be sure to get new approved replacement parts. If this is not done, the brakes might not work properly. For example, if someone puts in brake linings that are wrong for the vehicle, the balance between the front and rear brakes can change — for the worse. The braking performance expected can change in many other ways if the wrong replacement brake parts are installed.

Battery

Refer to the replacement number on the original battery label when a new battery is needed.

DANGER:

Battery posts, terminals, and related accessories contain lead and lead compounds, chemicals known to the State of California to cause cancer and reproductive harm. Wash hands after handling.

The battery is under the rear seat cushion. To access the battery, see *Rear Underseat Fuse Block on page 6-109*. Access to the battery is not necessary to jump start the vehicle. See *Jump Starting on page 6-40*.

⚠ WARNING:

A battery that is not properly vented can let sulfuric acid fumes into the area under the rear seat cushion. These fumes can damage the rear seat safety belt systems. You might not be able to see this damage and the safety belts might not provide the protection needed in a crash. If a replacement battery is ever needed, it must be vented in the same manner as the original battery. Always make sure that the vent hose is properly reattached before reinstalling the seat cushion.

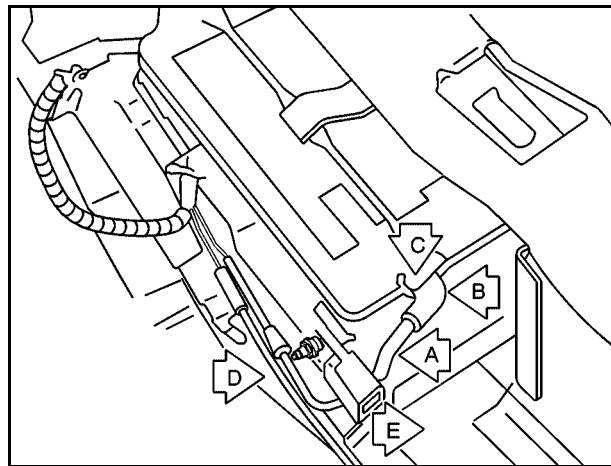

To be sure the vent hose (A) is properly attached, the vent hose connectors (B) must be securely reattached to the vent outlets (C) on each side of the battery and the vent assembly grommet (D) must be secured to the floor pan (E).

Vehicle Storage

WARNING:

Batteries have acid that can burn you and gas that can explode. You can be badly hurt if you are not careful. See *Jump Starting on page 6-40* for tips on working around a battery without getting hurt.

Infrequent Usage: Remove the black, negative (-) cable from the battery to keep the battery from running down.

Extended Storage: Remove the black, negative (-) cable from the battery or use a battery trickle charger.

Jump Starting

If the vehicle's battery has run down, you may want to use another vehicle and some jumper cables to start your vehicle. Be sure to use the following steps to do it safely.

WARNING:

Batteries can hurt you. They can be dangerous because:

- They contain acid that can burn you.
- They contain gas that can explode or ignite.
- They contain enough electricity to burn you.

If you do not follow these steps exactly, some or all of these things can hurt you.

Notice: Ignoring these steps could result in costly damage to the vehicle that would not be covered by the warranty.

Trying to start the vehicle by pushing or pulling it will not work, and it could damage the vehicle.

1. Check the other vehicle. It must have a 12-volt battery with a negative ground system.

Notice: If the other vehicle's system is not a 12-volt system with a negative ground, both vehicles can be damaged. Only use vehicles with 12-volt systems with negative grounds to jump start your vehicle.

2. Get the vehicles close enough so the jumper cables can reach, but be sure the vehicles are not touching each other. If they are, it could cause a ground connection you do not want. You would not be able to start your vehicle and the bad grounding could damage the electrical systems.

To avoid the possibility of the vehicles rolling, set the parking brake firmly on both vehicles involved in the jump start procedure. Put an automatic transmission in P (Park) or a manual transmission in NEUTRAL before setting the parking brake.

Notice: If you leave the radio or other accessories on during the jump starting procedure, they could be damaged. The repairs would not be covered by the warranty. Always turn off the radio and other accessories when jump starting the vehicle.

3. Turn off the ignition on both vehicles. Unplug unnecessary accessories plugged into the cigarette lighter or the accessory power outlets. Turn off the radio and all lamps that are not needed. This will avoid sparks and help save both batteries. And it could save the radio!
4. Open the hoods and locate the positive (+) and negative (-) terminal locations on the other vehicle. Your vehicle has a remote positive (+) jump starting terminal and a remote negative (-) jump starting terminal.

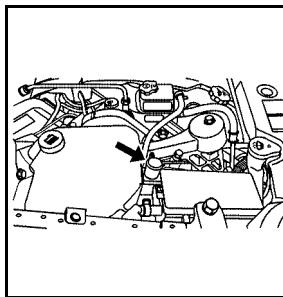

4.6L LD8 Engine shown, 4.6L L37 Engine similar

The remote positive (+) terminal is located in the engine compartment on the passenger's side of the vehicle. Lift the red plastic cap to access the terminal. See *Engine Compartment Overview on page 6-14* for more information on the location of the remote positive (+) terminal.

A second remote positive (+) terminal is located on the rear underseat fuse block.

The remote negative (-) terminal is located behind the power steering pulley, near the engine cover. It is marked GND (-).

You will not see the battery of your vehicle under the hood. It is located under the rear passenger's seat. You will not need to access the battery for jump starting. The remote terminals are for that purpose.

 **WARNING:**

An electric fan can start up even when the engine is not running and can injure you. Keep hands, clothing and tools away from any underhood electric fan.

 **WARNING:**

Using an open flame near a battery can cause battery gas to explode. People have been hurt doing this, and some have been blinded. Use a flashlight if you need more light.

(Continued)

WARNING: (Continued)

Be sure the battery has enough water. You do not need to add water to the battery installed in your new vehicle. But if a battery has filler caps, be sure the right amount of fluid is there. If it is low, add water to take care of that first. If you do not, explosive gas could be present.

Battery fluid contains acid that can burn you. Do not get it on you. If you accidentally get it in your eyes or on your skin, flush the place with water and get medical help immediately.

 **WARNING:**

Fans or other moving engine parts can injure you badly. Keep your hands away from moving parts once the engine is running.

5. Check that the jumper cables do not have loose or missing insulation. If they do, you could get a shock. The vehicles could be damaged too.

Before you connect the cables, here are some basic things you should know. Positive (+) will go to positive (+) or to a remote positive (+) terminal if the vehicle has one. Negative (-) will go to a heavy, unpainted metal engine part or to a remote negative (-) terminal if the vehicle has one.

Do not connect positive (+) to negative (-) or you will get a short that would damage the battery and maybe other parts too. And do not connect the negative (-) cable to the negative (-) terminal on the dead battery because this can cause sparks.

6. Connect the red positive (+) cable to the remote positive (+) terminal location on the vehicle with the dead battery. Use a remote positive (+) terminal if the vehicle has one.
7. Do not let the other end touch metal. Connect it to the positive (+) terminal location of the vehicle with the good battery. Use a remote positive (+) terminal if the vehicle has one.
8. Now connect the black negative (-) cable to the negative (-) terminal location of the vehicle with the good battery. Use a remote negative (-) terminal if the vehicle has one.

Do not let the other end of the cable touch anything until the next step. The other end of the negative (-) cable does not go to the dead battery. It goes to a heavy, unpainted metal engine part or to a remote negative (-) terminal on the vehicle with the dead battery.
9. Connect the other end of the negative (-) cable to the negative (-) terminal location on the vehicle with the dead battery. Your vehicle has a remote negative (-) terminal marked GND (-).
10. Now start the vehicle with the good battery and run the engine for a while.
11. Try to start the vehicle that had the dead battery. If it will not start after a few tries, it probably needs service.

Notice: If the jumper cables are connected or removed in the wrong order, electrical shorting may occur and damage the vehicle. The repairs would not be covered by the vehicle warranty. Always connect and remove the jumper cables in the correct order, making sure that the cables do not touch each other or other metal.

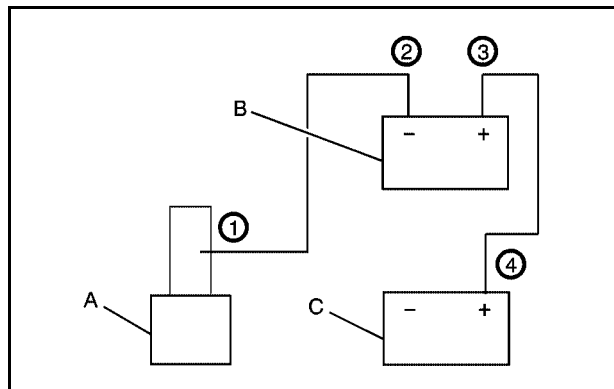

Jumper Cable Removal

- A. Heavy, Unpainted Metal Engine Part or Remote Negative (-) Terminal (GND)
- B. Good Battery or Remote Positive (+) and Remote Negative (-) Terminals
- C. Dead Battery or Remote Positive (+) Terminal

To disconnect the jumper cables from both vehicles, do the following:

1. Disconnect the black negative (-) cable from the vehicle that had the dead battery.
2. Disconnect the black negative (-) cable from the vehicle with the good battery.
3. Disconnect the red positive (+) cable from the vehicle with the good battery.
4. Disconnect the red positive (+) cable from the other vehicle.
5. Return the remote positive (+) terminal cover to its original position.

Headlamp Aiming

The vehicle has a visual optical headlamp aiming system. The aim has been preset at the factory and should need no further adjustment.

However, if the vehicle is damaged in a crash, the headlamp aim may be affected and adjustment may be necessary.

If oncoming vehicles flash their high beams at you, this may also mean the vertical aim needs to be adjusted.

It is recommended that the vehicle is taken to your dealer for service if the headlamps need to be re-aimed. It is possible however, to re-aim the headlamps as described.

Notice: To make sure the headlamps are aimed properly, read all the instructions before beginning. Failure to follow these instructions could cause damage to headlamp parts.

The vehicle should:

- Be placed so the headlamps are 25 ft. (7.6 m) from a light colored wall.
- Have all four tires on a level surface which is level all the way to the wall.
- Be placed so it is perpendicular to the wall.
- Not have any snow, ice, or mud on it.
- Be fully assembled and all other work stopped while headlamp aiming is being performed.
- Be normally loaded with a full tank of fuel and one person or 160 lbs (75 kg) sitting on the driver seat.
- Have all tires properly inflated.
- Have the spare tire is in its original location in the vehicle.

Headlamp aiming is done with the vehicle's low-beam headlamps. The high-beam headlamps will be correctly aimed if the low-beam headlamps are aimed properly.

To adjust the vertical aim:

1. Open the hood. See *Hood Release* on page 6-13 for more information.

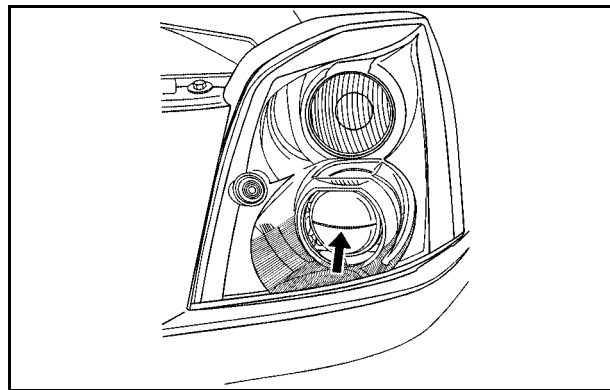

2. Find the center line running through the lens of the headlamp.
3. Record the distance from the ground to the center line running through the lens of the headlamp.

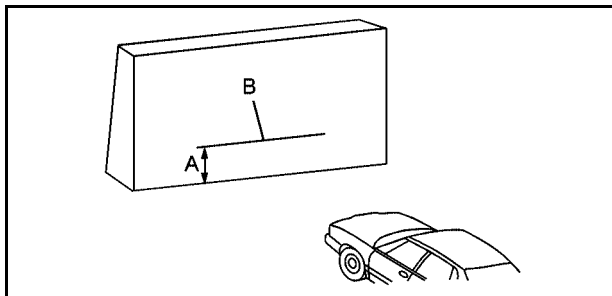

4. At a wall, measure from the ground upward (A) to the recorded distance from Step 3 and mark it.
5. Draw or tape a horizontal line (B) the width of the vehicle at the wall where it was marked in Step 4.

Notice: Do not cover a headlamp to improve beam cut-off when aiming. Covering a headlamp may cause excessive heat build-up which may cause damage to the headlamp.

6. Turn on the low-beam headlamps and place a piece of cardboard or equivalent in front of the headlamp not being aimed. This should allow only the beam of light from the headlamp being aimed to be seen on the flat surface.

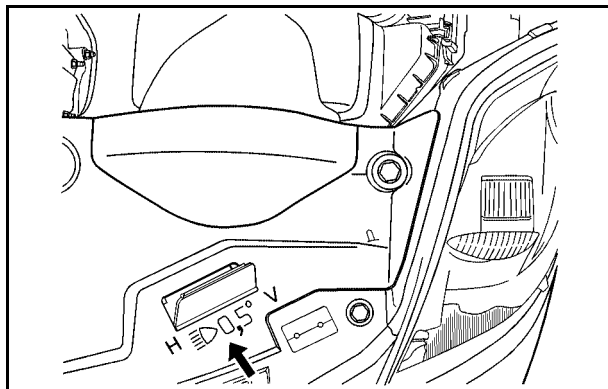

7. Locate the vertical headlamp aiming screws. They are located under the hood near each headlamp assembly. First lift the flap to access either of them. Each one is the top outboard screw by the "V" on the cover panel next to the aiming flap.

The adjustment screw can be turned with a 6 mm hex wrench.

- Turn the vertical aiming screw until the headlamp beam is aimed to the horizontal tape line. Turn it clockwise or counterclockwise to raise or lower the angle of the beam.

The top edge of the cut-off should be positioned at the bottom edge of the horizontal tape line.

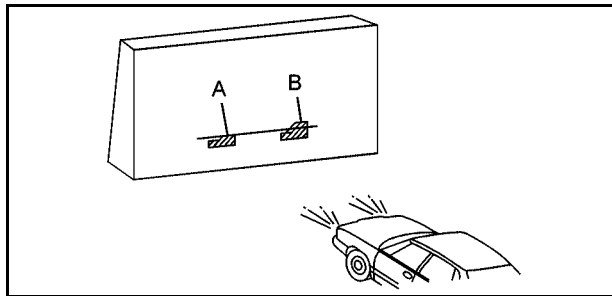

- Make sure that the light from the headlamp is positioned at the bottom edge of the horizontal tape line. The lamp on the left (A) shows the correct headlamp aim. The lamp on the right (B) shows the incorrect headlamp aim.
- Repeat Steps 7 through 9 for the opposite headlamp.

Bulb Replacement

It is recommended that all bulbs be replaced by your dealer.

High Intensity Discharge (HID) Lighting

WARNING:

The low beam high intensity discharge lighting system operates at a very high voltage. If you try to service any of the system components, you could be seriously injured. Have your dealer or a qualified technician service them.

The vehicle may have HID headlamps. After an HID headlamp bulb has been replaced, you may notice that the beam is a slightly different shade than it was originally. This is normal.

Windshield Wiper Blade Replacement

Windshield wiper blades should be inspected for wear or cracking. See *Scheduled Maintenance on page 7-3* for more information on wiper blade inspection.

Replacement blades come in different types and are removed in different ways. Here is how to remove the wiper blade:

1. Turn the engine off.
2. Lift the windshield wiper arm and blade away from the windshield.

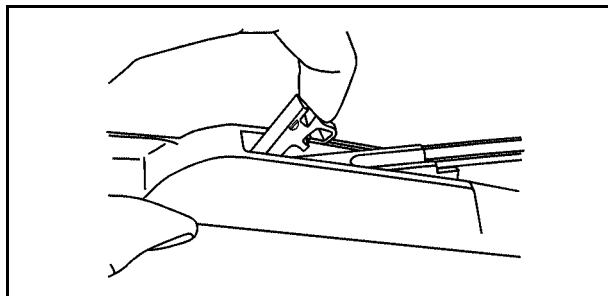

3. Pull the clip up from the blade connecting point and pull the blade assembly down toward the windshield to remove it from the wiper arm.
4. Install the new wiper blade onto the wiper arm and firmly press down on the clip to snap it into place.

To remove and replace the wiper blade element:

1. The wiper blade element has two notches at one end which are engaged by the bottom claw set of the wiper blade. At the notched end of the wiper blade, pull the wiper blade element from the wiper blade assembly.
2. Replace the element by starting at the heel end of the wiper blade, which is the end nearest to the base of the wiper arm, and slide the wiper blade element, notched end last, into the wiper blade claw sets.
3. Engage the last claw into the notched end of the wiper blade element by squeezing the wiper blade element at the notched area, and push the wiper blade element so the claw fits into the notch.
4. Be sure the two wiper blade element notches are engaged by the last claw set and all the other claws are properly engaged in the slots of the wiper blade element on both sides.

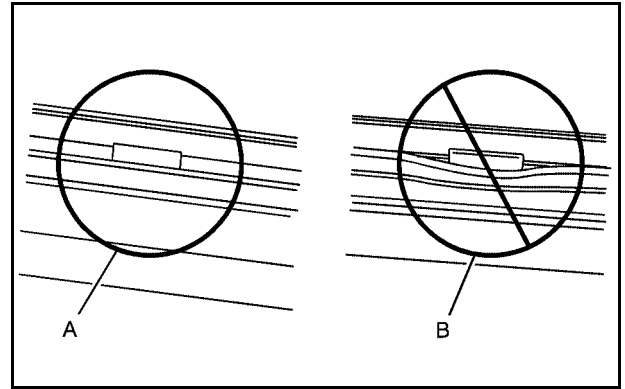

A. Correct Installation

B. Incorrect Installation

For the proper type and size windshield wiper blades, see *Maintenance Replacement Parts* on page 7-11.

Tires

Your new vehicle comes with high-quality tires made by a leading tire manufacturer. If you ever have questions about your tire warranty and where to obtain service, see your vehicle Warranty booklet for details. For additional information refer to the tire manufacturer.

WARNING:

- Poorly maintained and improperly used tires are dangerous.
- Overloading your tires can cause overheating as a result of too much flexing. You could have an air-out and a serious accident. See *Loading the Vehicle on page 5-18*.

(Continued)

WARNING: (Continued)

- Underinflated tires pose the same danger as overloaded tires. The resulting accident could cause serious injury. Check all tires frequently to maintain the recommended pressure. Tire pressure should be checked when your tires are cold. See *Inflation - Tire Pressure on page 6-59*.
- Overinflated tires are more likely to be cut, punctured, or broken by a sudden impact — such as when you hit a pothole. Keep tires at the recommended pressure.
- Worn, old tires can cause accidents. If your tread is badly worn, or if your tires have been damaged, replace them.

See *High-Speed Operation on page 6-61* for inflation pressure adjustment for high speed driving.

Tire Sidewall Labeling

Useful information about a tire is molded into its sidewall.

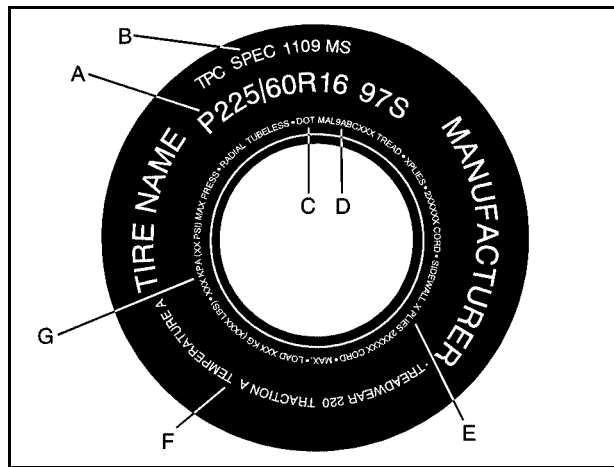

Passenger Car Tire Example

(A) Tire Size: The tire size is a combination of letters and numbers used to define a particular tire's width, height, aspect ratio, construction type and service description. See the "Tire Size" illustration later in this section for more detail.

(B) TPC Spec (Tire Performance Criteria Specification): Original equipment tires designed to GM's specific tire performance criteria have a TPC specification code molded onto the sidewall. GM's TPC specifications meet or exceed all federal safety guidelines.

(C) DOT (Department of Transportation): The Department of Transportation (DOT) code indicates that the tire is in compliance with the U.S. Department of Transportation Motor Vehicle Safety Standards.

(D) Tire Identification Number (TIN): The letters and numbers following the DOT code are the Tire Identification Number (TIN). The TIN shows the manufacturer and plant code, tire size, and date the tire was manufactured. The TIN is molded onto both sides of the tire, although only one side may have the date of manufacture.

(E) Tire Ply Material: The type of cord and number of plies in the sidewall and under the tread.

(F) Uniform Tire Quality Grading (UTQG): Tire manufacturers are required to grade tires based on three performance factors: treadwear, traction and temperature resistance. For more information see *Uniform Tire Quality Grading* on page 6-72.

(G) Maximum Cold Inflation Load Limit: Maximum load that can be carried and the maximum pressure needed to support that load. For information on recommended tire pressure see *Inflation - Tire Pressure* on page 6-59 and *Loading the Vehicle* on page 5-18.

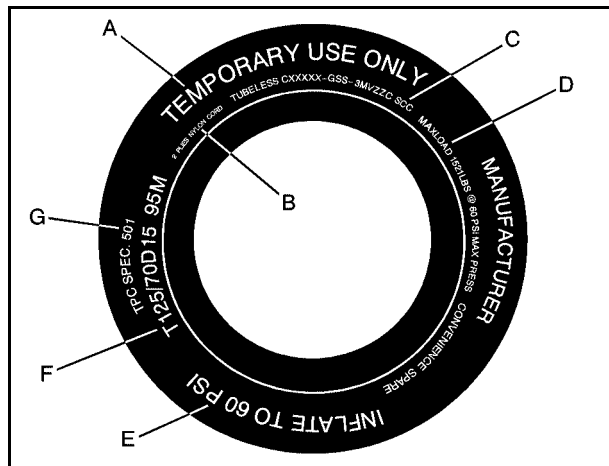

Compact Spare Tire Example

(A) Temporary Use Only: The compact spare tire or temporary use tire has a tread life of approximately 3,000 miles (5 000 km) and should not be driven at speeds over 65 mph (105 km/h). The compact spare tire is for emergency use when a regular road tire has lost air and gone flat. See *Spare Tire* on page 6-95 and *If a Tire Goes Flat* on page 6-76.

(B) Tire Ply Material: The type of cord and number of plies in the sidewall and under the tread.

(C) Tire Identification Number (TIN): The Tire Identification Number (TIN). The TIN shows the manufacturer and plant code, tire size, and date the tire was manufactured. The TIN is molded onto both sides of the tire, although only one side may have the date of manufacture.

(D) Maximum Cold Inflation Load Limit: Maximum load that can be carried and the maximum pressure needed to support that load. See *Inflation - Tire Pressure on page 6-59* and *Loading the Vehicle on page 5-18*.

(E) Tire Inflation: The temporary use tire or compact spare tire should be inflated to 60 psi (420 kPa). For more information on tire pressure and inflation see *Inflation - Tire Pressure on page 6-59* and *Spare Tire on page 6-95*.

(F) Tire Size : A combination of letters and numbers define a tire's width, height, aspect ratio, construction type and service description. The letter T as the first character in the tire size means the tire is for temporary use only.

(G) TPC Spec (Tire Performance Criteria Specification): Original equipment tires designed to GM's specific tire performance criteria have a TPC specification code molded onto the sidewall. GM's TPC specifications meet or exceed all federal safety guidelines.

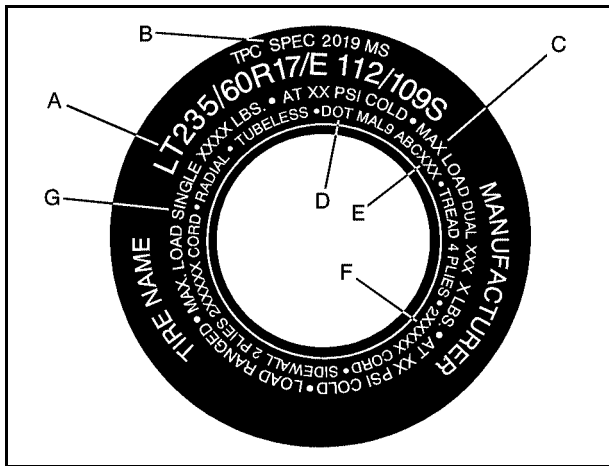

Light Truck Tire Example

(A) Tire Size: The tire size code is a combination of letters and numbers used to define a particular tire's width, height, aspect ratio, construction type and service description. See the "Tire Size" illustration later in this section for more detail.

(B) TPC Spec (Tire Performance Criteria Specification): Original equipment tires designed to GM's specific tire performance criteria have a TPC specification code molded onto the sidewall. GM's TPC specifications meet or exceed all federal safety guidelines.

(C) Dual Tire Maximum Load: Maximum load that can be carried and the maximum pressure needed to support that load when used in a dual configuration.

(D) DOT (Department of Transportation): The Department of Transportation (DOT) code indicates that the tire is in compliance with the U.S. Department of Transportation Motor Vehicle Safety Standards.

(E) Tire Identification Number (TIN): The letters and numbers following DOT code are the Tire Identification Number (TIN). The TIN shows the manufacturer and plant code, tire size, and date the tire was manufactured. The TIN is molded onto both sides of the tire, although only one side may have the date of manufacture.

(F) Tire Ply Material: The type of cord and number of plies in the sidewall and under the tread.

(G) Single Tire Maximum Load: Maximum load that can be carried and the maximum pressure needed to support that load when used as a single. For information on recommended tire pressure see *Inflation - Tire Pressure on page 6-59*.

Tire Size

The following illustration shows an example of a tire size.

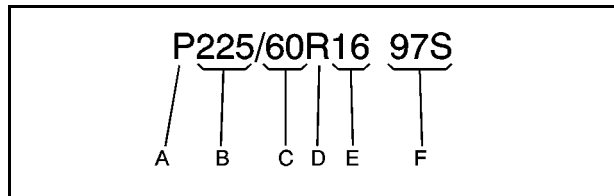

(A) P-Metric Tire: The United States version of a metric tire sizing system. The letter P as the first character in the tire size means a passenger vehicle tire engineered to standards set by the U. S. Tire and Rim Association.

(B) Tire Width: The three-digit number indicates the tire section width in millimeters from sidewall to sidewall.

(C) Aspect Ratio: A two-digit number that indicates the tire height-to-width measurements. For example, if the tire size aspect ratio is 60, as shown in item C of the illustration, it would mean that the tire's sidewall is 60 percent as high as it is wide.

(D) Construction Code: A letter code is used to indicate the type of ply construction in the tire. The letter R means radial ply construction; the letter D means diagonal or bias ply construction; and the letter B means belted-bias ply construction.

(E) Rim Diameter: Diameter of the wheel in inches.

(F) Service Description: These characters represent the load index and speed rating of the tire. The load index represents the load carry capacity a tire is certified to carry. The speed rating is the maximum speed a tire is certified to carry a load.

Tire Terminology and Definitions

Air Pressure: The amount of air inside the tire pressing outward on each square inch of the tire. Air pressure is expressed in pounds per square inch (psi) or kilopascal (kPa).

Accessory Weight: This means the combined weight of optional accessories. Some examples of optional accessories are, automatic transmission, power steering, power brakes, power windows, power seats, and air conditioning.

Aspect Ratio: The relationship of a tire's height to its width.

Belt: A rubber coated layer of cords that is located between the plies and the tread. Cords may be made from steel or other reinforcing materials.

Bead: The tire bead contains steel wires wrapped by steel cords that hold the tire onto the rim.

Bias Ply Tire: A pneumatic tire in which the plies are laid at alternate angles less than 90 degrees to the centerline of the tread.

Cold Tire Pressure: The amount of air pressure in a tire, measured in pounds per square inch (psi) or kilopascals (kPa) before a tire has built up heat from driving. See *Inflation - Tire Pressure on page 6-59*.

Curb Weight: The weight of a motor vehicle with standard and optional equipment including the maximum capacity of fuel, oil, and coolant, but without passengers and cargo.

DOT Markings: A code molded into the sidewall of a tire signifying that the tire is in compliance with the U.S. Department of Transportation (DOT) motor vehicle safety standards. The DOT code includes the Tire Identification Number (TIN), an alphanumeric designator which can also identify the tire manufacturer, production plant, brand, and date of production.

GVWR: Gross Vehicle Weight Rating. See *Loading the Vehicle on page 5-18*.

GAWR FRT: Gross Axle Weight Rating for the front axle. See *Loading the Vehicle on page 5-18*.

GAWR RR: Gross Axle Weight Rating for the rear axle. See *Loading the Vehicle on page 5-18*.

Intended Outboard Sidewall: The side of an asymmetrical tire, that must always face outward when mounted on a vehicle.

Kilopascal (kPa): The metric unit for air pressure.

Light Truck (LT-Metric) Tire: A tire used on light duty trucks and some multipurpose passenger vehicles.

Load Index: An assigned number ranging from 1 to 279 that corresponds to the load carrying capacity of a tire.

Maximum Inflation Pressure: The maximum air pressure to which a cold tire can be inflated. The maximum air pressure is molded onto the sidewall.

Maximum Load Rating: The load rating for a tire at the maximum permissible inflation pressure for that tire.

Maximum Loaded Vehicle Weight: The sum of curb weight, accessory weight, vehicle capacity weight, and production options weight.

Normal Occupant Weight: The number of occupants a vehicle is designed to seat multiplied by 150 lbs (68 kg). See *Loading the Vehicle on page 5-18*.

Occupant Distribution: Designated seating positions.

Outward Facing Sidewall: The side of an asymmetrical tire that has a particular side that faces outward when mounted on a vehicle. The side of the tire that contains a whitewall, bears white lettering, or bears manufacturer, brand, and/or model name molding that is higher or deeper than the same moldings on the other sidewall of the tire.

Passenger (P-Metric) Tire: A tire used on passenger cars and some light duty trucks and multipurpose vehicles.

Recommended Inflation Pressure: Vehicle manufacturer's recommended tire inflation pressure as shown on the tire placard. See *Inflation - Tire Pressure on page 6-59* and *Loading the Vehicle on page 5-18*.

Radial Ply Tire: A pneumatic tire in which the ply cords that extend to the beads are laid at 90 degrees to the centerline of the tread.

Rim: A metal support for a tire and upon which the tire beads are seated.

Sidewall: The portion of a tire between the tread and the bead.

Speed Rating: An alphanumeric code assigned to a tire indicating the maximum speed at which a tire can operate.

Traction: The friction between the tire and the road surface. The amount of grip provided.

Tread: The portion of a tire that comes into contact with the road.

Treadwear Indicators: Narrow bands, sometimes called wear bars, that show across the tread of a tire when only 1/16 inch (1.6 mm) of tread remains. See *When It Is Time for New Tires on page 6-69*.

UTQGS (Uniform Tire Quality Grading Standards): A tire information system that provides consumers with ratings for a tire's traction, temperature, and treadwear. Ratings are determined by tire manufacturers using government testing procedures. The ratings are molded into the sidewall of the tire. See *Uniform Tire Quality Grading on page 6-72*.

Vehicle Capacity Weight: The number of designated seating positions multiplied by 150 lbs (68 kg) plus the rated cargo load. See *Loading the Vehicle on page 5-18*.

Vehicle Maximum Load on the Tire: Load on an individual tire due to curb weight, accessory weight, occupant weight, and cargo weight.

Vehicle Placard: A label permanently attached to a vehicle showing the vehicle's capacity weight and the original equipment tire size and recommended inflation pressure. See "Tire and Loading Information Label" under *Loading the Vehicle on page 5-18*.

Inflation - Tire Pressure

Tires need the correct amount of air pressure to operate effectively.

Notice: Do not let anyone tell you that under-inflation or over-inflation is all right. It is not. If your tires do not have enough air (under-inflation), you can get the following:

- Too much flexing
- Too much heat
- Tire overloading
- Premature or irregular wear
- Poor handling
- Reduced fuel economy

If your tires have too much air (over-inflation), you can get the following:

- Unusual wear
- Poor handling
- Rough ride
- Needless damage from road hazards

A Tire and Loading Information label is attached to the vehicle's center pillar. This label lists your vehicle's original equipment tires and shows the correct inflation pressures for your tires when they are cold. The recommended cold tire inflation pressure, shown on the label, is the minimum amount of air pressure needed to support your vehicle's maximum load carrying capacity.

For additional information regarding how much weight your vehicle can carry, and an example of the Tire and Loading Information label, see *Loading the Vehicle on page 5-18*. How you load your vehicle affects the vehicle handling and ride comfort, never load your vehicle with more weight than it was designed to carry.

When to Check

Check your tires once a month or more. Do not forget to check the spare tire. If your vehicle has a compact spare tire, it should be at 60 psi (420 kPa). For additional information see *Spare Tire on page 6-95*.

How to Check

Use a good quality pocket-type gauge to check tire pressure. You cannot tell if your tires are properly inflated simply by looking at them. Radial tires may look properly inflated even when they are under-inflated. Check the tire's inflation pressure when the tires are cold. Cold means your vehicle has been sitting for at least three hours or driven no more than 1 mile (1.6 km).

Remove the valve cap from the tire valve stem. Press the tire gauge firmly onto the valve to get a pressure measurement. If the cold tire inflation pressure matches the recommended pressure on the Tire and Loading Information label, no further adjustment is necessary. If the inflation pressure is low, add air until you reach the recommended amount.

If you overfill the tire, release air by pushing on the metal stem in the center of the tire valve. Re-check the tire pressure with the tire gauge.

Be sure to put the valve caps back on the valve stems. They help prevent leaks by keeping out dirt and moisture.

Professional Vehicle

The proper inflation of the tires on your professional vehicle depends on the type of tires on it.

- If your vehicle has P235/60R17 size tires, the cold inflation pressure is 41 psi (284 kPa).
- If your vehicle has LT235/60R17E size tires, the cold inflation pressure depends on the vehicle mass and should be determined by the vehicle coach-builder. A Tire and Loading Information label provided by the final stage manufacturer should be attached to the B-pillar on the driver's side of the vehicle. If the final stage manufacturer's label is not present, the coach-builder should be consulted. Do not use the tire pressures indicated on the General Motors label. These tire pressures are for the incomplete vehicle and are not the correct tire pressures for the completed professional vehicle.

Operation at inflation pressures below this recommendation may cause your tires to become overloaded.

High-Speed Operation

WARNING:

Driving at high speeds, 160 km/h (100 mph) or higher, puts an additional strain on tires. Sustained high-speed driving causes excessive heat build up and can cause sudden tire failure. You could have a crash and you or others could be killed. Some high-speed rated tires require inflation pressure adjustment for high speed operation. When speed limits and road conditions are such that a vehicle can be driven at high speeds, make sure the tires are rated for high speed operation, in excellent condition, and set to the correct cold tire inflation pressure for the vehicle load.

If your vehicle has P235/55R17 or P245/50R18 size tires, and you will be driving at speeds of 100 mph (160 km/h) or higher, where it is legal, set the cold inflation pressure to the maximum inflation pressure shown on the tire sidewall, or 38 psi (265 kPa), whichever is lower. See the example following.

Example:

You will find the maximum load and inflation pressure molded on the tire's sidewall, in small letters, near the rim flange. It will read something like this: Maximum load 690 kg (1521 lbs) @ 300 kPa (44 psi) Max. Press.

For this example, you would set the inflation pressure for high-speed driving at 38 psi (265 kPa).

When you end this high-speed driving, return the tires to the cold inflation pressure shown on the Tire and Loading Information label. See *Loading the Vehicle on page 5-18*.

Tire Pressure Monitor System

The Tire Pressure Monitor System (TPMS) uses radio and sensor technology to check tire pressure levels. The TPMS sensors monitor the air pressure in your vehicle's tires and transmit tire pressure readings to a receiver located in the vehicle.

Each tire, including the spare (if provided), should be checked monthly when cold and inflated to the inflation pressure recommended by the vehicle manufacturer on the vehicle placard or tire inflation pressure label. (If your vehicle has tires of a different size than the size indicated on the vehicle placard or tire inflation pressure label, you should determine the proper tire inflation pressure for those tires.)

As an added safety feature, your vehicle has been equipped with a tire pressure monitoring system (TPMS) that illuminates a low tire pressure telltale when one or more of your tires is significantly under-inflated.

Accordingly, when the low tire pressure telltale illuminates, you should stop and check your tires as soon as possible, and inflate them to the proper pressure. Driving on a significantly under-inflated tire causes the tire to overheat and can lead to tire failure. Under-inflation also reduces fuel efficiency and tire tread life, and may affect the vehicle's handling and stopping ability.

Please note that the TPMS is not a substitute for proper tire maintenance, and it is the driver's responsibility to maintain correct tire pressure, even if under-inflation has not reached the level to trigger illumination of the TPMS low tire pressure telltale.

Your vehicle has also been equipped with a TPMS malfunction indicator to indicate when the system is not operating properly. The TPMS malfunction indicator is combined with the low tire pressure telltale. When the system detects a malfunction, the telltale will flash for approximately one minute and then remain continuously illuminated. This sequence will continue upon subsequent vehicle start-ups as long as the malfunction exists.

When the malfunction indicator is illuminated, the system may not be able to detect or signal low tire pressure as intended. TPMS malfunctions may occur for a variety of reasons, including the installation of replacement or alternate tires or wheels on the vehicle that prevent the TPMS from functioning properly. Always check the TPMS malfunction telltale after replacing one or more tires or wheels on your vehicle to ensure that the replacement or alternate tires and wheels allow the TPMS to continue to function properly.

See *Tire Pressure Monitor Operation* on page 6-63 for additional information.

Federal Communications Commission (FCC) and Industry Canada

See *Radio Frequency Statement on page 8-20* for information regarding Part 15 of the Federal Communications Commission (FCC) Rules and RSS-210/211 of Industry Canada.

Tire Pressure Monitor Operation

This vehicle may have a Tire Pressure Monitor System (TPMS). The TPMS is designed to warn the driver when a low tire pressure condition exists. TPMS sensors are mounted onto each tire and wheel assembly, excluding the spare tire and wheel assembly. The TPMS sensors monitor the air pressure in the vehicle's tires and transmits the tire pressure readings to a receiver located in the vehicle.

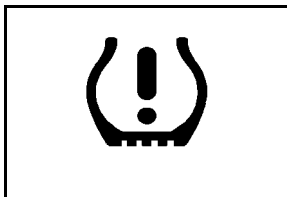

When a low tire pressure condition is detected, the TPMS illuminates the low tire pressure warning light located on the instrument panel cluster.

If the warning light comes on, stop as soon as possible and inflate the tires to the recommended pressure shown on the tire loading information label. See *Loading the Vehicle on page 5-18*.

At the same time a message to check the pressure in a specific tire appears on the Driver Information Center (DIC) display. The low tire pressure warning light and the DIC warning message come on at each ignition cycle until the tires are inflated to the correct inflation pressure. Using the DIC, tire pressure levels can be viewed by the driver. For additional information and details about the DIC operation and displays see *DIC Operation and Displays on page 4-61* and *DIC Warnings and Messages on page 4-66*.

The low tire pressure warning light may come on in cool weather when the vehicle is first started, and then turn off as you start to drive. This could be an early indicator that the air pressure in the tire(s) are getting low and need to be inflated to the proper pressure.

A Tire and Loading Information label, attached to your vehicle, shows the size of your vehicle's original equipment tires and the correct inflation pressure for your vehicle's tires when they are cold. See *Loading the Vehicle on page 5-18*, for an example of the Tire and Loading Information label and its location on your vehicle. Also see *Inflation - Tire Pressure on page 6-59*.

Your vehicle's TPMS can warn you about a low tire pressure condition but it does not replace normal tire maintenance. See *Tire Inspection and Rotation on page 6-67* and *Tires on page 6-50*.

Notice: Using non-approved tire sealants could damage the Tire Pressure Monitor System (TPMS) sensors. TPMS sensor damage caused by using an incorrect tire sealant is not covered by the vehicle warranty. Always use the GM approved tire sealant available through your dealer.

Factory-installed Tire Inflator Kits use a GM approved liquid tire sealant. Using non-approved tire sealants could damage the TPMS sensors. See *Tire Sealant and Compressor Kit on page 6-77* for information regarding the inflator kit materials and instructions.

TPMS Malfunction Light and Message

The TPMS will not function properly if one or more of the TPMS sensors are missing or inoperable. When the system detects a malfunction, the low tire warning light flashes for about one minute and then stays on for the remainder of the ignition cycle. A DIC warning message is also displayed. The low tire warning light and DIC warning message come on at each ignition cycle until the problem is corrected. Some of the conditions that can cause the malfunction light and DIC message to come on are:

- One of the road tires has been replaced with the spare tire. The spare tire does not have a TPMS sensor. The TPMS malfunction light and DIC message should go off once you re-install the road tire containing the TPMS sensor.
- The TPMS sensor matching process was started but not completed or not completed successfully after rotating the vehicle's tires. The DIC message and TPMS malfunction light should go off once the TPMS sensor matching process is performed successfully. See "TPMS Sensor Matching Process" later in this section.

- One or more TPMS sensors are missing or damaged. The DIC message and the TPMS malfunction light should go off when the TPMS sensors are installed and the sensor matching process is performed successfully. See your dealer/retailer for service.
- Replacement tires or wheels do not match your vehicle's original equipment tires or wheels. Tires and wheels other than those recommended for your vehicle could prevent the TPMS from functioning properly. See *Buying New Tires on page 6-70*.
- Operating electronic devices or being near facilities using radio wave frequencies similar to the TPMS could cause the TPMS sensors to malfunction.

If the TPMS is not functioning it cannot detect or signal a low tire condition. See your dealer/retailer for service if the TPMS malfunction light and DIC message comes on and stays on.

TPMS Sensor Matching Process

Each TPMS sensor has a unique identification code. Any time you rotate your vehicle's tires or replace one or more of the TPMS sensors, the identification codes will need to be matched to the new tire/wheel position. The sensors are matched to the tire/wheel positions in the following order: driver side front tire, passenger side front tire, passenger side rear tire, and driver side rear tire using a TPMS diagnostic tool. See your dealer/retailer for service.

The TPMS sensors can also be matched to each tire/wheel position by increasing or decreasing the tire's air pressure. If increasing the tire's air pressure, do not exceed the maximum inflation pressure indicated on the tire's sidewall.

To decrease air-pressure out of a tire you can use the pointed end of the valve cap, a pencil-style air pressure gauge, or a key.

You have two minutes to match the first tire/wheel position, and five minutes overall to match all four tire/wheel positions. If it takes longer than two minutes, to match the first tire and wheel, or more than five minutes to match all four tire and wheel positions the matching process stops and you need to start over.

The TPMS sensor matching process is outlined below:

1. Set the parking brake.
2. Turn the ignition switch to ON/RUN with the engine off.
3. Press the Remote Keyless Entry (RKE) transmitter's lock and unlock buttons at the same time for approximately five seconds. The horn sounds twice to signal the receiver is in relearn mode and TIRE LEARNING ACTIVE message displays on the DIC screen.
4. Start with the driver side front tire.
5. Remove the valve cap from the valve cap stem. Activate the TPMS sensor by increasing or decreasing the tire's air pressure for five seconds, or until a horn chirp sounds. The horn chirp, which may take up to 30 seconds to sound, confirms that the sensor identification code has been matched to this tire and wheel position.
6. Proceed to the passenger side front tire, and repeat the procedure in Step 5.
7. Proceed to the passenger side rear tire, and repeat the procedure in Step 5.
8. Proceed to the driver side rear tire, and repeat the procedure in Step 5. The horn sounds two times to indicate the sensor identification code has been matched to the driver side rear tire, and the TPMS sensor matching process is no longer active. The TIRE LEARNING ACTIVE message on the DIC display screen goes off.
9. Turn the ignition switch to LOCK/OFF.
10. Set all four tires to the recommended air pressure level as indicated on the Tire and Loading Information label.
11. Put the valve caps back on the valve stems.

Tire Inspection and Rotation

We recommend that you regularly inspect your vehicle's tires, including the spare tire, for signs of wear or damage. See *When It Is Time for New Tires* on page 6-69 for more information.

Tires should be rotated every 5,000 to 8,000 miles (8 000 to 13 000 km). See *Scheduled Maintenance* on page 7-3.

The purpose of a regular tire rotation is to achieve a uniform wear for all tires on the vehicle. This will ensure that your vehicle continues to perform most like it did when the tires were new.

Any time you notice unusual wear, rotate your tires as soon as possible and check wheel alignment. Also check for damaged tires or wheels. See *When It Is Time for New Tires* on page 6-69 and *Wheel Replacement* on page 6-74 for more information.

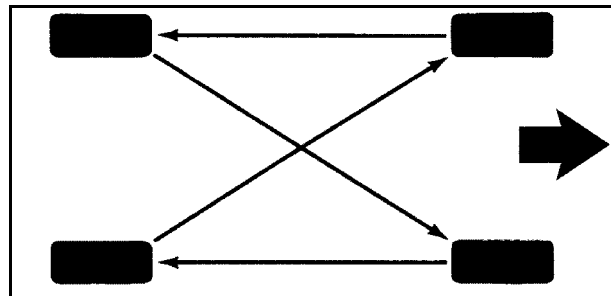

Four-Tire Rotation Pattern

If your vehicle has a compact spare tire, it should not be included in the tire rotation process. Use the four-tire rotation pattern shown.

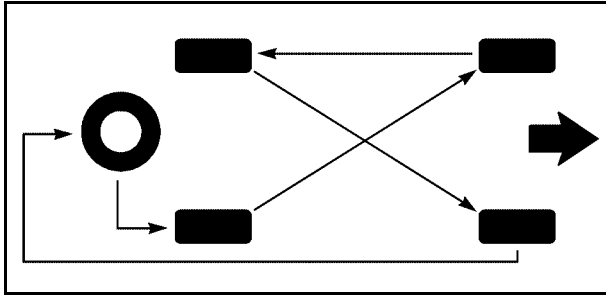

Five-Tire Rotation Pattern

A five-tire rotation pattern may be used for your professional vehicle, if it has a full-size spare tire and wheel assembly that matches the original equipment tires and wheels in size, type and brand. The correct five-tire rotation pattern is shown.

After the tires have been rotated, adjust the front and rear inflation pressures as shown on the Tire and Loading Information label. See *Loading the Vehicle* on page 5-18.

Vehicles that have the Tire Pressure Monitor System (TPMS) will need to have the sensors reset after a tire rotation is performed. See *Tire Pressure Monitor System* on page 6-62.

Make certain that all wheel nuts are properly tightened. See "Wheel Nut Torque" under *Capacities and Specifications* on page 6-114.

⚠ WARNING:

Rust or dirt on a wheel, or on the parts to which it is fastened, can make wheel nuts become loose after time. The wheel could come off and cause an accident. When you change a wheel, remove any rust or dirt from places where the wheel attaches to the vehicle. In an emergency, you can use a cloth or a paper towel to do this; but be sure to use a scraper or wire brush later, if needed, to get all the rust or dirt off. See *Changing a Flat Tire* on page 6-85.

When It Is Time for New Tires

Various factors, such as maintenance, temperatures, driving speeds, vehicle loading, and road conditions influence when you need new tires.

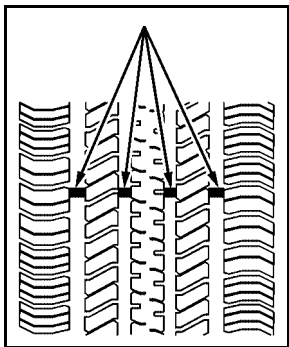

One way to tell when it is time for new tires is to check the treadwear indicators, which will appear when your tires have only 1/16 inch (1.6 mm) or less of tread remaining.

You need new tires if any of the following statements are true:

- You can see the indicators at three or more places around the tire.
- You can see cord or fabric showing through the tire's rubber.
- The tread or sidewall is cracked, cut, or snagged deep enough to show cord or fabric.
- The tire has a bump, bulge, or split.
- The tire has a puncture, cut, or other damage that cannot be repaired well because of the size or location of the damage.

The rubber in tires degrades over time, even if they are not being used. This is also true for the spare tire, if your vehicle has one. Multiple conditions affect how fast this aging takes place, including temperatures, loading conditions, and inflation pressure maintenance. With proper care and maintenance tires will typically wear out before they degrade due to age. If you are unsure about the need to replace your tires as they get older, consult the tire manufacturer for more information.

Buying New Tires

GM has developed and matched specific tires for your vehicle. The original equipment tires installed on your vehicle, when it was new, were designed to meet General Motors Tire Performance Criteria Specification (TPC Spec) system rating. If you need replacement tires, GM strongly recommends that you get tires with the same TPC Spec rating. This way, your vehicle will continue to have tires that are designed to give the same performance and vehicle safety, during normal use, as the original tires.

GM's exclusive TPC Spec system considers over a dozen critical specifications that impact the overall performance of your vehicle, including brake system performance, ride and handling, traction control, and tire pressure monitoring performance. GM's TPC Spec number is molded onto the tire's sidewall near the tire size. If the tires have an all-season tread design, the TPC Spec number will be followed by an MS for mud and snow. See *Tire Sidewall Labeling on page 6-51* for additional information.

GM recommends replacing tires in sets of four. This is because uniform tread depth on all tires will help keep your vehicle performing most like it did when the tires were new. Replacing less than a full set of tires can affect the braking and handling performance of your vehicle. See *Tire Inspection and Rotation on page 6-67* for information on proper tire rotation.

WARNING:

Mixing tires could cause you to lose control of your vehicle while driving. If you mix tires of different sizes, brands, or types (radial and bias-belted tires), the vehicle may not handle properly, and you could have a crash. Using tires of different sizes, brands, or types may also cause damage to your vehicle. Be sure to use the correct size, brand, and type of tires on all wheels.

Your vehicle may have a compact spare tire and wheel assembly. If the vehicle has a compact spare tire and wheel, they have the same overall diameter as your vehicle's full-size tires and wheels. Because they were designed and developed for use on your vehicle, it is all right to drive your vehicle with the compact spare installed properly. Compact spare tires are designed for temporary use only. See *Spare Tire on page 6-95*.

 **WARNING:**

If you use bias-ply tires on the vehicle, the wheel rim flanges could develop cracks after many miles of driving. A tire and/or wheel could fail suddenly, causing a crash. Use only radial-ply tires with the wheels on the vehicle.

If you must replace your vehicle's tires with those that do not have a TPC Spec number, make sure they are the same size, load range, speed rating, and construction type (radial and bias-belted tires) as your vehicle's original tires.

Vehicles that have a tire pressure monitoring system could give an inaccurate low-pressure warning if non-TPC Spec rated tires are installed on your vehicle. Non-TPC Spec rated tires may give a low-pressure warning that is higher or lower than the proper warning level you would get with TPC Spec rated tires. See *Tire Pressure Monitor System on page 6-62*.

Your vehicle's original equipment tires are listed on the Tire and Loading Information Label. See *Loading the Vehicle on page 5-18*, for more information about the Tire and Loading Information Label and its location on your vehicle.

Different Size Tires and Wheels

If you add wheels or tires that are a different size than your original equipment wheels and tires, this may affect the way your vehicle performs, including its braking, ride and handling characteristics, stability, and resistance to rollover. Additionally, if your vehicle has electronic systems such as, antilock brakes, traction control, and electronic stability control, the performance of these systems can be affected.

 **WARNING:**

If you add different sized wheels, your vehicle may not provide an acceptable level of performance and safety if tires not recommended for those wheels are selected. You may increase the chance that you will crash and suffer serious injury. Only use GM specific wheel and tire systems developed for your vehicle, and have them properly installed by a GM certified technician.

See *Buying New Tires on page 6-70* and *Accessories and Modifications on page 6-3* for additional information.

Uniform Tire Quality Grading

Quality grades can be found where applicable on the tire sidewall between tread shoulder and maximum section width. For example:

Treadwear 200 Traction AA Temperature A

The following information relates to the system developed by the United States National Highway Traffic Safety Administration (NHTSA), which grades tires by treadwear, traction, and temperature performance. This applies only to vehicles sold in the United States. The grades are molded on the sidewalls of most passenger car tires. The Uniform Tire Quality Grading (UTQG) system does not apply to deep tread, winter-type snow tires, space-saver, or temporary use spare tires, tires with nominal rim diameters of 10 to 12 inches (25 to 30 cm), or to some limited-production tires.

While the tires available on General Motors passenger cars and light trucks may vary with respect to these grades, they must also conform to federal safety requirements and additional General Motors Tire Performance Criteria (TPC) standards.

All Passenger Car Tires Must Conform to Federal Safety Requirements In Addition To These Grades.

Treadwear

The treadwear grade is a comparative rating based on the wear rate of the tire when tested under controlled conditions on a specified government test course. For example, a tire graded 150 would wear one and a half (1½) times as well on the government course as a tire graded 100. The relative performance of tires depends upon the actual conditions of their use, however, and may depart significantly from the norm due to variations in driving habits, service practices and differences in road characteristics and climate.

Traction – AA, A, B, C

The traction grades, from highest to lowest, are AA, A, B, and C. Those grades represent the tire's ability to stop on wet pavement as measured under controlled conditions on specified government test surfaces of asphalt and concrete. A tire marked C may have poor traction performance. Warning: The traction grade assigned to this tire is based on straight-ahead braking traction tests, and does not include acceleration, cornering, hydroplaning, or peak traction characteristics.

Temperature – A, B, C

The temperature grades are A (the highest), B, and C, representing the tire's resistance to the generation of heat and its ability to dissipate heat when tested under controlled conditions on a specified indoor laboratory test wheel. Sustained high temperature can cause the material of the tire to degenerate and reduce tire life, and

excessive temperature can lead to sudden tire failure. The grade C corresponds to a level of performance which all passenger car tires must meet under the Federal Motor Safety Standard No. 109. Grades B and A represent higher levels of performance on the laboratory test wheel than the minimum required by law. Warning: The temperature grade for this tire is established for a tire that is properly inflated and not overloaded. Excessive speed, underinflation, or excessive loading, either separately or in combination, can cause heat buildup and possible tire failure.

Wheel Alignment and Tire Balance

The tires and wheels on your vehicle were aligned and balanced carefully at the factory to give you the longest tire life and best overall performance. Adjustments to wheel alignment and tire balancing will not be necessary on a regular basis. However, if you notice unusual tire wear or your vehicle pulling to one side or the other, the alignment might need to be checked. If you notice your vehicle vibrating when driving on a smooth road, the tires and wheels might need to be rebalanced. See your dealer for proper diagnosis.

Wheel Replacement

Replace any wheel that is bent, cracked or badly rusted or corroded. If wheel nuts keep coming loose, the wheel, wheel bolts and wheel nuts should be replaced. If the wheel leaks air, replace it. Some aluminum wheels can sometimes be repaired. See your GM dealer if any of these conditions exist.

Your GM dealer will know the kind of wheel you need.

Each new wheel should have the same load-carrying capacity, diameter, width, offset and be mounted the same way as the one it replaces.

If you need to replace any of your wheels, wheel bolts, wheel nuts, or Tire Pressure Monitor System (TPMS) sensors, replace them only with new GM original equipment parts. This way, you will be sure to have the right wheel, wheel bolts, wheel nuts, and TPMS sensors for your vehicle.

WARNING:

Using the wrong replacement wheels, wheel bolts, or wheel nuts on your vehicle can be dangerous. It could affect the braking and handling of your vehicle, make your tires lose air and make you lose control. You could have a collision in which you or others could be injured. Always use the correct wheel, wheel bolts, and wheel nuts for replacement.

Notice: The wrong wheel can also cause problems with bearing life, brake cooling, speedometer or odometer calibration, headlamp aim, bumper height, vehicle ground clearance, and tire or tire chain clearance to the body and chassis.

If your vehicle is a professional model, the wheels have a unique offset and bolt hole diameter. Each of the wheels on the professional vehicle have eight wheel nuts. The wheels on the non-professional vehicle have five wheel nuts. See *Changing a Flat Tire* on page 6-85 for more information.

Used Replacement Wheels

WARNING:

Putting a used wheel on the vehicle is dangerous. You cannot know how it has been used or how far it has been driven. It could fail suddenly and cause a crash. If you have to replace a wheel, use a new GM original equipment wheel.

Tire Chains

WARNING:

Do not use tire chains. There is not enough clearance. Tire chains used on a vehicle without the proper amount of clearance can cause damage to the brakes, suspension or other vehicle parts. The area damaged by the tire chains could cause you to lose control of the vehicle and you or others may be injured in a crash.

Use another type of traction device only if its manufacturer recommends it for use on the vehicle and tire size combination and road conditions. Follow that manufacturer's instructions. To help avoid damage to the vehicle, drive slowly, readjust or remove the device if it is contacting the vehicle, and do not spin the vehicle's wheels. If you do find traction devices that will fit, install them on the front tires.

If a Tire Goes Flat

It is unusual for a tire to blowout while you are driving, especially if you maintain your vehicle's tires properly. If air goes out of a tire, it is much more likely to leak out slowly. But if you should ever have a blowout, here are a few tips about what to expect and what to do:

If a front tire fails, the flat tire creates a drag that pulls the vehicle toward that side. Take your foot off the accelerator pedal and grip the steering wheel firmly. Steer to maintain lane position, and then gently brake to a stop well out of the traffic lane.

A rear blowout, particularly on a curve, acts much like a skid and may require the same correction you would use in a skid. In any rear blowout remove your foot from the accelerator pedal. Get the vehicle under control by steering the way you want the vehicle to go. It may be very bumpy and noisy, but you can still steer. Gently brake to a stop, well off the road if possible.

WARNING:

Lifting a vehicle and getting under it to do maintenance or repairs is dangerous without the appropriate safety equipment and training. If a jack is provided with the vehicle, it is designed only for changing a flat tire. If it is used for anything else, you or others could be badly injured or killed if the vehicle slips off the jack. If a jack is provided with the vehicle, only use it for changing a flat tire.

This vehicle may come with a jack and spare tire or a tire sealant and compressor kit. To use the jack and spare tire, follow the instructions below. To use the tire sealant and compressor kit, see *Tire Sealant and Compressor Kit* on page 6-77.

Tire Sealant and Compressor Kit

WARNING:

Idling a vehicle in an enclosed area with poor ventilation is dangerous. Engine exhaust may enter the vehicle. Engine exhaust contains Carbon Monoxide (CO) which cannot be seen or smelled. It can cause unconsciousness and even death. Never run the engine in an enclosed area that has no fresh air ventilation. For more information, see *Engine Exhaust on page 3-34*.

WARNING:

Over-inflating a tire could cause the tire to rupture and you or others could be injured. Be sure to read and follow the tire sealant and compressor kit instructions and inflate the tire to its recommended pressure. Do not exceed the recommended pressure.

WARNING:

Storing the tire sealant and compressor kit or other equipment in the passenger compartment of the vehicle could cause injury. In a sudden stop or collision, loose equipment could strike someone. Store the tire sealant and compressor kit in its original location.

If this vehicle has a tire sealant and compressor kit, there may not be a spare tire, tire changing equipment, and on some vehicles there may not be a place to store a tire.

The tire sealant and compressor can be used to temporarily seal punctures up to ¼ inch (6 mm) in the tread area of the tire. It can also be used to inflate an under inflated tire.

If the tire has been separated from the wheel, has damaged sidewalls, or has a large puncture, the tire is too severely damaged for the tire sealant and compressor kit to be effective. See *Roadside Service on page 8-7*.

Read and follow all of the tire sealant and compressor kit instructions.

The kit includes:

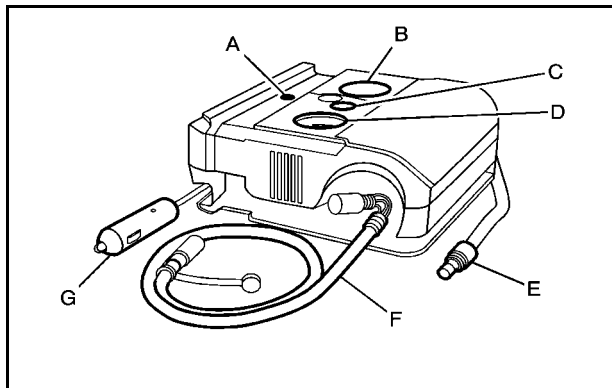

- | | |
|---|--------------------------------|
| A. On/Off Button | E. Air Only
Hose (Black) |
| B. Selector Switch
(Sealant/Air or Air Only) | F. Sealant/Air
Hose (Clear) |
| C. Pressure Relief Button | G. Power Plug |
| D. Pressure Gauge | |

Tire Sealant

Read and follow the safe handling instructions on the label adhered to the compressor.

Check the tire sealant expiration date on the sealant canister. The sealant canister should be replaced before its expiration date. Replacement sealant canisters are available at your local dealer. See "Removal and Installation of the Sealant Canister" following.

There is only enough sealant to seal one tire. After usage, the sealant canister and sealant/air hose assembly must be replaced. See "Removal and Installation of the Sealant Canister" following.

Using the Tire Sealant and Compressor Kit to Temporarily Seal and Inflate a Punctured Tire

Follow the directions closely for correct sealant usage.

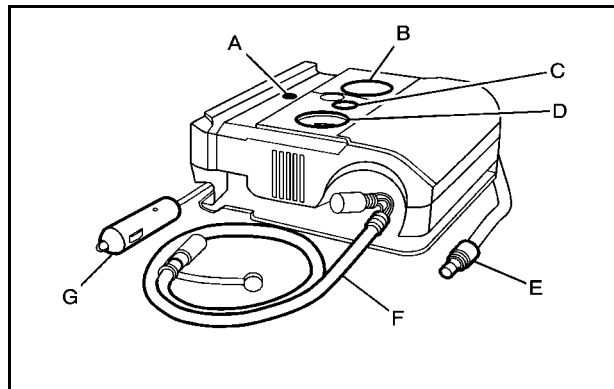

When using the tire sealant and compressor kit during cold temperatures, warm the kit in a heated environment for 5 minutes. This will help to inflate the tire faster.

Always do a safety check first. See *If a Tire Goes Flat on page 6-76*. Do not remove any objects that have penetrated the tire.

1. Remove the tire sealant and compressor kit from its storage location. See *Tire Sealant and Compressor Kit Storage on page 6-84*.

2. Unwrap the sealant/air hose (F) and the power plug (G).

3. Place the kit on the ground.

Make sure the tire valve stem is positioned close to the ground so the hose will reach it.

4. Remove the valve stem cap from the flat tire by turning it counterclockwise.
5. Attach the sealant/air hose (F) onto the tire valve stem. Turn it clockwise until it is tight.
6. Plug the power plug (G) into the accessory power outlet in the vehicle. Unplug all items from other accessory power outlets. See *Accessory Power Outlet(s) on page 4-34*.

If the vehicle has an accessory power outlet, do not use the cigarette lighter.

If the vehicle only has a cigarette lighter, use the cigarette lighter.

Do not pinch the power plug cord in the door or window.

7. Start the vehicle. The vehicle must be running while using the air compressor.
8. Turn the selector switch (B) clockwise to the Sealant + Air position.
9. Press the on/off (A) button to turn the tire sealant and compressor kit on.

The compressor will inject sealant and air into the tire.

The pressure gauge (D) will initially show a high pressure while the compressor pushes the sealant into the tire. Once the sealant is completely dispersed into the tire, the pressure will quickly drop and start to rise again as the tire inflates with air only.

10. Inflate the tire to the recommended inflation pressure using the pressure gauge (D). The recommended inflation pressure can be found on the Tire and Loading Information label. See *Inflation - Tire Pressure on page 6-59*.

The pressure gauge (D) may read higher than the actual tire pressure while the compressor is on. Turn the compressor off to get an accurate pressure reading. The compressor may be turned on/off until the correct pressure is reached.

Notice: If the recommended pressure cannot be reached after approximately 25 minutes, the vehicle should not be driven farther. The tire is too severely damaged and the tire sealant and compressor kit cannot inflate the tire. Remove the power plug from the accessory power outlet and unscrew the inflating hose from the tire valve. See *Roadside Service on page 8-7*.

11. Press the on/off button (A) to turn the tire sealant and compressor kit off.

The tire is not sealed and will continue to leak air until the vehicle is driven and the sealant is distributed in the tire, therefore, Steps 12 through 18 must be done immediately after Step 11.

Be careful while handling the tire sealant and compressor kit as it could be warm after usage.

12. Unplug the power plug (G) from the accessory power outlet in the vehicle.
13. Turn the sealant/air hose (F) counterclockwise to remove it from the tire valve stem.
14. Replace the tire valve stem cap.
15. Replace the sealant/air hose (F), and the power plug (G) back in their original location.

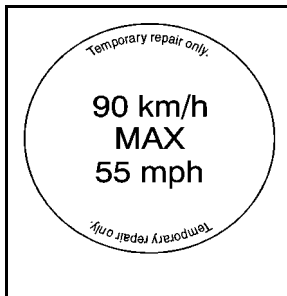

16. If the flat tire was able to inflate to the recommended inflation pressure, remove the maximum speed label from the sealant canister and place it in a highly visible location. The label is a reminder not to exceed 55 mph (90 km/h) until the damaged tire is repaired or replaced.
17. Return the equipment to its original storage location in the vehicle.
18. Immediately drive the vehicle 5 miles (8 km) to distribute the sealant in the tire.
19. Stop at a safe location and check the tire pressure. Refer to Steps 1 through 11 under “Using the Tire Sealant and Compressor Kit without Sealant to Inflate a Tire (Not Punctured).”

If the tire pressure has fallen more than 10 psi (68 kPa) below the recommended inflation pressure, stop driving the vehicle. The tire is too severely damaged and the tire sealant cannot seal the tire. See *Roadside Service on page 8-7*.

If the tire pressure has not dropped more than 10 psi (68 kPa) from the recommended inflation pressure, inflate the tire to the recommended inflation pressure.
20. Wipe off any sealant from the wheel, tire, and vehicle.
21. Dispose of the used sealant canister and sealant/air hose (F) assembly at a local dealer or in accordance with local state codes and practices.
22. Replace it with a new canister available from your dealer.
23. After temporarily sealing a tire using the tire sealant and compressor kit, take the vehicle to an authorized dealer within a 100 miles (161 km) of driving to have the tire repaired or replaced.

Using the Tire Sealant and Compressor Kit without Sealant to Inflate a Tire (Not Punctured)

To use the air compressor to inflate a tire with air only and not sealant:

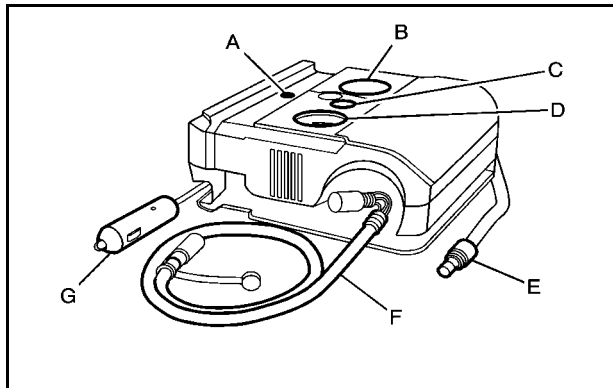

Always do a safety check first. See *If a Tire Goes Flat* on page 6-76.

1. Remove the tire sealant and compressor kit from its storage location. See *Tire Sealant and Compressor Kit Storage* on page 6-84.

2. Unwrap the air only hose (E) and the power plug (G).

3. Place the kit on the ground.

Make sure the tire valve stem is positioned close to the ground so the hose will reach it.

4. Remove the tire valve stem cap from the flat tire by turning it counterclockwise.

5. Attach the air only hose (E) onto the tire valve stem by turning it clockwise until it is tight.

6. Plug the power plug (G) into the accessory power outlet in the vehicle. Unplug all items from other accessory power outlets. See *Accessory Power Outlet(s)* on page 4-34.

If the vehicle has an accessory power outlet, do not use the cigarette lighter.

If the vehicle only has a cigarette lighter, use the cigarette lighter.

Do not pinch the power plug cord in the door or window.

7. Start the vehicle. The vehicle must be running while using the air compressor.

8. Turn the selector switch (B) counterclockwise to the Air Only position.

9. Press the on/off (A) button to turn the compressor on.

The compressor will inflate the tire with air only.

10. Inflate the tire to the recommended inflation pressure using the pressure gauge (D).
The recommended inflation pressure can be found on the Tire and Loading Information label. See *Inflation - Tire Pressure on page 6-59*.

The pressure gauge (D) may read higher than the actual tire pressure while the compressor is on. Turn the compressor off to get an accurate reading. The compressor may be turned on/off until the correct pressure is reached.

11. Press the on/off button (A) to turn the tire sealant and compressor kit off.

Be careful while handling the tire sealant and compressor kit as it could be warm after usage.

12. Unplug the power plug (G) from the accessory power outlet in the vehicle.
13. Disconnect the air only hose (E) from the tire valve stem, by turning it counterclockwise, and replace the tire valve stem cap.
14. Replace the air only hose (E) and the power plug (G) and cord back in its original location.
15. Place the equipment in the original storage location in the vehicle.

Removal and Installation of the Sealant Canister

To remove the sealant canister:

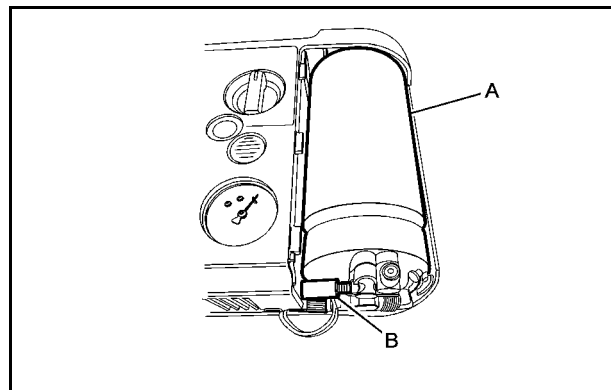

1. Remove the plastic cover.
2. Unscrew the connector (B) from the canister (A).

3. Pull up on the canister (A) to remove it.
4. Replace with a new canister which is available from your dealer.
5. Push the new canister into place.
6. Screw the connector (B) to the canister (A).
7. Slide the plastic cover back on.

Tire Sealant and Compressor Kit Storage

The tire sealant and compressor kit is located in the trunk.

1. Open the trunk. See *Trunk* on page 3-12.
2. Lift the cover.

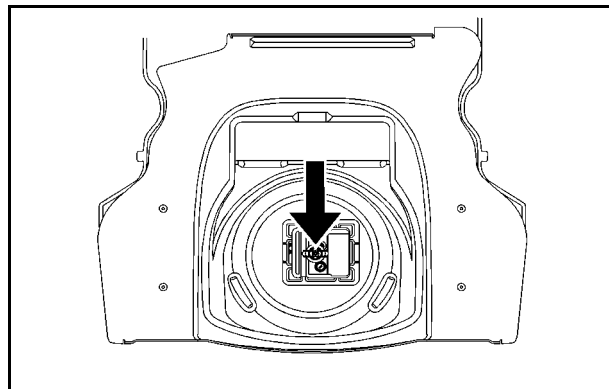

3. Turn the retainer clockwise and remove the tire sealant and compressor kit.

To store the tire sealant and compressor kit, reverse the steps.

Changing a Flat Tire

If a tire goes flat, avoid further tire and wheel damage by driving slowly to a level place. Turn on the hazard warning flashers. See *Hazard Warning Flashers on page 4-3*.

WARNING:

Changing a tire can be dangerous. The vehicle can slip off the jack and roll over or fall on you or other people. You and they could be badly injured or even killed. Find a level place to change your tire. To help prevent the vehicle from moving:

1. Set the parking brake firmly.
2. Put the shift lever in P (Park).
3. Turn off the engine and do not restart while the vehicle is raised.
4. Do not allow passengers to remain in the vehicle.

To be even more certain the vehicle will not move, you should put blocks at the front and rear of the tire farthest away from the one being changed. That would be the tire, on the other side, at the opposite end of the vehicle.

When the vehicle has a flat tire (B), use the following example as a guide to assist you in the placement of wheel blocks (A).

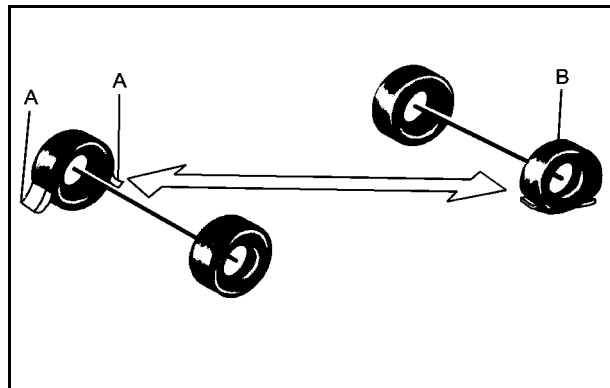

A. Wheel Block

B. Flat Tire

The following information explains how to use the jack and change a tire.

Removing the Spare Tire and Tools

The equipment needed is in the trunk. To access the equipment:

1. Open the trunk. See *Trunk on page 3-12* for more information.

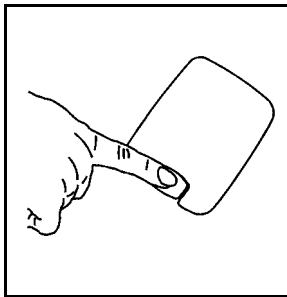

2. Press the area at the front of the handle located on the cover so that the back edge raises.

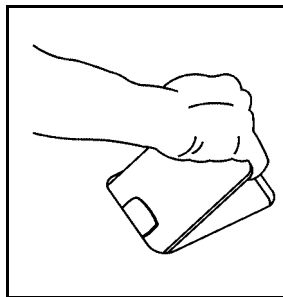

3. Grab the handle and remove the cover.

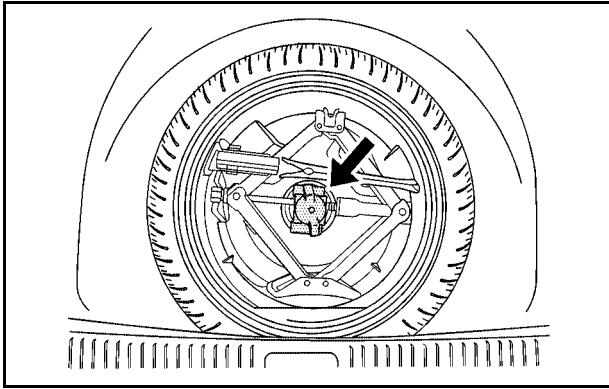

4. Turn the wing nut to remove the retainer that holds the wrench and jack.
5. Remove the wheel wrench, jack and spare tire from the trunk. See *Spare Tire* on page 6-95 for more information.

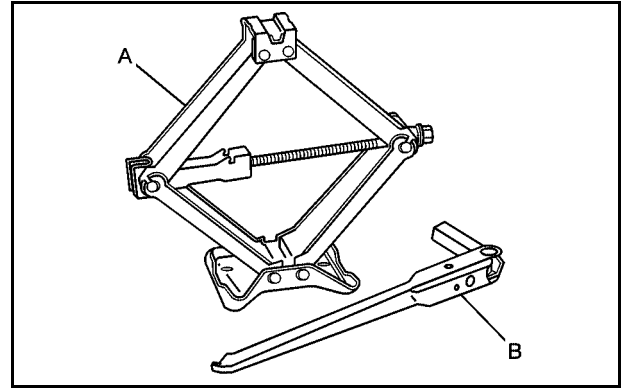

The tools to be used are the jack (A) and the wheel wrench (B).

Removing the Flat Tire and Installing the Spare Tire

1. Do a safety check before proceeding. See *Changing a Flat Tire on page 6-85* for more information.

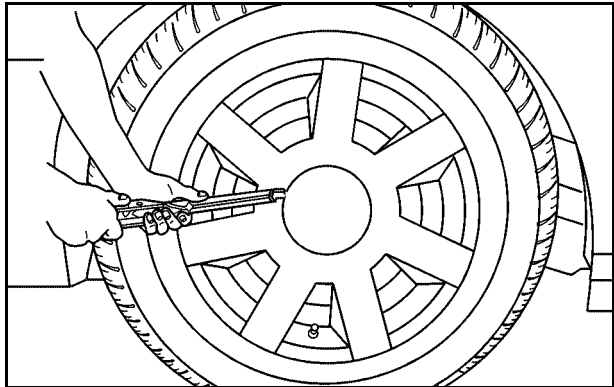

2. For models having aluminum wheels with a center wheel cover, use the flat end of the wheel wrench to gently pry the wheel covers off. Store the wheel cover and lug nut caps in the trunk until you have the flat tire repaired or replaced.

Be careful not to scratch the aluminum wheel edge and do not try to remove it with your hands. Then loosen the wheel nuts with the wheel wrench. Do not remove them yet.

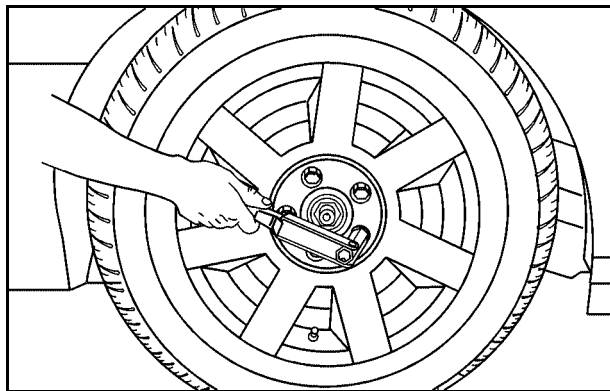

3. For models with exposed lug nuts, loosen them using the wheel wrench. Do not remove them yet.

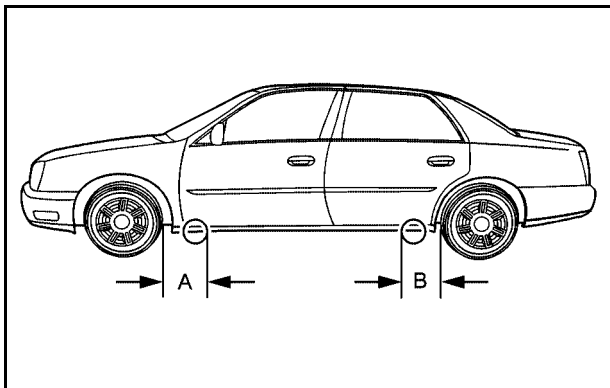

4. Find the jacking location from the diagram above and use the corresponding cutouts located in the plastic molding.

The front location is (A) 8.5 inches (21 cm) from the rear edge of the front wheel well, and the rear location (B) is 3.5 inches (8.5 cm) from the front edge of the rear wheel well.

The notches may also be labeled JACK with an arrow pointing to the jacking location on the vehicle.

WARNING:

Getting under a vehicle when it is jacked up is dangerous. If the vehicle slips off the jack, you could be badly injured or killed. Never get under a vehicle when it is supported only by a jack.

WARNING:

Raising your vehicle with the jack improperly positioned can damage the vehicle and even make the vehicle fall. To help avoid personal injury and vehicle damage, be sure to fit the jack lift head into the proper location before raising the vehicle.

Notice: If you position the jack under the rocker molding and attempt to raise the vehicle, you could break the molding and/or cause other damage to your vehicle. Always position the jack so that when the jack head is raised, it will fit firmly in the notch located inboard from the rocker molding.

5. Turn the jack handle counterclockwise to lower the jack lift head until the jack fits under the vehicle.

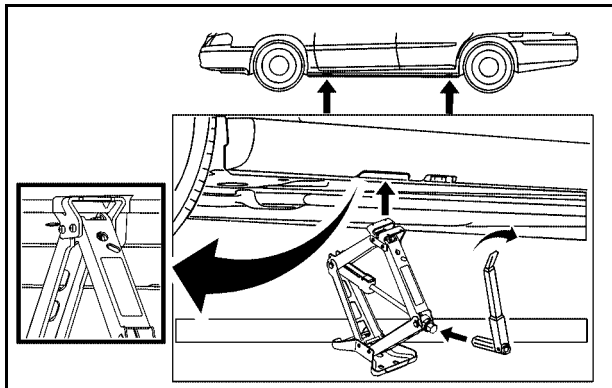

6. Raise the jack until the metal flange fits firmly into the channel of the jack head.
7. Put the spare tire near you.

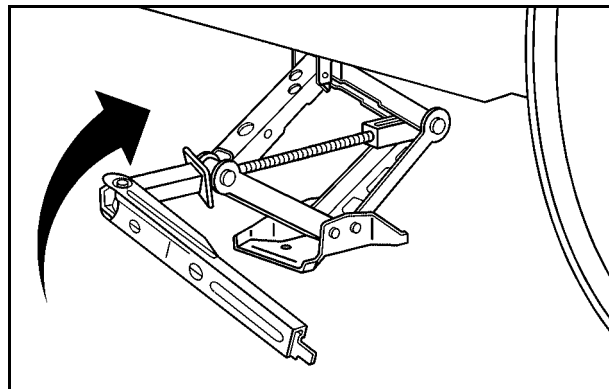

8. Raise the vehicle by turning the jack handle clockwise. Raise the vehicle far enough off the ground for the spare tire to fit under the vehicle.
9. Remove all wheel nuts and the flat tire.

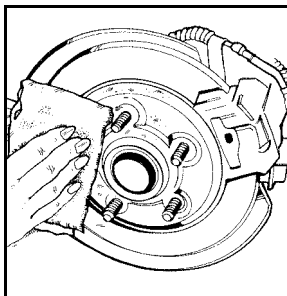

10. Remove any rust or dirt from the wheel bolts, mounting surfaces, and spare wheel.

⚠ WARNING:

Rust or dirt on a wheel, or on the parts to which it is fastened, can make wheel nuts become loose after time. The wheel could come off and cause an accident. When changing a wheel, remove any rust or dirt from places where the wheel attaches to the vehicle. In an emergency, use a cloth or a paper towel to do this; but be sure to use a scraper or wire brush later, if needed, to get all the rust or dirt off. See *Changing a Flat Tire* on page 6-85.

11. Place the spare tire on the wheel-mounting surface.

⚠ WARNING:

Never use oil or grease on bolts or nuts because the nuts might come loose. The vehicle's wheel could fall off, causing a crash.

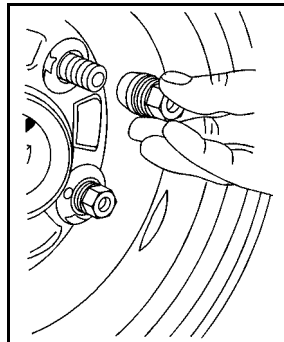

12. Put the wheel nuts back on with the rounded end of the nuts toward the wheel. Tighten each nut by hand until the wheel is held against the hub.

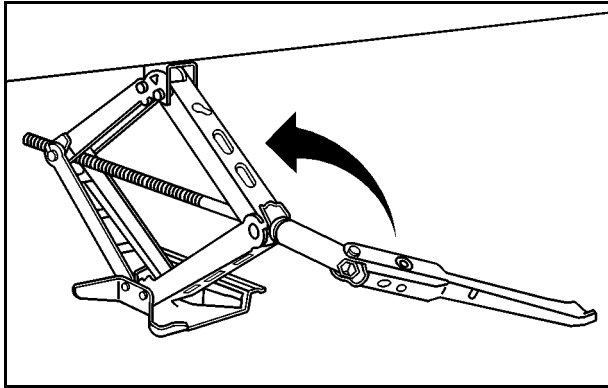

13. Lower the vehicle by turning the jack handle counterclockwise. Lower the jack completely.

⚠ WARNING:

Wheel nuts that are improperly or incorrectly tightened can cause the wheels to become loose or come off. The wheel nuts should be tightened with a torque wrench to the proper torque specification after replacing. Follow the torque specification supplied by the aftermarket manufacturer when using accessory locking wheel nuts. See *Capacities and Specifications on page 6-114* for original equipment wheel nut torque specifications.

Notice: Improperly tightened wheel nuts can lead to brake pulsation and rotor damage. To avoid expensive brake repairs, evenly tighten the wheel nuts in the proper sequence and to the proper torque specification. See *Capacities and Specifications on page 6-114* for the wheel nut torque specification.

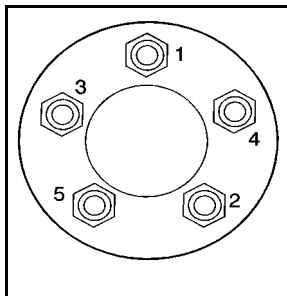

5-Wheel Nuts

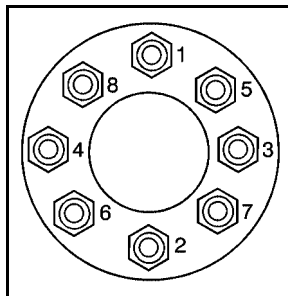

8-Wheel Nuts

14. Tighten the wheel nuts firmly in a crisscross sequence as shown.

If your vehicle is equipped with wheel nut covers, screw the nut covers on with your fingers, then tighten one-quarter turn with the wheel wrench.

Notice: Wheel covers will not fit on your vehicle's compact spare. If you try to put a wheel cover on the compact spare, the cover or the spare could be damaged.

Storing a Flat or Spare Tire and Tools

WARNING:

Storing a jack, a tire, or other equipment in the passenger compartment of the vehicle could cause injury. In a sudden stop or collision, loose equipment could strike someone. Store all these in the proper place.

After you have put the spare tire on your vehicle, store the flat tire in your trunk.

Store the flat tire as far forward in the trunk as possible. Store the jack and wheel wrench in their compartment in the trunk. For storage, the jack must be raised until the screw end is flush with the edge of the jack.

The compact spare is for temporary use only. Replace the compact spare tire with a full-size tire as soon as you can.

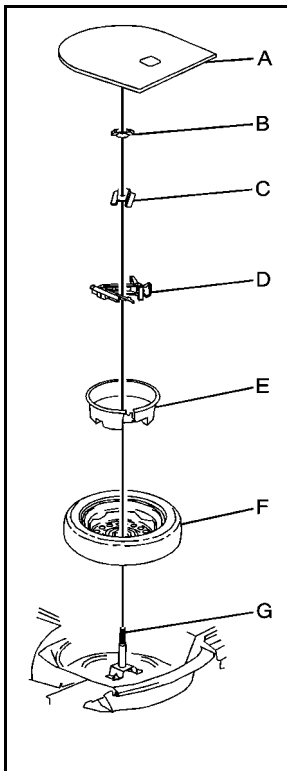

- A. Cover
 - B. Wing Nut
 - C. Retainer
 - D. Jack and Wheel Wrench
 - E. Jack Container
 - F. Spare Tire
 - G. Bolt
1. Open the trunk. See *Trunk* on page 3-12.
 2. Reinstall the spare tire (F), face down, making sure to line up the wheel center hole with the bolt (G) and place it on the compartment floor.
 3. Insert the jack container (E) into the spare tire (F). Then insert the jack and wheel wrench (D) into the center of the spare tire making sure to line up the wheel nut hole with the bolt (G) on the compartment floor.
 4. Secure the spare tire and the jack container with the retainer (C) and then the wing nut (B).
 5. Reinstall the spare tire cover (A).

Spare Tire

Compact Spare Tire

WARNING:

Driving with more than one compact spare tire at a time could result in loss of braking and handling. This could lead to a crash and you or others could be injured. Use only one compact spare tire at a time.

This vehicle may have a compact spare tire. Although the compact spare tire was fully inflated when the vehicle was new, it can lose air after a time. Check the inflation pressure regularly. It should be 60 psi (420 kPa).

After installing the compact spare on the vehicle, stop as soon as possible and make sure the spare tire is correctly inflated. The compact spare is made to perform well at speeds up to 65 mph (105 km/h) for distances up to 3,000 miles (5 000 km), so you can finish your trip and have the full-size tire repaired or replaced at your convenience. Of course, it is best to replace the spare with a full-size tire as soon as possible. The spare tire will last longer and be in good shape in case it is needed again.

Notice: When the compact spare is installed, do not take the vehicle through an automatic car wash with guide rails. The compact spare can get caught on the rails which can damage the tire, wheel and other parts of the vehicle.

Do not use the compact spare on other vehicles.

And do not mix the compact spare tire or wheel with other wheels or tires. They will not fit. Keep the spare tire and its wheel together.

Notice: Tire chains will not fit the compact spare. Using them can damage the vehicle and can damage the chains too. Do not use tire chains on the compact spare.

Spare Tire

This vehicle may have a spare tire, which, when new, was fully inflated. A spare tire may lose air over time, so check its inflation pressure regularly. See *Inflation - Tire Pressure* on page 6-59 and *Loading the Vehicle* on page 5-18 for information regarding proper tire inflation and loading your vehicle. For instructions on how to remove, install or store a spare tire, see *Removing the Flat Tire and Installing the Spare Tire* on page 6-88.

After installing the spare tire on your vehicle, you should stop as soon as possible and make sure the spare is correctly inflated. Have the damaged or flat road tire repaired or replaced as soon as you can and installed back onto your vehicle. This way, a spare tire will be available in case you need it again.

Your vehicle may have a different size spare tire than the road tire originally installed on your vehicle. This spare tire was developed for use on your vehicle, so it is all right to drive on it.

If your vehicle has a spare tire that does not match your vehicle's original road tires and wheels in size and type, do not include the spare in the tire rotation.

Appearance Care

Interior Cleaning

The vehicle's interior will continue to look its best if it is cleaned often. Although not always visible, dust and dirt can accumulate on the upholstery. Dirt can damage carpet, fabric, leather, and plastic surfaces. Regular vacuuming is recommended to remove particles from the upholstery. It is important to keep the upholstery from becoming and remaining heavily soiled. Soils should be removed as quickly as possible. The vehicle's interior may experience extremes of heat that could cause stains to set rapidly.

Lighter colored interiors may require more frequent cleaning. Use care because newspapers and garments that transfer color to home furnishings may also transfer color to the vehicle's interior.

When cleaning the vehicle's interior, only use cleaners specifically designed for the surfaces being cleaned. Permanent damage may result from using cleaners on surfaces for which they were not intended. Use glass cleaner only on glass. Remove any accidental over-spray from other surfaces immediately. To prevent over-spray, apply cleaner directly to the cleaning cloth.

Notice: Using abrasive cleaners when cleaning glass surfaces on the vehicle, could scratch the glass and/or cause damage to the rear window defogger. When cleaning the glass on the vehicle, use only a soft cloth and glass cleaner.

Many cleaners contain solvents that may become concentrated in the vehicle's breathing space. Before using cleaners, read and adhere to all safety instructions on the label. While cleaning the vehicle's interior, maintain adequate ventilation by opening the vehicle's doors and windows.

Dust may be removed from small buttons and knobs using a small brush with soft bristles.

Products that remove odors from the vehicle's upholstery and clean the vehicle's glass can be obtained from your dealer.

Do not clean the vehicle using:

- A knife or any other sharp object to remove a soil from any interior surface.
- A stiff brush. It can cause damage to the vehicle's interior surfaces.
- Heavy pressure or aggressive rubbing with a cleaning cloth. Use of heavy pressure can damage the interior and does not improve the effectiveness of soil removal.

- Laundry detergents or dishwashing soaps with degreasers can leave residue that streaks and attracts dirt. For liquid cleaners, about 20 drops per gallon (3.78 L) of water is a good guide. Use only mild, neutral-pH soaps.
- Too much cleaner that saturates the upholstery.
- Organic solvents such as naphtha, alcohol, etc. that can damage the vehicle's interior.

Fabric/Carpet

Use a vacuum cleaner with a soft brush attachment frequently to remove dust and loose dirt. A canister vacuum with a beater bar in the nozzle may only be used on floor carpet and carpeted floor mats. For any soil, always try to remove it first with plain water or club soda. Before cleaning, gently remove as much of the soil as possible using one of the following techniques:

- For liquids: gently blot the remaining soil with a paper towel. Allow the soil to absorb into the paper towel until no more can be removed.
- For solid dry soils: remove as much as possible and then vacuum.

To clean:

1. Saturate a lint-free, clean white cloth with water or club soda.
2. Wring the cloth to remove excess moisture.

3. Start on the outside edge of the soil and gently rub toward the center. Continue cleaning, using a clean area of the cloth each time it becomes soiled.
4. Continue to gently rub the soiled area until the cleaning cloth remains clean.
5. If the soil is not completely removed, use a mild soap solution and repeat the cleaning process that was used with plain water.

If any of the soil remains, a commercial fabric cleaner or spot lifter may be necessary. When a commercial upholstery cleaner or spot lifter is to be used, test a small hidden area for colorfastness first. If the locally cleaned area gives any impression that a ring formation may result, clean the entire surface.

After the cleaning process has been completed, a paper towel can be used to blot excess moisture from the fabric or carpet.

Leather

A soft cloth dampened with water can be used to remove dust. If a more thorough cleaning is necessary, a soft cloth dampened with a mild soap solution can be used. Allow the leather to dry naturally. Do not use heat to dry. Never use steam to clean leather. Never use spot lifters or spot removers on leather. Many commercial leather cleaners and coatings that are sold to preserve and protect leather may permanently

change the appearance and feel of the leather and are not recommended. Do not use silicone or wax-based products, or those containing organic solvents to clean the vehicle's interior because they can alter the appearance by increasing the gloss in a non-uniform manner. Never use shoe polish on leather.

TEHAMA™ Leather

The leather surface on the seat was not designed to be aggressively cleaned using any commercial product. Use a well wrung cloth dampened with water to remove dust. Do not use a wet cloth or saturate the leather surface with water. Allow the leather to dry naturally. If a soil occurs that cannot be completely removed, allow it to become part of the natural markings of the leather. The leather in the vehicle was designed to have a natural appearance and develop a more vintage appearance with use.

Do not use heat to dry. Never use steam to clean leather. Never use spot lifters or spot removers on leather. It is very important to not use any commercial leather cleaners or coatings that are sold to preserve and protect leather. Not only are those products not necessary, they will permanently and adversely change the appearance and feel of the leather. Never use silicone or wax-based products, or those containing organic solvents to clean the vehicle's interior. Never use shoe polish on leather.

Instrument Panel, Vinyl, and Other Plastic Surfaces

A soft cloth dampened with water may be used to remove dust. If a more thorough cleaning is necessary, a clean soft cloth dampened with a mild soap solution can be used to gently remove dust and dirt. Never use spot lifters or removers on plastic surfaces. Many commercial cleaners and coatings that are sold to preserve and protect soft plastic surfaces may permanently change the appearance and feel of the interior and are not recommended. Do not use silicone or wax-based products, or those containing organic solvents to clean the vehicle's interior because they can alter the appearance by increasing the gloss in a non-uniform manner.

Some commercial products may increase gloss on the instrument panel. The increase in gloss may cause annoying reflections in the windshield and even make it difficult to see through the windshield under certain conditions.

Wood Panels

Use a clean cloth moistened in warm, soapy water (use mild dish washing soap). Dry the wood immediately with a clean cloth.

Speaker Covers

Vacuum around a speaker cover gently, so that the speaker will not be damaged. Clean spots with just water and mild soap.

Care of Safety Belts

Keep belts clean and dry.

WARNING:

Do not bleach or dye safety belts. It may severely weaken them. In a crash, they might not be able to provide adequate protection. Clean safety belts only with mild soap and lukewarm water.

Weatherstrips

Silicone grease on weatherstrips will make them last longer, seal better, and not stick or squeak. Apply silicone grease with a clean cloth. During very cold, damp weather frequent application may be required. See *Recommended Fluids and Lubricants on page 7-9*.

Washing Your Vehicle

The best way to preserve the vehicle's finish is to keep it clean by washing it often.

Notice: Certain cleaners contain chemicals that can damage the emblems or nameplates on the vehicle. Check the cleaning product label. If it states that it should not be used on plastic parts, do not use it on the vehicle or damage may occur and it would not be covered by the warranty.

Do not wash the vehicle in direct sunlight. Use a car washing soap. Do not use cleaning agents that are petroleum based or that contain acid or abrasives, as they can damage the paint, metal or plastic on the vehicle. Approved cleaning products can be obtained from your dealer. Follow all manufacturers' directions regarding correct product usage, necessary safety precautions and appropriate disposal of any vehicle care product.

Rinse the vehicle well, before washing and after to remove all cleaning agents completely. If they are allowed to dry on the surface, they could stain.

Dry the finish with a soft, clean chamois or an all-cotton towel to avoid surface scratches and water spotting.

High pressure car washes may cause water to enter the vehicle. Avoid using high pressure washes closer than 12 inches (30 cm) to the surface of the vehicle. Use of power washers exceeding 1,200 psi (8 274 kPa) can result in damage or removal of paint and decals.

Cleaning Exterior Lamps/Lenses

Use only lukewarm or cold water, a soft cloth and a car washing soap to clean exterior lamps and lenses. Follow instructions under *Washing Your Vehicle* on page 6-100.

Finish Care

Occasional waxing or mild polishing of the vehicle by hand may be necessary to remove residue from the paint finish. Approved cleaning products can be obtained from your dealer.

If the vehicle has a basecoat/clearcoat paint finish, the clearcoat gives more depth and gloss to the colored basecoat. Always use waxes and polishes that are non-abrasive and made for a basecoat/clearcoat paint finish.

Notice: Machine compounding or aggressive polishing on a basecoat/clearcoat paint finish may damage it. Use only non-abrasive waxes and polishes that are made for a basecoat/clearcoat paint finish on the vehicle.

Foreign materials such as calcium chloride and other salts, ice melting agents, road oil and tar, tree sap, bird droppings, chemicals from industrial chimneys, etc., can damage the vehicle's finish if they remain on painted surfaces. Wash the vehicle as soon as possible. If necessary, use non-abrasive cleaners that are marked safe for painted surfaces to remove foreign matter.

Exterior painted surfaces are subject to aging, weather and chemical fallout that can take their toll over a period of years. To help keep the paint finish looking new, keep the vehicle garaged or covered whenever possible.

Protecting Exterior Bright Metal Parts

Bright metal parts should be cleaned regularly to keep their luster. Washing with water is all that is usually needed. However, chrome polish may be used on chrome or stainless steel trim, if necessary.

Use special care with aluminum trim. To avoid damaging protective trim, never use auto or chrome polish, steam or caustic soap to clean aluminum. A coating of wax, rubbed to high polish, is recommended for all bright metal parts.

Windshield and Wiper Blades

Clean the outside of the windshield with glass cleaner.

Clean the rubber blades using a lint free cloth or paper towel soaked with windshield washer fluid or a mild detergent. Wash the windshield thoroughly when cleaning the blades. Bugs, road grime, sap, and a buildup of vehicle wash/wax treatments may cause wiper streaking. Replace the wiper blades if they are worn or damaged.

Wipers can be damaged by:

- Extreme dusty conditions
- Sand and salt
- Heat and sun
- Snow and ice, without proper removal

Aluminum or Chrome-Plated Wheels and Trim

The vehicle may have either aluminum or chrome-plated wheels.

Keep the wheels clean using a soft clean cloth with mild soap and water. Rinse with clean water. After rinsing thoroughly, dry with a soft clean towel. A wax may then be applied.

Notice: Chrome wheels and other chrome trim may be damaged if the vehicle is not washed after driving on roads that have been sprayed with magnesium, calcium or sodium chloride. These chlorides are used on roads for conditions such as ice and dust. Always wash the vehicle's chrome with soap and water after exposure.

Notice: Using strong soaps, chemicals, abrasive polishes, cleaners, brushes, or cleaners that contain acid on aluminum or chrome-plated wheels, could damage the surface of the wheel(s). The repairs would not be covered by the vehicle warranty. Use only approved cleaners on aluminum or chrome-plated wheels.

The surface of these wheels is similar to the painted surface of the vehicle. Do not use strong soaps, chemicals, abrasive polishes, abrasive cleaners,

cleaners with acid, or abrasive cleaning brushes on them because they could damage the surface. Do not use chrome polish on aluminum wheels.

Notice: Using chrome polish on aluminum wheels could damage the wheels. The repairs would not be covered by the vehicle warranty. Use chrome polish on chrome wheels only.

Use chrome polish only on chrome-plated wheels, but avoid any painted surface of the wheel, and buff off immediately after application.

Notice: Driving the vehicle through an automatic car wash that has silicone carbide tire cleaning brushes, could damage the aluminum or chrome-plated wheels. The repairs would not be covered by the vehicle warranty. Never drive a vehicle that has aluminum or chrome-plated wheels through an automatic car wash that uses silicone carbide tire cleaning brushes.

Tires

To clean the tires, use a stiff brush with tire cleaner.

Notice: Using petroleum-based tire dressing products on the vehicle may damage the paint finish and/or tires. When applying a tire dressing, always wipe off any overspray from all painted surfaces on the vehicle.

Sheet Metal Damage

If the vehicle is damaged and requires sheet metal repair or replacement, make sure the body repair shop applies anti-corrosion material to parts repaired or replaced to restore corrosion protection.

Original manufacturer replacement parts will provide the corrosion protection while maintaining the vehicle warranty.

Finish Damage

Any stone chips, fractures or deep scratches in the finish should be repaired right away. Bare metal will corrode quickly and may develop into major repair expense.

Minor chips and scratches can be repaired with touch-up materials available from your dealer. Larger areas of finish damage can be corrected in your dealer's/retailer's body and paint shop.

Underbody Maintenance

Chemicals used for ice and snow removal and dust control can collect on the underbody. If these are not removed, corrosion and rust can develop on the underbody parts such as fuel lines, frame, floor pan, and exhaust system even though they have corrosion protection.

At least every spring, flush these materials from the underbody with plain water. Clean any areas where mud and debris can collect. Dirt packed in close areas of the frame should be loosened before being flushed. Your dealer or an underbody car washing system can do this.

Chemical Paint Spotting

Some weather and atmospheric conditions can create a chemical fallout. Airborne pollutants can fall upon and attack painted surfaces on the vehicle. This damage can take two forms: blotchy, ring-shaped discolorations, and small, irregular dark spots etched into the paint surface.

Although no defect in the paint job causes this, we will repair, at no charge to the owner, the surfaces of new vehicles damaged by this fallout condition within 12 months or 12,000 miles (20 000 km) of purchase, whichever occurs first.

Vehicle Identification

Vehicle Identification Number (VIN)



This legal identifier is in the front corner of the instrument panel, on the driver side. It can be seen through the windshield from outside. The VIN also appears on the Vehicle Certification and Service Parts labels and certificates of title and registration.

Engine Identification

The eighth character in the VIN is the engine code. This code identifies the vehicle's engine, specifications, and replacement parts. See "Engine Specifications" under *Capacities and Specifications on page 6-114* for the vehicle's engine code.

Service Parts Identification Label

This label, on the spare tire cover, has the following information:

- Vehicle Identification Number (VIN)
- Model designation
- Paint information
- Production options and special equipment

Do not remove this label from the vehicle.

Electrical System

Add-On Electrical Equipment

Notice: Do not add anything electrical to the vehicle unless you check with your dealer first. Some electrical equipment can damage the vehicle and the damage would not be covered by the vehicle's warranty. Some add-on electrical equipment can keep other components from working as they should.

Add-on equipment can drain the vehicle battery, even if the vehicle is not operating.

The vehicle has an airbag system. Before attempting to add anything electrical to the vehicle, see *Servicing Your Airbag-Equipped Vehicle on page 2-73* and *Adding Equipment to Your Airbag-Equipped Vehicle on page 2-74*.

Headlamp Wiring

The headlamp wiring system has four individual fuses. An electrical overload will cause the lamps to go on and off, or in some cases to remain off. If this happens, have the headlamp wiring checked right away.

Windshield Wiper Fuses

The windshield wiper motor is protected by an internal circuit breaker. If the wiper motor overheats due to heavy snow, the wipers will stop until the motor cools and will then restart.

A fuse powers the wiper motor. If the fuse blows, there is an electrical problem. Be sure to have it fixed.

Power Windows and Other Power Options

Circuit breakers in the fuse block protect the power windows and other power accessories. When the current load is too heavy, the circuit breaker opens and closes, protecting the circuit until the problem is fixed or goes away.

Fuses and Circuit Breakers

The wiring circuits in the vehicle are protected from short circuits by a combination of fuses and circuit breakers. This greatly reduces the chance of fires caused by electrical problems.

Look at the silver-colored band inside the fuse. If the band is broken or melted, replace the fuse. Be sure you replace a bad fuse with a new one of the identical size and rating.

If you ever have a problem on the road and don't have a spare fuse, you can borrow one that has the same amperage. Just pick some feature of the vehicle that you can get along without — like the radio or cigarette lighter — and use its fuse, if it is the correct amperage. Replace it as soon as you can.

Underhood Fuse Block

The underhood fuse block is located on the passenger side of the engine compartment. Remove the fuse cover and secondary service cover to access the fuse block.

Notice: Spilling liquid on any electrical components on the vehicle may damage it. Always keep the covers on any electrical component.

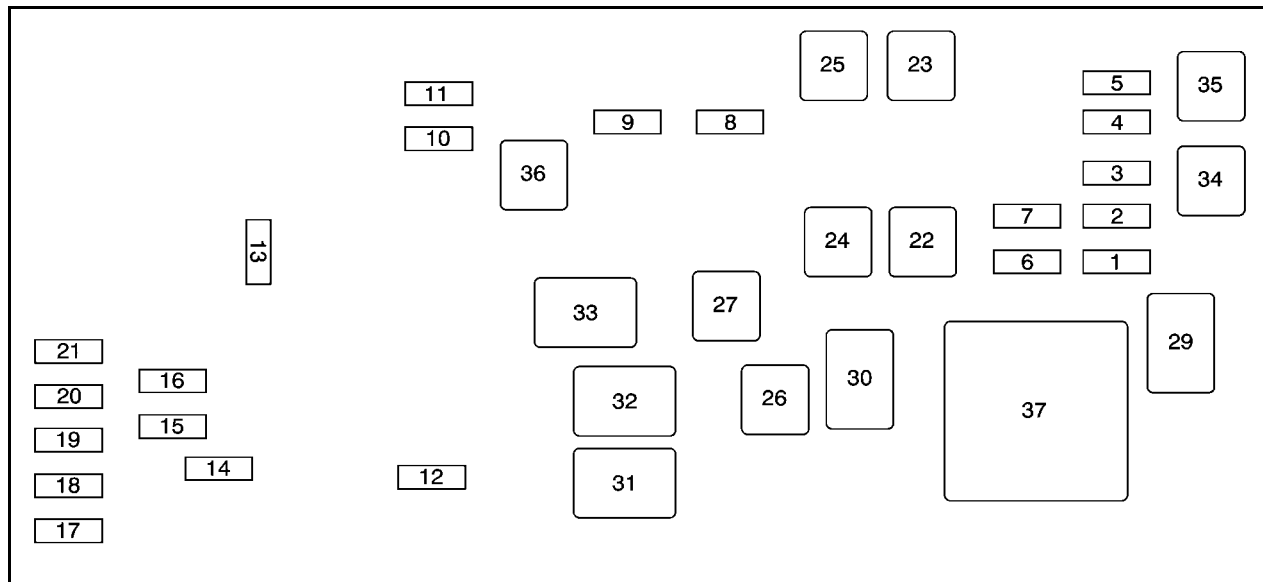

Fuses	Usage
1	Engine Control Module (ECM), Crank
2	Fuel Injectors Odd
3	Fuel Injectors Even
4	Air Conditioning Clutch

Fuses	Usage
5	Air Injection Reactor (AIR) Solenoid
6	Oxygen Sensor
7	Emission Device
8	Transmission, Ignition 1

Fuses	Usage
9	Engine Control Module (ECM), Powertrain Control Module (PCM)
10	Climate Control System, Instrument Panel Cluster Ignition 1
11	Airbag System
12	Horn
13	Windshield Wiper
14	Fog Lamps
15	Right High-Beam Headlamp
16	Left High-Beam Headlamp
17	Left Low-Beam Headlamp
18	Right Low-Beam Headlamp
19	Windshield Washer Pump Motor
20	Left Front Cornering Lamp
21	Right Front Cornering Lamp
22	Air Pump (J-Case)
23	Antilock Brake System (ABS) (J-Case)

Fuses	Usage
24	Starter (J-Case)
25	Antilock Brake System (ABS) Motor (J-Case)
26	Cooling Fan 2 (J-Case)
27	Cooling Fan 1 (J-Case)

Relays	Usage
29	Powertrain
30	Starter
31	Cooling Fan 2
32	Cooling Fan 3
33	Cooling Fan 1
34	Air Conditioning Clutch
35	Air Injection Reactor (AIR) Solenoid
36	Ignition
37	Air Pump

Rear Underseat Fuse Block

The rear fuse block is located under the rear seat on the driver side. The rear seat cushion must be removed to access the rear fuse block.

Removing the Rear Seat Cushion

Notice: If you touch the exposed wires with the metal on the seat cushion, you could cause a short that could damage the battery and or wires. Avoid contact between the rear seat and the fuse center whenever you remove or reinstall the rear seat. Do not remove covers from any of the covered parts, and do not store anything under the seats.

To remove the rear seat cushion, do the following:

1. Pull up on the front of the cushion to release the front hooks.
2. Pull the cushion up and out toward the front of the vehicle.

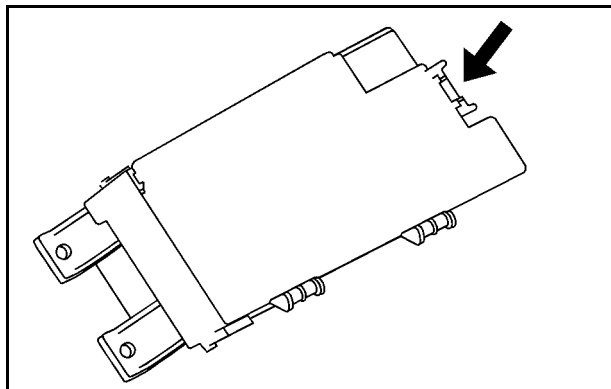

To access the fuse block, pull out and lift up on the cover latch, located at the end of the fuse block, near the battery cable.

To reinstall the rear seat cushion, do the following:

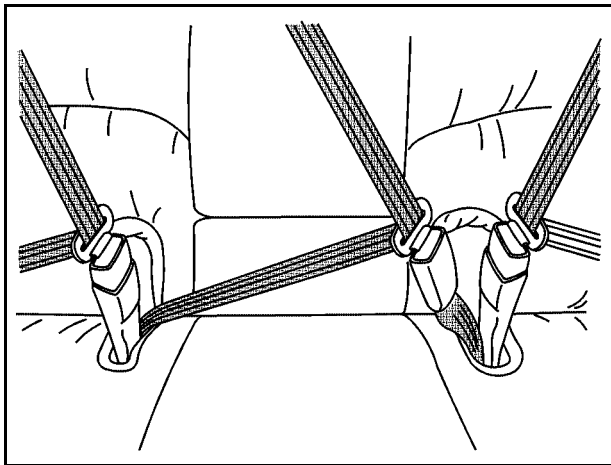

⚠ WARNING:

A safety belt that is not properly routed through the seat cushion or is twisted will not provide the protection needed in a crash. If the safety belt has not been routed through the seat cushion at all, it

(Continued)

WARNING: (Continued)

will not be there to work for the next passenger. The person sitting in that position could be badly injured. After reinstalling the seat cushion, always check to be sure that the safety belts are properly routed and are not twisted.

1. Buckle the center passenger position safety belt, then route the safety belts through the proper slots in the seat cushion. Do not let the safety belts get twisted.
2. Slide the rear of the cushion up and under the seatback so the rear-locating guides hook into the wire loops on the back frame.
3. With the seat cushion lowered, push rearward and then press down on the seat cushion until the spring locks on both ends engage.
4. Check to make sure the safety belts are properly routed and that no portion of any safety belt is trapped under the seat. Also make sure the seat cushion is secured.

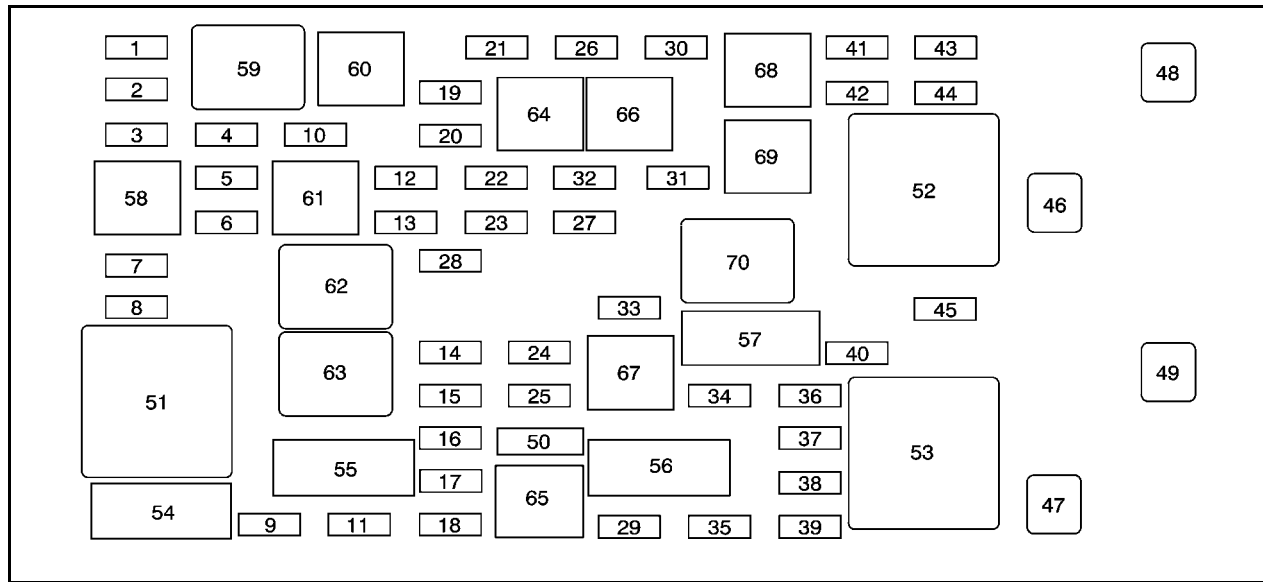

Fuses	Usage
1	Fuel Pump
2	Left Park Lamp
3	Run 3 - Rear Blower
4	Right Park Lamp

Fuses	Usage
5	Engine Control Module (ECM)/ Transmission Control Module (TCM)
6	Memory Module
7	Right Park Lamp (optional)

Fuses	Usage
8	Steering Wheel Illumination
9	Front Heated/Cooled Seat Module
10	Run 2 - Heated/Cooled Seats
11	Rear Heated Seat Module
12	RPA Module
13	PASS-Key® III System
14	Unlock/Lock Module
15	Magnetic Ride Control
16	Not Used
17	Sunroof
18	Body Control Module (BCM) Dim
19	Body Control Module (BCM)
20	Run 1-Heated Steering Wheel
21	Ignition Switch
22	Driver Door Module
23	Rear Lumbar
24	Electronic Leveling Control Module
25	Body Control Module (Left Turn Signal)
26	Cigarette Lighter, Auxiliary Power Outlet
27	Navigation (Optional)

Fuses	Usage
28	Retained Accessory Power 1 (RAP)
29	Passenger Door Module
30	Sensing and Diagnostic Module
31	Accessory Power Outlets
32	Body Control Module (BCM) (Inadvertent)
33	Retained Accessory Power 2 (RAP)
34	Canister Vent Solenoid
35	Body Control Module (Courtesy)
36	Body Control Module (Right Turn Signal)
37	Trunk Release
38	Amplifier, Radio
39	Body Control Module (CHMSL)
40	Body Control Module
41	Stoplamp (optional)
42	OnStar® Module
43	Body Modules
44	Radio
45	Door Unlatch (optional)
46	Rear Defogger (J-Case)

Fuses	Usage
47	Electronic Leveling Control Compressor (J-Case)
48	Blower (J-Case) (optional)
49	Blower (J-Case) (optional)

Resistor	Usage
50	Terminating Resistor

Relays	Usage
51	Front Blower (optional)
52	Rear Defogger
53	Electronic Leveling Control Compressor
58	Park Lamps
59	Fuel Pump
60	License Plate Lamp (optional)
61	Right Park Lamp (optional)

Relays	Usage
62	Unlock
63	Lock
64	Run
65	Not Used
66	Door Unlatch (optional)
67	Trunk Release
68	Stoplamp (optional)
69	Overhead Lamps (optional)
70	Retained Accessory Power (RAP)

Circuit Breakers	Usage
54	Right Front Seat
55	Left Front Power Seat
56	Power Windows
57	Power Tilt Steering Wheel

Capacities and Specifications

The following approximate capacities are given in English and metric conversions. See *Recommended Fluids and Lubricants on page 7-9* for more information.

Application	Capacities	
	English	Metric
Air Conditioning Refrigerant	For the air conditioning system refrigerant charge amount, see the refrigerant caution label located under the hood. See your dealer for more information.	
Cooling System	12.6 qt	12.0 L
Engine Oil with Filter	7.5 qt	7.1 L
Fuel Tank	18.5 gal	70.0 L
Transmission Fluid (Bottom Pan Removal)	7.4 qt	7.0 L
Wheel Nut Torque	100 lb ft	140 N•m
All capacities are approximate. When adding, be sure to fill to the approximate level as recommended in this manual. Recheck fluid level after filling.		

Engine Specifications

Engine	VIN Code	Transmission	Spark Plug Gap
4.6L DOHC V8 Engine	Y	Automatic	0.050 in (1.27 mm)
4.6L DOHC V8 Engine	9	Automatic	0.050 in (1.27 mm)

Section 7 Maintenance Schedule

Maintenance Schedule	7-2	Recommended Fluids and Lubricants	7-9
Introduction	7-2	Maintenance Replacement Parts	7-11
Scheduled Maintenance	7-3	Engine Drive Belt Routing	7-12
Owner Checks and Services	7-7	Maintenance Record	7-13

Maintenance Schedule

Introduction

Notice: Maintenance intervals, checks, inspections, recommended fluids, and lubricants are necessary to keep this vehicle in good working condition.

Damage caused by failure to follow scheduled maintenance might not be covered by the vehicle warranty.

As the vehicle owner, you are responsible for the scheduled maintenance in this section. We recommend having your dealer/retailer perform these services. Proper vehicle maintenance helps to keep the vehicle in good working condition, improves fuel economy, and reduces vehicle emissions for better air quality.

Because of all the different ways people use vehicles, maintenance needs vary. The vehicle might need more frequent checks and services. Please read the information under Scheduled Maintenance. To keep the vehicle in good condition, see your dealer/retailer.

The maintenance schedule is for vehicles that:

- carry passengers and cargo within recommended limits on the Tire and Loading Information label. See *Loading the Vehicle* on page 5-18.
- are driven on reasonable road surfaces within legal driving limits.
- use the recommended fuel. See *Gasoline Octane* on page 6-5.

WARNING:

Performing maintenance work on a vehicle can be dangerous. In trying to do some jobs, you can be seriously injured. Do your own maintenance work only if you have the required know-how and the proper tools and equipment for the job. If you have any doubt, see your dealer to have a qualified technician do the work. See *Doing Your Own Service Work* on page 6-4.

At your dealer/retailer, you can be certain that you will receive the highest level of service available. Your dealer/retailer has specially trained service technicians, uses genuine replacement parts, as well as, up to date tools and equipment to ensure fast and accurate diagnostics.

The proper replacement parts, fluids, and lubricants to use are listed in *Recommended Fluids and Lubricants on page 7-9* and *Maintenance Replacement Parts on page 7-11*. We recommend the use of genuine parts from your dealer/retailer.

Rotation of New Tires

To maintain ride, handling, and performance of the vehicle, it is important that the first rotation service for new tires be performed when they have 8 000 to 13 000 km (5,000 to 8,000 miles). See *Tire Inspection and Rotation on page 6-67*.

Scheduled Maintenance

When the Change Engine Oil Soon Message Displays

Change engine oil and filter. See *Engine Oil on page 6-15. An Emission Control Service*.

When the Change Engine Oil Soon message displays, service is required for the vehicle as soon as possible, within the next 1 000 km/600 miles. If driving under the best conditions, the engine oil life system might not indicate the need for vehicle service for more than a year. The engine oil and filter must be changed at least once a year and the oil life system must be reset. Your dealer has trained service technicians who will perform this work and reset the system. If the engine oil life system is reset accidentally, service the vehicle within 5 000 km/3,000 miles since the last service. Reset the oil life system whenever the oil is changed. See *Engine Oil Life System on page 6-18*.

When the Change Engine Oil Soon message displays, certain services, checks, and inspections are required.

Every Engine Oil Change

- Change engine oil and filter. See *Engine Oil on page 6-15. An Emission Control Service.*
- Engine coolant level check. See *Engine Coolant on page 6-26.*
- Windshield washer fluid level check. See *Windshield Washer Fluid on page 6-33.*
- Tire inflation check. See *Inflation - Tire Pressure on page 6-59.*
- Tire wear inspection. See *Tire Inspection and Rotation on page 6-67.*
- Rotate tires. See *Tire Inspection and Rotation on page 6-67.*
- Fluids visual leak check (or every 12 months, whichever occurs first). A leak in any system must be repaired and the fluid level checked.
- Engine air cleaner filter inspection. See *Engine Air Cleaner/Filter on page 6-19.*
- Brake system inspection (or every 12 months, whichever occurs first).
- Steering and suspension inspection. Visual inspection for damaged, loose, or missing parts or signs of wear.
- Engine cooling system inspection. Visual inspection of hoses, pipes, fittings, and clamps and replacement, if needed.
- Windshield wiper blade inspection for wear, cracking, or contamination and windshield and wiper blade cleaning, if contaminated. See *Windshield and Wiper Blades on page 6-101.* Worn or damaged wiper blade replacement. See *Windshield Wiper Blade Replacement on page 6-48.*
- Body hinges and latches, key lock cylinders, console hinges, and glove box door hinges lubrication. See *Recommended Fluids and Lubricants on page 7-9.* More frequent lubrication may be required when vehicle is exposed to a corrosive environment. Applying silicone grease on weatherstrips with a clean cloth makes them last longer, seal better, and not stick or squeak.
- Restraint system component check. See *Checking the Restraint Systems on page 2-75.*
- Automatic transmission fluid level check and adding fluid, if needed. See *Automatic Transmission Fluid on page 6-21.*

Additional Required Services

At Each Fuel Stop

- Engine oil level check. See *Engine Oil* on page 6-15.
- Engine coolant level check. See *Engine Coolant* on page 6-26.
- Windshield washer fluid level check. See *Windshield Washer Fluid* on page 6-33.

Once a Month

- Tire inflation check. See *Inflation - Tire Pressure* on page 6-59.
- Tire wear inspection. See *Tire Inspection and Rotation* on page 6-67.

Once a Year

- Starter switch check. See *Owner Checks and Services* on page 7-7.
- Parking brake and automatic transmission P (Park) mechanism check. See *Owner Checks and Services* on page 7-7.
- Automatic transmission shiftlock control system check. See *Owner Checks and Services* on page 7-7.
- Ignition transmission lock check. See *Owner Checks and Services* on page 7-7.

- Engine cooling system and pressure cap pressure check. Radiator and air conditioning condenser outside cleaning. See *Cooling System* on page 6-24.
- Exhaust system and nearby heat shields inspection for loose or damaged components.
- Accelerator pedal check for damage, high effort, or binding. Replace if needed.

First Engine Oil Change After Every 40 000 km/25,000 Miles

- Fuel system inspection for damage or leaks.
- Passenger compartment air filter replacement (or every 12 months, whichever occurs first). More frequent replacement may be required if vehicle is driven regularly under dusty conditions.

First Engine Oil Change After Every 80 000 km/50,000 Miles

- Engine air cleaner filter replacement. See *Engine Air Cleaner/Filter* on page 6-19.
- Automatic transmission fluid and filter change (severe service) for vehicles mainly driven in heavy city traffic in hot weather, in hilly or mountainous terrain, when frequently towing a trailer, or used for taxi, police, or delivery service. See *Automatic Transmission Fluid* on page 6-21.

First Engine Oil Change After Every 120 000 km/75,000 Miles

- Professional Vehicle Only: Engine cooling system drain, flush, and refill, cooling system and cap pressure check, and cleaning of outside of radiator and air conditioning condenser (or every 5 years, whichever occurs first). See *Engine Coolant on page 6-26. An Emission Control Service.*

First Engine Oil Change After Every 160 000 km/100,000 Miles

- Automatic transmission fluid and filter change (normal service). See *Automatic Transmission Fluid on page 6-21.*
- Spark plug replacement. *An Emission Control Service.*

First Engine Oil Change After Every 240 000 km/150,000 Miles

- Except Professional Vehicle: Engine cooling system drain, flush, and refill, cooling system and cap pressure check, and cleaning of outside of radiator and air conditioning condenser (or every 5 years, whichever occurs first). See *Engine Coolant on page 6-26. An Emission Control Service.*
- Engine accessory drive belt inspection for fraying, excessive cracks, or obvious damage and replacement, if needed. *An Emission Control Service.*

Owner Checks and Services

Starter Switch Check

WARNING:

When you are doing this inspection, the vehicle could move suddenly. If the vehicle moves, you or others could be injured.

1. Before starting this check, be sure there is enough room around the vehicle.
2. Firmly apply both the parking brake and the regular brake. See *Parking Brake on page 3-30*.
Do not use the accelerator pedal, and be ready to turn off the engine immediately if it starts.
3. Try to start the engine in each gear. The vehicle should start only in P (Park) or N (Neutral). If the vehicle starts in any other position, contact your dealer for service.

Automatic Transmission Shift Lock Control System Check

WARNING:

When you are doing this inspection, the vehicle could move suddenly. If the vehicle moves, you or others could be injured.

1. Before starting this check, be sure there is enough room around the vehicle. It should be parked on a level surface.
2. Firmly apply the parking brake. See *Parking Brake on page 3-30*.
Be ready to apply the regular brake immediately if the vehicle begins to move.
3. With the engine off, turn the ignition to ON/RUN, but do not start the engine. Without applying the regular brake, try to move the shift lever out of P (Park) with normal effort. If the shift lever moves out of P (Park), contact your dealer for service.

Ignition Transmission Lock Check

While parked, and with the parking brake set, try to turn the ignition to LOCK/OFF in each shift lever position.

- The ignition should turn to LOCK/OFF only when the shift lever is in P (Park).
- The ignition key should come out only in LOCK/OFF.

Contact your dealer if service is required.

Parking Brake and Automatic Transmission P (Park) Mechanism Check

WARNING:

When you are doing this check, the vehicle could begin to move. You or others could be injured and property could be damaged. Make sure there is room in front of the vehicle in case it begins to roll. Be ready to apply the regular brake at once should the vehicle begin to move.

Park on a fairly steep hill, with the vehicle facing downhill. Keeping your foot on the regular brake, set the parking brake.

- To check the parking brake's holding ability: With the engine running and the transmission in N (Neutral), slowly remove foot pressure from the regular brake pedal. Do this until the vehicle is held by the parking brake only.
- To check the P (Park) mechanism's holding ability: With the engine running, shift to P (Park). Then release the parking brake followed by the regular brake.

Contact your dealer if service is required.

Recommended Fluids and Lubricants

Fluids and lubricants identified below by name, part number, or specification can be obtained from your dealer.

Usage	Fluid/Lubricant
Engine Oil	The engine requires a special engine oil meeting GM Standard GM4718M. Oils meeting this standard can be identified as synthetic, and should also be identified with the American Petroleum Institute (API) Certified for Gasoline Engines starburst symbol. However, not all synthetic API oils with the starburst symbol will meet this GM standard. Look for and use only oil that meets GM Standard GM4718M. For the proper viscosity, see <i>Engine Oil on page 6-15</i> .

Usage	Fluid/Lubricant
Engine Coolant	50/50 mixture of clean, drinkable water and use only DEX-COOL [®] Coolant. See <i>Engine Coolant on page 6-26</i> .
Hydraulic Brake System	DOT 3 Hydraulic Brake Fluid (GM Part No. U.S. 88862806, in Canada 88862807).
Windshield Washer	Optikleen [®] Washer Solvent.
Parking Brake Cable Guides	Chassis Lubricant (GM Part No. U.S. 12377985, in Canada 88901242) or lubricant meeting requirements of NLGI #2, Category LB or GC-LB.

Usage	Fluid/Lubricant
Power Steering System	GM Power Steering Fluid (GM Part No. U.S. 89021184, in Canada 89021186).
Automatic Transmission	DEXRON®-VI Automatic Transmission Fluid.
Key Lock Cylinders	Multi-Purpose Lubricant, Superlube (GM Part No. U.S. 12346241, in Canada 10953474).
Hood Latch Assembly, Secondary Latch, Pivots, Spring Anchor, and Release Pawl	Lubriplate Lubricant Aerosol (GM Part No. U.S. 12346293, in Canada 992723) or lubricant meeting requirements of NLGI #2, Category LB or GC-LB.

Usage	Fluid/Lubricant
Hood and Door Hinges	Multi-Purpose Lubricant, Superlube (GM Part No. U.S. 12346241, in Canada 10953474).
Weatherstrip Conditioning	Weatherstrip Lubricant (GM Part No. U.S. 3634770, in Canada 10953518) or Dielectric Silicone Grease (GM Part No. U.S. 12345579, in Canada 992887).

Maintenance Replacement Parts

Replacement parts identified below by name, part number, or specification can be obtained from your dealer.

Part	GM Part Number	ACDelco Part Number
Engine Air Cleaner/Filter Element	22676970	A1627C
Engine Oil Filter	89017342	PF61
Passenger Compartment Air Filter Element	25906375	CF118C
Spark Plugs	12571535	41-987
Wiper Blades		
Driver Side - 21.7 in (55.0 cm)	15931977	—
Passenger Side - 21.7 in (55.0 cm)	15931976	—

Engine Drive Belt Routing

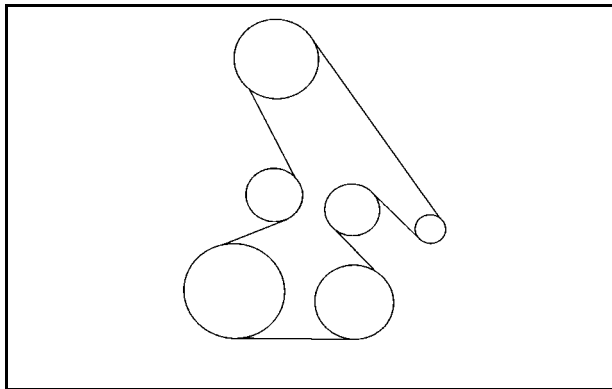

4.6L V8 Engines

Maintenance Record

After the scheduled services are performed, record the date, odometer reading, who performed the service, and the type of services performed in the boxes provided. Retain all maintenance receipts.

Maintenance Record

Date	Odometer Reading	Serviced By	Maintenance Stamp	Services Performed

Maintenance Record (cont'd)

Date	Odometer Reading	Serviced By	Maintenance Stamp	Services Performed

Maintenance Record (cont'd)

Date	Odometer Reading	Serviced By	Maintenance Stamp	Services Performed

Maintenance Record (cont'd)

Date	Odometer Reading	Serviced By	Maintenance Stamp	Services Performed

Section 8 Customer Assistance Information

Customer Assistance and Information	8-2	Reporting Safety Defects	8-16
Customer Satisfaction Procedure	8-2	Reporting Safety Defects	
Online Owner Center	8-5	to the United States Government	8-16
Customer Assistance		Reporting Safety Defects	
for Text Telephone (TTY) Users	8-6	to the Canadian Government	8-16
Customer Assistance Offices	8-6	Reporting Safety Defects	
GM Mobility Reimbursement Program	8-7	to General Motors	8-16
Roadside Service	8-7	Service Publications Ordering Information	8-17
Scheduling Service Appointments	8-11	Vehicle Data Recording and Privacy	8-18
Courtesy Transportation Program	8-11	Event Data Recorders	8-19
Collision Damage Repair	8-13	OnStar®	8-20
		Navigation System	8-20
		Radio Frequency Identification (RFID)	8-20
		Radio Frequency Statement	8-20

Customer Assistance and Information

Customer Satisfaction Procedure

Your satisfaction and goodwill are important to your dealer and to Cadillac. Normally, any concerns with the sales transaction or the operation of the vehicle will be resolved by the dealer's sales or service departments. Sometimes, however, despite the best intentions of all concerned, misunderstandings can occur. If your concern has not been resolved to your satisfaction, the following steps should be taken:

STEP ONE: Discuss your concern with a member of dealership management. Normally, concerns can be quickly resolved at that level. If the matter has already been reviewed with the sales, service or parts manager, contact the owner of the dealership or the general manager.

STEP TWO : If after contacting a member of dealership management, it appears your concern cannot be resolved by the dealership without further help, in the United States, call the Cadillac Customer Assistance Center, 24 hours a day, at 1-800-458-8006. In Canada, call the Canadian Cadillac Customer Communication Centre at 1-888-446-2000.

We encourage you to call the toll-free number in order to give your inquiry prompt attention. Have the following information available to give the Customer Assistance Representative:

- Vehicle Identification Number (VIN). This is available from the vehicle registration or title, or the plate at the top left of the instrument panel and visible through the windshield.
- Dealership name and location.
- Vehicle delivery date and present mileage.

When contacting Cadillac, remember that your concern will likely be resolved at a dealer's facility. That is why we suggest following Step One first.

STEP THREE (U.S. Owners): Both General Motors and your dealer are committed to making sure you are completely satisfied with your new vehicle. However, if you continue to remain unsatisfied after following the procedure outlined in Steps One and Two, you can file with the Better Business Bureau (BBB) Auto Line Program to enforce your rights.

The BBB Auto Line Program is an out of court program administered by the Council of Better Business Bureaus to settle automotive disputes regarding vehicle repairs or the interpretation of the New Vehicle Limited Warranty. Although you may be required to resort to this informal dispute resolution program prior to filing a court action, use of the program is free of charge and your case will generally be heard within 40 days. If you do not agree with the decision given in your case, you may reject it and proceed with any other venue for relief available to you.

You may contact the BBB Auto Line Program using the toll-free telephone number or write them at the following address:

BBB Auto Line Program
Council of Better Business Bureaus, Inc.
4200 Wilson Boulevard
Suite 800
Arlington, VA 22203-1838
Telephone: 1-800-955-5100
dr.bbb.org/goauto

This program is available in all 50 states and the District of Columbia. Eligibility is limited by vehicle age, mileage and other factors. General Motors reserves the right to change eligibility limitations and/or discontinue its participation in this program.

STEP THREE (Canadian Owners):

General Motors Participation in the Mediation/ Arbitration Program

In the event that you do not feel your concerns have been addressed after the following the procedure outlined in Steps One and Two. General Motors of Canada Limited wants you to be aware of its participation in a no-charge mediation/Arbitration program. General Motors of Canada Limited has committed to binding arbitration of owner disputes involving factory-related vehicle service claims. The program provides for the review of the facts involved by an impartial third party arbiter, and may include an informal hearing before the arbiter. The program is designed so that the entire dispute settlement process, from the time you file your complaint to the final decision, should be completed in approximately 70 days. We believe our impartial program offers advantages over courts in most jurisdictions because it is informal, quick, and free of charge.

For further information concerning eligibility in the Canadian Motor Vehicle Arbitration Plan (CAMVAP), call toll-free 1-800-207-0685, or call the General Motors Customer Communication Centre, 1-800-263-3777 (English), 1-800-263-7854 (French), or write to the Mediation/Arbitration Program at the following address:

Mediation/Arbitration Program
c/o Customer Communication Centre
General Motors of Canada Limited
Mail Code: CA1-163-005
1908 Colonel Sam Drive
Oshawa, Ontario L1H 8P7

Your inquiry should be accompanied by the Vehicle Identification Number (VIN).

Online Owner Center

Online Owner Center (U.S.) — www.gmownercenter.com/cadillac

Information and services customized for your specific vehicle — all in one convenient place.

- Digital owner manual, warranty information, and more
- Online service and maintenance records
- Find Cadillac dealers for service nationwide
- Exclusive privileges and offers
- Recall notices for your specific vehicle
- OnStar® and GM Cardmember Services Earnings summaries

Other Helpful Links:

Cadillac — www.cadillac.com

Cadillac Merchandise — www.cadillaccollection.com

Help Center — www.cadillac.com/helpcenter

- FAQ
- Contact Us

My GM Canada (Canada) — www.gm.ca

My GM Canada is a password-protected section of www.gm.ca where you can save information on GM vehicles, get personalized offers, and use handy tools and forms with greater ease.

Here are a few of the valuable tools and services you will have access to:

- **My Showroom:** Find and save information on vehicles and current offers in your area.
- **My Dealers/Retailers:** Save details such as address and phone number for each of your preferred GM dealers/retailers.
- **My Driveway:** Access quick links to parts and service estimates, check trade-in values, or schedule a service appointment by adding the vehicles you own to your driveway profile.
- **My Preferences:** Manage your profile and use tools and forms with greater ease.

To sign up, visit the My GM Canada section within www.gm.ca.

Customer Assistance for Text Telephone (TTY) Users

To assist customers who are deaf, hard of hearing, or speech-impaired and who use Text Telephones (TTYs), Cadillac has TTY equipment available at its Customer Assistance Center. Any TTY user can communicate with Cadillac by dialing: 1-800-833-CMCC (2622). (TTY users in Canada can dial 1-800-263-3830.)

Customer Assistance Offices

Cadillac encourages customers to call the toll-free number for assistance. However, if a customer wishes to write or e-mail Cadillac, the letter should be addressed to:

United States — Customer Assistance

Cadillac Customer Assistance Center
Cadillac Motor Car Division
P.O. Box 33169
Detroit, MI 48232-5169
www.Cadillac.com

1-800-458-8006

1-800-833-2622

(For Text Telephone devices (TTYs))

Roadside Assistance: 1-800-882-1112

From Puerto Rico:

1-800-496-9992 (English)

1-800-496-9993 (Spanish)

From U.S. Virgin Islands:

1-800-496-9994

Canada — Customer Assistance

General Motors of Canada Limited
Canadian Cadillac Customer Communication
Centre, CA1-163-005
1908 Colonel Sam Drive
Oshawa, Ontario L1H 8P7
www.gmcanada.com

1-888-446-2000

1-800-263-3830

(For Text Telephone devices (TTYs))

Roadside Assistance: 1-800-882-1112

Overseas — Customer Assistance

Please contact the local General Motors Business Unit.

Mexico, Central America and Caribbean Islands/Countries (Except Puerto Rico and U.S. Virgin Islands) — Customer Assistance

General Motors de Mexico, S. de R.L. de C.V.
Customer Assistance Center
Paseo de la Reforma # 2740
Col. Lomas de Bezares
C.P. 11910, Mexico, D.F.

01-800-508-0000

Long Distance: 011-52-53 29 0 800

GM Mobility Reimbursement Program



This program, available to qualified applicants, can reimburse you up to \$1,000 of the cost of eligible aftermarket adaptive equipment required for your vehicle, such as hand controls or a wheelchair/scooter lift.

The offer is available for a very limited period of time from the date of vehicle purchase/lease. For more details, or to determine your vehicle's eligibility, visit gmmobility.com or call the GM Mobility Assistance Center at 1-800-323-9935. Text telephone (TTY) users, call 1-800-833-9935.

General Motors of Canada also has a Mobility Program. Call 1-800-GM-DRIVE (463-7483) for details. TTY users call 1-800-263-3830.

Roadside Service

In the United States or Canada, call **1-800-882-1112**.

Text Telephone (TTY), U.S. only, call **1-888-889-2438**.

Service is available 24 hours a day, 365 days a year.

Calling for Assistance

When calling Roadside Assistance, have the following information ready:

- Your name, home address, and home telephone number
- Telephone number of your location
- Location of the vehicle
- Model, year, color, and license plate number of the vehicle
- Odometer reading, Vehicle Identification Number (VIN), and delivery date of the vehicle
- Description of the problem

Coverage

Services are provided up to 5 years/
100,000 miles (160 000 km), whichever comes first.

In the U.S., anyone driving the vehicle is covered. In Canada, a person driving the vehicle without permission from the owner is not covered.

Roadside Assistance is not a part of the New Vehicle Limited Warranty. Cadillac and General Motors of Canada Limited reserve the right to make any changes or discontinue the Roadside Assistance program at any time without notification.

Cadillac and General Motors of Canada Limited reserve the right to limit services or payment to an owner or driver if they decide the claims are made too often, or the same type of claim is made many times.

Cadillac Owner Privileges™

- **Emergency Fuel Delivery:** Delivery of enough fuel for the vehicle to get to the nearest service station.
- **Lock-Out Service:** Service is provided to unlock the vehicle if you are locked out. A remote unlock may be available if you have OnStar®. For security reasons, the driver must present identification before this service is given.
- **Emergency Tow From a Public Road or Highway:** Tow to the nearest Cadillac dealer for warranty service, or if the vehicle was in a crash and cannot be driven. Assistance is also given when the vehicle is stuck in the sand, mud, or snow.
- **Flat Tire Change:** Service is provided to change a flat tire with spare tire. The spare tire, if equipped, must be in good condition and properly inflated. It is your responsibility for the repair or replacement of the tire if it is not covered by the warranty.
- **Battery Jump Start:** Service is provided to jump start a dead battery.
- **Trip Routing Service:** Detailed maps of North America are provided when requested either with the most direct route or the most scenic route. Additional travel information is also available. Allow three weeks for delivery.
- **Trip Interruption Benefits and Assistance:** If your trip is interrupted due to a warranty failure, incidental expenses may be reimbursed during the 5 year/100,000 miles (160 000 km) Powertrain warranty period. Items considered are hotel, meals, and rental car.

Cadillac Technician Roadside Service (U.S. only)

Cadillac's exceptional Roadside Service is more than an auto club or towing service. It provides every Cadillac owner in the United States with the advantage of contacting a Cadillac advisor and, where available, a Cadillac trained dealer technician who can provide on-site service.

A dealer technician will travel to your location within a 30 mile radius of a participating Cadillac dealership. If beyond this radius, we will arrange to have your car towed to the nearest Cadillac dealership. Each technician travels with a specially equipped service vehicle complete with the necessary Cadillac parts and tools required to handle most roadside repairs.

Services Not Included in Roadside Assistance

- Impound towing caused by violation of any laws.
- Legal fines.
- Mounting, dismounting or changing of snow tires, chains, or other traction devices.
- Towing or services for vehicles driven on a non-public road or highway.

Services Specific to Canadian Purchased Vehicles

- **Fuel delivery:** Reimbursement is approximately \$5 Canadian. Diesel fuel delivery may be restricted. Propane and other fuels are not provided through this service.
- **Lock-Out Service:** Vehicle registration is required.
- **Trip Routing Service:** Limit of six requests per year.
- **Trip Interruption Benefits and Assistance:** Pre-authorization, original detailed receipts, and a copy of the repair orders are required. Once authorization has been received, the Roadside Assistance advisor will help you make arrangements and explain how to receive payment.
- **Alternative Service:** If assistance cannot be provided right away, the Roadside Assistance advisor may give you permission to get local emergency road service. You will receive payment, up to \$100, after sending the original receipt to Roadside Assistance. Mechanical failures may be covered, however any cost for parts and labor for repairs not covered by the warranty are the owner responsibility.

Scheduling Service Appointments

When your vehicle requires warranty service, contact your dealer and request an appointment. By scheduling a service appointment and advising your service consultant of your transportation needs, your dealer can help minimize your inconvenience.

If your vehicle cannot be scheduled into the service department immediately, keep driving it until it can be scheduled for service, unless, of course, the problem is safety-related. If it is, please call your dealership/retailer, let them know this, and ask for instructions.

If the dealer requests you to bring the vehicle for service, you are urged to do so as early in the work day as possible to allow for the same day repair.

Courtesy Transportation Program

To enhance your ownership experience, we and our participating dealers are proud to offer Courtesy Transportation, a customer support program for vehicles with the Bumper to Bumper (Base Warranty Coverage period in Canada) and extended powertrain, and hybrid specific warranties in both the U.S. and Canada.

Several courtesy transportation options are available to assist in reducing your inconvenience when warranty repairs are required.

Courtesy Transportation is not a part of the New Vehicle Limited Warranty. A separate booklet entitled "Warranty and Owner Assistance Information" furnished with each new vehicle provides detailed warranty coverage information.

Transportation Options

Warranty service can generally be completed while you wait. However, if you are unable to wait, GM helps to minimize your inconvenience by providing several transportation options. Depending on the circumstances, your dealer can offer you one of the following:

Shuttle Service

Participating dealers can provide shuttle service to get you to your destination with minimal interruption of your daily schedule. This includes one-way or round trip shuttle service to a destination up to 10 miles (16 km) from the dealership.

Public Transportation or Fuel Reimbursement

If your vehicle requires warranty repairs, and public transportation is used instead of the dealer's shuttle service, the expense must be supported by original receipts and can only be up to the maximum amount allowed by GM for shuttle service. In addition, for U.S. customers, should you arrange transportation through a

friend or relative, limited reimbursement for reasonable fuel expenses may be available. Claim amounts should reflect actual costs and be supported by original receipts. See your dealer for information regarding the allowance amounts for reimbursement of fuel or other transportation costs.

Courtesy Rental Vehicle

Your dealer may arrange to provide you with a courtesy rental vehicle or reimburse you for a rental vehicle that you obtain if your vehicle is kept for a warranty repair. If you obtain a rental vehicle on your own, please see your dealer for the maximum number of days allowed and the allowance per rental day. Rental reimbursement must be supported by original receipts. This requires that you sign and complete a rental agreement and meet state, local, and rental vehicle provider requirements. Requirements vary and may include minimum age requirements, insurance coverage, credit card, etc. You are responsible for fuel usage charges and may also be responsible for taxes, levies, usage fees, excessive mileage, or rental usage beyond the completion of the repair.

It may not be possible to provide a like-vehicle as a courtesy rental.

Additional Program Information

All program options, such as shuttle service, may not be available at every dealer. Please contact your dealer for specific information about availability. All Courtesy Transportation arrangements will be administered by appropriate dealer personnel.

General Motors reserves the right to unilaterally modify, change, or discontinue Courtesy Transportation at any time and to resolve all questions of claim eligibility pursuant to the terms and conditions described herein at its sole discretion.

Collision Damage Repair

If your vehicle is involved in a collision and it is damaged, have the damage repaired by a qualified technician using the proper equipment and quality replacement parts. Poorly performed collision repairs will diminish your vehicle's resale value, and safety performance can be compromised in subsequent collisions.

Collision Parts

Genuine GM Collision parts are new parts made with the same materials and construction methods as the parts with which your vehicle was originally built. Genuine GM Collision parts are your best choice to

ensure that your vehicle's designed appearance, durability and safety are preserved. The use of Genuine GM parts can help maintain your GM New Vehicle Warranty.

Recycled original equipment parts may also be used for repair. These parts are typically removed from vehicles that were total losses in prior crashes. In most cases, the parts being recycled are from undamaged sections of the vehicle. A recycled original equipment GM part, may be an acceptable choice to maintain your vehicle's originally designed appearance and safety performance, however, the history of these parts is not known. Such parts are not covered by your GM New Vehicle Limited Warranty, and any related failures are not covered by that warranty.

Aftermarket collision parts are also available. These are made by companies other than GM and may not have been tested for your vehicle. As a result, these parts may fit poorly, exhibit premature durability/corrosion problems, and may not perform properly in subsequent collisions. Aftermarket parts are not covered by your GM New Vehicle Limited Warranty, and any vehicle failure related to such parts are not covered by that warranty.

Repair Facility

GM also recommends that you choose a collision repair facility that meets your needs before you ever need collision repairs. Your GM dealer may have a collision repair center with GM-trained technicians and state of the art equipment, or be able to recommend a collision repair center that has GM-trained technicians and comparable equipment.

Insuring Your Vehicle

Protect your investment in your GM vehicle with comprehensive and collision insurance coverage. There are significant differences in the quality of coverage afforded by various insurance policy terms. Many insurance policies provide reduced protection to your GM vehicle by limiting compensation for damage repairs by using aftermarket collision parts. Some insurance companies will not specify aftermarket collision parts. When purchasing insurance, we recommend that you assure your vehicle will be repaired with GM original equipment collision parts. If such insurance coverage is not available from your current insurance carrier, consider switching to another insurance carrier.

If your vehicle is leased, the leasing company may require you to have insurance that assures repairs with Genuine GM Original Equipment Manufacturer (OEM) parts or Genuine Manufacturer replacement parts. Read your lease carefully, as you may be charged at the end of your lease for poor quality repairs.

If a Crash Occurs

If there has been an injury, call emergency services for help. Do not leave the scene of a crash until all matters have been taken care of. Move the vehicle only if its position puts you in danger, or you are instructed to move it by a police officer.

Give only the necessary information to police and other parties involved in the crash.

For emergency towing see *Roadside Service on page 8-7*

Gather the following information:

- Driver's name, address, phone number
- Driver's license number
- Owner's name, address, phone number
- Vehicle license plate
- Vehicle make, model and model year
- Vehicle Identification Number (VIN)
- Insurance company and policy number
- General description of the damage to the other vehicle

Choose a reputable repair facility that uses quality replacement parts. See "Collision Parts" earlier in this section.

If the airbag has inflated, see *What Will You See After an Airbag Inflates?* on page 2-66.

Managing the Vehicle Damage Repair Process

In the event that your vehicle requires damage repairs, GM recommends that you take an active role in its repair. If you have a pre-determined repair facility of choice, take your vehicle there, or have it towed there. Specify to the facility that any required replacement collision parts be original equipment parts, either new Genuine GM parts or recycled original GM parts. Remember, recycled parts will not be covered by your GM vehicle warranty.

Insurance pays the bill for the repair, but you must live with the repair. Depending on your policy limits, your insurance company may initially value the repair using aftermarket parts. Discuss this with your repair professional, and insist on Genuine GM parts. Remember if your vehicle is leased you may be obligated to have the vehicle repaired with Genuine GM parts, even if your insurance coverage does not pay the full cost.

If another party's insurance company is paying for the repairs, you are not obligated to accept a repair valuation based on that insurance company's collision policy repair limits, as you have no contractual limits with that company. In such cases, you can have control of the repair and parts choices as long as cost stays within reasonable limits.

Reporting Safety Defects

Reporting Safety Defects to the United States Government

If you believe that your vehicle has a defect which could cause a crash or could cause injury or death, you should immediately inform the National Highway Traffic Safety Administration (NHTSA) in addition to notifying General Motors.

If NHTSA receives similar complaints, it may open an investigation, and if it finds that a safety defect exists in a group of vehicles, it may order a recall and remedy campaign. However, NHTSA cannot become involved in individual problems between you, your dealer, or General Motors.

To contact NHTSA, you may call the Vehicle Safety Hotline toll-free at 1-888-327-4236 (TTY: 1-800-424-9153); go to <http://www.safercar.gov>; or write to:

Administrator, NHTSA
1200 New Jersey Avenue, S.E.
Washington, D.C. 20590

You can also obtain other information about motor vehicle safety from <http://www.safercar.gov>.

Reporting Safety Defects to the Canadian Government

If you live in Canada, and you believe that your vehicle has a safety defect, notify Transport Canada immediately, in addition to notifying General Motors of Canada Limited. Call them at 1-800-333-0510 or write to:

Transport Canada
Road Safety Branch
2780 Sheffield Road
Ottawa, Ontario K1B 3V9

Reporting Safety Defects to General Motors

In addition to notifying NHTSA (or Transport Canada) in a situation like this, please notify General Motors.

Call 1-800-458-8006, or write:

Cadillac Customer Assistance Center
Cadillac Motor Car Division
P.O. Box 33169
Detroit, MI 48232-5169

In Canada, call 1-888-446-2000, or write:

Canadian Cadillac Customer Communication
Centre, CA1-163-005
General Motors of Canada Limited
1908 Colonel Sam Drive
Oshawa, Ontario L1H 8P7

Service Publications Ordering Information

Service Manuals

Service Manuals have the diagnosis and repair information on engines, transmission, axle suspension, brakes, electrical, steering, body, etc.

Service Bulletins

Service Bulletins give additional technical service information needed to knowledgeable service General Motors cars and trucks. Each bulletin contains instructions to assist in the diagnosis and service of your vehicle.

Owner Information

Owner publications are written specifically for owners and intended to provide basic operational information about the vehicle. The owner manual includes the Maintenance Schedule for all models.

In-Portfolio: Includes a Portfolio, Owner Manual, and Warranty Booklet.

RETAIL SELL PRICE: \$35.00 (U.S.) plus processing fee

Without Portfolio: Owner Manual only.

RETAIL SELL PRICE: \$25.00 (U.S.) plus processing fee

Current and Past Model Order Forms

Technical Service Bulletins and Manuals are available for current and past model GM vehicles. To request an order form, specify year and model name of the vehicle.

ORDER TOLL FREE: 1-800-551-4123
Monday-Friday 8:00 AM - 6:00 PM
Eastern Time

For Credit Card Orders Only
(VISA-MasterCard-Discover), visit Helm, Inc. on the
World Wide Web at: helminc.com

Or you can write to:

Helm, Incorporated
P.O. Box 07130
Detroit, MI 48207

Prices are subject to change without notice and without
incurring obligation. Allow ample time for delivery.

Note to Canadian Customers: All listed prices are
quoted in U.S. funds. Canadian residents are to make
checks payable in U.S. funds.

Vehicle Data Recording and Privacy

Your GM vehicle has a number of sophisticated computers that record information about the vehicle's performance and how it is driven. For example, your vehicle uses computer modules to monitor and control engine and transmission performance, to monitor the conditions for airbag deployment and deploy airbags in a crash and, if so equipped, to provide antilock braking to help the driver control the vehicle. These modules may store data to help your dealer technician service your vehicle. Some modules may also store data about how you operate the vehicle, such as rate of fuel consumption or average speed. These modules may also retain the owner's personal preferences, such as radio pre-sets, seat positions, and temperature settings.

Event Data Recorders

This vehicle has an Event Data Recorder (EDR). The main purpose of an EDR is to record, in certain crash or near crash-like situations, such as an airbag deployment or hitting a road obstacle, data that will assist in understanding how a vehicle's systems performed. The EDR is designed to record data related to vehicle dynamics and safety systems for a short period of time, typically 30 seconds or less. The EDR in this vehicle is designed to record such data as:

- How various systems in your vehicle were operating
- Whether or not the driver and passenger safety belts were buckled/fastened
- How far, if at all, the driver was pressing the accelerator and/or brake pedal
- How fast the vehicle was traveling

This data can help provide a better understanding of the circumstances in which crashes and injuries occur.

Important: EDR data is recorded by your vehicle only if a non-trivial crash situation occurs; no data is recorded by the EDR under normal driving conditions and no personal data (e.g., name, gender, age, and crash location) is recorded. However, other parties, such as law enforcement, could combine the EDR data with the type of personally identifying data routinely acquired during a crash investigation.

To read data recorded by an EDR, special equipment is required, and access to the vehicle or the EDR is needed. In addition to the vehicle manufacturer, other parties, such as law enforcement, that have the special equipment, can read the information if they have access to the vehicle or the EDR.

GM will not access this data or share it with others except: with the consent of the vehicle owner or, if the vehicle is leased, with the consent of the lessee; in response to an official request of police or similar government office; as part of GM's defense of litigation through the discovery process; or, as required by law. Data that GM collects or receives may also be used for GM research needs or may be made available to others for research purposes, where a need is shown and the data is not tied to a specific vehicle or vehicle owner.

OnStar®

If the vehicle has OnStar and you subscribe to the OnStar services, please refer to the OnStar Terms and Conditions in the OnStar Owners Guide for information on data collection and use.

Navigation System

If your vehicle has a navigation system, use of the system may result in the storage of destinations, addresses, telephone numbers, and other trip information. Refer to the navigation system operating manual for information on stored data and for deletion instructions.

Radio Frequency Identification (RFID)

RFID technology is used in some vehicles for functions such as tire pressure monitoring and ignition system security, as well as in connection with conveniences such as key fobs for remote door locking/unlocking and

starting, and in-vehicle transmitters for garage door openers. RFID technology in GM vehicles does not use or record personal information or link with any other GM system containing personal information.

Radio Frequency Statement

This vehicle has systems that operate on a radio frequency that comply with Part 15 of the Federal Communications Commission (FCC) Rules and with RSS-210/211 of Industry Canada.

Operation is subject to the following two conditions:

1. The device may not cause interference.
2. The device must accept any interference received, including interference that may cause undesired operation of the device.

Changes or modifications to any of these systems by other than an authorized service facility could void authorization to use this equipment.

A

Accessories and Modifications	6-3
Accessory Power	3-24
Accessory Power Outlets	4-34
Adaptive Cruise Control	4-14
Add-On Electrical Equipment	6-105
Additives, Fuel	6-6
Air Cleaner/Filter, Engine	6-19
Air Filter, Passenger Compartment	4-43
Airbag	
Adding Equipment to Your Airbag-Equipped Vehicle	2-74
Airbag System	
How Does an Airbag Restrain?	2-65
Passenger Sensing System	2-68
Servicing Your Airbag-Equipped Vehicle	2-73
What Makes an Airbag Inflate?	2-65
What Will You See After an Airbag Inflates?	2-66
When Should an Airbag Inflate?	2-63
Where Are the Airbags?	2-61
Airbags	
Passenger Status Indicator	4-49
Readiness Light	4-48
System Check	2-58
Analog Clock	4-35
Antenna	
Backglass	4-122
Antenna, XM™ Satellite Radio Antenna System	4-122
Antilock Brake System (ABS)	5-4
Warning Light	4-52
Appearance Care	
Aluminum or Chrome-Plated Wheels	6-102
Care of Safety Belts	6-99
Chemical Paint Spotting	6-103
Cleaning Exterior Lamps/Lenses	6-100
Fabric/Carpet	6-97
Finish Care	6-101
Finish Damage	6-103
Instrument Panel, Vinyl, and Other Plastic Surfaces	6-99
Interior Cleaning	6-96
Leather	6-98
Sheet Metal Damage	6-103
Speaker Covers	6-99
Tires	6-102
Underbody Maintenance	6-103
Washing Your Vehicle	6-100
Weatherstrips	6-99
Windshield and Wiper Blades	6-101
Wood Panels	6-99
Ashtray(s)	4-35

Audio System	4-88
Audio Steering Wheel Controls	4-120
Navigation/Radio System, see Navigation	
Manual	4-110
Radio Reception	4-121
Setting the Clock	4-89
Theft-Deterrent Feature	4-120
XM™ Satellite Radio Antenna System	4-122
Audio System(s)	4-93
Automatic Transmission	
Fluid	6-21
Operation	3-27

B

Backglass Antenna	4-122
Battery	6-38
Electric Power Management	4-32
Exterior Lighting Battery Saver	4-30
Inadvertent Power Saver	4-33
Load Management	4-32
Run-Down Protection	4-33
Belt Routing, Engine	7-12
Bluetooth®	4-110
Brake	
Emergencies	5-5

Brakes	6-35
Antilock	5-4
Parking	3-30
System Warning Light	4-51
Braking	5-3
Braking in Emergencies	5-5
Break-In, New Vehicle	3-22
Bulb Replacement	
Fog Lamps	4-30
Headlamp Aiming	6-44
Headlamps	6-47
High Intensity Discharge (HID) Lighting	6-47
Buying New Tires	6-70

C

Calibration	3-36
California	
Perchlorate Materials Requirements	6-4
Warning	6-4
California Fuel	6-6
Canadian Owners	iii
Capacities and Specifications	6-114
Carbon Monoxide	
Engine Exhaust	3-34
Trunk	3-12
Winter Driving	5-15

Care of	
Safety Belts	6-99
CD, MP3	4-103
Center Console Storage	3-56
Center Flex Storage Unit	3-56
Center Seat	2-9
Central Door Unlock System	3-10
Chains, Tire	6-75
Charging System Light	4-50
Check	
Engine Lamp	4-55
Checking Things Under the Hood	6-12
Chemical Paint Spotting	6-103
Child Restraints	
Infants and Young Children	2-37
Lower Anchors and Tethers for Children	2-45
Older Children	2-33
Securing a Child Restraint in a Rear Seat	
Position	2-51
Securing a Child Restraint in the Center Front	
Seat Position	2-53
Securing a Child Restraint in the Right Front	
Seat Position	2-54
Systems	2-41
Where to Put the Restraint	2-44
Circuit Breakers	6-106
Cleaning	
Aluminum or Chrome-Plated Wheels	6-102
Exterior Lamps/Lenses	6-100
Fabric/Carpet	6-97
Finish Care	6-101
Instrument Panel, Vinyl, and Other Plastic	
Surfaces	6-99
Interior	6-96
Leather	6-98
Speaker Covers	6-99
Tires	6-102
Underbody Maintenance	6-103
Washing Your Vehicle	6-100
Weatherstrips	6-99
Windshield and Wiper Blades	6-101
Wood Panels	6-99
Climate Control System	
Outlet Adjustment	4-41
Climate Control Systems	
Dual	4-36
Rear	4-42
Climate Controls	1-14
Clock	4-35
Clock, Setting	4-89
Collision Damage Repair	8-13
Compass	3-36

Compressor Kit, Tire Sealant	6-77
Content Theft-Deterrent	3-19
Control of a Vehicle	5-3
Convenience Net	3-57
Coolant	
Engine	6-26
Engine Temperature Gauge	4-54
Engine Temperature Warning Light	4-54
Cooling System	6-24
Cornering Lamps	4-30
Courtesy Lamps	4-31
Courtesy Transportation Program	8-11
Cruise Control	4-11
Light	4-59
Cruise Control, Active	4-14
Cruise Control, Forward Collision Alert (FCA)	
System	4-6
Cupholders	3-55
Customer Assistance	8-6
Offices	8-6
Text Telephone (TTY) Users	8-6
Customer Information	
Service Publications Ordering Information	8-17
Customer Satisfaction Procedure	8-2

D

Damage Repair, Collision	8-13
Data Recorders, Event	8-19
Daytime Running Lamps (DRL)	4-29
Defensive Driving	5-2
Disc, MP3	4-103
Doing Your Own Service Work	6-4
Door	
Central Door Unlocking System	3-10
Locks	3-9
Power Locks	3-10
Programmable Automatic Door Locks	3-10
Rear Door Security Locks	3-10
Rear Seat Pass-Through	2-11
Driver Information Center (DIC)	4-61
DIC Operation and Displays	4-61
DIC Vehicle Customization	4-79
DIC Warnings and Messages	4-66
Driving	
At Night	5-11
Before a Long Trip	5-13
Defensive	5-2
Drunk	5-2
Highway Hypnosis	5-13

Driving (cont.)	
Hill and Mountain Roads	5-14
In Rain and on Wet Roads	5-12
Loss of Control	5-10
Off-Road Recovery	5-9
Rocking Your Vehicle to Get it Out	5-17
Winter	5-15
Driving for Better Fuel Economy	1-23
Dual Climate Control System	4-36

E

EDR	8-18
Electrical Equipment, Add-On	6-105
Electrical System	
Fuses and Circuit Breakers	6-106
Headlamp Wiring	6-105
Power Windows and Other Power Options	6-106
Rear Underseat Fuse Block	6-109
Underhood Fuse Block	6-106
Windshield Wiper Fuses	6-105
Electronic Immobilizer	
PASS-Key® III+	3-21
Electronic Immobilizer Operation	
PASS-Key® III+	3-21

Engine	
Air Cleaner/Filter	6-19
Check and Service Engine Soon Lamp	4-55
Compartment Overview	6-14
Coolant	6-26
Coolant Heater	3-26
Coolant Temperature Gauge	4-54
Coolant Temperature Warning Light	4-54
Cooling System	6-24
Drive Belt Routing	7-12
Exhaust	3-34
Oil	6-15
Overheated Protection Operating Mode	6-32
Overheating	6-29
Starting	3-24
Engine Oil	
Life System	6-18
Entry Lighting	4-31
Event Data Recorders	8-19
Extender, Safety Belt	2-33
Exterior Lamps	4-25
Exterior Lighting Battery Saver	4-30

F

Filter	
Engine Air Cleaner	6-19
Finish Damage	6-103
Flash-to-Pass	4-10
Flashers, Hazard Warning	4-3
Flat Tire	6-76
Flat Tire, Changing	6-85
Flat Tire, Storing	6-93
Floor Mats	3-57
Fluid	
Automatic Transmission	6-21
Power Steering	6-32
Windshield Washer	6-33
Fog Lamps	
Bulb Replacement	4-30
Light	4-59
Footwell Lamps	4-32
Forward Collision Alert (FCA) System	4-6
Front Storage Area	3-56
Fuel	6-5
Additives	6-6
California Fuel	6-6
Filling a Portable Fuel Container	6-11
Filling the Tank	6-8
Fuels in Foreign Countries	6-7

Fuel (cont.)	
Gasoline Octane	6-5
Gasoline Specifications	6-6
Gauge	4-60
Fuel Economy	
Driving for Better	1-23
Fuses	
Fuses and Circuit Breakers	6-106
Rear Underseat Fuse Block	6-109
Underhood Fuse Block	6-106
Windshield Wiper	6-105

G

Garage Door Opener	3-48
Gasoline	
Octane	6-5
Specifications	6-6
Gauges	
Engine Coolant Temperature	4-54
Fuel	4-60
Speedometer	4-47
Tachometer	4-47
Glove Box	3-55
GM Mobility Reimbursement Program	8-7

H

Hazard Warning Flashers	4-3
Head Restraints	2-2
Headlamp Wiring	6-105
Headlamps	
Aiming	6-44
Bulb Replacement	6-47
Daytime Running Lamps (DRL)	4-29
Exterior Lamps	4-25
Flash-to-Pass	4-10
High Intensity Discharge (HID) Lighting	6-47
High/Low Beam Changer	4-6
On Reminder	4-28
Wiper Activated	4-28
Heated	
Steering Wheel	4-4
Heated Seats	2-5
Heater	
Engine Coolant	3-26
High-Speed Operation, Tires	6-61
Highbeam On Light	4-60
Highway Hypnosis	5-13
Hill and Mountain Roads	5-14

Hood

Checking Things Under	6-12
Release	6-13
Horn	4-3
How to Wear Safety Belts Properly	2-17

I

Ignition Positions	3-23
Inadvertent Power Battery Saver	4-33
Infants and Young Children, Restraints	2-37
Inflation - Tire Pressure	6-59
Instrument Panel	
Brightness	4-30
Instrument Panel Cluster	4-46
Integrated Trailer Brake Control System (ITBC)	5-26
Introduction	7-2

J

Jump Starting	6-40
---------------------	------

K

Keyless Entry	
Remote (RKE) System	3-4
Keyless Entry System	3-4
Keys	3-3

L

Labeling, Tire Sidewall	6-51
Lamps	
Cornering	4-30
Courtesy	4-31
Daytime Running (DRL)	4-29
Exterior Lighting Battery Saver	4-30
Footwell	4-32
Malfunction Indicator	4-55
Reading	4-31
Lane Departure Warning	3-46
Lane Departure Warning Light	4-53
Lap Belt	2-32
Lap-Shoulder Belt	2-26
LATCH System for Child Restraints	2-45
Lighting	
Entry	4-31
Parade Dimming	4-31

Lights

Airbag Readiness	4-48
Antilock Brake System (ABS) Warning	4-52
Brake System Warning	4-51
Charging System	4-50
Cruise Control	4-59
Engine Coolant Temperature Warning	4-54
Exterior Lamps	4-25
Flash-to-Pass	4-10
Fog Lamps	4-59
High/Low Beam Changer	4-6
Highbeam On	4-60
Lane Departure Warning	4-53
Lights On Reminder	4-59
Oil Pressure	4-58
On Reminder	4-28
Passenger Airbag Status Indicator	4-49
Safety Belt Reminders	4-48
Security	4-59
StabiliTrak® Indicator	4-53
Tire Pressure	4-55
Traction Control System (TCS) Warning	4-52
Loading Your Vehicle	5-18
Lockout Switch, Valet	3-18

Locks	
Central Door Unlocking System	3-10
Door	3-9
Lockout Protection	3-11
Power Door	3-10
Programmable Automatic Door Locks	3-10
Rear Door Security Locks	3-10
Loss of Control	5-10
Lower Anchors and Tethers for Children	2-45
Lumbar	
Massaging Controls	2-4
Power Controls	2-4
Lumbar Controls, Rear Power	2-11

M

Magnetic Ride Control	5-7
Maintenance Schedule	
Maintenance Record	7-13
Maintenance Replacement Parts	7-11
Owner Checks and Services	7-7
Recommended Fluids and Lubricants	7-9
Scheduled Maintenance	7-3

Malfunction Indicator Lamp	4-55
Massaging Lumbar Controls	2-4
Memory Seat, Mirrors, Steering Wheel Controls	2-6
Message	
DIC Warnings and Messages	4-66
Mirrors	
Automatic Dimming Rearview	3-36
Outside Automatic Dimming Mirror	3-38
Outside Convex Mirror	3-39
Outside Heated Mirrors	3-39
Outside Power Foldaway Mirrors	3-37
Park Tilt	3-39
MP3	4-103

N

Navigation System, Privacy	8-20
Navigation/Radio System, see Navigation	
Manual	4-110
Net, Convenience	3-57
New Vehicle Break-In	3-22

O

Object Detection, Side Blind Zone Alert (SBZA) ...	3-43
Odometer	4-47
Off-Road	
Recovery	5-9
Oil	
Engine	6-15
Engine Oil Life System	6-18
Pressure Light	4-58
Older Children, Restraints	2-33
Online Owner Center	8-5
OnStar, Privacy	8-20
OnStar [®] System	1-24
Operation, Universal Home Remote System	3-49
Outlet Adjustment	4-41
Outlets	
Accessory Power	4-34
Outside	
Automatic Dimming Mirror	3-38
Convex Mirror	3-39
Heated Mirrors	3-39
Power Foldaway Mirrors	3-37
Overheated Engine Protection Operating Mode	6-32
Owner Checks and Services	7-7
Owners, Canadian	iii

P

Paint, Damage	6-103
Parade Dimming	4-31
Park	
Shifting Into	3-31
Shifting Out of	3-32
Park Aid	3-40
Park Tilt Mirrors	3-39
Parking	
Assist	3-40
Brake	3-30
Over Things That Burn	3-33
PASS-Key [®] III+ Electronic Immobilizer	3-21
PASS-Key [®] III+ Electronic Immobilizer	
Operation	3-21
Passenger Airbag Status Indicator	4-49
Passenger Compartment Air Filter	4-43
Passenger Sensing System	2-68
Passing	5-10
Perchlorate Materials Requirements, California	6-4
Performance Shifting	3-29
Phone	
Bluetooth [®]	4-110

Power	
Door Locks	3-10
Electrical System	6-106
Lumbar Controls	2-4
Rear Lumbar Controls	2-11
Reclining Seatbacks	2-8
Retained Accessory (RAP)	3-24
Seat	2-3
Steering Fluid	6-32
Tilt Wheel and Telescopic Steering Column	4-4
Windows	3-15
Pregnancy, Using Safety Belts	2-31
Privacy	8-18
Navigation System	8-20
OnStar	8-20
Radio Frequency Identification (RFID)	8-20
Program	
Courtesy Transportation	8-11
Programmable Automatic Door Locks	3-10
Proposition 65 Warning, California	6-4

R

Radio Frequency	
Identification (RFID)	8-20
Statement	8-20
Radio(s)	4-93
Radios	
Navigation/Radio System, see Navigation	
Manual	4-110
Reception	4-121
Setting the Clock	4-89
Theft-Deterrent	4-120
Reading Lamps	4-31
Rear Climate Control System	4-42
Rear Door Security Locks	3-10
Rear Heated Seats	2-10
Rear Seat Armrest	3-57
Rear Seat Pass-Through Door	2-11
Rearview Mirrors	
Automatic Dimming	3-36

Reclining Seatbacks, Power	2-8
Recommended Fluids and Lubricants	7-9
Recreational Vehicle Towing	5-24
Reimbursement Program, GM Mobility	8-7
Remote Keyless Entry (RKE) System	3-4
Remote Vehicle Start	3-7
Removing the Flat Tire and Installing the Spare Tire	6-88
Removing the Spare Tire and Tools	6-86
Replacement Parts Maintenance	7-11
Reporting Safety Defects Canadian Government	8-16
General Motors	8-16
U.S. Government	8-16
Restraint System Check Checking the Restraint Systems	2-75
Replacing Restraint System Parts After a Crash	2-76
Retained Accessory Power (RAP)	3-24
Roadside Service	8-7
Rocking Your Vehicle to Get it Out	5-17
Roof Sunroof	3-57
Running the Vehicle While Parked	3-35

S

Safety Belts Care of	6-99
Extender	2-33
How to Wear Safety Belts Properly	2-17
Lap Belt	2-32
Lap-Shoulder Belt	2-26
Reminders	4-48
Safety Belts Are for Everyone	2-12
Use During Pregnancy	2-31
Safety Defects Reporting Canadian Government	8-16
General Motors	8-16
U.S. Government	8-16
Safety Warnings and Symbols	iv
Scheduled Maintenance	7-3
Scheduling Appointments	8-11
Sealant Kit, Tire	6-77
Seats Center Seat	2-9
Head Restraints	2-2
Heated and Ventilated Seats	2-5
Heated Seats - Rear	2-10
Massaging Lumbar	2-4
Memory, Mirrors	2-6
Power Lumbar	2-4

Seats (cont.)	
Power Lumbar, Rear	2-11
Power Reclining Seatbacks	2-8
Power Seats	2-3
Securing a Child Restraint	
Center Front Seat Position	2-53
Rear Seat Position	2-51
Right Front Seat Position	2-54
Security	
Light	4-59
Service	6-3
Accessories and Modifications	6-3
Adding Equipment to the Outside of the Vehicle	6-5
Doing Your Own Work	6-4
Engine Soon Lamp	4-55
Parts Identification Label	6-104
Publications Ordering Information	8-17
Scheduling Appointments	8-11
Servicing Your Airbag-Equipped Vehicle	2-73
Setting the Clock	4-89
Sheet Metal Damage	6-103
Shifting	
Out of Park	3-32
Shifting Into Park	3-31
Side Blind Zone Alert	3-43
Signals, Turn and Lane-Change	4-5
Spare Tire	6-95
Installing	6-88
Removing	6-86
Storing	6-93
Specifications and Capacities	6-114
Speedometer	4-47
StabiliTrak [®] Indicator Light	4-53
StabiliTrak [®] System	5-5
Start Vehicle, Remote	3-7
Starting the Engine	3-24
Steering	5-8
Heated Wheel	4-4
Steering Wheel Controls, Audio	4-120
Steering Wheel Controls, Memory	2-6
Steering Wheel, Power Tilt Wheel and Telescopic	
Steering Column	4-4
Steering Wheel, Tilt Wheel	4-3
Storage Areas	
Center Console	3-56
Center Flex Storage Unit	3-56
Convenience Net	3-57
Cupholders	3-55
Front Storage Area	3-56
Glove Box	3-55
Rear Seat Armrest	3-57

Storing the Tire Sealant and Compressor Kit	6-84
Stuck in Sand, Mud, Ice, or Snow	5-17
Sun Visors	3-17
Sunroof	3-57

T

Tachometer	4-47
Telescopic Steering Column, Power Tilt Wheel	4-4
Text Telephone (TTY) Users	8-6
Theft-Deterrent Feature	4-120
Theft-Deterrent Systems	3-18
Content Theft-Deterrent	3-19
PASS-Key® III+ Electronic Immobilizer	3-21
PASS-Key® III+ Electronic Immobilizer Operation	3-21
Tilt Wheel	4-3
Time, Setting	4-89
Tires	6-50
Aluminum or Chrome-Plated Wheels, Cleaning	6-102
Buying New Tires	6-70
Chains	6-75
Changing a Flat Tire	6-85
Cleaning	6-102
Different Size	6-71

Tires (cont.)	
High-Speed Operation	6-61
If a Tire Goes Flat	6-76
Inflation - Tire Pressure	6-59
Inspection and Rotation	6-67
Installing the Spare Tire	6-88
Pressure Light	4-55
Pressure Monitor Operation	6-63
Pressure Monitor System	6-62
Removing the Flat Tire	6-88
Removing the Spare Tire and Tools	6-86
Sealant and Compressor Kit	6-77, 6-84
Sidewall Labeling	6-51
Spare Tire	6-95
Storing a Flat or Spare Tire and Tools	6-93
Terminology and Definitions	6-56
Uniform Tire Quality Grading	6-72
Wheel Alignment and Tire Balance	6-73
Wheel Replacement	6-74
When It Is Time for New Tires	6-69
Towing	
Recreational Vehicle	5-24
Towing a Trailer	5-26
Your Vehicle	5-24

Traction	
Control System (TCS)	5-6
Control System Warning Light	4-52
Magnetic Ride Control	5-7
StabiliTrak® System	5-5
Transmission	
Fluid, Automatic	6-21
Transmission Operation, Automatic	3-27
Transportation Program, Courtesy	8-11
Trunk	3-12
Turn and Lane-Change Signals	4-5
Turn Signal/Multifunction Lever	4-5

U

Ultrasonic Front and Rear Parking Assist (UFRPA)	3-40
Uniform Tire Quality Grading	6-72
Universal Home Remote System	3-48
Operation	3-49

V

Valet Lockout Switch	3-18
Vehicle	
Control	5-3
Loading	5-18
Remote Start	3-7
Running While Parked	3-35
Symbols	iv
Vehicle Customization, DIC	4-79
Vehicle Data Recording and Privacy	8-18
Vehicle Identification	
Number (VIN)	6-104
Service Parts Identification Label	6-104
Ventilated Seats	2-5
Ventilation Adjustment	4-41
Visors	3-17

W

Warning Lights, Gauges, and Indicators	4-45
Warnings	
DIC Warnings and Messages	4-66
Hazard Flashers	4-3
Safety and Symbols	iv
Wheels	
Alignment and Tire Balance	6-73
Different Size	6-71
Replacement	6-74
When It Is Time for New Tires	6-69
Where to Put the Child Restraint	2-44
Windows	3-14
Power	3-15

Windshield	
Washer	4-11
Washer Fluid	6-33
Wiper Blade Replacement	6-48
Wiper Blades, Cleaning	6-101
Wiper Fuses	6-105
Wipers	4-10
Winter Driving	5-15
Wiper Activated Headlamps	4-28

X

XM Radio Messages	4-108
XM™ Satellite Radio	
Antenna	4-122

Free Manuals Download Website

<http://myh66.com>

<http://usermanuals.us>

<http://www.somanuals.com>

<http://www.4manuals.cc>

<http://www.manual-lib.com>

<http://www.404manual.com>

<http://www.luxmanual.com>

<http://aubethermostatmanual.com>

Golf course search by state

<http://golfingnear.com>

Email search by domain

<http://emailbydomain.com>

Auto manuals search

<http://auto.somanuals.com>

TV manuals search

<http://tv.somanuals.com>