





AN ASSORTMENT OF
GOURMET ACCESSORIES
FOR ANY OCCASION

Since the discovery of fire, people have enjoyed outdoor cooking. Since then, outdoor enthusiasts have sought more convenient, powerful and professional barbecue grills and accessories. Homeowners around the world all have one thing in common: The desire to cook outdoors. Now you can do it with style and function! Cal Flame is the first and only manufacturer to offer you the commercial-grade equipment to build a true outdoor kitchen.

The very best in stainless steel grills and cooking peripherals can now be yours. Side burners, food warmers and outdoor refrigerators eliminate the need to run inside and keep you where you want to be the most: At the grill! Best of all, Cal Flame gives you the choice of grill accessories to personalize your barbecue island with your unique style of cooking. Add smoke trays, sear zones and deep fryers with ease. Our grills provide every convenience of an indoor kitchen...without the walls. Cal Flame: Gourmet grilling of the highest degree.





QUALITY YOU CAN TRUST



All Cal Flame grills series are ETL and CE listed and constructed using 304 or 430 Commercial Grade stainless steel, double-walled construction, and cast stainless steel or porcelain burners. Standard premium features include 3-5 burners; individual blowtorch igniters for each burner, infrared back burner, nighttime grill lights, full-length drip tray, and flavor bars. Cal Flame Grills are the hottest looking grills on the market, and the best performing. With designer knobs, exclusive V-shaped grates and polished stainless steel construction, looks alone can sear your steak.



1 Sturdy Construction

Seamless 304-gauge stainless steel hood with built-in temperature gauge for precision grilling.

2 Temperature Gauge



Precision cooking begins with just the right temperature. Extended prong for accurate cooking.

3 Durable Handle



Welded one-piece handle finished in high-polish.

4 Convenient Nighttime Grilling



Self-cleaning grill lights illuminate food for perfectly grilled meals every time.

5 New Warmer Rack Hideaway Hook



The warming rack suspends from convenient hooks when you just need more rotisserie space.

6 12V Rotisserie Roller



The built-in roller creates smooth, continuous turning of the rotisserie for more even cooking.

7 Rotisserie Cooking



The infrared backburner produces an intense heat, evenly cooking up to 35 lbs. on the rotisserie spit.

8 Reversible Rotisserie Hook-Up



Rotisserie can be hooked directly to the grill, on either side, for its power source. With this unit attached to your Cal Flame grill you can turn a roast perfectly and guarantee you flawlessly cooked dishes.

9 Convection Grill



Unique technology offered only on Cal Flame grills features a powerful fan that circulates heat throughout the cooking area, eliminating cold zones and the need to shift food.

10 Smart Grilling



Cal Flame exclusive V-shaped grates keep smaller food from falling through.

11 Largest Grilling Surface Areas



Cal Flame offers 25% more grilling capacity than the competition.

12 Lifetime Guaranteed Cast Stainless Steel Burners



These commercial-grade burners emit 15000 BTUs each and features dedicated blowtorch ignition and control knobs.

13 Clean Knobs Every Time



Front panel controls are always protected by the one-piece splash guard.

14 One Hand Operation Knob



Cal Flame exclusive custom knobs feature one-hand operation with blowtorch ignition.

15 Easy Cleaning



The full-width drip tray catches all drippings and slides out for easy cleaning.

16 Conversion Kit

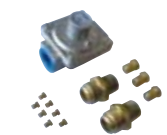

All Cal Flame grills are built for liquid propane, but come with natural gas conversion kits as standard.

OPTIONAL FEATURES

17 Lock in the Flavor



Substitute any grill burner with an optional sear zone to seal flavor and juices with a tasty crust.

18 Enjoy Smoked Barbecue



Any grill burner can also be substituted with a smoke tray to infuse food with smoky flavor.



WHAT MAKES A PERFECT OUTDOOR KITCHEN

Grills

You don't need to be a gourmet chef to prepare gourmet meals on these professional-grade drop-in grills. Cal Flame has the grill for you: From the expanded "G" Series to the classic line of 2- to 5-burner models (most with infrared backburners) to electric grills which are perfect for apartments to charcoal grills that will satisfy any purist.

Grill Accessories

Add even more functionality to your grill with powerful 12V rotisseries. The rotisserie basket makes it easy to prepare seafood and vegetables. Replace a burner with a sear zone or a smoke tray. Deep-fry foods right on the grill with the Deep Fryer Helper—designed exclusively for Cal Flame.

Side Burners

Convenient side burners make it easy to prepare multiple meals while you grill. Cook soups, stews and skillet dishes without having to run inside. Choose single and double side burners in the style that complements your backyard design.

Drop-In Accessories

Drop-in accessories give you the functionality you need to handle any event in your backyard or garden. Keep side dishes fresh with food warmers and make any drink with cocktail centers, blenders and ice chests. Prepare rare meals with a vertical grill, hibachi grill and deep fryer. At Cal Flame, it's all about choice.

Doors & Drawers

Have everything you need to grill the perfect steak close at hand with deep drawers and spacious storage. Cal Flame provides several options for storing spices, cooking utensils, propane, aprons and everything else you may need.

Ovens

Enjoy the convenience of a food warmer that discreetly hides itself in a drawer. Kids will love the electric pizza oven drawer that can also double as a dish warmer for keeping meals hot.

Refrigerators & Ice Makers

Keep food fresh and ready for cooking or chill drinks with stainless steel refrigerators. Host keg parties in style with a built-in beer tap. Have sodas ready for the kids in the elegant beverage cooler. The Cal Flame ice maker ensures you never have to run to the store for more ice!

Accessories

When you're creating the perfect meal, the last thing you need are interruptions. That's why Cal Flame offers handy built-in tools like bottle openers, griddle trays and cutting boards.

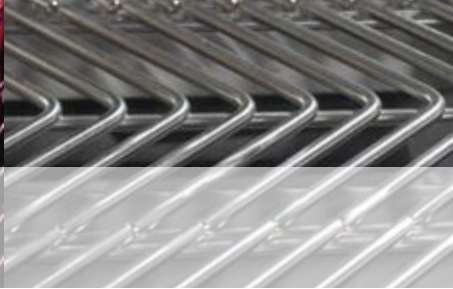

GRILLS

This is the finest cooking equipment in the industry. Available in 2- to 5-burner, electric and charcoal configurations.

OVENS

Enjoy the functionality of baking pizza or keeping food warm.

SIDE BURNERS

Prepare side dishes while you grill the main course!

DROP-IN ACCESSORIES

Add more functionality with food warmers, sinks, blenders and ice chests.



DOORS & DRAWERS

Deep drawers and spacious cabinets for discreet, convenient storage.

REFRIGERATORS & ICE MAKERS

Cooling units keep food fresh and beverages crisp while the ice maker ensures you never have to leave the party.

ACCESSORIES

Extra tools to make your cooking experience easier, like bottle openers, griddles and cutting boards.







DROP-IN GRILLS



5 Burner Convection Grill



Part Number: BBQ08875CP

	Dimensions:	39" x 24" x 22 ^{7/16} " (99x 61x 57cm)
	BTU Output:	75,000
	Cooking Area:	1,000 sq. in. (2540cm)
	Infrared Burner:	YES 22000 BTU
	Rotisserie:	YES
	C/O Dimensions:	9 ^{1/4} " x 38 ^{7/8} " x 22 ^{1/4} " (23.5x 98.7x 56.5cm)



5 Burner Grill

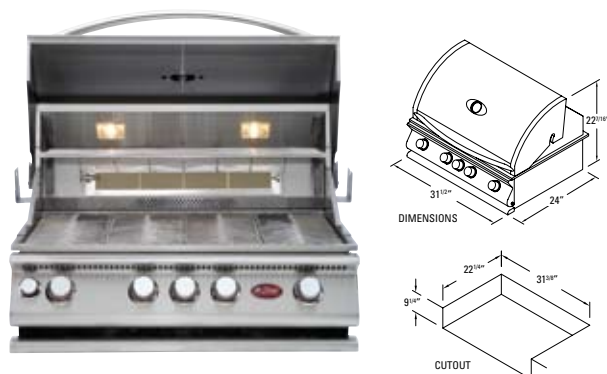

Part Number: BBQ08875P

	Dimensions:	39" x 24" x 22 ^{7/16} " (99x 61x 57cm)
	BTU Output:	75,000
	Cooking Area:	1,000 sq. in. (2540cm)
	Infrared Burner:	YES 22000 BTU
	Rotisserie:	YES
	C/O Dimensions:	9 ^{1/4} " x 38 ^{7/8} " x 22 ^{1/4} " (23.5x 98.7x 56.5cm)



4 Burner Convection Grill

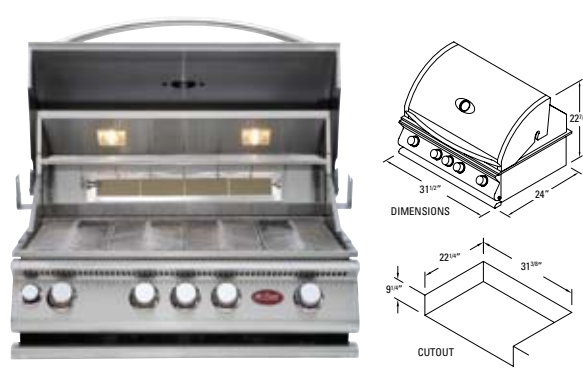

Part Number: BBQ0874CP

	Dimensions:	31 ^{1/2} " x 24" x 22 ^{7/16} " (80x 61x 57cm)
	BTU Output:	60,000
	Cooking Area:	800 sq. in. (2032cm)
	Infrared Burner:	YES 15000 BTU
	Rotisserie:	YES
	C/O Dimensions:	9 ^{1/4} " x 31 ^{3/8} " x 22 ^{1/4} " (23.5x 79x 56.5cm)



4 Burner Grill

Part Number: BBQ08874P

	Dimensions:	31 ^{1/2} " x 24" x 22 ^{7/16} " (80x 61x 57cm)
	BTU Output:	60,000
	Cooking Area:	800 sq. in. (2032cm)
	Infrared Burner:	YES 15000 BTU
	Rotisserie:	YES
	C/O Dimensions:	9 ^{1/4} " x 31 ^{3/8} " x 22 ^{1/4} " (23.5x 79x 56.5cm)



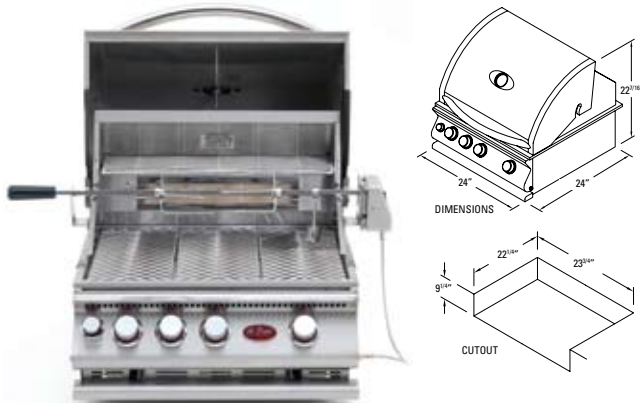

DROP-IN GRILLS



3 Burner Grill

Part Number: BBQ08873P

	Dimensions:	24" x 24" x 22 7/16" (61x 61x 57cm)
	BTU Output:	45,000
	Cooking Area:	600 sq. in. (1524cm)
	Infrared Burner:	YES 11,000 BTU
	Rotisserie:	YES
	C/O Dimensions:	9 1/4" x 23 3/4" x 22 1/4" (23.5x 60.5x 56.5cm)



5 Burner G5 Grill



Part Number: BBQ09G05

	Dimensions:	39" x 24" x 22 7/16" (99x 61x 57cm)
	BTU Output:	75,000
	Cooking Area:	1,000 sq. in. (2540cm)
	Infrared Burner:	N/A
	Rotisserie:	N/A
	C/O Dimensions:	9 1/4" x 38 7/8" x 22 1/4" (23.5x 98.7x 56.5cm)



4 Burner G4 Grill

Part Number: BBQ08G04

	Dimensions:	31 1/2" x 24" x 22 7/16" (80x 61x 57cm)
	BTU Output:	60,000
	Cooking Area:	800 sq. in. (2032cm)
	Infrared Burner:	N/A
	Rotisserie:	N/A
	C/O Dimensions:	9 1/4" x 31 3/8" x 22 1/4" (23.5x 79x 56.5cm)

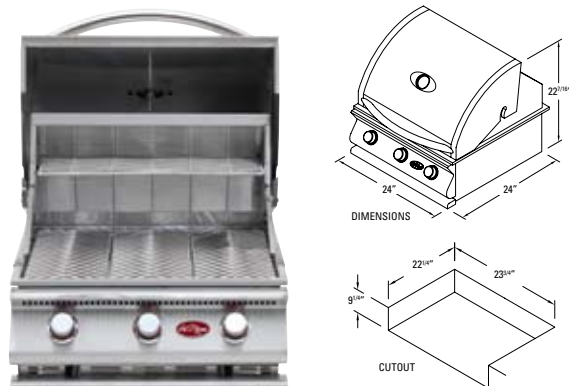

3 Burner G3 Grill

Part Number: BBQ09G03

	Dimensions:	24" x 24" x 22 7/16" (61x 61x 57cm)
	BTU Output:	45,000
	Cooking Area:	600 sq. in. (1524cm)
	Infrared Burner:	N/A
	Rotisserie:	N/A
	C/O Dimensions:	9 1/4" x 23 3/4" x 22 1/4" (23.5x 60.5x 56.5cm)



DROP-IN GRILLS

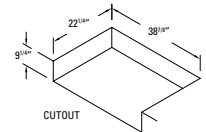
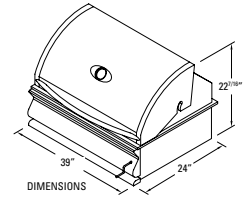
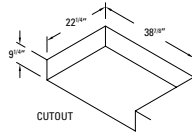
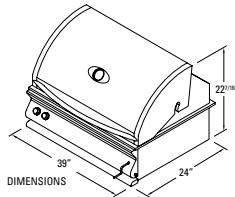

Charcoal Convection Grill (w/ Lights and Infrared) Part Number: BBQ08880P

- Dimensions: 39" x 24" x 22^{7/16}" (99x 61x 57cm)
- Cooking Area: 800 sq. in. (2,032cm)
- Infrared Burner: YES 15000 BTU
- Rotisserie: YES
- C/O Dimensions: 9^{1/4}" x 38^{7/8}" x 22^{1/4}" (23.5x 98.7x 56.5cm)

Charcoal Grill (No Lights) Part Number: BBQ08870P

- Dimensions: 39" x 24" x 22^{7/16}" (99x 61x 57 cm)
- Cooking Area: 800 sq. in. (2,032 sq. cm)
- Infrared Burner: N/A
- Rotisserie: N/A
- C/O Dimensions: 9^{1/4}" x 38^{7/8}" x 22^{1/4}" (23.5x 98.7x 56.5 cm)

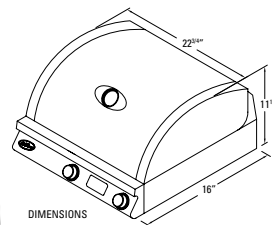

Electric Grill (110v) Part Number: BBQ08882E



- Dimensions: 22^{3/4}" x 16" x 11^{1/2}"
- Cooking Area: 277 sq. in.
- Watts: 1500
- Amps: 12.5



SIDE BURNERS





Deluxe Double Side By Side Burner
Part Number: BBQ08954P

 Dimensions: 26" x 13" x 10 1/2" (66x 33x 26.7 cm)
 BTU Output: 30,000
 C/O Dimensions: 7 1/4" x 25 1/2" x 13 1/4" (18.4x 64.8x 33.6 cm)



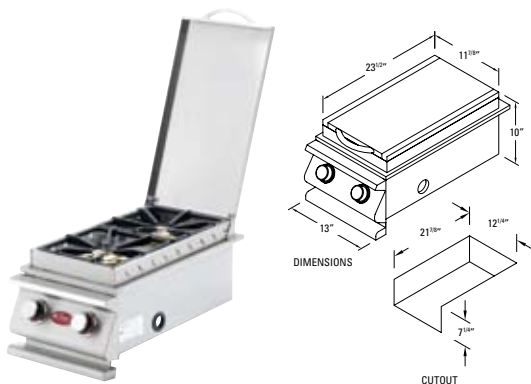

Standard Side By Side Flat Burner
Part Number: BBQ08953P

 Dimensions: 24 1/4" x 19 1/2" x 6 1/8" (61.6x 49.5x 15.5 cm)
 BTU Output: 30,000
 C/O Dimensions: 4 1/4" x 24 1/2" x 19 3/4" (10.8x 62.2x 50.2 cm)



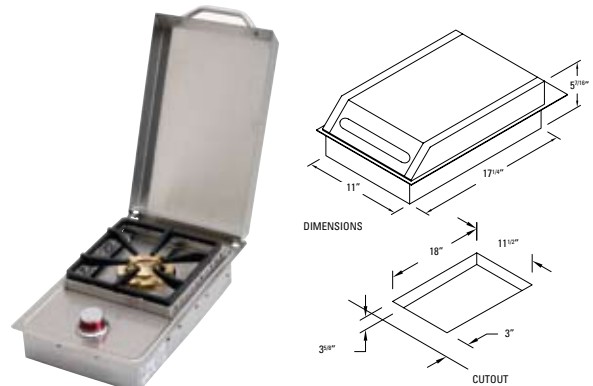

Deluxe Double Side Burner
Part Number: BBQ08899P

 Dimensions: 13" x 23 1/2" x 10" (33x 59.7x 25.4 cm)
 BTU Output: 30,000
 C/O Dimensions: 7 1/4" x 12 1/4" x 21 7/8" (18.4x 31.1x 55.3 cm)



Standard Single Flat Side Burner
Part Number: BBQ08852P

 Dimensions: 11" x 17 1/4" x 5 7/16" (27.9x 43.8x 13.8 cm)
 BTU Output: 15,000
 C/O Dimensions: 3 5/8" x 11 1/2" x 18" (9.2x 29.2x 45.7 cm)

DROP-IN ACCESSORIES

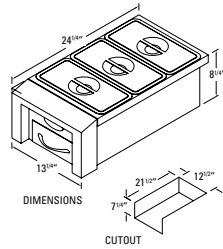

Drop-In Food Warmer

Part Number: BBQ07888P

Dimensions: 13 1/4" x 24 1/4" x 8 1/4" (33.6x 61.6x 20.9 cm)

C/O Dimensions: 7 1/4" x 12 1/2" x 21 1/2" (18.4x 31.7x 54.6 cm)

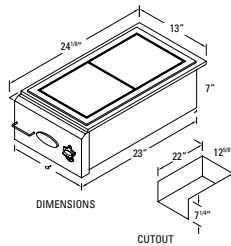

12" Cocktail Center

Part Number: BBQ07842P-12

Dimensions: 13" x 24 1/8" x 7" (33x 61.3x 17.8 cm)

C/O Dimensions: 7 1/4" x 12 5/8" x 22" (18.4x 32x 55.9 cm)

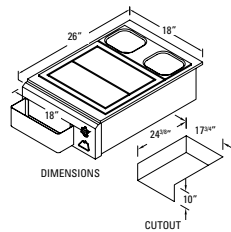

18" Cocktail Center

Part Number: BBQ07842P-18

Dimensions: 18" x 26" x 9 3/4" (45.7x 66x 24.8 cm)

C/O Dimensions: 10" x 17 3/4" x 24 3/8" (25.4x 45.1x 61.9 cm)

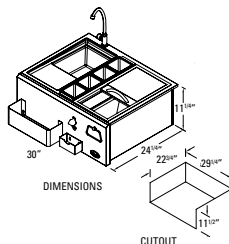

30" Drop-In Bar Center

Part Number: BBQ07902

Dimensions: 30" x 24 1/4" x 11 1/4" (76.2x 61.6x 28.6 cm)

C/O Dimensions: 11 1/2" x 29 1/4" x 22 3/4" (29.2x 74.3x 57.8 cm)

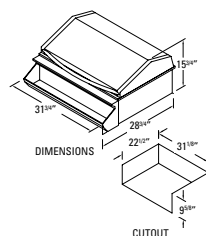

30" Drop-In Ice Chest

Part Number: BBQ07864P

Dimensions: 31 3/4" x 28 3/4" x 15 3/4" (80.6x 73x 40 cm)

C/O Dimensions: 9 5/8" x 31 1/8" x 22 1/2" (24.4x 79x 57.1 cm)



DROP-IN ACCESSORIES

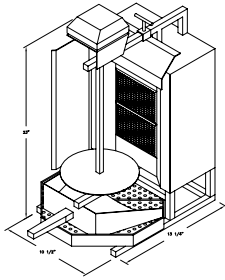

Gyro Vertical Grill Part Number: BBQ09903P

Dimensions: 10¹/₂" x 13¹/₄" x 23"
C/O Dimensions: TBD

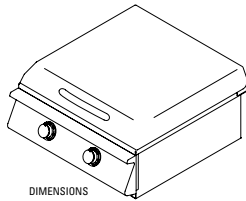

Hibachi Drop-In Grill Part Number: BBQ09900

Dimensions: TBD
C/O Dimensions: TBD

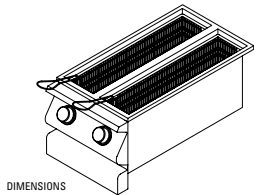

Deep Fryer Drop-In Part Number: BBQ09901

Dimensions: TBD
C/O Dimensions: TBD

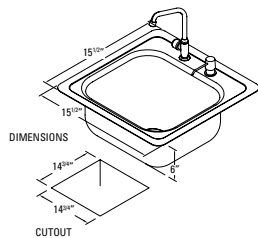

Stainless Steel Sink (w/ Faucet and Soap Dispenser) Part Number: BBQ07963

Dimensions: 15¹/₂" x 15¹/₂" x 6" (39.4x 39.5x 15.2 cm)
C/O Dimensions: 14³/₄" x 14³/₄" (37.5x 37.5 cm)

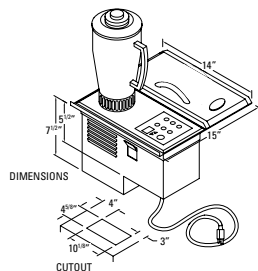

Top Counter Blender Station Part Number: BBQ07912

Dimensions: 15" x 14" x 7¹/₂" (38.1x 35.6x 19 cm)

Top Counter Blender Cover Part Number: BBQ07100500

TOP COUNTER BLENDER COVER

DOORS & DRAWERS

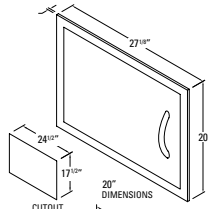

27" Horizontal Door

Part Number: BBQ07841P-27

Dimensions: 27^{1/8}" x 20" (68.9x 50.8 cm)

C/O Dimensions: 24^{1/2}" x 17^{1/2}" (62.2x 44.4 cm)

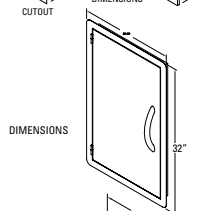

20" Tall Single Door

Part Number: BBQ08841P-20

Dimensions: 20" x 32" (50.8x 81.3 cm)

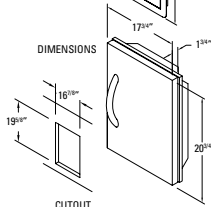

18" Single Access Door

Part Number: BBQ08839P-18

Dimensions: 20^{3/4}" x 17^{3/4}" x 1^{1/4}" (52.7x 45.1x 3.2 cm)

C/O Dimensions: 19^{5/8}" x 16^{7/8}" (49.8x 42.9 cm)

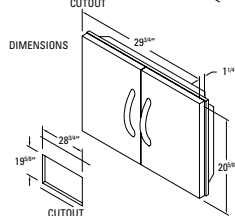

30" Double Access Door

Part Number: BBQ08839P-30

Dimensions: 20^{3/8}" x 29^{3/4}" x 1^{1/4}" (52.4x 75.6x 3.1 cm)

C/O Dimensions: 19^{5/8}" x 28^{3/4}" x 2^{3/4}" (49.8x 73x 7 cm)

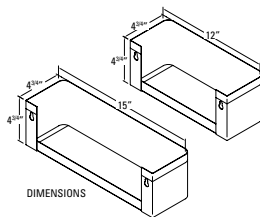

18" Juice / Spice Rack

Part Number: BBQ07846P-18

Dimensions: 12" x 4^{3/4}" x 4^{3/4}" (30.5x 12x 12 cm)

30" Juice / Spice Rack

Part Number: BBQ07846P-30

Dimensions: 15" x 4^{3/4}" x 4^{3/4}" (38.1x 12x 12 cm)

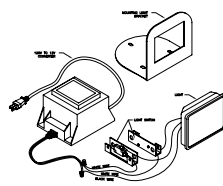

Lights Inside the Door Kit

Part Number: BBQ07831

(Lights inside the door kit available only on 18" Single and 30" Double Access Doors)

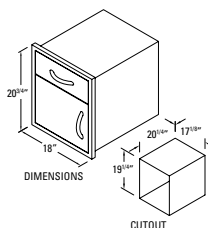

18" Door & Drawer Combo

Part Number: BBQ08840P-18

Dimensions: 20^{3/4}" x 18" x 20^{3/4}" (52.7x 45.7x 52.7 cm)

C/O Dimensions: 19^{1/4}" x 17^{1/8}" x 20^{1/4}" (48.9x 43.5x 51.4 cm)

DOORS & DRAWERS

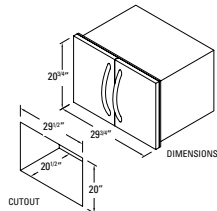

30" Door & Drawer Combo

Part Number: BBQ07840P-30

Dimensions: 20 3/4" x 29 1/2" x 21 3/4" (52.7x 75.6x 55.2 cm)

C/O Dimensions: 20" x 29 1/2" x 20 1/2" (50.8x 74.9x 52 cm)

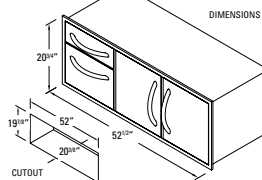

Complete Utility Storage Set

Part Number: BBQ07909

Dimensions: 20 3/4" x 52 1/2" x 20 3/4" (52.7x 133.3x 52.7 cm)

C/O Dimensions: 19 7/8" x 52" x 20 3/8" (50.5x 132.1x 51.7 cm)

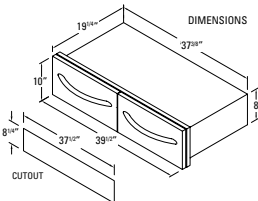

2 Drawer Horizontal

Part Number: BBQ08867P

Dimensions: 39 1/2" x 19 1/4" x 10" (100.3x 48.9x 25.4 cm)

C/O Dimensions: 37 1/2" x 8 1/4" (95.2x 20.9 cm)

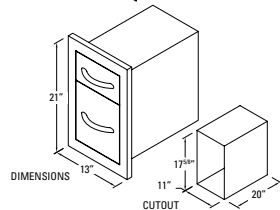

2 Drawer Storage Deep Drawer

Part Number: BBQ07868P

Dimensions: 21" x 13" x 20 1/2" (53.3x 33x 52.1 cm)

C/O Dimensions: 17 5/8" x 11" x 20" (44.8x 27.9x 50.8 cm)

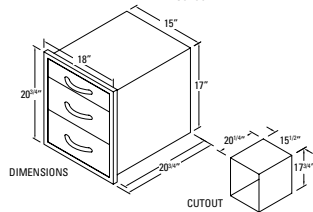

3 Drawer Storage Wide

Part Number: BBQ08866

Dimensions: 18" x 20 3/4" x 20 3/4" (45.7x 52.7x 52.7 cm)

C/O Dimensions: 20 1/4" x 15 1/2" x 17 3/4" (51.4x 39.4x 45.1 cm)

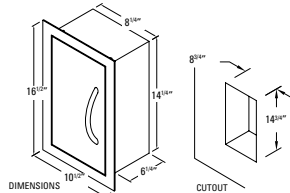

Paper Towel Storage Door

Part Number: BBQ07910

Dimensions: 16 1/2" x 10 1/2" x 6 1/4" (49.1x 26.7x 15.9 cm)

C/O Dimensions: 14 3/4" x 8 3/4" (37.5x 22.2 cm)

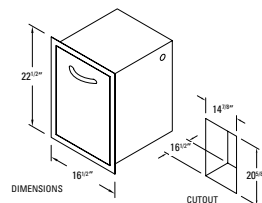

Propane Tank Drawer

Part Number: BBQ07857P

Dimensions: 22 1/2" x 16 1/2" x 16 1/4" (57.1x 41.9x 41.3 cm)

C/O Dimensions: 20 5/8" x 14 7/8" x 16 1/2" (52.4x 37.8x 41.9 cm)

OVENS & REFRIGERATORS

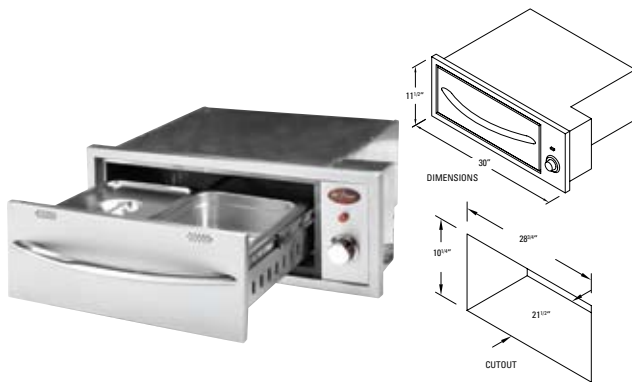

30" Warmer Drawer
Part Number: BBQ07889P

Dimensions: 30" x 11 1/2" x 21 1/4"
C/O Dimensions: 10 1/4" x 28 3/4" x 21 1/2"

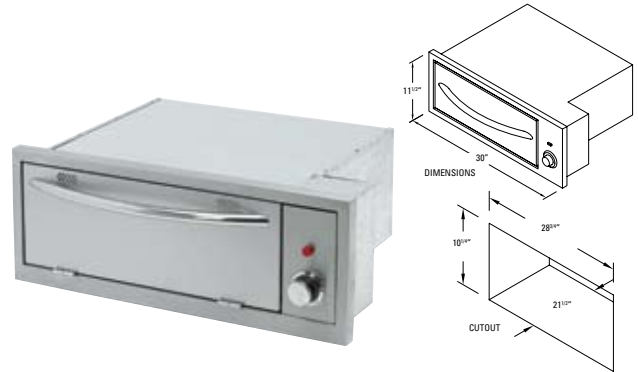

Built-In Pizza Drawer Electric 110V
Part Number: BBQ08967E

Dimensions: 30" x 11 1/2" x 21 1/4"
C/O Dimensions: 10 1/4" x 28 3/4" x 21 1/2"
Watts: 1,500
Amps: 12.5

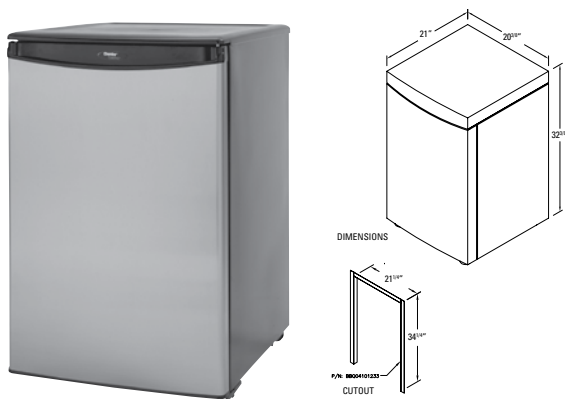

Stainless Steel Refrigerator
Part Number: BBQ07849P

Dimensions: 32 3/8" x 20 3/8" x 21"
C/O Dimensions: 34 1/4" x 21 1/4"

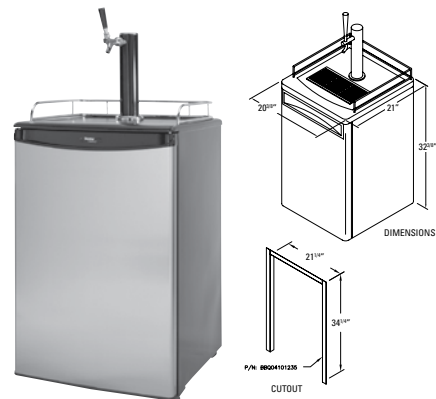

Beer Tap Refrigerator
Part Number: BBQ07843B

Dimensions: 32 3/8" x 20 3/8" x 21"
C/O Dimensions: 34 1/4" x 21 1/4"

REFRIGERATORS & ICE MAKERS

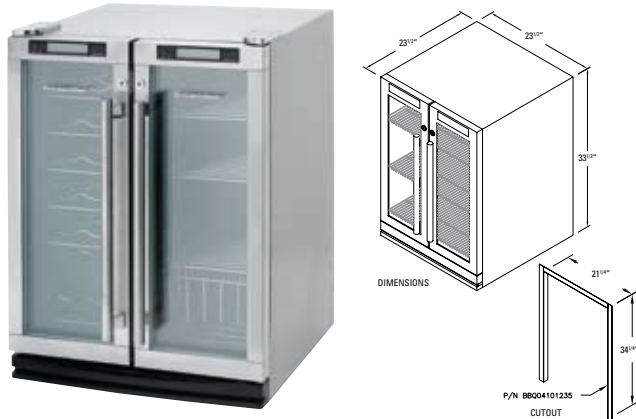

Outdoor Beverage Cooler

Part Number: BBQ07850P

Dimensions: 33 1/2" x 23 1/2" x 23 1/2"
 C/O Dimensions: 34 1/4" x 21 1/4"

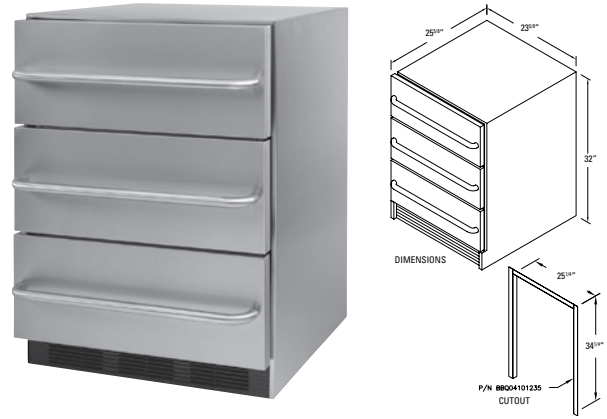

3 Drawer Pull Out Refrigerator

Part Number: BBQ07863P

Dimensions: 32" x 23 5/8" x 25 5/8"
 C/O Dimensions: 34 1/4" x 25 1/4"

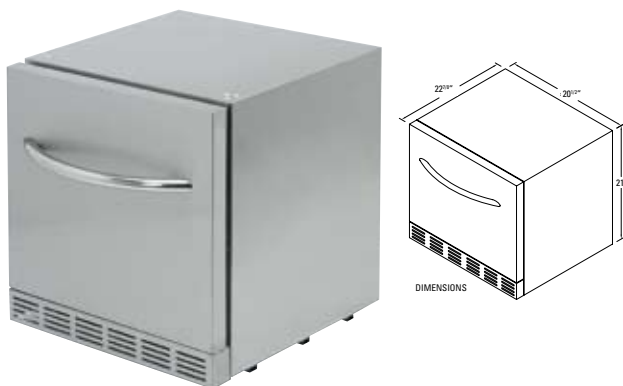

1 Drawer Pull Out Refrigerator

Part Number: BBQ08865

Dimensions: 21" x 20 1/2" x 22 7/8"

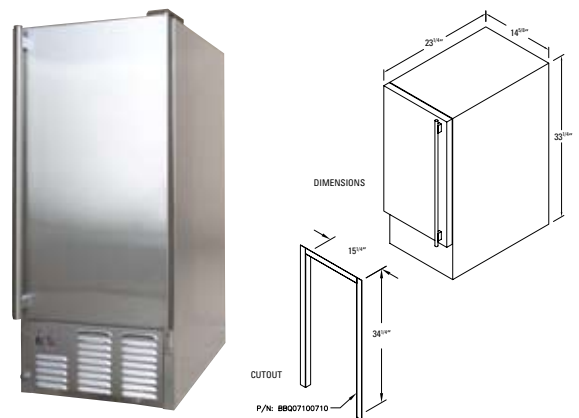

Ice Maker

Part Number: BBQ07908

Dimensions: 23 1/4" x 14 5/8" x 33 1/4"
 C/O Dimensions: 34 1/4" x 15 1/4"

GRILL ACCESSORIES

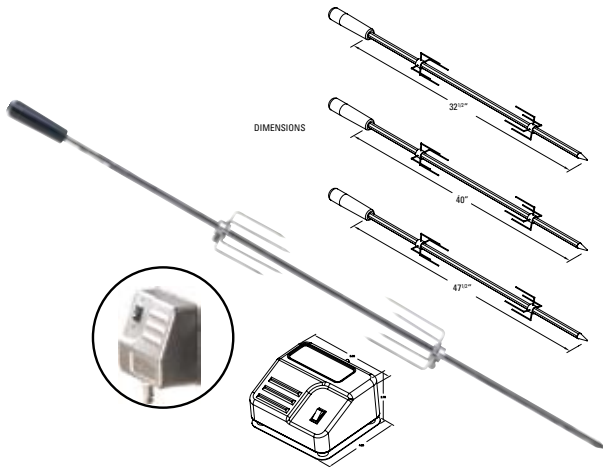

Rotisserie 3 Burner (Rod Kit '08)

Part Number: BBQ08856P3 Dimensions: 32¹/₂" (82.5 cm)

Rotisserie 4 Burner (Rod Kit '08)

Part Number: BBQ08856P4 Dimensions: 40" (101.6 cm)

Rotisserie 5 Burner (Rod Kit '08)

Part Number: BBQ08856P5 Dimensions: 47¹/₂" (120.6 cm)

Rotisserie Motor (12v)

Part Number: BBQ07100781

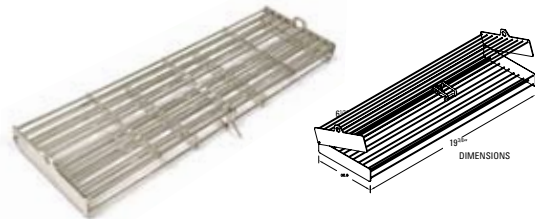

Rotisserie Basket

Part Number: BBQ08892

Dimensions: 19³/₈" x 6¹/₂" x 1¹/₂" (49.2x 16.5x 3.8 cm)

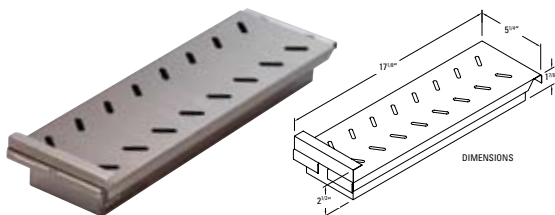

Smoke Tray

Part Number: BBQ07854P

Dimensions: 5¹/₄" x 17¹/₈" x 2¹/₂" (13.3x 43.5x 6.35 cm)

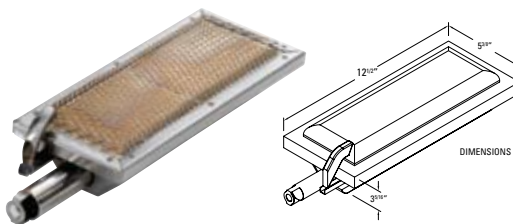

Sear Zone Burner X1

Part Number: BBQ07890P

Dimensions: 12¹/₂" x 5³/₈" x 3⁵/₁₆" (31.7x 13.6x 8.4 cm)

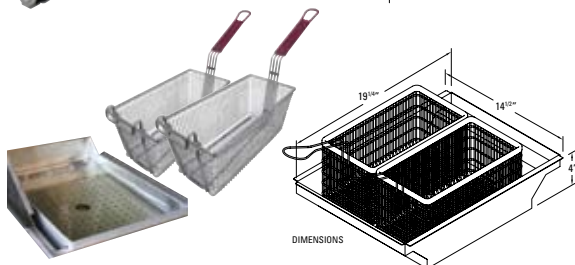

Deep Fryer Helper

Part Number: BBQ09902

Dimensions: 19¹/₄" x 14¹/₂" x 4" (48.9x 36.8x 10.2 cm)

ACCESSORIES

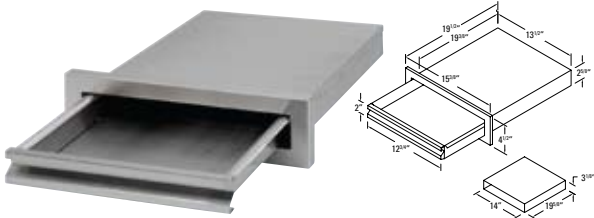

Griddle Tray w/ Storage Part Number: BBQ07862P

Dimensions: 19 1/2" x 13 1/2" x 2 5/8" (49.5x 34.3x 6.7 cm)
C/O Dimensions: 2 7/8" x 13 3/4" x 19 5/8" (7.3x 34.9x 49.8 cm)

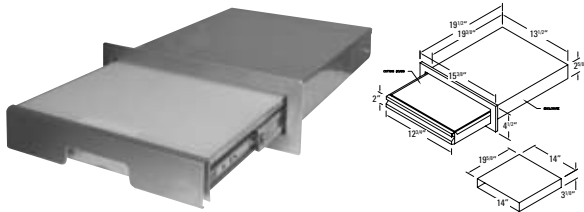

Pull Out Cutting Board Part Number: BBQ07891P

Dimensions: 19 1/2" x 13 1/2" x 2 5/8" (49.5x 34.3x 6.7 cm)
C/O Dimensions: 2 7/8" x 13 3/4" x 19 5/8" (7.3x 34.9x 49.8 cm)

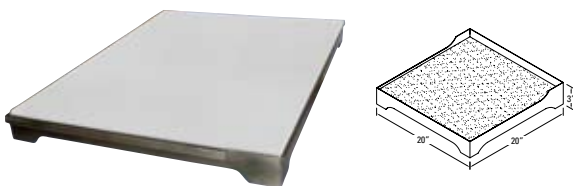

Pizza Brick Tray Part Number: BBQ07900

Dimensions: 20" x 20" x 3" (50.8x 50.8x 7.6 cm)

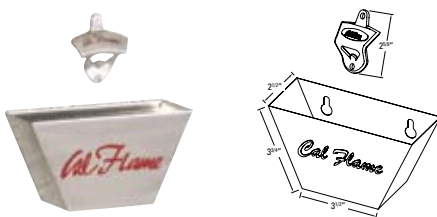

Bottle Opener and Catcher Part Number: BBQ07901

Dimensions:
Bottle Opener: 2 5/8" (6.7 cm)
Catcher: 3 3/4" x 6 3/4" x 2 1/2" (9.5x 17.1x 6.3 cm)



Snake Light Part Number: BBQ08893

Dimensions: TBD
C/O Dimensions: TBD



Cal Flame brings the ultimate outdoor kitchen within your reach. Experience the power, convenience and selection of the very finest in grillware, storage options and refrigeration in your backyard or garden. Install our professional-grade equipment in any outdoor kitchen or in Cal Flame's custom barbecue islands which are designed specifically to complement your Home Resort. Make every morsel a feast and every meal a celebration with Cal Flame.

Free Manuals Download Website

<http://myh66.com>

<http://usermanuals.us>

<http://www.somanuals.com>

<http://www.4manuals.cc>

<http://www.manual-lib.com>

<http://www.404manual.com>

<http://www.luxmanual.com>

<http://aubethermostatmanual.com>

Golf course search by state

<http://golfingnear.com>

Email search by domain

<http://emailbydomain.com>

Auto manuals search

<http://auto.somanuals.com>

TV manuals search

<http://tv.somanuals.com>