



United States and Canada

2008 OWNER'S MANUAL

All Portable Spas

Manufactured after January 14, 2008
© 2008 Lloyds Material Supply, Inc.



Cal Spas Home Resort™



www.calspas.com

Due to our continuous improvement programs, all models, operation, and/or specifications are subject to change without prior notice.

LTR20081000, Rev. D
8/12/08

Read This First!

Important Safety Instructions	1
Basic Spa Information	1

Preparing for Your New Portable Spa

Planning the Best Location	3
Preparing a Good Foundation	3
120 Volt Electrical Installation	4
240 Volt Electrical Installation	4
GFCI Wiring Diagram	7
Gas Heater Hook up	8
Filling and Powering Up Your Portable Spa . .	10

Operating Your Spa

5100, 6200 and 6300 Electronic Control Operation	11
9800 Electronic Control Operation	14
Auxiliary Control Operation	18
Wireless Spa Monitor	18
Adjustable Jets	19
Diverter Knobs	19
Air Venturis	19
Adjustable Therapy System™	20
Multi-Colored Spa Light Operation	20
Aromatherapy	20
Waterfalls	20

Water Quality Maintenance

Cal Spas Clear Water Plan	21
Alternative Sanitation Options	21
Before You Begin	21
Chemical Safety	22

Chemical Descriptions	23
Traditional Chemical Start Up	25
Bromine Clear Water Plan	25
Chlorine Clear Water Plan	26
Ozonator Clear Water Plan	26
Bromine Generator Clear Water Plan	27
Maintenance Schedule	28

Cleaning and Maintenance

Removing and Reseating the Pillows	29
Spa Cover	29
Draining Your Portable Spa	30
Winterizing (Cold Climate Draining)	30
Cleaning the Cover, Shell and Pillows	31
Cleaning and Replacing the Filter	32

Using the Entertainment System

Listening to the Radio	33
Inserting and Ejecting a CD or DVD	33
Playing a CD	34
Raising and Lowering the 20" TV	34
Playing a Movie	34
Using the Universal Remote Control	35
Programming the Universal Remote Control .	36
Using the iPod Docking Station	36

Appendix

Replacement Parts	37
Keeping Fit with your Spa	45
Cal Spas™ Chemicals	47
2008 Warranty	48

CONTACT INFORMATION

For customer service, please contact your authorized dealer immediately. If you need additional information and/or assistance, contact:

LMS Customer Service Department
1462 East Ninth Street
Pomona, CA 91766.

Toll Free: 1-800-CAL-SPAS
Fax: 1-909-629-3890

Copyright 2007-2008 Lloyds Material Supply, Inc. All rights reserved. Duplication without written consent is strictly prohibited.

Cal Spas®, Adjustable Therapy System™, ATSTM, Bio-Clean™, Cal Zone Quest 2000™, Cal Premium™, Cal Select™, Cal Stone™ Ultimate Fitness Spa Series™, and XL Heat Exchanger™ are registered trademarks.

Due to continuous improvement programs, all models, operation, and/or specifications are subject to change without prior notice.

LTR20081000, Rev. D
8/12/08

Read This First!

Important Safety Instructions

When installing and using this electrical equipment, always follow basic safety precautions. Following these instructions will help make your first spa session a pleasurable one.

READ AND FOLLOW ALL INSTRUCTIONS

NOTE: A licensed electrician may be required to upgrade your standard receptacle and/or circuit breaker.

DANGER -- RISK OF ACCIDENTAL DROWNING: Do not allow children to be in or around a spa unless a responsible adult supervises them. Keep the spa cover on and locked when not in use. See instructions enclosed with your cover for locking procedures.

DANGER -- RISK OF INJURY: The suction fittings in this spa are sized to match the specific water flow created by the pump. Should the need arise to replace the suction fittings, or the pump, be sure the flow rates are compatible.

DANGER -- RISK OF INJURY: Never operate the spa if the suction fitting or filter baskets are broken or missing.

DANGER -- RISK OF INJURY: Never replace a suction fitting with one that is rated less than the flow rate marked on the original suction fitting.

DANGER -- RISK OF ELECTRIC SHOCK: Install the spa at least 5 feet (1.5 meters) from all metal surfaces. As an alternative, a spa may be installed within 5 feet of metal surfaces if each metal surface is permanently bonded by a minimum #8 AWG solid copper conductor to the outside of the spa's control box.

DANGER -- RISK OF ELECTRIC SHOCK: Do not permit any external electrical appliances, such as lights, telephones, radios, televisions, and etc., within five feet (1.5 meters) of the spa. Never attempt to operate any electrical device from inside the spa. This does not apply to lights, stereos and televisions that are built into the spa as factory options from Cal Spas™.

WARNING -- RISK OF INJURY

The spa water should never exceed 104°F (40°C). Water temperatures between 100°F (38°C) and 104°F (40°C) are considered safe for a healthy adult. Lower water temperatures are recommended for young children and when spa use exceeds 10 minutes.

High water temperatures have a high potential for causing fetal damage during pregnancy. Women who are pregnant, or who think they are pregnant, should always check with their physician prior to spa usage.

The use of alcohol, drugs or medication before or during spa use may lead to unconsciousness, with the possibility of drowning.

Persons suffering from obesity, a medical history of heart disease, low or high blood pressure, circulatory system problems or diabetes should consult a physician before using the spa.

Persons using medications should consult a physician before using the spa since some medications may induce drowsiness while others may affect heart rate, blood pressure and circulation.

Hyperthermia Danger

Prolonged exposure to hot air or water can induce hyperthermia. Hyperthermia occurs when the internal temperature of the body reaches a level 3°F to 6°F above the normal body temperature of 98.6°F (or 2°C to 4°C above 37°C). While hyperthermia has many health benefits, it is important not to allow your body's core temperature to rise above 103°F (39.5°C). Symptoms of excessive hyperthermia include dizziness, lethargy, drowsiness and fainting. The effects of excessive hyperthermia may include:

- Failure to perceive heat
- Failure to recognize the need to exit spa or hot tub
- Unawareness of impending hazard
- Fetal damage in pregnant women
- Physical inability to exit the spa
- Unconsciousness

WARNING: The use of alcohol, drugs, or medication can greatly increase the risk of fatal hyperthermia.

Basic Spa Information

The following operating and maintenance instructions are very important and must be followed carefully. With the proper care and maintenance, your spa will provide you with years of satisfaction and performance.

Do not be afraid to push buttons or turn knobs to learn about your new spa, as it is built with quality materials and excellent craftsmanship.

Your new spa has been engineered with a high-powered water pump that pushes water through various therapy

Read This First!

jets, which will relax even the tightest muscles. In addition to the water pressure, you can add air into the spa water with air venturi handles located seat-side that increase the intensity of your massage.

The filtering of this spa is very important. It will minimize cleaning time and the amount of chemicals needed to keep your spa water balanced. The two daily pre-programmed filter cycles of two hours in duration can be increased to six hour cycles if the need arises. This can be accomplished through the topside control panel.

IMPORTANT: Keep the spa covered when not in use!

- Covered spas use less electricity while maintaining a set temperature.
- Covering your spa will protect your spa's finish from the sun's ultraviolet rays.
- You are required to keep the spa covered to maintain warranty coverage.
- Covering your spa helps prevent children from drowning in the spa.

Your new spa comes equipped with an electric heater. Following the directions listed below will ensure the most efficient operation:

NOTE: This method is only for spa usage under two hours a week.

- Keep the spa's operating temperature 5°F below the desired usage temperature when not in use. One or two hours before use, set the temperature to the desired temperature.
- If the spa usage exceeds two hours a week, the set temperature should remain at the desired usage temperature.

- The air venturis should be used sparingly. When open, water temperature drops quite rapidly and can also dissipate chemicals.

Allowing the water temperature to lower more than 10°F below the desired usage temperature and reheating it prior to usage will cause the heater to operate longer than it normally would maintaining the desired temperature. Doing this will increase your operating cost and makes your heater work more than necessary.

The filter needs to be cleaned or changed on a regular basis. This process takes only a few minutes and the result is increased water clarity and equipment longevity.

Water level is very important to the operation of your spa. If the water level is too low or too high, your spa will not operate properly. The water level should be to the middle of the skimmer area when the spa is not being used.

We recommend that your spa water be changed every 4 to 6 months. You may find the need to change your spa water more frequently with heavy use. When empty, your spa should be cleaned with a non-abrasive cleaner, such as Cal Spas™ All Surface Cleaner, and then rinsed thoroughly.

See the section "Cleaning and Maintaining Your Spa" for instructions on draining your spa.

When filling your spa, always fill through the skimmer filter canister. Use only regular tap water.

WARNING: DO NOT USE SOFT WATER.

Preparing for Your New Portable Spa

Most cities and counties require permits for exterior construction and electrical circuits. In addition, some communities have codes requiring residential barriers such as fencing and/or self-closing gates on property to prevent unsupervised access to the property by children. Your dealer can provide information on which permits may be required and how to obtain them prior to the delivery of your spa.

Planning the Best Location

Here are some of the things that you will need to consider when determining where to place your new spa.

Safety First

Do not place your spa within 10 feet (3 m) of overhead power lines.

Consider How You Will Use Your Spa

How you intend to use your spa will help you determine where you should position it. For example, will you use your spa for recreational or therapeutic purposes? If your spa is mainly used for family recreation, be sure to leave plenty of room around it for activity. If you will use it for relaxation and therapy, you will probably want to create a specific mood around it.

Plan for Your Environment

If you live in a region where it snows in the winter or rains frequently, place the spa near a house entry. By doing this, you will have a place to change clothes and not be uncomfortable.

Consider Your Privacy

In a cold-weather climate, bare trees won't provide much privacy. Think of your spa's surroundings during all seasons to determine your best privacy options. Consider the view of your neighbors as well when you plan the location of your spa.

Provide a View with Your Spa

Think about the direction you will be facing when sitting in your spa. Do you have a special landscaped area in your yard that you find enjoyable? Perhaps there is an area that catches a soothing breeze during the day or a lovely sunset in the evening.

Keep Your Spa Clean

In planning your spa's location, consider a location where the path to and from the house can be kept clean and free of debris.

Prevent dirt and contaminants from being tracked into your spa by placing a foot mat at the spa's entrance

where the bathers can clean their feet before entering your spa.

Allow for Service Access

Many people choose to install a decorative structure around their spa. If you are installing your spa with any type of structure on the outside, such as a gazebo, remember to allow access for service. It is always best to design special installations so that the spa can still be moved, or lifted off the ground.

Preparing a Good Foundation

Your spa needs a solid and level foundation. The area that it sits on must be able to support the weight of the spa and the occupants who use it. If the foundation is inadequate, it may shift or settle after the spa is in place, causing stress that could damage your spa shell or finish.

Damage caused by inadequate or improper foundation support is not covered by the warranty. It is the responsibility of the spa owner to provide a proper foundation for the spa. We strongly recommend that you have a qualified, licensed contractor prepare the foundation for your spa.

Place the spa on a level foundation (preferably a 4" concrete slab). If you are installing the spa indoors, pay close attention to the flooring beneath it. Choose flooring that will not be damaged or stained.

If you are installing your spa on an elevated wood deck or other structure, consult a structural engineer or a contractor to ensure the structure will support the weight of 150 pounds per square foot.

Your Cal Spas™ retailer can help you with your foundation and more. Your retailer has a wealth of information and experience about how to get the most out of your spa and can provide you with a full line of accessories that are designed to complement your spa and increase your enjoyment.

Preparing for Your New Portable Spa

120 Volt Electrical Installation

Always follow applicable local, state and federal codes and guidelines.

Use only a dedicated electrical line with a 20 amp breaker.

Cord-and-plug connections may not use a cord longer than 15 feet (4.6 m) and must be plugged into a dedicated 20 amp GFCI connection (NEC 680.42(A)(2)). Do not use extension cords!

Always use a weatherproof-covered receptacle.

Receptacle shall be located not less than 5 feet (1.5 m) from and not exceeding 10 feet (3.0 m) from the inside wall of the spa. (NEC 680.43(A))

Do not bury the power cord. If your cord becomes damaged, replace it before next usage.

All 120V spas must have a GFCI. This can be either a 20 amp GFCI receptacle or a 20 amp GFCI cord and plug kit as shown (CKIT110 - P/N ELE09700086).

Test the GFCI plug prior to first use and periodically when the spa is powered. To test the GFCI plug version, follow these instructions. (Spa should already be plugged in and operational.)

1. Press the TEST button on the GFCI. The GFCI will trip and the spa will stop operating.
2. Press the RESET button on the GFCI. The GFCI will reset and the spa will turn back on.

The spa is now safe to use.

If the GFCI trips while the spa is in use, press the RESET button. If the GFCI does not reset, unplug the spa and call your local Cal Spas dealer for service. **DO NOT USE THE SPA!**

240 Volt Electrical Installation

All 240V spas must be permanently connected (hardwired) to the power supply. These instructions describe the only acceptable electrical wiring procedure. Spas wired in any other way will void your warranty and may result in serious injury.

This is the only acceptable electrical wiring procedure. Spas wired in any other way will void your warranty. See the wiring diagram on page 7.

When installed in the United States, the electrical wiring of this spa must meet the requirements of National Electric Code, ANSI/NFPA 70-2008 and any applicable local, state, and federal codes. The electrical circuit must be installed by an electrical contractor and approved by a local building / electrical inspector.

GFCI and Wiring Requirements

The power supplied to the spa must be on a dedicated GFCI protected circuit as required by ANSI/NFPA 70 with no other appliances or lights sharing the power.

Use copper wire with THHN insulation. Do not use aluminum wire.

Use the table on the next page to determine your GFCI and wiring requirements.

When NEC requires the use of wires larger than #6 AWG, install a junction box near the spa and use #6 AWG wire between the junction box and the spa.

Wire runs over 85 feet must increase wire gauge to the next lower number. For example: A normal 50 amp GFCI with four #8 AWG Copper wires run over 85 feet would require you to go to four #6 AWG copper wires.

Read and follow the heater manufacturer's safety and installation instructions prior to installation and operation. Incorrect installation may damage the heater and void its warranty.

Testing the GFCI Breaker

Test the GFCI breaker prior to first use and periodically when the spa is powered. To test the GFCI breaker follow these instructions (spa should be operating):

1. Press the TEST button on the GFCI. The GFCI will trip and the spa will shut off.
2. Reset the GFCI breaker by switching the breaker to the full OFF position, wait a moment, then turn the breaker back on. The spa should have power again.

Preparing for Your New Portable Spa

Spa Model	GFCI Required	Wires Required
All 240V spas (except 6300 control boxes requiring high amperage - see below)	One 50 amp GFCI	Four #8 AWG copper wires
Spas with the 6300 control box (when high amperage is selected on circuit board) SEE CONFIGURATION INSTRUCTIONS ON PAGE 6.	One 60 amp GFCI	Four #8 AWG copper wires
Ultimate Fitness Spas: Fitness 2400 spa with 5.5 kW heater	One 50 amp GFCI	Four #8 AWG copper wires
Fitness 2400 spa with 11 kW heater and Fitness Pro 2500 spa SEE PAGES 6 AND 7 FOR INSTALLATION DIAGRAM.	Service 1: One 60 amp GFCI Service 2: One 30 amp GFCI	Service 1: Four #8 AWG copper wires Service 2: Three #8 AWG copper wires
Fitness Pro 4700 spa SEE PAGES 6 AND 7 FOR INSTALLATION DIAGRAM.	Service 1 (swim side): One 60 amp GFCI Service 2 (swim side): One 30 amp GFCI Service 3 (spa side): One 40 amp GFCI	Service 1: Four #8 AWG copper wires Service 2: Three #8 AWG copper wires Service 3: Four #8 AWG copper wires

Preparing for Your New Portable Spa

Configuring the 6300 Control System

The 6300 control system requires higher power than other 240V systems. Dip switch #10 is factory set in the ON position. This causes the heater to shut off when any pump is running in high speed. To allow the heater to continue operating, dip switch #10 must be set to the OFF position.

To ensure your spa functions properly, ensure the following steps are performed before starting your spa:

- When installing the electrical system, use a 60 amp GFCI. Follow the GFCI wiring diagram on the next page.
- Have your dealer or installer set dip switch #10 to the OFF position on the circuit board as shown at right.

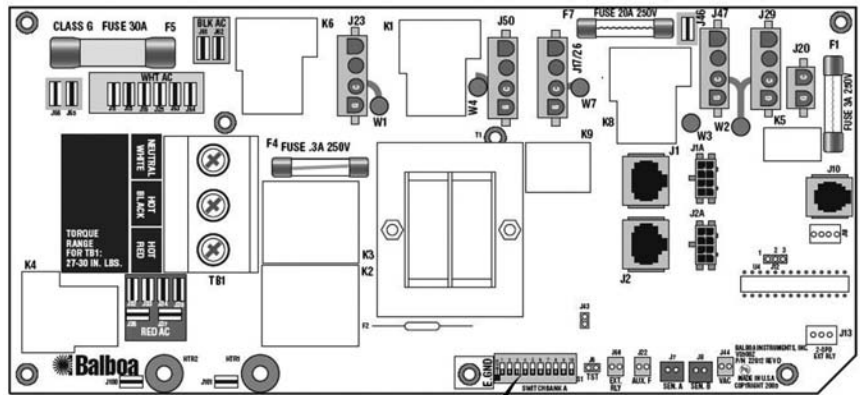

Set dip switch 10 to OFF position

Electrical Installation for 11 kW Heater

This applies to Ultimate Fitness spas with the 11 kW heater only.

Two electrical services are required to heat the swim side of the Fitness Spa.

SOURCE #2
INPUT POWER 30AMPS
3 WIRES
HOT, HOT, GROUND
AWG #8

SOURCE #1
INPUT POWER 60 AMPS
4 WIRES
HOT, HOT, NEUTRAL GROUND
AWG #8

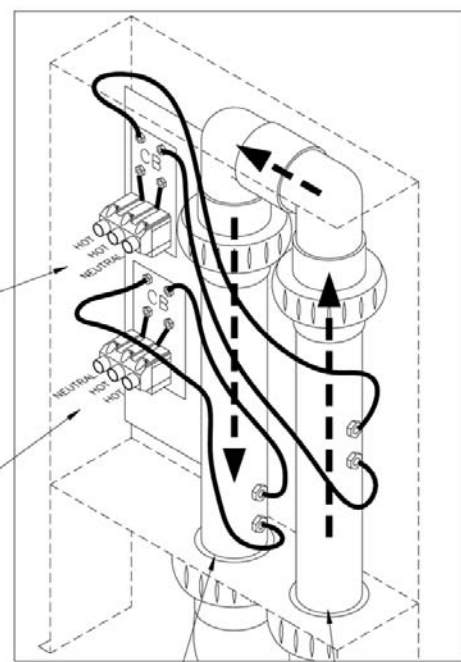

5.5 KW H OUT

5.5 KW H IN

GFCI Wiring Diagram

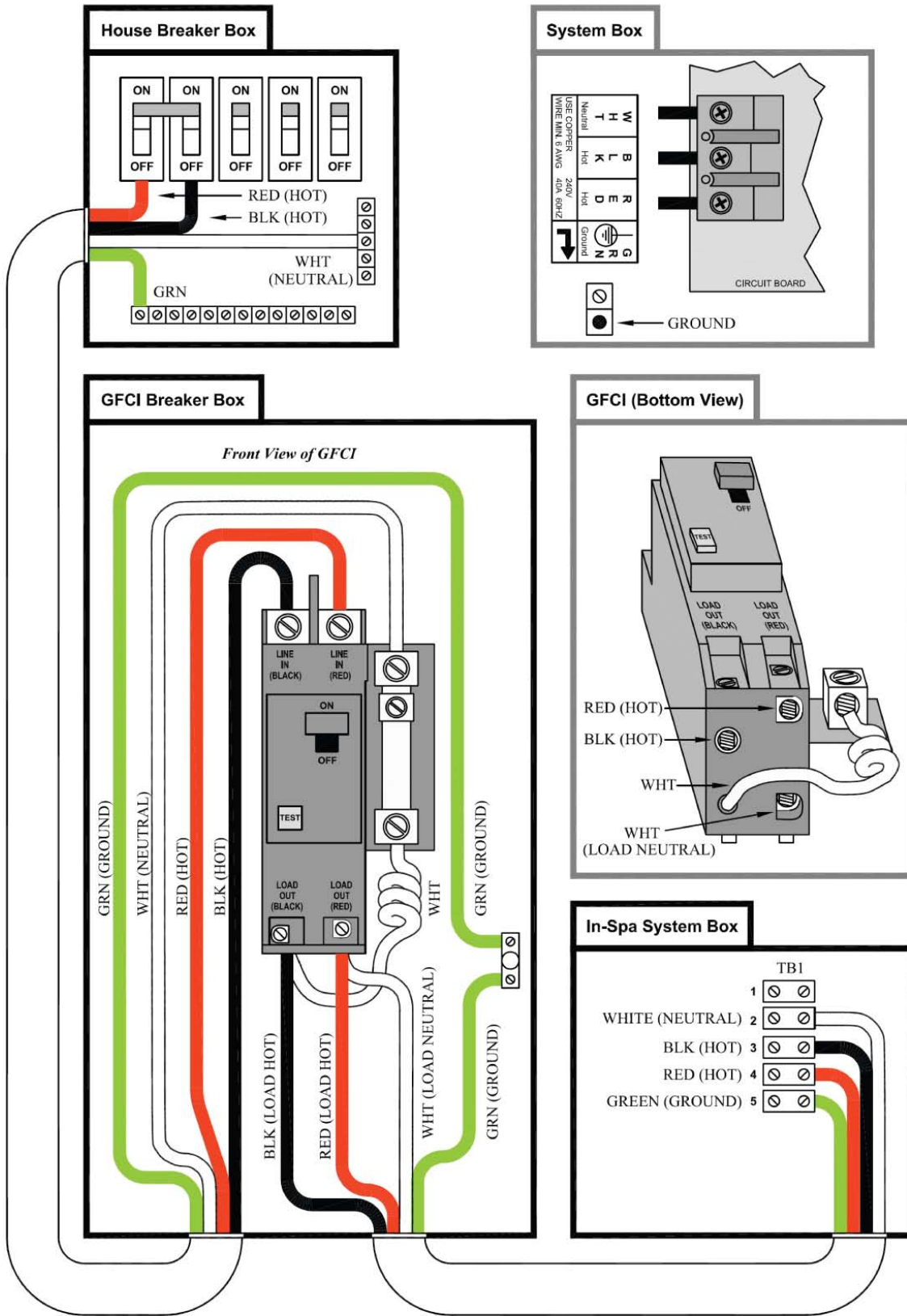

Preparing for Your New Portable Spa

Gas Heater Hook up

Ultimate Fitness Series spa owners may buy and install a separate gas heater and pump for use with their spa. This option may be purchased separately from your local distributor.

Spa owners are responsible for ensuring installation of their gas heater conforms to local, state, and federal regulations. The electrical and gas installation must be performed by contractors and approved by a local building / electrical inspector. Failure to do so may void your warranty.

All Ultimate Fitness Series spas are plumbed with a gas heater ready union located inside the cabinet at either the front or rear, depending on the model. (See the figures below and at right.) Properly installed, they can be attached to an external gas heater. Customers are responsible for creating openings in the panel to accommodate the lines and wiring. The gas heater should be located not less than 10 feet and no more than 25 feet away from the spa.

To connect the plumbing for an external gas heater:

1. Disconnect the ready union.
2. Cut off both sides of the union and discard it.
3. Create two 2½" diameter holes through the spa panel.
4. Use two 2" couplings to connect the hoses to 10' - 15' 2-3/8" diameter PVC lines.
5. Connect PVC lines to the gas heater.

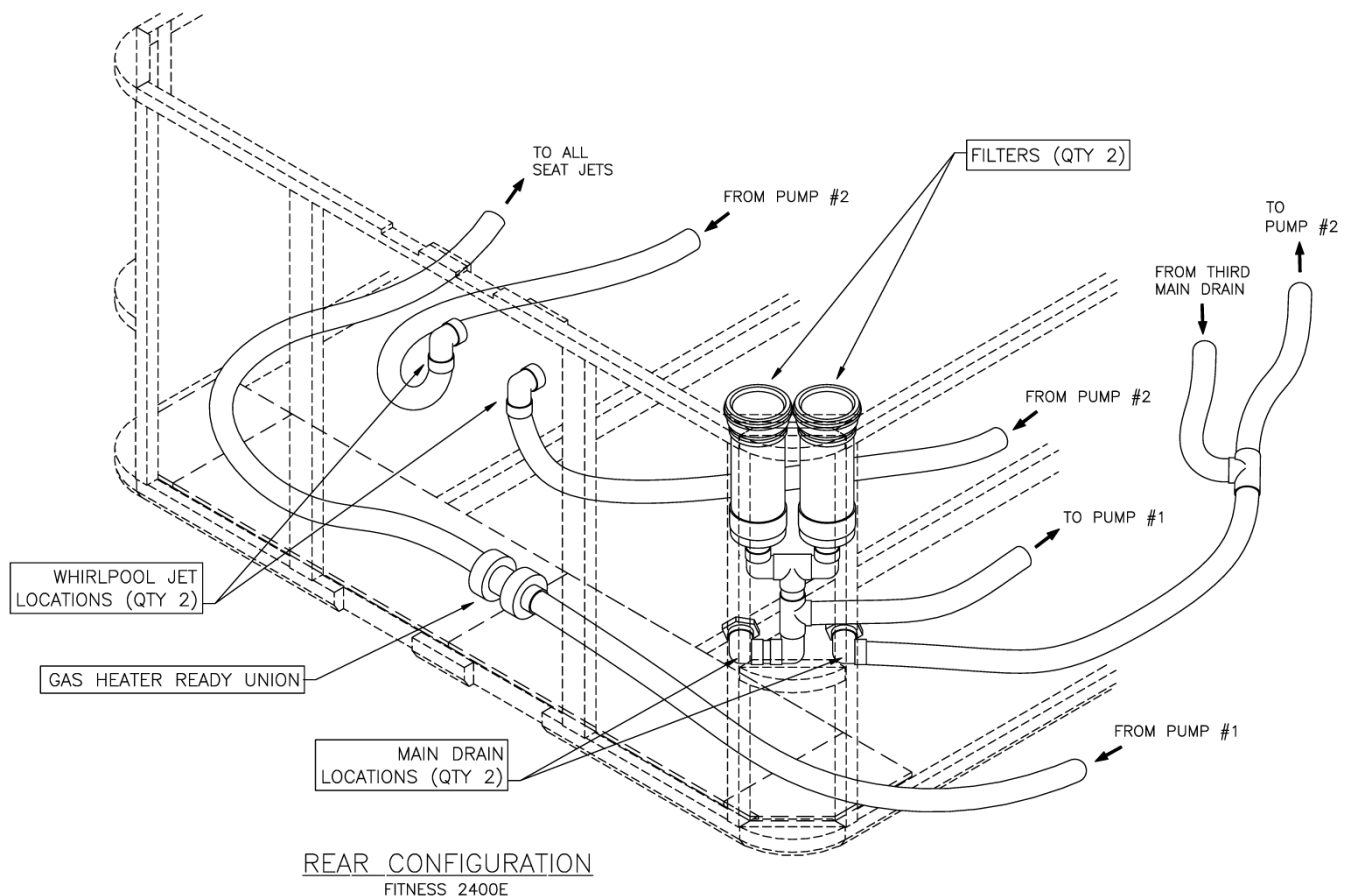

Preparing for Your New Portable Spa

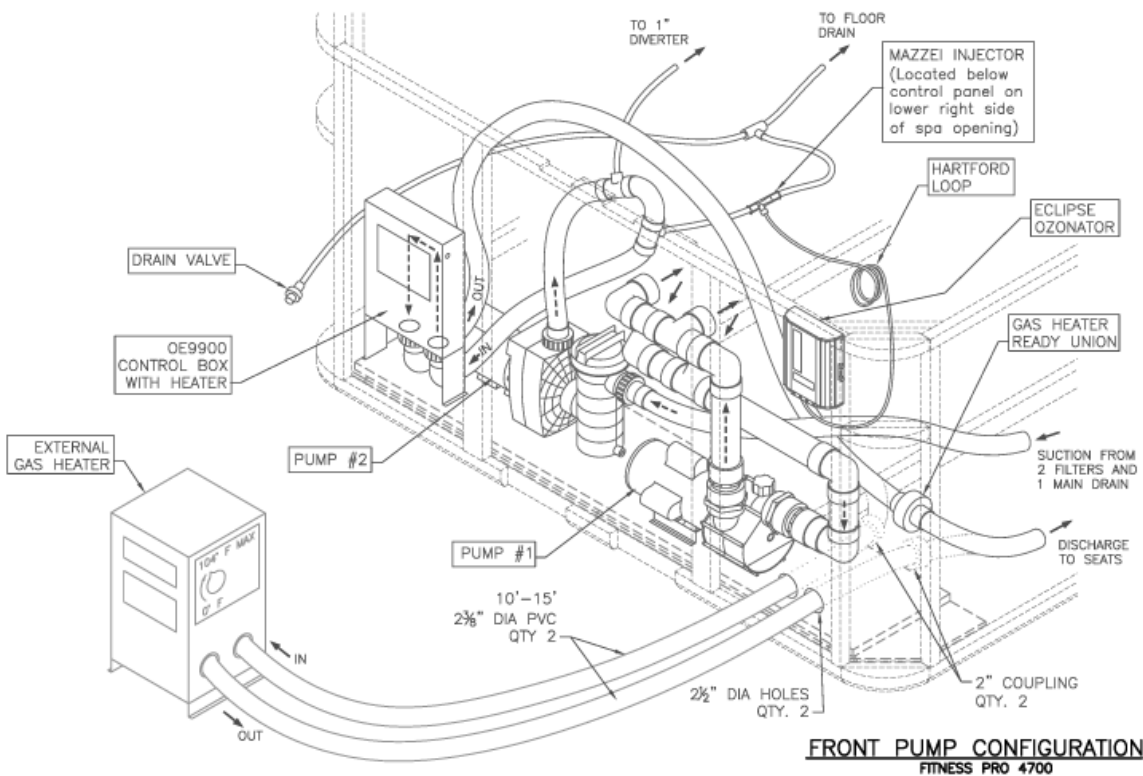
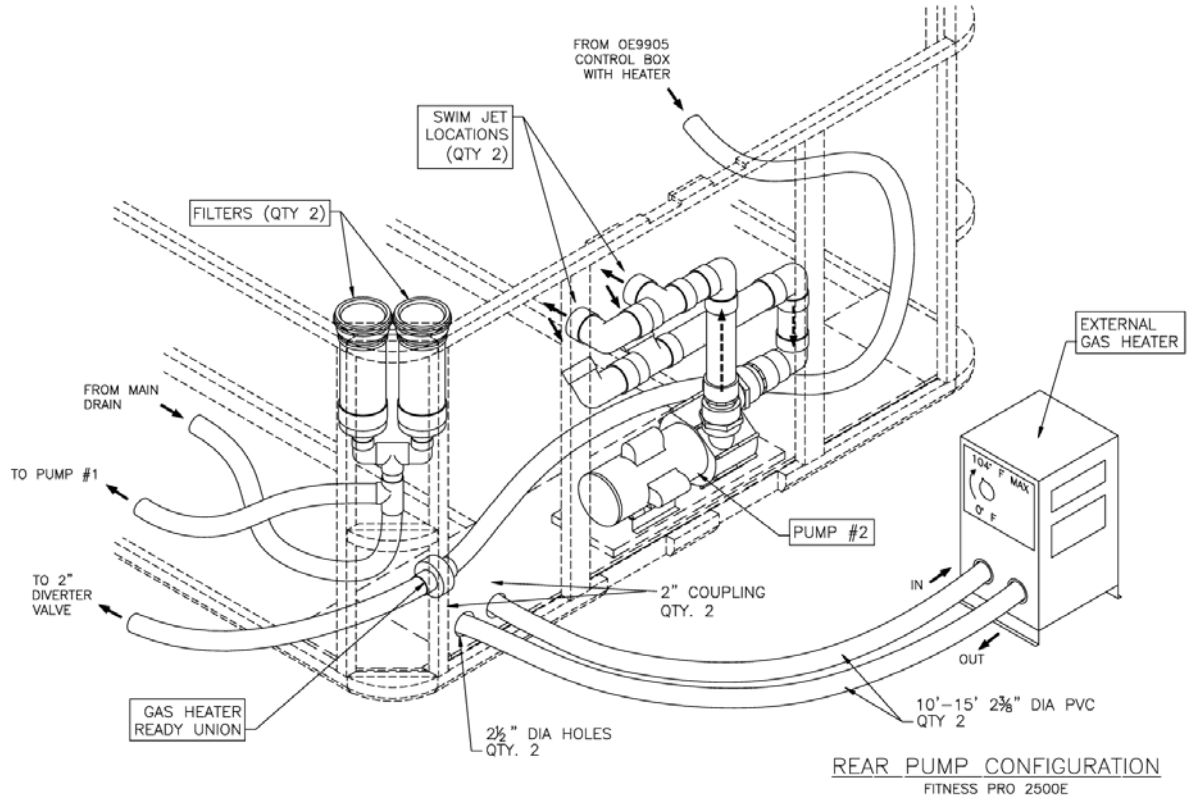

Preparing for Your New Portable Spa

Filling and Powering Up Your Portable Spa



Never fill your spa with soft water.

Soft water makes it impossible to maintain the proper water chemistry and may cause the water to foam, which will ultimately harm the finish of the spa and void your warranty.

1. Once the spa has been placed on an approved surface and has been correctly wired by a licensed electrician, inspect all plumbing connections in the equipment area of your spa. Ensure that these connections are secure and that they did not loosen during shipment.
2. If equipped, open all gate valves in the equipment area. Before operating the spa, these valves must be in the up or "open" position.



VERY IMPORTANT!

Never run the spa with the gate valves closed or without water circulating for long periods of time. Be careful not to over-tighten the plumbing fittings.

3. Remove the filter basket and cartridge from filter canister.
4. Place a garden hose in the skimmer/filter canister and fill your spa with **regular tap water** to the proper water level (halfway up the skimmer area).



VERY IMPORTANT!

Always fill the spa through the filter canister! Failure to do so may cause air to be trapped in the filtration system and prevent the pumps from operating properly.

5. Presoak the filters in spa water.



VERY IMPORTANT!

You must presoak the filters before inserting them in the filter canister. Dry filters can allow air into the filtration system which can cause pump failure.

6. (For owners of the automatic bromine generator) Make sure the dial on the face of the bromine generator unit is turned to the OFF position.
7. Once the water is at the correct level and air is bled, turn on the power at the GFCI breaker. (Ensure that the 120V spas are connected to the proper electrical outlet.)

Note: Depending on the model, when the power is turned on to the spa, the controls will perform a diagnostic check for approximately five minutes. When the diagnostic is complete, the spa will automatically operate at filter speed and continue heating until the spa water temperature reaches the default temperature of 100°F.

8. If no water is flowing when the pump is running, there could be an air pocket at the suction side of the pump. Shut off power to the spa and loosen the pump union on the suction side of the pump to bleed the air. When air is bled, turn power back on.
9. Install the pre-soaked filters and the filter basket into the filter canister.

The spa is now ready for use.

Operating Your Spa

5100, 6200 and 6300 Electronic Control Operation

Initial Start up

When first powered up, it will automatically revert to Priming mode. A **Pr** on the topside display will indicate this. Priming mode will be active for less than five minutes at which time the heater will be activated and the water temperature will be maintained in Standard mode. The spa will heat to 100°F (37.5°C) at start up until the set temperature is changed as described below.

Temperature Adjustment

(Range 80°F to 104°F, 26°C to 40°C)

The 6200 and 6300 electronic control panels display the actual water temperature in degrees Fahrenheit. The displayed temperature will only be current after the pump has been running for at least two minutes.

To display the temperature that the spa is set to:

- Press the **Temp** button. The temperature setting will flash.
- While the display is flashing, each time you press **Temp** button, the set temperature will change up or down one degree.
- If the desired temperature is opposite of the direction each press of the button is making, release button, allow display to stop flashing and then press **Temp** button to change temperature the other direction.

Standard, Economy and Sleep Heating Modes

Your new spa is equipped with a heating feature that gives you complete control of the heating system. When the spa is powered up, it will automatically start in standard heating mode.

- **St** will light briefly on the main display. In this mode, the heating system will automatically maintain the set spa temperature. In the economy-heating mode, the heating system will only activate during filtration times.



- **Ec** will display solid if temperature is not current and will alternate with spa temperature if measured temperature is current.
- Economy mode will heat the water to the set temperature while Sleep mode, indicated by a **SL** on the main display, will also only activate the heater during the filtering cycles but will only heat the water to within 20°F (10°C) of the set temperature. Like Economy mode, **SL** will display solid when temperature is not current and will alternate with actual temperature when it is current.

NOTE: Displayed temperature will only be current after the pump has been running for at least two minutes.

Switching Modes

- Press **Temp** button followed by the **Light** button.
- Press the same sequence to switch to the next mode.

Jets

Press the **Jets** button:

- Once to activate low speed pump.
- Twice to activate high speed.
- Three times to turn pump off.

Operating Your Spa

Light

Press the **Light** button to turn on the light. Press it once again to turn the light off. All optional lighting such as the control panel light and cabinet perimeter lighting is controlled by the **Light** button and will turn on and off with the spa light.

Option

Press the **Option** button to turn on the pump 2. Press it once again to turn off the pump 2 (6200 Controls only).

6300 Controls - Pump 2 and Pump 3 Sequence

- Press **Option** button once to activate high speed pump 2.
- Press **Option** button twice to activate high speed pump 3 and high speed pump 2
- Press 3 times to activate pump 3 hi speed only
- Press 4 times to turn pumps off

Automatic Time outs

These features will automatically turn themselves off during periods of continuous use:

- Low speed pump After 4 hours
- High speed pumps After 15 minutes
- Optional circulation pump After 15 minutes
- Optional turbo After 15 minutes
- Spa light After 15 minutes

Setting Filtration Cycles

Your spa is programmed to filter twice a day. The first cycle will begin 6 minutes after the spa is turned on and the second cycle 12 hours later. The factory has programmed the cycle to last for 2 hours but this can be switched to 4, 6, or 8 hours depending on your requirements. To set filtration time, turn off the power to the spa at the time of day you would like one of the filtration cycles to begin then turn back on after 30 seconds. When power has been restored, press the **Temp** button then the **Jets** button. Press **Temp** button again to change the filtering cycle duration. When desired duration is selected press the **Jets** button to exit.

At the beginning of each filtering cycle the Turbo system will run for approximately 30 seconds. The low speed pump will run for the duration of the filtering cycle and if an Ozone system is installed it will be activated. During filtering, **FC** will appear on the main display.

Diagnostic Messages

Message	Meaning
--	Spa temperature is unknown. After pump has been running for 2 minutes temperature will be displayed.
HH	Overheat protection (spa is shutdown) DO NOT ENTER THE WATER! One sensor has detected 118°F (48°C) at the heater. Remove the spa cover and allow spa to cool below 107°F (42°C). Press any button on the topside display to reset spa. If spa will not reset after spa has cooled, turn off power for approximately 30 seconds and then turn power back on. If display message is repeated then shut the power off to the spa and call your dealer or service organization.
OH	Overheat protection (spa is shutdown) DO NOT ENTER THE WATER! If the spa has reached 110°F (43°C), remove the spa cover to cool the water. At 107°F (42°C), the spa should reset itself. If the spa does not reset, then shut the power off to the spa, wait 30 seconds and restore power to spa. If display message is repeated then shut the power off to the spa and call your dealer or service organization.
IC	A possible ice condition exists within the spa. No action is required, the pump will automatically activate.
SA or Sb	Spa is shut down. Spa has detected that one of the sensors is not operating properly. One of these may display briefly during overheat then disappear when overheat situation has been resolved. Call your dealer or service organization if message does not go away.
Sn	Sensor (Spa is shut down). The high limit or water temperature sensors are not working correctly. Call your dealer or service organization.

HL	A difference in readings between temperature sensors has been detected indicating a possible water flow problem. Make sure spa is filled to proper level and that pumps are primed (water is flowing). Also check to make sure filter cartridges are clean. If message does not reset, call your dealer or service organization.
LF	This will display on the 5th occurrence of the HL message in 24 hours indicating a persistent flow problem. The heater will be shut down but other functions will continue to operate. Follow HL message actions then press any button to reset.
dr	Insufficient water flow through the heater has been detected. Spa will be shut down for 15 minutes. Check water level and fill spa if water level is low. Make sure pumps are primed (water is flowing) and filter cartridges are clean. Press any button to reset or wait 15 minutes and spa will automatically reset. If message does not reset, call your dealer or service organization.
dY	Insufficient water level detected in heater. This will display on the 3rd occurrence of dr message. Follow directions for dr message and press any button to reset spa. Spa will not automatically reset when dY is displayed.
Sf	Safety Suction System (spa is shut down). The display will show Sf as soon as the vacuum switch closes. All functions will turn off and the system will be disabled until a panel button is pressed.
ST	Indicates heater is in standard mode.
Ec	Indicates heater is in economy mode.
SL	Indicates heater is in sleep mode.

Operating Your Spa

9800 Electronic Control Operation

When first powered up, the 9800 electronic system will perform a self-diagnostic check and then it will automatically heat to and maintain a temperature of 100°F (37.5°C) until you change the set temperature as listed in the “Temperature Adjustment” section below.

These instructions will describe features and options that your particular spa may not be equipped with.



Initial Start-up

When your spa is first powered up, it displays some configuration codes and then goes into priming mode (*Pr* will appear on the display panel). This mode lasts up to four minutes and then the spa begins to heat to its pre-programmed temperature of 100°F.

Temperature Adjustment

(Range 80°F to 104°F, 26°C to 40°C)

The start-up temperature is set at 100°F (37.5°C). The last measured temperature is constantly displayed on the control panel. Note that the last measured spa temperature is displayed. The displayed temperature will be updated when the pump has been running for at least two minutes.

Press the “UP” or “DOWN” buttons once to display the set temperature. Each time either button is pressed again, the set temperature will increase or decrease depending on which button is pressed. After three seconds, the control panel will automatically display the last measured spa temperature.

Time

When time hasn't been programmed, the “TIME” icon flashes. To set the time, press the “TIME” button and then the “MODE/PROG” button. Use the “UP” and “DOWN” buttons to adjust time. See the next page for more detailed instructions.

Standard, Economy, Sleep, and Standby Modes

Mode/Prog: This button is used to switch between standard, economy, and sleep modes.

1. Press “MODE/PROG” to enter mode programming.
2. Press the “DOWN” button to cycle through to the desired mode.
3. Press “MODE/PROG” to confirm selection.

Standard Mode: This is programmed to maintain the desired temperature. Note that the last measured spa temperature displayed is current only when the pump has been running for at least two minutes. The “STAND” icon will display until the mode is changed.

Economy Mode: Economy mode heats the spa to the set temperature only during filter cycles. The “ECON” icon will display until the mode is changed. Pressing the “JETS 1” button while in economy mode puts the spa in standard-in-economy mode, which operates the same as standard mode but reverts back to economy mode automatically after one hour. During this time, pressing the “MODE/PROG” button will revert to economy mode immediately.

Sleep Mode: Sleep mode heats the spa to within 20°F (11°C) of the set temperature only during filter cycles. The “SLEEP” icon will display until the mode is changed.

Standby Mode: Pressing “Warm” or “Cool” then “JETS 2” will turn off all spa functions temporarily. This is helpful when changing a filter. Pressing any button resets the spa.

Jets 1

Press the “JETS 1” button once to turn pump 1 on or off and to shift between low and high speeds if equipped. If left running, the low speed turns off after two hours and the high speed turns off after 15 minutes. On non-circulation systems, the low speed of pump 1 runs when the blower or any other pump is on. It may also activate for at least two minutes every 30 minutes to detect the spa temperature and then to heat to the set temperature if needed, depending upon the mode. When the low speed turns on automatically, it cannot be deactivated from the panel; however, the high speed may be started.

Jets 2

Press the “JETS 2” button once to turn pump 2 on or off and to shift between low and high speeds if it is a two-speed pump. If left running, the pump will turn off after 15 minutes.

Option

This is an optional feature. Press the “OPTION” button to turn the optional equipment on and off. If left on, the equipment will automatically turn off after 15 minutes.

Light

Press the “LIGHT” button to turn the spa light on and off and to shift between dim and bright settings if your light is dimmable. On dim, the control panel will show the center circle plus one quarter of the light beams. Half of the light beams will show on medium brightness, and all of the light beams will show on bright.

Invert

Press the “INVERT” button to change the numbers in the display to read upside down. Another press returns the display to the right-side-up position. This enables you to read the display while you are in the spa.

Locking the Panel

To lock the panel:

- Press “TIME”, “JETS 1”, and the “UP” button within three seconds. When locked, the panel will display “LOCK”. All buttons are frozen except the “TIME” button.

To unlock the panel:

- Press “TIME”, “JETS 1” then the “DOWN” button within three seconds.

Setting the Temperature Lock

To activate the temperature lock:

- Press the “UP” or “DOWN” button, “TIME”, “JETS 1”, then the “UP” button within three seconds. The panel will display “TEMP LOCK” when the set temperature is locked.

To unlock the set temperature:

- Press the “UP” or “DOWN” button, “TIME”, “JETS 1”, and then the “DOWN” button.

Circulation Pump

This is an optional feature. The circulation pump will come on when the system is checking temperature, during filter cycles, during freeze conditions, or when another pump is on.

Preset Filter Cycles

There are two filter cycles per day. The start and end times of each cycle are programmable. To program, set the time as instructed above, then press “MODE/PROG” to advance to the next setting (or to exit after the last setting). The default filter cycles are as follows:

- The first filter cycle is automatically activated at 8:00 AM and operates the pump until 10:00 AM. The “FILTER 1” indicator icon will light when filter 1 is running.
- The second filter cycle is automatically activated at 8:00 PM and operates the pump until 10:00 PM. The “FILTER 2” indicator icon will light when filter 2 is running.

The pump and the ozone generator will run during filtration. At the start of each filter cycle, the blower will run on highest speed for 30 seconds to clean out the air channels. The lowest speed of pump 2 and pump 3 will run for five minutes. In the event of power loss or shut down, the time of day will need to be reset for filter cycles to run according to your desired programming.

Clean up Cycle

When the pump or blower is turned on by a button press, a clean-up cycle begins 30 minutes after the pump or blower is turned off or times out. The pump and the ozone generator will run for one hour.

Ozone

This is an optional feature. On most systems, the ozone generator (if installed) runs during filter cycles (except when pump 1 is operating at high speed on a non-circulating system) and during clean-up cycles. On some systems, the ozone generator operates whenever the pump runs. If your system is configured with the optional ozone disable feature, the ozone generator will turn off for one hour any time a function button (“JETS 1”, “JETS 2”, “OPTION” etc.) is pressed.

Freeze Protection

If the temperature sensors detect a drop to 44°F within the heater, the pump automatically activates to provide freeze protection. The equipment stays on until four minutes after the sensors detect that the spa temperature has risen to 45°F or higher. In colder climates, an optional additional freeze sensor may be added to protect against freeze conditions that may not be sensed by the standard sensors. Auxiliary freeze sensor protection acts similarly except with the temperature thresholds determined by the switch and without a four-minute delay in turnoff.

Operating Your Spa

Periodic Reminder Messages

Press the "Mode" button to reset a displayed reminder.

Message	Frequency	Action Required
rPH	Every 7 days	Test and adjust chemical levels per manufacturer's instructions.
rSA	Every 7 days	Test and adjust chemical levels per manufacturer's instructions.
rCL	Every 30 days	Remove, clean, and reinstall filter per manufacturer's instructions.
rtg	Every 30 days	Test and reset GFCI per manufacturer's instructions. Drain and refill spa per manufacturer's instructions.
rdr	Every 90 days	Drain and refill spa per manufacturer's instructions.
rCO	Every 180 days	Clean and condition spa cover.
rCH	Every 365 days	Install New Bio-Clean™ Filter.

Diagnostic Messages

Message	Meaning	Action Required
	No message on display. Power has been cut off to the spa.	The control panel will be disabled until power returns. Spa settings and time of day will be preserved for 30 days with a battery back-up.
OHH	"Overheat" - The spa has shut down. One of the sensors has detected 118°F at the heater.	DO NOT ENTER THE WATER. Remove the spa cover and allow water to cool. Once the heater has cooled, reset by pushing any button. If spa does not reset, shut off the power to the spa and call your dealer or service organization.
OHS	"Overheat" - The spa has shut down. One of the sensors has detected that the spa water is 110°F.	DO NOT ENTER THE WATER. Remove the spa cover and allow water to cool. At 107°F, the spa should automatically reset. If spa does not reset, shut off the power to the spa and call your dealer or service organization.
ICE	"Ice" - Potential freeze condition detected.	No action required. The pumps and the blower will automatically activate regardless of spa status.
Sna	Spa is shut down. The sensor that is plugged into the Sensor "A" jack is not working.	If the problem persists, contact your dealer or service organization. (May appear temporarily in an overheat situation and disappear when the heater cools.)
Snb	Spa is shut down. The sensor that is plugged into the Sensor "B" jack is not working.	If the problem persists, contact your dealer or service organization. (May appear temporarily in an overheat situation and disappear when the heater cools.)
Sns	Sensors are out of balance. If this is alternating with the temperature, it may just be a temporary condition. If the display shows only this message (periodically blinking), the spa is shut down.	If the problem persists, contact your dealer or service organization.
HFL	A substantial difference between the temperature sensors was detected. This could indicate a flow problem.	If the water level is okay, make sure the pumps have been primed. If problem persists, contact your dealer or service organization.

Message	Meaning	Action Required
LF	Persistent low flow problems. (Displays on the fifth occurrence of the HFL message within 24 hours.) Heater is shut down, but other spa functions continue to run normally.	Follow action required for HFL message. Heating capacity of the spa will not reset automatically; you may press any button to reset.
dr	Inadequate water detected in heater.	Check water level in spa. Refill if necessary. If the water level is okay, make sure the pumps have been primed. Press any button to reset.
dry	Inadequate water detected in heater. (Displays on third occurrence of dr message.) Spa is shut down.	Follow action required for dr message. Spa will not automatically reset; you may press any button to reset.
Pr	When your spa is first actuated, it will go into priming mode.	The priming mode will last for up to four minutes and then the spa will begin to heat and maintain the water temperature in the Standard mode.
--F or --C	Temperature unknown	After the pump has been running for two minutes, the temperature will be displayed.
-----	Economy or Sleep mode. Temperature not displayed.	In Economy or Sleep mode, the pump may be off for hours outside a filter cycle. If you wish to see the current spa temperature, either switch to Standard mode or turn Jets1 on for at least two minutes.
BUF	Internal problem detected.	Repair required. Contact your dealer or service organization.
Stby	Pressing a button combination on the user panel has activated Standby Mode.	Press any button to leave Standby Mode and return to normal operation.
SF	Safety Suction.	Spa is shut down. The display will show SF when a vacuum switch closes. All functions will turn off and the system will be disabled until a panel button is pressed.
ST	Indicates heater is in Standard Mode.	None.
Ec	Indicates heater is in Economy Mode.	None.
SL	Indicates heater is in Sleep Mode.	None.

Operating Your Spa

Auxiliary Control Operation

The auxiliary control option is available with the 9800 controls only. It is a small panel with four buttons that control certain spa functions, such as primary or additional jets, TV, or lights. It conveniently puts the control of several spa functions at your fingertips without having to get up.

For operation, see the previous section, "9800 Electric Control Operation".



Auxiliary Panel Configuration	Functions
Standard configuration	JETS 1, JETS 2, LIGHT, OPTION
Spa models with automatic TV	JETS 1, JETS 2, TV, OPTION
Spa models with 3-pump system	JETS 1, JETS 2, JETS 3, OPTION

Wireless Spa Monitor

The wireless spa monitor allows you to monitor and change your spa's activity from a distance. The table below describes each button's function.



Light	Operates spa light and LED mood lighting
Temp	Display or adjust the set temperature control
Jet 1	Turn on or off jet 1
Mode	Switch between Standard, Economy, and Sleep Modes

Adjustable Jets

Almost all of the jets in your spa are adjustable. Rotating the face of an adjustable jet to the left (counterclockwise) will decrease the amount of water flow through the jet. Rotating the face of an adjustable jet to the right (clockwise) will increase the amount of water flow through the jet. (See example shown below.)

Neck jets adjust in the opposite directions (counterclockwise to increase, clockwise to decrease).

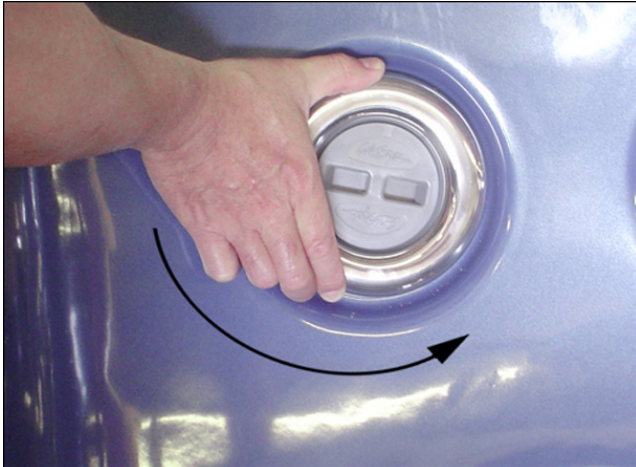

Diverter Knobs

Diverter knobs are 1" and 2" knobs located around the top of your spa. They allow you to divert water through jets from one side of the spa to the other, or in most cases from floor jets to wall jets. This is accomplished by rotating the diverter knob to the left (counterclockwise), decreasing the amount of water flow through a section of jets. To increase the amount of water flow through the other section of jets, rotate the handle to the right (clockwise).



Air Venturis

Air venturis are the 1" knobs located around the top of your spa. Each one will let you add a mixture of air with the jet pressure. This is accomplished by rotating the air venturi knob to the left (counterclockwise) to increase the amount of airflow through the jets. To decrease the amount of airflow through the jets, rotate the handle to the right (clockwise).



Adjustable Therapy System™

Pump On/Off

This button allows the user to turn on and off the ATS™ seat pump. Press this button once to turn the pump on. Once on, the green LED light on the control panel will illuminate, indicating that the system is operational. To turn off the pump, press the “PUMP ON/OFF” button a second time. Note: The pump must be on prior to operating any other features of this system.



Pulse Mode

This button allows the user to turn the ATS™ massage control on and off. Press the pulse button once to turn on the massage control. Once pressed, the orange LED in position number 1 will light, indicating the number one pulse mode. Each press of either the up or down button will move the orange LED up or down to the next pulse mode.

Note: Allow one second between each button press. Pressing the button quickly may cause improper operation. To turn the pulse mode off and return to normal pump operation, press the “PULSE MODE” button a second time.

Up

This button allows the user to cycle up from one through seven massage modes one at a time. Each mode offers a different pulsating massage. Some modes are faster than others, so just cycle through them to find the massage you like best.

Down

This button allows the user to cycle down through all seven massage modes, one at a time.

Time Reset Mode

Pulse mode will normally run for 15 minutes then automatically shut off. For another 15-minute session, press the “PUMP ON/OFF” button and the “PULSE MODE” button. A green LED will blink and the pump will run on high-speed mode as part of a 15-minute cool down period. After that, the pump will stop automatically and the green LED light on the panel will continue to

blink for one minute then shut off automatically. After the second 15-minute session, the system will run through a cool down cycle for up to two hours. In this cool down mode, the user will only be able to operate the pump (by again pressing the “PUMP ON/OFF” button). However, the massage mode will remain off until the cool down mode is completed.

Pulse Mode System

Pulse mode system will shut off for two hours unless reset by the following procedure. During this time the pump will run at a maximum speed.

- In the off position, press the “PULSE MODE” button once.
- The green power light will flash to indicate reset.

Multi-Colored Spa Light Operation

1. Turn the spa light on by pressing the “LIGHT” button on the topside control panel.
2. To filter through the different color choices, press the button on and off. Each time you press the button, you advance to the next color.
3. To turn the spa light off when not in use, press the “LIGHT” button.

Aromatherapy

This optional accessory is very easy to use. Unscrew the cap on the aromatherapy chamber and drop in a bag of scented aromatherapy beads and replace the cap.

Waterfalls

Some spa series include optional waterfalls. When the booster pump is on, turn the knob near the waterfall, or rotate the dial on top of the waterfall. Water will immediately start flowing through it.

Water Quality Maintenance

Cal Spas Clear Water Plan

Great spa water is easily achieved when the right chemicals and / or systems are used and the Cal Spas Clear Water Plan is implemented. The key to clean, clear, and safe water is to fully understand how spa water reacts to users, system operation and chemical use. The Clear Water Plan will help give you that understanding.

The first thing to understand about taking care of your spa water is that preventive actions are much easier to do than correcting water quality issues. For this reason, we offer the Clear Water Plan as a simple, easy to follow guide to clean, safe spa water.

Follow the Right Plan

You will need to decide which chemical plan or alternative sanitation option works best for your spa water. Consult your Cal Spas dealer for the right decision with regards to your lifestyle and spa usage. Whichever plan you decide on, follow it completely and don't take shortcuts. These plans will provide you with clean, safe, clear spa water with a minimum of effort.

Traditional Chemical Options

Choose from either Bromine tablets or Chlorinating granules as your sanitizer of choice. Both work well when the appropriate Clear Water Plan is followed. Make sure you follow all instructions and use only Cal Spas brand chemicals.

Alternative Sanitation Options

Cal Zone Quest 2000 / 3000 Ozonator

This system automatically generates ozone gas and injects it into the spa water. Ozone gas is far superior to chemical bromine or chlorine in sanitizing spa water. Saves replacement chemical cost and guards against forgetting to add chemicals.

Cal Clarity Automatic Bromine Generator

This system automatically generates and releases free bromine into the spa water. No more need to add chemical bromine tablets or chlorine granules. Saves replacement chemical cost and circumvents the need to add chemicals on a regular basis.

Before You Begin

Before you begin a Clear Water Plan, you should understand that chemicals or systems alone will not take care of your spa water. Other factors such as Filtration and Bather Load also play an important part.

Filtration

The filter is the part of your spa that removes the debris from the water. Even though Cal Spas uses the advanced Bio Clean filter cartridge that protects itself from bacterial growth, the filter still needs to be cleaned on a regular basis to maximize your spa's filtering performance and heating efficiency.

In addition to spraying off the filter weekly to remove surface debris, your filter should be deep cleaned periodically to dissolve scale and other contaminants that get lodged deep within the filter fibers and impede the filtration process. Even if the filter looks clean, the contaminants can clog the fibers and prevent water from flowing through the filter resulting in the most common spa problem—no heat, caused by a dirty filter.

Filter Cleaning

- Place the dirty filter into a bucket of water deep enough to cover the filter. Add 8 oz of Cal Spas "Liquid Filter Cleaner" to the bucket of water.

Note: It is a good idea to keep a spare filter to be deep cleaned while the regular filter is in the spa. This way, you can rotate the filters and both will last longer.

- Soak the filter for a minimum of 24 hours.
- Remove the filter and spray clean with a water hose. Spray each pleat carefully.
- Allow filter to dry completely (a minimum of 2 days drying time is recommended).
- Reinstall filter as described in the Clear Water Plan.

Filtration Cycles

The filtration cycle of your spa is the process that allows the water to flow through the filter. Your spa will filter automatically twice each day. The factory set default time for filtration is usually enough for normal use, however heavy bather load or frequent use may require longer filtration times or more frequent filtration cycles to keep the spa water clean. Consult your Owner's Manual for setting your spa's filtration times.

Water Quality Maintenance

Bather Load

“Bather Load” is the term used to describe the number of people using a spa, combined with the length of usage, and the frequency of usage. All these factors have a great effect on the spa water. The higher the bather load, the more chemicals need to be added and a longer filtration time will be needed.

All versions of the Cal Spas Clear Water Plan are designed for spas with average bather load. (3-4 people, 15 minutes of usage, 3 times a week at 100 degrees) If your bather load exceeds these guidelines, and you experience water quality problems, increase the amount of filtration first, (go to the next higher filtration number) then if water quality is still not adequate, consult the advice of your Cal Spas dealer for additional chemical or system recommendations. Be sure to give them your bather load information.

Chemical Overview

The following information is intended for use with Cal Spas chemicals only. Other brands of chemicals may have similar names and/or usage descriptions but due to manufacturing differences, use of other chemicals can increase the likelihood of under- or over-dosing the spa chemicals. Damage to the spa or spa's components from improper chemicals or chemical usage is not covered under the spa's warranty.

Chemical Safety

Failure to follow chemical directions may result in serious injury, sickness, or even death.

Read and follow all printed instructions listed on bottles, packages and in your owner's manual.

Do not exceed chemical dosages as recommended in the Clear Water Plan, or on chemical bottles and packages. (Most chemical instructions are figured for a 500 gallon spa however, most spas hold less than 500 gallons, consult your owner's manual for the approximate gallons of your spa)

Never mix chemicals together.

Never change chemical brands or types without completely draining, flushing and thoroughly cleaning the spa and cover first.

Always protect your eyes while introducing chemicals into the spa. Wear protective eyeglasses to prevent powdered chemicals from blowing into the eyes or liquid chemicals from splashing into the eyes.

In the event of overdosing a sanitizing chemical (chlorine or bromine), immediately turn off the power to the spa and drain water to a safe and approved area. Refill with fresh water and proceed with the Clear Water Plan start up.

Physical Chemical Hazards

Do not allow chemicals to come in contact with skin, eyes or clothing.

Always wear rubber gloves, protective eye wear and clothing to reduce the risk of chemical contact and irritation.

Remove and wash clothing that may have been exposed to chemical contact prior to wearing them again.

Inhaling or ingesting chemicals will cause serious injury, sickness, or even death.

Do not mix chemicals. Mixing chemicals together can cause dangerous chemical reactions including the release of toxic gas, fire and explosions.

Chemical Storage

Chemicals must be stored completely out of the reach of children in an area that is well vented, cool, and dry. Failure to provide a proper area for chemical storage may result in serious injury, sickness, fire explosion and even death. Do not store your chemicals inside the equipment area of your spa.

Chemical Descriptions

The following descriptions and recommendations are intended for use with Cal Spas chemicals only. Many of these chemicals will be used with alternative sanitation systems as well.

For use with any Clear Water Plan



Oxidizer Shock

Destroys ammonia, organic contaminants, and odor causing wastes in spa water.



Iron Out

Helps prevent metals in water from staining spa. Use during start up.



Stain and Scale Defense

Helps prevent minerals from damaging spa components.



Ph / Alkalinity Up

Raises pH and alkalinity levels in spa water.



Ph / Alkalinity Down

Lowers pH and alkalinity levels in spa water.



Liquid Hardness Increaser

Helps reduce foaming and corrosion by increasing hardness levels in spa water.



Spa Brite

Helps to quickly clear up cloudy spa water.



Foam Gone

Quickly breaks up existing foam on spa water.



Filter Cartridge Cleaner

Deep cleans filter cartridge. Dissolves scale and removes imbedded organic contaminants from filter cartridge fibers.



Enzyme Formula

Biodegrades body oils, suntan lotions, and organic contaminants in spa water. Do not use on same day as adding Chlorine Granules.

Water Quality Maintenance

For use with the chlorine Clear Water Plan



Chlorinating Granules

Quick acting sanitizer / disinfectant for spa water.



Test Strips – Chlorine

Provides accurate spa water testing for bromine, pH, and total Alkalinity.

For use with the bromine Clear Water Plan



Test Strips -- Bromine

Provides accurate spa water testing for bromine, pH, and total alkalinity.



Go Brom

Establishes a bromide reserve in spa water. Use during start up.



Brominating Tablets

Long lasting sanitizer / disinfectant for spa water. Add to bromine floater.

For use with the Cal Clarity Bromine Generator



Test Strips -- Sodium Bromide

Provides accurate spa water testing for sodium bromide.

Traditional Chemical Start Up

Prior to filling a spa for the first time, or after a routine draining, you will want to follow this start-up plan to extend water life and performance. If you are following either the Bromine or Chlorine Clear Water Plans, you will notice that both start-up processes are the same with the exception of Step 7. As with all chemical dosages listed in these Clear Water Plans, start-up dosages are intended for 500-gallon spas. Please adjust the chemical dosages to the capacity of your particular spa.

Start Up

1. Clean surface of spa with Cal Spas "Multi-Purpose Cleaner".
2. Apply a protective coat of Cal Spas "Fast Sheen" to the acrylic surface.
3. Fill spa to proper water level with normal tap water. (Do not use soft water.)
4. Use test strip and balance the spa water.
 - Adjust total alkalinity (acceptable range is 80-120ppm).
 - Adjust pH if necessary (between 7.2 to 7.8).
5. Pour in 16 oz of Cal Spas "Metal Protector" in the center of the spa.
6. Add either bromine or chlorine (according to your preferred plan).

Bromine: Add 2 oz of Cal Spas "Go Brom" to establish a bromine base.

Add 2 Cal Spas "Bromine Tablets" to bromine floater.

Set floater opening at #2.

Chlorine: Add two tablespoons of Cal Spas "Chlorine Granules" to the spa water.
7. Sprinkle 2 oz of Cal Spas "Oxidizer Shock" in the center of the spa and turn on jets for 15 minutes. Leave spa uncovered during this time.
8. Put cover on spa and allow to heat up to desired temperature.

Bromine Clear Water Plan

This plan and its chemical dosages are intended for Cal Spas chemicals only. Most chemical manufacturers use different chemical formulas and strengths. Only Cal spas chemicals are specially formulated to provide chemical balance at lower dosages. Always read and follow printed instructions on chemical bottles and packages.

Day One (Monday)

1. Test spa water using "Bromine Test Strips".
2. Based on the test strip readings:
 - Adjust total alkalinity first (acceptable range of 80-120 ppm).
 - Adjust the pH if needed (range is between 7.2 to 7.8).
 - Add Cal Spas "Bromine Tablets" if needed (do not add more than 2).
 - The recommended level of bromine is 3-5 ppm.
3. Add 2 oz of "Stain and Scale Defense".
4. Remove dirty filter from the spa and rinse off. Allow to dry.
5. Place your extra clean filter cartridge back into the spa.
6. Vacuum debris from the bottom of your spa with the spa vacuum.

Day Two (Wednesday)

1. Test spa water using bromine test strips.
2. Based on the test strip reading, adjust total alkalinity, then the pH if needed.

Day Three (Friday)

1. Test spa water using bromine test strips.
2. Based on the test strip reading:
 - Adjust total alkalinity, then the pH if needed.
 - Add one bromine tablet (if needed).
3. Add 2 oz of Cal Spas "Oxidizer Shock" to spa. Run spa for 15 minutes with cover off.
4. Replace cover.

Water Quality Maintenance

Chlorine Clear Water Plan

This plan and its chemical dosages are intended for Cal Spas chemicals only. Most chemical manufacturers use different chemical formulas and strengths. Only Cal Spas chemicals are specially formulated to provide chemical balance at lower dosages. Always read and follow printed instructions on chemical bottles and packages.

Day One (Monday)

1. Test spa water using chlorine test strips.
2. Based on the test strip readings:
 - Adjust total alkalinity (acceptable range of 80-120 ppm).
 - Adjust the pH if needed (range is between 7.2 to 7.8).
 - Add 2 tablespoons of chlorine granules.
 - The recommended level of chlorine is 3-5 ppm.
3. Add 2 oz of "Stain and Scale Defense".
4. Remove dirty filter from the spa and rinse off.

5. Place your extra clean filter cartridge back into the spa.
6. Vacuum debris from the bottom of your spa with the spa vacuum.

Day Two (Wednesday)

1. Test spa water using chlorine test strips.
2. Based on the test strip reading, adjust total alkalinity, then the pH if needed.

Day Three (Friday)

1. Test spa water using chlorine test strips.
2. Based on the test strip reading:
 - Adjust total alkalinity, then the pH if needed.
 - Add 2 tablespoons of chlorine granules (if needed).
3. Add 2 oz of Cal Spas "Oxidizer Shock" to spa. Run spa for 15 minutes with cover off.
4. Replace cover.

Ozonator Clear Water Plan

This plan and its chemical dosages are intended for spas equipped with the optional Cal Zone Quest 2000 / 3000 Ozonator or Del Zone Eclipse Ozonator. The chemical references are designed for Cal Spas chemicals only.

Start Up

1. Follow the spa start up procedures for chlorine Clear Water Plan.
2. Set the spa's filtration time for "F-4". This activates the ozonator and produces the ozone gas. (Follow the instructions in the owner's manual.)

Note: Filtration time may need to be increased with heavy bather load.

Day One (Monday)

1. Test spa water using chlorine test strips. (You will need to use a small amount of chlorine as a supplemental sanitizer)
2. Based on the test strip readings:
 - Adjust total alkalinity (acceptable range of 80-120 ppm).
 - Adjust the pH if needed (range is between 7.2 to 7.8).
 - Add 1 tablespoon of chlorine granules.
 - The recommended level of Chlorine is 1-3 ppm.
3. Add 2 oz of "Stain and Scale Defense".
4. Remove dirty filter from the spa and rinse off.



- Place your extra clean filter cartridge back into the spa.
- Vacuum debris from the bottom of your spa with the spa vacuum.
- Adjust total alkalinity, then the pH if needed.
- Add 1 tablespoon of chlorine granules (if needed).
- Add 2 oz of Cal Spas "Oxidizer Shock" to spa. Run spa for 15 minutes with cover off.

Day Two (Friday)

- Test spa water using chlorine test strips.
- Based on the test strip reading:
 - Replace cover.

Bromine Generator Clear Water Plan

This plan and its chemical dosages are intended for spas equipped with the optional Cal Clarity Automatic Bromine Generator. The chemical references are designed for Cal Spas chemicals only. Note: Following these instructions is very important to ensure proper operation of your Cal Clarity Automatic Bromine Generator.

Start Up

- Clean surface of spa with Cal Spas "Multi-Purpose Cleaner".
 - Apply a protective coat of Cal Spas "Fast Sheen" to the acrylic surface.
 - Fill spa to proper water level with normal tap water. (Do not use soft water.)
 - Use bromine test strip and balance the spa water:
 - Adjust total alkalinity (acceptable range is 80 to 120 ppm),
 - Adjust pH if necessary (between 7.2 to 7.8).
 - Pour in 16 oz of Cal Spas "Metal Protector" in the center of spa.
 - Test for TDS (total dissolved solids).
 - The ideal range is 50 to 300 ppm.
 - TDS must be less than 500 ppm to start with.
 - Phosphate level should be below 200 ppb. Remove phosphates if necessary.
 - Determine the gallon capacity of the spa. Be accurate, because this determines the amount of TRU BLU that will be added. Consult the Cal Spas Pre-delivery Guide for spa gallons.
 - Power up the spa and make sure all the spa's pumps are set to high speed. Turn the dial on the face of the Cal Clarity Bromine Generator to OFF.
 - Sprinkle evenly over the surface of the spa one 2lb bottle of TRU BLU sodium bromide per 100 US gallons (370 liters) of water. Do not add too much!
- Note: Each bottle of TRU BLU will raise TDS / conductivity amount approximately 500 ppm.
- Allow spa to run for 15 minutes so the TRU BLU can dissolve completely before proceeding to the next step.

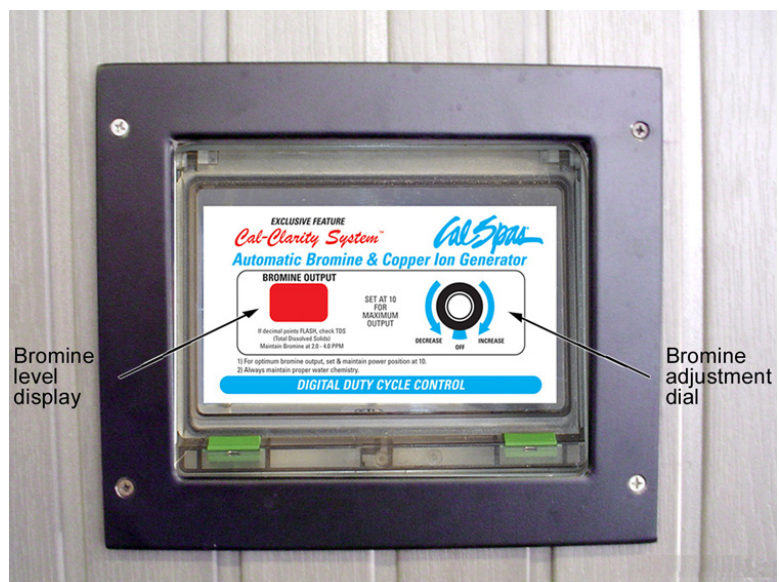

Water Quality Maintenance

12. Use sodium bromide test strips (not bromine) and adjust sodium bromide level to 7.4 to 8.2 (equates to 1700 to 2500 ppm TDS level).
 13. Add 2 oz of Cal Spas "Oxidizer Shock" to help burn out impurities in fill water.
 14. Turn the dial on the bromine generator clockwise until the LED display reads 10.
 15. This will initiate the build up of a bromine bank.
 16. Set the filtration cycle to "continuous" (F-C) for the first 24 hours.
 17. Put the cover on and allow the spa to heat to desired temperature.
3. Once the desired level has been achieved, turn the dial down until a maintenance setting is achieved.
 4. The common maintenance setting for an average bather load is #4.

When changing the setting, use bromine test strips to determine when you have reached the level you want.

Once a Week

Adjusting The Proper Bromine Levels

1. After start up, decrease the filtration cycle to F-4 and monitor the bromine level until it is within the recommended range.
2. Use bromine test strips to achieve a 3-5 ppm recommended level.

Note: It can take several days for the bromine level to stabilize because the fill water that was used sometimes contains contaminants that need to be neutralized, thereby using up the initial bromine that is generated.

1. Test spa water with bromine test strip.
2. Based on test strip readings:
 - Adjust alkalinity if necessary.
 - Adjust pH if necessary.
 - Increase / decrease bromine production with dial if required.
3. Remove dirty filter from the spa and rinse off.
4. Place your clean, extra filter cartridge back into the spa.
5. Add 2 oz of Cal Spas "Oxidizer Shock" to spa. Run spa for 15 minutes
6. Vacuum debris from the bottom of your spa with the "Spa Vacuum".
7. Replace cover.

Maintenance Schedule

Regardless of which Clear Water Plan you are using, you should also do the following:

Every Month

1. Deep clean your spa's filter. (Follow filter cleaning instruction at beginning of Clear Water Plan)
2. Check inside the equipment area for leaks, rodents, and insects.
3. If a leak is discovered, contact your Cal Spas dealer for service.
4. If you see evidence of rodents or insects, take necessary actions to remove them and precautions to prevent them from returning.

Every 3 To 4 Months

1. Drain and clean your spa with "Multi-Purpose Cleaner".

2. Polish the acrylic surface with "Fast Sheen".
3. Clean and treat spa cover, pillows, and Cal Select cabinet (if equipped) with "Cover Protector".
4. When re-filling your spa, follow your specific Clear Water Plan Start Up procedures.
5. If you are using the Cal Clarity Automatic Bromine Generator Clear Water Plan, don't forget to add new TRU BLU sodium bromide to the water.

Once A Year

1. Clean and treat redwood spa cabinets and gazebos with "Nu-Spa Redwood Stain Renew and Brightener".
2. If you use the Cal Zone Quest 2000 Ozonator, you will need to replace the ozone cartridge.
3. Check the filter cartridge pleats. If they are frayed, replace the cartridge.

Cleaning and Maintenance

Removing and Reseating the Pillows

You can remove the pillows for cleaning and maintenance quickly and easily. This method works for all types of pillows.

Grab the lower edge of the pillow with both hands firmly and pull up. As you do this, the pillow inserts will pop out of the holes.

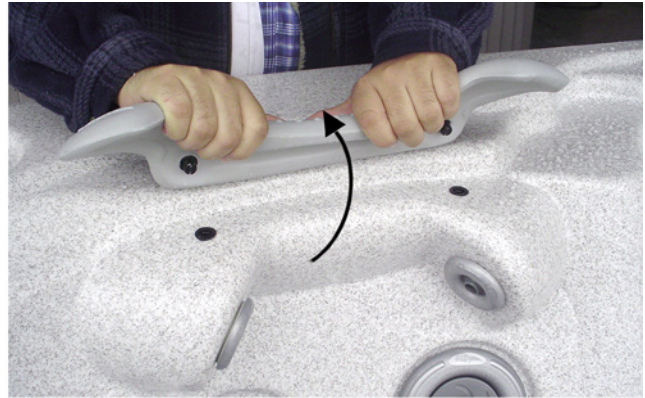

Reseat the pillows by aligning the pillow inserts with the holes and striking the pillow hard enough to insert the pegs back into the holes.



Spa Cover

Important! Keep the spa covered when not in use!

- Covered spas will use less electricity in maintaining your set temperature.
- Covering your spa will protect your spa's finish from the sun's ultraviolet rays.
- You are required to keep the spa covered to maintain warranty coverage.
- Covering your spa helps prevent children from drowning in the spa.

See the manual enclosed with your cover for instructions on mounting the locks and how to lock and unlock the cover.

In addition, while the spa cover is rigid, it is not designed to support any weight. Therefore, as a safety precaution and to preserve the life of your cover, you must not sit, stand, or lie on it; nor should you place objects of any kind on top of it.

Cleaning and Maintenance

Draining Your Portable Spa

Your spa should be drained every four to six months, and refilled with fresh tap water. The following is the recommended method for draining your spa.

1. Turn off the power at the breaker.
2. Remove all filters.

If your drain valve is mounted on the side of the spa cabinet as shown at right, proceed to step 5.

If your drain valve is located inside the spa cabinet:

3. Using a Phillips screwdriver, remove the screws to the access panel and open it.
4. Locate hose ending with the 3/4 inch hose-bib fixture.

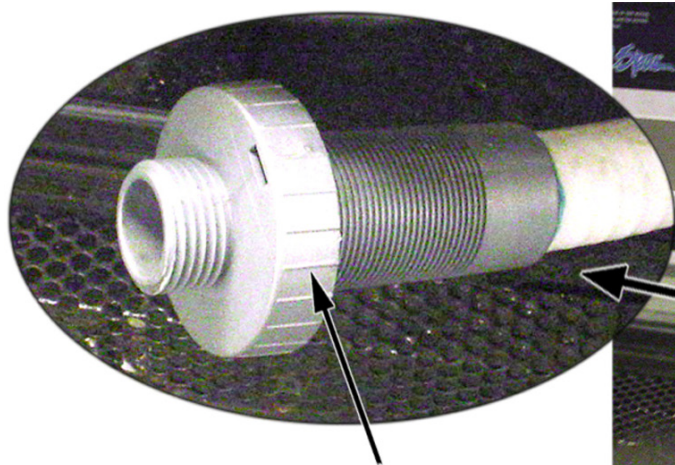

Hose-bib fixture

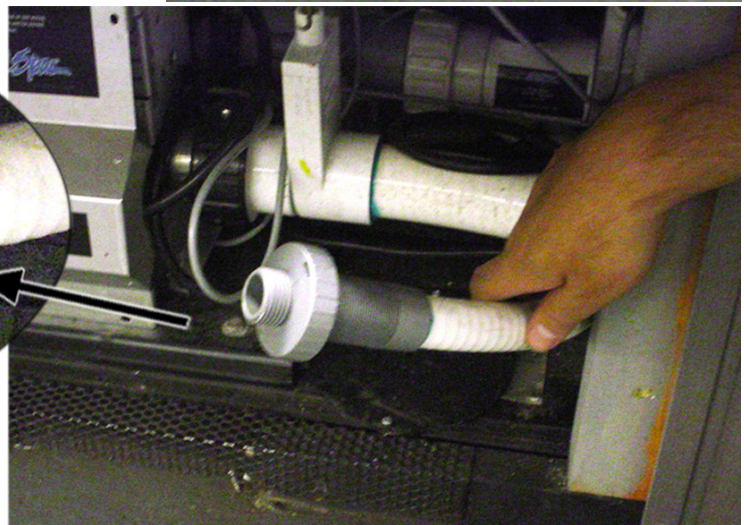

5. Hook up the female end of a garden hose to the drain fitting.
6. Place the other end of the garden hose where you would like the water to drain to.
7. Twist the hose-bib fixture counterclockwise and pull to open the drain.
8. Let spa drain completely, then remove garden hose.
9. Twist the hose-bib fixture clockwise to close it.

Winterizing (Cold Climate Draining)

In many areas of the country, the temperature drops below 32°F (0°C). We recommend that you always have your spa full of water and running at normal spa temperatures (80°F to 100°F, 26.7°C to 37.8°C). This will help reduce the risk of freezing in your spa and your spa's equipment.

Warning: If you find the need to drain your spa, please be aware of the potential of freezing in your spas equipment and plumbing. Even if the directions below are followed perfectly, there is no guarantee that your spa will not suffer freeze damage.

Freeze damage is not covered by your warranty.

1. Open all filter covers.

2. Remove the filter baskets and filters.
3. Drain your spa completely as described in the instructions above.
4. Remove drain plugs from the front of the pumps.
5. Disconnect the unions from both sides of the pump.
6. Use a wet/dry vacuum to blow any remaining water out of the jets and equipment area.

Cover your spa with a good spa cover and an all-weather tarp to ensure that neither rain nor snow enters the spa.

Cleaning the Cover, Shell and Pillows

Due to the constant punishment your spa cover and pillows receive, you should protect them by applying Vinyl and Leather Cleaner as part of your monthly maintenance plan. Cal Spas™ Vinyl and Leather Cleaner is specifically designed to protect spa covers and pillows from chemical and ultraviolet light damage. It accomplishes this without leaving an oily residue behind that is normally associated with common automotive vinyl protectants.

Use of Vinyl and Leather Cleaner

Cal Spas™ Vinyl and Leather Cleaner should be used sparingly. Incorrect usage may cause water clarity issues.

Spa Covers

1. Remove spa cover from spa.
2. Allow spa cover to dry completely.
3. Spray Vinyl and Leather Cleaner to cover evenly and wipe dry.
4. Allow spa cover to dry completely.
5. Reinstall cover on spa.



Pillows

1. Wipe pillows dry with a soft cloth.
2. Carefully spray Vinyl and Leather Cleaner directly onto pillow.
3. Wipe pillows dry.
4. Allow pillows to dry completely.

Warning: Do not use automotive vinyl protectants on spa covers or pillows. These products are generally oil-based and will cause severe water clarity issues that are difficult to correct.

All-Purpose Cleaner (Spa Finish cleaning)

Cal Spas™ All-Purpose Cleaner is an essential part of maintaining your spa's finish. Through normal use, the spa's finish can accumulate dirt, oil, and calcium causing a rough feel and unsightly scum lines. Cal Spas™ All-Purpose Cleaner is a low detergent, non-abrasive cleaner specifically formulated to clean the spa without damaging its acrylic finish.



The most effective solution to minimize cleaning time is prevention. When the following steps are followed, the spa's finish will actually start to resist most of the elements that cause calcium build-up and make scum line clean up easier.

Prior to Spa Start-Up and Refilling

1. Spray Cal Spas™ Multi-Purpose Cleaner directly on to the spa's finish.
2. Wipe clean with a clean soft cloth.
3. Repeat on heavily calcified areas.
4. Wipe spa thoroughly with a wet sponge, rinsing often with a bucket of clean water.
5. Allow spa to dry completely.
6. Apply a coat of Cal Spas™ Fast Sheen to the spa's entire finish with a soft towel or sponge.
7. Allow Fast Sheen to dry until white and powdery.
8. Buff clean with a soft cloth, rotating frequently.

Periodic Maintenance

1. Spray Cal Spas™ Multi-Purpose Cleaner directly to the spa's finish.
2. Wipe clean with a clean soft cloth.
3. Wipe spa thoroughly with a wet sponge, rinsing often in a bucket of clean water.

Cal Spas™ Multi-Purpose Cleaner should not be sprayed directly into the spa water. Incorrect usage of this product will cause water clarity issues.

Fast Sheen (Spa Finish Protecting Wax)

Cal Spas™ Fast Sheen is an essential part of maintaining your spa's finish. Through normal use, the spa's finish can accumulate dirt, oil, and calcium, causing a rough feel and unsightly scum lines. Cal Spas™ Fast Sheen is a non-oil



Cleaning and Maintenance

based wax that is specifically formulated to protect the spa's finish from the chemicals and minerals associated with normal spa use.

The most effective solution to minimize cleaning time is prevention. When the following steps are followed, the spa's finish will actually start to resist most of the elements that cause calcium build-up and make scum line clean-up easier.

Prior to Spa Start-Up and Refilling

1. Spray Cal Spas™ Multi-Purpose Cleaner directly to the spa's finish.
2. Wipe clean with a soft cloth.
3. Repeat on heavily calcified areas.
4. Wipe spa thoroughly with a wet sponge, rinsing often in a bucket of clean water.
5. Allow the spa to dry completely.
6. Apply a coat of Cal Spas™ Fast Sheen to the spa's entire finish with a soft cloth or sponge.
7. Allow Fast Sheen to dry until white and powdery.
8. Buff clean with a soft cloth, rotating frequently.

IMPORTANT: Cal Spas™ Fast Sheen should not be used on spas full of water. Only apply to clean, cool, dry surfaces. Incorrect product usage may cause water clarity issues.

Cleaning and Replacing the Filter

Filtration

Filtration is one of the most important steps you can take to ensure clean, clear water. Regardless of what some people may think, it is far less expensive to fix water clarity problems by filtering your spa than by using excessive amounts of chemicals, excessive filtration times, or by water replacement.

Cal Spas™ filtration system draws contaminated water through the exclusive Bio-Clean™ filter removing debris from the water. It then pumps the newly cleaned water back into the spa through various jets. Spas equipped with the optional Quest 2000 Ozonator will also receive ozone injection into the filtered water for further protection against contaminants during filtration cycles. Filtration also ensures that chemicals are mixed thoroughly through the water, increasing performance.

Filtration starts on electronically controlled spas as soon as the pumps are primed and water flow is steady. As

the flow of water goes through the filter, dirt and debris is removed and accumulated in the filter cartridge. As the filter cartridge accumulates dirt and debris, water flow is restricted and jet performance is reduced. This can cause your spa to not run or heat effectively.

Clean your filter regularly and replace as needed.

Filter Cleaning

Your new spa has been designed for quick and easy filter maintenance. The filter cartridge should be cleaned once a week. These instructions apply to both dual and single filtration systems.

1. Turn the power off at the breaker.
2. Remove the filter by turning it counterclockwise and unscrewing the bottom threads. Then pull it up and out.
3. Clean the filter with a garden hose as follows:
 - a. Hold the filter vertically.
 - b. Spray the filter cartridges with a pressure nozzle, starting from the top and spraying down each pleat.
 - c. Turn the filter cartridge over and repeat Step 3b.
 - d. Deep clean filter cartridge every month. Use only a Cal Spas™-approved filter-cleaning chemical.

Exclusive Bio-Clean™ Filter Cartridge

The filter cartridge is designed to remove dirt, sand, minerals, phosphates, bather waste and other solids from the spa. Unfortunately, some spa owners fail to include filter cleaning as part of their chemical maintenance plan. Filters accumulate debris and become prime areas for bacteria growth.

The Cal Spas™ exclusive Bio-Clean™ Filter is the only antibacterial filter cartridge on the market today. Having a filter cartridge that prevents bacteria growth is added protection for those times you forget to clean the filter. We recommend that you only replace your spa's filter cartridge with a Bio-Clean™ filter cartridge for ensured protection and peace of mind.

Using the Entertainment System

Some spas may be equipped with audio/visual entertainment options. Several options are available and include marine grade CD players, DVD players, and an iPod® docking station. Each spa equipped with an audio/visual system is delivered with the manufacturer's operating instructions in a clear plastic bag.

The instructions contained in this manual describe only basic functions. See the manufacturer's operating instructions for other features and functions. We strongly recommend that you read the manufacturer's instructions prior to operating this unit.

Observe the following precautions for your entertainment system:

- Make sure that hands and CDs / DVDs are dry before coming in contact with this or any electronic option.
- Always close the CD / DVD protective door.
- Do not place wet CD's or DVD's into this unit at any time.
- Water damage is not covered by Cal Spas or the manufacturer's warranty.

Although the marine grade entertainment system is encased in a plastic housing with weather seals, the system is water resistant and NOT waterproof. You must take every precaution to keep this system dry! Water damage is not covered by Cal Spas or the manufacturer's warranty.

WARNING! Although the TV monitor is water resistant, make sure that hands are dry before coming in contact with this or any electronic option. **DO NOT SPLASH WATER ON THE TV MONITOR!**

Listening to the Radio

5. Press the POWER button on the unit or the remote control to turn the system on. The system automatically starts in the mode it was in when it was last shut off.
6. Press the SOURCE or MODE button to switch to the radio mode.
7. Press the left and right arrows located at the far right of the panel to tune the radio to a station.

Inserting and Ejecting a CD or DVD

For the Sony CDX-HS70MW and Aeware systems:

1. Press the OPEN button on the unit. The faceplate will lower and expose the disk drive.
2. Insert a disk in the disk drive.
3. Flip up the faceplate.

To remove the disc, press the OPEN button. The faceplate will open. Press the small EJECT button located to the left of the disk drive slot.

For the Sony CDX-GT10M system, simply insert a disk into the slot in the faceplate. To remove the disc, press the EJECT button.

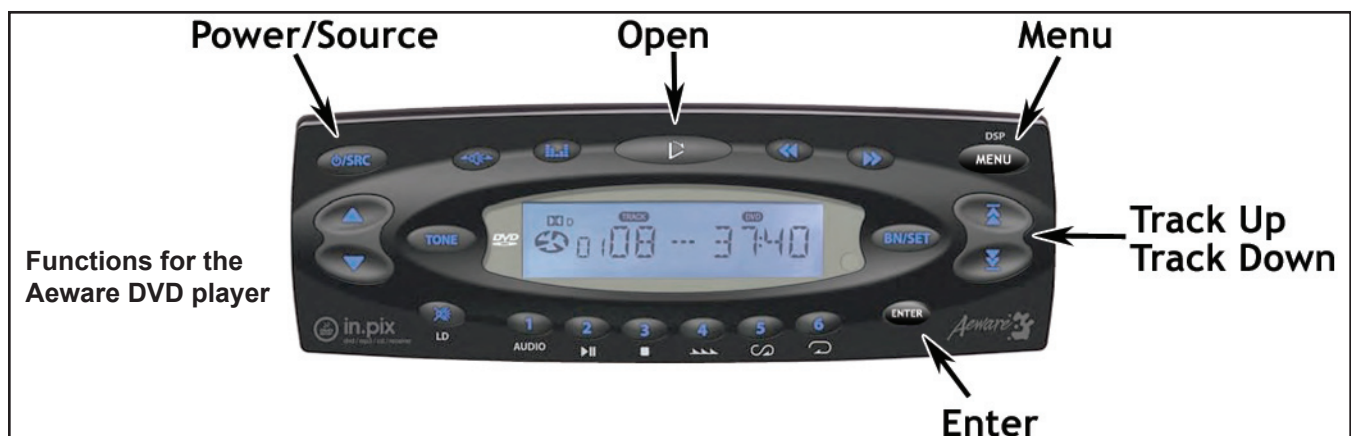

Using the Entertainment System

Playing a CD

You can play CDs with any of the media systems (Sony or Aeware).

1. Insert a disc in the disc drive as described above. The player will identify the type of disc and begin playing it.
2. Use either the remote control or the buttons on the faceplate to start and stop the player and to jump to selections.
3. To remove the disc, press the EJECT button.

Raising and Lowering the 20" TV

Press the TV button on the auxiliary control panel to raise and lower the TV monitor.

- Press the button once to raise the TV.
- Press it again to lower the TV.

Note: Make sure you turn off the TV before you lower it. The TV does not automatically shut off and will remain on while it is in the lowered position unless you turn it off.

Playing a Movie

This applies to the Aeware system only.

Note: The Cal Spas universal remote control requires a direct line of sight between the remote and the CD/DVD player in order to function. The remote will not function when used inside the spa.

1. Press the TV button on the auxiliary control panel to raise the TV monitor.
2. Press the TV function button on the remote control, aim it toward the TV, then press the red POWER button to turn on the TV. The red LED beneath the screen will appear.
3. Press the ENTER button until the message VIDEO appears on the TV screen.
4. Press the VCR/DVD function button.
5. Insert a disc in the DVD player as described above. The disc will begin playing. Either the DVD menu will appear on the TV screen or the movie will begin playing automatically.

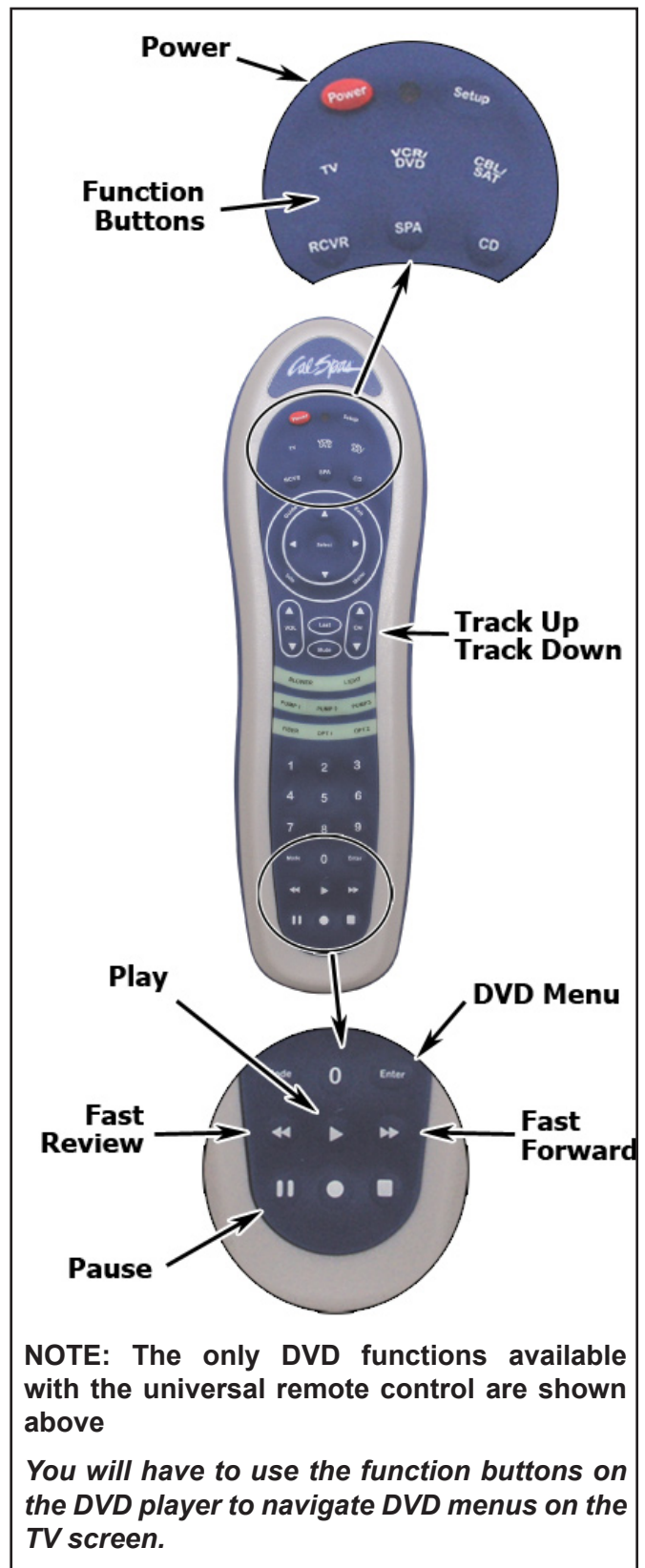

To navigate the DVD menu on the TV screen, press the TRACK UP or TRACK DOWN buttons on the Aeware DVD player (not the remote control). Each time you press one of these buttons, the pointer on the TV screen will move from one selection to the next.

- To confirm a selection, press the ENTER button on the DVD player.
- To play the movie, select the PLAY MOVIE feature on the DVD menu, or press the PLAY button on the remote control.
- To return to the DVD menu, press the MENU button on the DVD player, or press the ENTER button on the remote control.

To remove the disc, press the OPEN button on the DVD player. The faceplate will open. Press the small EJECT button located to the left of the disk drive slot.

Using the Universal Remote Control

The Cal Spas universal remote control requires a direct line of sight between the remote and the CD/DVD player in order to function. The remote will not function when used inside the spa.

The universal remote and control several functions with your entertainment system.

The commands are organized into five areas.

Device selection buttons	Selects the devices to be controlled
Channel and volume control	Adjusts the volume up and down
Spa controls	Selects among eight functions specific to the spa, such as blower, pumps and light
Keypad	Used to enter TV channels
CD and DVD controls	Use to control a CD or DVD player



Using the Entertainment System

Programming the Universal Remote Control

The Cal Spas universal remote has been pre-programmed to function with the entertainment system the spa has been configured with. However, in case you need to reprogram the remote, use the device list below for the programming code.

1. Turn on the device (TV, CD player, DVD player) with the manufacturer's remote control.
2. Press the button on the remote for the device you want to program (TV, CD, DVD, etc.)
3. Press and hold the SETUP button until the LED blinks twice.
4. Enter the device code. If you perform this procedure correctly, the LED will blink twice. If not, repeat steps 2 and 3.

Device Manufacturer	Device Type	Code
Samsung 42" plasma	TV	1312
River Park 20"	TV	1530
Aeware	DVD	1866
Sony CDX-GT10M	CD	
Sony CDX-HS70MW	CD	

Using the iPod Docking Station















To play an iPod from the docking station to the spa's stereo system:

1. Place the iPod in the docking station.
2. Press the SOURCE button on the stereo (if equipped) until the display shows AUX.
3. Play the iPod.
4. Adjust volume using the volume control in the docking station.



Appendix

Replacement Parts

<p>CXLW 6.5" POWER STORM JET DIRECTIONAL</p>   <p>Standard gray PLU21703421</p> <p>Stainless steel PLU21703622</p>	<p>MFRW 3.25", STORM JET, MAXI FLOW W/DRK EYEBALL</p>   <p>Standard gray PLU21703431</p> <p>Stainless steel PLU21703627</p>
<p>CXW 5.5". POWER STORM JET, DIRECTIONAL</p>   <p>Standard gray PLU21703425</p> <p>Stainless steel PLU21703624</p>	<p>MFW 3.25", STORM JET, MICRO FLOW W/DRK EYEBALL</p>   <p>Standard gray PLU21703432</p> <p>Stainless steel PLU21703631</p>
<p>E / EW / EP / EPW INTERNAL CLUSTER STORM, PULSATOR, EURO</p>   <p>Standard gray PLU21703420</p> <p>Stainless steel PLU21703621</p>	<p>MJLW 6.5", POWER STORM JET, DIRECTIONAL</p>   <p>Standard gray PLU21703422</p> <p>Stainless steel PLU21703625</p>
<p>MFLW / MFW 4.25", STORM JET, MAXI FLOW W/ DRK EYEBALL</p>   <p>Standard gray PLU21703430</p> <p>Stainless steel PLU21703630</p>	<p>MJW 5.5", POWER STORM JET, DIRECTIONAL</p>  <p>Standard gray PLU21703423</p> <p>Stainless steel PLU21703600</p>

Appendix

MNW
2.5", NECK JET, QUAD BLASTER



Standard gray
PLU21703427



Stainless steel
PLU21703628

MSRW / MFS
3", STORM JET, MICRO SWIRL W/DRK EYEBALL



Standard gray
PLU21703433



Stainless steel
PLU21703632

SFW
5.5", POWER STORM JET, SURE-FLO



Standard gray
PLU21703426



Stainless steel
PLU21703626

S / SJW / SJ
5", POWER STORM JET W/DRK EYEBALL



Standard gray
PLU21703429



Stainless steel
PLU21703429

SW
STREAM (SWIM) JET COMPLETE



PLU21700565

SXW
5.5", POWER STORM JET, SWIRLEY



Standard gray
PLU21703424



Stainless steel
PLU21703623

TW
4.75", POWER SWIM JET TORNADO



Standard gray
PLU21703428



Stainless steel
PLU21703629

W
WHIRLPOOL

Standard gray
PLU21703122

OZONE INJECTOR JET



Standard gray
PLU21700818

DIRECTIONAL JET EURO



Stainless steel
PLU21703643

AIR INJECTOR CAP



Stainless steel
FIX12500050

Valves

PLU21300052	DIVERTER VALVE 1" (2 WAY) SILVER, TEARDROP HANDLE (2 TONE)
PLU21300062	DIVERTER VALVE 2" (2 WAY) SILVER, TEARDROP HANDLE (2 TONE)
PLU21700378	VENT, 1" AIR CONTROL SILVER, TEARDROP (2 TONE)
PLU21700637	AROMATHERAPY CHAMBER AND CAP

Pillows

ACC01400884	QUAD BLASTER PILLOW
ACC01400874	NECK JET/ BLASTER PILLOW
ACC01400864	STD PILLOW, #965 RECTANGULAR
ACC01400886	PILLOW, VX
ACC01400479	PILLOW, FLOATING, GREY
ACC01400481	BOOSTER SEAT, GREY

Drains

PLU21400132	MAIN DRAIN, SUPER HI FLO SUCTION 2" SILVER
PLU21400155	HEAT RETURN
PLU21400197	BOTTOM DRAIN STAR SUCTION COVER
PLU21400065	HI FLO SUCTION SILVER 1 1/2"-
PLU21400195	BOTTOM DRAIN OZONE FITTING-
PLU21400196	BOTTOM DRAIN WALL FITTING-
OZO18300005	BOTTOM DRAIN-FILTRATION RETURN ASSY

Waterfalls

PLU21800618	WATERFALL SILVER
PLU21800611	WATERFALL SILVER, 4 PORT LED
PLU21800700	WATERFALL SILVER W/4" SLOT CLEAR FACE
PLU21800730	WATERFALL SILVER W/9" SLOT CLEAR FACE
PLU21800642	POP-UP WATERFALL
PLU21800800	WATERFALL SILVER AQUA SPRING 11"

Lights

LIT16100153	WALLFITTING, CLEAR LENS CAP, JUMBO SPA LIGHT, 5"
LIT16000151	LIGHT MINI 2-1/2 DIA
LIT16100155	RED LENS INSERT, JUMBO SPA LIGHT
LIT16100156	BLUE LENS INSERT, JUMBO SPA LIGHT,

Appendix

Filters

FIL11100190	FILTER CARTRIDGE, 50 SQ FT. ANTI-BACTERIAL RED
FIL11100191	FILTER CARTRIDGE, 75 SQ FT. ANTI-BACTERIAL WHITE
FIL11100193	FILTER CARTRIDGE, 35 SQ FT. ANTI-BACTERIAL WHITE
FIL11100125	FILTER CARTRIDGE CAL 75 SQ FT 10 1/16 X 15 1/6 (REMOTE EQUIPMENT)
FIL11703200	FILTER CARTRIDGE 75 SQ FT ANTI-BACTERIAL SCREW-IN
FIL11100200	FILTER CARTRIDGE, 50 SQ FT. ANTI-BACTERIAL WHITE, SCREW-IN

Pumps

PUM22000951	PUMP, 5.0 HP 2 SP SWITCHLESS, DBL SEAL 240V
PUM22000941	PUMP 6.0 HP 2SP 145T DBL SEAL, SWITCHLESS 2" 240V
PUM22000031	PUM 1.5 HP 2 SP 2" WET END 120V - 56 FRAME SWITCHLESS
PUM22000916	PUMP DUALY, DBL SEAL SWITCHLESS 2" ULTIMA-240V
PUM22000952	PUMP 1.0 HP ATS – 240V
PUM22200051	PUMP, 1.5 BHP DUALY GE-56 FRAME, DBL SEAL-120V
PUM22000977	24 HOUR FILTRATION PUMP ASSEMBLY 240V
PUM22100944	SPA CAL FILTRATION CIRC PUMP 240V
BLO05000085	BLOWER W/CORD COMPLETE 1.5 HP 240V 3.5 AMPS
PLU21100160	CHECK VALVE 1 ¼ lb.
	1.5 HP 2 SP 48 FRAME

LED Lights

LIT16100179	SMALL CONTROLLER DAISY CHAIN
LIT16100183	2' DAISY CHAIN JUMPER
LIT16100208	SILICONE O-RING FOR LENS
LIT16100209	OVERMOLD ADAPTER FOR SMALL CONTROLLER
LIT16100211	QUAD LED DAISY CHAIN ASSEMBLY
LIT16100212	DUAL LED DAISY CHAIN ASSEMBLY
LIT16100214	7 LED 2" LIGHT DAISY CHAIN WITH STAND-OFF
LIT16100215	FACETED BULLET LENS, POLYCARBONATE, UV STABLE

Cover Lifts

ACC01600116	COVER LIFT KIT, BOTTOM MOUNTING
ACC01600117	COVER LIFT ADJUSTABLE(top mount)

Hand Rails

FIX12400002	SWIVEL HAND RAIL
FIX12400003	SWIVEL HAND RAIL (BLACK)

Replacement Cabinet Panels

The complete selection of replacement cabinets for all models is very extensive and too lengthy for this owner's manual. See your Cal Spas deal to order replacement panels for your spa, or call 1-800-CAL-SPAS.

Covers

Avalon Series	
A515/A526/A534 - 84 x 64	
Standard Rust	ACC01200460
Standard Gray	ACC01200461
Standard Slate	ACC01200464
Standard Palomino	ACC01200466
Deluxe Rust	ACU02200500
Deluxe Gray	ACU02200501
Deluxe Slate	ACU02200502
Deluxe Palomino	ACU02200499
A726 / A734 / A744 - 84 x 84	
Standard Rust	ACC01200410
Standard Gray	ACC01200411
Standard Slate	ACC01200412
Standard Palomino	ACC01200419
Deluxe Rust	ACU02200250
Deluxe Gray	ACU02200251
Deluxe Slate	ACU02200256
Deluxe Palomino	ACU02200257
A826 / A834 / A844 / A857 - 93 x 93	
Standard Rust	ACC01200420
Standard Gray	ACC01200421
Standard Slate	ACC01200422
Standard Palomino	ACC01200423
Deluxe Rust	ACU02200260
Deluxe Gray	ACU02200261
Deluxe Slate	ACU02200266
Deluxe Palomino	ACU02200267
A969L - 93 x 130	
Standard Rust	ACC01200450
Standard Gray	ACC01200451
Standard Slate	ACC01200452
Standard Palomino	ACC01200454
Deluxe Rust	ACU02200290
Deluxe Gray	ACU02200291
Deluxe Slate	ACU02200295
Deluxe Palomino	ACU02200289

Classic / Legacy Series	
CLASSIC / LEGACY ATLANTIC, BEL AIR, MALIBU - 93 x 93	
Standard Rust	ACC01200420
Standard Gray	ACC01200421
Standard Slate	ACC01200422
Standard Palomino	ACC01200423
Deluxe Rust	ACU02200260
Deluxe Gray	ACU02200261
Deluxe Slate	ACU02200266
Deluxe Palomino	ACU02200267
Custom Teal	ACU02200262
Custom Navy	ACU02200263
Custom Hunter	ACU02200264
CLASSIC / LEGACY DEL MAR - 93" OCTAGON	
Standard Rust	ACC01200434
Standard Gray	ACC01200435
Standard Slate	ACC01200436
Standard Palomino	ACC01200433
Deluxe Rust	ACU02200277
Deluxe Gray	ACU02200278
Deluxe Slate	ACU02200279
Deluxe Palomino	ACU02200276
Custom Teal	ACU02200287
Custom Navy	ACU02200288
Custom Hunter	ACU02200298
CLASSIC/LEGACY EL GRANDE - 96 x 135	
Standard Rust	ACC01200440
Standard Gray	ACC01200441
Standard Slate	ACC01200444
Standard Palomino	ACC01200445
Deluxe Rust	ACU02200280
Deluxe Gray	ACU02200281
Deluxe Slate	ACU02200285
Deluxe Palomino	ACU02200286
Custom Teal	ACU02200282
Custom Navy	ACU02200283
Custom Hunter	ACU02200284

Appendix

CLASSIC/LEGACY NEWPORTER - 93 x 130	
Standard Rust	ACC01200450
Standard Gray	ACC01200451
Standard Slate	ACC01200452
Standard Palomino	ACC01200454
Deluxe Rust	ACU02200290
Deluxe Gray	ACU02200291
Deluxe Slate	ACU02200295
Deluxe Palomino	ACU02200289
Custom Teal	ACU02200296
Custom Navy	ACU02200297
Custom Hunter	ACU02200299
CLASSIC/LEGACY LAGUNA - 64 x 84	
Standard Rust	ACC01200460
Standard Gray	ACC01200461
Standard Slate	ACC01200464
Standard Palomino	ACC01200466
Deluxe Rust	ACU02200500
Deluxe Gray	ACU02200501
Deluxe Slate	ACU02200502
Deluxe Palomino	ACU02200499
Custom Teal	ACU02200503
Custom Navy	ACU02200504
Custom Hunter	ACU02200505
CLASSIC / LEGACY PACIFICA, TROPICAL - 84 X 84	
Standard Rust	ACC01200410
Standard Gray	ACC01200411
Standard Slate	ACC01200412
Standard Palomino	ACC01200419
Deluxe Rust	ACU02200250
Deluxe Gray	ACU02200251
Deluxe Slate	ACU02200256
Deluxe Palomino	ACU02200257
Custom Teal	ACU02200252
Custom Navy	ACU02200253
Custom Hunter	ACU02200254
CLASSIC/LEGACY VENICE - 84 x 93	
Standard Rust	ACC01200462
Standard Gray	ACC01200463
Standard Slate	ACC01200465
Standard Palomino	ACC01200467
Deluxe Rust	ACU02200510
Deluxe Gray	ACU02200511

Deluxe Slate	ACU02200512
Deluxe Palomino	ACU02200509
Custom Teal	ACU02200513
Custom Navy	ACU02200514
Custom Hunter	ACU02200515
Designer Series	
DIJ-401 - 93" ROUND	
Deluxe Rust	ACU02200310
Deluxe Gray	ACU02200311
Deluxe Slate	ACU02200315
Deluxe Palomino	ACU02200316
Deluxe Teal	ACU02200312
Deluxe Navy	ACU02200313
Deluxe Hunter	ACU02200314
DIJ-402 - 93" OCTAGON	
Deluxe Rust	ACU02200330
Deluxe Gray	ACU02200331
Deluxe Slate	ACU02200332
Deluxe Palomino	ACU02200329
Deluxe Teal	ACU02200333
Deluxe Navy	ACU02200334
Deluxe Hunter	ACU02200335
DIJ-403 - 93 x 93	
Deluxe Rust	ACU02200550
Deluxe Gray	ACU02200551
Deluxe Slate	ACU02200552
Deluxe Palomino	ACU02200553
Deluxe Teal	ACU02200554
Deluxe Navy	ACU02200555
Deluxe Hunter	ACU02200556
DIJ-404 - 93 x 130	
Deluxe Rust	ACU02200339
Deluxe Gray	ACU02200343
Deluxe Slate	ACU02200344
Deluxe Palomino	ACU02200338
Deluxe Teal	ACU02200345
Deluxe Navy	ACC02200346
Deluxe Hunter	ACC02200347

DIJ-405 - 93 x 130	
Deluxe Rust	ACU02200540
Deluxe Gray	ACU02200541
Deluxe Slate	ACU02200542
Deluxe Palomino	ACU02200543
Deluxe Teal	ACU02200544
Deluxe Navy	ACU02200545
Deluxe Hunter	ACU02200546
DIJ-406 - 80 x 120	
Deluxe Rust	ACU02200340
Deluxe Gray	ACU02200341
Deluxe Slate	ACU02200348
Deluxe Palomino	ACU02200356
Deluxe Teal	ACU02200349
Deluxe Navy	ACU02200516
Deluxe Hunter	ACU02200517
DIJ-407 - 93 x 200	
Deluxe Rust	ACU02200300
Deluxe Gray	ACU02200301
Deluxe Slate	ACU02200305
Deluxe Palomino	ACU02200306
Deluxe Teal	ACU02200302
Deluxe Navy	ACU02200303
Deluxe Hunter	ACU02200304
Fitness Series	
F2400 - 96 x 169	
Deluxe Rust	ACU02200420
Deluxe Gray	ACU02200421
Deluxe Slate	ACU02200422
Deluxe Palomino	ACU02200423
Custom Teal	ACU02200424
Custom Navy	ACU02200425
Custom Hunter	ACU02200426
FP2500 - 93 x 206	
Deluxe Rust	ACU02200400
Deluxe Gray	ACU02200401
Deluxe Slate	ACU02200402
Deluxe Palomino	ACU02200406
Custom Teal	ACU02200403
Custom Navy	ACU02200404
Custom Hunter	ACU02200405

FP4700 - 96 x 202	
Deluxe Rust	ACU02200407
Deluxe Gray	ACU02200408
Deluxe Slate	ACU02200409
Deluxe Palomino	ACU02200410
Custom Teal	ACU02200411
Custom Navy	ACU02200412
Custom Hunter	ACU02200413
Family Series	
FII510/20R - 78" ROUND	
Standard Rust	ACC01002600
Standard Gray	ACC01002601
Standard Slate	ACC01002602
Standard Palomino	ACC01002603
FII515B - 54 x 78	
Standard Rust	ACC01200370
Standard Gray	ACC01200371
Standard Slate	ACC01200373
Standard Palomino	ACC01200374
Deluxe Rust	ACU02200210
Deluxe Gray	ACU02200211
Deluxe Slate	ACU02200216
Deluxe Palomino	ACU02200217
Deluxe Teal	ACU02200212
Deluxe Navy	ACU02200213
Deluxe Hunter	ACU02200214
FII530 - 84 x 64	
Standard Rust	ACC01200460
Standard Gray	ACC01200461
Standard Slate	ACC01200464
Standard Palomino	ACC01200466
Deluxe Rust	ACU02200500
Deluxe Gray	ACU02200501
Deluxe Slate	ACU02200502
Deluxe Palomino	ACU02200499
Deluxe Teal	ACU02200503
Deluxe Navy	ACU02200504
Deluxe Hunter	ACU02200505

Appendix

FII730B/L, FII745B/L - 84 x 84	
Standard Rust	ACC01200410
Standard Gray	ACC01200411
Standard Slate	ACC01200412
Standard Palomino	ACC01200419
Deluxe Rust	ACU02200250
Deluxe Gray	ACU02200251
Deluxe Slate	ACU02200256
Deluxe Palomino	ACU02200257
Deluxe Teal	ACU02200252
Deluxe Navy	ACU02200253
Deluxe Hunter	ACU02200254
FII830B/L, FII845B/L - 93 x 93	
Standard Rust	ACC01200420
Standard Gray	ACC01200421
Standard Slate	ACC01200422
Standard Palomino	ACC01200423
Deluxe Rust	ACU02200260
Deluxe Gray	ACU02200261
Deluxe Slate	ACU02200266
Deluxe Palomino	ACU02200267
Deluxe Teal	ACU02200262
Deluxe Navy	ACU02200263
Deluxe Hunter	ACU02200264
Galaxy Series	
GX49 - 93 x 93	
Deluxe Rust	ACU02200260
Deluxe Gray	ACU02200261
Deluxe Slate	ACU02200266
Deluxe Palomino	ACU02200267
Victory Xtreme Series	
VX624B - 76 x 84	
Standard Rust	ACC01200406
Standard Gray	ACC01200407
Standard Slate	ACC01200508
Standard Palomino	ACC01200509
Deluxe Rust	ACU02200362
Deluxe Gray	ACU02200363
Deluxe Slate	ACU02200367
Deluxe Palomino	ACU02200358
Custom Teal	ACU02200372

Custom Navy	ACU02200373
Custom Hunter	ACU02200374
VX724L - 84 x 78	
Standard Rust	ACC01200520
Standard Gray	ACC01200521
Standard Slate	ACC01200522
Standard Palomino	ACC01200523
VX726B/L, VX740L - 84 x 84	
Standard Rust	ACC01200410
Standard Gray	ACC01200411
Standard Slate	ACC01200412
Standard Palomino	ACC01200419
Deluxe Rust	ACU02200250
Deluxe Gray	ACU02200251
Deluxe Slate	ACU02200256
Deluxe Palomino	ACU02200257
Custom Teal	ACU02200252
Custom Navy	ACU02200253
Custom Hunter	ACU02200254
VX834B/L, VX848B/L, VX860B/L - 93 x 93	
Standard Rust	ACC01200420
Standard Gray	ACC01200421
Standard Slate	ACC01200422
Standard Palomino	ACC01200423
Deluxe Rust	ACU02200260
Deluxe Gray	ACU02200261
Deluxe Slate	ACU02200266
Deluxe Palomino	ACU02200267
Custom Teal	ACU02200262
Custom Navy	ACU02200263
Custom Hunter	ACU02200264
VX901 - 72 x 72	
Standard Rust	ACC01200566
Standard Gray	ACC01200567
Standard Slate	ACC01200568
Standard Palomino	ACC01200559

Keeping Fit with your Spa

IMPORTANT: Always consult your physician before starting any exercise activity or program. The Ultimate Fitness series spas feature rubber exercise bands. When stretched, these bands create a high tension condition. Improper use or failure to connect the exercise bands properly may cause injury. Always inspect all of the exercise equipment prior to beginning any exercise. Do not use any damaged equipment

The fitness equipment consists of: two rowing arm bars, two 62" exercise bands, two 32" exercise bands, two 27" exercise bands, two hand grips, two ankle bands, two hand loops, and an exercise belt. This equipment attaches to the exercise anchors located on the spa walls.

Ultimate Fitness Series Exercise Program

Refer to the equipment configurations shown on the next page for the following exercises.

Seated Row

Use the exercise bars in a seated position with your feet stable, abs tight and lower back stable. Keep your palms down, arms extended with elbows slightly bent. Pull towards your chest squeezing your shoulder blades to the middle back and returning slowly to the starting position.

Standing Chest Fly

Using the exercise grips, place palms sideways facing your body with your elbows slightly bent. Pull your body forward, bringing hands together, squeezing and flexing chest muscles, then slowly returning to the starting position.

Standing Chest Press

Using the exercise grips, place your palms down with your elbows bent at 90°. Press forward bringing your hands together, squeezing and flexing your chest muscles, then slowly return to the start position.

Standing Shoulder Press

Using the exercise grips, place your palms facing away from your body with your elbows bent at 90°. Press upward bringing your hands together in front of you, above your head and slowly return to the start position.

Arm Curls

Using the exercise grips, place your hands face up with your elbows slightly bent, pull upward towards your chin squeezing and flexing your biceps then slowly return to start position.

Running or Walking

Attach the exercise belt around your waist and attach the two 62" exercise bands to the far wall of the spa. Turn on the two swim jets and walk or run into jet stream.

Leg Stretching and Strength Training

Attach an ankle band to your ankle and attach a 62" exercise band to any exercise anchor. Lift your leg to the side or back as the band provides tension.

Appendix

Connecting the Exercise Equipment

The drawings below show different ways the exercise kit can be connected depending on the exercises you wish to do.

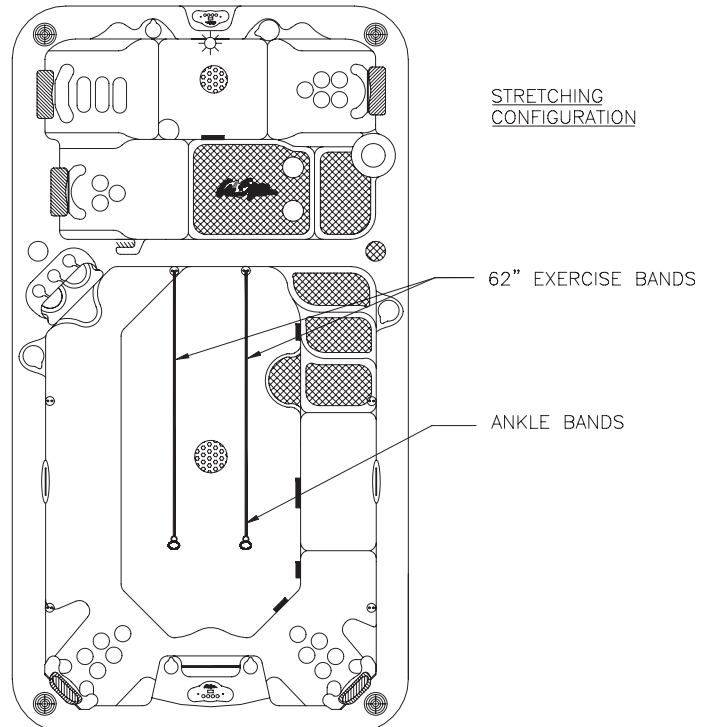
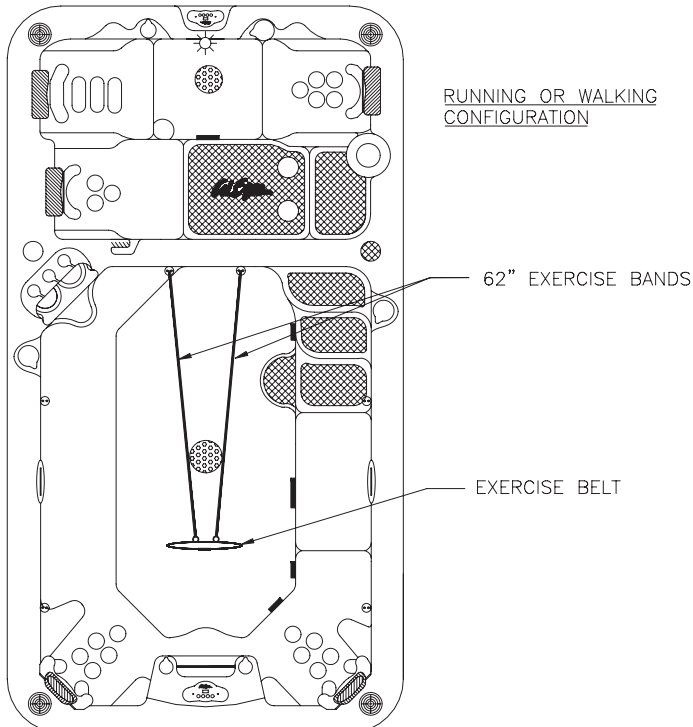
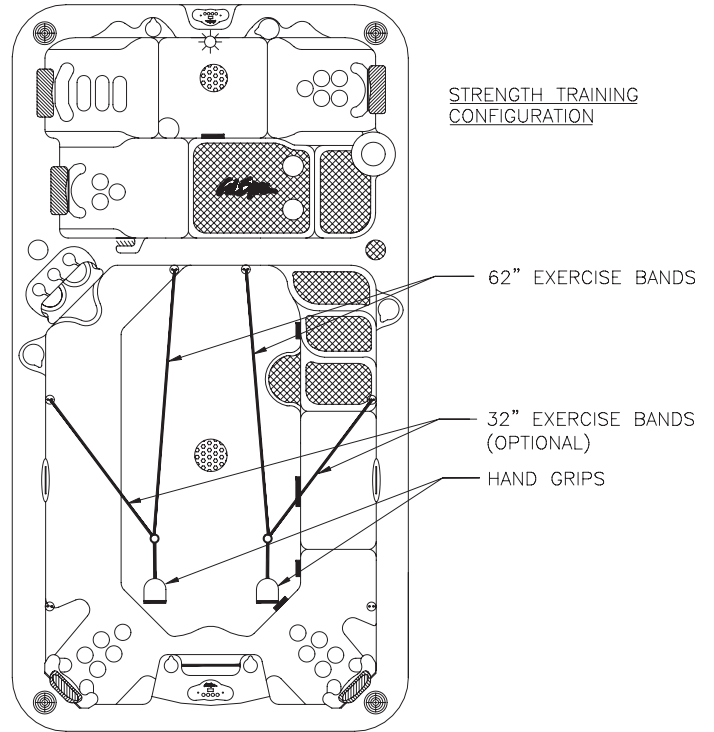
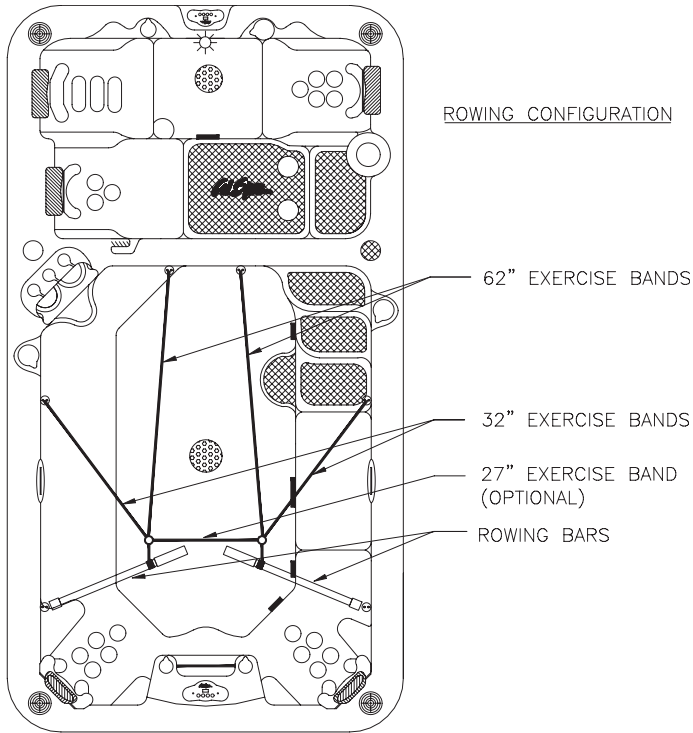
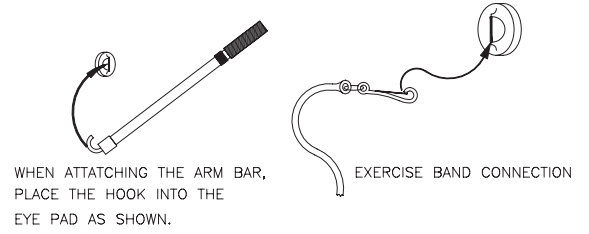

Cal Spas™ Chemicals



Bromine/Chlorine Starter Kit

#CHE07000290/#CHE07000295

When used as directed, this product is effective as a spa and hot tub sanitizer/disinfectant. Treats 250 gallons for up to three weeks.



Vinyl & Leather Cleaner

#CHE07000620

Specifically designed to protect spa covers and pillows from chemical and ultraviolet damage.



Fast Sheen

#CHE07000610

Unique water-based, chemically reactive silicone sealant and polish. Seals, shines, and protects spa surfaces.



Brominating Tablets

#CHE07000760/#CHE07000770

Sanitizer, disinfectant for spas and hot tubs.



Chlorinating Granules

#CHE07000865/#CHE07000880

When used as directed, this product is effective as a spa and hot tub water disinfecting agent.



Go Brom

#CHE07000830

Establishes a bromide bank in spas and hot tubs.



Filter Cartridge Cleaner

#CHE07000690

Breaks down organic and inorganic material. Removes calcium scale and mineral deposits.



Liquid Hardness Increaser

#CHE07000250

Increases water hardness to reduce corrosion. Helps reduce foaming.



Spa Brite

#CHE07000580/#CHE07000590

Clears up cloudy water in spas and hot tubs. Effective at all spa and hot tub temperatures.



Foam Gone

#CHE07000800/#CHE07000810

Breaks up existing foam in spa water. Effective at all spa and hot tub temperatures.



pH-Alkalinity Up

#CHE07000720/#CHE07000730

Helps maintain pH in spas and hot tubs.



pH-Alkalinity Down

#CHE07000750

Lowers pH in spas and hot tubs.



Enzyme Formula

#CHE07000600/#CHE07000605

Emulsifies and biodegrades bodily oils, suntan lotion, and other contaminants in spas and hot tubs.



Metal Protector

#CHE07000630/#CHE07000640

Controls water discoloration caused by minerals. Special Extra Strength formula for spas and hot tubs.



Stain & Scale Prevention

#CHE07000650/#CHE07000660

Prevents minerals from damaging spa components and affecting performance.



Oxidizer Shock

#CHE07000680/#CHE07000710

Destroys organic contaminants and odor-causing wastes.

2008 WARRANTY

U.S. and Canada
Portable Spas

This limited warranty is effective for portable spas manufactured after January 14, 2008

Spa Shell / Structural

10
Years

LMS warrants against the loss of water through the spa shell due to defects in materials and/or workmanship for a period of **10 years** from the original date of purchase.

Interior Surface – Altair Plus / Quarite Plus

10
Years

LMS warrants against cracks, blisters, peeling, discoloration and delamination of Altair Plus / Quarite Plus interior surfaces for a period of **ten years** from the original date of purchase.

Interior Surface – Standard Acrylic / Quarite

5
Years

LMS warrants against cracks, blisters, peeling, discoloration and delamination of standard acrylic/quarite interior surfaces for a period of **five years** from the original date of purchase.

Equipment

5
Years

LMS warrants the spa's electrical and electronic components, specifically: the control system, pumps and air blowers against malfunction due to defects in materials and/or workmanship for a period of **five years** from the original date of purchase.

Plumbing

5
Years

LMS warrants all factory installed plumbing and Eliminator™ Plus Wet Ends from loss of water due to defects in material and/or workmanship for a period of **five years** from the original date of purchase.

Cabinets

3
Years

LMS warrants Cal Premium™, Cal Select™ and Cal Stone™ panels against cracking and warping for a period of **three years** from the original date of purchase.

Components

Lifetime

LMS warrants manufacturer-installed XL Heat Exchanger™ and Cal Zone Quest 2000 Ozonator™ against malfunction due to defects in materials and/or workmanship for the lifetime of the spa.

Electrical and Electronic Components

1
Year

LMS warrants stereos, DVD players, TVs and the LED light source for a period of **one year** from the original date of purchase.

Extent of Warranty

This limited warranty is only valid on portable hot tubs delivered in the United States and Canada. However, it does not apply to special offers and events and extends through the selling dealer to the original purchaser at the original site of installation. This warranty becomes valid at time of purchase and ends either by specified time-frame listed above, owner-transfer, relocation, or installation of any component other than by manufacturer. The Designer series in-ground spas are excluded from this warranty.

Manufacturer Warranty

All Cal Spas hot tubs are manufactured with the highest quality appliances and are warranted to be free from defects in material and workmanship at the time of delivery. Cal Spas electronic component warranty is extended through the manufacturer of the product including, but not limited to: televisions, stereos, DVD players, etc.

Proration of Warranty

Units determined by the Company to be non-repairable will be replaced on a prorated basis with the same or a comparable unit. The user will be charged one percent of the current retail cost for each full month of ownership from the date of purchase through the date failure is determined to be non-repairable. This charge will be waived during the first twelve months of ownership.

Warranty Performance

In the event of a malfunction or defect covered under the terms of this warranty, the factory authorized selling dealer is responsible for performing all necessary repairs. To obtain service, contact the selling dealer. In the event the consumer is unable to obtain satisfactory customer service from the selling dealer, written notification must be given to the LMS Customer Relations Department within 30 days of the reported failure. There will be no charge for parts or labor on a covered item. However, the LMS Service Agent may assess a reasonable travel or mileage charge per service call, which may include diagnostic time. If LMS determines that repair of a covered item is not feasible, LMS reserves the right to replace the defective merchandise with merchandise equivalent or equal in value to the original merchandise. In the event of any warranty replacement, all removal, replacement, installation and shipping costs are the responsibility of the spa owner.

Warranty Exclusions and Limitations

This warranty is void if the spa has been subject to negligence, alteration, misuse, abuse, repairs by non-LMS authorized personnel, incorrect electrical installation, installation of any component other than by the manufacturer, acts of God (including, but not limited to, acts of nature and surrounding environments), and any other cases beyond the control of LMS Refer to the owner's manual for further information and examples of exclusions and common acts invalidating this warranty. This warranty excludes Designer Series in-ground spas.

Disclaimers

This limited warranty is made with the express understanding that the spa is not an essential device or medical device as defined under State and Federal Law. LMS shall not be liable for loss of use of the spa or other incidental or consequential costs, expense or damages, which may include but are not limited to removal of permanent deck or other custom fixtures or the necessity for crane removal. Any implied warranty shall have duration equal of the applicable warranty stated above. Under no circumstances shall LMS or any of its representatives be held liable for injury to any person or damage to any property, however arising.

Legal Remedies

This limited warranty gives you specific legal rights and you may have other rights, which may vary from state to state.

Customer Service

For customer service, contact the authorized selling dealer immediately. If you need additional information or assistance, please contact the LMS Customer Relations Department at 1462 E. Ninth St., Pomona CA 91766 or call (800) 225-7727.

See your Cal Spas™ dealer for a copy of the applicable warranty, details, and any questions you may have regarding the warranty coverage on your spa.

Warranty Specifics

- Five Year Cabinet Warranty: Cabinet surface peeling, blistering, fading, or delamination are specifically excluded from this warranty.
- Lifetime Warranty on XL Heat Exchanger and Quest 2000 Ozonator: After original five-year coverage from date of delivery, lifetime warranty covers parts only. Specifically excludes replacement ozone cartridge, which has a one year warranty
- One Year Spa Cover Warranty: Spa covers are warranted for one year by manufacturer unless otherwise specified.

Warranty Limitations

The 2008 Limited Warranty is void if the spa has been subject to negligence, alteration, misuse, abuse, repairs by non-LMS authorized representatives, incorrect electrical installation, acts of God and any other cases beyond the control of LMS. Examples of common acts invalidating this warranty include, but are not limited to:

- Use of spa in a non-residential application.
- Scratches caused by normal use.
- Operation of spas water temperature out of the normal operating range of 32°F (0°C) to 118°F (47.8°C).
- Damage caused by incorrect water level (low, overflow, etc.).
- Damage caused by extreme weather conditions (hot, cold, etc.).
- Damage caused by dirt, sand and calcium.
- Damage caused by clogged filter cartridges. See filter cleaning recommendations in this owner's manual.
- Damage caused by continued operation of this spa with either a known or an unknown problem.
- Damage caused by tri-chlor, acids, chlorine tablets, any floating chemical devices, or any spa chemicals not authorized by LMS
- Damage caused by improper water chemistry. (High levels of chlorine, bromine, calcium, pH and other excessive chemical levels.)
- Damage caused by direct sunlight. Spas should always be covered when not in use.
- Damage caused as a result of failure to follow operating instructions as defined within this owner's manual.
- Damage caused by incorrect electrical installation, electrical brownout, voltage spikes, or operation of spa out of voltage range by more than ±10%.
- Spas improperly installed or placed on non-approved surfaces.

Although shell cracks, which are breaks in the shell that go all the way through, are covered by this limited warranty, cosmetic scratches, gouges and crazing are not considered cracks and are not covered.

The limited warranty applies only to spas normally used for personal, family or household purposes.

For relocating your spa without voiding your warranty, contact Customer Service for relocation procedures.

Warranty Exclusions

Replaceable service items such as filters, light bulbs, pillows, jet inserts, and filter covers are specifically excluded from the limited warranty.

Spa covers and stereo systems are delivered with their own manufacturer's warranty. For more information, please see their warranties in the owner's information package that was delivered with your spa for more information.

Equipment adjustments (such as pressure switch adjustments) are specifically excluded from this warranty.



Locating the product serial number

The serial number of your spa is located on a metal plate attached to the lower right front panel of the spa. You will need this number to properly register your spa and activate coverage. Write this information in the space provided below.

Spa Model: _____

Spa Serial Number: _____

Date Purchased: _____

Date Installed: _____

Dealer's Phone Number: _____

Dealer's Address: _____

CONTACT INFORMATION

For customer service, please contact your authorized dealer immediately. If you need additional information and/or assistance, please contact:

LMS Customer Service Department
1462 East Ninth Street
Pomona, CA 91766.

Toll Free: 1-800-CAL-SPAS
Fax: 1-909-629-3890

www.calspas.com

Free Manuals Download Website

<http://myh66.com>

<http://usermanuals.us>

<http://www.somanuals.com>

<http://www.4manuals.cc>

<http://www.manual-lib.com>

<http://www.404manual.com>

<http://www.luxmanual.com>

<http://aubethermostatmanual.com>

Golf course search by state

<http://golfingnear.com>

Email search by domain

<http://emailbydomain.com>

Auto manuals search

<http://auto.somanuals.com>

TV manuals search

<http://tv.somanuals.com>