

can-am™



2008

**Operator's
Guide**

**Includes
Safety, Vehicle
and Maintenance Information**

DS 70™

DS 90™

DS 90 X™

⚠ WARNING

Read this guide thoroughly. It contains important safety information.

Minimum recommended operator age:

A child under 12 years should never operate a vehicle with an engine size 70 cc or greater.

Do not remove this Operator's Guide from the vehicle.

2 1 9 0 0 0 5 1 4

Download from www.50manuals.com. All Manuals Search And Download.

This Operator's Guide utilizes the following symbols and words to emphasize particular information:

 The Safety Alert Symbol indicates a potential personal injury hazard.

 **WARNING** Indicates a potential hazard that, if not avoided, could result in serious injury or death.

CAUTION: Denotes an instruction which, if not followed, could severely damage vehicle components.

NOTE: Indicates supplementary information needed to fully complete an instruction.

 **WARNING**

YOUR VEHICLE CAN BE HAZARDOUS TO OPERATE. A collision or rollover can occur quickly, even during routine maneuvers such as turning and driving on hills or over obstacles, if you fail to take proper precautions. For your safety, understand and follow all the warnings contained in this Operator's Guide and the labels on your vehicle. **Failure to follow these warnings can result in SEVERE INJURY OR DEATH!** Keep this Operator's Guide with the vehicle at all times.

 **WARNING**

Disregarding any of the safety precautions and instructions contained in this Operator's Guide, *SAFETY VIDEO* and on-product labels could cause injury including the possibility of death!

All safety documentation should remain with the vehicle at the time of sale.

All content of the Safety Information section should be interpreted by the reader as a warning which, if not followed, may result in injury including the possibility of death.

In Canada, products are distributed by Bombardier Recreational Products Inc. (BRP).

In USA, products are distributed by BRP US Inc.

The following trademarks are the property of Bombardier Recreational Products Inc.:

Can-Am™

DS70™

DS90™

XP-S™

FOREWORD

Congratulations on your purchase of a new Can-Am™ ATV, category "Y" (youth model). It is backed by the BRP warranty and a network of authorized Can-Am dealers ready to provide the parts, service or accessories you may require.

Your dealer is committed to your satisfaction. He has taken training to perform the initial setup and inspection of your vehicle as well as completed the final adjustment before you took possession. At delivery, your dealer would have explained the operation, maintenance and safety features of the vehicle. We trust you have taken full advantage of this! If you need more complete servicing information, please ask your dealer.

At delivery, you were also informed of the warranty coverage and signed the *PREDELIVERY CHECK LIST* to ensure your new vehicle was prepared to your entire satisfaction.

You are invited to contact our customer assistance center should you experience problems which cannot be resolved by an authorized Can-Am dealer.

It is understood that this Operator's Guide may be translated into another language. In the event of any discrepancy, the English version shall prevail. Throughout this document the masculine is used to denote the masculine or feminine.

If you want to view and/or print an extra copy of your Operator's Guide, simply visit the following website www.operatorsguide.brp.com. Also note that the guide is available in several languages.

The information and components/system descriptions contained in this document are correct at the time of publication. BRP, however, maintains a policy of continuous improvement of its products without imposing upon itself any obligation to install them on products previously manufactured. Due to late changes, some differences between the manufactured product and the descriptions and/or specifications in this guide may occur. BRP reserves the right at any time to discontinue or change specifications, designs, features, models or equipment without incurring any obligation upon itself.

The illustrations in this document show the typical construction of the different assemblies and may not reproduce the full detail or exact shape of the parts. However, they represent parts that have the same or similar function.

The use of RIGHT and LEFT indications in the text always refers to driving position (when sitting on vehicle).

Specifications are given in the SI metric system with the SAE U.S. equivalent in parenthesis. Where precise accuracy is not required, some conversions are rounded off for easier use.

We recommend genuine BRP products for replacement parts and accessories. They've been especially designed for your vehicle and manufactured to meet BRP's demanding standards.

A *SHOP MANUAL* can be obtained for complete service and maintenance information and more repair information.

TABLE OF CONTENTS

While reading this Operator's Guide, remember that:

WARNING

Indicates a potential hazard that, if not avoided, could result in serious injury or death.

NOTICE	7
Notice to Parents	7
INTRODUCTION	9

SAFETY INFORMATION

SPECIAL SAFETY MESSAGES	12
OPERATION WARNINGS	15
RIDING THE VEHICLE	41
Pre-Operation Check	41
Clothing	43
Carrying Loads	44
Recreational Riding	44
Environment.....	44
Design Limitation	45
Off-Highway Operation.....	45
General Operating and Safety Precautions	45
Uphill Driving	45
Downhill Driving	46
Side Hilling.....	46
Drop-Offs	46
Riding Techniques	46
Routine Maintenance.....	52
HANG TAG	54
LOCATION OF THE IMPORTANT LABELS	55

VEHICLE INFORMATION

HOW TO IDENTIFY YOUR VEHICLE	60
NOISE EMISSION CONTROL SYSTEM REGULATION	61
EMISSION REQUIREMENTS	62
BREAK-IN PERIOD	63
CONTROLS/INSTRUMENTS/EQUIPMENT	64
1) Throttle Lever	67
2) Speed Limiter Screw	67

3) Front Brake Lever.....	68
4) Rear Brake Lever.....	68
5) Parking Brake.....	68
6) Transmission Lever.....	69
7) Multi-Switch Housing.....	69
8) Indicator Lamps.....	71
9) Ignition Switch.....	72
10) Fuel Tank Cap.....	72
11) Fuel Valve.....	72
12) Engine Oil Dipstick.....	73
13) Footpeg.....	73
14) Seat Latch Knob.....	74
15) Fuse.....	74
16) Kick Start Pedal.....	75
17) Tool Kit.....	75
18) Front Storage Compartment.....	75
LIQUIDS.....	77
Quick Reference Chart.....	77
Overview.....	77
Fuel.....	78
Fueling Procedure.....	78
Engine Oil.....	78
Engine Oil Level.....	79
Brake Fluid.....	80
TIRES AND RIMS.....	81
Tire Pressure.....	81
Tire/Rim Condition.....	81
OPERATING INSTRUCTIONS.....	82
Starting the Engine.....	82
Stopping the Engine.....	84
Post-Operation Care.....	84
SUSPENSION ADJUSTMENT.....	85
Spring Preload Adjustment.....	85
SPECIAL PROCEDURES.....	86
Turn Over.....	86
Vehicle Immersion.....	86
TRANSPORTING THE VEHICLE.....	87
TROUBLESHOOTING.....	88
SPECIFICATIONS.....	91

MAINTENANCE INFORMATION

MAINTENANCE CHART	96
GENERAL	99
ENGINE	100
Oil Change	100
Air Filter Housing Draining	101
Air Filter Cleaning	102
Air Injection Valve Filter Cleaning	102
Spark Arrester Cleaning	103
TRANSMISSION (CVT)	104
Drive Belt Inspection	104
CVT Cover Drain Plug	104
GEARBOX	105
Oil Change	105
FUEL SYSTEM	107
Throttle Cable Inspection	107
Throttle Lever Adjustment	107
Speed Limiter Adjustment	107
ELECTRICAL	109
Spark Plug Removal/Inspection	109
Battery Removal	110
Fuse Replacement	110
Bulb Replacement	110
DRIVE TRAIN	112
Drive Chain Cleaning/Lubrication/Adjustment	112
Drive Chain Roller Inspection	113
Sprocket and Pinion Inspection	113
Wheels Removal/Condition	113
STEERING SYSTEM	115
Lubrication	115
BRAKES	116
Inspection (hydraulic)	116
Inspection (mechanical)	116
Front Brake Cable Adjustment	116
Rear Brake Lever Adjustment	117
BODY/FRAME	118
Engine Compartment Inspection	118
Fasteners Inspection	118
Seat Latch Inspection	118
STORAGE AND PRESEASON PREPARATION	119

WARRANTY

BRP LIMITED WARRANTY NORTH AMERICA: 2008 CAN-AM™ ATV ...	122
BRP INTERNATIONAL LIMITED WARRANTY: 2008 CAN-AM™ ATV	126
BRP EUROPEAN UNION MEMBER STATES LIMITED WARRANTY: 2008 CAN-AM™ ATVS	130
PRIVACY OBLIGATION/DISCLAIMER	134
CHANGE OF ADDRESS/OWNERSHIP	135

NOTICE

This Operator's Guide has been prepared to acquaint the owner/operator of a new vehicle with the various vehicle controls, maintenance and safe operating instructions. It is indispensable for the proper use of the product.

This Operator's Guide uses the following symbols.

WARNING

Indicates a potential hazard that, if not avoided, could result in serious injury or death.

CAUTION: Denotes an instruction which, if not followed, could severely damage vehicle components.

NOTE: Indicates supplementary information needed to fully complete an instruction.

Although the mere reading of such information does not eliminate the hazard, the understanding and application of the information will promote the correct use of this vehicle.

To fully appreciate the pleasures, enjoyment and excitement of using this vehicle, there are some basic rules that **MUST** be observed and followed by any user.

This vehicle is a youth model vehicle. It is designed to provide the following speed.

- The DS70 provides a maximum restricted speed of 16 km/h (10 MPH).
- The DS90 and DS90 X provides a maximum restricted speed of 24 km/h (15 MPH).

Notice to Parents

Review this Operator's Guide with any vehicle's user.

Please take time with the children to review the instructions on its safe and proper use, while pay attention to the on-product safety labeling before allowing them to ride the vehicle.

Understand the controls and operation of the vehicle, carefully read the Operator's Guide, pay attention to the on-product safety labeling and review them with children before allowing them to ride the vehicle.

A child under 6 years old should never operate an ATV with an engine size 50 cc or higher.

A child under 12 years old should never operate an ATV with an engine size 70 cc or higher.

Always remember that your approach to safety influences the child.

WARNING

An ATV is not a toy.

- Children differ in skills, physical abilities and judgement. Some children may not be able to operate an ATV safely.
- Parents should supervise their children when they use of the vehicle at all times.
- Parents should permit continued use only if they determine that the child has the ability to operate the vehicle safely.
- No one under 16 years should operate an ATV without adult supervision at all times and never allow continued use of the vehicle by a child if he does not have the abilities, the strength or the judgement to operate it safely.
- BRP recommends that all ATV riders take a training course. For safety and training information, contact an authorized Can-Am dealer or call the Specialty Vehicle Institute of America (SVIA) at 1 800 887-2887 or in Canada, the Canada Safety Council (CSC) at 1 613 739-1535 ext. 227.

INTRODUCTION

Your dealer should have provided you with some basic information on the particular controls and features of your new youth model vehicle. Please take the time to study this Operator's Guide and all on-product warning labels as well as the *SAFETY VIDEO* that came with this vehicle. They more completely describe what you should know about this vehicle before riding it.

Whether you are a new user or an experienced rider, it is important for your personal safety as well as passenger safety that you know the controls and features of this vehicle. Equally important is knowing how to properly ride.

Irrespective of your age, experience or state regulations, it is always prudent for you or any other person who may ride your vehicle, to take an approved safe riding course. Please check with your dealer or local authorities for availability in your area. If you are a completely new rider, this should be done before your first ride. Your instructor should be able to provide advice on local conditions and safe riding practices particular to the area.

Riding conditions vary from place to place. Each is subject to weather conditions which may radically change from time to time and from season to season.

Riding on sand is different than riding on snow or through forests or marshes. Each location may require a greater degree of awareness and skill may not be suitable with a passenger. Show good judgement. Always proceed with caution. Please do not take any unnecessary risks that could leave you or your passenger stranded or possibly injured.

The contents of this Operator's Guide provide riding information which has been proven reliable by other users. They are not intended as a definitive means of avoiding accidents. How you apply this information, coupled with your mental and physical condition, the particular terrain hazard and your risk acceptance level will have an effect on your riding experience. Have fun... and ride responsibly.

This Operator's Guide has been prepared to acquaint the owner/operator of a new vehicle with the various vehicle controls, maintenance and safe operating instructions. They are indispensable for the proper use of the product.

We would be pleased to receive any comments on the content and format of this Operator's Guide, the *SAFETY VIDEO* or *WARNINGS LABELS*.

SAFETY INFORMATION

SPECIAL SAFETY MESSAGES

THIS VEHICLE IS NOT A TOY AND CAN BE HAZARDOUS TO OPERATE.

This vehicle handles differently from other vehicles including motorcycles and cars. A collision or rollover can occur quickly, even during routine maneuvers such as turning and driving on hills or over obstacles, if you fail to take proper precautions.

SEVERE INJURY OR DEATH can result if you do not follow these instructions:

- ⚠ Read this Operator's Guide and all on-product warning labels carefully and follow the operating procedures described. Watch and pay attention to the *SAFETY VIDEO* before operation.
- ⚠ Never operate this vehicle without proper instruction. **Take a training course.** All operators should receive training from a certified instructor. Contact an authorized Can-Am dealer for more information.
- USA and Canada only:** to find out about available training course nearest you, call the Specialty Vehicle Institute of America (SVIA) at 1 800 877-2887 or in Canada, the Canada safety Council (CSC) at 1 613 739-1535 ext. 227.
- ⚠ Always follow this age recommendation:
 - A child under 6 years old should never operate an ATV with engine size 50 cc or greater.
 - A child under 12 years old should never operate an ATV with engine size 70 cc or greater.

- ⚠ Never allow a child under age 16 to operate a category "Y" (youth model) ATV without adult supervision, and never allow continued use of an ATV by a child if he does not have the abilities to operate it safely.
- ⚠ Never carry a passenger on this vehicle.
- ⚠ Never operate this vehicle on any paved surfaces, including sidewalks, driveways, parking lots and streets.
- ⚠ Never operate this vehicle on any public street, road or highway, even a dirt or gravel one.
- ⚠ Never take place on this vehicle without wearing an approved helmet that fits properly. You should also wear eye protection (goggles or visor), gloves, boots, long sleeved shirt or jacket, and long pants.
- ⚠ Never consume alcohol or drugs before or while riding this vehicle.
- ⚠ Never operate at excessive speeds. Always go at a speed that is proper for the terrain, visibility, and operating conditions, and your experience.
- ⚠ Never attempt wheelies, jumps, or other stunts.
- ⚠ Always inspect your vehicle each time you use it to make sure it is in safe operating condition. Always follow the inspection and maintenance procedures and schedules described in this Operator's Guide.
- ⚠ Always keep both hands on the handlebars and both feet on the footpegs of the vehicle during operation.

- ⚠ Always go slowly and be extra careful when operating on unfamiliar terrain. Always be alert to changing terrain conditions when operating this vehicle.
- ⚠ Never operate on excessively rough, slippery or loose terrain until you have learned and practiced the skills necessary to control this vehicle on such terrain. Always be especially cautious on these kinds of terrain.
- ⚠ Always follow proper procedures for turning as described further in this Operator's Guide. Practice turning at low speeds before attempting to turn at faster speeds. Do not turn at excessive speed.
- ⚠ Never operate this vehicle on hills too steep for the vehicle or for your abilities. Practice on smaller hills before attempting larger hills.
- ⚠ Always follow proper procedures for climbing hills as described further in this Operator's Guide. Check the terrain carefully before you start up any hill. Never climb hills with excessively slippery or loose surfaces. Shift your weight forward. Never open the throttle suddenly or make sudden gear changes. Never go over the top of any hill at high speed.
- ⚠ Always follow proper procedures for going down hills and for braking on hills as described further in this Operator's Guide. Check the terrain carefully before you start down any hill. Shift your weight backward. Never go down a hill at high speed. Avoid going down a hill at an angle that would cause the vehicle to lean sharply to one side. Go straight down the hill where possible.
- ⚠ Always follow proper procedures for crossing the side of a hill as described further in this Operator's Guide. Avoid hills with excessively slippery or loose surfaces. Shift your weight to the uphill side of the vehicle. Never attempt to turn the vehicle around on any hill until you have mastered the turning technique described in this Operator's Guide on level ground. Avoid crossing the side of a steep hill if possible.
- ⚠ Always use proper procedures if you stall or roll backwards when climbing a hill. To avoid stalling, use proper gear and maintain a steady speed when climbing a hill. If you stall or roll backwards, follow the special procedure for braking described in this Operator's Guide. Dismount on the uphill side or to a side if pointed straight uphill. Turn the vehicle around and remount, following the procedure described further in this Operator's Guide.
- ⚠ Always check for obstacles before operating in a new area. Never attempt to operate over large obstacles, such as large rocks or fallen trees. Always follow proper procedures when operating over obstacles as described further in this Operator's Guide.
- ⚠ Always be careful when skidding or sliding. Learn to safely control skidding or sliding by practicing at low speeds and on level smooth terrain. On extremely slippery surfaces, such as ice, go slowly and be very cautious in order to reduce the chance of skidding out of control.

⚠ Never operate this vehicle in fast flowing water or in water deeper than that specified in this Operator's Guide. Remember that wet brakes may have reduced stopping ability. Test your brakes after leaving water. If necessary, apply them several times to let friction dry out the pads.

⚠ Always use the size and type tires specified further in this Operator's Guide. Always maintain proper tire pressure as described further in this Operator's Guide.

⚠ Never load a youth model vehicle.

⚠ **FOR MORE INFORMATION ABOUT ATV SAFETY**, contact an authorized Can-Am dealer to find out about available training courses nearest you.

USA and Canada only: call the Specialty Vehicle Institute of America (SVIA) at 1 800 877-2887 or in Canada, the Canada safety Council (CSC) at 1 613 739-1535 ext. 227.

OPERATION WARNINGS

While reading this Operator's Guide, remember that:

WARNING

Indicates a potential hazard that, if not avoided, could result in serious injury or death.

The following warning and their format have been requested by the United States Consumer Product Safety Commission and are required to be in the Operator's Guide for all ATVs.

NOTE: The following illustrations are general representations only. Your model may differ.

WARNING



V00A0AQ

POTENTIAL HAZARD

Operating this vehicle without proper instruction.

WHAT CAN HAPPEN

The risk of an accident is greatly increased if the operator does not know how to operate this vehicle properly in different situations and on different types of terrain.

HOW TO AVOID THE HAZARD

Beginning and inexperienced operators should complete a training course. They should then regularly practice the skills learned in the course and the operating techniques described in this Operator's Guide.

For more information about the training course, contact an authorized Can-Am dealer.

 **WARNING**



V00A19Q

POTENTIAL HAZARD

Failure to follow the age recommendations for this vehicle.

WHAT CAN HAPPEN

Use by children of ATVs that are not recommended for their age can lead to severe injury or death of the child.

Even though a child may be within the age group for which this vehicle is recommended, he may not have the skills, abilities, or judgment needed to operate this vehicle safely and may be involved in a serious accident.

HOW TO AVOID THE HAZARD

A child under 6 years old should never operate an ATV.

A child under 6 years old should never operate an ATV with engine size 50 cc or greater.

A child under 12 years old should never operate an ATV with engine size 70 cc or greater.

No one under 16 should operate a category "Y" (youth model) ATV without adult supervision.

Adults should never allow continued use of the vehicle by a child if he does not have the abilities, strength or judgement to operate it safely.

 **WARNING**



V00A02Q

POTENTIAL HAZARD

Carrying a passenger on this vehicle.

WHAT CAN HAPPEN

Greatly reduces your ability to balance and control this vehicle.

Could cause an accident, resulting in harm to you and/or your passenger.

HOW TO AVOID THE HAZARD

Never carry passenger. Even with a long seat that provides unrestricted operator movement, it is not designed nor intended to carry passenger(s).

WARNING

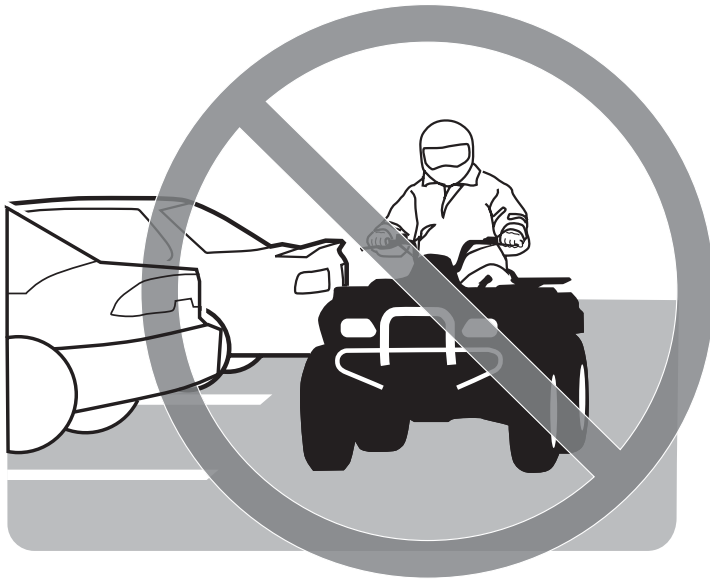

V00A03Q

POTENTIAL HAZARD

Operating this vehicle on paved surfaces.

WHAT CAN HAPPEN

The tires are designed for off-road use only, not for use on pavement. Paved surfaces may seriously affect handling and control of this vehicle, and may cause the vehicle to go out of control.

HOW TO AVOID THE HAZARD

Never operate this vehicle on any paved surfaces, including sidewalks, driveways, parking lots and streets.

 **WARNING**



V00A04Q

POTENTIAL HAZARD

Operating this vehicle on public streets, roads or highways.

WHAT CAN HAPPEN

You can collide with another vehicle.

HOW TO AVOID THE HAZARD

Never operate this vehicle on any public street, road or highway, even a dirt or gravel one. In many states or provinces it is illegal to operate this vehicle on public streets, roads or highways.

WARNING



V00A06Q

POTENTIAL HAZARD

Riding this vehicle without wearing an approved helmet, eye protection and protective clothing.

WHAT CAN HAPPEN

The following items concern all ATV's operator:

- riding without an approved helmet increases the chances of a severe head injury or death in the event of an accident
- riding without eye protection can result in an accident and increases the chances of a severe injury in the event of an accident
- riding without protective clothing increases the chances of severe injury in the event of an accident.

HOW TO AVOID THE HAZARD

Always wear an approved helmet that fits properly. You should also wear:

- eye protection (goggles or visor)
- gloves and boots
- long sleeved shirt or jacket
- long pants.

 **WARNING**



V00A07Q

POTENTIAL HAZARD

Riding this vehicle after consuming alcohol or drugs.

WHAT CAN HAPPEN

- Could seriously affect your judgment.
- Could cause you to react more slowly.
- Could affect your balance and perception.
- Could result in an accident or death.

HOW TO AVOID THE HAZARD

Never consume alcohol or drugs before or while riding this vehicle.

WARNING

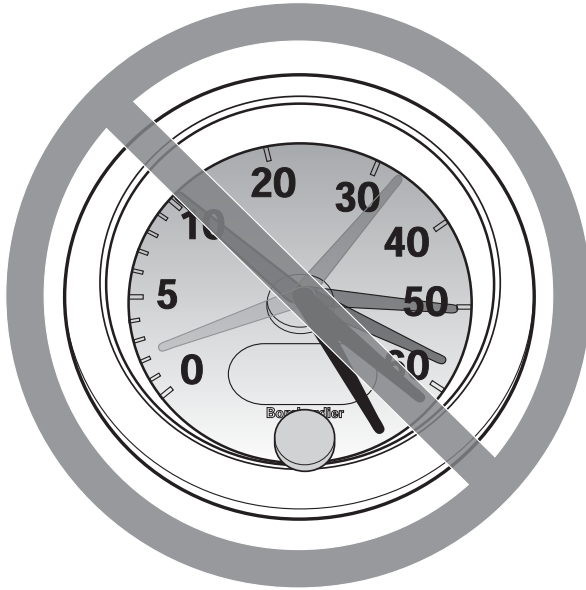

V00A08Q

POTENTIAL HAZARD

Operating this vehicle at excessive speeds.

WHAT CAN HAPPEN

Increases your chances of losing control of the vehicle, which can result in an accident.

HOW TO AVOID THE HAZARD

Always travel at a speed which is proper for the terrain, visibility and operating conditions, and your experience.

 **WARNING**



V00A09Q

POTENTIAL HAZARD

Attempting wheelies, jumps and other stunts.

WHAT CAN HAPPEN

Increases the chance of an accident, including an overturn.

HOW TO AVOID THE HAZARD

Never attempt stunts, such as wheelies or jumps. Do not try to show off.

 **WARNING**

POTENTIAL HAZARD

Failure to inspect the vehicle before operating.
Failure to properly maintain the vehicle.

WHAT CAN HAPPEN

Increases the possibility of an accident or equipment damage.

HOW TO AVOID THE HAZARD

Always inspect your vehicle each time you use it to make sure the vehicle is in safe operating condition.

Always follow the inspection and maintenance procedures and schedules described further in this Operator's Guide.

 **WARNING**

POTENTIAL HAZARD

Riding on frozen waterways.

WHAT CAN HAPPEN

Severe injury or death can result if the vehicle and/or operator break through the ice.

HOW TO AVOID THE HAZARD

Never ride this vehicle on a frozen surface before you are sure the ice is thick enough and sound enough to support the vehicle and its load, as well as the force that is created by a moving vehicle.

 **WARNING**



V00A0BQ

POTENTIAL HAZARD

Removing hands from handlebar or feet from the footrests during operation.

WHAT CAN HAPPEN

Removing even one hand or foot can reduce your ability to control the vehicle or could cause you to lose your balance and fall off the vehicle. If you remove a foot from the footrests, your foot or leg may come into contact with the rear wheels, which could injure you or cause an accident.

HOW TO AVOID THE HAZARD

Always keep both hands on the handlebar and both feet on the footrests during vehicle operation.

WARNING

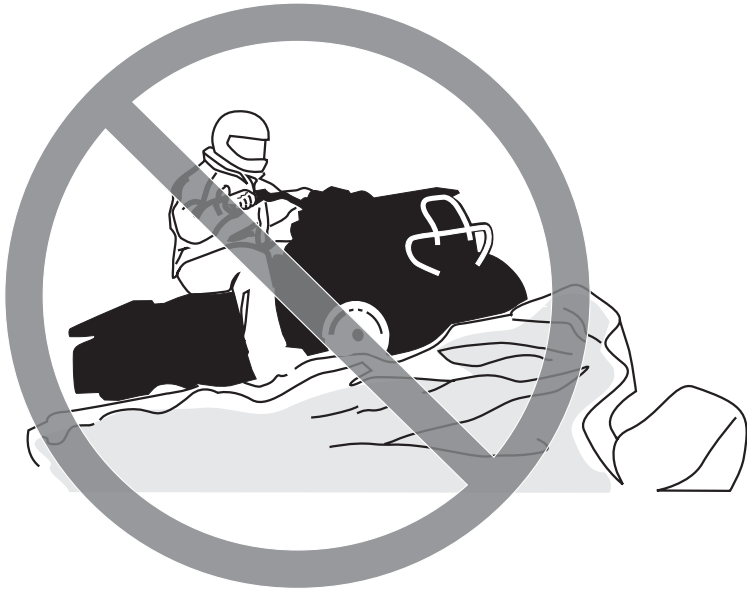

V00A0CQ

POTENTIAL HAZARD

Failure to use extra care when operating this vehicle on unfamiliar terrain.

WHAT CAN HAPPEN

You can come upon hidden rocks, bumps, or holes, without enough time to react.

Could result in the vehicle overturning or loss of control.

HOW TO AVOID THE HAZARD

Go slowly and be extra careful when operating on unfamiliar terrain.

Always be alert to changing terrain conditions when operating the vehicle.

WARNING



V00A0DQ

POTENTIAL HAZARD

Failure to use extra care when operating on excessively rough, slippery or loose terrain.

WHAT CAN HAPPEN

Could cause loss of traction or vehicle control, which could result in an accident, including an overturn.

HOW TO AVOID THE HAZARD

Do not operate on excessively rough, slippery or loose terrain until you have learned and practiced the skills necessary to control this vehicle on such terrain.

Always be especially cautious on these kinds of terrain.

⚠ WARNING



V00A0EQ

POTENTIAL HAZARD

Turning improperly.

WHAT CAN HAPPEN

Vehicle could go out of control, causing a collision or overturn.

HOW TO AVOID THE HAZARD

Always follow proper procedures for turning as described further in this Operator's Guide. Practice turning at low speeds before attempting to turn at faster speeds.

Do not turn at excessive speed.

⚠ WARNING



V00A0QQ

POTENTIAL HAZARD

Operating on excessively steep hills.

WHAT CAN HAPPEN

The vehicle can overturn more easily on extremely steep hills than on level surfaces or small hills.

HOW TO AVOID THE HAZARD

Never operate this vehicle on hills too steep for the vehicle or for your abilities.

Practice on smaller hills before attempting larger hills.

⚠ WARNING



V00A0FQ

POTENTIAL HAZARD

Climbing hills improperly.

WHAT CAN HAPPEN

Could cause loss of control or cause vehicle to overturn.

HOW TO AVOID THE HAZARD

Always follow proper procedures for climbing hills as described further in this Operator's Guide.

Always check the terrain carefully before you start up any hill.

Never climb hills with excessively slippery or loose surfaces.

Shift your weight forward.

Never open the throttle suddenly or make sudden gear changes. The vehicle could flip over backwards.

Never go over the top of any hill at high speed. An obstacle, a sharp drop, or another vehicle or person could be on the other side of the hill.

 **WARNING**



V00A0GQ

POTENTIAL HAZARD

Going down a hill improperly.

WHAT CAN HAPPEN

Could cause loss of control or cause vehicle to overturn.

HOW TO AVOID THE HAZARD

Always follow proper procedures for going down hills as described further in this Operator's Guide. **NOTE:** A special technique is required when braking as you go down a hill.

Always check the terrain carefully before you start down any hill.

Shift your weight backward.

Never go down a hill at high speed.

Avoid going down a hill at an angle which would cause the vehicle to lean sharply to one side. Go straight down the hill where possible.

WARNING



V00A0HQ

POTENTIAL HAZARD

Improperly crossing hills or turning on hills.

WHAT CAN HAPPEN

Could cause loss of control or cause vehicle to overturn.

HOW TO AVOID THE HAZARD

Never attempt to turn the vehicle around on any hill until you have mastered the turning technique as described further in this Operator's Guide on level ground. Be very careful when turning on any hill.

Avoid crossing the side of a steep hill if possible.

When crossing the side of a hill:

Always follow proper procedures as described further in this Operator's Guide.

Avoid hills with excessively slippery or loose surfaces.

Shift your weight to the uphill side of the vehicle.

WARNING



V00A01Q

POTENTIAL HAZARD

Stalling, rolling backwards or improperly dismounting while climbing a hill.

WHAT CAN HAPPEN

Could result in vehicle overturning.

HOW TO AVOID THE HAZARD

Use proper gear and maintain steady speed when climbing a hill.

If you lose all forward speed:

Keep your weight uphill. Never open the throttle suddenly or make sudden gear changes. The vehicle could flip over backwards.

Apply the brakes.

Lock parking brake after you are stopped.

Dismount on uphill side, or to a side if pointed straight uphill.

If you begin rolling backwards:

Keep your weight uphill. Never open the throttle suddenly or make sudden gear changes. The vehicle could flip over backwards.

Never apply the rear brake while rolling backwards.

Apply the front brake gradually.

When fully stopped, apply rear brake as well and lock parking brake.

Dismount on uphill side, or to a side if pointed straight uphill.

Turn the vehicle around and remount, following the procedure described further in this Operator's Guide.

WARNING



V00A0JQ

POTENTIAL HAZARD

Improperly operating over obstacles.

WHAT CAN HAPPEN

Could cause loss of control or a collision.

Could cause the vehicle to overturn.

HOW TO AVOID THE HAZARD

Before operating in a new area, check for obstacles.

Never attempt to ride over large obstacles, such as large rocks or fallen trees.

When you go over obstacles, always follow proper procedures as described further in this Operator's Guide.

⚠ WARNING



V00A0KQ

POTENTIAL HAZARD

Skidding or sliding improperly.

WHAT CAN HAPPEN

You may lose control of this vehicle.

You may also regain traction unexpectedly, which may cause the vehicle to overturn.

HOW TO AVOID THE HAZARD

Learn to safely control skidding or sliding by practicing at low speeds and on level smooth terrain.

On extremely slippery surfaces, such as ice, go slowly and be very cautious in order to reduce the chance of skidding or sliding out of control.

WARNING



V00A0LQ

POTENTIAL HAZARD

Operating this vehicle through deep or fast flowing water.

WHAT CAN HAPPEN

Tires may float, causing loss of traction and loss of control, which could lead to an accident.

HOW TO AVOID THE HAZARD

Never operate this vehicle in fast flowing water or in water deeper than that specified further in this Operator's Guide.

Check water depth and current before you attempt to cross any water. Water should not go above footrests.

Remember that wet brakes may have reduced stopping ability. Test your brakes after leaving water. If necessary, apply them several times to let friction dry out the pads.

 **WARNING**



V00A00Q

POTENTIAL HAZARD

Operating this vehicle with improper tires, or with improper or uneven tire pressure.

WHAT CAN HAPPEN

Use of improper tires on this vehicle, or operation of this vehicle with improper or uneven tire pressure, may cause loss of control, tire blow outs, tire to move around on its rim, and increases the risk of an accident.

HOW TO AVOID THE HAZARD

Always use the size and type of tires specified further in this Operator's Guide for this vehicle.

Always maintain proper tire pressure as described further in this Operator's Guide.

Always replace wheels or tires that are damaged.

WARNING



V00A0N0

POTENTIAL HAZARD

Operating this vehicle with improper modifications.

WHAT CAN HAPPEN

Improper installation of accessories or modification of this vehicle may cause changes in handling which in some situations could lead to an accident.

HOW TO AVOID THE HAZARD

Never modify this vehicle through improper installation or use of accessories. All parts and accessories added to this vehicle should be approved by BRP and should be installed and used according to instructions. If you have questions, consult an authorized Can-Am dealer.

NEVER install passenger seat or use the racks to carry a passenger.

Modification of the vehicle to increase speed and performance may violate the terms and conditions of your vehicle limited warranty. In addition, certain modifications including the removal of engine or exhaust components are illegal under most laws.

⚠ WARNING



V00A0PQ

POTENTIAL HAZARD

Overloading this vehicle or carrying or towing cargo improperly.

WHAT CAN HAPPEN

Could cause changes in vehicle handling which could lead to an accident.

HOW TO AVOID THE HAZARD

Never load cargo on this vehicle.

Never tow cargo or another vehicle with this vehicle.

 **WARNING**



V03M01Q

POTENTIAL HAZARD

Transporting flammable or dangerous material can lead to explosions.

WHAT CAN HAPPEN

This can cause serious injury or death.

HOW TO AVOID THE HAZARD

Never transport flammable or dangerous material.

While reading this Operator's Guide, remember that:

 **WARNING**

Indicates a potential hazard that, if not avoided, could result in serious injury or death.

RIDING THE VEHICLE

To fully appreciate the pleasures and excitement of riding this vehicle, there are some basic rules and tips that you **MUST** follow. Some may be new to you while others may be common sense or obvious. Nonetheless, we ask that you take a few minutes to read, with your child, this Operator's Guide completely before he operates this vehicle.

Information in this Operator's Guide is limited. It is strongly recommended that you obtain further information and training from your local authorities, ATV clubs, a recognized ATV training organization or contact an authorized Can-Am dealer.

USA and Canada only: To find out about available training course nearest you, call the Specialty Vehicle Institute of America (SVIA) at 1 800 877-2887 or in Canada, the Canada safety Council (CSC) at 1 613 739-1535 ext. 227.

The U.S. Consumer Product Safety Commission and all ATV manufacturers do not recommended anyone under the age of 16 to ride an ATV having an engine higher than 90 cc and anyone under age of 12 to ride an ATV having an engine higher than 70 cc. For the child's safety, we strongly recommend you also follow and enforce this recommendation. You are the sole judge of a rider's capability to understand the risks and operate a vehicle safely.

Persons with cognitive or physical impairments or who are high risk takers have an increased exposure to over-turns or collisions which may result in injury including death.

Become completely familiar with the operational controls and the general operation of the vehicle before venturing into off road conditions. Practice driving in a suitable area free of hazards and feel the response of each control. Drive at low speeds. Higher speeds require greater experience, knowledge and suitable riding conditions.

Not all vehicles are the same. Each has its own unique performance characteristics, controls and features. Each will ride and handle differently.

Never assume that the vehicle will go everywhere safely. Sudden changes in terrain caused by holes, depressions, banks, softer or harder "ground" or other irregularities may cause the vehicle to topple or become unstable. To avoid this, slow down and always observe the terrain ahead. If the vehicle does begin to topple or tipover, it is usually the best advice to immediately get off... **AWAY** from the direction of the tipover!

Pre-Operation Check

WARNING

The pre-operation check is very important prior to operating the vehicle. Always check the proper operation of critical controls, safety features and mechanical components before starting. If not done, severe injury or death might occur.

Before using this vehicle, the operator and/or an adult should always:

- Apply parking brake and check if it operates properly.
- Check tire pressure and condition.
- Check wheels and bearings for wear and damage.

- Check location of controls and ensure they work properly.
- Verify if steering operates freely.
- Activate throttle control lever several times to ensure it operates freely. It must return to idle position when released.
- Ensure that the speed limited screw is adjusted at the good position for the rider capability.
- Activate the brake levers to make sure the brakes fully apply. Levers must fully return when released.
- Check drive chain for adjustment and lubrication.
- Check sprockets for wear and damages.
- Check fuel and oil levels.
- Check for oil leaks on the engine, transmission and the drive train components.
- Ensure fuel valve is in fully open position (ON).
- Ensure seat and front storage compartment are properly latched.
- Look and feel for loose parts while engine is off. Check fasteners.
- Ensure the path of travel is free of persons and obstacles.
- Check operation of ignition switch, engine start button, engine stop switch and indicator light.
- Start engine, remove parking brake and drive forward slowly a few feet then apply all brakes individually to test them.

Correct any problem you may have found before riding. See an authorized Can-Am dealer as necessary.

Clothing

Actual weather conditions should help you decide how to dress. However, it is important that the operator always wear the appropriate protective clothing and apparel, including an approved helmet, eye protection, boots, gloves, long sleeved shirt and pants. This type of clothing will provide you protection from some of the minor hazards you may encounter en route. Operator must never wear loose clothing such as a scarf that may get entangled in the vehicle or on tree branches and shrubs. Depending on conditions, antifogging goggles or sun glasses may be required. Sun glasses should only be worn during the daytime. Different colored lenses available for goggles or glasses help you distinguish terrain variations.

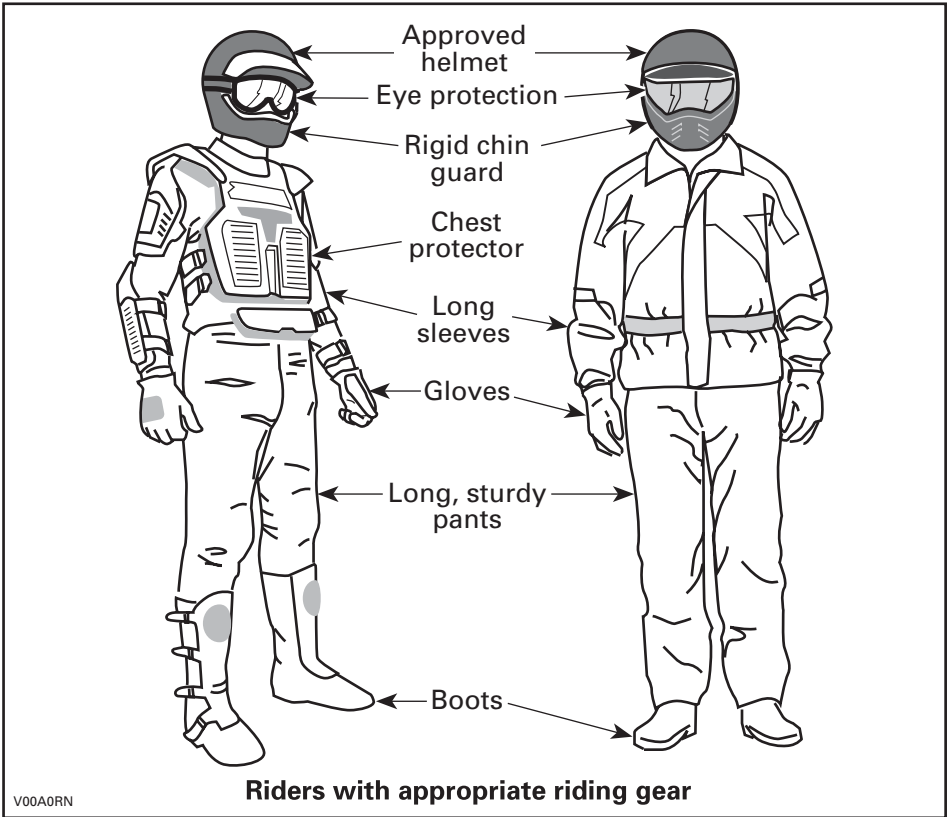

Carrying Loads

This vehicle is designed specifically to carry an operator only. Even with a long seat that provide unrestricted operator movements, it is not designed nor intended to carry passenger(s). NEVER install passenger's seat or use the racks or their location to carry passenger(s). Carrying passenger(s) may affect the stability and your control of the vehicle.

Never load cargo on this vehicle.

Recreational Riding

Respect the rights and limitations of others. Stay away from areas designated for other types of off road use. This includes snowmobile trails, equestrian trails, cross country ski trails, mountain bike trails etc. Never assume there are no other users on the trail. Always stay to the complete right of the trail and do not zig zag to one side of the trail then the other. Be prepared to stop or pull off to the side if another trail user appears in front of you.

Always keep a safe distance from other riders. Your judgment of speed, terrain conditions, weather, mechanical condition of your vehicle and the "trust in judgment" you have in others around you will help you make a better choice of appropriate safe distance. This vehicle, like any other motorized vehicle, cannot stop "on a dime".

Before you ride, tell someone where you are planning to travel and your expected time of return. Never consume alcohol or drugs before or while riding!

Depending on the length of your ride, carry additional tools or emergency equipment. Find out where you can get additional gasoline and oil. Be prepared for the possible conditions you may encounter. An emergency first aid kit should always be a consideration.

Environment

One of the benefits of this vehicle is that it can take you off the beaten path away from most communities. However, you should always respect nature and the rights of others to enjoy it. Do not ride in environmentally sensitive areas. Do not drive over forest crops or shrubs... nor cut down trees or take down fencing... nor spin your wheels and destroy the terrain. "Tread Lightly".

Chasing wildlife is in many areas illegal. Wildlife can die of exhaustion after being chased by a motorized vehicle. If you encounter animals on the trail, stop and observe quietly and with caution. It will be one of the better memories of your life.

Observe the rule... "what you take in, carry out". Do not litter. Do not start campfires unless you have permission to do so... and then only... away from dry areas. The hazards you may create on the trail may cause injury to others or yourself, even at a later date.

Respect farm lands. Always obtain the permission of the landowner before riding on private land. Respect crops, farm animals and property lines. If you come to a closed a gate, close it again after yourself.

Finally, do not pollute streams, lakes or rivers and do not modify the engine or muffling system, or remove any of its components.

Design Limitation

Although the vehicle is exceptionally rugged for its class, it is still a light vehicle by definition and its operation must be restricted to its proper purpose.

The addition of weight to any part of the vehicle changes its gravitational stability and modifies its performance.

Off-Highway Operation

The very nature of off-highway operation is dangerous. Any terrain, which has not been specially prepared to carry vehicles, presents an inherent danger where angularity, terrain substance and exact steepness are unpredictable. The terrain itself presents a continual element of danger, which must be knowingly accepted by anyone venturing over it.

An operator who takes a vehicle off-road should always exercise the utmost care in selecting the safest path and keeping close watch on the terrain ahead of him. On no account should the vehicle be operated by anyone who is not completely familiar with the driving instructions applicable to the vehicle, nor should it be operated on steep or treacherous terrain.

General Operating and Safety Precautions

Care, caution, experience and driving skill are the best precautions against the hazards of vehicle operation.

Whenever there is the slightest doubt that the vehicle can safely negotiate an obstacle or a particular piece of terrain, always choose an alternate route.

In off-road operation, power and traction, not speed, are important. Never drive faster than visibility and your own ability to select a safe route permit.

Constantly watch the terrain ahead for sudden changes in slopes or obstacles, such as rocks or stumps, that may cause loss of stability, resulting in tipover or rollover.

Never operate the vehicle if the controls do not function normally.

When stopped or parked, always apply the parking brake. This is especially important when parking on a slope. On very steep inclines or if the vehicle is carrying cargo, the wheels should be blocked using rocks or bricks. Remember to turn the fuel valve to the closed position.

Uphill Driving

Due to configuration, this vehicle has excellent climbing ability, so much so that tipover is possible before traction is lost. For example, it's common to encounter terrain situations where the top of the hill has eroded to a point that the hill peak rises very sharply. The vehicle can readily negotiate such a condition, however, in doing so, when the front of the vehicle is driven to a point that the vehicle's balance changes rearward tipover can occur.

The same situation may apply if an embedded object causes the front of the vehicle to climb more than desired. If such a situation occurs take an alternate route. Be aware of side hilling dangers when doing so.

It is also wise to know the terrain condition on the other side of the hill or bank. All too often there exists a sharp drop-off that is impossible to negotiate or descend.

Downhill Driving

This vehicle can climb slopes that are steeper than it can safely descend. Therefore, it is essential to assure that a safe route exists to descend a slope before you climb it.

Decelerating while negotiating a slippery downhill slope could “toboggan” the vehicle. Maintain steady speed and/or accelerate slightly to regain control.

Side Hilling

Whenever possible, such operation should be avoided. If necessary, do so with extreme caution. Side hilling on steep inclines could result in rollover. In addition, slippery or unfirm surfaces could result in uncontrollable side sliding. Do not attempt to turn the vehicle downhill with the slide. Avoid all objects or depressions that will intensify the raising of one side of the vehicle higher than the other, thus causing rollover.

Drop-Offs

This vehicle will “bottom-out” and usually stop if either the front or rear wheels are driven over a drop-off. If the drop is sharp or deep, the vehicle will nose dive and tipover.

WARNING

Avoid negotiating drop-offs. Reverse and select an alternate route.

Riding Techniques

Riding your vehicle too fast for the conditions may result in injury. Apply only enough throttle to proceed safely. Statistics show that high speed turns usually result in mishaps and injury. Always remember that this vehicle is heavy! Its pure weight alone may entrap you should it fall and pin you down.

This vehicle is not designed for jumping nor can it, or you, absorb the energy of high impacts such as jumping. Performing “wheelies” can cause the vehicle to flip over onto you. Both practices have a high risk for you and should be avoided at all times.

To maintain proper control it is strongly advised that you keep your hands on the handlebar and within easy reach of all controls. The same holds true for your feet. To minimize the possibility of any leg or foot injury, keep your feet on the footrests at all times. Do not direct your toes outwards nor place your foot out to assist turning as they can be hit or snagged by passing obstacles or may contact the wheels.

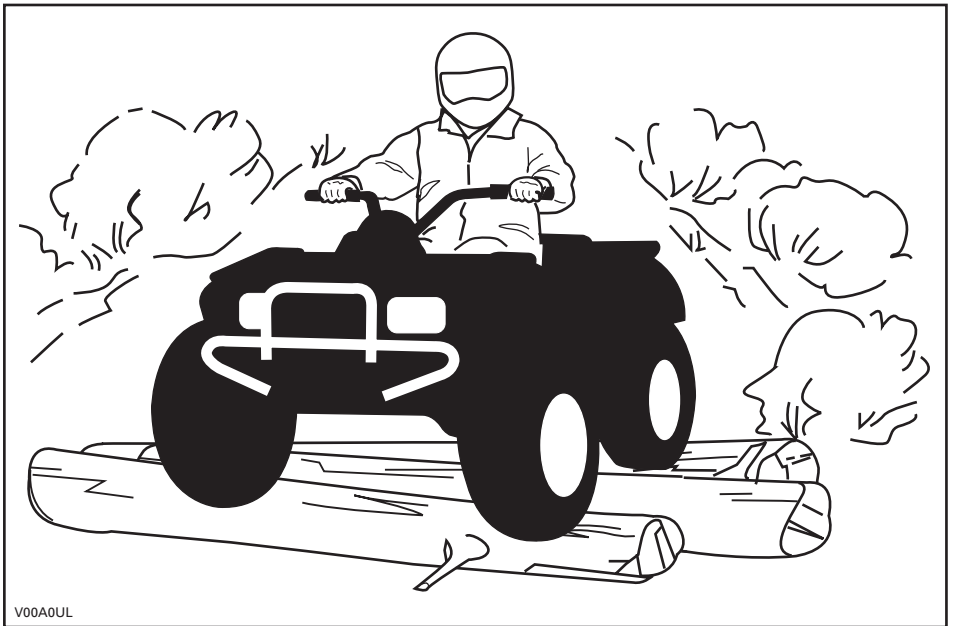

Even though there is an adequate suspensions system on this vehicle there are “washboard” or rough terrain conditions that will make you feel uncomfortable and even cause back injury. “Posting” or riding in a crouched position will often be required. Slow down and allow your flexed legs to absorb impact.

This vehicle is not designed for riding on roads or highways. In most places it is an illegal practice. Riding your vehicle on roads or highways could cause a collision to occur with another vehicle. The tires of this vehicle are not suited for paved road use. Pavement may seriously affect the handling and control of the vehicle. Riding on roads or soft shoulders may confuse other road users, especially if your lights are on. If you have to cross a road, the lead driver should get off his vehicle then observe and give directions to the other riders. The last person after crossing then assists the lead driver to cross. Do not travel sidewalks. They are designated for pedestrian use.

Water can be a unique hazard. If it is too deep the vehicle may “float” and topple. Check the water depth and current before you attempt to cross any water. Water should not go above the footrest. Be wary of slippery surfaces such as rocks, grass, logs, etc., both in the water and on its banks. A loss of traction may occur. Do not attempt to enter the water at high speed. The water will act as a brake and could throw you.

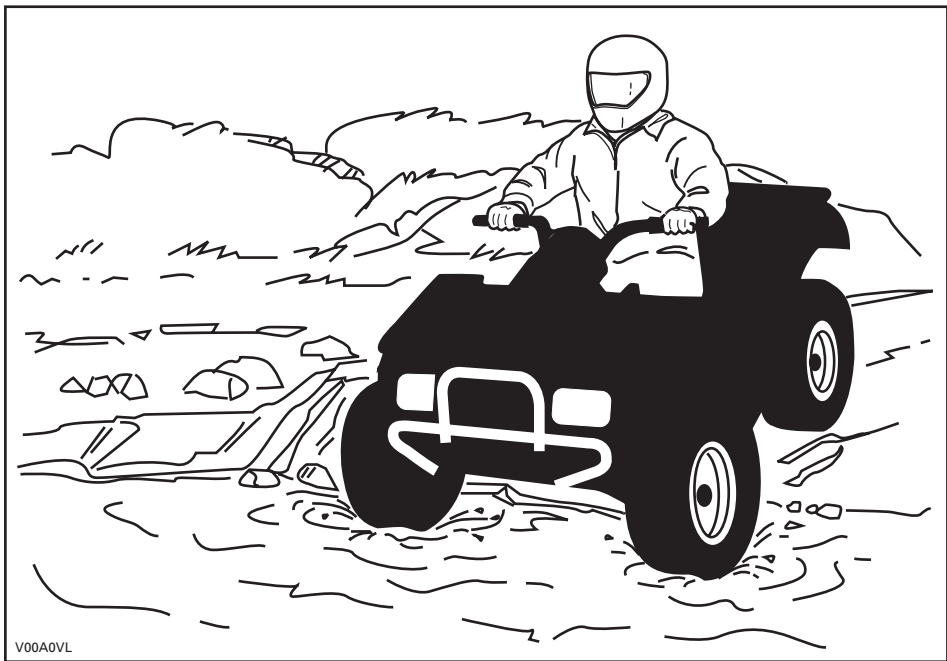

Water will affect the braking ability of your vehicle. Make sure you dry the brakes by applying them several times after the vehicle leaves the water.

Mud or marsh lands may be encountered near water. Be prepared for sudden "holes" or changes in depth. Similarly so, be watchful of hazards such as rocks, logs, etc., partially covered by vegetation.

If your trip crosses frozen waterways, make sure that the ice is thick enough and sound enough to support the total weight of yourself, the vehicle and its load. Be ever watchful of open water... it is a sure indication that the ice thickness will vary. If in doubt, do not attempt to cross.

Ice will also affect the control of vehicle. Slow down and do not "gun" the throttle. This will only result in spinning of the tires and possible tipover of the vehicle. Avoid rapid braking. This again will possibly result in an uncontrolled slide and tipover of the vehicle. Slush should be avoided at all times since it could block the operation or controls of the vehicle.

Sand and riding on sand dunes or on snow is another unique experience but there are some basic precautions that should be observed. Wet, deep or fine sand/snow may create a loss of traction and cause the vehicle to slide, drop off or become "bogged" down. If this occurs look for a firmer base. Again, the best advice is to slow down and be watchful of the conditions.

When riding in sand dunes it is advisable to equip the vehicle with an antenna type safety flag. This will help make your location more visible to others over the next sand dune. Proceed carefully should you see another safety flag ahead. Since the antenna type safety flag can snag and rebound on your body if caught, do not use it in areas where there are low hanging branches or obstacles.

Riding on loose stones or gravel is very similar to riding on ice. They will affect the steering of vehicle... possibly causing it to slide and tipover especially at high speeds. In addition, braking distance may be affected. Remember that "gunning" the throttle or sliding may cause loose stones to be ejected rearwards into the path of another rider's way. Never do it deliberately.

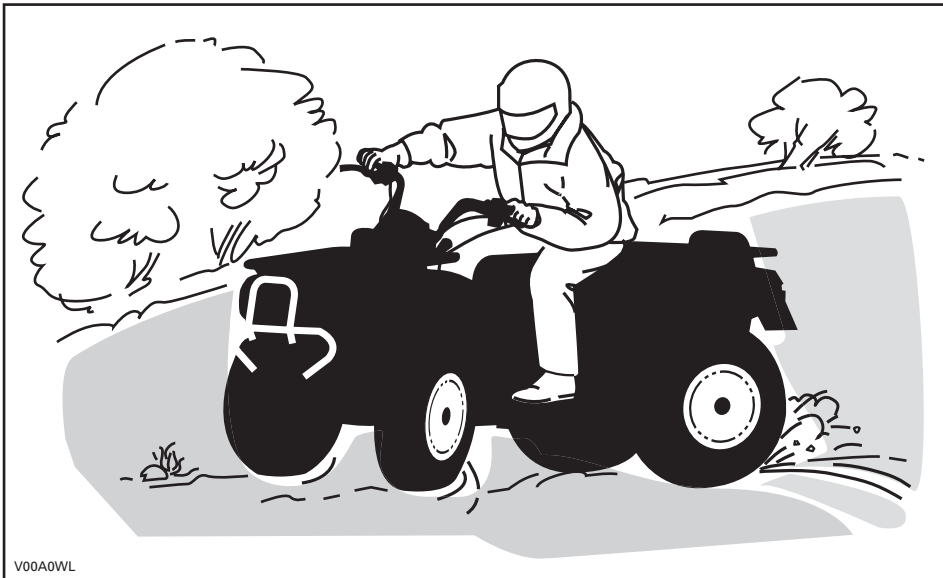

If you do get into a slide or skid, it may help to turn the handlebar into the direction of the skid until you regain control. Never jam the brakes and lock the wheels.

Respect and follow all posted trail signs. They are there to help you and others.

Obstacles in the "trail" should be traversed with caution. This includes loose rocks, fallen trees, slippery surfaces, fences, posts, and embankments and depressions. You should avoid them whenever possible. Remember that some obstacles are too large or dangerous to cross and should be avoided. Small rocks or fallen trees may be safely crossed... approach at a 90° angle. Stand on the footrests while keeping your knees flexed. Adjust speed without losing momentum and do not "gun" the throttle. Hold handlebar firmly. Place your body weight rearwards and proceed. Do not try to lift the vehicle front wheels off the ground. Be aware that the object may be slippery or may move while crossing.

When driving on hills or slopes two things are highly important... be prepared for slippery surfaces or terrain variations and obstacles and... use proper body positioning.

Uphill

Keep your body weight forward towards the top of the hill. Keep your feet on the footpegs and shift into low gear then accelerate and when necessary, change gear quickly as you climb. Do not over-speed since this may cause the front of the vehicle to lift from the ground and fall back on you. If the hill is too steep and you cannot proceed or the vehicle begins to roll backwards, apply the brake, being careful not to slide. Dismount then use the "U" turn or "K" turn (while walking back, next to the vehicle on the up hill side and with a hand on the brake lever, slowly back the rear of the vehicle toward the top of the hill then drive downhill). Always walk or dismount on the upside of the slope while keeping clear of the vehicle and its rotating wheels. Do not try to hold on to the vehicle if it begins to topple. Stay clear. Do not ride over the crest of the hill at high speed. Obstacles, including sharp drop-offs, may exist.

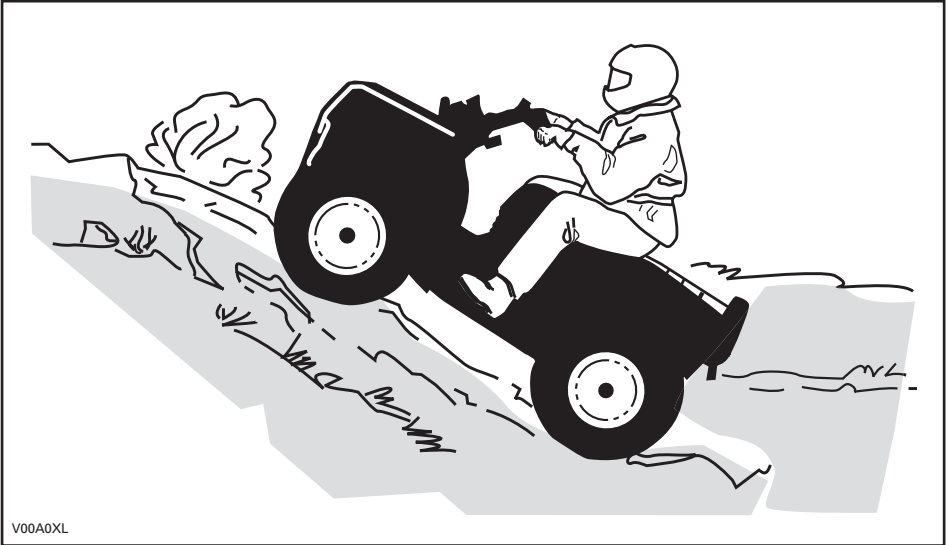

V00A0XL

Downhill

Keep your body weight rearwards. Apply the brake gradually to prevent skidding. Do not “coast” down the slope using solely engine compression or in neutral gear.

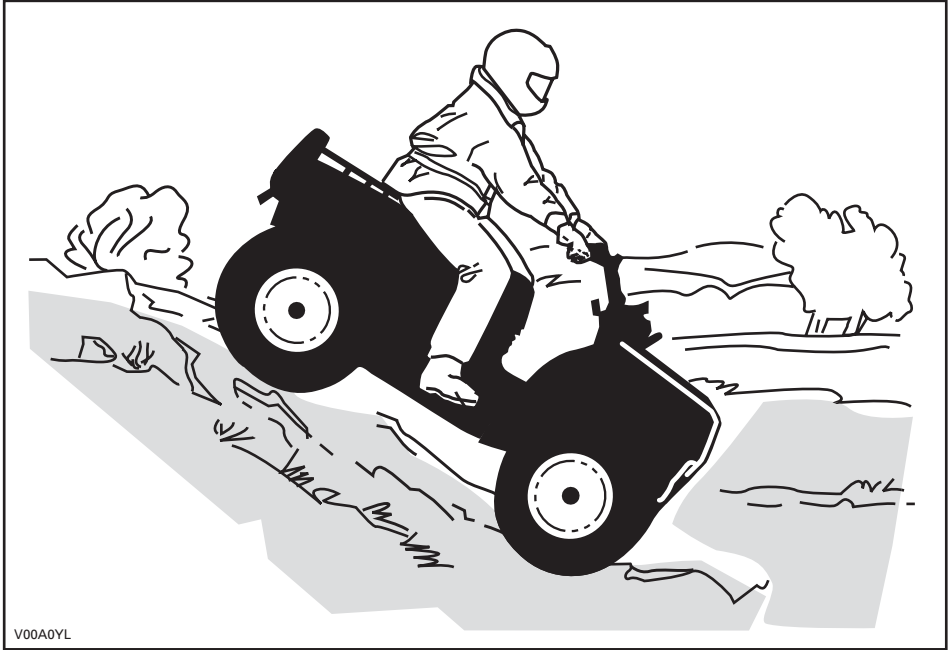

While reading this Operator’s Guide, remember that:

WARNING

Indicates a potential hazard that, if not avoided, could result in serious injury or death.

Side Hilling

This is one of the **most risky** types of riding since it may drastically change the balance of the vehicle. It should be avoided wherever possible. If it is necessary to do so however, it is important that you **ALWAYS** keep your body weight on the upside of the slope... and be prepared to dismount on that side should the vehicle begin to topple. **Do not try to stop or save the vehicle from damage.**



Routine Maintenance

Once your ride completed, it is wise to remove any build up of snow, ice, mud and grime. Not only will this help you keep your vehicle longer and in good condition for resale but will eliminate potential hazards the next time you use the vehicle. Wash your vehicle in warm soapy water then allow it to dry. (A towel may help.) Do not wash your vehicle outside during freezing weather. Apply appropriate lubrication as described in the *MAINTENANCE INFORMATION* section.

Part of your responsibility towards safety is to respect the contents of this Operator's Guide. It provides valuable advice on how to properly take care of your vehicle. If further assistance is required your authorized Can-Am dealer is always willing to help.

Modification of the vehicle to increase speed and performance may violate the terms and conditions of your vehicle limited warranty. In addition, certain modifications including the removal of engine or exhaust components are illegal under most laws.

Changing the wheel and/or tire size may affect the stability of the vehicle. Incorrect tire pressure may lead to blow outs or cause a tire to move around on its rim and become lost or damaged. Wheels or tires which are damaged should always be replaced.





While reading this Operator's Guide, remember that:

 **WARNING**

Indicates a potential hazard that, if not avoided, could result in serious injury or death.

HANG TAG

This vehicle comes with a hang tag containing important information.

<div style="text-align: center; border: 1px solid black; padding: 5px;"> Y CATEGORY MODEL </div> <p style="text-align: center;">THIS ATV IS FOR RECREATIONAL USE UNDER STRICT PARENTAL SUPERVISION. OPERATOR ONLY-NO PASSENGERS</p> <p style="text-align: center;">THIS Y CATEGORY ATV HAS BEEN DESIGNED TO BE USED UNDER LIMITED/ RESTRICTED MAXIMUM SPEED</p> <hr/> <p style="text-align: center;">(RECOMMENDED FOR USER ABOVE 6 YEARS OLD) RESTRICTED MAXIMUM SPEED: 16 KPH (10 MPH) (FACTORY SET-UP) *UNRESTRICTED MAXIMUM SPEED: 24 KPH (15 MPH) (SET UNDER CLOSE PARENT SUPERVISION/JUDGEMENT)</p> <hr/> <p style="text-align: center;">(RECOMMENDED FOR USER ABOVE 12 YEARS OLD) RESTRICTED MAXIMUM SPEED: 24 KPH (15 MPH) (FACTORY SET-UP) *UNRESTRICTED MAXIMUM SPEED: 48 KPH (30 MPH) (SET UNDER CLOSE PARENT SUPERVISION/JUDGEMENT)</p> <hr/> <p style="text-align: center;">TRAINING COURSES TO TEACH ATV RIDING SKILLS ARE AVAILABLE. FOR INFORMATION CONTACT YOUR DEALER.</p> <p style="text-align: center;">CHECK WITH YOUR DEALER TO FIND OUT ABOUT STATE OR LOCAL LAWS REGARDING ATV OPERATION.</p> <p style="text-align: center; font-size: 0.8em;">*See operator's guide for the procedure</p> <div style="text-align: center; border: 1px solid black; padding: 2px; font-size: 0.7em; font-weight: bold;">THIS HANGTAG IS NOT TO BE REMOVED BEFORE SALE.</div>	<div style="text-align: center; border: 1px solid black; padding: 5px;"> ⚠ WARNING </div> <p style="text-align: center; font-size: 0.8em;">Improper ATV use can result in SEVERE INJURY or DEATH.</p> <div style="display: flex; justify-content: space-around;"> <div style="text-align: center;">  <p style="font-size: 0.7em;">ALWAYS USE AN APPROVED HELMET AND PROTECTIVE GEAR.</p> </div> <div style="text-align: center;">  <p style="font-size: 0.7em;">NEVER USE ON PUBLIC ROADS.</p> </div> </div> <div style="display: flex; justify-content: space-around; margin-top: 10px;"> <div style="text-align: center;">  <p style="font-size: 0.7em;">NEVER CARRY PASSENGERS.</p> </div> <div style="text-align: center;">  <p style="font-size: 0.7em;">NEVER USE WITH DRUGS OR ALCOHOL.</p> </div> </div> <p style="font-size: 0.7em; margin-top: 10px;">NEVER operate:</p> <ul style="list-style-type: none"> • without proper training or instructions. • at speeds too fast for your skills or the conditions. • on public roads - a collision can occur with another vehicle. • with a passenger - passengers affect balance and steering and increase risk of losing control. <p style="font-size: 0.7em; margin-top: 10px;">ALWAYS:</p> <ul style="list-style-type: none"> • use proper riding techniques to avoid vehicle overturns on hills and rough terrain and in turns. • avoid paved surfaces - pavement may seriously affect handling and control. <p style="text-align: center; font-size: 0.7em; margin-top: 10px;">LOCATE AND READ OPERATOR'S GUIDE. FOLLOW ALL INSTRUCTIONS & WARNINGS.</p> <p style="text-align: right; font-size: 0.6em;">704 901 401</p>
---	---

vmo2008-008-066_aen

TYPICAL

USA and Canada Only

VEHICLE ENGINE DESCRIPTION:

XXXXX

EPA CERTIFIED

NER (NORMALIZED EMISSION RATE) = X

ON A 0 TO 10 SCALE, 0 BEING THE CLEANEST

*NOT TO BE REMOVED PRIOR TO SALE



704901107

vmo2006-005-009_en

LOCATION OF THE IMPORTANT LABELS

The following labels are on your vehicle and they should be considered permanent parts of the vehicle. If missing or damaged, they can be replaced free of charge. See an authorized Can-Am dealer.

NOTE: The following illustrations used in this Operator's Guide are a general representation only. Your model may differ.



TYPICAL

Label 1

⚠ WARNING

Improper ATV use can result in SEVERE INJURY or DEATH.



ALWAYS USE AN APPROVED HELMET AND PROTECTIVE GEAR.

NEVER USE ON PUBLIC ROADS.

NEVER CARRY PASSENGERS.

NEVER USE WITH DRUGS OR ALCOHOL.

NEVER operate:

- without proper training or instructions.
- at speeds too fast for your skills or the conditions.
- on public roads - a collision can occur with another vehicle.
- with a passenger - passengers affect balance and steering and increase risk of losing control.

ALWAYS:

- use proper riding techniques to avoid vehicle overturns on hills and rough terrain and in turns.
- avoid paved surfaces - pavement may seriously affect handling and control.

LOCATE AND READ OPERATOR'S GUIDE.
FOLLOW ALL INSTRUCTIONS & WARNINGS.

V01M01Z 704 900 901

Label 2

⚠ WARNING



NEVER ride as a passenger. Passengers can cause a loss of control, resulting in SEVERE INJURY or DEATH.

V01M07Z 704 900 005

Label 3

⚠ WARNING



UNDER 6

Operating this ATV if you are under the age of 6 increases your chance of SEVERE INJURY or DEATH. **NEVER** operate this ATV if you are under age 6.

V05M02Y 704 900

DS70

⚠ WARNING



UNDER 12

Operating this ATV if you are under the age of 12 increases your chance of SEVERE INJURY or DEATH. **NEVER** operate this ATV if you are under age 12.

V05M03Y 704 900

DS90/DS90 X

Label 4

⚠ WARNING

Improper tire pressure or overloading can cause loss of control.

Loss of control can result in SEVERE INJURY or DEATH.

TIRE PRESSURE

- Set with tires cold: DSXX / DSXX
 - Recommended: FRONT: XXX kPa, X X psi, REAR: XXX kPa, X X psi.
 - Minimum FRONT: XXX kPa, X X psi, REAR: XXX kPa, X X psi.
- Never set tire pressure below minimum. It could cause the tire to dislodge from the rim.
- Maximum Vehicle Load: XXX lbs, (XX kg). Includes weight of operator and accessories.

vm02008-008-002_aen

TYPICAL

Label 5

USA and Canada Models

EMISSION CONTROL INFORMATION		
THIS VEHICLE IS CERTIFIED TO OPERATE ON UNLEADED GASOLINE AND MEETS TO [XXXX] U.S. EPA AND CALIFORNIA REGULATIONS FOR ATV SI ENGINES.		
ENGINE FAMILY	[XXXXX.XXXXXX]	FAMILLE DE MOTEUR
CERTIFICATION STANDARD (FEL)	[XXXXXXXXXXXXXXXX]	LIMITE DES ÉMISSIONS DE LA FAMILLE
ENGINE DISPLACEMENT	[XXXXXXXXXX]	CYLINDRÉE
EXHAUST EMISSION CONTROL SYSTEM	[XXXX]	SYSTÈME DE CONTRÔLE DES ÉMISSIONS
RENSEIGNEMENTS SUR LE DISPOSITIF ANTIPOLLUTION		
CE VÉHICULE EST CERTIFIÉ POUR FONCTIONNER À L'ESSENCE SANS PLOMB ET IL RÉPOND AUX NORMES [XXXX] DE L'EPA ET RÉGLEMENTATIONS CALIFORNIENNES POUR LES VTT À MOTEUR SI.		
SEE OPERATOR'S GUIDE FOR MAINTENANCE SPECIFICATIONS VOIR GUIDE DU CONDUCTEUR POUR LES SPÉCIFICATIONS D'ENTRETIENS		
BOMBARDIER RECREATIONAL PRODUCTS INC.		

vmo2007-002-002

LOCATED UNDER REAR FENDER

VEHICLE INFORMATION

HOW TO IDENTIFY YOUR VEHICLE

The main components of your vehicle (engine and frame) are identified by different serial numbers. It may sometimes become necessary to locate these numbers for warranty purposes or to trace your vehicle in the event of loss. These numbers are required by the authorized Can-Am dealer to complete warranty claims properly. No warranty will be allowed by BRP if the engine identification number (EIN) or vehicle identification number (VIN) is removed or mutilated in any way. We strongly recommend that you take note of all the serial numbers on your vehicle and supply them to your insurance company.

Engine Identification Number Location

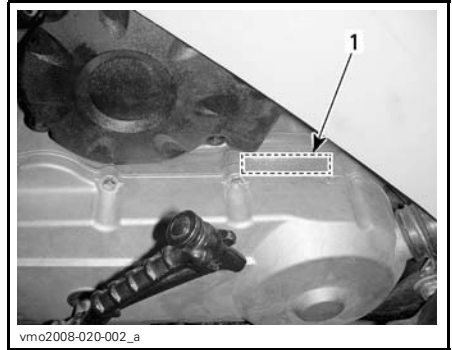

LH SIDE OF VEHICLE
1. E.I.N.

Vehicle Identification Number Location



TYPICAL — FRONT OF VEHICLE
1. V.I.N.

NOISE EMISSION CONTROL SYSTEM REGULATION

USA and Canada Only

Tampering with Noise Control System is Prohibited!

U.S. Federal law and Canadian provincial laws may prohibit the following acts or the causing there of:

1. The removal or rendering inoperative by any person other than for purposes of maintenance, repair or replacement of any device or element of design incorporated into any new vehicle for the purpose of noise control prior to its sale or delivery to the ultimate purchaser or while it is in use or,
2. The use of the vehicle after such device or element of design has been removed or rendered inoperative by any person.

Among those Acts Presumed to Constitute Tampering Are the Acts Listed Below:

1. Removal or alteration or the puncturing of the muffler or any engine component which conducts removal of engine exhaust gases.
2. Removal or alteration or the puncturing of any part of the intake system.
3. Replacing any moving parts of the vehicle or parts of the exhaust or intake system, with parts other than those specified by the manufacturer.
4. Lack of proper maintenance.

EMISSION REQUIREMENTS

USA Only

The California Air Resources Board (CARB) requires that your vehicle complies with applicable exhaust emissions standards during its useful life, when operated and maintained according to the instructions supplied.

A non-compliance RED label (as well as a GREEN label) is obtained annually during California Vehicle registration. The appropriate label is denoted by the vehicle identification number (in the 8th character detailed herein).

VEHICLE CATEGORY	VIN 8 TH CHARACTER
Non-complying RED label	Must denote a C or 3
Complying GREEN label	Any alphanumeric designation other than a C or 3

BREAK-IN PERIOD

Engine

A break-in period of 10 operating hours is required before running the vehicle at sustained full throttle.

CAUTION: Never mix oil with fuel.

During this period, maximum throttle should not exceed 3/4 opening. However, brief full acceleration and speed variations contribute to a good break-in. Continued wide open throttle accelerations, prolonged cruising speeds and engine overheating are detrimental during the break-in period.

Belt

A new belt requires a break-in period of 50 km (30 miles). Avoid strong acceleration/deceleration or high speed cruising.

10-Hour Inspection

NOTE: The 10-hour inspection is at the expense of the vehicle owner.

As with any precision piece of mechanical equipment, we suggest that after the first 10 hours or 30 days after the purchase, whichever comes first, your vehicle be inspected by an authorized Can-Am dealer. This inspection will give you the opportunity to discuss the unanswered questions you may have encountered during the first hours of operation.

CONTROLS/INSTRUMENTS/EQUIPMENT

NOTE: Some controls/instruments/equipment are optional.

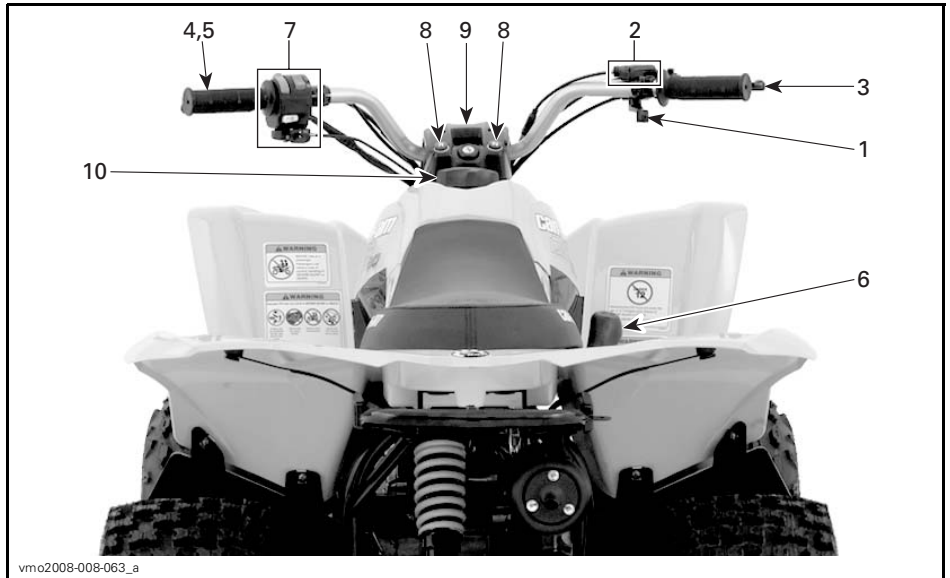

TYPICAL

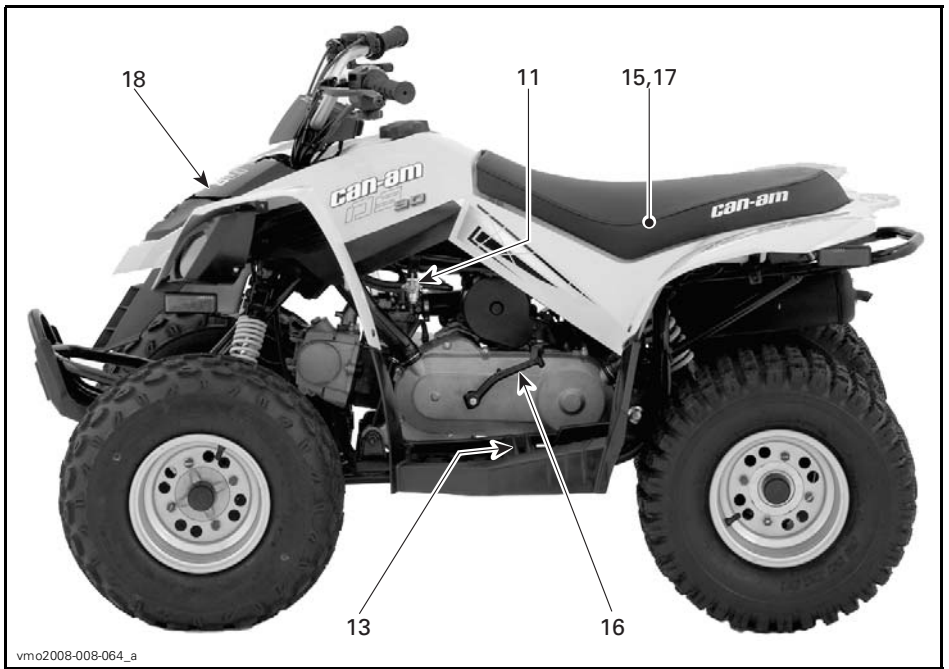

vmo2008-008-064_a

TYPICAL

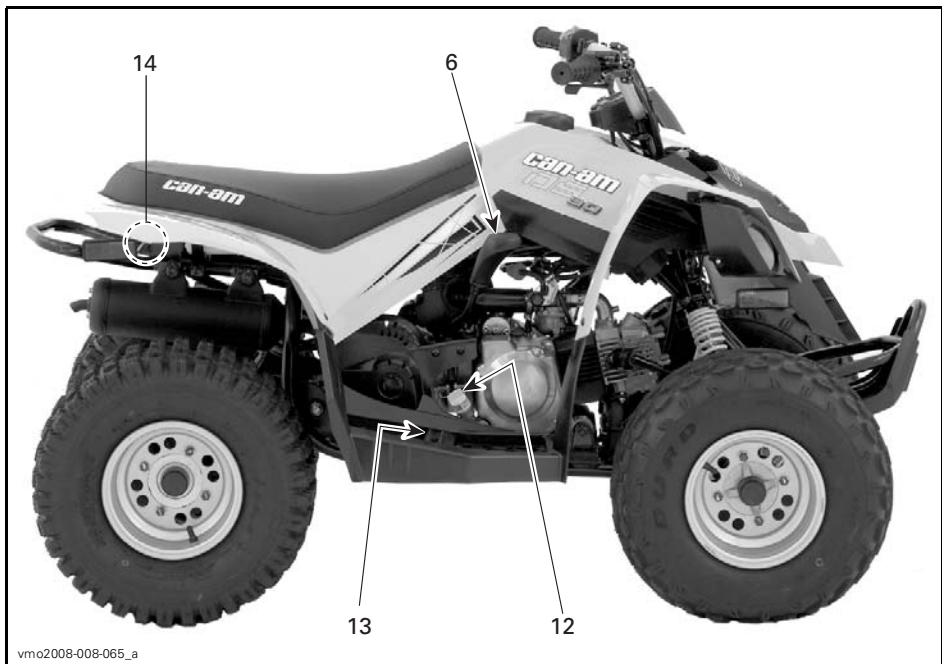

TYPICAL

While reading this Operator's Guide, remember that:

⚠ WARNING

Indicates a potential hazard that, if not avoided, could result in serious injury or death.

NOTE: This section gives basic functions of the various controls of your vehicle. For more details of how to operate one control in conjunction with some others, refer to *OPERATING INSTRUCTIONS* further in this section.

1) Throttle Lever

When pushed, it increases the engine speed that allows the engagement of the transmission.

When released, the engine speed should return automatically to idle and the vehicle will gradually slow down.

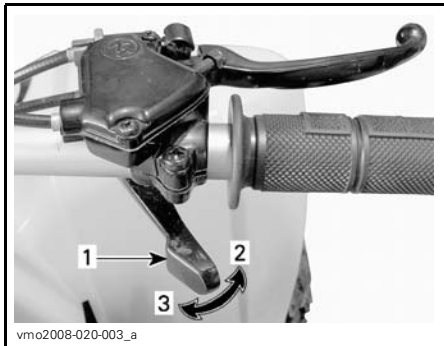

TYPICAL

1. Throttle lever
2. To accelerate
3. To decelerate

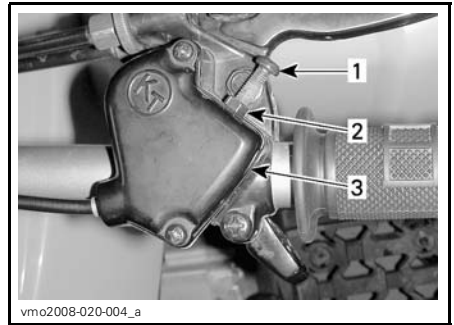

vmo2008-020-004_a

TYPICAL

1. Speed limiter screw
2. Lock nut
3. Throttle lever cable housing

Screwing in the speed limiter screw limits the maximum engine power available and decreases the maximum speed of the vehicle.

NOTE: DS70 are shipped from the factory with a restricted speed setting of 16 km/h (10 MPH) and DS90/DS90 X with a restricted speed setting of 24 km/h (15 MPH).

BRP recommend that all beginners start off with the speed limiter screw turned in while they learn.

Adults can unscrew the speed limiter screw gradually to increase maximum speed as the beginner becomes more familiar with the operation of the vehicle.

NOTE: The maximum unrestricted speed setting for the DS70 is 24 km/h (15 MPH), and the DS90/DS90 X, 48 km/h (30 MPH).

WARNING

Check throttle lever operation before you start the engine. If the throttle lever does not work smoothly, check for the cause. Correct the problem before riding the vehicle. Consult your authorized dealer if you can't find or solve the problem yourself.

2) Speed Limiter Screw

This vehicle is equipped with an adjustable speed limiter. The speed limiter keeps the throttle from fully opening, even when the throttle lever is pushed to the maximum.

WARNING

Adults should always limit the maximum restricted speed within the ability and capacity of the child to operate the vehicle safely. Never allow the child to adjust the speed limiter screw.

Refer to *SPEED LIMITER ADJUSTMENT* in *FUEL SYSTEM* section for proper adjustment.

⚠ WARNING

Improper adjustment of the speed limiter screw could damage throttle cable and impair throttle lever operation. Failure to follow adjustment recommendations could lead to an accident resulting in severe injuries including the possibility of death.

3) Front Brake Lever

When compressed, the brake is applied. When released, it should automatically return to its original position. Braking effect is proportional to the force applied on the lever and to the type and condition of the terrain.

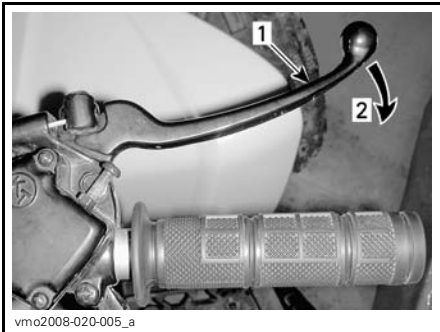

TYPICAL

1. Brake lever
2. To apply brake

4) Rear Brake Lever

When compressed, the brake is applied. When released, it should automatically return to its original position. Braking effect is proportional to the force applied on the lever and to the type and condition of the terrain.

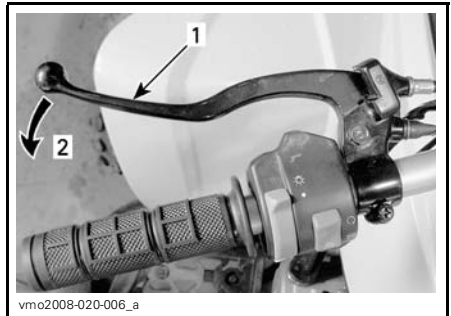

TYPICAL

1. Brake lever
2. To apply brake

5) Parking Brake

When applied, it prevents the vehicle from moving. Useful during transportation or when the vehicle is not in operation.

⚠ WARNING

Always use the parking brake when the vehicle is not in operation.

⚠ WARNING

Make sure parking brake is fully disengaged before operating the vehicle. When you ride the vehicle, brakes that are caused to drag by a continuous pressure on the lever may cause damage to the brake system and cause loss of braking capacity and/or fire.

To engage mechanism: Squeeze brake lever and maintain while moving lever lock. Brake lever is now compressed and applying brake(s).

All Models except DS90 X

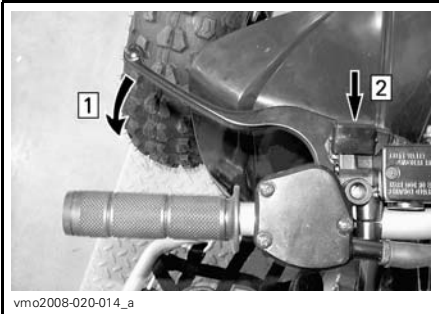

REAR BRAKE LEVER

Step 1: Squeeze brake lever and maintain
Step 2: Move lever lock

DS90 X Only

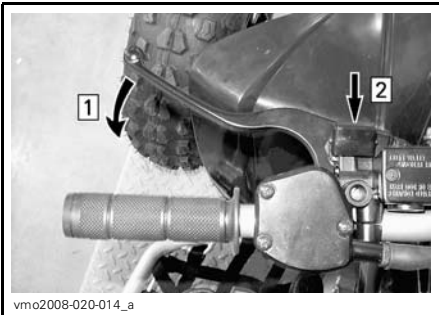

REAR BRAKE LEVER

Step 1: Squeeze brake lever and maintain
Step 2: Push lever lock

All Models

To release mechanism: Squeeze brake lever. Lever lock should automatically return to its original position. Brake lever should return to rest position. Always release parking brake before riding.

6) Transmission Lever

A 3-position lever.

CAUTION: Always completely stop the vehicle and apply the brakes prior to moving the transmission lever.

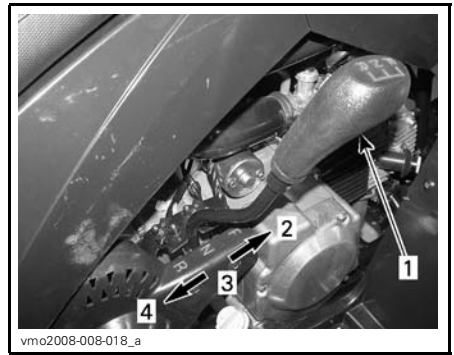

TRANSMISSION LEVER PATTERN

1. Transmission lever
2. Forward (F)
3. Neutral (N)
4. Reverse (R)

To change the transmission position, completely stop vehicle, apply brakes then move lever to the desired position while moving lever forward or backward. Do not force lever.

F: Forward

It is the normal driving range. It allows the vehicle to reach its maximum speed.

N: Neutral

This position disengages the transmission to allow manual vehicle movement or towing.

R: Reverse

This allows the vehicle to go backward.

WARNING

Before moving vehicle in reverse, ensure the path behind is clear of obstacles or bystanders. Remain seated.

7) Multi-Switch Housing

The controls located on this multi-switch housing are:



vmo2008-008-011_e

1. Engine stop switch
2. Engine start button
3. Daytime running lights switch
(if so equipped)
4. Choke lever

Engine Stop Switch

This switch can be used to stop engine and as an emergency control.

The engine will turn over but will not start if the engine stop switch is placed in the OFF position.

NOTE: While engine can be stopped by turning ignition key to OFF position, we recommend the engine be stopped by the engine stop switch.



vmo2008-008-011_a

1. Engine stop switch
2. OFF position
3. ON position

Engine Start Button

To start engine, place the engine stop switch to ON position.

Press and hold LH brake lever.

Press and hold the engine start button. Release immediately after engine is started.



vmo2008-008-011_b

1. Engine start button

To stop engine, fully release throttle lever then use the engine stop switch.

Daytime Running Lights Switch

All Models except DS90 X

Position daytime running lights switch to ON position to activate them. To turn them off, place daytime running lights switch to OFF position.

CAUTION: Using the daytime running lights for a prolonged time when the engine is not running will discharged the battery.

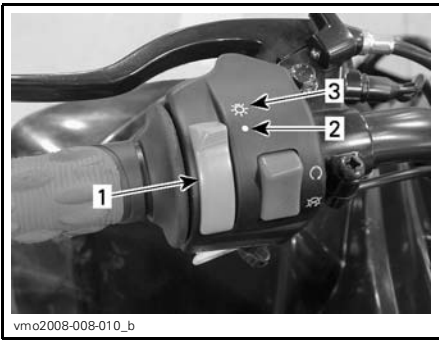

vmo2008-008-010_b

1. Daytime running lights switch
2. OFF position
3. ON position

Choke Lever

This device features a variable lever to ease engine cold start.

Position OFF is for normal use with a warm engine.



vmo2008-008-011_c

OFF POSITION

The full choke position is used for low-engine temperature.



vmo2008-008-011_d

FULL CHOKE POSITION

The other positions between OFF and FULL position, will be use depending on the engine temperature.

8) Indicator Lamps

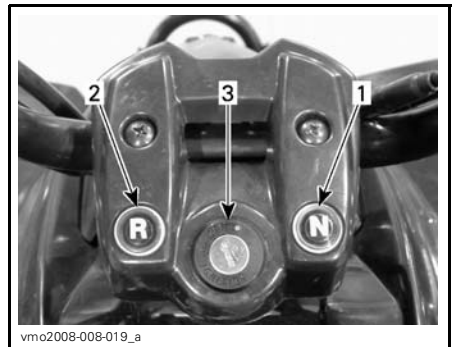

vmo2008-008-019_a

TYPICAL

1. Neutral (N)
2. Reverse (R)
3. Ignition switch

Neutral Lamp (GREEN)

 When lit, it indicates the transmission is in neutral position.

Reverse Lamp (RED)

 When lit, it indicates the transmission is in reverse position.

9) Ignition Switch

Key-operated, 2-position switch: OFF and ON.

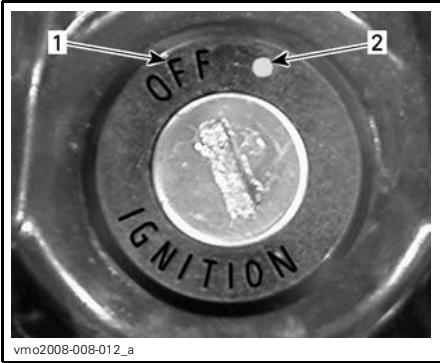

IGNITION SWITCH

1. OFF position
2. ON position

Insert key in switch and turn to ON position. To remove key, turn key to OFF position then pull it out.

NOTE: While engine can be stopped by turning ignition key to OFF position, we recommend the engine be stopped by the engine stop switch. Always turn ignition switch to OFF position after engine has been stopped.

10) Fuel Tank Cap

WARNING

Do not allow children to put fuel in the vehicle.

Unscrew to fill up tank then fully tighten.

NOTE: Refer to *FUELING PROCEDURE* in *LIQUIDS* section for proper fueling procedure.

WARNING

Always stop engine before refueling. Open cap slowly. If a differential pressure condition is noticed (whistling sound heard when loosening fuel tank cap) have vehicle inspected and/or repaired before further operation. Fuel is flammable and explosive. Never use an open flame to check fuel level. Never smoke or allow flame or spark in vicinity. Always work in a well-ventilated area. Never top off the fuel tank before placing the vehicle in a warm area. As temperature increases, fuel expands and may overflow. Always wipe off any fuel spillage from the vehicle.

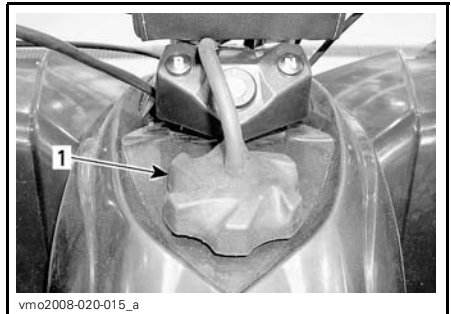

TYPICAL

1. Fuel tank cap

11) Fuel Valve

This is a 3-position rotary valve: OFF, ON, RES. Rotate the tab to align its pointer with ON, OFF or RES.

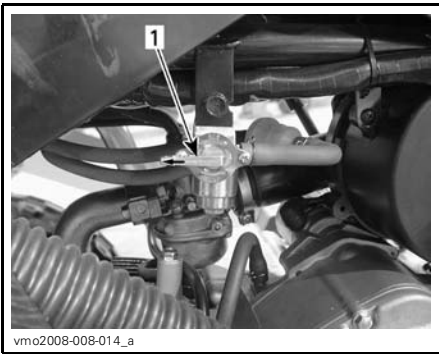

vmo2008-008-014_a

LH SIDE OF VEHICLE

1. Align this pointer toward the desired position

OFF

Stops fuel supply to carburetor.

CAUTION: Turn valve to OFF position when vehicle is not being operated or when transporting.

ON

Allows fuel to flow to carburetor. This is the normal position for operation of the vehicle.

RES. (reserve)

When fuel is exhausted in the fuel tank when in the ON position, an emergency supply of fuel is available by turning the knob to RES. Use this position only when the ON supply is empty.

When down to the reserve, refuel as soon as possible. Be sure to turn the valve back to the ON position after refuelling.

CAUTION: Improper opening of fuel valve will restrict the flow of fuel. Make sure valve is fully opened while running.

12) Engine Oil Dipstick

Allow to check the oil level in the engine.



vmo2008-008-021_a

TYPICAL — RH SIDE OF ENGINE

1. Dipstick

Refer to *LIQUIDS* to check the engine oil correctly.

13) Footpeg

Use this area to keep your feet stable.



vmo2008-020-009_a

DS90 X

1. Footpeg

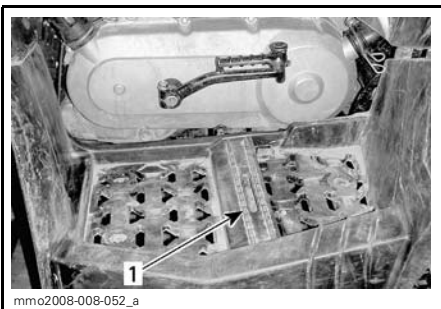

mmo2008-008-052_a

OTHERS

1. Footpeg

14) Seat Latch Knob

Located underneath rear fender, near rear bumper. It allows the removal of seat to give access to engine compartment. Pull knob to release seat.

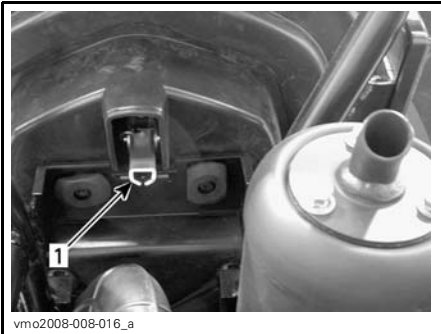

vmo2008-008-016_a

TYPICAL

1. Seat release knob

Seat Removal

Pull latch while gently lifting rear of seat. Pull seat rearward then remove it.

Seat Installation

Insert front tabs of seat into frame hooks. When seat rests in its position, firmly push seat down to latch.

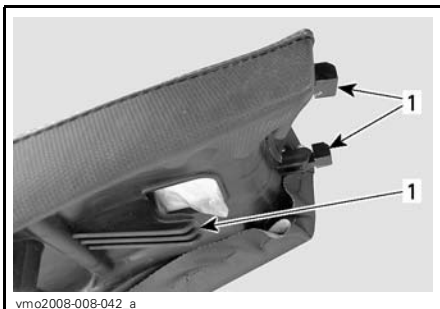

vmo2008-008-042_a

1. Seat tabs

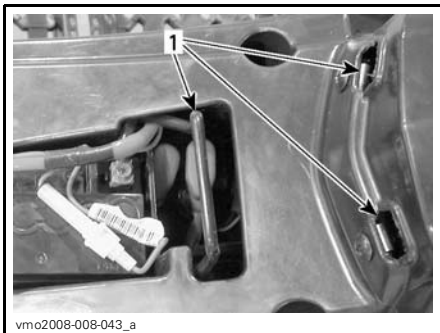

vmo2008-008-043_a

1. Hooks

WARNING

Make sure seat is securely latched before riding.

15) Fuse

The electrical system is protected with a fuse. Refer to *MAINTENANCE INFORMATION* for details.

The fuse holder is located on the RED (+) cable, near battery.



vmo2008-008-017_a

1. Fuse holder

16) Kick Start Pedal

The kick start pedal is provided as an emergency starting device.

Follow the usual starting procedure; but use the kick start pedal instead of the electric starter. Refer to *EMERGENCY MANUAL STARTING* in *OPERATING INSTRUCTIONS* section.

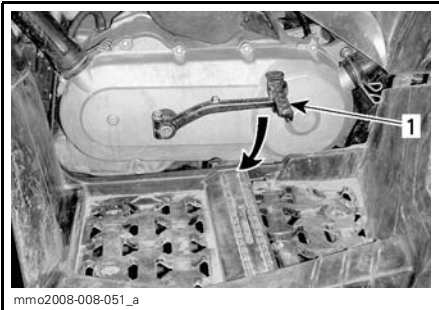

mimo2008-008-051_a

TYPICAL

1. Kick start pedal

17) Tool Kit

Located underneath the seat in engine compartment, the tool kit contains tools for basic maintenance.

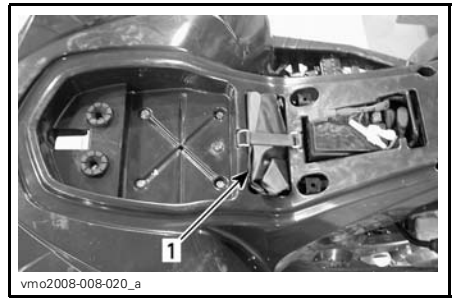

vmo2008-008-020_a

1. Tool kit

18) Front Storage Compartment

A convenient area to carry personal articles.

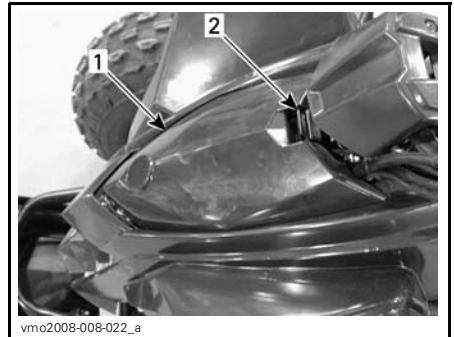

vmo2008-008-022_a

1. Front storage compartment
2. Cover latch

To open storage compartment cover, gently pull and hold latch while lifting cover.



vmo2008-008-023_a

 **WARNING**

When engine is running, always engage the NEUTRAL position on the transmission lever and apply parking brake before opening cover. Never leave any heavy or loose breakable objects in the storage compartment. Always latch cover before riding.

LIQUIDS

While reading this Operator's Guide, remember that:

WARNING

Indicates a potential hazard that, if not avoided, could result in serious injury or death.



This section specifies the recommended liquids of your vehicle and procedures on how to check their levels. For liquids replacement, refer to *MAINTENANCE INFORMATION* section.

WARNING

The following procedures should be done by an adult only.

Quick Reference Chart

NOTE: For more details, refer to *RECOMMENDED FUEL* and *RECOMMENDED OIL* further in this section.

UNLEADED FUEL MINIMUM OCTANE NUMBER:		
	Inside North America	(87 (R + M/2))
	Outside North America	92 RON
ENGINE OIL:		
	Recommended	SAE 10W 40 API classification SM, SL or SJ
	Preferred	XP-S 5W 40 synthetic oil

Overview

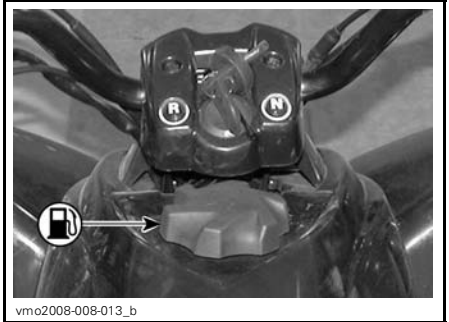

TYPICAL — FUEL TANK CAP



TYPICAL — ENGINE OIL

Fuel

Recommended Fuel

Use unleaded gasoline available from most service stations or oxygenated fuel containing a maximum total of 10% of ethanol or methanol or both. The gasoline used must have the following recommended minimum octane number.

OCTANE NUMBER	
Inside North America	(87 (R + M)/2)
Outside North America	92 RON

CAUTION: Never experiment with other fuels. The use of unrecommended fuel can result in vehicle performance deterioration and damage to critical parts in the fuel system and engine components.

Fueling Procedure

WARNING

Do not allow children to put fuel in the vehicle.

Stop engine.

Do not allow anyone to remain seated on the vehicle while filling.

Unscrew fuel tank cap counterclockwise to remove.

Insert the spout into the filler neck.

Pour fuel slowly so that air can escape from the tank and prevent fuel flow-back. Be careful not to spill fuel.

Do not overfill. Stop filling when the fuel reaches the bottom of filler neck. Fully tighten fuel tank cap clockwise.

WARNING

Always stop engine before refueling. Open cap slowly. If a differential pressure condition is noticed (whistling sound heard when loosening fuel tank cap) have vehicle inspected and/or repaired before further operation. Fuel is flammable and explosive under certain conditions. Never use an open flame to check fuel level. Never smoke or allow flame or spark in vicinity. Always work in a well-ventilated area. Never top off the fuel tank before placing the vehicle in a warm area. As temperature increases, fuel expands and may overflow. Always wipe off any fuel or oil spillage from the vehicle.

Engine Oil

Recommended Oil

Use 4-stroke engine oil that meets or exceeds the requirements for API service classification SM, SL or SJ. Always check the API service label certification on the oil container, it must contain at least one of the above standards.

Recommended Oil Viscosity

SAE 10W 40 oil is recommended for all seasons.

However, during the hottest days of the summer the BRP XP-S 10W 40 mineral oil (P/N 219 700 346) can be used.

NOTE: For improved overall performance and all season application, use XP-S 5W 40 synthetic oil (P/N 293 600 039).

Oil Viscosity Chart

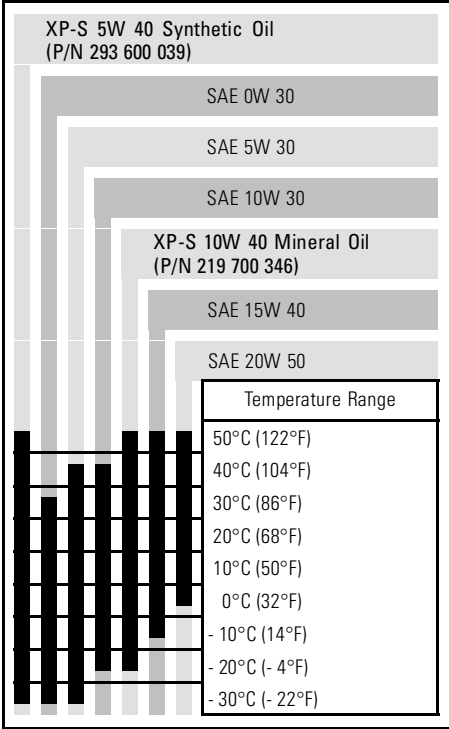

TYPICAL — RH SIDE OF ENGINE
1. Dipstick

With vehicle on a level surface, start engine and let it running for several minutes, then stop engine check the oil level as follows:

1. Unscrew dipstick then remove it and wipe clean.
2. Reinstall dipstick (**do not screw it in**).
3. Remove and check oil level. It should be near or equal to the upper per mark.

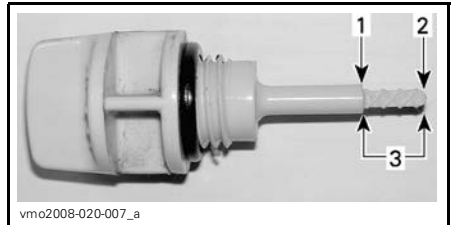

1. Full
2. Add
3. Operating range

To add oil, remove dipstick. Place a funnel into the dipstick hole to avoid spillage.

Add a small amount of oil and recheck oil level.

Repeat until oil level reaches the dipstick's upper mark. **Do not overfill.**

Properly tighten dipstick.

Engine Oil Level

CAUTION: Check level frequently and refill if necessary. Do not overfill. Operating the engine with an improper level may severely damage engine. Wipe off any spillage.

Brake Fluid

DS90 X Only

Recommended Fluid

Always use brake fluid meeting the specification DOT 4 only.

CAUTION: To avoid serious damage to the braking system, do not use fluids other than the recommended one, nor mix different fluids for topping up.

Fluid Level

With vehicle on a level surface, check brake fluid in reservoirs for proper level. They should be above MIN. mark.

Add fluid as required. **Do not overfill.**

Clean filler cap before removing.

CAUTION: Use only DOT 4 brake fluid from a sealed container. Do not use brake fluid taken from old or already opened containers.

NOTE: A low level may indicate leaks or worn brake pads. See an authorized Can-Am dealer.

Front and Rear Brake Lever Fluid Reservoir

Brake fluid reservoirs are located on the handlebar above brake levers.



LH REAR BRAKE FLUID RESERVOIR

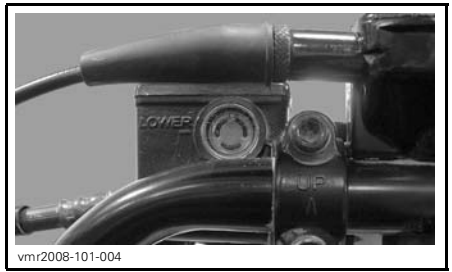

RH FRONT BRAKE FLUID RESERVOIR

Turn steering in the straight-ahead position to ensure reservoirs are levelled.

Check fluid level, the reservoir is full when the fluid reaches of the top of window.



TYPICAL

1. Minimum
2. Maximum

Visually inspect lever boot condition. Check for cracks, tears, etc. Replace if damaged.

Repeat the same procedure for the other reservoir.

TIRES AND RIMS

While reading this Operator's Guide, remember that:

WARNING

Indicates a potential hazard that, if not avoided, could result in serious injury or death.

Tire Pressure

WARNING

Tire pressure greatly affects vehicle handling and stability. Underpressure may cause tire to deflate and rotate on wheel. Overpressure may burst the tire. Always follow recommended pressure. Since tires are low-pressure types, a manual pump should be used.

Check pressure when tires are «cold» before using the vehicle. Tire pressure changes with temperature and altitude. Recheck pressure if one of these conditions has changed.

For your convenience, a pressure gauge is supplied in tool box.

TIRE PRESSURE	
FRONT AND REAR	
MINIMUM	25 kPa (3.5 PSI)
MAXIMUM	35 kPa (5 PSI)

Although the tires are specifically designed for off-road use, a flat may still occur. Therefore, it is recommended to carry a tire pump and a repair kit.

Tire/Rim Condition

Check tires and rims for damage and wear.

Replace if necessary.

OPERATING INSTRUCTIONS

Starting the Engine

WARNING

Always proceed with the pre-operation check as described in the **SAFETY INFORMATION** section prior to operating the vehicle. Always check the proper operation of critical controls, safety features and mechanical components before starting. If not done as specified, severe injury or death might occur.

Insert key in ignition switch and turn to ON position.



TYPICAL — TURN TO ON POSITION

1. Ignition key

Place the engine stop switch to ON position.



1. Engine stop switch
2. OFF position
3. ON position

In cold weather, colder than 0°C (32°F), place choke lever in full choke position.



FULL CHOKE POSITION

Press and hold LH brake lever.

Press the engine start button and hold until engine starts.



1. Engine start button

NOTE: Overusing choke may flood engine and make it hard to start. Refer to *SPECIAL PROCEDURES* if it occurs.

When the engine is warm, place choke lever to OFF position and release brakes.



OFF POSITION

CAUTION: Do not hold start button more than 10 seconds. A rest period should be observed between the cranking cycles to let starter cool down. Pay attention to battery; do not discharge it.

NOTE: Throttle assist may be used to help starting the engine faster. Press the throttle lever slightly; if it is pressed too much, the choke system will not be activated.

Warm Engine Starting

Start the engine as explained above but without any choke. If the engine will not start after two 5-second attempts with the electric starter, adjust choke lever in half way position. Start the engine without activating the throttle lever. After few seconds, set the choke lever to OFF position.

Emergency Manual Starting

Manual start is provided in the event electric start does not work.

Follow the starting procedure above but instead use the kick start pedal instead of the electric starter.

To start engine, gently press pedal down until engagement is felt, then kick down with a rapid follow through motion.

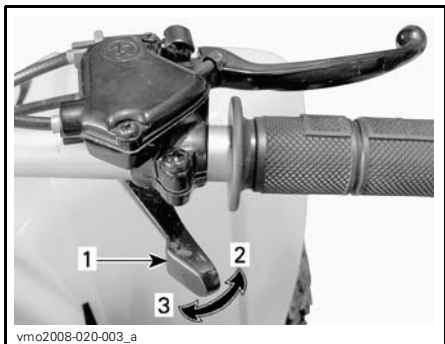

TYPICAL

1. Throttle lever
2. To accelerate
3. To decelerate

Release the engine start button immediately when engine has started.

After a few seconds, adjust choke lever until the best engine RPM is achieved.

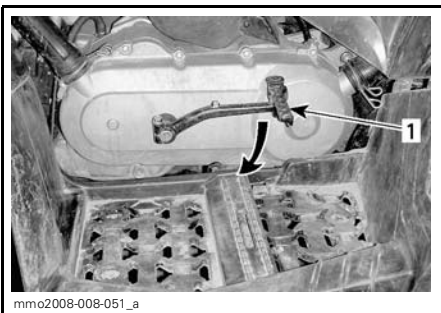

mmo2008-008-051_a

TYPICAL

1. Kick start pedal

Repeat this procedure completely if necessary.

Stopping the Engine

WARNING

Avoid parking on a slope.

Release throttle and completely stop the vehicle.

Apply the parking brake.

Push the engine stop switch to OFF position.

Turn key in ignition switch to OFF position.

Remove key from ignition switch.

Post-Operation Care

Never use a high pressure washer to clean these vehicles. **USE LOW PRESSURE ONLY (like a garden hose)**. High pressure can cause electrical and mechanical damages.

When vehicle is used in salt-water environment (beach area), rinsing the vehicle with fresh water is necessary to preserve vehicle and its components. Metallic parts lubrication is highly recommended. Use XP-S Lube.

This must be performed at the end of each operating day.

When vehicle is operated in muddy conditions, rinsing the vehicle is recommended to preserve vehicle and its components and to keep lights clean.

SUSPENSION ADJUSTMENT

WARNING

Left and right front shock adjustment must always be set at the same position. Never adjust one shock only. Uneven adjustment can cause poor handling and loss of stability, which could lead to an accident.

Spring Preload Adjustment

Shorten the spring for a firmer ride and rough road condition.

Lengthen the spring for a softer ride and smooth road condition.

Adjust by turning adjusting cam or ring accordingly. Use tool from vehicle tool kit.

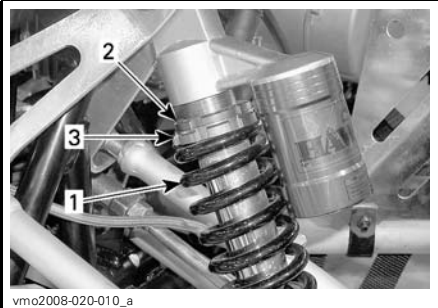

DS90 X — FRONT SUSPENSION

1. Front spring
2. Loosen locking ring
3. Turn adjustment ring



OTHERS — FRONT SUSPENSION

1. Front spring
2. Turn adjusting cam

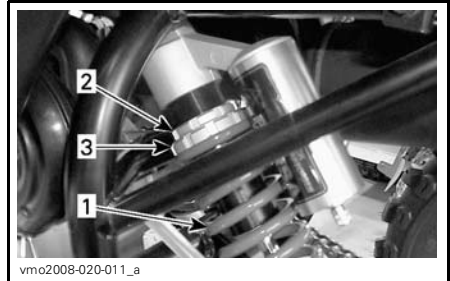

DS90 X — REAR SUSPENSION

1. Rear spring
2. Loosen locking ring
3. Turn adjustment ring

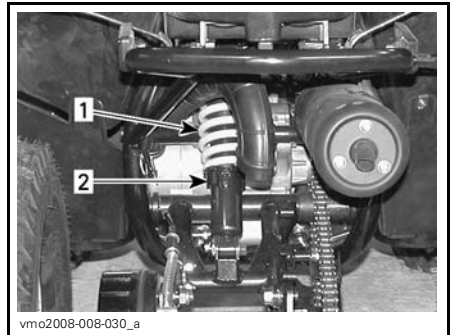

OTHERS — REAR SUSPENSION

1. Rear spring
2. Turn adjusting cam

SPECIAL PROCEDURES

Turn Over

When vehicle is turned over or stays tilted on the side, replace the vehicle in its normal operation position (on all four wheels) and wait 3 to 5 minutes before starting engine. Check oil level and refill if necessary.

Vehicle Immersion

Should the vehicle become immersed, it will be necessary to take it to an authorized Can-Am dealer as soon as possible. **DO NOT START THE ENGINE!** Immersion of the vehicle can cause serious damage if the correct restart procedure is not followed.

TRANSPORTING THE VEHICLE

While reading this Operator's Guide, remember that:

WARNING

Indicates a potential hazard that, if not avoided, could result in serious injury or death.

When transporting a vehicle, secure vehicle to trailer with suitable tie-downs. Using ordinary ropes is not recommended.

WARNING

Never tip this vehicle on end for transporting. We recommend that you carry the vehicle in its normal operating position (on all four wheels).

Place the fuel valve to OFF position.

Apply the parking brake.

Secure the vehicle to front by the front bumper and rear by the rear bumper.

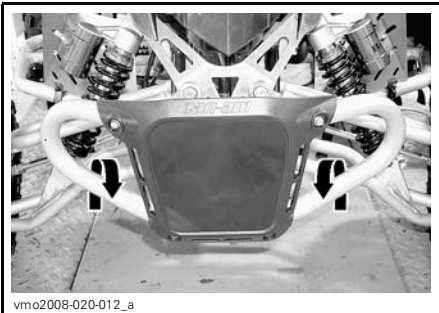

FRONT LOCATION — DS90 X



FRONT LOCATION — OTHERS

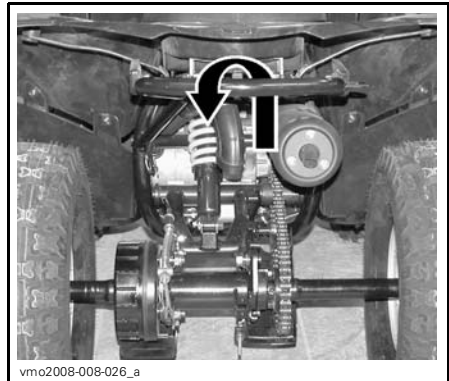

REAR LOCATION — ALL MODELS

CAUTION: Attaching vehicle at other locations may damage the vehicle.

WARNING

Do not tow this vehicle behind a car or other vehicle. Use a trailer.

TROUBLESHOOTING

ENGINE DOES NOT TURN

- 1. Ignition switch is in the OFF position.**
 - Place switch to the ON position.
- 2. Burnt fuse.**
 - Check main supply fuse.
- 3. Weak battery or loose connections.**
 - Check connections and terminals condition.
 - Have the battery checked.
 - Contact an authorized Can-Am dealer.

ENGINE TURNS OVER BUT FAILS TO START

- 1. Engine stop switch is in the OFF position.**
 - Place switch to the ON position.
- 2. Mixture not rich enough to start cold engine.**
 - Check fuel tank level and check starting procedure, particularly use of the choke.
- 3. Flooded engine (spark plug wet when removed).**
 - When the engine does not start after several attempts, the engine may be fuel flooded. Proceed as follows:
 - Turn ignition switch to ON and ensure choke is not applied.
 - Fully press throttle lever and hold while starting the engine.
 - As soon as the engine starts, release throttle lever. Do not race engine.
 - If it does not work:**
 - Disconnect the spark plug cable.
 - Remove the spark plug.
 - Crank engine several times. Install new spark plug if possible or clean and dry spark plug.
 - Start engine as explained above. If engine continues to flood, see an authorized Can-Am dealer.
- 4. No fuel to the engine (spark plug dry when removed).**
 - Check fuel tank level; turn fuel valve to ON (also try on RES.). A failure of the fuel pump or carburetor may have occurred.
 - Contact an authorized Can-Am dealer.
- 5. Spark plug/ignition (no spark).**
 - Remove spark plug then reconnect to spark plug cap.
 - Check that ignition switch and/or engine stop switch is/are at the ON position.
 - Start engine with spark plug grounded to the engine away from spark plug hole. If no spark appears, replace spark plug.
 - If trouble persists, contact an authorized Can-Am dealer.

ENGINE TURNS OVER BUT FAILS TO START (cont'd)

6. Engine compression.

- *As the engine is pulled over with the kick stater, “cycles” of resistance should be felt as piston goes past top dead center. If no pulsating resistance is felt, it suggests a major loss of compression. Contact an authorized Can-Am dealer.*

ENGINE LACKS ACCELERATION OR POWER

1. Fouled/damage/worn spark plug.

- *Clean/verify spark plug and heat range. Replace as required.*

2. Lack of fuel to engine.

- *Check item ENGINE TURNS OVER BUT FAILS TO START.*

3. Carburetor adjustments.

- *Contact an authorized Can-Am dealer.*

4. Engine is overheating.

- *If engine overheats try the following:*
 - *Reduce vehicle speed but try to keep vehicle moving to supply air to engine. If engine is still overheating after approximately one minute, stop vehicle.*
 - *Apply parking brake and stop engine.*
 - *Let engine cool down.*
 - *See an authorized Can-Am dealer as soon as possible.*
- *If overheating persists, contact an authorized Can-Am dealer.*

5. Air filter/box plugged or dirty.

- *Check air filter and clean if necessary.*
- *Check the position of the air intake tube.*

6. CVT dirty or wear.

- *Contact an authorized Can-Am dealer.*

ENGINE BACKFIRE

1. Exhaust system leakage.

- *Contact an authorized Can-Am dealer.*

2. Engine is running too hot.

- *See ENGINE LACKS ACCELERATION OR POWER.*

3. Ignition timing is incorrect or there is an ignition system failure.

- *Contact an authorized Can-Am dealer.*

4. Improper carburetor setting.

- *Contact an authorized Can-Am dealer.*

ENGINE MISFIRE

1. Fouled/damaged/worn spark plug.

- *Clean/verify spark plug and heat range. Replace as required.*

ENGINE MISFIRE (cont'd)

2. Water in fuel.

- *Drain fuel system and refill with fresh fuel.*

VEHICLE CANNOT REACH FULL SPEED

1. Engine.

- *See ENGINE LACKS ACCELERATION OR POWER.*

2. Parking brake.

- *Ensure brake lever lock is completely removed.*

3. Air filter/box plugged or dirty.

- *Check air filter and clean if necessary.*
- *Check the position of the air intake tube.*

4. CVT dirty or wear.

- *Contact an authorized Can-Am dealer.*

THE RPM INCREASES BUT THE VEHICLE DOES NOT MOVE

1. CVT is defective.

- *Contact an authorized Can-Am dealer.*

2. Water in the CVT housing.

- *Contact an authorized Can-Am dealer.*

SPECIFICATIONS

MODEL		DS70	DS90/DS90 X
ENGINE			
Type		4-stroke, forced air cooled	
Number of cylinder		Single horizontal cylinder	
Displacement		69.36 cc (4.23 cu. in)	89.53 cc (5.46 cu. in)
Starting		Electric/kick start	
TRANSMISSION			
Transmission		Continuously Variable Transmission (CVT)	
CARBURETION			
Carburetor	Make	KEHIN with manual choke	
	Type	PTE	
Idle speed		± 100	1700 RPM
ELECTRICAL			
Ignition type		CDI (Capacitor Discharge Ignition)	
Spark plug	Make	NGK	
	Type	CR7HSA	
	Gap	0.6 to 0.7 mm (.024 to .027 in)	
Number of spark plug		1	
Battery	Type	Maintenance free	
	Volt	12 volts, 4 A•h	
Starting system		Electric start/kick start	
Daytime running light bulb		2 x 5 W	
Taillight bulb		N.A.	
Fuse	Main	15 A	

MODEL		DS70	DS90/DS90 X
SUSPENSION			
Type	Front	Independent suspension – A-arm DS90 X: independent suspension – Double A-arm	
	Rear	Rigid swing arm	
Travel	Front	86 mm (3.4 in) DS90 X: 178 mm (7 in)	
	Rear	160 mm (6.3 in) DS90 X: 229 mm (9 in)	
Shock absorber		Oil DS90 X: HPG	
TIRES			
Pressure	Front	25 kPa (3.5 PSI) minimum 35 kPa (5 PSI) maximum	
	Rear		
Size	Front	19 x 7-8 DS90 X: 20 x 6-10	
	Rear	18 x 9.5-8 DS90 X: 18 x 10.5-9	
WHEELS			
Size	Front	8 x 5.5 DS90 X: 10 x 5.5	
	Rear	8 x 7 DS90 X: 9 x 8	
Wheel nuts torque	Front	71 N•m (52 lbf•ft)	
	Rear	120 N•m (89 lbf•ft)	
BRAKES			
Front		Mechanical, drum DS90 X: hydraulic, disc	
Rear		Mechanical, drum DS90 X: hydraulic, disc	
Parking device		LH brake lever with parking brake	

MODEL		DS70	DS90/DS90 X
DIMENSIONS			
Dry weight		114 kg (251 lb)	
Overall length		152 cm (59.8 in) DS90 X: 142 cm (56 in)	
Overall width		90.5 cm (35.6 in) DS90 X: 109.2 cm (43 in)	
Overall height		93.5 cm (36.8 in)	
Wheel base		100 cm (39.4 in)	
Ground clearance		11.5 cm (4.5 in)	
LIQUIDS			
Engine Oil type		SAE10W 40 API classification SM, SL or SJ, XP-S 5W 40 synthetic oil is recommended	
Gearbox Oil Type		XP-S synthetic chaincase oil	
Fuel	Type	Unleaded gasoline	
	Octane	Inside North America	(87 (R + M)/2) or higher
		Outside North America	92 RON
CAPACITIES			
Engine oil		Oil change with filter: 1.1 L (1.16 U.S. quarts)	
Gearbox oil		165 mL (6 U.S. oz)	
Fuel tank		6 L (1.6 U.S. gal)	

A: Ampere

V: Volt

A•h: Ampere hour

W: Watt

RPM: Revolution Per Minute

Because of our ongoing commitment to product quality and innovation, BRP reserves the right, at any time, to make changes in design and specifications and/or to make additions to, or improvements in its products without imposing any obligation upon itself to install them on its products previously manufactured.

MAINTENANCE INFORMATION

MAINTENANCE CHART

The maintenance is very important, if you are not familiar with safe service practices and adjustment procedures, see your authorized Can-Am dealer.

PERIODIC MAINTENANCE CHART						
A: ADJUST C: CLEAN I: INSPECT L: LUBRICATE R: REPLACE	INITIAL INSPECTION 10 HOURS OR 30 DAYS					
	(To be performed by an authorized Can-Am dealer. The initial maintenance is very important and must not be neglected.)					
	WEEKLY					
	MONTHLY					
	ONCE A YEAR OR EVERY 100 HOURS					
TO BE PERFORMED BY					LEGEND	
PART/TASK						
ENGINE						
Engine oil level ⁽¹⁾		EVERY RIDE			Customer	(1) Pre-ride inspection item. (3) More often under severe use such as dusty area, sand, snow, wet or muddy conditions. (5) Inspect every 6 months. (6) Replace every 3 months or 40 hours.
Engine oil	R		R ⁽⁶⁾		Customer	
Engine oil strainer				C	Customer	
Air filter/air injection valve filter ⁽³⁾		I, C		R	Customer	
Engine idle speed	I		I		Dealer	
Valve clearance	I			A	Dealer	
Crankcase breather system			I ⁽⁵⁾	I	Dealer	
Spark arrester				C	Customer	
Exhaust system				I	Dealer	
FUEL SYSTEM						
Fuel lines and connections	I			I	Dealer	(2) Inspect and adjust every 6 months. (4) Replace every 2 years or 200 hours.
Fuel filter				⁽⁴⁾	Dealer	
Throttle cable/housing	I, A		I, A	I, A, L	Dealer/Customer	
Carburetor	I, A		⁽²⁾	C, A	Dealer	

PERIODIC MAINTENANCE CHART

A: ADJUST
 C: CLEAN
 I: INSPECT
 L: LUBRICATE
 R: REPLACE

INITIAL INSPECTION 10 HOURS OR 30 DAYS

(To be performed by an authorized Can-Am dealer. The initial maintenance is very important and must not be neglected.)

WEEKLY

MONTHLY

ONCE A YEAR OR EVERY 100 HOURS

TO BE PERFORMED BY

PART/TASK

LEGEND

ELECTRICAL

PART/TASK	I	L	C	A	R	BY	LEGEND
Spark plug		I			R	Dealer	—
Battery connections	I			I		Customer	
Battery voltage	I			I		Dealer	

DRIVE TRAIN

PART/TASK	I	L	C	A	R	BY	LEGEND
Drive chain lubrication/adjustment					EVERY RIDE	Customer	(3) More often under severe use such as dusty area, sand, snow, wet or muddy conditions.
Drive chain roller inspection					EVERY RIDE	Customer	
Sprockets wear ⁽³⁾					I	Dealer	
Wheels bearing condition					I	Customer	
Wheel bolts	I				I	Customer	
Tire pressure and wear					EVERY RIDE	Customer	

TRANSMISSION (CVT)

PART/TASK	I	L	C	A	R	BY	LEGEND
Drive belt					I	Dealer	—
Drive and driven pulleys					I, C, L	Dealer	
CVT air inlet/outlet ducts	I				I, C	Customer	

GEARBOX

PART/TASK	I	L	C	A	R	BY	LEGEND	
Gearbox oil					R	(4)	Dealer	(4) Replace every 2 years or 200 hours.

PERIODIC MAINTENANCE CHART

INITIAL INSPECTION 10 HOURS OR 30 DAYS

(To be performed by an authorized Can-Am dealer. The initial maintenance is very important and must not be neglected.)

WEEKLY

MONTHLY

ONCE A YEAR OR EVERY 100 HOURS

TO BE PERFORMED BY

A: ADJUST
C: CLEAN
I: INSPECT
L: LUBRICATE
R: REPLACE

PART/TASK

LEGEND

STEERING SYSTEM

Handlebar fasteners ⁽¹⁾	I	A		I	Dealer	(1) Pre-ride inspection item. (5) Lubricate every 6 months.
Steering knuckles (all models except DS90 X)			(5)	L	Customer	
Steering shaft				L	Dealer	
Steering system				I	Dealer	

SUSPENSION

Suspension system				I	Customer	—
-------------------	--	--	--	---	----------	---

BRAKES ⁽⁷⁾

Brake fluid (DS90 X) ^{(1) (7)}	I	I		(4) (7)	Dealer/ Customer	(1) Pre-ride inspection item. (4) Replace every 2 years or 200 hours. (7) Brake fluid replacement or any brake system repairs must be performed by an authorized Can-Am dealer. (8) Hydraulic brakes are self-adjusting and require no adjustment.
Brake system ^{(1) (7)}	I		I, A (8)	A (8)	Dealer	
Brake pads/shoe wear ⁽⁷⁾				I	Dealer	

BODY/FRAME

Fasteners tightness ⁽¹⁾	I	I			Customer	(1) Pre-ride inspection item.
------------------------------------	---	---	--	--	----------	-------------------------------

GENERAL

While reading this Operator's Guide, remember that:

WARNING

Indicates a potential hazard that, if not avoided, could result in serious injury or death.

WARNING

Unless otherwise specified, engine should not be running for all maintenance procedures.

Before performing any service or inspection operation on the vehicle, wait until the engine and exhaust have cooled down to avoid potential burns.

WARNING

Should removal of a locking device (e.g. lock tabs, self-locking fasteners, etc.) be required when undergoing disassembly/assembly, always replace with a new one.

WARNING

All maintenance should be done by an adult or an authorized Can-Am dealer. Do not allow children to attempt repairs or maintenance.

The following covers the maintenance items that can be performed by the customer if desired. Other items found in *MAINTENANCE CHART* must be performed by an authorized Can-Am dealer.

NOTE: Among other things, this section gives the procedures to replace the liquids. Refer to *LIQUIDS* for procedures to check levels and refill.

ENGINE

Oil Change

Oil change should be done with a warm engine.

WARNING

The engine oil can be very hot. Wait until engine oil is warm.

Ensure vehicle is on a level surface.

Remove dipstick.



TYPICAL — RH SIDE OF ENGINE

1. Dipstick

Clean the drain plug area.

Place a drain pan under the engine drain plug area.

Unscrew drain plug.



LH SIDE OF ENGINE

1. Drain plug

Allow enough time for oil to flow out of engine.

Remove oil strainer and spring for cleaning if necessary, refer to *MAINTENANCE CHART* for details.

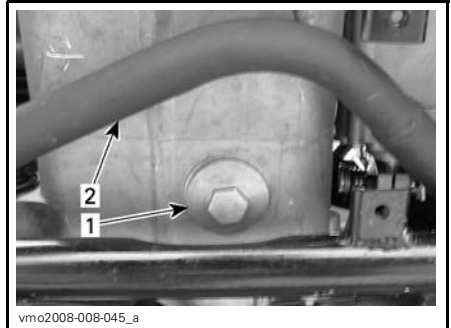

UNDERNEATH ENGINE

1. Oil strainer cover
2. Exhaust pipe

To clean oil strainer, use a solvent then dry with compressed air.

WARNING

Always wear eye protector. Chemicals can cause a rash break out and an injury to your eyes.

NOTE: Check cover O-ring and replace it if necessary.

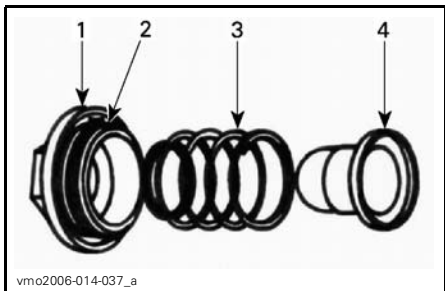

vmo2006-014-037_a

TYPICAL

1. Cover
2. O-ring
3. Spring
4. Strainer

Wipe out any oil spillage on engine.
 Reinstall oil strainer, spring and O-ring.
 Torque to 42 N•m (31 lbf•ft).
 Verify drain plug washer condition and replace it if necessary.

Clean washer area on engine and drain plug, then reinstall plug and torque it to 22 N•m (16 lbf•ft).

Refill engine at the proper level with the recommended oil. Refer to *SPECIFICATIONS* for capacity.

Start engine and let idle for a few minutes. Ensure oil strainer area and drain plug areas are not leaking.

Stop engine. Wait a while to allow oil to flow down to crankcase then check oil level. Refill as necessary.

Dispose of oil as per your local environmental regulations.

Air Filter Housing Draining

Periodically inspect air filter housing drain tube for liquids water or deposits.

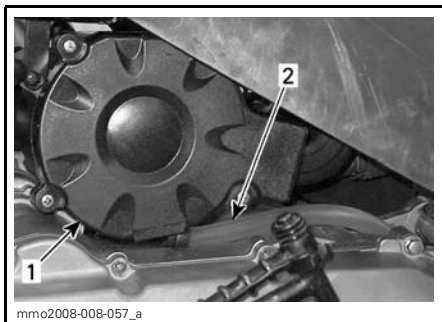

mmo2008-008-057_a

1. Air filter housing
2. Drain tube

NOTE: If vehicle is used in dusty area, inspect more frequently than specified in *MAINTENANCE CHART*.

If liquids/deposits are found, squeeze and remove the clamp. Pull drain tube plug out. and empty it.

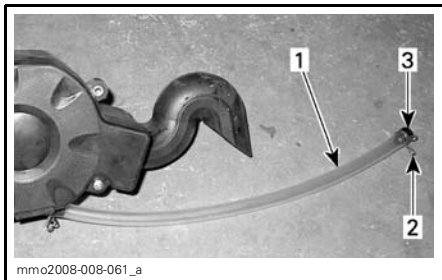

mmo2008-008-061_a

1. Drain tube
2. Clamp
3. Plug

CAUTION: Do not start engine when liquids/deposits are found in the drain tube.

When liquids/deposits are found, the air filter must be inspected/dried/replaced depending on its condition.

Remove air filter as explained below.

Air Filter Cleaning

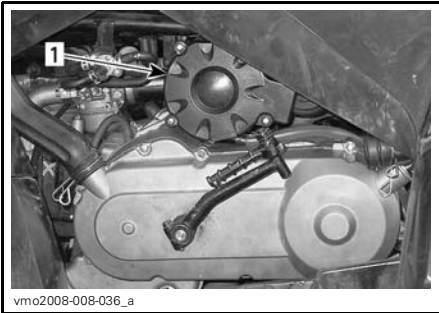

1. Air filter location

Removal

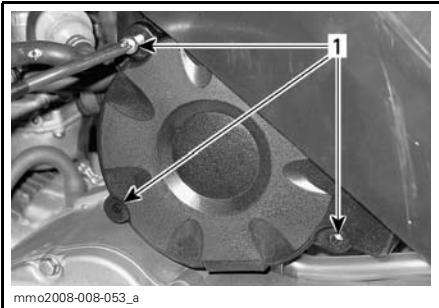

REMOVE AIR FILTER BOX COVER

1. Screws



REMOVE AIR FILTER FROM HOUSING

1. Air filter

Cleaning

Pour cleaning solution (P/N 219 700 341) or an equivalent into a bucket. Put the filter in to soak.

While filter soaks, clean inside the air filter housing.

Rinse the filter with warm water until all cleaning solution disappears.

Then, let the filter dry completely.

When the filter is dried, re-oil with air filter oil (P/N 219 700 340) or an equivalent.

Installation

Installation is the reverse of removal procedure.

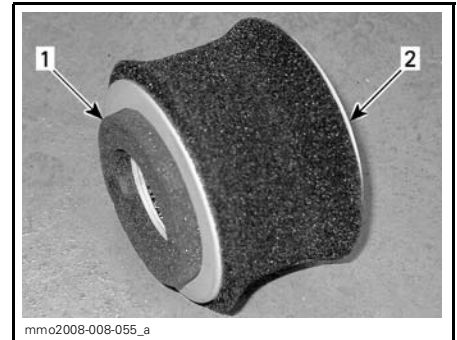

FILTER POSITION

1. Cover side
2. Housing side

Air Injection Valve Filter Cleaning

Air injection valve is located on the LH side of the vehicle underneath front fender.



TYPICAL

1. Air injection valve

Clean air injection valve cover before removing.

Remove cover to gain access to air filter.

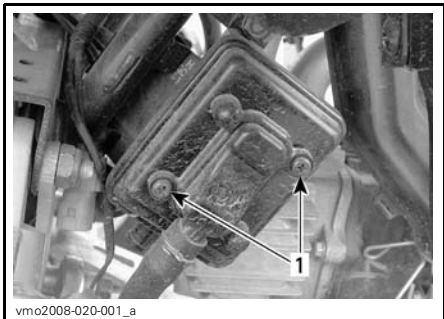

vmo2008-020-001_a

1. Remove screws

Remove filter from air injection valve.

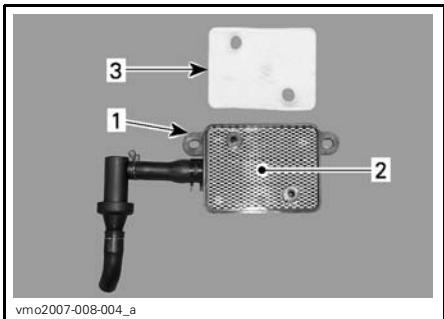

vmo2007-008-004_a

TYPICAL

1. Air injection valve
2. Screen
3. Air filter

Clean air filter and the inside of air injection valve using pressurized air.

NOTE: If the air filter is still dirty, replace it with a new one.

When finished, properly reinstall removed parts in the reverse order of their removal.

Spark Arrester Cleaning

The muffler must be periodically purged of accumulated carbon.

⚠ WARNING

Never perform this operation immediately after the engine has been run because exhaust system is very hot. Wear eye protection and gloves. Respect all applicable laws and regulations.

Remove muffler cover (if applicable).

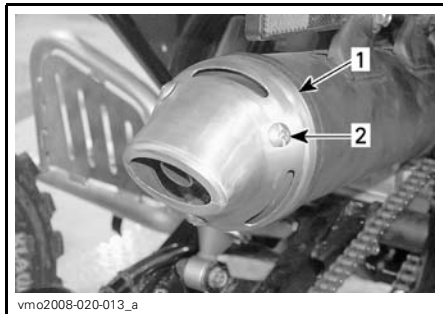

vmo2008-020-013_a

DS90 X ONLY

1. Cover
2. Remove screws

Remove the spark arrester from the muffler.

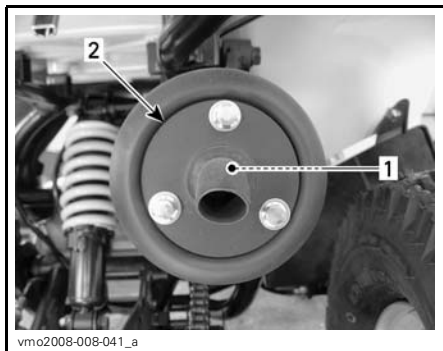

vmo2008-008-041_a

1. Spark arrester
2. Muffler tip

Remove carbon deposits from the spark arrester using a brush.

NOTE: Use a soft brush and be careful to avoid damaging spark arrester.

Reinstall the spark arrester in muffler and muffler cover (if applicable).

TRANSMISSION (CVT)

Drive Belt Inspection

See an authorized Can-Am dealer to check the width and the condition of drive belt.

CVT Cover Drain Plug

Any time you suspect that water has entered the CVT cover, drain the CVT housing by removing the drain tube plug.



LH SIDE OF VEHICLE

1. Drain tube
2. Clamp
3. Plug
4. Engine drain plug

GEARBOX

Oil Change

Place the vehicle on a level surface.

Remove the air filter housing from the vehicle.

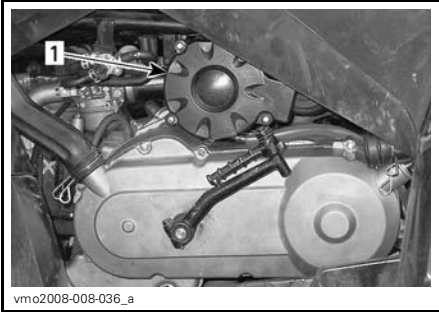

1. Air filter housing

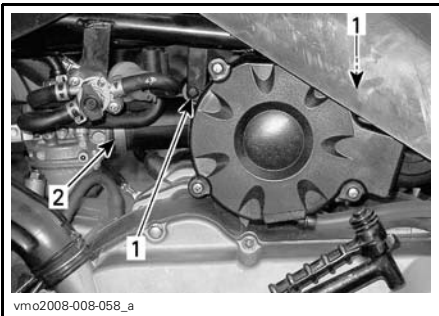

1. Remove screws
2. Loosen clamp



REMOVE AIR FILTER HOUSING

Clean drain plug and oil filling plug area then remove the gearbox drain plug.

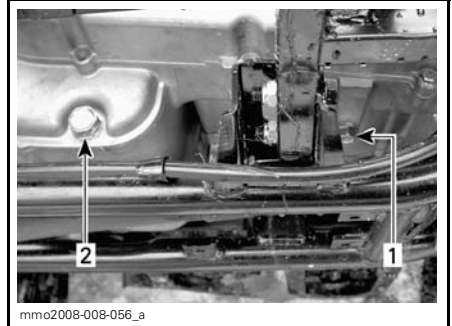

DRAIN PLUG — LH SIDE OF ENGINE

1. Gearbox drain plug
2. Engine oil drain plug

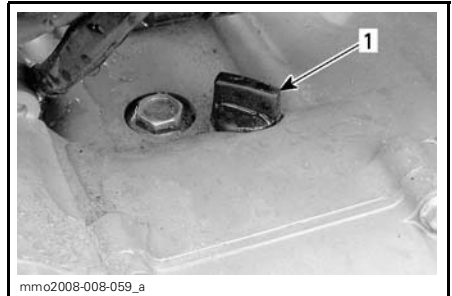

FILL PLUG — LH SIDE OF ENGINE

1. Gearbox fill plug

Allow enough time for oil to flow out of gearbox.

Reinstall drain plug and torque to 16 N•m (142 lbf•in).

Refill gearbox using 165 mL (6 U.S. oz) of XP-S chaincase oil (P/N 413 801 900) or an equivalent.

NOTE: There is no dipstick provided with this vehicle to check gearbox oil level. The ensure proper oil quantity in gearbox, drain oil and replenish with the proper amount of recommended oil.

CAUTION: Do not use other unrec-
ommended types of oil when ser-
vicing. Do not mix with other types
of oil.

Reinstall oil filling plug.

Reinstall all removed parts.

FUEL SYSTEM

Throttle Cable Inspection

Check throttle lever free-play, adjust if necessary.

If correct adjustment is unattainable, see an authorized Can-Am dealer.

Inspect throttle cable for excessive wear, kinking or fraying. Ensure cable moves freely.

Replace throttle cable if any signs of wear, fraying or other damage are found.

Lubricate cable using silicone lubricant (P/N 293 600 041) to reduce premature wear and to ensure proper movement of the cable.

WARNING

Always use a silicone-based lubricant. Using another lubricant (like a water-based lubricant) could cause the throttle lever/cable sticking or stiffness.

Throttle Lever Adjustment

The normal throttle free-play is 5 to 10 mm (3/16 to 13/32 in).

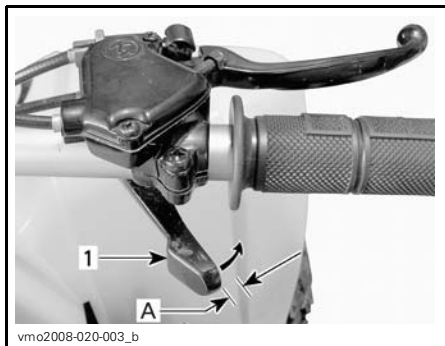

TYPICAL — NORMAL FREE-PLAY

1. Throttle lever

A. 5 to 10 mm (3/16 to 13/32 in)

To adjust cable, slide rubber protector back to expose throttle cable adjuster.

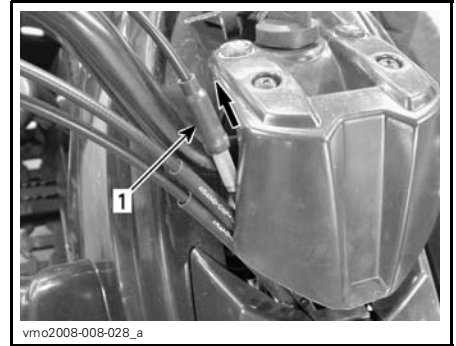

1. Rubber protector

Loosen locking nut and turn the adjuster to get proper adjustment.

NOTE: Measure throttle free play at the tip of throttle lever.

Tighten locking nut and reinstall protector.

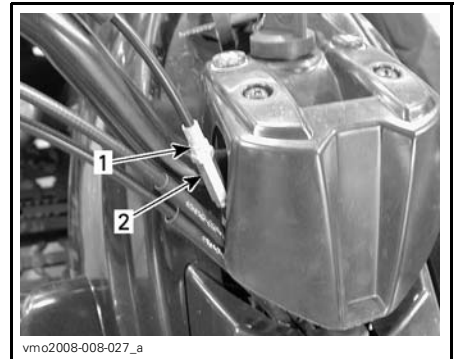

1. Lock nut

2. Adjuster

Speed Limiter Adjustment

This vehicle is equipped with an adjustable speed limiter.

Using the appropriate tools, it is possible to increase or decrease engine speed by modifying speed limiter screw position.

WARNING

Adults should always limit the maximum restricted speed within the ability and capacity of the child to operate the vehicle safely. Never allow the child to adjust the speed limiter.

To adjust speed limiter screw, loosen lock nut then, turn speed limiter screw accordingly.

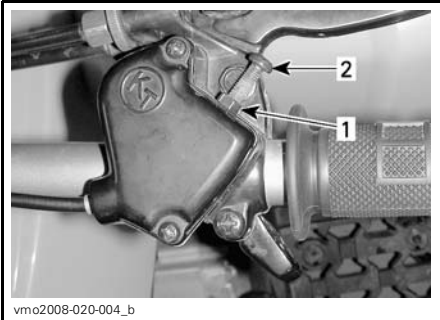

1. Lock nut
2. Speed limiter screw

The maximum throttle lever movement adjustment to obtain vehicle maximum speed is 20 mm (0.8 in).

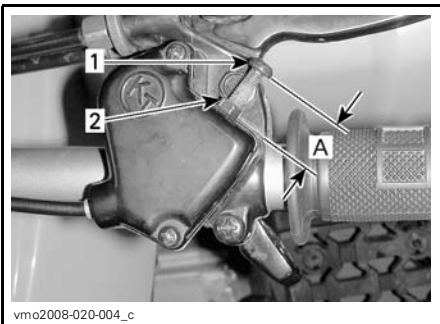

1. Speed limiter screw
2. Lock nut
- A. 20 mm (0.8 in)

WARNING

Improper adjustment of the speed limiter screw could damage throttle cable and impair throttle lever operation. Failure to follow adjustment recommendations could lead to an accident resulting in severe injuries including the possibility of death.

ELECTRICAL

WARNING

Unless otherwise indicated, always turn ignition switch to the OFF position before performing any maintenance or repair on electrical system.

Spark Plug Removal/ Inspection



vmo2008-008-033_a

TYPICAL — RH SIDE OF VEHICLE
1. Spark plug location

Removal



vmo2008-008-034_a

UNPLUG SPARK PLUG CABLE
1. Spark plug cable

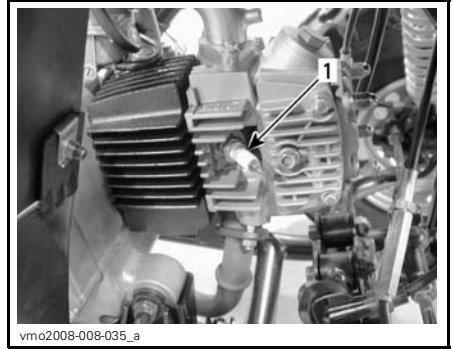

vmo2008-008-035_a

UNSCREW SPARK PLUG ONE TURN
1. Spark plug

Clean spark plug and cylinder head with pressurized air if possible.

WARNING

Always wear safety goggles when using pressurized air.

Unscrew and remove spark plug completely.

Installation

Prior to installation make sure that contact surface of cylinder head and spark plug are free of grime.

Using a feeler gauge, set the spark plug gap between 0.7 and 0.8 mm (.027 to .031 in).

Apply anti-seize lubricant over spark plug threads to prevent a possible seizure.

Screw spark plug into cylinder head by hand and tighten with a torque wrench and proper socket.

Torque spark plug to 11 N•m (97 lbf•in).

Battery Removal

WARNING

Never charge a battery while installed in vehicle.

These vehicles are equipped with a VRLA battery (Valve Regulated Lead Acid). It is a maintenance-free type battery, there is no need to add water to adjust electrolyte level.

CAUTION: Never remove the battery sealing cap.

Clean battery post with a wire brush. Apply dielectric grease on post to protect against oxidation.

Removal

Disconnect BLACK (-) cable first then RED (+) cable.

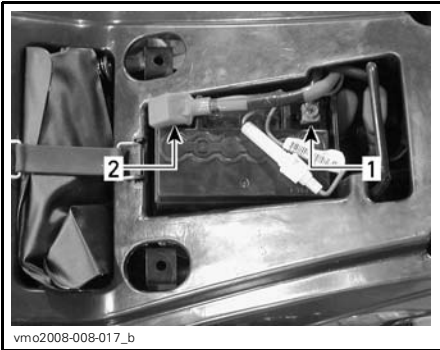

1. BLACK (-)
2. RED (+)

WARNING

Always respect this order for disassembly; disconnect BLACK (-) cable first. Fuel vapors can be present in engine compartment and a spark may ignite them and possibly cause personal injuries.

Remove battery from vehicle.

Installation

Reinstall battery in vehicle.

WARNING

Connect RED (+) cable first then BLACK (-) cable. Always connect RED (+) cable first.

Fuse Replacement

If the fuse is damaged, replace it by one of the same rating.

CAUTION: Do not use a higher rated fuse as this can cause severe damage.

Fuse holder is located on the RED (+) battery cable.



1. Fuse holder

Bulb Replacement

All Models except DS90 X

WARNING

Always turn the ignition switch to OFF position before replacing a defective bulb.

Always check light operation after replacement.

Daytime Running Lights



vmo2008-008-038_a

REMOVE RUBBER PROTECTOR

1. Rubber protector

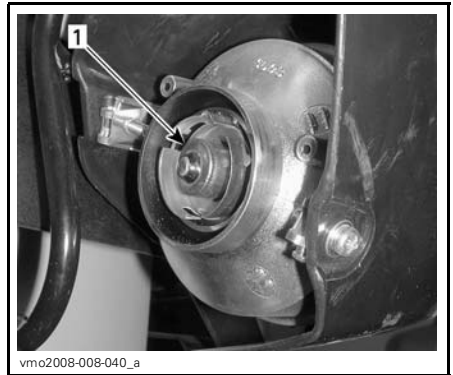

vmo2008-008-040_a

**PULL ON BULB TO REMOVE THEN
REPLACE BULB**

1. Bulb

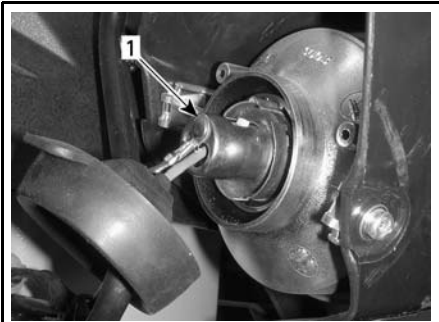

vmo2008-008-039_a

**PUSH AND TURN BULB HOLDER
COUNTERCLOCKWISE**

1. Bulb holder

DRIVE TRAIN

Drive Chain Cleaning/ Lubrication/Adjustment

Inspection

Inspect the chain for damaged links and rollers.

Replace chain if any damage is found.

CAUTION: Replace chain, sprocket axle and pinion together to prevent rapid chain and sprocket wear.

Check the free-play of drive chain and adjust if necessary.

Cleaning and Lubrication

Clean chain by soaking and agitating in solvent.

Wipe it dry.

Lubricate using commercial chain lubricant, refer to *MAINTENANCE CHART* for more details.

Adjustment

NOTE: Never adjust the drive chain with the driver seated on the vehicle. Remove all load on the vehicle.

Select a level surface and set transmission to NEUTRAL.

Check drive chain condition.

The drive chain should be checked, lubricated and adjusted before every ride.

To adjust chain, loosen rear axle locking bolts.

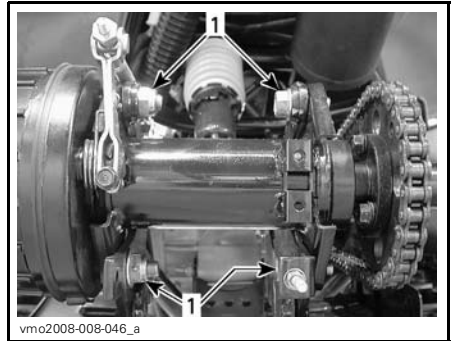

TYPICAL — REAR AXLE

1. Locking bolts

Loosen chain adjuster lock nut.

On so equipped models, push and hold chain tensioner to release chain tension.

Turn chain adjuster nut until proper adjustment is obtained.



TYPICAL

1. Chain adjuster

2. Chain adjuster lock nut

3. Chain adjuster nut

The free-play of the drive chain should be between 44 to 57 mm (1-3/4 to 2-1/4 in) up and down.

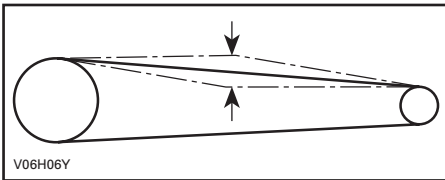

FREE-PLAY: 44 TO 57 MM (1-3/4 TO 2-1/4 IN)

When properly adjusted, tighten chain adjuster lock nut.

Then, tighten drive axle locking bolts to 69 N•m (51 lbf•ft).

Drive Chain Roller Inspection

Inspect the drive chain roller around swing arm pivot member for excessive wear and damage. Replace if necessary.



1. Drive chain roller

Sprocket and Pinion Inspection

Check the sprocket axle and pinion for distortion. Replace if necessary.

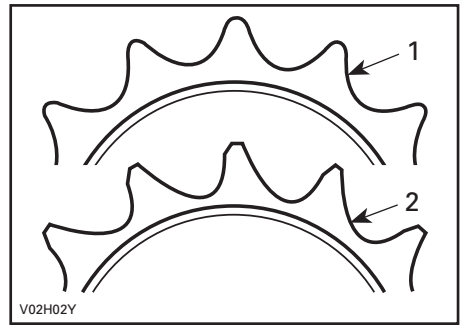

1. Good
2. Replace

CAUTION: Replace chain, sprocket axle and pinion together to prevent rapid chain and sprocket wear. Install a new retaining ring each time the pinion is removed.

Wheels Removal/Condition

Occasionally, wheel bolts should be removed to apply anti-seize lubricant to ease future removal. This is particularly important when vehicle is used in salt-water environment or in mud. Remove one nut at a time, lubricate then retorque.

Wheels Removal

Loosen bolts then lift vehicle. Place a support under vehicle. Remove bolts then remove wheel.

At installation, it is recommended to apply anti-seize lubricant on bolts threads. Gently tighten bolts in a criss-cross sequence then apply a final torque.

WHEEL NUTS TORQUE	
Front	71 N•m (52 lbf•ft)
Rear	120 N•m (89 lbf•ft)

Wheel Bearing Condition

Push and pull the wheels from the upper edge to feel the play. See an authorized Can-Am dealer if there is any play.

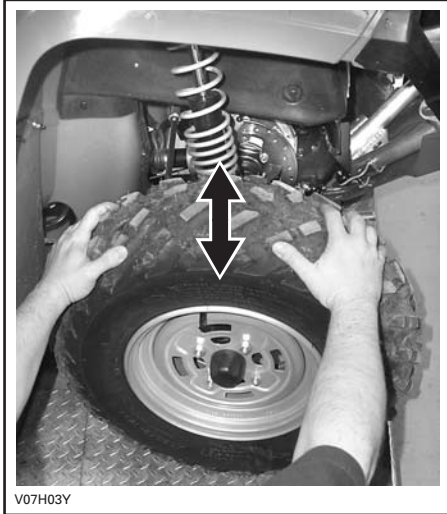

TYPICAL

STEERING SYSTEM

Lubrication

All Models except DS90 X

Lubricate front knuckles. Use synthetic grease (P/N 293 550 033) or an equivalent. There is a grease fitting on each knuckle.



TYPICAL

1. Grease fitting

BRAKES

Inspection (hydraulic)

DS90 X

WARNING

The brake fluid replacement or brake system maintenance and repairs should be performed by an authorized Can-Am dealer.

The braking system is an hydraulic type and no adjustment is required.

Check the following to keep the brakes in a good operating condition:

- brake fluid level
- brake system for fluid leaks
- brake for spongy feel
- brake cleanliness
- brake discs for excessive wear and surface condition
- brake pads for wear, damage or looseness.

Have your authorized Can-Am dealer inspect brake pads for wear or damage.

BRAKE PAD MINIMUM THICKNESS	1 mm (.0394 in)
--	-----------------

See your authorized Can-Am dealer if a problem is detected concerning the brake system.

Inspection (mechanical)

All Models except DS90 X

WARNING

Any brake system repair should be performed by an authorized Can-Am Dealer.

Check brake levers free-play, adjust if necessary.

Check for levers operation, they should move freely and have a firm feeling when brakes are applied.

If correct adjustment is unattainable, see an authorized Can-Am dealer.

Inspect cables for excessive wear, kinking or fraying.

Replace any cable that show signs of wear, fraying or other damage.

Lubricate cables using silicone lubricant (P/N 293 600 041) to reduce premature wear and to ensure proper movement of the cable.

WARNING

Always use a silicone-based lubricant. Using another lubricant (like a water-based lubricant) could cause the brake cables sticking or stiffness.

Have your authorized Can-Am dealer inspect brake shoe for wear or damage.

BRAKE SHOE MINIMUM THICKNESS	
Front	1.5 mm (0.06 in)
Rear	1.5 mm (0.06 in)

See your authorized Can-Am dealer if a problem is detected concerning the brake system.

Front Brake Cable Adjustment

All Models except DS90 X

Fully tighten all adjustment screws of brake cables.

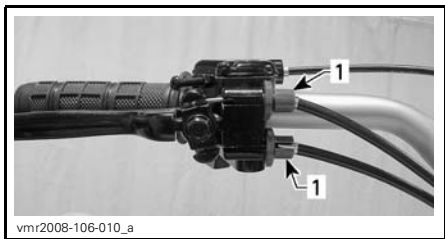

vmr2008-106-010_a

1. Adjustment screws on lever

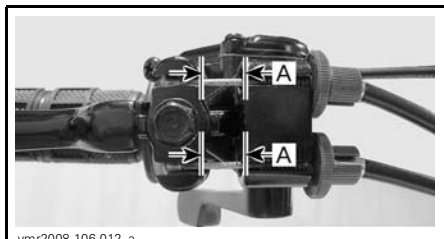

vmr2008-106-012_a

A. 10 and 12 mm (13/32 and 1/2 in)

Tighten all adjustment screw locks.

Rear Brake Lever Adjustment

All Models except DS90 X

The normal free-play of at the end of brake lever is between 15 and 25 mm (19/32 and 1 in).

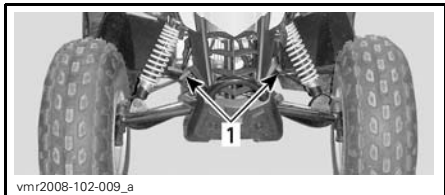

vmr2008-102-009_a

1. Adjustment screws on cables

Press brake lever.

Adjust cable link so it is parallel to cable support. Turn adjustment screws on cable (not at lever) as required.

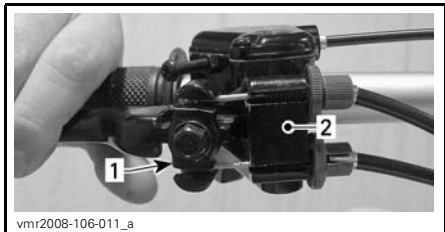

vmr2008-106-011_a

1. Cable link
2. Cable support

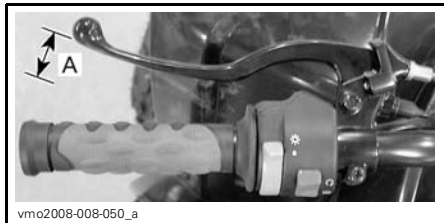

vmo2008-008-050_a

NORMAL FREE-PLAY

A. 15 to 25 mm (19/32 to 1 in)

To adjust rear brake lever, turn the brake cable adjuster at the end of brake cable until proper adjustment is obtained.

Using adjustment screws on lever, adjust cable free-play.

BRAKE CABLES ADJUSTMENT	
Free-play	10 to 12 mm (13/32 to 1/2 in)

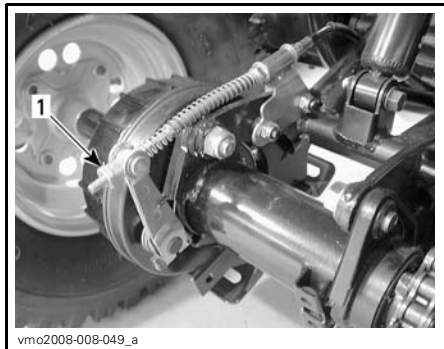

vmo2008-008-049_a

1. Brake cable adjuster

BODY/FRAME

Engine Compartment Inspection

Check engine compartment for any damage and leaks. Ensure all hose clamps are properly secured and no hose is cracked, kinked or otherwise damaged.

Inspect muffler, battery and reservoir fastening devices.

Check electrical connections for corrosion and tightness.

Replace or have damaged parts repaired.

Fasteners Inspection

Check fastener condition and tightness on the vehicle. Retighten as required.

Seat Latch Inspection

Remove seat and check latch mechanism for wear. See an authorized Can-Am dealer for parts replacement if damaged.

STORAGE AND PRESEASON PREPARATION

WARNING

Have an authorized Can-Am dealer inspect fuel system integrity as specified in *MAINTENANCE CHART*.

When a vehicle is not in use for more than one month, proper storage is a necessity.

See an authorized Can-Am dealer for proper procedures.

When using your vehicle after storage, a preparation is required. See an authorized Can-Am dealer for proper procedures.

WARRANTY

BRP LIMITED WARRANTY NORTH AMERICA: 2008 CAN-AM™ ATV

1) SCOPE OF THE LIMITED WARRANTY

Bombardier Recreational Products Inc. ("BRP")* warrants its 2008 Can-Am ATV from defects in material or workmanship for the period and under the conditions described below.

All genuine Can-Am ATV parts and accessories, installed by an authorized BRP dealer (as hereinafter defined) at the time of delivery of the 2008 Can-Am ATV, carry the same warranty as that of the Can-Am ATV.

A GPS receiver may be supplied by BRP as standard equipment on certain 2008 Can-Am ATV's. The GPS receiver is covered by the limited warranty issued by the GPS receiver's manufacturer and is not covered by this limited warranty. Please contact the following distributors:

In the USA:

Garmin International Inc.
1200 East 151st Street Olathe
KS 66062
(Kansas City metro area)
Tel.: 913 397-8200
Fax Number: 913 397-8282

In Canada (one or the other):

Raytech Électronique
1451, Boul. des Laurentides
Vimont, Laval, Qc
H7M 2Y3
Tel.: 450 975-1015
Fax Number: 800 975-0025 / 450 975-0817
Contact: raytech@raytech.qc.ca
Web Site: www.raytech.qc.ca
Coord. GPS: N45o35.25' - W73o42.95'

Naviclub Ltée
5054, St-Georges
Lévis, Qc
G6V 4P2
Tel.: 418 835-9279
Fax Number: 418 835-6681
Contact: naviclub@naviclub.com
Web Site: www.naviclub.com

Your 2008 Can-Am ATV could be originally equipped with Carlisle[†] tires. The tires are warranted separately by the tire manufacturer. Please contact the manufacturer or ask your authorized BRP dealer for warranty coverage and assistance.

Carlisle Tire & Wheel Company

23, Windham Boulevard
Aiken, SC 29805
Warranty Information:
in USA 1 800 260-7959
in Canada 1 800 265-6155
in Quebec 1 877 997-4999

Use of the product for racing or any other competitive activity, at any point, even by a previous owner, will render this warranty null and void.

2) EXCLUSIONS – ARE NOT WARRANTED

The following are not warranted under any circumstances:

- Normal wear and tear;
- Routine maintenance items, tune ups, adjustments;
- Damage caused by failure to provide proper maintenance and/or storage, as described in the Operator's Guide;
- Damage resulting from removal of parts, improper repairs, service, maintenance, modifications or use of parts not manufactured or approved by BRP or resulting from repairs done by a person that is not an authorized servicing BRP dealer;
- Damage caused by abuse, abnormal use, neglect or operation of the product in a manner inconsistent with the recommended operation described in the Can-Am ATV Operator's Guide;
- Damage resulting from accident, submersion, fire, theft, vandalism or any act of God;
- Operation with fuels, oils or lubricants which are not suitable for use with the product (see the Operator's Guide);
- Water or snow ingestion;
- Incidental or consequential damages, or damages of any kind including without limitation towing, storage, telephone, rental, taxi, inconvenience, insurance coverage, loan payments, loss of time, loss of income.

3) LIMITATIONS OF LIABILITY

THIS WARRANTY IS EXPRESSLY GIVEN AND ACCEPTED IN LIEU OF ANY AND ALL OTHER WARRANTIES, EXPRESSED OR IMPLIED, INCLUDING WITHOUT LIMITATION ANY WARRANTY OF MERCHANTABILITY OR FITNESS FOR A PARTICULAR PURPOSE. TO THE EXTENT THAT THEY CANNOT BE DISCLAIMED, THE IMPLIED WARRANTIES ARE LIMITED IN DURATION TO THE LIFE OF THE EXPRESS WARRANTY. INCIDENTAL AND CONSEQUENTIAL DAMAGES ARE EXCLUDED FROM COVERAGE UNDER THIS WARRANTY. SOME STATES/ PROVINCES DO NOT ALLOW FOR THE DISCLAIMERS, LIMITATIONS AND EXCLUSIONS IDENTIFIED ABOVE, AS A RESULT, THEY MAY NOT APPLY TO YOU. THIS WARRANTY GIVES YOU SPECIFIC RIGHTS, AND YOU MAY ALSO HAVE OTHER LEGAL RIGHTS WHICH MAY VARY FROM STATE TO STATE, OR PROVINCE TO PROVINCE.

Neither the distributor, any BRP dealer nor any other person has been authorized to make any affirmation, representation or warranty regarding the product, other than those contained in this limited warranty, and if made, shall not be enforceable against BRP.

BRP reserves the right to modify this warranty at any time, being understood that such modification will not alter the warranty conditions applicable to the products sold while this warranty is in effect.

4) WARRANTY COVERAGE PERIOD

This warranty will be in effect from the date of delivery to the first retail consumer or the date the product is first put into use, whichever occurs first and for a period of:

SIX (6) CONSECUTIVE MONTHS, for private use or commercial use owners.

The emission-related components included in the chart below that are installed on EPA certified Can-Am ATVs registered in the USA are covered for thirty (30) consecutive months.

EMISSION-RELATED COMPONENTS	DS70/90/90 X
Carburetor	X
Carburetor Air Intake Adapter	X
Engine Air Intake Adapter	X
Ignition Coil	X
Air Injection Valve	X
ECM (Engine Control Module)	X
Catalyst	X
Crankcase ventilation system	X
Cylinder head gasket	X

The repair or replacement of parts or the performance of service under this warranty does not extend the life of this warranty beyond its original expiration date.

5) CONDITIONS TO HAVE WARRANTY COVERAGE

This warranty coverage is available **only** if **each** of the following conditions has been fulfilled:

- The 2008 Can-Am ATV must be purchased as new and unused by its first owner from a BRP dealer authorized to distribute Can-Am ATVs in the country in which the sale occurred ("BRP dealer");
- The BRP specified pre-delivery inspection process must be completed and documented;
- The 2008 Can-Am ATV must have undergone proper registration by an authorized BRP dealer;
- The 2008 Can-Am ATV must be purchased in the country in which the purchaser resides;
- Routine maintenance outlined in the Operator's Guide must be timely performed in order to maintain warranty coverage. BRP reserves the right to make warranty coverage contingent upon proof of proper maintenance.

BRP will not honor this limited warranty to any private use owner or commercial use owner if the preceding conditions have not been met. Such limitations are necessary in order to allow BRP to preserve both the safety of its products, and also that of its consumers and the general public.

6) WHAT TO DO TO OBTAIN WARRANTY COVERAGE

The customer must notify a servicing BRP dealer within two (2) days of the appearance of a defect, and provide it with reasonable access to the product and reasonable opportunity to repair it. The customer must also present to the authorized BRP dealer, proof of purchase of the product and must sign the repair/work order prior to starting the repair in order to validate the warranty repair. All parts replaced under this limited warranty become the property of BRP.

7) WHAT BRP WILL DO

BRP's obligations under this warranty are limited to, at its sole discretion, repairing parts found defective under normal use, maintenance and service, or replacing such parts with new genuine Can-Am ATV parts without charge for parts and labor, at any authorized BRP dealer during the warranty coverage period.

BRP reserves the right to improve or modify products from time to time without assuming any obligation to modify products previously manufactured.

8) TRANSFER

If the ownership of a product is transferred during the warranty coverage period, this warranty shall also be transferred and be valid for the remaining coverage period provided that BRP is notified of such transfer of ownership in the following way:

- a) The former owner contacts BRP (at the phone number provided below) or an authorized BRP dealer and gives the coordinates of the new owner; or
- b) BRP or an authorized BRP dealer receives a proof that the former owner agreed to the transfer of ownership, in addition to the coordinates of the new owner.

9) CONSUMER ASSISTANCE

- a) In the event of a controversy or a dispute in connection with this limited warranty, BRP suggests that you try to resolve the issue at the dealership level. We recommend discussing the issue with the authorized dealer's service manager or owner.
- b) If the issue has not yet been resolved, please submit your complaint in writing or call the appropriate number below:

In Canada

BOMBARDIER RECREATIONAL PRODUCTS INC.

Consumer Services Group
75, J.-A. Bombardier Street
Sherbrooke, Québec J1L 1W3
Tel.: 819 566-3366

In USA

BRP US INC.

Consumer Services Group
7575 Bombardier Court
Wausau WI 54401
Tel.: 715 848-4957

* In the USA, products are distributed and serviced by BRP US Inc.

© 2007 Bombardier Recreational Products Inc. All rights reserved.

™ trademark of Bombardier Recreational Products Inc. or its affiliates.

† Carlisle is a trademark of Carlisle Tire & Wheel Company.

BRP INTERNATIONAL LIMITED WARRANTY: 2008 CAN-AM™ ATV

1) SCOPE OF THE LIMITED WARRANTY

Bombardier Recreational Products Inc. ("BRP")* warrants its 2008 Can-Am ATV from defects in material or workmanship for the period and under the conditions described below.

All genuine Can-Am ATV parts and accessories, installed by an authorized Can-Am distributor/dealer (as hereinafter defined) at the time of delivery of the 2008 Can-Am ATV, carry the same warranty as that of the Can-Am ATV.

Use of the product for racing or any other competitive activity, at any point, even by a previous owner will render this warranty null and void.

2) EXCLUSIONS – ARE NOT WARRANTED

The following are not warranted under any circumstances:

- Normal wear and tear;
- Routine maintenance items, tune ups, adjustments;
- Damage caused by failure to provide proper maintenance and/or storage, as described in the Operator's Guide;
- Damage resulting from removal of parts, improper repairs, service, maintenance, modifications or use of parts not manufactured or approved by BRP or resulting from repairs done by a person that is not an authorized servicing Can-Am distributor/dealer;
- Damage caused by abuse, abnormal use, neglect or operation of the product in a manner inconsistent with the recommended operation described in the Operator's Guide;
- Damage resulting from accident, submersion, fire, theft, vandalism or any act of God;
- Operation with fuels, oils or lubricants which are not suitable for use with the product (see the Operator's Guide);
- Water or snow ingestion;
- Incidental or consequential damages, or damages of any kind including without limitation towing, storage, telephone, rental, taxi, inconvenience, insurance coverage, loan payments, loss of time, loss of income.

3) LIMITATIONS OF LIABILITY

THIS WARRANTY IS EXPRESSLY GIVEN AND ACCEPTED IN LIEU OF ANY AND ALL OTHER WARRANTIES, EXPRESSED OR IMPLIED, INCLUDING WITHOUT LIMITATION ANY WARRANTY OF MERCHANTABILITY OR FITNESS FOR A PARTICULAR PURPOSE. TO THE EXTENT THAT THEY CANNOT BE DISCLAIMED, THE IMPLIED WARRANTIES ARE LIMITED IN DURATION TO THE LIFE OF THE EXPRESS WARRANTY. INCIDENTAL AND CONSEQUENTIAL DAMAGES ARE EXCLUDED FROM COVERAGE UNDER THIS WARRANTY. SOME JURISDICTIONS DO NOT ALLOW FOR THE DISCLAIMERS, LIMITATIONS AND EXCLUSIONS IDENTIFIED ABOVE, AS A RESULT, THEY MAY NOT APPLY TO YOU. THIS WARRANTY GIVES YOU SPECIFIC RIGHTS, AND YOU MAY ALSO HAVE OTHER LEGAL RIGHTS WHICH MAY VARY FROM COUNTRY TO COUNTRY.

Neither the distributor, any Can-Am dealer nor any other person has been authorized to make any affirmation, representation or warranty regarding the product, other than those contained in this limited warranty, and if made, shall not be enforceable against BRP.

BRP reserves the right to modify this warranty at any time, being understood that such modification will not alter the warranty conditions applicable to the products sold while this warranty is in effect.

4) WARRANTY COVERAGE PERIOD

This warranty will be in effect from the date of delivery to the first retail consumer or the date the product is first put into use, whichever occurs first and for a period of:

SIX (6) CONSECUTIVE MONTHS, for private use or commercial use.

The repair or replacement of parts or the performance of service under this warranty does not extend the life of this warranty beyond its original expiration date.

5) CONDITIONS TO HAVE WARRANTY COVERAGE

This warranty coverage is available **only** if **each** of the following conditions has been fulfilled:

- The 2008 Can-Am ATV must be purchased as new and unused by its first owner from a Can-Am distributor/dealer authorized to distribute Can-Am ATVs in the country in which the sale occurred (“Can-Am distributor/dealer”);
- The BRP specified pre-delivery inspection process must be completed and documented;
- The product must have undergone proper registration by an authorized Can-Am distributor/dealer;
- The 2008 Can-Am ATV must be purchased in the country or union of countries in which the purchaser resides;
- Routine maintenance outlined in the Operator’s Guide must be timely performed in order to maintain warranty coverage. BRP reserves the right to make warranty coverage contingent upon proof of proper maintenance.

BRP will not honour this limited warranty to any private use owner or commercial use owner if the preceding conditions have not been met. Such limitations are necessary in order to allow BRP to preserve both the safety of its products, and also that of its consumers and the general public.

6) WHAT TO DO TO OBTAIN WARRANTY COVERAGE

The customer must notify a servicing Can-Am distributor/dealer within two (2) days of the appearance of a defect, and provide it with reasonable access to the product and reasonable opportunity to repair it. The customer must also present to the authorized Can-Am distributor/dealer, proof of purchase of the product and must sign the repair/work order prior to starting the repair in order to validate the warranty repair. All parts replaced under this limited warranty become the property of BRP.

7) WHAT BRP WILL DO

BRP's obligations under this warranty are limited to, at its sole discretion, repairing parts found defective under normal use, maintenance and service; or replacing such parts with new genuine Can-Am ATV parts without charge for parts and labour, at any authorized Can-Am distributor/dealer.

BRP reserves the right to improve or modify products from time to time without assuming any obligation to modify products previously manufactured.

8) TRANSFER

If the ownership of a product is transferred during the warranty coverage period, this warranty shall also be transferred and be valid for the remaining coverage period provided BRP or an authorized Can-Am distributor/dealer receives a proof that the former owner agreed to the transfer of ownership, in addition to the co-ordinates of the new owner.

9) CONSUMER ASSISTANCE

- a) In the event of a controversy or a dispute in connection with this limited warranty, BRP suggests that you try to resolve the issue at the dealership level. We recommend discussing the issue with the authorized dealer's service manager or owner.
- b) If further assistance is required, the distributor's service department should be contacted in order to resolve the matter. You will find your distributor's coordinates on www.brp.com.
- c) If the matter still remains unresolved then contact BRP by writing to us at the address listed below.

For countries within Europe, Middle East, Africa, Russia & CIS, please contact our European office:

BRP EUROPE N.V.

Consumer Service Center
Skaldenstraat 125
9042 Gent
Belgium
Tel.: + 32-9-218-26-00

For Scandinavian countries, please contact our Finland office:

BRP FINLAND OY

Service Department
Ahjotie 30
Fin-96320 Rovaniemi
Finland
Tel.: + 358 16 3208 111

For all other countries, please contact your local distributor or our North America office:

BOMBARDIER RECREATIONAL PRODUCTS INC.

Consumer Services Group
75, J.-A. Bombardier Street
Sherbrooke, Québec J1L 1W3
Tel.: 819 566-3366

* For the territory covered by this limited warranty, products are distributed and serviced by Bombardier Recreational Products Inc. or its affiliates.

© 2007 Bombardier Recreational Products Inc. All rights reserved.

™ Trademark of Bombardier Recreational Products Inc. or its affiliates.

BRP EUROPEAN UNION MEMBER STATES LIMITED WARRANTY: 2008 CAN-AM™ ATVS

1) SCOPE OF THE LIMITED WARRANTY

Bombardier Recreational Product Inc. ("BRP")* warrants its new and unused model-year 2008 Can-Am ATVs sold by authorized BRP distributors/dealers ("Distributors/Dealers") in the European Union member states from defects in material or workmanship for the period and under the conditions described below.

All genuine Can-Am ATV parts and accessories, installed by an authorized BRP Distributors/Dealers at the time of delivery of the 2008 Can-Am ATV, carry the same warranty as that of the ATV.

Use of the product for racing or any other competitive activity, at any point, even by a previous owner, will render this warranty null and void.

2) EXCLUSIONS – ARE NOT WARRANTED

The following are not warranted under any circumstances:

- Normal wear and tear;
- Routine maintenance items, tune ups, adjustments;
- Damage caused by failure to provide proper maintenance and/or storage, as described in the Operator's Guide;
- Damage resulting from removal of parts, improper repairs, service, maintenance, modifications or use of parts not manufactured or approved by BRP or resulting from repairs done by a person that is not an authorized servicing Distributor/Dealer;
- Damage by abuse, abnormal use, neglect or operation of the product in a manner inconsistent with the recommended operation described in the Operator's Guide;
- Damage resulting from accident, submersion, fire, theft, vandalism or any act of God;
- Operation with fuels, oils or lubricants which are not suitable for use with the product (see the Operator's Guide);
- Water or snow ingestion;
- Incidental or consequential damages, or damages of any kind including without limitation towing, storage, telephone, rental, taxi, inconvenience, insurance coverage, loan payments, loss of time, loss of income.

3) LIMITATIONS OF LIABILITY

THIS WARRANTY IS EXPRESSLY GIVEN AND ACCEPTED IN LIEU OF ANY AND ALL OTHER WARRANTIES, EXPRESSED OR IMPLIED, INCLUDING WITHOUT LIMITATION ANY WARRANTY OF MERCHANTABILITY OR FITNESS FOR A PARTICULAR PURPOSE. TO THE EXTENT THAT THEY CANNOT BE DISCLAIMED, THE IMPLIED WARRANTIES ARE LIMITED IN DURATION TO THE LIFE OF THE EXPRESS WARRANTY. INCIDENTAL AND CONSEQUENTIAL DAMAGES ARE EXCLUDED FROM COVERAGE UNDER THIS WARRANTY. SOME JURISDICTIONS DO NOT ALLOW FOR THE DISCLAIMERS, LIMITATIONS AND EXCLUSIONS IDENTIFIED ABOVE, AS A RESULT, THEY MAY NOT APPLY TO YOU. THIS WARRANTY GIVES YOU SPECIFIC RIGHTS, AND YOU MAY ALSO HAVE OTHER LEGAL RIGHTS WHICH MAY VARY FROM COUNTRY TO COUNTRY.

Neither the distributor, any BRP Distributor/Dealer nor any other person has been authorized to make any affirmation, representation or warranty regarding the product, other than those contained in this limited warranty, and if made, shall not be enforceable against BRP.

BRP reserves the right to modify this warranty at any time, being understood that such modification will not alter the warranty conditions applicable to the products sold while this warranty is in effect.

4) WARRANTY COVERAGE PERIOD

This warranty will be in effect from the date of delivery to the first retail consumer or the date the product is first put into use, whichever occurs first and for a period of:

TWENTY-FOUR (24) CONSECUTIVE MONTHS for private and commercial use.

The repair or replacement of parts or the performance of service under this warranty does not extend the life of this warranty beyond its original expiration date.

Note that the duration and any other modalities of the warranty coverage are subject to the applicable national or local legislation in your country.

5) CONDITIONS TO HAVE WARRANTY COVERAGE

This warranty coverage is available **only** if **each** of the following conditions has been fulfilled:

- The 2008 Can-Am ATV must be purchased as new and unused by its first owner from a Can-Am Distributor/Dealer authorized to distribute Can-Am ATVs in the country in which the sale occurred;
- The BRP specified pre-delivery inspection process must be completed and documented;
- The product must have undergone proper registration by an authorized Can-Am Distributor/Dealer;
- The 2008 Can-Am ATV must be purchased in the country or union of countries in which the purchaser resides;
- Routine maintenance outlined in the Operator's Guide must be timely performed in order to maintain warranty coverage. BRP reserves the right to make warranty coverage contingent upon proof of proper maintenance.

BRP will not honour this limited warranty to any private use owner or commercial use owner if the preceding conditions have not been met. Such limitations are necessary in order to allow BRP to preserve both the safety of its products, and also that of its consumers and the general public.

6) WHAT TO DO TO OBTAIN WARRANTY COVERAGE

The customer must notify a servicing BRP Distributor/Dealer within two (2) months of the appearance of a defect, and provide it with reasonable access to the product and reasonable opportunity to repair it. The customer must also present to the authorized BRP Distributor/Dealer, proof of purchase of the product and must sign the repair/work order prior to starting the repair in order to validate the warranty repair. All parts replaced under this limited warranty become the property of BRP.

Note that the notification period is subject to the applicable national or local legislation in your country.

7) WHAT BRP WILL DO

BRP's obligations under this warranty are limited to, at its sole discretion, repairing parts found defective under normal use, maintenance and service, or replacing such parts with new genuine Can-Am parts without charge for parts and labor, at any authorized BRP Distributor/Dealer during the warranty coverage period.

BRP reserves the right to improve or modify products from time to time without assuming any obligation to modify products previously manufactured.

8) TRANSFER

If the ownership of a product is transferred during the warranty coverage period, this warranty shall also be transferred and be valid for the remaining coverage period provided BRP or an authorized BRP Distributor/Dealer receives a proof that the former owner agreed to the transfer of ownership, in addition to the co-ordinates of the new owner.

9) CONSUMER ASSISTANCE

- a) In the event of a controversy or a dispute in connection with this limited warranty, BRP suggests that you try to resolve the issue at the dealership level. We recommend discussing the issue with the authorized Distributor/Dealer's service manager or owner.
- b) If further assistance is required, the distributor's service department should be contacted in order to resolve the matter. You will find your distributor's coordinates on www.brp.com.
- c) If the matter still remains unresolved then contact BRP at the address listed below.

For countries within Europe, Middle East, Africa, Russia & CIS, please contact our European office:

BRP EUROPE N.V.

Consumer Service Center
Skaldenstraat 125
9042 Gent
Belgium
Tel.: + 32-9-218-26-00

For Scandinavian countries, please contact our Finland office:

BRP FINLAND OY

Service Department
Ahjotie 30
Fin-96320 Rovaniemi
Finland
Tel.: + 358 16 3208 111

For all other countries, please contact your local distributor or our North America office:

BOMBARDIER RECREATIONAL PRODUCTS INC.

Consumer Services Group
75, J.-A. Bombardier Street
Sherbrooke, Québec J1L 1W3
Tel.: 819 566-3366

* For the territory covered by this limited warranty, products are distributed and serviced by Bombardier Recreational Products Inc. or its affiliates.

© 2007 Bombardier Recreational Products Inc. All rights reserved.

™ Trademark of Bombardier Recreational Products Inc. or its affiliates.

PRIVACY OBLIGATION/DISCLAIMER

We wish to inform you that your coordinates will be used for safety and warranty purposes. Sometimes, we also use the coordinates of our clients to inform them about our products and to present them offers. Should you prefer not to receive information on our product, services and offers, please let us know by writing to the address below.

Also note that, from time to time, carefully selected and trustworthy organizations may be permitted to use the coordinates of our clients to promote quality products and services. If you prefer not to have your name and address released, please let us know by writing to the address below.

In Canada

BOMBARDIER RECREATIONAL PRODUCTS INC.

Warranty Department
75, J.-A. Bombardier Street
Sherbrooke, Québec J1L 1W3
Fax Number: 819 566-3590

In USA

BRP US INC.

Warranty Department
7575 Bombardier Court
Wausau WI 54401
Tel.: 715 848-4957

Other countries in the world

BRP EUROPEAN DISTRIBUTION

Warranty Department
Chemin de Messidor 5-7
1006 Lausanne Switzerland
Fax Number: + 41213187801

ATV MODEL No. _____

VEHICLE IDENTIFICATION NUMBER (V.I.N.) _____

ENGINE IDENTIFICATION NUMBER (E.I.N.) _____

Owner: _____
NAME

No. STREET APT

CITY STATE/PROVINCE ZIP/POSTAL CODE

Purchase Date _____
YEAR MONTH DAY

Warranty Expiry Date _____
YEAR MONTH DAY

To be completed by the dealer at the time of the sale.

DEALER IMPRINT AREA

Please verify with your dealer to ensure your vehicle has been registered with BRP.

While reading this Operator's Guide, remember that:

 **WARNING**

Indicates a potential hazard that, if not avoided, could result in serious injury or death.



WARNING

THIS VEHICLE CAN BE HAZARDOUS TO OPERATE.

A collision or rollover can occur quickly, even during routine maneuvers such as turning and driving on hills or over obstacles, if you fail to take proper precautions.

SEVERE INJURY OR DEATH can result if you do not follow these instructions:

- **BEFORE YOU OPERATE THIS ATV, READ THIS OPERATOR'S GUIDE AND ALL ON-PRODUCT LABELS.**
- **NEVER OPERATE THIS VEHICLE WITHOUT PROPER INSTRUCTIONS.** Beginners should complete a certified training course.
- **NEVER CARRY A PASSENGER.** You increase your risk of losing control if you carry a passenger.
- **NEVER OPERATE THIS VEHICLE ON A PAVED SURFACE.** You increase your risk of losing control if you operate this vehicle on pavement.
- **NEVER OPERATE THIS VEHICLE ON PUBLIC ROADS.** You can collide with another vehicle if you operate this vehicle on a public road.
- **ALWAYS WEAR AN APPROVED HELMET,** eye protection, and protective clothing.
- **NEVER CONSUME ALCOHOL OR DRUGS** before or while operating this vehicle.
- **NEVER OPERATE THIS VEHICLE AT EXCESSIVE SPEEDS.** You increase your risk of losing control if you operate this vehicle at speeds too fast for the terrain, visibility conditions, or your experience.
- **NEVER ATTEMPT WHEELIES, JUMPS, OR OTHER STUNTS.**

219 000 514

CA

OPERATOR'S GUIDE, DS 70, 90, 90 X / ENGLISH
GUIDE DU CONDUCTEUR, DS 70, 90, 90 X / ANGLAIS

FAIT AU / MADE IN CANADA

U/M.P.C.

Free Manuals Download Website

<http://myh66.com>

<http://usermanuals.us>

<http://www.somanuals.com>

<http://www.4manuals.cc>

<http://www.manual-lib.com>

<http://www.404manual.com>

<http://www.luxmanual.com>

<http://aubethermostatmanual.com>

Golf course search by state

<http://golfingnear.com>

Email search by domain

<http://emailbydomain.com>

Auto manuals search

<http://auto.somanuals.com>

TV manuals search

<http://tv.somanuals.com>