

# BOMBARDIER\* ATV



## OPERATOR'S GUIDE

Includes  
Safety,  
vehicle and  
maintenance  
information



# DS650<sup>TM</sup>X



### WARNING

Read this guide thoroughly.  
It contains important safety information.  
Minimum recommended operator age:  
16 years.  
Do not remove this *Operator's Guide* from  
the vehicle.

This *Operator's Guide* utilizes the following symbols to emphasize particular information:

 The Safety Alert Symbol indicates a potential personal injury hazard.

 **WARNING** Indicates a potential hazard that, if not avoided, could result in serious injury or death.

**CAUTION:** Denotes an instruction which, if not followed, could severely damage vehicle components.

## **WARNING**

**YOUR VEHICLE CAN BE HAZARDOUS TO OPERATE.** A collision or rollover can occur quickly, even during routine maneuvers such as turning and driving on hills or over obstacles, if you fail to take proper precautions.

For your safety, understand and follow all the warnings contained in this *Operator's Guide* and the labels on your vehicle. **Failure to follow these warnings can result in SEVERE INJURY OR DEATH!**

Keep this *Operator's Guide* with the vehicle at all times.

## **WARNING**

Disregarding any of the safety precautions and instructions contained in this *Operator's Guide*, Safety Videocassette and on-product labels could cause injury including the possibility of death!

## **WARNING**

This ATV may exceed the performance of other ATVs you have ridden in the past. This category S (sport) is a high performance ATV for off road use only. It is for sport type recreational and competitive use by operators with advanced skills and substantial experience.

All safety documentation should remain with the vehicle at the time of sale.

All content of the Safety Information section should be interpreted by the reader as a warning which, if not followed, may result in injury including the possibility of death.

In Canada, products are distributed by Bombardier Recreational Products Inc. (BRP). In USA, products are distributed by BRP US Inc.

The following trademarks are the property of Bombardier Recreational Products Inc.:

DS650™

Rotax®

XP-STM

---

# FOREWORD

Congratulations on your purchase of a new Bombardier\* recreational vehicle. It is backed by the BRP warranty and a network of authorized Bombardier ATV dealers ready to provide the parts, service or accessories you may require.

Your dealer is committed to your satisfaction. He has taken training to perform the initial setup and inspection of your vehicle as well as completed the final adjustment before you took possession. At delivery, your dealer would have explained the operation, maintenance and safety features of the vehicle. We trust you have taken full advantage of this! If you need more complete servicing information, please ask your dealer.

At delivery, you were also informed of the warranty coverage and completed the Warranty Registration Form which is to be sent to us for processing. In the near future you should be receiving a warranty card which will confirm our receipt of the registration as well as be used for warranty or recall purposes.

You are invited to contact our customer assistance center should you experience problems which cannot be resolved by an authorized Bombardier ATV dealer.

It is understood that this Operator's Guide may be translated into another language. In the event of any discrepancy, the English version shall prevail. Throughout this document the masculine is used to denote the masculine or feminine.

The information and components/system descriptions contained in this document are correct at the time of publication. BRP, however, maintains a policy of continuous improvement of its products without imposing upon itself any obligation to install them on products previously manufactured. Due to late changes, some differences between the manufactured product and the descriptions and/or specifications in this guide may occur. BRP reserves the right at any time to discontinue or change specifications, designs, features, models or equipment without incurring any obligation upon itself.

The illustrations in this document show the typical construction of the different assemblies and may not reproduce the full detail or exact shape of the parts. However, they represent parts that have the same or similar function.

The use of RIGHT and LEFT indications in the text always refers to driving position (when sitting on vehicle).

Specifications are given in the SI metric system with the SAE U.S. equivalent in parenthesis. Where precise accuracy is not required, some conversions are rounded off for easier use.

We recommend genuine BRP products for replacement parts and accessories. They've been especially designed for your vehicle and manufactured to meet BRP's demanding standards.

A *Shop Manual* can be obtained for complete service and maintenance information and more repair information.

# TABLE OF CONTENTS

While reading this Operator's Guide, remember that:

## **WARNING**

Indicates a potential hazard that, if not avoided, could result in serious injury or death.

<b>NOTICE</b> .....	<b>7</b>
<b>INTRODUCTION</b> .....	<b>8</b>

### ***SAFETY INFORMATION***

<b>SPECIAL SAFETY MESSAGES</b> .....	<b>10</b>
<b>OPERATION WARNINGS</b> .....	<b>13</b>
<b>SAFETY WARNING</b> .....	<b>39</b>
Pre-Operation Check .....	40
Clothing .....	41
Carrying Loads .....	42
Recreational Riding .....	42
Environment.....	42
Design Limitation .....	43
Off-Highway Operation.....	43
General Operating and Safety Precautions.....	43
Uphill Driving .....	44
Downhill Driving.....	44
Side Hilling.....	44
Drop-Offs .....	44
Riding Techniques .....	44
Routine Maintenance.....	50
<b>HANG TAG</b> .....	<b>52</b>
<b>LOCATION OF THE IMPORTANT LABELS</b> .....	<b>53</b>

### ***VEHICLE INFORMATION***

<b>HOW TO IDENTIFY YOUR ATV</b> .....	<b>58</b>
<b>NOISE EMISSION CONTROL SYSTEM REGULATION</b> .....	<b>59</b>
<b>EMISSION REQUIREMENTS</b> .....	<b>60</b>
<b>CONTROLS/COMPONENTS/INSTRUMENT</b> .....	<b>61</b>
1) Throttle Lever .....	63
2) Front Brake Lever.....	63
3) Clutch Lever .....	64
4) Parking Lever Lock .....	64
5) Multi-Function Switch .....	65

6) Fuel Tank Cap .....	66
7) Ignition Switch .....	66
8) Indicator Lamps .....	66
9) Front Brake Fluid Reservoir .....	66
10) Fuel Valve .....	67
11) Gearshift Pedal .....	67
12) Tool Box .....	68
13) Seat Latch .....	68
14) Footpeg .....	69
15) Foot Brake Pedal .....	69
16) Rear Brake Fluid Reservoir .....	69
17) Engine/Transmission Oil Tank Cap .....	69
18) Tachometer .....	70
19) Auxiliary Headlamps .....	70
20) Nerf Bar .....	70
21) Radiator Cap .....	70
<b>LIQUIDS .....</b>	<b>72</b>
Fuel .....	72
Engine/Transmission Oil .....	72
Engine Coolant .....	74
Brake Fluid .....	75
Battery .....	76
<b>BREAK-IN PERIOD .....</b>	<b>77</b>
<b>OPERATING INSTRUCTIONS .....</b>	<b>78</b>
General .....	78
Pre-Operation Check .....	78
Initial Cold Starting .....	78
Warm Engine Starting .....	79
Stopping the Engine .....	79
Shifting the Transmission .....	79
<b>SPECIAL PROCEDURES .....</b>	<b>81</b>
Flooded Engine .....	81
Engine Overheat .....	81
Turn Over .....	81
ATV Immersion .....	82
Post-Operation Care .....	82
Storage and Preseason Preparation .....	82

<b>CARGO AND TRANSPORTATION</b> .....	<b>83</b>
<b>TROUBLESHOOTING</b> .....	<b>84</b>
<b>SPECIFICATIONS</b> .....	<b>87</b>

## ***MAINTENANCE INFORMATION***

<b>MAINTENANCE CHART</b> .....	<b>92</b>
<b>GENERAL</b> .....	<b>96</b>
<b>ENGINE/TRANSMISSION</b> .....	<b>97</b>
Oil Change and Oil Filter Replacement.....	97
Coolant Replacement .....	98
Valves Adjustment .....	98
Spark Arrester.....	99
Radiator .....	100
Gearshift Pedal Adjustment .....	100
<b>CARBURETOR</b> .....	<b>101</b>
<b>AIR INTAKE SYSTEM</b> .....	<b>102</b>
Air Filter Cleaning/Draining.....	102
<b>ELECTRICAL</b> .....	<b>104</b>
Battery .....	104
Fuses.....	104
Bulb Replacement .....	105
Indicator Lamp Replacement.....	107
Beam Aiming Adjustment.....	107
<b>DRIVE TRAIN</b> .....	<b>108</b>
Swing Arm and Wheel Hub.....	108
Drive Chain .....	108
Drive Chain Slider.....	109
Sprocket and Pinion .....	109
Tires/Wheels.....	110
Front Wheel Bearing Condition.....	110
Rear Axle Inspection.....	110
<b>STEERING SYSTEM</b> .....	<b>111</b>
Throttle Cable Lubrication.....	111
Throttle Lever Adjustment .....	112
Clutch Cable Lubrication .....	113
<b>SUSPENSION</b> .....	<b>114</b>
Lubrication.....	114
Inspection.....	114
Adjustment .....	114
<b>BRAKES</b> .....	<b>117</b>
<b>BODY/FRAME</b> .....	<b>118</b>
Engine Area .....	118

Skid Plate .....	118
Front Fenders .....	118
Fasteners .....	118
Seat Latch .....	118
Frame .....	118
Vehicle Cleaning and Protection.....	118

***WARRANTY***

<b>BRP LIMITED WARRANTY NORTH AMERICA: 2005 BOMBARDIER<sup>†</sup> ATV</b>	<b>120</b>
<b>BRP INTERNATIONAL LIMITED WARRANTY: 2005 BOMBARDIER<sup>†</sup> ATV</b>	<b>124</b>
<b>PRIVACY OBLIGATION/DISCLAIMER .....</b>	<b>127</b>
<b>CHANGE OF ADDRESS/OWNERSHIP .....</b>	<b>129</b>





---

## NOTICE

This *Operator's Guide* has been prepared to acquaint the owner/operator of a new vehicle with the various vehicle controls, maintenance and safe operating instructions. It is indispensable for the proper use of the product.

This *Operator's Guide* uses the following symbols.



### WARNING

Indicates a potential hazard that, if not avoided, could result in serious injury or death.

**CAUTION:** Denotes an instruction which, if not followed, could severely damage vehicle components.

**NOTE:** Indicates supplementary information needed to fully complete an instruction.

Although the mere reading of such information does not eliminate the hazard, the understanding and application of the information will promote the correct use of this vehicle.

To fully appreciate the pleasures, enjoyment and excitement of using this vehicle, there are some basic rules that **MUST** be observed and followed by any user.

---

# INTRODUCTION

Your dealer should have provided you with some basic information on the particular controls and features of your new vehicle. Please take the time to study this *Operator's Guide* and all on-product warning labels as well as the Safety Videocassette that came with this vehicle. They more completely describe what you should know about this vehicle before riding it.

Whether you are a new user or an experienced rider, it is important for your personal safety as well as passenger safety that you know the controls and features of this vehicle. Equally important is knowing how to properly ride.

Irrespective of your age, experience or state regulations, it is always prudent for you or any other person who may ride your vehicle, to take an approved safe riding course. Please check with your dealer or local authorities for availability in your area. If you are a completely new rider, this should be done before your first ride. Your instructor should be able to provide advice on local conditions and safe riding practices particular to the area.

Riding conditions vary from place to place. Each is subject to weather conditions which may radically change from time to time and from season to season. Riding on sand is different than riding on snow or through forests or marshes. Each location may require a greater degree of awareness and skill may not be suitable with a passenger. Show good judgement. Always proceed with caution. Please do not take any unnecessary risks that could leave you or your passenger stranded or possibly injured.

The vehicle handling, stability and braking distance may be affected when riding with a passenger. Safely reduce speed when riding with a passenger. Allow greater distance for braking.

The contents of this *Operator's Guide* provide riding information which has been proven reliable by other users. They are not intended as a definitive means of avoiding accidents. How you apply this information, coupled with your mental and physical condition, the particular terrain hazard and your risk acceptance level will have an effect on your riding experience. Have fun... and ride responsibly.

This *Operator's Guide* has been prepared to acquaint the owner/operator of a new vehicle with the various vehicle controls, maintenance and safe operating instructions. They are indispensable for the proper use of the product.

We would be pleased to receive any comments on the content and format of this *Operator's Guide*, the Safety Videocassette or on-product warnings labels.

# ***SAFETY INFORMATION***

# SPECIAL SAFETY MESSAGES

## THIS VEHICLE IS NOT A TOY AND CAN BE HAZARDOUS TO OPERATE.

This vehicle handles differently from other vehicles including motorcycles and cars. A collision or rollover can occur quickly, even during routine maneuvers such as turning and driving on hills or over obstacles, if you fail to take proper precautions.

**SEVERE INJURY OR DEATH** can result if you do not follow these instructions:

- ⚠ Read this *Operator's Guide* and all on-product warning labels carefully and follow the operating procedures described. Watch and pay attention to the Safety Videocassette before operation.
- ⚠ Never operate this vehicle without proper instruction. **Take a training course.** Beginners should receive training from a certified instructor. Contact an authorized Bombardier ATV dealer to find out about available training course nearest you or call the Specialty Vehicle Institute of America (SVIA) at 1 800 877-2887 or in Canada, the Canada safety Council (CSC) at 1 (613) 739-1535 ext. 227.
- ⚠ Always follow this age recommendation: A person under 16 years old should never operate this vehicle.
- ⚠ Never carry a passenger on this vehicle.
- ⚠ Never operate this vehicle on any paved surfaces, including sidewalks, driveways, parking lots and streets.
- ⚠ Never operate this vehicle on any public street, road or highway, even a dirt or gravel one.
- ⚠ Never take place on this vehicle without wearing an approved helmet that fits properly. You should also wear eye protection (goggles or face shield), gloves, boots, long sleeved shirt or jacket, and long pants.
- ⚠ Never consume alcohol or drugs before or while riding this vehicle.
- ⚠ Never operate at excessive speeds. Always go at a speed that is proper for the terrain, visibility, and operating conditions, and your experience.
- ⚠ Never attempt wheelies, jumps, or other stunts.
- ⚠ Always inspect your vehicle each time you use it to make sure it is in safe operating condition. Always follow the inspection and maintenance procedures and schedules described in this *Operator's Guide*.
- ⚠ Always keep both hands on the handlebars and both feet on the footrests of the vehicle during operation.
- ⚠ Always go slowly and be extra careful when operating on unfamiliar terrain. Always be alert to changing terrain conditions when operating this vehicle.
- ⚠ Never operate on excessively rough, slippery or loose terrain until you have learned and practiced the skills necessary to control this vehicle on such terrain. Always be especially cautious on these kinds of terrain.
- ⚠ Always follow proper procedures for turning as described further in this *Operator's Guide*. Practice turning at low speeds before attempting to turn at faster speeds. Do not turn at excessive speed.

- ⚠ Never operate this vehicle on hills too steep for the vehicle or for your abilities. Practice on smaller hills before attempting larger hills.
- ⚠ Always follow proper procedures for climbing hills as described further in this *Operator's Guide*. Check the terrain carefully before you start up any hill. Never climb hills with excessively slippery or loose surfaces. Shift your weight forward. Never open the throttle suddenly or make sudden gear changes. Never go over the top of any hill at high speed.
- ⚠ Always follow proper procedures for going down hills and for braking on hills as described further in this *Operator's Guide*. Check the terrain carefully before you start down any hill. Shift your weight backward. Never go down a hill at high speed. Avoid going down a hill at an angle that would cause the vehicle to lean sharply to one side. Go straight down the hill where possible.
- ⚠ Always follow proper procedures for crossing the side of a hill as described further in this *Operator's Guide*. Avoid hills with excessively slippery or loose surfaces. Shift your weight to the uphill side of the vehicle. Never attempt to turn the vehicle around on any hill until you have mastered the turning technique described in this *Operator's Guide* on level ground. Avoid crossing the side of a steep hill if possible.
- ⚠ Always use proper procedures if you stall or roll backwards when climbing a hill. To avoid stalling, use proper gear and maintain a steady speed when climbing a hill. If you stall or roll backwards, follow the special procedure for braking described in this *Operator's Guide*. Dismount on the uphill side or to a side if pointed straight uphill. Turn the vehicle around and remount, following the procedure described further in this *Operator's Guide*.
- ⚠ Always check for obstacles before operating in a new area. Never attempt to operate over large obstacles, such as large rocks or fallen trees. Always follow proper procedures when operating over obstacles as described further in this *Operator's Guide*.
- ⚠ Always be careful when skidding or sliding. Learn to safely control skidding or sliding by practicing at low speeds and on level smooth terrain. On extremely slippery surfaces, such as ice, go slowly and be very cautious in order to reduce the chance of skidding out of control.
- ⚠ Never operate this vehicle in fast flowing water or in water deeper than that specified in this *Operator's Guide*. Remember that wet brakes may have reduced stopping ability. Test your brakes after leaving water. If necessary, apply them several times to let friction dry out the pads.
- ⚠ Always use the size and type tires specified further in this *Operator's Guide*. Always maintain proper tire pressure as described further in this *Operator's Guide*.
- ⚠ Never modify this vehicle through improper installation or use of accessories. Only use BRP's approved accessories.

⚠ Never exceed the stated load limits for this vehicle including operator, all other loads and added accessories. Cargo should be properly distributed and securely attached. Reduce speed and follow instructions in this manual for carrying cargo or pulling a trailer. Allow greater distance for braking.

⚠ FOR MORE INFORMATION ABOUT ATV SAFETY, call the Specialty Vehicle Institute of America (SVIA) at 1 800 887-2887 or in Canada, the Canada Safety Council (CSC) at 1 (613) 739-1535 ext. 227 or contact an authorized Bombardier ATV dealer to find out about available training courses nearest you.

# OPERATION WARNINGS

While reading this Operator's Guide, remember that:

## WARNING

Indicates a potential hazard that, if not avoided, could result in serious injury or death.

The following warning and their format have been requested by the United States Consumer Product Safety Commission and are required to be in the *Operator's Guide* for all ATVs.

**NOTE:** The following illustrations are general representations only. Your model may differ.

## WARNING



V00A0AQ

### **POTENTIAL HAZARD**

Operating this vehicle without proper instruction.

### **WHAT CAN HAPPEN**

The risk of an accident is greatly increased if the operator does not know how to operate this vehicle properly in different situations and on different types of terrain with or without passenger.

### **HOW TO AVOID THE HAZARD**

Beginning and inexperienced operators should complete the training course offered by BRP. They should then regularly practice the skills learned in the course and the operating techniques described in this *Operator's Guide*.

For more information about the training course, contact an authorized Bombardier ATV dealer or call BRP at 1 (819) 566-3366.

 **WARNING**



V00A01Q

**POTENTIAL HAZARD**

Failure to follow the age recommendations for this vehicle.

**WHAT CAN HAPPEN**

A lack of respect for this age recommendation can lead to severe injury or death of the child.

Even though a child may be within the age group for which this vehicle is recommended, he may not have the skills, abilities, or judgment needed to operate this vehicle safely and may be involved in a serious accident.

**HOW TO AVOID THE HAZARD**

No one under 16 should operate this vehicle.



 **WARNING**



V00A02Q

**POTENTIAL HAZARD**

Carrying a passenger on this vehicle.

**WHAT CAN HAPPEN**

Greatly reduces your ability to balance and control this vehicle.

Could cause an accident, resulting in harm to you and/or your passenger.

**HOW TO AVOID THE HAZARD**

Never carry a passenger. Even with a long seat that provides unrestricted operator movement, it is not designed nor intended to carry passenger(s).

**⚠ WARNING**

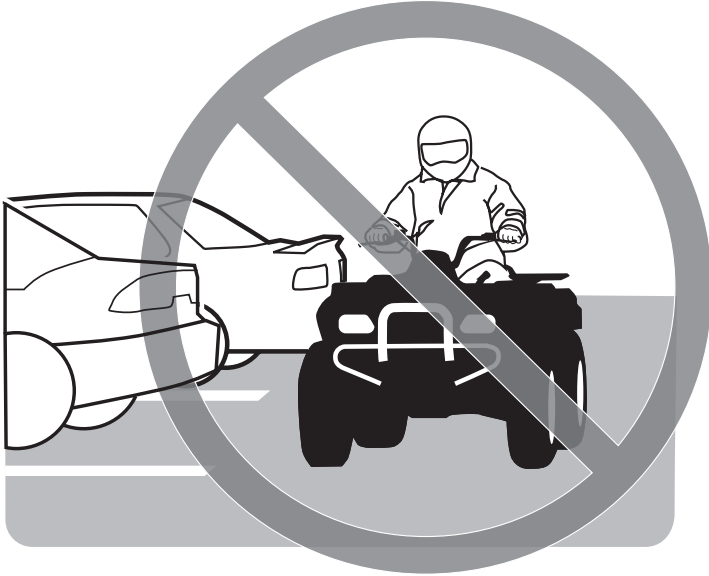

V00A03Q

**POTENTIAL HAZARD**

Operating this vehicle on paved surfaces.

**WHAT CAN HAPPEN**

The ATV's tires are designed for off-road use only, not for use on pavement. Paved surfaces may seriously affect handling and control of this vehicle, and may cause the vehicle to go out of control.

**HOW TO AVOID THE HAZARD**

Never operate this vehicle on any paved surfaces, including sidewalks, driveways, parking lots and streets.

**⚠ WARNING**



V00A04Q

**POTENTIAL HAZARD**

Operating this vehicle on public streets, roads or highways.

**WHAT CAN HAPPEN**

You can collide with another vehicle.

**HOW TO AVOID THE HAZARD**

Never operate this vehicle on any public street, road or highway, even a dirt or gravel one. In many states or provinces it is illegal to operate ATVs on public streets, roads or highways.

## **WARNING**



V00A06Q

### **POTENTIAL HAZARD**

Riding this vehicle without wearing an approved helmet, eye protection and protective clothing.

### **WHAT CAN HAPPEN**

The following items concern all ATV's operator:

- riding without an approved helmet increases the chances of a severe head injury or death in the event of an accident
- riding without eye protection can result in an accident and increases the chances of a severe injury in the event of an accident
- riding without protective clothing increases the chances of severe injury in the event of an accident.

### **HOW TO AVOID THE HAZARD**

Always wear an approved helmet that fits properly. You should also wear:

- eye protection (goggles or face shield)
- gloves and boots,
- long sleeved shirt or jacket
- long pants.

## WARNING



V00A07Q

### **POTENTIAL HAZARD**

Riding this vehicle after consuming alcohol or drugs.

### **WHAT CAN HAPPEN**

- Could seriously affect your judgment.
- Could cause you to react more slowly.
- Could affect your balance and perception.
- Could result in an accident or death.

### **HOW TO AVOID THE HAZARD**

Never consume alcohol or drugs before or while riding this vehicle.

 **WARNING**

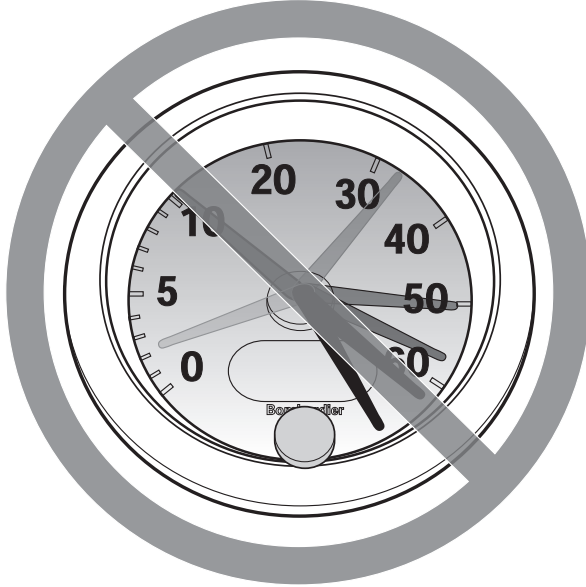

V00A08Q

**POTENTIAL HAZARD**

Operating this vehicle at excessive speeds.

**WHAT CAN HAPPEN**

Increases your chances of losing control of the vehicle, which can result in an accident.

**HOW TO AVOID THE HAZARD**

Always travel at a speed which is proper for the terrain, visibility and operating conditions, and your experience.

 **WARNING**



V00A09Q

**POTENTIAL HAZARD**

Attempting wheelies, jumps and other stunts.

**WHAT CAN HAPPEN**

Increases the chance of an accident, including an overturn.

**HOW TO AVOID THE HAZARD**

Never attempt stunts, such as wheelies or jumps. Do not try to show off.

 **WARNING**

**POTENTIAL HAZARD**

Failure to inspect the vehicle before operating.

Failure to properly maintain the vehicle.

**WHAT CAN HAPPEN**

Increases the possibility of an accident or equipment damage.

**HOW TO AVOID THE HAZARD**

Always inspect your vehicle each time you use it to make sure the vehicle is in safe operating condition.

Always follow the inspection and maintenance procedures and schedules described further in this *Operator's Guide*.

 **WARNING**

**POTENTIAL HAZARD**

Riding on frozen waterways.

**WHAT CAN HAPPEN**

Severe injury or death can result if the vehicle and/or operator break through the ice.

**HOW TO AVOID THE HAZARD**

Never ride this vehicle on a frozen surface before you are sure the ice is thick enough and sound enough to support the vehicle and its load, as well as the force that is created by a moving vehicle.



**⚠ WARNING**



V00A0BQ

**POTENTIAL HAZARD**

Removing hands from handlebar or feet from the footrests during operation.

**WHAT CAN HAPPEN**

Removing even one hand or foot can reduce your ability to control the vehicle or could cause you to lose your balance and fall off the vehicle. If you remove a foot from the footrests, your foot or leg may come into contact with the rear wheels, which could injure you or cause an accident.

**HOW TO AVOID THE HAZARD**

Always keep both hands on the handlebar and both feet on the footrests during vehicle operation.

**⚠ WARNING**

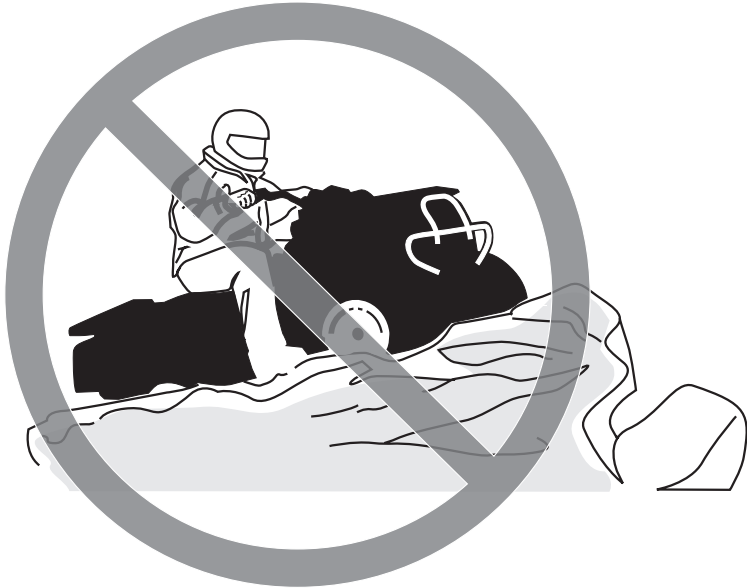

V00A0CQ

**POTENTIAL HAZARD**

Failure to use extra care when operating this vehicle on unfamiliar terrain.

**WHAT CAN HAPPEN**

You can come upon hidden rocks, bumps, or holes, without enough time to react.

Could result in the vehicle overturning or loss of control.

**HOW TO AVOID THE HAZARD**

Go slowly and be extra careful when operating on unfamiliar terrain.

Always be alert to changing terrain conditions when operating the vehicle.

## **WARNING**



V00A0DQ

### **POTENTIAL HAZARD**

Failure to use extra care when operating on excessively rough, slippery or loose terrain.

### **WHAT CAN HAPPEN**

Could cause loss of traction or vehicle control, which could result in an accident, including an overturn.

### **HOW TO AVOID THE HAZARD**

Do not operate on excessively rough, slippery or loose terrain until you have learned and practiced the skills necessary to control this vehicle on such terrain.

Always be especially cautious on these kinds of terrain.

**⚠ WARNING**



V00A0EQ

**POTENTIAL HAZARD**

Turning improperly.

**WHAT CAN HAPPEN**

Vehicle could go out of control, causing a collision or overturn.

**HOW TO AVOID THE HAZARD**

Always follow proper procedures for turning as described further in this *Operator's Guide*. Practice turning at low speeds before attempting to turn at faster speeds.

Do not turn at excessive speed.

**⚠ WARNING**



V00A0QQ

**POTENTIAL HAZARD**

Operating on excessively steep hills.

**WHAT CAN HAPPEN**

The vehicle can overturn more easily on extremely steep hills than on level surfaces or small hills.

**HOW TO AVOID THE HAZARD**

Never operate this vehicle on hills too steep for the vehicle or for your abilities.

Practice on smaller hills before attempting larger hills.

 **WARNING**



V00A0FQ

**POTENTIAL HAZARD**

Climbing hills improperly.

**WHAT CAN HAPPEN**

Could cause loss of control or cause vehicle to overturn.

**HOW TO AVOID THE HAZARD**

Always follow proper procedures for climbing hills as described further in this *Operator's Guide*.

Always check the terrain carefully before you start up any hill.

Never climb hills with excessively slippery or loose surfaces.

Shift your weight forward.

Never open the throttle suddenly or make sudden gear changes. The vehicle could flip over backwards.

Never go over the top of any hill at high speed. An obstacle, a sharp drop, or another vehicle or person could be on the other side of the hill.

**⚠ WARNING**



V00A0GQ

**POTENTIAL HAZARD**

Going down a hill improperly.

**WHAT CAN HAPPEN**

Could cause loss of control or cause vehicle to overturn.

**HOW TO AVOID THE HAZARD**

Always follow proper procedures for going down hills as described further in this *Operator's Guide*.

**NOTE:** A special technique is required when braking as you go down a hill.

Always check the terrain carefully before you start down any hill.

Shift your weight backward.

Never go down a hill at high speed.

Avoid going down a hill at an angle which would cause the vehicle to lean sharply to one side. Go straight down the hill where possible.

## WARNING



V00A0HQ

### **POTENTIAL HAZARD**

Improperly crossing hills or turning on hills.

### **WHAT CAN HAPPEN**

Could cause loss of control or cause vehicle to overturn.

### **HOW TO AVOID THE HAZARD**

Never attempt to turn the vehicle around on any hill until you have mastered the turning technique as described further in this *Operator's Guide* on level ground. Be very careful when turning on any hill.

Avoid crossing the side of a steep hill if possible.

#### ***When crossing the side of a hill:***

Always follow proper procedures as described further in this *Operator's Guide*.

Avoid hills with excessively slippery or loose surfaces.

Shift your weight to the uphill side of the vehicle.



## WARNING



V00A01Q

### **POTENTIAL HAZARD**

Stalling, rolling backwards or improperly dismounting while climbing a hill.

### **WHAT CAN HAPPEN**

Could result in vehicle overturning.

### **HOW TO AVOID THE HAZARD**

Use proper gear and maintain steady speed when climbing a hill.

#### ***If you lose all forward speed:***

Keep your weight uphill. Never open the throttle suddenly or make sudden gear changes. The vehicle could flip over backwards.

Apply the brakes.

Lock parking brake after you are stopped.

Dismount on uphill side, or to a side if pointed straight uphill.

#### ***If you begin rolling backwards:***

Keep your weight uphill. Never open the throttle suddenly or make sudden gear changes. The vehicle could flip over backwards.

Never apply the rear brake while rolling backwards.

Apply the front brake gradually.

When fully stopped, apply rear brake as well and lock parking brake.

Dismount on uphill side, or to a side if pointed straight uphill.

Turn the vehicle around and remount, following the procedure described further in this *Operator's Guide*.

**⚠ WARNING**



V00A0JQ

**POTENTIAL HAZARD**

Improperly operating over obstacles.

**WHAT CAN HAPPEN**

Could cause loss of control or a collision.

Could cause the vehicle to overturn.

**HOW TO AVOID THE HAZARD**

Before operating in a new area, check for obstacles.

Never attempt to ride over large obstacles, such as large rocks or fallen trees.

When you go over obstacles, always follow proper procedures as described further in this *Operator's Guide*.

**⚠ WARNING**



V00A0KQ

**POTENTIAL HAZARD**

Skidding or sliding improperly.

**WHAT CAN HAPPEN**

You may lose control of this vehicle.

You may also regain traction unexpectedly, which may cause the vehicle to overturn.

**HOW TO AVOID THE HAZARD**

Learn to safely control skidding or sliding by practicing at low speeds and on level smooth terrain.

On extremely slippery surfaces, such as ice, go slowly and be very cautious in order to reduce the chance of skidding or sliding out of control.

**⚠ WARNING**



V00A0LQ

**POTENTIAL HAZARD**

Operating this vehicle through deep or fast flowing water.

**WHAT CAN HAPPEN**

Tires may float, causing loss of traction and loss of control, which could lead to an accident.

**HOW TO AVOID THE HAZARD**

Never operate this vehicle in fast flowing water or in water deeper than that specified further in this *Operator's Guide*.

Check water depth and current before you attempt to cross any water. Water should not go above footrests.

Remember that wet brakes may have reduced stopping ability. Test your brakes after leaving water. If necessary, apply them several times to let friction dry out the pads.

 **WARNING**



V00A00Q

**POTENTIAL HAZARD**

Operating this vehicle with improper tires, or with improper or uneven tire pressure.

**WHAT CAN HAPPEN**

Use of improper tires on this vehicle, or operation of this vehicle with improper or uneven tire pressure, may cause loss of control, and increases the risk of an accident.

**HOW TO AVOID THE HAZARD**

Always use the size and type of tires specified further in this *Operator's Guide* for this vehicle.

Always maintain proper tire pressure as described further in this *Operator's Guide*.

 **WARNING**



V00A0NQ

**POTENTIAL HAZARD**

Operating this vehicle with improper modifications.

**WHAT CAN HAPPEN**

Improper installation of accessories or modification of this vehicle may cause changes in handling which in some situations could lead to an accident.

**HOW TO AVOID THE HAZARD**

Never modify this vehicle through improper installation or use of accessories. All parts and accessories added to this vehicle should be approved by BRP and should be installed and used according to instructions. If you have questions, consult an authorized Bombardier ATV dealer.

**⚠ WARNING**



V02A02Q

**POTENTIAL HAZARD**

Overloading this vehicle or carrying or towing cargo improperly.

**WHAT CAN HAPPEN**

Could cause changes in vehicle handling which could lead to an accident.

**HOW TO AVOID THE HAZARD**

Never exceed the stated load capacity for this vehicle including operator as well as other loads and added accessories.

Cargo should be properly distributed and securely attached.

Reduce speed when carrying cargo. Allow greater distance for braking.

Always follow the instructions in this *Operator's Guide* for carrying cargo.

 **WARNING**



V03M01Q

**POTENTIAL HAZARD**

Transporting inflammable or dangerous material can lead to explosions.

**WHAT CAN HAPPEN**

This can cause serious injury or death.

**HOW TO AVOID THE HAZARD**

Never transport inflammable or dangerous material.

While reading this Operator's Guide, remember that:

 **WARNING**

Indicates a potential hazard that, if not avoided, could result in serious injury or death.



---

# SAFETY WARNING

To fully appreciate the pleasures and excitement of riding this vehicle, there are some basic rules and tips that you should follow. Some may be new to you while others may be common sense or obvious. Irrespective, we ask that you take a few minutes to read this *Operator's Guide* completely before you operate this vehicle.

Information in this *Operator's Guide* is limited. It is strongly recommended that you obtain further information and training from your local authorities, ATV clubs or a recognized ATV training organization such as Specialty Vehicle Institute of America (SVIA) or the Canada Safety Council (CSC).

The U.S. Consumer Product Safety Commission and all ATV manufacturers do not recommended anyone under the age of 16 to ride an ATV having an engine higher than 90 cc. For the child's safety, we strongly recommend you also follow and enforce this recommendation. You are the sole judge of a rider's capability to understand the risks and operate a vehicle safely.

Persons with cognitive or physical impairments or who are high risk takers have an increased exposure to over-turns or collisions which may result in injury including death.

Become completely familiar with the operational controls and the general operation of the vehicle before venturing into off road conditions. Practice driving in a suitable area free of hazards and feel the response of each control. Drive at low speeds. Higher speeds require greater experience, knowledge and suitable riding conditions.

Not all vehicles are the same. Each has its own unique performance characteristics, controls and features. Each will ride and handle differently.

Never assume that the vehicle will go everywhere safely. Sudden changes in terrain caused by holes, depressions, banks, softer or harder "ground" or other irregularities may cause the vehicle to topple or become unstable. To avoid this, slow down and always observe the terrain ahead. If the vehicle does begin to topple or tipover, it is usually the best advice to immediately get off... AWAY from the direction of the tipover!

## Pre-Operation Check

### **WARNING**

The pre-operation check is very important prior to operating the vehicle. Always check the proper operation of critical controls, safety features and mechanical components before starting. If not done, severe injury or death might occur.

Before using this vehicle, the operator should always:

- Apply parking brake and check if it operates properly.
- Check tire pressure and condition.
- Check wheels and bearings for wear and damage.
- Check location of controls and ensure they work properly.
- Verify if steering operates freely.
- Activate throttle control lever several times to ensure it operates freely. It must return to idle position when released.
- Activate the brake lever and brake pedal to make sure the brakes fully apply. They must fully return when released.
- Check all brake line fittings for tightness and against leaks.
- With parking brake correctly applied, activate the clutch lever. It must fully return when released.
- Check drive chain for adjustment and lubrication.
- Check sprockets for wear and damages.
- Check tightening of rear axle fasteners.
- Check swing arm, if any lateral play is detected **DO NOT USE THE VEHICLE.**
- Check fuel, oil and coolant levels.

- Check for oil leaks on the engine, oil tank and transmission.
- Ensure fuel valve is in fully open position (ON).
- Clean headlamp and taillight.
- Ensure seat is properly latched.
- If you transport cargo, respect load capacity. Ensure cargo is properly secured to the vehicle.
- Look and feel for loose parts while engine is off. Check fasteners.
- Ensure the path of travel is free of persons and obstacles.
- Check operation of ignition switch, start button, engine stop switch and headlamp switch.
- Start engine, remove parking brake and drive forward slowly a few feet then apply all brakes individually to test them.

**Correct any problem you may have found before riding. See an authorized Bombardier ATV dealer as necessary.**

# Clothing

Actual weather conditions should help you decide how to dress. However, it is important that the operator always wear the appropriate protective clothing and apparel, including an approved helmet, eye protection, boots, gloves, long sleeved shirt and pants. This type of clothing will provide you protection from some of the minor hazards you may encounter en route. Operator must never wear loose clothing such as a scarf that may get entangled in the vehicle or on tree branches and shrubs. Depending on conditions, antifogging goggles or sun glasses may be required. Different colored lenses available for goggles or sun glasses help you distinguish terrain variations. Sun glasses should only be worn during the daytime.

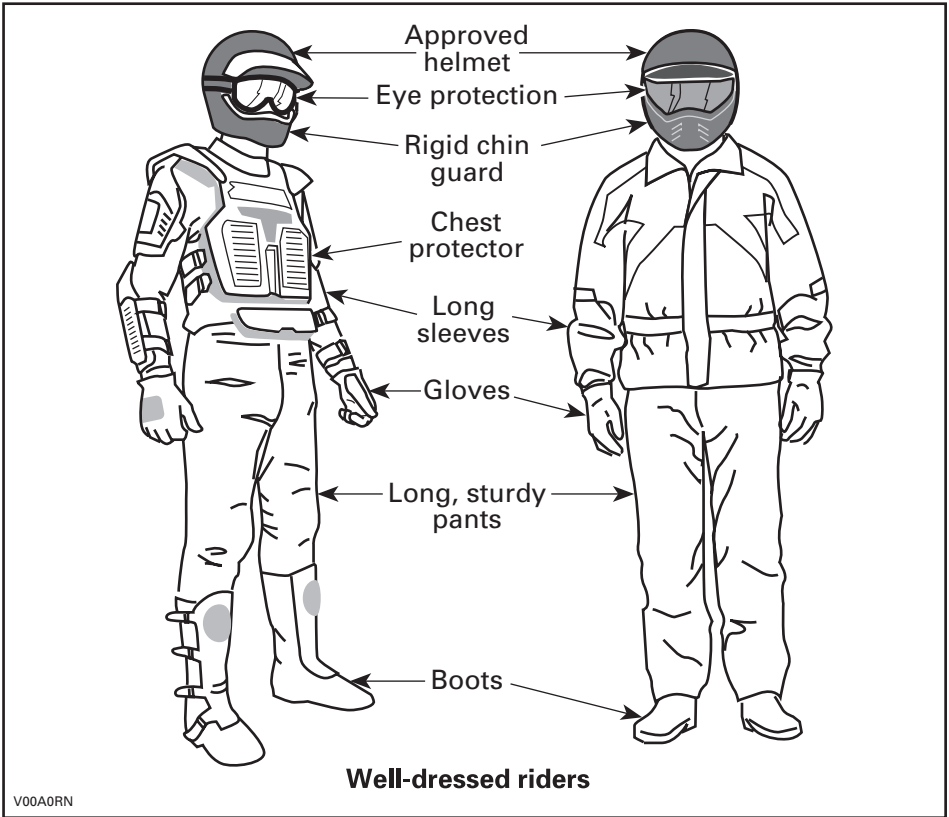

## Carrying Loads

Any load carried on the vehicle will affect the stability and control of the vehicle. For this reason, do not exceed the load limits of the vehicle's manufacturer. Always make sure the load is secured and cannot interfere with your proper control. Always be aware that the "load" may slide or fall off and create an accident. Avoid loads that may protrude sideways and get snagged or caught in brush or other obstacles. Avoid covering and obstructing the headlamp or taillight with the cargo.

This vehicle is designed specifically to carry an operator only. Even with a long seat that provide unrestricted operator movements, it is not designed nor intended to carry passenger(s). Carrying passenger(s) may affect the stability and your control of the vehicle.

## Recreational Riding

Respect the rights and limitations of others. Stay away from areas designated for other types of off road use. This includes snowmobile trails, equestrian trails, cross country ski trails, mountain bike trails etc. Never assume there are no other users on the trail. Always stay to the complete right of the trail and do not zig zag to one side of the trail then the other. Be prepared to stop or pull off to the side if another trail user appears in front of you.

Join a local ATV club. They will provide you with a map and advice or inform you where you can ride. If a club does not exist in your area, help start one. Group riding and club activities provide a pleasurable, social experience.

Always keep a safe distance from other riders. Your judgment of speed, terrain conditions, weather, mechanical condition of your vehicle and the "trust in judgment" you have in others around you will help you make a better choice of appropriate safe distance. This vehicle, like any other motorized vehicle, cannot stop "on a dime".

Before you ride, tell someone where you are planning to travel and your expected time of return. Never consume alcohol or drugs before or while riding!

Depending on the length of your ride, carry additional tools or emergency equipment. Find out where you can get additional gasoline and oil. Be prepared for the possible conditions you may encounter. An emergency first aid kit should always be a consideration.

## Environment

One of the benefits of this vehicle is that it can take you off the beaten path away from most communities. However, you should always respect nature and the rights of others to enjoy it. Do not ride in environmentally sensitive areas. Do not drive over forest crops or shrubs... nor cut down trees or take down fencing... nor spin your wheels and destroy the terrain. "Tread Lightly".

Chasing wildlife is in many areas illegal. Wildlife can die of exhaustion after being chased by a motorized vehicle. If you encounter animals on the trail, stop and observe quietly and with caution. It will be one of the better memories of your life.

Observe the rule... "what you take in, carry out". Do not litter. Do not start campfires unless you have permission to do so... and then only... away from dry areas. The hazards you may create on the trail may cause injury to others or yourself, even at a later date.

Respect farm lands. Always obtain the permission of the landowner before riding on private land. Respect crops, farm animals and property lines. If you come to a closed a gate, close it again after yourself.

Finally, do not pollute streams, lakes or rivers and do not modify the engine or muffling system, or remove any of its components.

## **Design Limitation**

Although the vehicle is exceptionally rugged for its class, it is still a light vehicle by definition and its operation must be restricted to its proper purpose.

The addition of weight to any part of the vehicle changes its gravitational stability and modifies its performance.

## **Off-Highway Operation**

The very nature of off-highway operation is dangerous. Any terrain, which has not been specially prepared to carry vehicles, presents an inherent danger where angularity, terrain substance and exact steepness are unpredictable. The terrain itself presents a continual element of danger, which must be knowingly accepted by anyone venturing over it.

An operator who takes a vehicle off-road should always exercise the utmost care in selecting the safest path and keeping close watch on the terrain ahead of him. On no account should the vehicle be operated by anyone who is not completely familiar with the driving instructions applicable to the vehicle, nor should it be operated on steep or treacherous terrain.

## **General Operating and Safety Precautions**

Care, caution, experience and driving skill are the best precautions against the hazards of vehicle operation.

Whenever there is the slightest doubt that the vehicle can safely negotiate an obstacle or a particular piece of terrain, always choose an alternate route.

In off-road operation, power and traction, not speed, are important. Never drive faster than visibility and your own ability to select a safe route permit.

Constantly watch the terrain ahead for sudden changes in slopes or obstacles, such as rocks or stumps, that may cause loss of stability, resulting in tipover or rollover.

Never operate the vehicle if the controls do not function normally.

When stopped or parked, always apply the parking brake. This is especially important when parking on a slope. On very steep inclines or if the vehicle is carrying cargo, the wheels should be blocked using rocks or bricks. Remember to turn the fuel valve to the closed position.

## Uphill Driving

Due to configuration, this vehicle has excellent climbing ability, so much so that tipover is possible before traction is lost. For example, it's common to encounter terrain situations where the top of the hill has eroded to a point that the hill peak rises very sharply. The vehicle can readily negotiate such a condition, however, in doing so, when the front of the vehicle is driven to a point that the vehicle's balance changes rearward tipover can occur.

The same situation may apply if an embedded object causes the front of the vehicle to climb more than desired. If such a situation occurs take an alternate route. Be aware of side hilling dangers when doing so.

It is also wise to know the terrain condition on the other side of the hill or bank. All too often there exists a sharp drop-off that is impossible to negotiate or descend.

## Downhill Driving

This vehicle can climb slopes that are steeper than it can safely descend. Therefore, it is essential to assure that a safe route exists to descend a slope before you climb it.

Decelerating while negotiating a slippery downhill slope could "toboggan" the vehicle. Maintain steady speed and/or accelerate slightly to regain control.

## Side Hilling

Whenever possible, such operation should be avoided. If necessary, do so with extreme caution. Side hilling on steep inclines could result in rollover. In addition, slippery or uneven surfaces could result in uncontrollable side sliding. Do not attempt to turn the vehicle downhill with the slide. Avoid all objects or depressions that will intensify the raising of one side of the vehicle higher than the other, thus causing rollover.

## Drop-Offs

This vehicle will "bottom-out" and usually stop if either the front or rear wheels are driven over a drop-off. If the drop is sharp or deep, the vehicle will nose dive and tipover.

### **WARNING**

Avoid negotiating drop-offs. Reverse and select an alternate route.

## Riding Techniques

Riding your vehicle too fast for the conditions may result in injury. Apply only enough throttle to proceed safely. Statistics show that high speed turns usually result in mishaps and injury. Always remember that this vehicle is heavy! Its pure weight alone may entrap you should it fall and pin you down.

This vehicle is not designed for jumping nor can it, or you, absorb the energy of high impacts such as jumping. Performing "wheelies" can cause the vehicle to flip over onto you. Both practices have a high risk for you and should be avoided at all times.

To maintain proper control it is strongly advised that you keep your hands on the handlebar and within easy reach of all controls. The same holds true for your feet. To minimize the possibility of any leg or foot injury, keep your feet on the footrests at all times. Do not direct your toes outwards nor place your foot out to assist turning as they can be hit or snagged by passing obstacles or may contact the wheels.

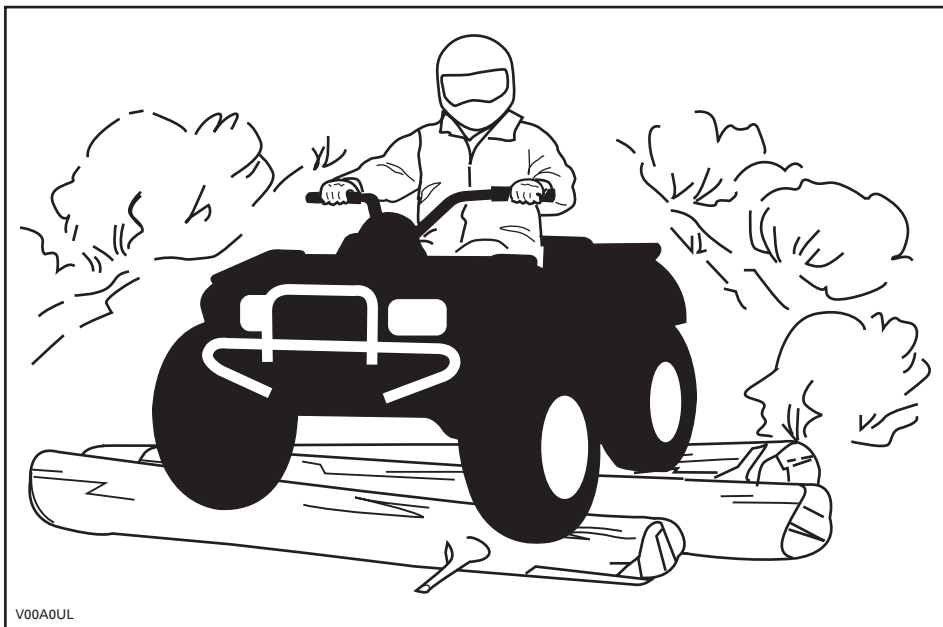

Even though there is an adequate suspensions system on this vehicle there are "washboard" or rough terrain conditions that will make you feel uncomfortable and even cause back injury. "Posting" or riding in a crouched position will often be required. Slow down and allow your flexed legs to absorb impact.

This vehicle is not designed for riding on roads or highways. In most places it is an illegal practice. Riding your vehicle on roads or highways could cause a collision to occur with another vehicle. ATV tires are not suited for paved road use. Pavement may seriously affect the handling and control of the vehicle. Riding on roads or soft shoulders may confuse other road users, especially if your lights are on. If you have to cross a road, the lead driver should get off his vehicle then observe and give directions to the other riders. The last person after crossing then assists the lead driver to cross. Do not travel sidewalks. They are designated for pedestrian use.

Water can be a unique hazard. If it is too deep the vehicle may "float" and topple. Check the water depth and current before you attempt to cross any water. Water should not go above the footrest. Be wary of slippery surfaces such as rocks, grass, logs, etc., both in the water and on its banks. A loss of traction may occur. Do not attempt to enter the water at high speed. The water will act as a brake and could throw you.

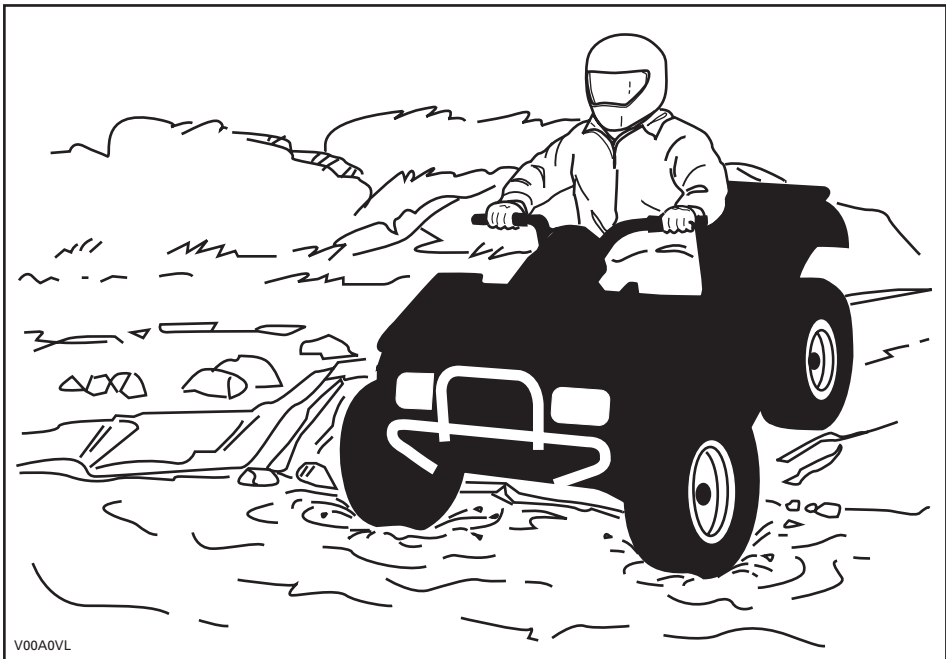

Water will affect the braking ability of your vehicle. Make sure you dry the brakes by applying them several times after the vehicle leaves the water.

Mud or marsh lands may be encountered near water. Be prepared for sudden “holes” or changes in depth. Similarly so, be watchful of hazards such as rocks, logs, etc., partially covered by vegetation.

If your trip crosses frozen waterways, make sure that the ice is thick enough and sound enough to support the total weight of yourself, the vehicle and its load. Be ever watchful of open water... it is a sure indication that the ice thickness will vary. If in doubt, do not attempt to cross.

Ice will also affect the control of vehicle. Slow down and do not “gun” the throttle. This will only result in spinning of the tires and possible tipover of the vehicle. Avoid rapid braking. This again will possibly result in an uncontrolled slide and tipover of the vehicle. Slush should be avoided at all times since it could block the operation or controls of the vehicle

Sand and riding on sand dunes or on snow is another unique experience but there are some basic precautions that should be observed. Wet, deep or fine sand/snow may create a loss of traction and cause the vehicle to slide, drop off or become “bogged” down. If this occurs look for a firmer base. Again, the best advice is to slow down and be watchful of the conditions.



When riding in sand dunes it is advisable to equip the vehicle with an antenna type safety flag. This will help make your location more visible to others over the next sand dune. Proceed carefully should you see another safety flag ahead. Since the antenna type safety flag can snag and rebound on your body if caught, do not use it in areas where there are low hanging branches or obstacles.

Riding on loose stones or gravel is very similar to riding on ice. They will affect the steering of vehicle... possibly causing it to slide and tipover especially at high speeds. In addition, braking distance may be affected. Remember that "gunning" the throttle or sliding may cause loose stones to be ejected rearwards into the path of another rider's way. Never do it deliberately.

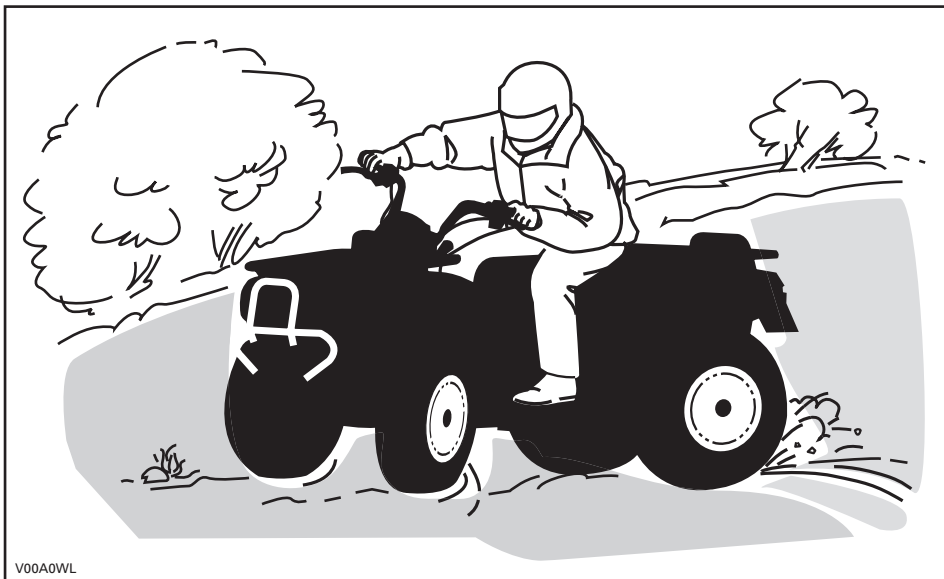

V00A0WL

If you do get into a slide or skid, it may help to turn the handlebar into the direction of the skid until you regain control. Never jam the brakes and lock the wheels.

Respect and follow all posted trail signs. They are there to help you and others.

Obstacles in the "trail" should be traversed with caution. This includes loose rocks, fallen trees, slippery surfaces, fences, posts, and embankments and depressions. You should avoid them whenever possible. Remember that some obstacles are too large or dangerous to cross and should be avoided. Small rocks or fallen trees may be safely crossed... approach at a 90° angle. Stand on the footrests while keeping your knees flexed. Adjust speed without losing momentum and do not "gun" the throttle. Hold handgrips firmly. Place your body weight rearwards and proceed. Do not try to lift the vehicle front wheels off the ground. Be aware that the object may be slippery or may move while crossing.

When driving on hills or slopes two things are highly important... be prepared for slippery surfaces or terrain variations and obstacles and... use proper body positioning.

## Uphill

Keep your body weight forward towards the top of the hill. Keep your feet on the footpegs and shift into low gear then accelerate and when necessary, change gear quickly as you climb. Do not over-speed since this may cause the front of the vehicle to lift from the ground and fall back on you. If the hill is too steep and you cannot proceed or the vehicle begins to roll backwards, apply the brake, being careful not to slide. Dismount then use the "U" turn or "K" turn (while walking back, next to the vehicle on the up hill side and with a hand on the brake lever, slowly back the rear of the vehicle toward the top of the hill then drive downhill). Always walk or dismount on the upside of the slope while keeping clear of the vehicle and its rotating wheels. Do not try to hold on to the vehicle if it begins to topple. Stay clear. Do not ride over the crest of the hill at high speed. Obstacles, including sharp drop-offs, may exist.

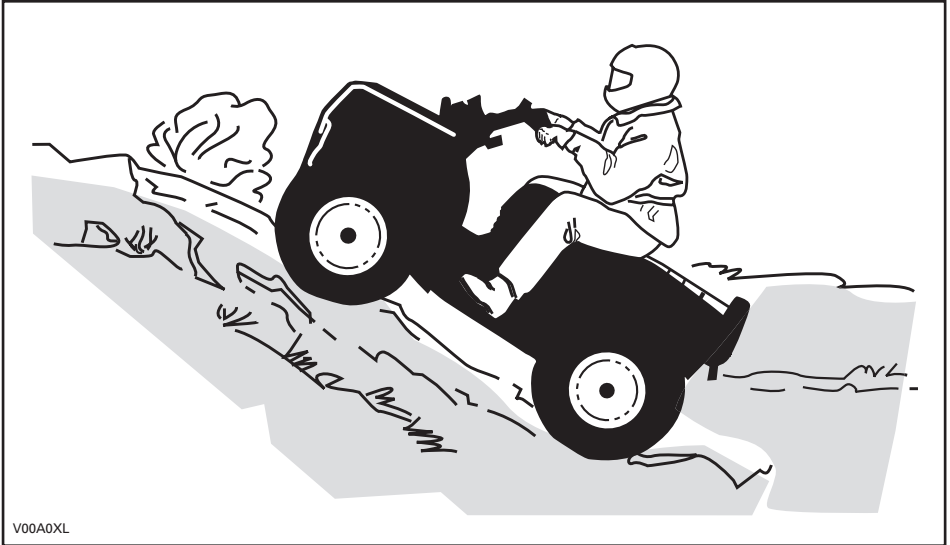

V00A0XL

## Downhill

Keep your body weight rearwards. Apply the brake gradually to prevent skidding. Do not "coast" down the slope using solely engine compression or in neutral gear.

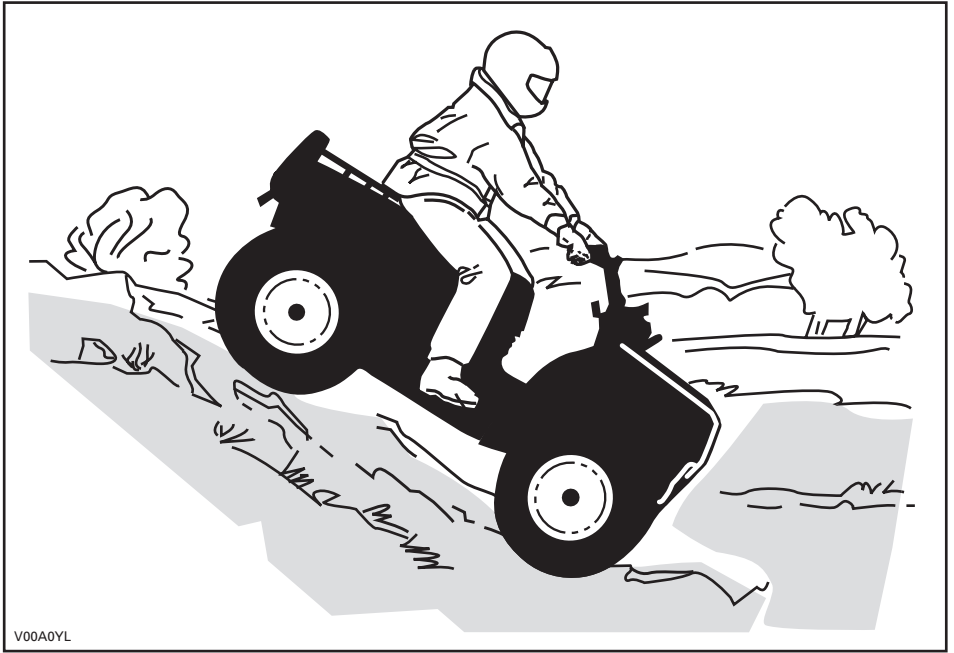

## Side Hilling

This is one of the **most risky** types of riding since it may drastically change the balance of the vehicle. It should be avoided wherever possible. If it is necessary to do so however, it is important that you **ALWAYS** keep your body weight on the upside of the slope... and be prepared to dismount on that side should the vehicle begin to topple. **Do not try to stop or save the vehicle from damage.**



V00A0ZL

## Routine Maintenance

Once your ride completed, it is wise to remove any build up of snow, ice, mud and grime. Not only will this help you keep your vehicle longer and in good condition for resale but will eliminate potential hazards the next time you use the vehicle. Wash your vehicle in warm soapy water then allow it to dry. (A towel may help). Do not wash your vehicle outside during freezing weather. Apply appropriate lubrication as described in the MAINTENANCE section.

Part of your responsibility towards safety is to respect the contents of this *Operator's Guide*. It provides valuable advice on how to properly take care of your vehicle. If further assistance is required your authorized Bombardier ATV dealer is always willing to help.

Modification of the vehicle to increase speed and performance may violate the terms and conditions of your vehicle limited warranty. In addition, certain modifications including the removal of engine or exhaust components are illegal under most laws.

Changing the wheel and/or tire size may affect the stability of the vehicle. Incorrect tire pressure may lead to blow outs or cause a tire to move around on its rim and become lost or damaged. Wheels or tires which are damaged should always be replaced.

While reading this Operator's Guide, remember that:













 **WARNING**

Indicates a potential hazard that, if not avoided, could result in serious injury or death.

# HANG TAG

This vehicle comes with a hang tag and labels containing important safety information.

Any person who rides this vehicle should read and understand this information before riding.

<p style="text-align: center;"><b>S</b> <b>SPORT MODEL</b></p> <p style="text-align: center;">THIS ATV IS FOR RECREATIONAL USE BY EXPERIENCED OPERATORS ONLY.</p> <p style="text-align: center;">OPERATOR ONLY-NO PASSENGERS</p> <p style="text-align: center;">NO OPERATOR UNDER AGE 16</p> <hr/> <p>THIS CATEGORY S (SPORT) ATV IS A HIGH PERFORMANCE ATV FOR OFF ROAD USE ONLY. IT IS FOR SPORT TYPE RECREATIONAL AND COMPETITIVE USE BY OPERATORS WITH ADVANCED SKILLS AND SUBSTANTIAL EXPERIENCE.</p> <hr/> <p>TRAINING COURSES TO TEACH ATV RIDING SKILLS ARE AVAILABLE. FOR INFORMATION CONTACT YOUR DEALER.</p> <hr/> <p>CHECK WITH YOUR DEALER TO FIND OUT ABOUT STATE OR LOCAL LAWS REGARDING ATV OPERATION.</p> <p style="text-align: center;"><b>THIS HANGTAG IS NOT TO BE REMOVED BEFORE SALE.</b></p> <p style="text-align: right;"><small>7045900923</small></p>	<p style="text-align: center;"><b>⚠ WARNING</b></p> <p>Improper ATV use can result in SEVERE INJURY or DEATH.</p> <table border="0" style="width: 100%; text-align: center;"><tr><td></td><td></td><td></td><td></td></tr><tr><td><small>ALWAYS USE AN APPROVED HELMET AND PROTECTIVE GEAR.</small></td><td><small>NEVER USE ON PUBLIC ROADS.</small></td><td><small>NEVER CARRY PASSENGERS.</small></td><td><small>NEVER USE WITH DRUGS OR ALCOHOL.</small></td></tr></table> <p><b>NEVER operate:</b></p> <ul style="list-style-type: none"><li>• without proper training or instructions.</li><li>• at speeds too fast for your skills or the conditions.</li><li>• on public roads - a collision can occur with another vehicle.</li><li>• with a passenger - passengers affect balance and steering and increase risk of losing control.</li></ul> <p><b>ALWAYS:</b></p> <ul style="list-style-type: none"><li>• use proper riding techniques to avoid vehicle overturns on hills and rough terrain and in turns.</li><li>• avoid paved surfaces - pavement may seriously affect handling and control.</li></ul> <p style="text-align: center;">LOCATE AND READ OPERATOR'S GUIDE. FOLLOW ALL INSTRUCTIONS &amp; WARNINGS.</p>					<small>ALWAYS USE AN APPROVED HELMET AND PROTECTIVE GEAR.</small>	<small>NEVER USE ON PUBLIC ROADS.</small>	<small>NEVER CARRY PASSENGERS.</small>	<small>NEVER USE WITH DRUGS OR ALCOHOL.</small>
									
<small>ALWAYS USE AN APPROVED HELMET AND PROTECTIVE GEAR.</small>	<small>NEVER USE ON PUBLIC ROADS.</small>	<small>NEVER CARRY PASSENGERS.</small>	<small>NEVER USE WITH DRUGS OR ALCOHOL.</small>						

V02M0FL

# LOCATION OF THE IMPORTANT LABELS

The following labels are on your vehicle and they should be considered permanent parts of the vehicle. If missing or damaged, they can be replaced free of charge. See an authorized Bombardier ATV dealer.

**NOTE:** The following illustrations used in this *Operator's Guide* are a general representation only. Your model may differ.

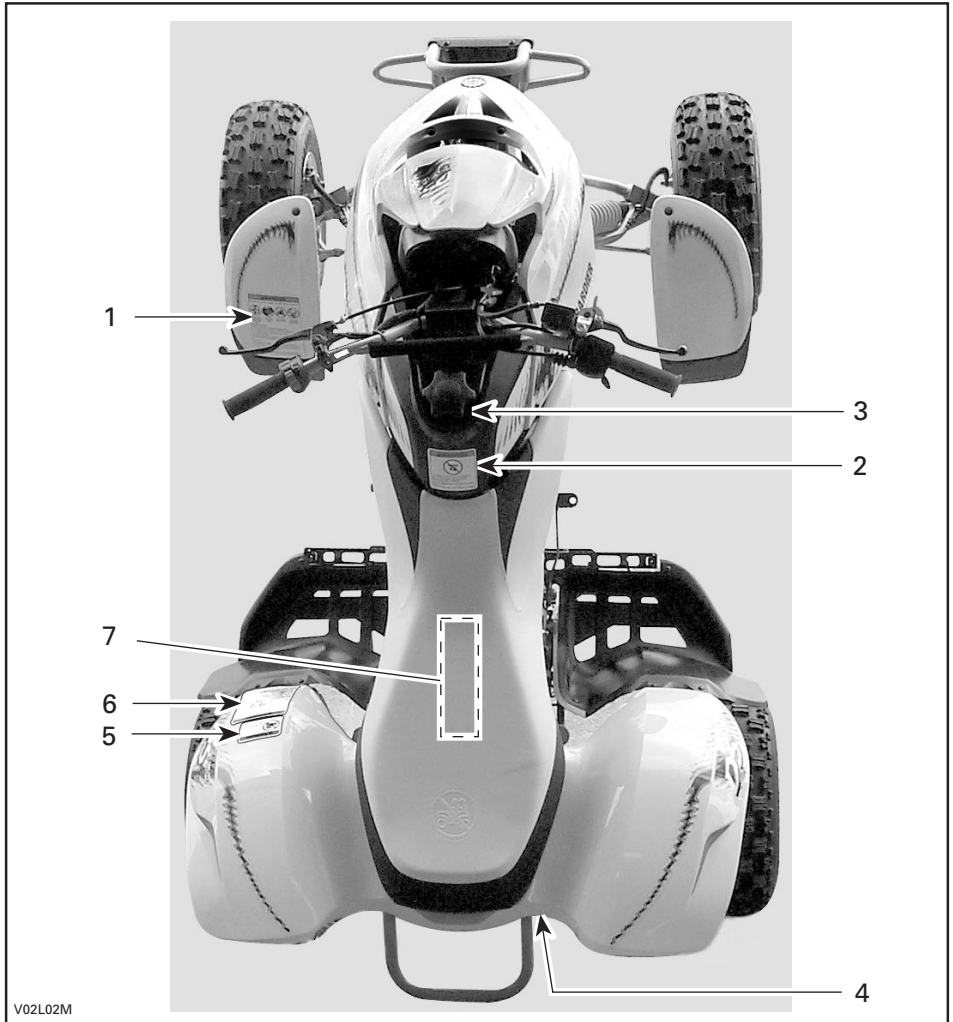

## LABEL 1

**⚠ WARNING**

Improper ATV use can result in **SEVERE INJURY** or **DEATH**.



**ALWAYS** USE AN APPROVED HELMET AND PROTECTIVE GEAR.



**NEVER** USE ON PUBLIC ROADS.



**NEVER** CARRY PASSENGERS.



**NEVER** USE WITH DRUGS OR ALCOHOL.

**NEVER** operate:

- without proper training or instructions.
- at speeds too fast for your skills or the conditions.
- on public roads - a collision can occur with another vehicle.
- with a passenger - passengers affect balance and steering and increase risk of losing control.

**ALWAYS:**

- use proper riding techniques to avoid vehicle overturns on hills and rough terrain and in turns.
- avoid paved surfaces - pavement may seriously affect handling and control.

LOCATE AND READ OPERATOR'S GUIDE.  
FOLLOW ALL INSTRUCTIONS & WARNINGS.

704 900 001

V01M01Z

## LABEL 4

**DRIVE CHAIN**

DRIVE CHAIN MUST BE WELL ADJUSTED AND LUBRICATED. FREE PLAY IS 22mm (7/8") WITH DRIVER ON VEHICLE. SEE OWNERS MANUAL FOR COMPLETE INSTRUCTIONS.

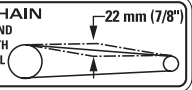

V02M06Y

## LABEL 5

**⚠ WARNING**



**NEVER** ride as a passenger. Passengers can cause a loss of control, resulting in **SEVERE INJURY** or **DEATH**.

704 900 005

V01M07Z

## LABEL 2

**⚠ WARNING**



Operating this ATV if you are under the age of 16 increases your chance of **SEVERE INJURY** or **DEATH**.

**NEVER** operate this ATV if you are under age 16.

704 900 011

V01M02Z

## LABEL 6

**⚠ WARNING**

Improper tire pressure or overloading can cause loss of control, resulting in **SEVERE INJURY** or **DEATH**.

LOAD	COLD TIRE PRESSURE
UP TO 100 kg (220 lb)	FRONT
	MAX: 34,5 kPa (5 psi)
	MIN: 21,0 kPa (3 psi)
	REAR
	MAX: 34,5 kPa (5 psi)
	MIN: 21,0 kPa (3 psi)

**ALWAYS** maintain proper tire pressure as shown.

**NEVER** set tire pressure below minimum. It could cause the tire to dislodge from the rim.

**NEVER** exceed the vehicle load capacity of 100 kg (220 lb) including weight of operator, cargo, accessories and trailer tongue weight.

704900014

V02M0GY

## LABEL 3

**⚠ WARNING**

This ATV may exceed the performance of other ATVs you may have ridden in the past.



This category S (sport) is a high performance ATV for off road use only. It is for sport type recreational and competitive use by operators with advanced skills and substantial experience.

704 900 089

V02M05Y



## LABEL 7

<p><b>EMISSION CONTROL INFORMATION</b> THIS VEHICLE MEETS U.S. ENVIRONMENTAL PROTECTION AGENCY AND C.A.R.B. REGULATIONS FOR MODEL YEAR 2006.</p> <p>SEE OPERATOR'S GUIDE FOR MAINTENANCE SPECIFICATIONS</p>	<table border="1" style="width: 100%; border-collapse: collapse;"> <tr><td>ENGINE FAMILY</td><td>6BCKX86226C</td></tr> <tr><td>FEL</td><td>13.4 g/kWh HC + NOx</td></tr> <tr><td>ENGINE DISPLACEMENT</td><td>651.88 cm<sup>3</sup></td></tr> <tr><td>EXHAUST EMISSION CONTROL SYSTEM</td><td>CARB</td></tr> <tr><td>FUEL</td><td>Unleaded (89 octane) 57 octane (100+mpg) 92</td></tr> <tr><td>ENGINE OIL</td><td>SAE 10W40</td></tr> <tr><td>IDLE SPEED</td><td>1300 RPM ± 100</td></tr> <tr><td>SPARK PLUG TYPE</td><td>NGK DR16CA</td></tr> <tr><td>SPARK PLUG GAP</td><td>0.6-0.8 mm / 0.024-0.032 in (ps)</td></tr> </table>	ENGINE FAMILY	6BCKX86226C	FEL	13.4 g/kWh HC + NOx	ENGINE DISPLACEMENT	651.88 cm <sup>3</sup>	EXHAUST EMISSION CONTROL SYSTEM	CARB	FUEL	Unleaded (89 octane) 57 octane (100+mpg) 92	ENGINE OIL	SAE 10W40	IDLE SPEED	1300 RPM ± 100	SPARK PLUG TYPE	NGK DR16CA	SPARK PLUG GAP	0.6-0.8 mm / 0.024-0.032 in (ps)	<p><b>FAMILLE DE MOTEUR</b> LEF</p> <p><b>SYSTEME DE CONTRÔLE DES ÉMISSIONS</b> ESSENCE</p> <p><b>HUILE À MOTEUR</b> VITESSE DE RALENTI</p> <p><b>TYPE DE BOUGIE</b> ÉCARTEMENT DES ÉLECTRODES</p> <p>VOIR GUIDE DU CONDUCTEUR POUR LES DONNÉES SPÉCIFICATIONS D'ENTRETIENS</p>	
ENGINE FAMILY	6BCKX86226C																				
FEL	13.4 g/kWh HC + NOx																				
ENGINE DISPLACEMENT	651.88 cm <sup>3</sup>																				
EXHAUST EMISSION CONTROL SYSTEM	CARB																				
FUEL	Unleaded (89 octane) 57 octane (100+mpg) 92																				
ENGINE OIL	SAE 10W40																				
IDLE SPEED	1300 RPM ± 100																				
SPARK PLUG TYPE	NGK DR16CA																				
SPARK PLUG GAP	0.6-0.8 mm / 0.024-0.032 in (ps)																				
		<p><b>RENSEIGNEMENTS SUR LE DISPOSITIF ANTIPOLLUTION</b> CE VÉHICULE SATISFAIT AUX NORMES 2006 DE L'E.P.A. &amp; À LA RÉGLEMENTATION CALIFORNIENNE.</p>																			

704901075

## LABEL 8

	<p><b>RENSEIGNEMENTS SUR LE DISPOSITIF ANTIPOLLUTION</b></p> <p>CE VÉHICULE N'EST PAS CONCERNÉ PAR LES NORMES 2006 DE L'E.P.A. DES É.-U. EN VERTU DE LA RÉGLEMENTATION 40 CFR 1061.</p>
<p><b>EMISSION CONTROL INFORMATION</b></p> <p>THIS VEHICLE IS NOT SUBJECT TO PHASE-IN EPA EMISSION STANDARDS AND RELATED REQUIREMENTS FOR MODEL YEAR 2006 APPLICABLE UNDER 40 CFR 1061.</p>	<p><b>RENSEIGNEMENTS SUR LE DISPOSITIF ANTIPOLLUTION</b></p> <p>CE VÉHICULE N'EST PAS CONCERNÉ PAR LES NORMES 2006 DE L'E.P.A. DES É.-U. EN VERTU DE LA RÉGLEMENTATION 40 CFR 1061.</p>
<p>512060138</p>	<p>512 060 138</p>

512060138

While reading this Operator's Guide, remember that:

### ⚠ **WARNING**

Indicates a potential hazard that, if not avoided, could result in serious injury or death.



# ***VEHICLE INFORMATION***

# HOW TO IDENTIFY YOUR ATV

The main components of your vehicle (engine and frame) are identified by different serial numbers. It may sometimes become necessary to locate these numbers for warranty purposes or to trace your vehicle in the event of loss. These numbers are required by the authorized Bombardier ATV dealer to complete warranty claims properly. No warranty will be allowed by BRP if the engine identification number (EIN) or vehicle identification number (VIN) is removed or mutilated in any way. We strongly recommend that you take note of all the serial numbers on your vehicle and supply them to your insurance company.

## Engine and Vehicle Identification Number Location

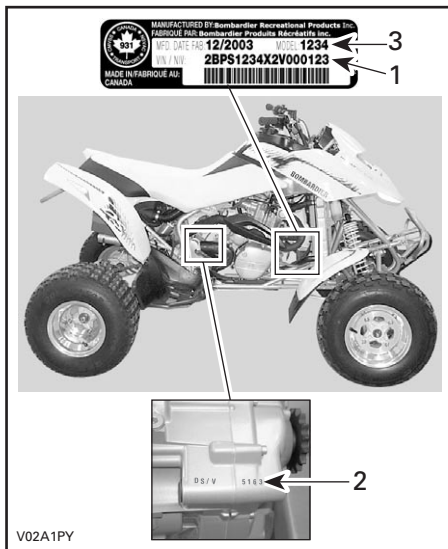

1. VIN (Vehicle Identification Number)
2. EIN (Engine Identification Number)
3. Model number

## Compliance Label

This label indicates vehicle's conformity in many countries.

The label is located on the right side of vehicle, on the upper bar of frame.



USA AND CANADA



OTHER COUNTRIES IN THE WORLD

---

# NOISE EMISSION CONTROL SYSTEM REGULATION

## **Tampering with Noise Control System is Prohibited!**

U.S. Federal law and Canadian provincial laws may prohibit the following acts or the causing there of:

1. The removal or rendering inoperative by any person other than for purposes of maintenance, repair or replacement of any device or element of design incorporated into any new vehicle for the purpose of noise control prior to its sale or delivery to the ultimate purchaser or while it is in use or,
2. The use of the vehicle after such device or element of design has been removed or rendered inoperative by any person.

## **Among those Acts Presumed to Constitute Tampering Are the Acts Listed Below:**

1. Removal or alteration or the puncturing of the muffler or any engine component which conducts removal of engine exhaust gases.
2. Removal or alteration or the puncturing of any part of the intake system.
3. Replacing any moving parts of the vehicle or parts of the exhaust or intake system, with parts other than those specified by the manufacturer.
4. Lack of proper maintenance.

---

## EMISSION REQUIREMENTS

The California Air Resources Board (CARB) requires that your ATV complies with applicable exhaust emissions standards during its useful life, when operated and maintained according to the instructions supplied.

A non-compliance Red Label (as well as a Green Label) is obtained annually during California Vehicle registration. The appropriate label is denoted by the vehicle identification number (in the 8<sup>th</sup> character detailed herein).

VEHICLE CATEGORY	VIN 8 <sup>TH</sup> CHARACTER
Non-complying red label	Must denote a C or 3
Complying green label	Any alphanumeric designation other than a C or 3

# CONTROLS/COMPONENTS/INSTRUMENT

NOTE: Some controls/instruments/equipment are optional.

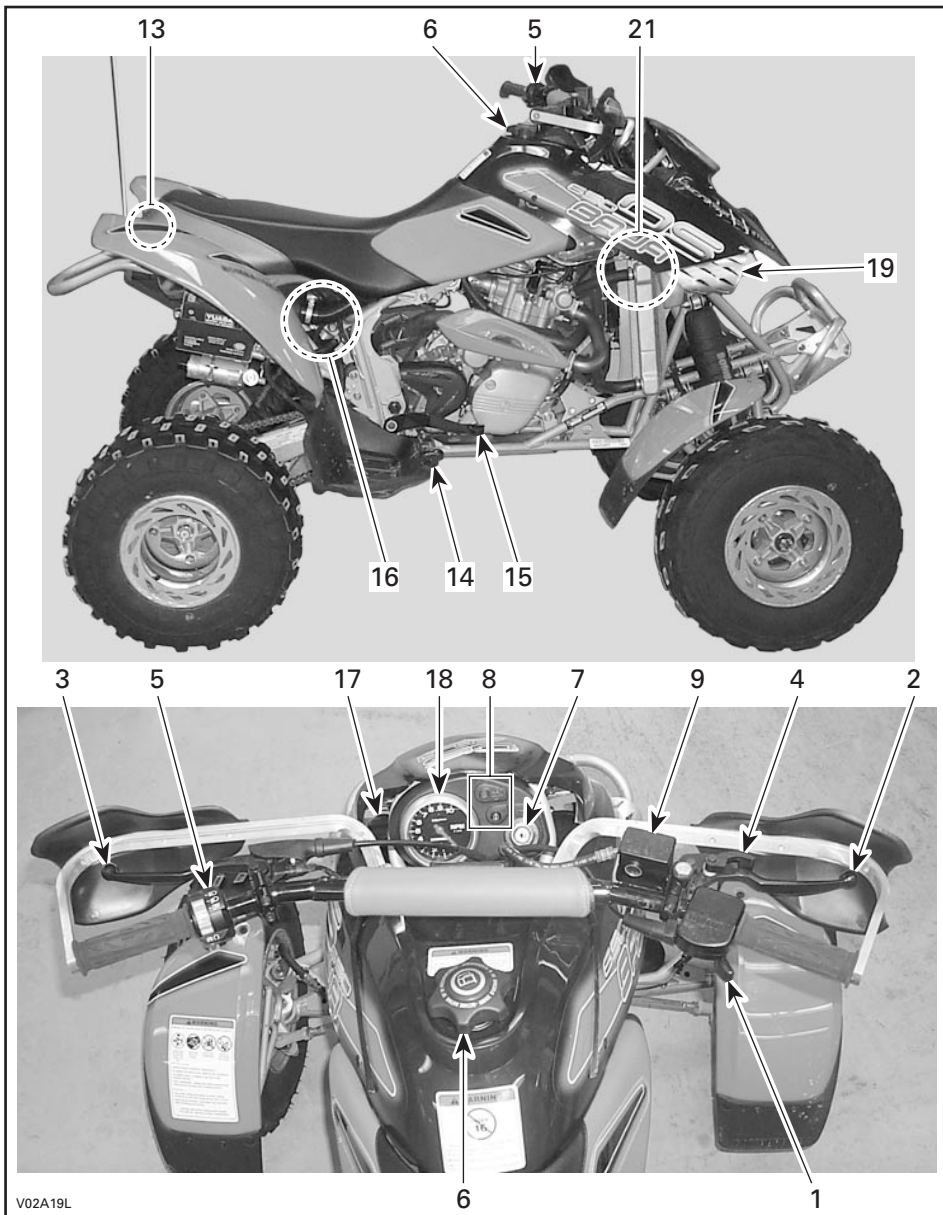

V02A19L

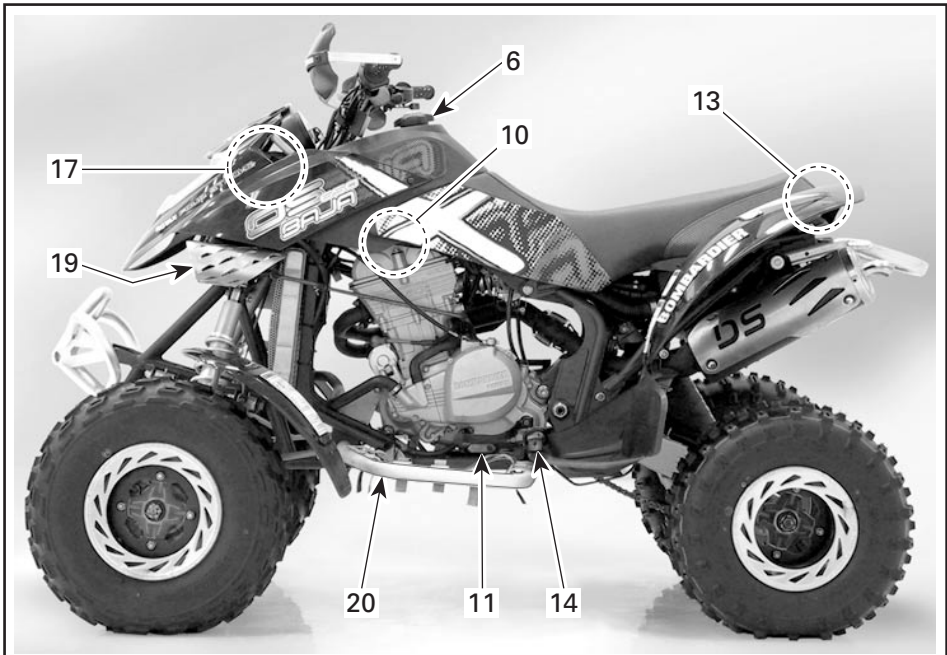

V02A1CL



While reading this Operator's Guide, remember that:

## **WARNING**

Indicates a potential hazard that, if not avoided, could result in serious injury or death.

## **WARNING**

This ATV may exceed the performance of other ATVs you may have ridden in the past. This category S (sport) is a high performance ATV for off road use only. It is for sport type recreational and competitive use by operators with advanced skills and substantial experience.

**NOTE:** This section gives basic functions of the various controls of your ATV. For more details of how to operate one control in conjunction with some others, refer to OPERATING INSTRUCTIONS further in this section.

### **1) Throttle Lever**

Located on the right side of handlebar. When pushed, it increases the engine speed that allows the engagement of the transmission on the selected gear.

When released, the engine speed should return automatically to idle and the vehicle will gradually slow down.

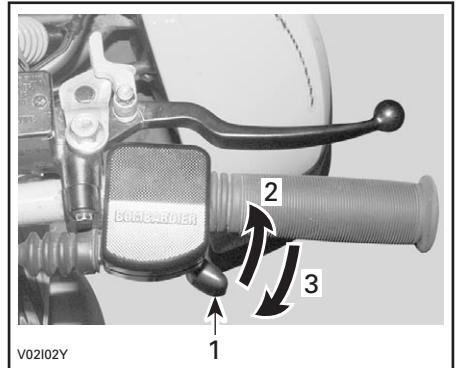

1. Throttle lever
2. To accelerate
3. To decelerate

## **WARNING**

Always release the throttle when shifting gears. Shifting gears without releasing the throttle, could cause loss of control including the ATV to overturn and mechanical damages.

### **2) Front Brake Lever**

Located on the right side of handlebar. When compressed, the brake is applied. When released, it should automatically return to its original position. Braking effect is proportional to the force applied on the lever and to the type and condition of the terrain.

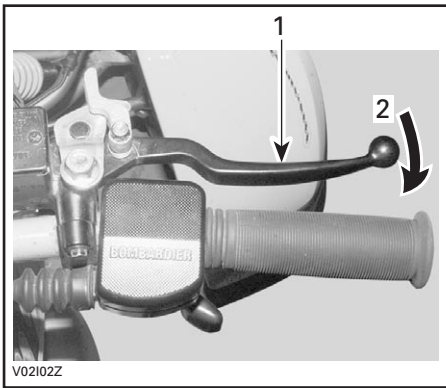

1. Brake lever
2. To apply brake

### 3) Clutch Lever

Located on the left side of handlebar. When compressed, the clutch is disengaged. When released, the clutch is engaged.

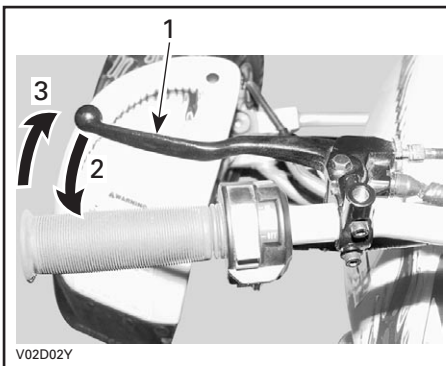

1. Clutch lever
2. To disengage
3. To engage

### WARNING

Always release the throttle when shifting gears. Shifting gears without releasing the throttle, could cause loss of control including the ATV to overturn and mechanical damages.

### 4) Parking Lever Lock

Located on right side of handlebar on the front brake lever. When applied, it temporarily prevents the vehicle from moving. Useful when the brake needs to be locked for example such as doing a K-turn, during transportation or when the vehicle is not in operation.

### WARNING

Always use the brake lever lock when the vehicle is not in operation.

### WARNING

Make sure brake lever lock is fully disengaged before operating the ATV.

When you ride the vehicle, brakes that are caused to drag by a continuous pressure on the lever may cause damage to the brake system and cause loss of braking capacity and/or fire.

**To engage mechanism:** Squeeze front brake lever and maintain while moving lever lock with a finger. Front brake lever is now compressed and applying front brake.

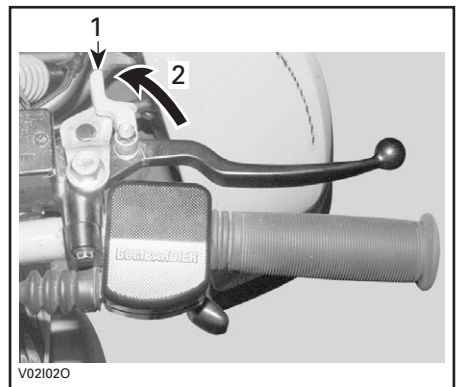

1. Parking lever lock
2. Press to apply parking brake

**To release mechanism:** Squeeze front brake lever. Lever lock should automatically return to its original position. Front brake lever should return to rest position.

## 5) Multi-Function Switch

The multi-function switch is located on the left side of handlebar.

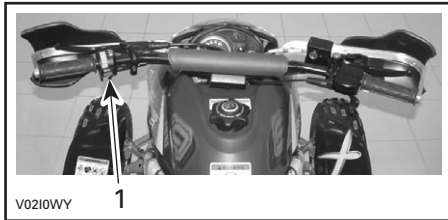

1. Multi-functions switch

### Headlamp Switch

Located on the top of multi-function switch. Place switch to LO for the low beam and taillight. Place switch to HI for the high beam and taillight. To close headlamp, move the headlamp switch to OFF position.

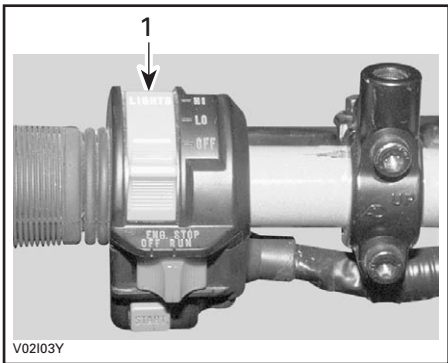

1. Headlamp switch

### Engine Stop Switch

Located at the middle of multi-function switch. The engine will not run or start if the engine stop switch is turned to OFF position.

This switch is used to stop engine and as an emergency control.

**NOTE:** While engine can be stopped by turning ignition key OFF, we recommend the engine be stopped by the engine stop switch.

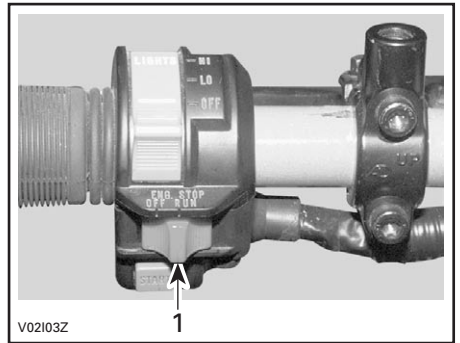

1. Engine stop switch

### Start Button

Located under engine stop switch. To start engine:

- Place the engine stop switch to RUN.
- Select transmission to the NEUTRAL position or squeeze the clutch lever.
- Turn ignition key to ON.
- Press and hold the start button.

Release immediately after engine is started.

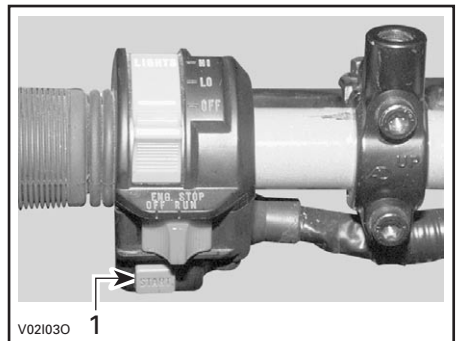

1. Start button

## 6) Fuel Tank Cap

Unscrew counterclockwise and remove cap to allow fuel tank filling then fully tighten clockwise.

### **WARNING**

Always stop engine before refueling. Open cap slowly. If a differential pressure condition is noticed (whistling sound heard when loosening fuel tank cap) have vehicle inspected and/or repaired before further operation. Fuel is flammable and explosive under certain conditions. Never use an open flame to check fuel level. Never smoke or allow flame or spark in vicinity. Always work in a well-ventilated area. Never top up the fuel tank before placing the vehicle in a warm area. As temperature increases, fuel expands and may overflow. Always wipe off any fuel spillage from the vehicle.

## 7) Ignition Switch

Located on the right side of the control panel.

Key-operated, 2 position switch: OFF, and ON without lights.

Insert key in switch and turn to the desired position. To remove key, turn key to OFF then pull it out.

**NOTE:** While engine can be stopped by turning ignition key OFF, we recommend the engine be stopped by pushing the engine stop switch.

## 8) Indicator Lamps

The indicator lamps are located above ignition switch.

## Neutral Indicator Lamp (green)

When the transmission is in neutral, the neutral indicator lamp light comes ON.

## Engine Indicator Lamp (red)

When the engine oil pressure is too low or the engine temperature is too high, the engine indicator lamp comes ON.

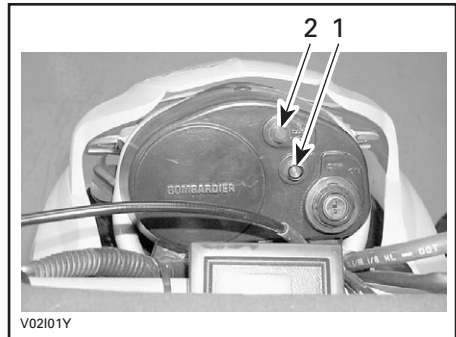

1. Neutral indicator lamp (green)
2. Engine indicator lamp (red)

In the event that the vehicle is flipped over or stays tilted on the side, be sure to check RED engine indicator lamp after restarting engine. If lamp stays ON, stop engine and refer to SPECIAL PROCEDURES section.

**CAUTION:** Failure to stop the engine immediately after RED engine indicator lamp comes ON will adversely affect the service life of the engine.

## 9) Front Brake Fluid Reservoir

Located above front brake lever.

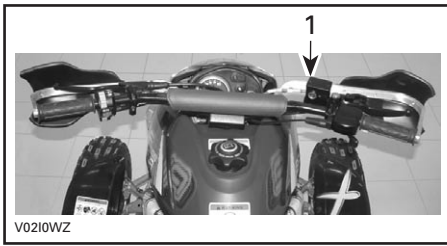

1. Front brake fluid reservoir

## 10) Fuel Valve

Located on right side under fuel tank. It is a 3-position rotary valve: OFF, ON, RES. Rotate the knob to align its pointer with ON, OFF or RES.

### OFF

Stops fuel supply to carburetor.

**CAUTION:** Turn valve to OFF position when ATV is not being operated or when transporting.

### ON

Allows fuel to flow to carburetor. This is the normal position for operation of the vehicle.

### RES (reserve)

When fuel is exhausted in the fuel tank when in the ON position, an emergency supply of fuel is available by turning the knob to RES. The reserve contains approximately 20% of the fuel tank capacity. Use only this position when the ON supply is empty.

When down to the reserve, refuel as soon as possible. Ensure to turn the valve back to the ON position after refuelling.

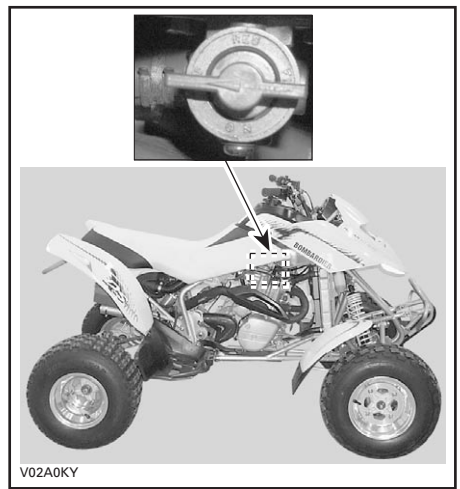

**CAUTION:** Improper opening of fuel valve will restrict the flow of fuel. Make sure valve is fully open while running.

## 11) Gearshift Pedal

Located in front of left footpeg.

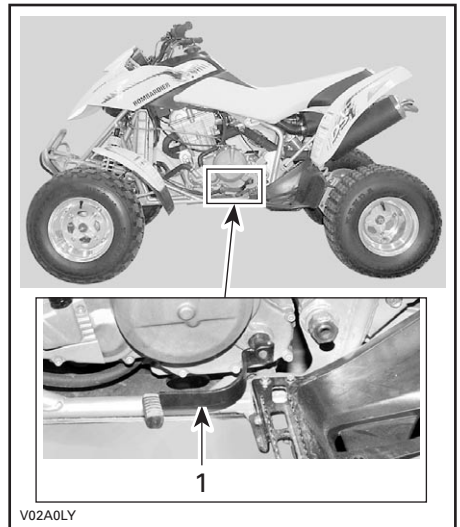

1. Gearshift pedal

## 12) Tool Box

The tool box is located in the service compartment, near the air box.

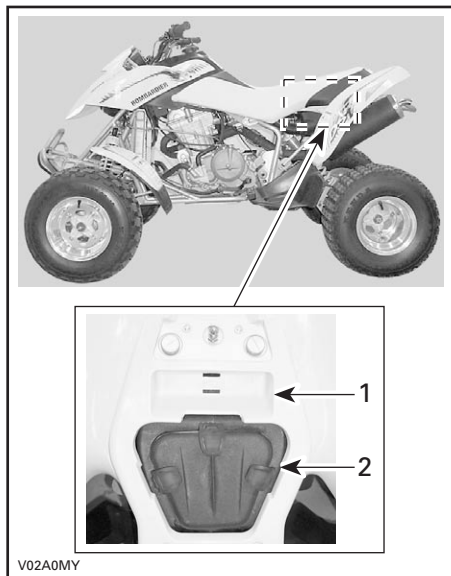

1. Storage compartment
2. Air box

The tool box contains tools for basic maintenance and this *Operator's Guide*.

The tools included in the tool box are:

- pliers (1)
- screwdriver (1)
- open wrench 10/13 mm (1)
- open wrench 15/17 mm (1)
- socket wrench 10/13 mm (1)
- socket wrench 16/18 mm (1)
- tire pressure gauge (1)
- Allen key 3 mm (1)
- Allen key 5 mm (1)
- offset screwdriver for rear shock absorber (1)
- drive chain adjuster lock (1)
- fuse 25 A (1)
- fuse 15 A (1).

## 13) Seat Latch

Located underneath rear end of seat. It allows the removal of seat to give access to air box and storage compartment.

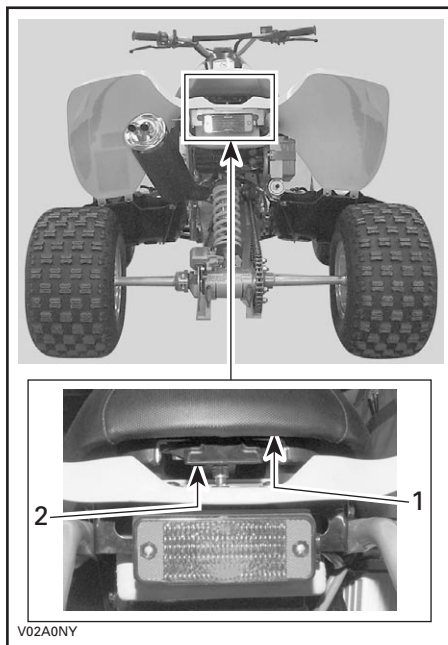

1. Seat
2. Seat latch

### Seat Removal

Pull latch upward while gently lifting rear of seat. Continue lifting movement until you can release the front retaining devices then completely remove seat.

### Seat Installation

Insert seat front tab into body hook. Pull latch lever to insert it over the rear lock pin. Release latch lever then firmly push on rear of the seat to relatch.



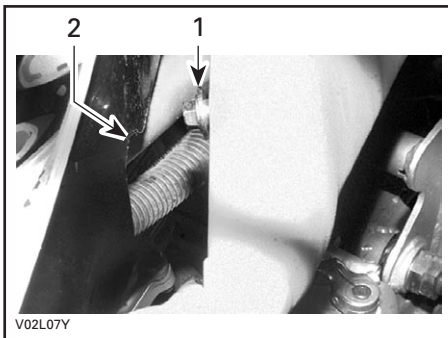

1. Seat tab
2. Body hook

### **⚠ WARNING**

Periodically verify the seat lock pin and tighten if needed. Make sure seat is securely latched before riding.

## **14) Footpeg**

Located on both sides of the vehicle.

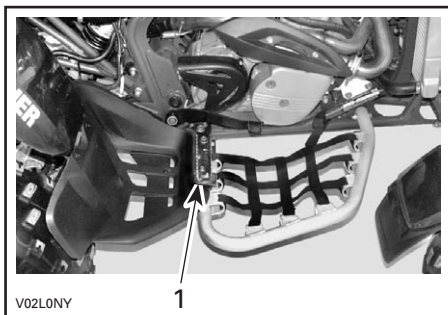

1. Footpeg

## **15) Foot Brake Pedal**

Located in front of right footpeg. When pressed down, the rear brake is applied. When released, it should return to its original position.

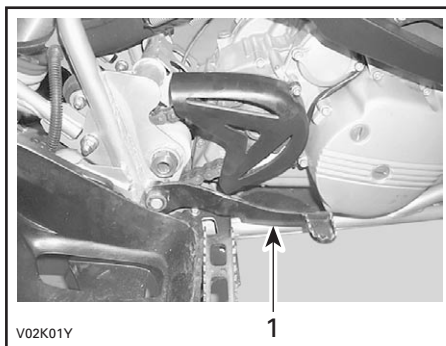

1. Foot brake pedal

**NOTE:** Braking effect is proportional to the force applied on the lever and to the type and condition of the terrain.

## **16) Rear Brake Fluid Reservoir**

Located near the right rear fender.

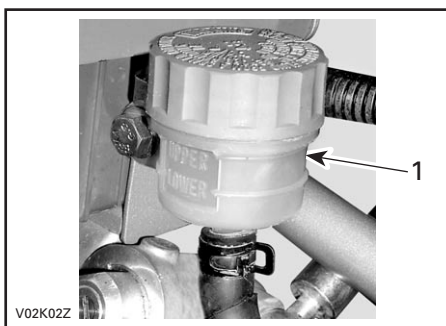

1. Rear brake fluid reservoir

## **17) Engine/Transmission Oil Tank Cap**

Located on LH of control panel.

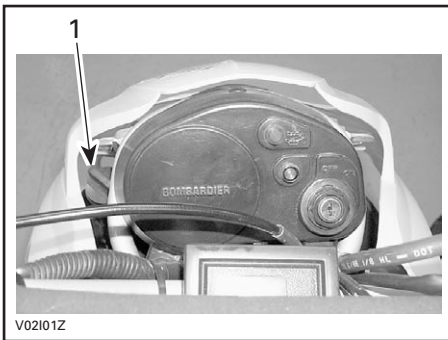

1. Engine/transmission oil tank cap

**⚠ WARNING**

The oil tank can be hot. Do not touch with your hands.

## 18) Tachometer

The tachometer is located on the left side of the control panel.



The tachometer indicates the revolution per minute (RPM) of the engine. Multiply by 1000 to obtain an approximation of the actual RPM.

## 19) Auxiliary Headlamps

Locate on each side of front of vehicle, under front fascia.

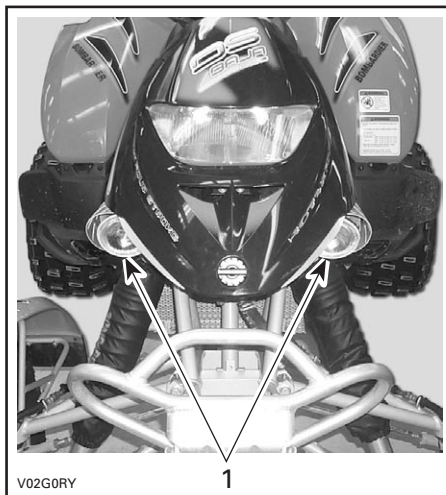

1. Auxiliary headlamps

## 20) Nerf Bar

Located on each side of vehicle, in front of footpegs.

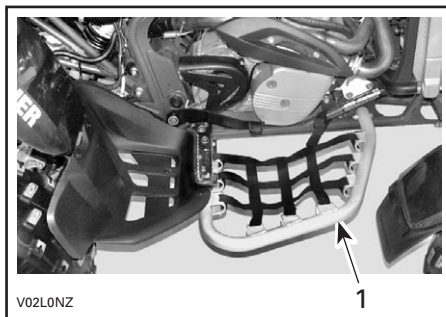

1. Nerf bar

## 21) Radiator Cap

The radiator cap is located under front fascia, on the top of radiator.

**⚠ WARNING**

In order to avoid potential burns, do not remove the radiator cap if the engine is hot.



To remove the radiator cap, press and turn it counterclockwise. Reverse the removal procedure to install.

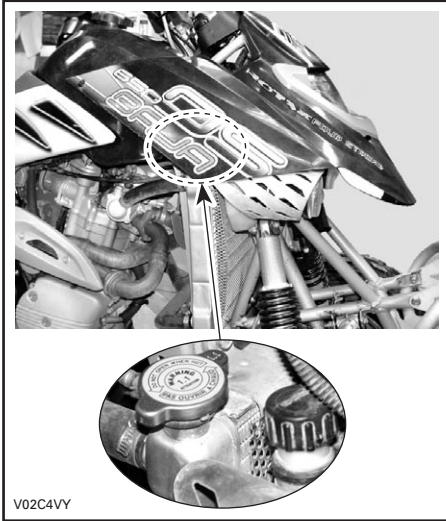

# LIQUIDS

While reading this Operator's Guide, remember that:

## **WARNING**

Indicates a potential hazard that, if not avoided, could result in serious injury or death.

**NOTE:** This section specifies the recommended liquids and procedures to check their levels. Refer to MAINTENANCE for procedures to replace the liquids.

## Fuel

### Recommended Fuel

Use premium unleaded gasoline, available from most service stations or oxygenated fuel containing a maximum total of 10% of ethanol or methanol or both. The gasoline used must have the following recommended minimum octane number.

OCTANE NUMBER	
Inside North America	(91 (R + M)/2)
Outside North America	95 RON

**CAUTION:** Never experiment with other fuels. The use of unrecommended fuel can result in vehicle performance deterioration and damage to critical parts in the fuel system and engine components.

**CAUTION:** Never mix oil with fuel. This ATV has a 4-stroke engine. Oil must be added to oil tank only.

## Fuel Level

### **WARNING**

Always stop engine before refueling. Open cap slowly. If a differential pressure condition is noticed (whistling sound heard when loosening fuel tank cap) have vehicle inspected and/or repaired before further operation. Fuel is flammable and explosive under certain conditions. Never use an open flame to check fuel level. Never smoke or allow flame or spark in vicinity. Always work in a well-ventilated area. Never top up the fuel tank before placing the vehicle in a warm area. As temperature increases, fuel expands and may overflow. Always wipe off any fuel or oil spillage from the vehicle.

## Engine/Transmission Oil

### Recommended Oil

Use 4-stroke mineral-based engine oil that meets or exceeds the requirements for API service classification SG, SH or SJ. Always check the API service label on the oil container to be sure it includes the letters SG, SH or SJ. Only use high-quality high-detergent oil.

**NOTE:** The same oil lubricates both engine and transmission. For improved overall performance and wear protection use XP-S 5W40 synthetic 4-stroke oil (P/N 293 600 039). This is a special synthetic oil formulated for clutch type gear box.

**CAUTION:** Use of synthetic or synthetic blend oil, other than XP-S 5W40 synthetic 4-stroke oil (P/N 293 600 039), may cause clutch slippage.

### Oil Viscosity

SAE 10W40 is recommended for summer time and SAE 5W30 for winter time.

Other viscosity should be used if the average temperature is outside the range of the recommended oil. See chart below.

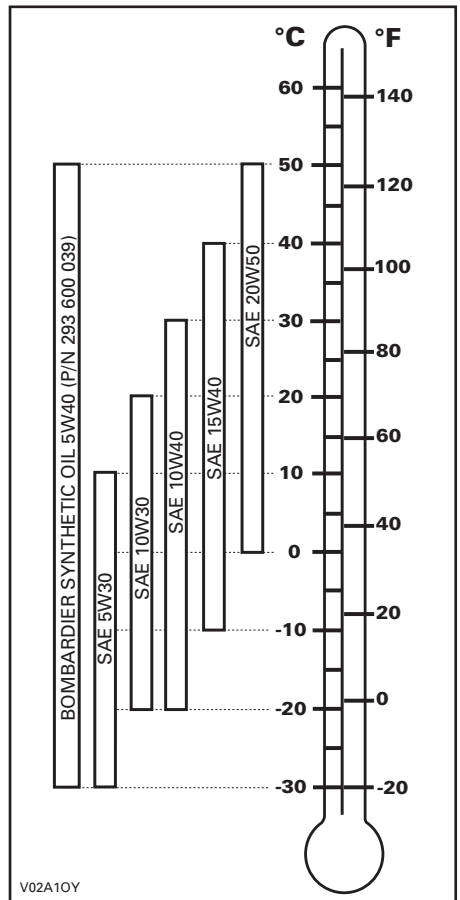

### Oil Level

**CAUTION:** Check level frequently and refill if necessary. Do not overfill. Operating the engine/transmission with an improper level may severely damage engine/transmission. Wipe off any spillage.

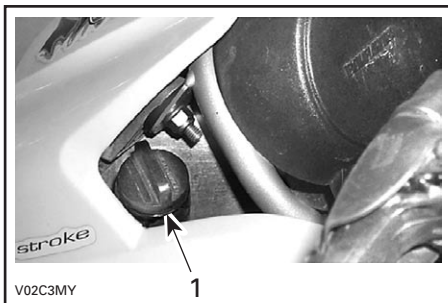

#### LH SIDE OF DASH

1. Dipstick

With vehicle on a level surface, start engine and let it running, around 1 minute, then stop engine. Check oil level as follows:

1. Unscrew dipstick out and wipe clean.
2. Screw dipstick until it bottoms.
3. Remove dipstick and check oil level. It should be near or equal to the upper mark.

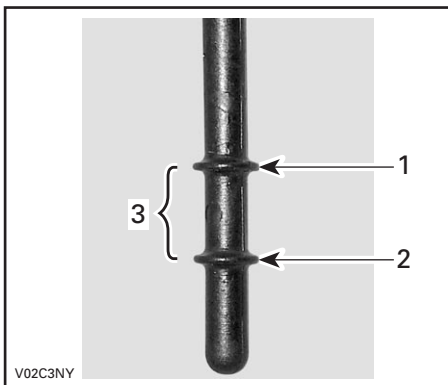

1. Full
2. Add
3. Operating range

To add oil, remove the dipstick. Place a funnel into the dipstick tube to avoid spillage.

Add a small amount of oil and recheck oil level.

Repeat the operation until oil level reaches the dipstick's upper mark. **Do not overfill.**

Properly tighten dipstick.

## Engine Coolant

### Recommended Coolant

Always use ethylene-glycol antifreeze containing corrosion inhibitors specifically for internal combustion aluminum engines.

Cooling system must be filled with Bombardier premixed coolant (P/N 219 700 362) or with distilled water and antifreeze solution (50% water, 50% antifreeze).

### Coolant Level



## WARNING

Check coolant level with engine cold. Never add coolant in cooling system when engine is hot.

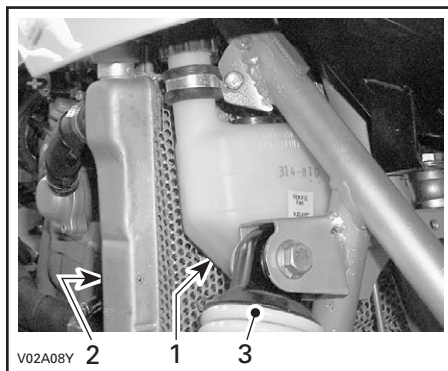

1. Coolant reservoir
2. Radiator
3. RH front shock

With vehicle on a level surface, liquid should be between MIN. and MAX. level marks of coolant reservoir.

**NOTE:** When checking level at temperature lower than 20°C (68°F), it may be slightly lower than MIN. mark.

Remove filler cap then add coolant up to MAX. mark if required. Use a funnel to avoid spillage. **Do not overfill.**

Properly reinstall and tighten filler cap.

If coolant is added in the coolant reservoir, check the level in the radiator too. Add coolant if necessary.

## **WARNING**

In order to avoid potential burns, do not remove the radiator cap if the engine is hot.

**NOTE:** A cooling system that frequently requires coolant is the indication of leaks or engine problems. See an authorized Bombardier ATV dealer.

## **Coolant Replacement**

Refer to MAINTENANCE section.

## **Brake Fluid**

### **Recommended Fluid**

Always use brake fluid meeting the specification DOT 4 only.

**CAUTION:** To avoid serious damage to the braking system, do not use fluids other than the recommended one, nor mix different fluids for topping up.

### **Fluid Level**

With vehicle on a level surface, check brake fluid in reservoirs for proper level. It should be above MIN. mark.

Clean and remove the filler cap then add fluid as required. **Do not overfill.**

**CAUTION:** Use only DOT 4 brake fluid from a sealed container. Do not use brake fluid taken from old or already opened containers.

**NOTE:** A low level may indicate leaks or worn brake pads. See an authorized Bombardier ATV dealer.

### **Front Brake Fluid Reservoir**

Turn steering in the straight-ahead position to ensure reservoir is level.

Check brake fluid level, the reservoir is full when fluid reaches of the top of window.

Visually inspect lever boot condition. Check for cracks, tears etc. Replace if damaged.

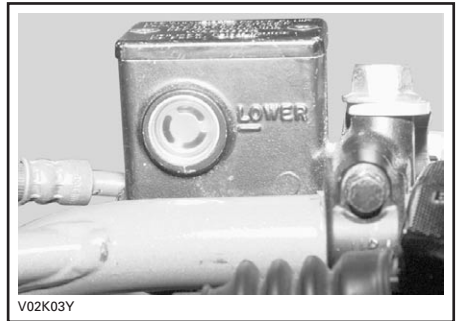

### **Rear Brake Fluid Reservoir**

With vehicle on a level surface, check brake fluid in reservoir for proper level. It should be above MIN. mark.



*RH SIDE OF VEHICLE*

## **Battery**

This vehicle is equipped with a dry type battery that requires no maintenance.

Refer to MAINTENANCE section to remove or install the battery.

---

# BREAK-IN PERIOD

## Engine

A break-in period of 10 operating hours is required before running the vehicle at sustained full throttle.

**CAUTION:** Never mix oil with fuel. This vehicle has a 4-stroke engine. Oil must be added to oil tank only.

During this period, maximum throttle should not exceed  $\frac{3}{4}$ . However, brief full acceleration and speed variations contribute to a good break-in. Continued wide open throttle accelerations, prolonged cruising speeds and engine overheating are detrimental during the break-in period.

## 10-Hour Inspection

**NOTE:** The 10-hour inspection is at the expense of the vehicle owner.

As with any precision piece of mechanical equipment, we suggest that after the first 10 hours or 30 days or 400 km (250 m.) after the purchase, whichever comes first, your vehicle be inspected by an authorized Bombardier ATV dealer. This inspection will give you the opportunity to discuss the unanswered questions you may have encountered during the first hours of operation.

While reading this Operator's Guide, remember that:

### **WARNING**

Indicates a potential hazard that, if not avoided, could result in serious injury or death.

# OPERATING INSTRUCTIONS

## General

This vehicle has five-forward gears.

To allow engine starting, the transmission must be on NEUTRAL or squeeze the clutch lever to start in any gear.

## Pre-Operation Check

### **WARNING**

The pre-operation check is very important prior to operating the vehicle. Always check the proper operation of critical controls, safety features and mechanical components before starting. If not done as specified here, severe injury or death might occur.

Before using this vehicle, the operator should always:

- Apply parking brake and check if it operates properly.
- Check tire pressure and condition.
- Check wheels and bearings for wear and damage.
- Check location of controls and ensure they work properly.
- Verify if steering operates freely.
- Activate throttle control lever several times to ensure it operates freely. It must return to idle position when released.
- Activate the brake levers and brake pedal to make sure the brakes fully apply. Levers and pedal must fully return when released.
- Check all brake line fittings for tightness and against leaks.
- Whit parking brake correctly applied, activate the clutch lever. It must fully return when released.
- Check drive chain for adjustment and lubrication.

- Check sprockets for wear and damages.
- Check tightening of rear axle fasteners.
- Check swing arm, if any lateral play is detected **DO NOT USE THE VEHICLE**.
- Check fuel, oil and coolant levels.
- Check for oil leaks on the engine, oil tank and transmission.
- Ensure fuel valve is in fully open position (ON).
- Clean headlamp and taillight.
- Ensure seat is properly latched.
- If you transport cargo, respect load capacity. Ensure cargo is properly secured to the vehicle.
- Look and feel for loose parts while engine is off. Check fasteners.
- Ensure the path of travel is free of persons and obstacles.
- Check operation of ignition switch, start button, engine stop switch and headlamps.
- Start engine, remove parking brake and drive forward slowly a few feet then apply all brakes individually to test them.

**Correct any problem you may have found before riding. See an authorized Bombardier ATV dealer as necessary.**

## Initial Cold Starting

Insert key in ignition switch and turn to ON.

Place the engine stop switch to run position.

In severe cold weather, colder than -20°C (-4°F), move the choke lever to full position.



Press start button and hold until engine starts.

Release start button immediately when engine has started.

### **WARNING**

**Do not apply throttle while starting.**

After a few seconds, move the lever to half position.

**NOTE:** Overusing choke may flood engine and make it hard to start. Refer to **SPECIAL PROCEDURES** if it occurs.

When the engine is warm, move the choke lever to OFF and release brakes.

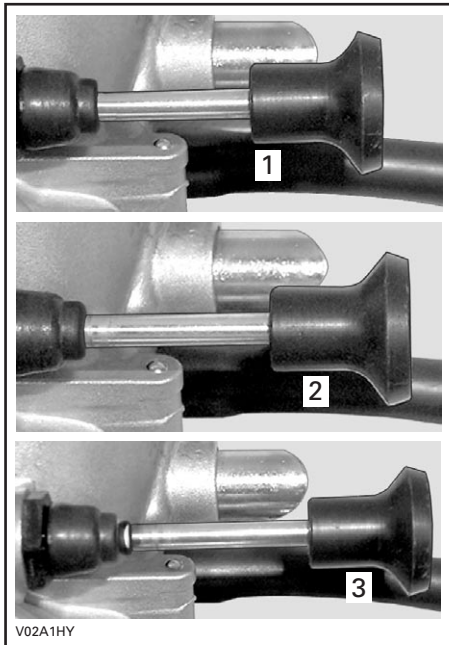

#### **UNDER SEAT, ON THE LH SIDE**

1. Off position
2. Half position
3. Full position

## **Warm Engine Starting**

Start the engine as explained above but without any choke. If the engine will not start after two 4-second attempts with the electric starter, move choke lever to half position. Start the engine without activating the throttle lever. After few times, move the choke lever to OFF.

## **Stopping the Engine**

### **WARNING**

**Avoid parking vehicle on slope.**

Release throttle and completely stop the vehicle.

Apply the parking brake by using brake lever lock on front brake lever.

Press the clutch lever and shift to 1<sup>st</sup> gear.

Push the engine stop switch.

Turn key in ignition switch to OFF.

Remove key from ignition switch.

## **Shifting the Transmission**

### **Gearshift Control**

To shift the transmission, pull in the clutch lever, then operate gearshift pedal as follows.

### **WARNING**

**Always use the clutch lever to up-shift or downshift.**

One full stroke of the pedal shifts the transmission to the next higher or lower gear in the shifting sequence. The pedal should automatically return to its original position.

To upshift to a higher gear, put the end of your boot under gearshift lever and lift up the pedal one full stroke. To downshift, lean the tip of the gearshift pedal and depress pedal one full stroke.

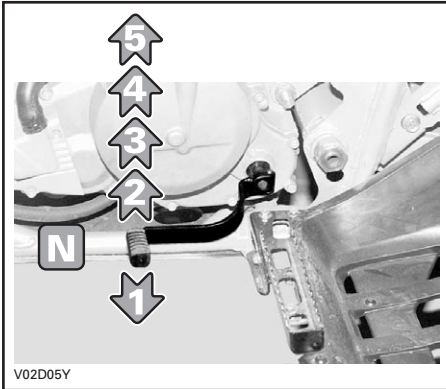

### **WARNING**

Always release the throttle when shifting gears. Shifting gears without releasing the throttle, could cause loss of control or cause the ATV to overturn.

**CAUTION:** Make sure parking brake is fully disengaged before operating the ATV.

# SPECIAL PROCEDURES

## Flooded Engine

When the engine does not start after several attempts, the engine may be fuel flooded. Proceed as follows.

Turn ignition switch to ON and ensure choke is not applied.

Ensure the transmission is in NEUTRAL or squeeze the clutch lever.

Fully press throttle lever and hold while starting the engine. Try several times.

As soon as the engine starts, release throttle lever. Do not race engine.

### If it does not work:

Disconnect spark plug cables.

Clean the spark plug area then remove spark plugs (tools are supplied in tool box).

### WARNING

Always wear eye protector and gloves when the spark plug hole is cleaned.

Crank engine several times. Install clean dry spark plugs or new spark plugs if possible.

Start engine as explained above. If engine continues to flood, see an authorized Bombardier ATV dealer.

## Engine Overheat

If engine overheats and engine indicator lamp (red) comes ON, try the following:

Check oil level in oil tank and refill if necessary.

Ensure radiator is not obstructed.

Check and clean radiator fins. See MAINTENANCE section.

### WARNING

The radiator can be very hot, wear gloves to touch the radiator.

Reduce vehicle speed but try to keep it moving to supply air to radiator. If engine is still overheating after approximately one minute, stop vehicle and set transmission to NEUTRAL. Apply parking brake and stop engine. Place the ignition switch to ON position (**do not restart engine yet**). The radiator fan will cool the radiator.

Let engine cool down before checking coolant level and refill if possible.

### WARNING

Never refill cooling system when engine is hot. Let engine cool down.

See an authorized Bombardier ATV dealer as soon as possible.

## Turn Over

When vehicle is turned over or stays tilted on the side, put the vehicle back on its wheels, then wait 3 to 5 minutes before starting the engine. Check RED engine indicator lamp after restarting the engine. If lamp stays ON after restarting the engine, stop it. Air bubbles present in the oil line must be evacuated. Proceed as follows.

On the LH side, remove the oil inlet hose on the engine.

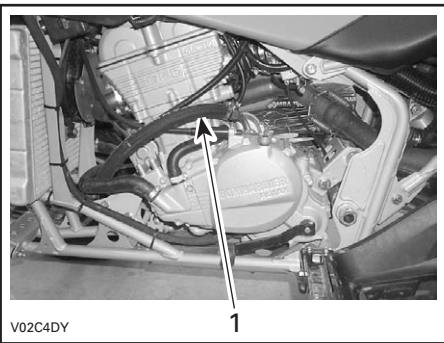

1. Oil inlet hose

### **WARNING**

The engine and the engine oil can be very hot. Wait until engine or engine oil has cooled off.

Lower oil inlet hose until a little quantity of oil flows without air bubbles.

Replace oil inlet hose and tighten clamp properly.

Check oil level in oil tank and refill if necessary.

Start engine. If RED engine indicator lamp stays ON, stop engine and see an authorized Bombardier ATV dealer as soon as possible.

## **ATV Immersion**

Should the ATV become immersed, it will be necessary to take it to an authorized Bombardier ATV dealer as soon as possible. **DO NOT START THE ENGINE!**

**CAUTION:** Immersion of the ATV can cause serious damage if the correct restart procedure is not followed.

## **Post-Operation Care**

When vehicle is used in salt-water environment (beach area, launching/loading boats, etc.), rinsing the vehicle with fresh water is necessary to preserve vehicle and its components. Metallic parts lubrication is highly recommended. Use BOMBARDIER LUBE (P/N 293 600 016) or an equivalent. This must be performed at the end of each operating day.

When vehicle is operated in muddy conditions, rinsing the vehicle is recommended to preserve vehicle and its components and to keep lights clean.

**NOTE:** Never use a high pressure washer to clean the vehicle **USE LOW PRESSURE ONLY** (like a garden hose). The high pressure can cause electrical or mechanical damages.

## **Storage and Preseason Preparation**

### **WARNING**

Have an authorized Bombardier ATV dealer inspect fuel system integrity as specified in MAINTENANCE CHART.

When a vehicle is not in use for more than one month, proper storage is a necessity.

See an authorized Bombardier ATV dealer for proper procedures.

When using your ATV after storage, a preparation is required. See an authorized Bombardier ATV dealer for proper procedures.

# CARGO AND TRANSPORTATION

While reading this Operator's Guide, remember that:

## WARNING

Indicates a potential hazard that, if not avoided, could result in serious injury or death.

## Cargo

### WARNING

This vehicle is not designed or manufactured to carry cargo or tow a trailer. If you decide to add accessories to allow you to carry cargo or tow a trailer, use common sense.

## Transportation

When transporting a vehicle, secure vehicle to trailer or pickup box with suitable tie-downs. Using ordinary ropes is not recommended.

### WARNING



V00A174

Never tip this vehicle on end for transporting. We recommend that you carry the vehicle in its normal operating position (on all 4 wheels).

Follow these procedures:

- Place the fuel valve to OFF position.
- Apply the parking break and place the transmission in 1<sup>st</sup> gear.

- Secure the vehicle, using the appropriate areas. See the following illustration.

**CAUTION:** Attaching vehicle at other locations may damage the vehicle.

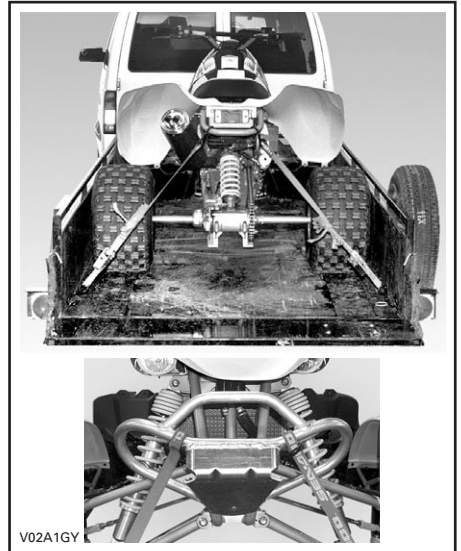

V02A1GY

### WARNING

Do not tow this vehicle behind a car or other vehicle. Use a trailer.

---

# TROUBLESHOOTING

---

## ENGINE DOES NOT TURN

---

- 1. Ignition switch is in the OFF position.**
  - Place switch to the ON position.
- 2. Transmission is not set on NEUTRAL.**
  - Set transmission either in NEUTRAL or squeeze the clutch lever.
- 3. Weak battery or loose connections.**
  - Check connections and terminals condition.
  - Have the battery checked.
  - Contact an authorized Bombardier ATV dealer.

---

## ENGINE TURNS OVER BUT FAILS TO START

---

- 1. Mixture not rich enough to start cold engine.**
  - Check fuel tank level and check starting procedure, particularly use of the choke.
- 2. Flooded engine (spark plugs wet when removed).**
  - Refer to SPECIAL PROCEDURES.
- 3. No fuel to the engine (spark plugs dry when removed).**
  - Check fuel tank level; turn fuel valve to ON (also try on RES). A failure of the carburetor may have occurred.
  - Contact an authorized Bombardier ATV dealer.
- 4. Spark plug/ignition (no spark).**
  - Check ignition fuse condition.
  - Remove spark plugs then reconnect to spark plug caps.
  - Check that ignition switch and/or engine stop switch is/are at the ON position.
  - Start engine with spark plugs grounded to the engine away from spark plug holes. If no spark appears, replace spark plugs.
  - If trouble persists, contact an authorized Bombardier ATV dealer.
- 5. Engine compression.**
  - If no pulsating resistance is felt, it suggests a major loss of compression.
  - Contact an authorized Bombardier ATV dealer.

---

## ENGINE LACKS ACCELERATION OR POWER

---

- 1. Fouled or damaged spark plugs.**
  - Check item ENGINE TURNS OVER BUT FAILS TO START.
- 2. Lack of fuel to engine.**
  - Check item ENGINE TURNS OVER BUT FAILS TO START.
- 3. Carburetor adjustments.**
  - Contact an authorized Bombardier ATV dealer.

## **ENGINE LACKS ACCELERATION OR POWER (cont'd)**

---

### **4. Engine is overheating.**

- Check *ENGINE OVERHEATING* in *SPECIAL PROCEDURES*.
- If overheating persists, contact an authorized *Bombardier ATV dealer*.

### **5. Air filter/box plugged or dirty.**

- Check air filter and clean if necessary.
- Check liquid/deposits in air box drain tube.
- Check the position of the air intake tube.

## **ENGINE BACKFIRE**

---

### **1. Faulty spark plugs (carbon accumulation).**

- See *ENGINE LACKS ACCELERATION OR POWER*.

### **2. Exhaust system leakage.**

- Contact an authorized *Bombardier ATV dealer*.

### **3. Engine is running too hot.**

- See *ENGINE LACKS ACCELERATION OR POWER*.

### **4. Ignition timing is incorrect or there is an ignition system failure.**

- Contact an authorized *Bombardier ATV dealer*.

### **5. Improper carburetor setting.**

- Contact an authorized *Bombardier ATV dealer*.

## **ENGINE MISFIRE**

---

### **1. Fouled/damaged/worn spark plugs.**

- Clean/verify spark plugs and heat range. Replace as required.

### **2. Water in fuel.**

- Drain fuel system and refill with fresh fuel.

## **UNUSUAL ENGINE NOISE**

---

### **1. Valve adjustment.**

- Contact an authorized *Bombardier ATV dealer*.

### **2. Chain tensioner plugged.**

- Contact an authorized *Bombardier ATV dealer*.

### **3. Timing chain wear.**

- Contact an authorized *Bombardier ATV dealer*.

## **VEHICLE CANNOT REACH FULL SPEED**

---

### **1. Engine.**

- See *ENGINE LACKS ACCELERATION OR POWER*.

### **2. Parking brake.**

- Ensure brake lever lock is completely removed.

## **VEHICLE CANNOT REACH FULL SPEED (cont'd)**

---

### **3. Air filter/box plugged or dirty.**

- *Check air filter and clean if necessary.*
- *Check liquid/deposits in air box drain tube.*
- *Check the position of the air intake tube.*

## **TRANSMISSION DOES NOT SHIFT SMOOTHLY**

---

### **1. Engine/transmission oil level is low.**

- *Refill oil tank with recommended oil at the proper level..*

### **2. Transmission shifting system.**

- *Try depressing the throttle lever more while shifting.*

### **3. Improper oil type.**

- *Drain oil in engine and use recommended oil only.*

### **4. Transmission.**

- *See an authorized Bombardier ATV dealer.*

## **RED ENGINE INDICATOR LAMP STAYS ON**

---

### **1. Engine/transmission oil pressure is low.**

- *Check oil level and refill oil tank with recommended oil at the proper level.*
- *See an authorized Bombardier ATV dealer.*

### **2. Vehicle is turned over or stays tilted on the side.**

- *Bleed oil system. Check TURN OVER section in SPECIAL PROCEDURES.*

### **3. Engine is overheating.**

- *Check ENGINE OVERHEAT section in SPECIAL PROCEDURES.*
- *Contact an authorized Bombardier ATV dealer.*



# SPECIFICATIONS

<b>MODEL</b>		<b>DS650™ X</b>
<b>ENGINE</b>		
Type	BRP – Rotax, 4 stroke. Double overhead camshaft engine, bush chain drive	
Number of cylinder	Single cylinder	
Number of valves	4 bucket tappet-operated valves	
Displacement	653 cc (39.8 cu. in)	
Bore	Standard	100 mm (3.9 in)
Stroke	83 mm (3.3 in)	
Compression ratio	9.7:1	
Lubrication	Dry sump lubrication by oil pump with replaceable oil filter (lubrication of engine and transmission simultaneously)	
Decompressor	Automatic	
Exhaust system	BRP, stainless header pipe painted steel muffler	
Air filter	2 stage foam filter	
<b>TRANSMISSION</b>		
Clutch	1 multi-disc	
Transmission	Integrated 5 speeds constant mesh transmission	
<b>COOLING</b>		
Type	Liquid cooled with integrated water pump	
Radiator	Front mounted with thermostatic fan	
<b>CARBURETION</b>		
Carburetor	Make	Mikuni
	Type	BSR 42 constant depression type
Choke	Manual choke	
Idle speed	± 100	1300 RPM

MODEL		DS650™ X
<b>ELECTRICAL</b>		
Magneto generator	Make	Denso
	Type	290 W @ 6000 RPM
Ignition type		Breakerless high voltage condenser ignition system with electronic spark advance
Ignition timing		Not adjustable
Engine RPM limiter		7900 RPM (any gear in forward)
Spark plug	Make	NGK
	Type	DR 8 EA
	Gap	0.6 to 0.7 mm (.024 to .027 in)
Number of spark plug		2
Battery	Type	Dry type battery.
	Volt	12 volts, 13 Ah
Instrument		Tachometer
Starting system		Electric start. Start in any gear (with clutch applied or on NEUTRAL)
Headlamp bulb		2 x 30 W
Taillight and brake light bulb		8/27 W, 1157
Auxiliary headlight		2 x 35 W, H3
Fuses	Fan	15 A
	Auxiliary headlight	15 A
	Charging system	25 A
<b>DRIVE TRAIN</b>		
Rear axle		Chain driven/solid axle
Turning radius		3.16 m (10 ft)
<b>SUSPENSION</b>		
Front	Type	Independent suspension — single A-arm, 2 shock absorbers (oil/gas)
	Travel	305 mm (12 in)
Rear	Type	Rigid swing-arm 1 shock absorber (oil/gas)
	Travel	279 mm (11 in)

MODEL		DS650™ X
<b>TIRES</b>		
Pressure	Front	35 kPa (5 PSI) recommended
	Rear	35 kPa (5 PSI) recommended
Size	Front	22 x 7 – 10
	Rear	20 x 10 – 9
<b>WHEELS</b>		
Size	Front	10 x 5.5 with reinforced ring
	Rear	9 x 8.5 with reinforced ring
Wheel nuts torque		53 N•m (39 lbf•ft)
<b>BRAKES</b>		
Front		Nissin hydraulic, 2 discs (Stainless)
Rear		Nissin hydraulic, 1 disc (Stainless)
Parking device		RH brake lever includes a lock on front wheels
<b>STEERING</b>		
Toe-out (vehicle on ground and measure on the rim)		0.5 mm ± 0.5 mm (.0197 in ± .0197 in) each side
<b>LOADING CAPACITY</b>		
Total vehicle load allowed		125 kg (220 lb) includes operator, all other loads and added accessories
GVWR (Gross Vehicle Weight Rating)		333 kg (733 lb)
Weight distribution (front/rear)		50/50%
<b>DIMENSIONS</b>		
Dry mass		225 kg (495 lb)
Overall length		1.97 m (77.5 in)
Overall width		1.23 m (48 in)
Overall height		1.21 m (47 in)
Wheel base		1.24 m (49 in)
Wheel track	Front	1.05 m (41 in)
	Rear	978 mm (38.5 in)
Ground clearance		297 mm (11.7 in)

MODEL		DS650™ X	
LIQUIDS			
Oil type (engine and transmission)		SAE 10W40 4–stroke mineral-based. API classification SG, SH or SJ or XP-S 5W40 synthetic 4-stroke oil <b>Do not use other synthetic oil, synthetic blend oil or special additive.</b> Refer to OIL VISCOSITY CHART for other grade	
Coolant		Ethylene-glycol/water mix (50% coolant, 50% distilled water). Use Bombardier premixed coolant or a coolant specially designed for aluminum engines.	
Fuel	Type	Super unleaded gasoline	
	Octane	Inside North America: 91 (R + M)/2 Outside North America: 95 RON	
Hydraulic brake		Brake fluid, DOT 4	
CAPACITIES			
Vehicle range		Approximately 3 hours depending on many factors such as temperature and operating conditions.	
Fuel tank		12 L (3.2 U.S. gal) including an approximate reserve of 2.4 L (0.6 U.S. gal).	
Engine/transmission oil		3.1 L (3.3 U.S. quarts)	
Coolant		1.75 L (1.9 U.S. quarts)	

A: ampere

kW: kilowatt

Ah: ampere hour

RPM: revolution per minute

cc: cubic centimeters

V: volt

cu. in.: cubic inches

W: watt

hp: horsepower

Because of our ongoing commitment to product quality and innovation, BRP reserves the right, at any time, to make changes in design and specifications and/or to make additions to, or improvements in its products without imposing any obligation upon itself to install them on its products previously manufactured.

# ***MAINTENANCE INFORMATION***

# MAINTENANCE CHART

The maintenance is very important, if you are not familiar with safe service practices and adjustment procedures, see your authorized Bombardier ATV dealer.

## PERIODIC MAINTENANCE CHART

<b>A: ADJUST</b> <b>C: CLEAN</b> <b>I: INSPECT</b> <b>L: LUBRICATE</b> <b>R: REPLACE</b> <b>T: PROCEED WITH TASK</b>	INITIAL INSPECTION 10 H OR 30 DAYS OR 400 KM (250 m.) (To be performed by an authorized BRP ATV dealer. The initial maintenance is very important and must not be neglected.)	
	25 H OR 1250 KM (800 m.)	
	50 H OR 2500 KM (1600 m.)	
	100 H OR 1 YEAR OR 5000 KM (3100 m.)	
	200 H OR 2 YEARS OR 10000 KM (6200 m.)	
TO BE PERFORMED BY		
<b>PART/TASK</b>	<b>LEGEND</b>	

### ENGINE/TRANSMISSION

Engine/transmission oil level <sup>(3)</sup>	EVERY RIDE				Customer
Engine/transmission oil and filter	R		R		Customer
Oil reservoir strainer				C	Customer
Valve clearance	T		T		Dealer
Engine mounting fasteners <sup>(3)</sup>	I		I		Dealer
Exhaust system	I		I		Dealer
Spark arrester			C		Customer
Coolant <sup>(2)</sup>	T	T		R	Customer
Radiator cap/cooling system pressure test	I			I	Dealer
Radiator condition/cleanliness (radiator fins) <sup>(4)</sup>	I	I			Customer
Clutch and transmission operation <sup>(3)</sup>			I		Dealer
Clutch lever <sup>(3)</sup>	I	I			Dealer

(2) Every 50 hours, check coolant strength.  
 (3) Pre-ride inspection item.  
 (4) More often under severe use such dusty area, sand, snow, wet or muddy conditions.

### FUEL

Air filter <sup>(4)</sup>		C	R		Customer
Fuel lines and connections	I		I		Dealer
Fuel tank strainers				R	Dealer
Carburetor	A		A		Dealer

(4) More often under severe use such dusty area, sand, snow, wet or muddy conditions.

## PERIODIC MAINTENANCE CHART

A: ADJUST  
 C: CLEAN  
 I: INSPECT  
 L: LUBRICATE  
 R: REPLACE  
 T: PROCEED WITH TASK

INITIAL INSPECTION 10 H OR 30 DAYS OR 400 KM (250 m.)

(To be performed by an authorized BRP ATV dealer. The initial maintenance is very important and must not be neglected.)

25 H OR 1250 KM (800 m.)

50 H OR 2500 KM (1600 m.)

100 H OR 1 YEAR OR 5000 KM (3100 m.)

200 H OR 2 YEARS OR 10000 KM (6200 m.)

TO BE PERFORMED BY

**PART/TASK**

**LEGEND**

### ELECTRICAL

Spark plug <sup>(5)</sup>	T			R		Dealer	(3) Pre-ride inspection item. (5) Make sure the spark plug is correctly gapped.
Battery connections	I			I		Dealer	
Wiring harnesses, cables and lines	I			I		Dealer	
Condition of ignition switch, start button and engine stop switch <sup>(3)</sup>	I			I		Customer	
Condition of lighting system (HI/LO intensity, brake lamp, headlamp aiming, etc.) <sup>(3)</sup>	I			I		Customer	

### DRIVE TRAIN

Drive chain lubrication <sup>(3)</sup>	EVERY RIDE				Customer	(3) Pre-ride inspection item. (4) More often under severe use such dusty area, sand, snow, wet or muddy conditions.	
Drive chain adjustment <sup>(3)</sup>	EVERY RIDE				Customer		
Drive chain slider and roller condition <sup>(3)</sup>	EVERY RIDE				Customer		
Sprockets <sup>(4)</sup>	I			I			Customer
Wheel bearing condition <sup>(3)</sup>	I		I	L			Customer
Rear wheel hub					L		Customer
Rear axle tightness (eccentric axle housing bolts and adjustment nut)	I	I					Customer

## PERIODIC MAINTENANCE CHART

A: ADJUST  
 C: CLEAN  
 I: INSPECT  
 L: LUBRICATE  
 R: REPLACE  
 T: PROCEED WITH TASK

INITIAL INSPECTION 10 H OR 30 DAYS OR 400 KM (250 m.)  
 (To be performed by an authorized BRP ATV dealer. The initial maintenance is very important and must not be neglected.)

25 H OR 1250 KM (800 m.)

50 H OR 2500 KM (1600 m.)

100 H OR 1 YEAR OR 5000 KM (3100 m.)

200 H OR 2 YEARS OR 10000 KM (6200 m.)

TO BE PERFORMED BY

**PART/TASK**

**LEGEND**

### STEERING

Handlebar fasteners <sup>(3)</sup>	I			I		Dealer
Throttle/housing/cable <sup>(3)</sup>	I		I			Customer
Choke	I			I		Dealer
Steering system <sup>(3)</sup>	I			I <sup>(4)</sup>		Dealer
Tie rod ends	I		I			Customer
Wheel nuts/studs <sup>(3)</sup>	I		I			Customer
Tires pressure and wear <sup>(3)</sup>	EVERY RIDE					Customer
Front wheel hub	EVERY RIDE					Customer
Front wheels alignment	I			I		Dealer

<sup>(3)</sup> Pre-ride inspection item.  
<sup>(4)</sup> More often under severe use such dusty area, sand, snow, wet or muddy conditions.

### SUSPENSION

Swing arm inspection	I	I				Customer
Swing arm lubrication	EVERY RIDE					Customer
A-arms	I	I, L				Customer
Ball joint boot	I	I				Customer
Ball joint <sup>(4)</sup>	I	I				Dealer
Shock absorbers		I				Customer

<sup>(4)</sup> More often under severe use such dusty area, sand, snow, wet or muddy conditions.

### BRAKE

Brake fluid (front and rear) <sup>(3)</sup>	I	I			R <sup>(6)</sup>	Customer
Brake pads <sup>(6)</sup>		I				Customer
Brake system (discs, hoses, etc.) <sup>(3)</sup>				I		Customer
Brake line fittings <sup>(3)</sup>	I	EVERY RIDE				Customer

<sup>(3)</sup> Pre-ride inspection item.  
<sup>(6)</sup> Brake fluid replacement or any brake system repairs must be performed by an authorized BRP ATV dealer.



## PERIODIC MAINTENANCE CHART

A: ADJUST  
 C: CLEAN  
 I: INSPECT  
 L: LUBRICATE  
 R: REPLACE  
 T: PROCEED WITH TASK

INITIAL INSPECTION 10 H OR 30 DAYS OR 400 KM (250 m.)  
 (To be performed by an authorized BRP ATV dealer. The initial maintenance is very important and must not be neglected.)

25 H OR 1250 KM (800 m.)

50 H OR 2500 KM (1600 m.)

100 H OR 1 YEAR OR 5000 KM (3100 m.)

200 H OR 2 YEARS OR 10000 KM (6200 m.)

TO BE PERFORMED BY

**PART/TASK**

**LEGEND**

### BODY/FRAME

Engine area	C		C			Customer	(3) Pre-ride inspection item. (4) More often under severe use such dusty area, sand, snow, wet or muddy conditions.
Skid plates and A-arm protectors	EVERY RIDE					Customer	
Frame				I		Dealer	
Chassis Fasteners <sup>(3)</sup>			I			Customer	
Seat latch	EVERY RIDE					Customer	
Vehicle cleaning and protection			C <sup>(4)</sup>			Customer	

# GENERAL

While reading this Operator's Guide, remember that:

## **WARNING**

Indicates a potential hazard that, if not avoided, could result in serious injury or death.

## **WARNING**

Unless otherwise specified, engine should not be running for all maintenance procedures.

Before performing any service or inspection operation on the vehicle, wait until the engine and exhaust have cooled down to avoid potential burns.

## **WARNING**

Should removal of a locking device (e.g. lock tabs, self-locking fasteners, etc.) be required, when undergoing disassembly/assembly, always replace with a new one.

**NOTE:** The following covers the maintenance items that can be performed by the customer if desired. Other items found in MAINTENANCE CHART must be performed by an authorized Bombardier ATV dealer.

# ENGINE/TRANSMISSION

Among other things, this section gives the procedures to replace the liquids. Refer to LIQUIDS for procedures to check levels and refill.

## Oil Change and Oil Filter Replacement

Oil and filter are to be replaced at the same time. Oil change should be done with a warm engine.

### **WARNING**

The engine oil can be very hot.  
Wait until engine oil is warm.

Ensure vehicle is on a level surface.

Remove dipstick.

Clean the drain plug area.

Place a drain pan under the engine drain plug area.

Remove drain plug and drain all oil from oil tank. Wipe out any oil spillage on frame.

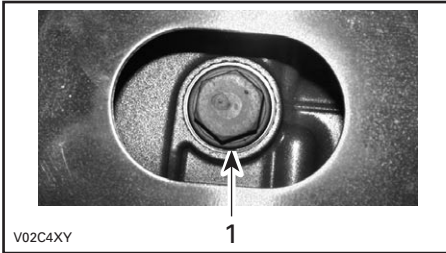

### **UNDER VEHICLE**

1. Oil drain plug

Allow enough time for oil to flow out of oil filter.

Unscrew oil filter cover.

Remove the oil filter and replace by a new filter.

**NOTE:** Check and change the O-ring, if necessary.

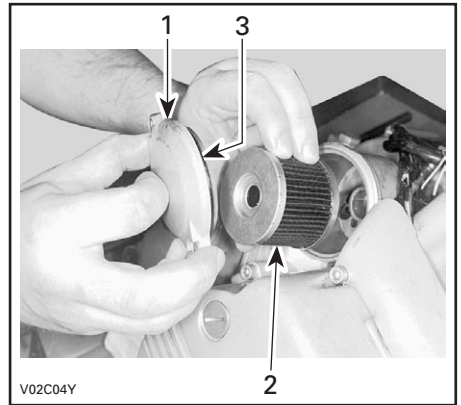

### **RH SIDE OF ENGINE**

1. Oil filter cover
2. Oil filter
3. O-ring

Wipe out any oil spillage on engine.

Change gasket on drain plugs. Clean gasket area on engine, oil tank and drain plugs then reinstall plugs.

Refill oil tank at the proper level with the recommended oil. Refer to SPECIFICATIONS for capacity.

Start engine and let idle for a few minutes.

Check if the RED indicator lamp stay ON, if so, stop engine and bleed system by removing oil filter and bleeding screw.

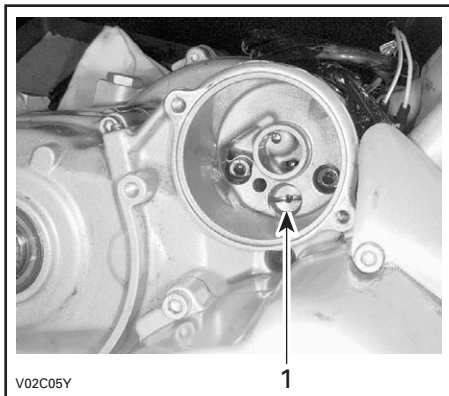

## BEHIND OIL FILTER

### 1. Bleeding screw

Reinstall all removed parts then start the engine. Check if the RED indicator lamp stays ON. If so, repeat the bleeding procedure. If the RED indicator lamp stays continually ON, stop the engine and see an authorized Bombardier ATV dealer.

Ensure oil filter area, hose and drain plug areas are not leaking.

Stop engine and check oil level. Refill as necessary.

Dispose oil as per your local environmental regulations.

## Coolant Replacement

### WARNING

In order to avoid potential burns, do not remove the radiator cap or loosen the engine drain plug if the engine is hot.

Turn the radiator cap counterclockwise and remove it.

Remove the drain plug on the LH side of engine and drain the coolant into a suitable container.

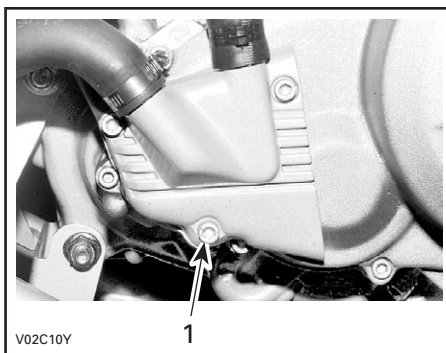

### 1. Cooling plug

Drain the system completely and reinstall the drain plug.

Remove the temperature sensor on the top of thermostat housing.

Fill radiator until coolant comes out by the temperature sensor hole.

Install the temperature sensor and continue the cooling system filling by the radiator.

Complete the radiator filling.

Check the level in the coolant reservoir and refill if necessary.

Run engine at idle with the radiator cap off. Slowly add additional coolant if necessary.

At this point, wait until engine reaches normal operating temperature. Depress the throttle lever two or three times; then add coolant if required.

Install radiator cap. Inspect all connections for leaks and check coolant level in the reservoir.

## Valves Adjustment

See an authorized Bombardier ATV dealer for valves adjustment.

Insufficient clearance will cause loss of power and possibly damage the valves. Excessive clearance will cause noise.

## Spark Arrester

The muffler must be periodically purged of accumulated carbon. See the MAINTENANCE CHART.

### Removal

#### **WARNING**

Never run engine in an enclosed area. Never perform this operation immediately after the engine has been run because exhaust system is very hot. Make sure that there are no combustible materials in the area. Wear eye protection and gloves. Never stand behind the vehicle while purging exhaust system. Respect all applicable laws and regulations.

Remove:

- the screws retaining the spark arrester to the muffler

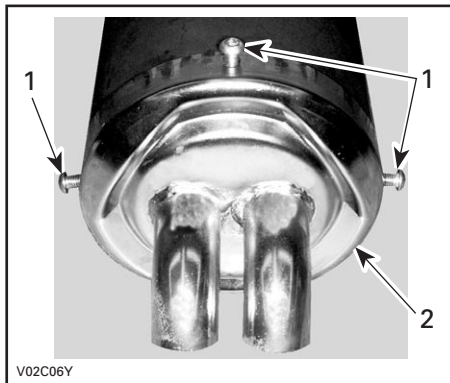

1. Screws
2. Spark arrester

- spark arrester and sealant joint

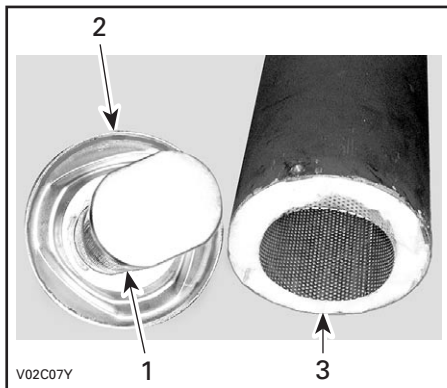

1. Spark arrester
2. Sealant joint
3. Muffler

- inner grill with wool.

Remove all carbon deposit in the muffler.

Remove carbon deposits from the spark arrester using a brush.

**NOTE:** Use a soft brush and be careful to avoid damaging spark arrester.

### Installation

For installation, reverse the removal procedure, pay attention to the following details:

Check:

- insulated wool and change if it is deteriorated
- the spark arrester condition, it must be free of breaks and holes. Replace if necessary.

Remove the old sealant joint and replace by a new one. Use ULTRA COOPER sealant (P/N 293 800 090) or an equivalent product.



Be sure that wool is in place when inserting grill.

Align grill properly in bottom of muffler shell.

## Radiator

Inspect radiator fins. They must be clean, free of mud, dirt, leaves and any other deposit that would prevent the radiator to cool properly.

Remove as much deposits as you can with your hands. If water is available in proximity, try rinsing the radiator fins.

If available, use a garden hose to rinse the radiator fins.

### **WARNING**

Never clean radiator with your hands when it is hot. Let the radiator cool down before cleaning.

**CAUTION:** Be careful not to damage the radiator fins when cleaning. Do not use any object/tool that could damage the fins. The fins are purposely thin parts to allow efficient cooling. **WHEN HOSING, USE LOW PRESSURE ONLY, DO NOT USE A HIGH PRESSURE WASHER.**

## Gearshift Pedal Adjustment

Unfasten socket screw near selector shaft end then remove gearshift pedal.

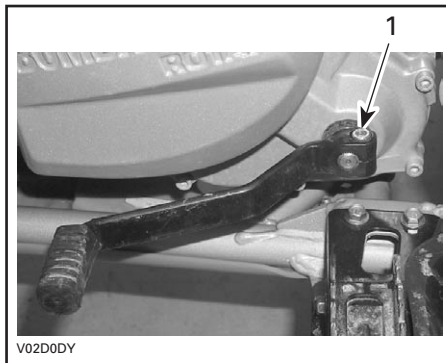

1. Socket screw

Install gearshift pedal at your convenience then torque socket screw.

---

## **CARBURETOR**

See an authorized Bombardier ATV dealer each year or after using the vehicle 100 hours or after 5000 km (3100 m.) to verify and clean the fuel system.

# AIR INTAKE SYSTEM

## Air Filter Cleaning/Draining

Periodically inspect air filter box drain tube for liquid or deposits.

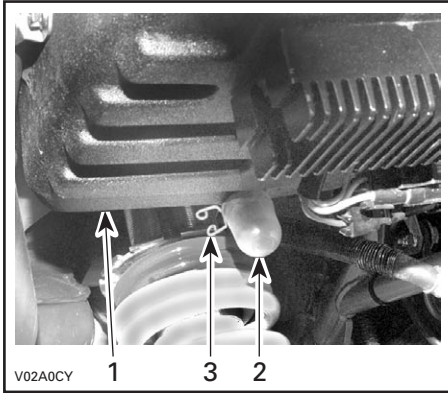

1. Air filter box
2. Drain tube
3. Clamp

**NOTE:** If vehicle is used in dusty areas, inspect more frequently than specified in MAINTENANCE CHART.

If liquid/deposits are found, squeeze and remove the clamp. Pull drain tubes out then empty it.

**CAUTION:** Do not start engine when liquid or deposits are found in the drain tubes.

When liquid/deposits are found, the air filter must be inspected/dried/replaced depending on its condition.

Remove air filter as explained below.

## Air Filter Removal

**CAUTION:** Never remove or modify any component in the air box. Always use genuine parts or suitable equivalent when replacing air filter and foam. The engine carburetion is calibrated to operate specifically with these components. Otherwise, engine performance degradation or damage can occur.

Remove seat.

Release latches and remove air filter box cover.

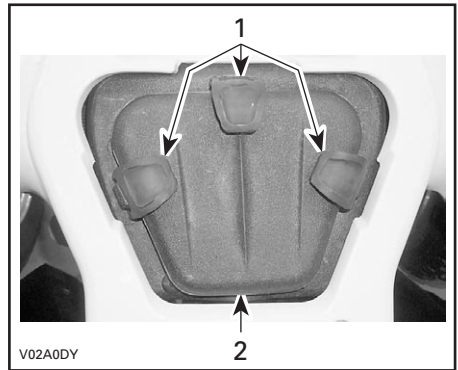

1. Latches
2. Air filter box cover

Remove screw driver cap by pushing it inside of air box.

Loosen clamp and remove filter.

Remove foam.



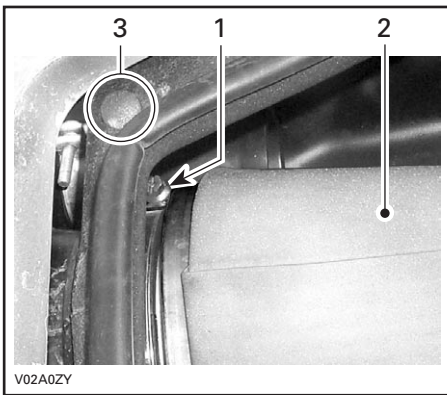

1. *Clamp*
2. *Air filter and foam*
3. *Screw driver cap*

Pour cleaning solution (P/N 219 700 341) or an equivalent into a bucket. Put the filter in to soak.

While filter soaks, clean inside of air box.

Rinse air filter and foam with warm water.

Squeeze foam to remove excess water. Let dry air filter and foam thoroughly.

**NOTE:** Slight dust may be cleaned using a low-pressure airgun. Blow compressed air backward of operating air flow.

If air filter element or foam is dirty, replace with a new one.

When the filter is dried, re-oil with air filter oil (P/N 219 700 340) or an equivalent.

### **Air Filter Installation**

Properly reinstall removed parts in the reverse order of their removal.

# ELECTRICAL

## WARNING

Unless otherwise indicated, always turn ignition switch to the OFF position before performing any maintenance or repair on electrical system.

## Battery

### Cleaning

Clean battery post with a wire brush. Apply dielectric grease (P/N 293 550 004) or an equivalent on post to protect against oxidation.

### Removal

Disconnect BLACK (-) cable first then RED (+) cable.

## WARNING

Always respect this order for disassembly; disconnect BLACK (-) cable first.

Remove bolts retaining battery holder and rack.

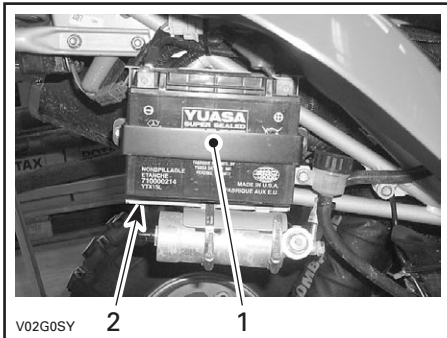

1. Battery holder
2. Rack

## Installation

Reinstall battery in vehicle. Fasten battery holder.

## WARNING

Connect RED (+) cable first then BLACK (-) cable. Always connect RED (+) cable first.

## Fuses

If a fuse is damaged, replace it by one of the same rating.

**CAUTION:** Do not use a higher rated fuse as this can cause severe damage.

Fuses are located under seat, between engine and air box.

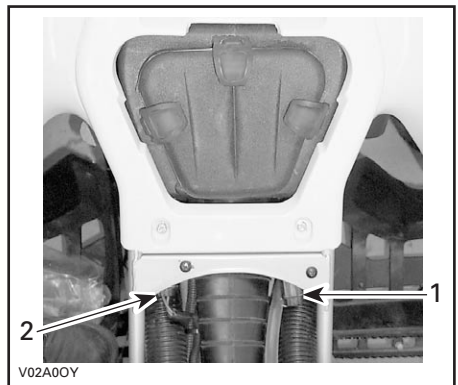

1. Fan (15 A)
2. Charging system (25 A)

To remove fuse from holder, pull fuse out. Check if filament is melted.

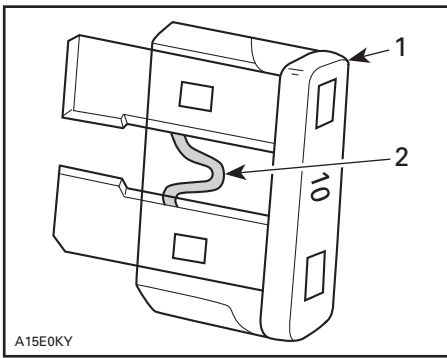

A15E0KY

**TYPICAL**

1. Fuse
2. Check if melted

**Bulb Replacement**

Always check light operation after replacement.

**Headlamp**

If the headlamp bulb is burnt:

- Remove front fascia.
- Remove rubber boot.

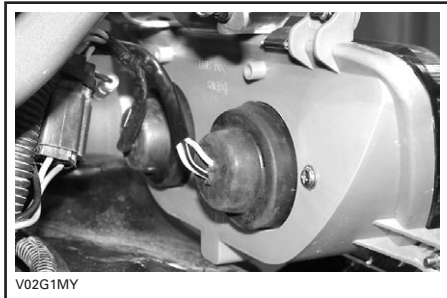

- Push and turn counterclockwise bulb socket ring then remove the bulb.

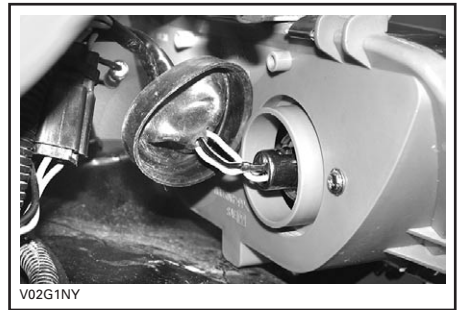

- Detach bulb and replace.



Properly reinstall removed parts in the reverse order of their removal.

**NOTE:** Align the bulb socket tab with the notch in the headlamp housing.

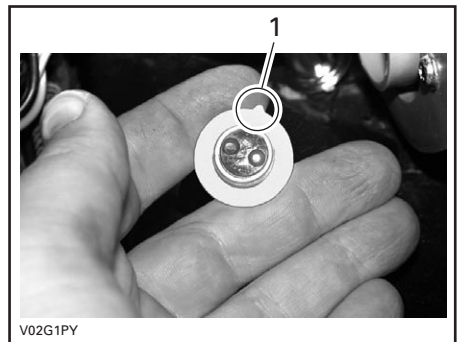

1. Bulb socket tab

**Taillight**

Unscrew lens screws to expose bulb.

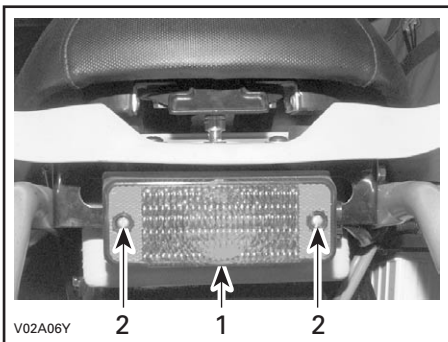

1. Lens
2. Screws

Push bulb in and hold while turning counterclockwise to release.

Install the new bulb by first pushing in while turning clockwise.

### Auxiliary Headlight

Disconnect the auxiliary headlight then remove it from support.

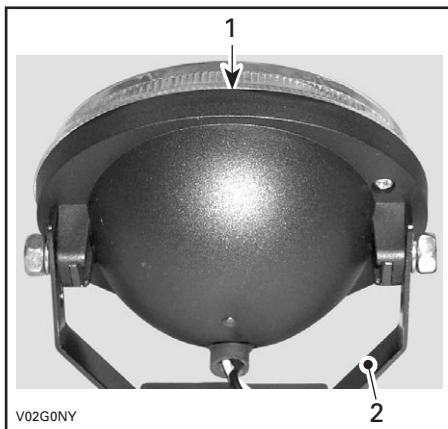

1. Auxiliary headlight
2. Support

Remove the back cover of auxiliary headlight.

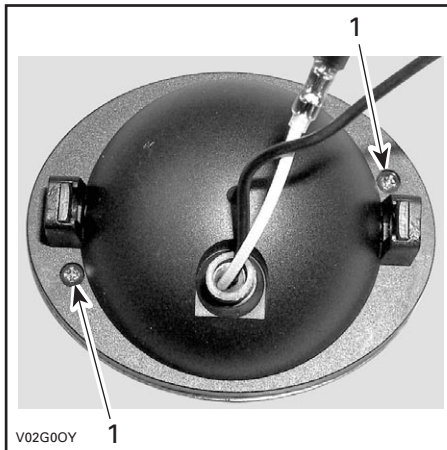

1. Remove these screws

Remove screw retaining the BLACK wire.

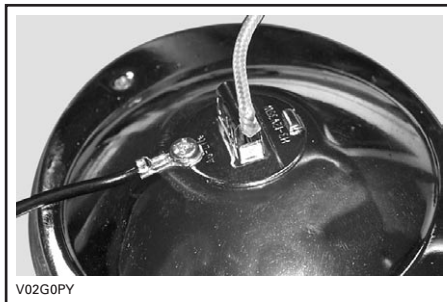

Detach bulb and replace.

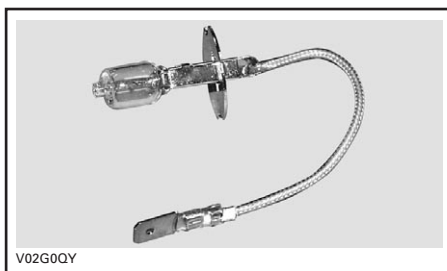

**BULB WITH WIRE ASSEMBLY**

**NOTE: ALWAYS USE A 35 WATTS BULB.** If a 55 watts bulb is used, the regulator might not be able to recharge the battery properly.

Properly reinstall removed parts in the reverse order of their removal.

**CAUTION:** Never touch glass portion of an halogen bulb with bare fingers, it shortens its operating life. If glass is touched, clean it with isopropyl alcohol which will not leave a film on the bulb.

### Tachometer

The bulb in the tachometer is not replaceable. If the tachometer bulb is burnt, replace the tachometer. See an authorized Bombardier ATV dealer.

### Indicator Lamp Replacement

#### Removal

Remove the control panel.

Unplug wires on indicator lamp.

Press both tabs then pull indicator lamp out of hole.

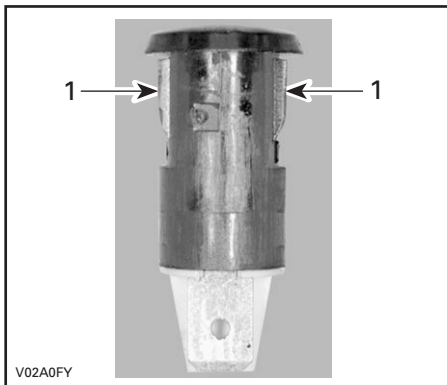

1. Tabs

#### Installation

For installation, reverse the removal procedure.

### Beam Aiming Adjustment

Remove the front fascia.

Using a long screwdriver, turn the adjusting screw clockwise to lift the inside of headlamp and counterclockwise to go down it.

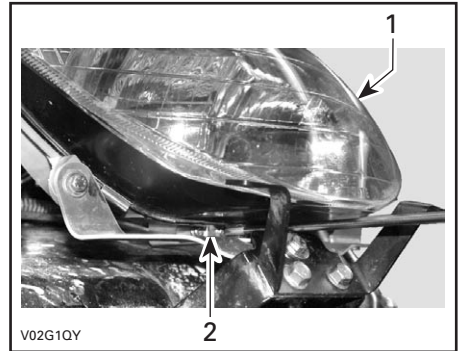

1. Headlamp  
2. Adjusting screw

Adjust beam height to your convenience then reinstall the front fascia.

# DRIVE TRAIN

## Swing Arm and Wheel Hub

### Inspection

Check these parts for damages (cracks, excessive play or corrosion pin-holes) at each 25 hours or at each 1250 km (800 m.). If one of these damages is detected DO NOT USE THE VEHICLE AND SEE AN AUTHORIZED BOMBARDIER ATV DEALER.

### WARNING

Never ride a vehicle with a defective swing arm or a defective wheel hub.

### Lubrication

Lubricate the swing arm with Bombardier suspension synthetic grease (P/N 293 550 033) or an equivalent.

### Drive Chain

Adjust the drive chain before every ride.

### WARNING

Unless otherwise indicated, always turn ignition switch to the OFF position before you check, adjust or lubricate the drive chain.

### Inspection

This ATV is equipped with O-ring sealed permanently greased pins and rollers. Before operating the vehicle, always inspect the drive chain.

Check for damage or missing O-ring, rollers and correct slack adjustment.

## Lubrication and Cleaning

**CAUTION:** Never wash the chain with a high pressure washer or gasoline. Damage to the O-ring will result, causing premature wear and drive chain failure.

Clean the side surfaces of the chain with a dry cloth.

**NOTE:** Do not brush chain.

Lubricate only with an approved O-ring chain lubricant. Other commercial chain lubricants may contain solvent which could damage the O-rings.

## Adjustment

**NOTE:** Always adjust drive chain with the driver, or equivalent weight, seated on the vehicle.

Select a level surface and set transmission to NEUTRAL.

Loosen rear axle lock bolts.

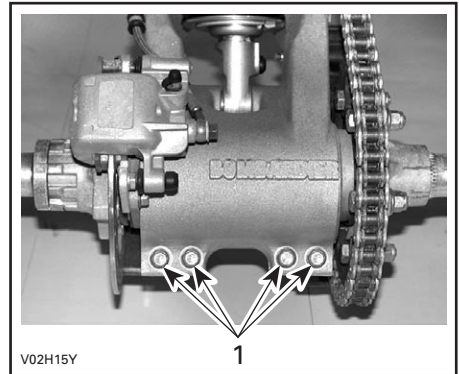

1. Rear axle lock bolts

Insert adjuster lock through sprocket hub and into eccentric axle housing.

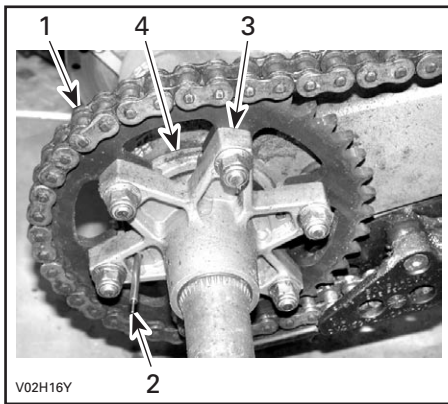

1. Drive chain
2. Adjuster lock
3. Sprocket hub
4. Eccentric axle housing

Turn the axle forward to increase or backwards to decrease chain free play.

**NOTE:** Correct chain free play adjustment is 19 to 25.4 mm (3/4 to 1 in) at midway between sprockets.

Tighten the rear axle lock bolts to 23 N•m (17 lbf•ft).

Use the following sequence to tight the rear axle lock bolts correctly.

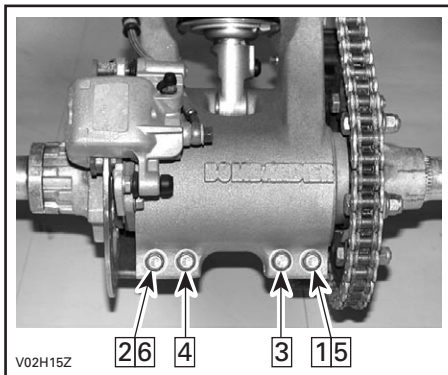

Lift rear of vehicle (without driver) and recheck the chain free play. The chain free play should be 44.5 to 51 mm (1-3/4 to 2 in). If not, redo the drive chain adjustment.

## Replacement

With the chain installed on vehicle, remove all slack from the chain then measure the distance between a span of 13 links from pin center to pin center. Change drive chain if the distance exceeds the service limit, see an authorized Bombardier ATV dealer.

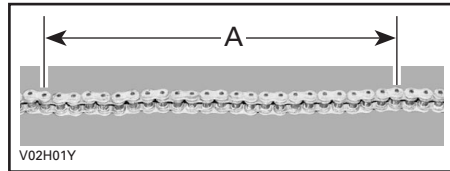

A. 403 mm (15-7/8 in)

## Drive Chain Slider

Check the drive chain slider frequently, see the MAINTENANCE CHART.

Replace the drive chain slider when it is worn.

See an authorized Bombardier ATV dealer for replacement.

## Sprocket and Pinion

Check the sprocket axle and pinion for distortion.

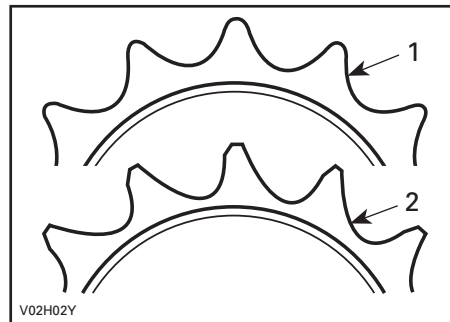

1. Good
2. Replace

**CAUTION:** Replace chain, sprocket axle and pinion together to prevent rapid chain and sprocket wear. Install a new retaining ring each time the pinion is removed.



## Tires/Wheels

### WARNING

When the tires are replaced, never install a bias tire with a radial tire. This combined application may create handling and/or stability problems.

Do not mix tires of different size and/or design on the same axle. Front tire pairs or rear tire pairs must be the identical model and manufacturer.

For unidirectional tread pattern, ensure that the tires are installed in the correct direction of rotation. The radial tires must be installed as a complete set.

Severe injury or death can result if you do not follow these instructions.

## Tire Pressure

### WARNING

Tire pressure greatly affects vehicle handling and stability. Underpressure may cause tire to deflate and rotate on wheel. Overpressure may burst the tire. Always follow recommended pressure. Since tires are low-pressure types, a manual pump should be used.

Check pressure when tires are COLD before using the vehicle. Tire pressure changes with temperature and altitude. Recheck pressure if one of these conditions has changed.

For your convenience, a pressure gauge is supplied in tool box.

TIRE PRESSURE		
	FRONT	REAR
RECOMMENDED	35 kPa (5 PSI)	35 kPa (5 PSI)

Although the tires are specifically designed for off-road use, a flat may still occur. Therefore, it is recommended to carry a tire pump and a repair kit.

## Tire/Wheel Condition

Check tire for damage and wear. Replace if necessary. Do not make a tire rotation. The front and rear tires have a different size. The tires are directional and their rotation must be kept in a specific direction for proper operation.

## Wheel Removal

Occasionally, wheel nuts should be removed to apply an anti-seize lubricant on studs to ease future removal. This is particularly important when vehicle is used in salt-water environment or in mud. Remove one nut at a time, lubricate then retorque.

Loosen nuts then lift vehicle. Place a support under vehicle. Remove nuts then remove wheel. At installation, it is recommended to apply an anti-seize lubricant on threads. Gently tighten nuts in a criss-cross sequence then apply a final torque of 53 N•m (39 lbf•ft).

**CAUTION:** Always use the recommended wheel nuts (P/N 732 610 084). Using a different nut could cause damages to the rim.

## Front Wheel Bearing Condition

Push and pull the wheels from the upper edge to feel the play. See an authorized Bombardier ATV dealer if there is any play.

## Rear Axle Inspection

Lift rear of vehicle high enough to have wheels off the ground. Push and pull rear axle to feel the play. See an authorized Bombardier ATV dealer if there is any play.



# STEERING SYSTEM

## Throttle Cable Lubrication

The throttle cable must be lubricated with Bombardier cable lubricant (P/N 293 600 041) or an equivalent.

### WARNING

Always use a silicone-based lubricant. Using another lubricant (like water-based lubricant) could cause the throttle lever/cable sticking or stiffness.

Open the throttle lever.

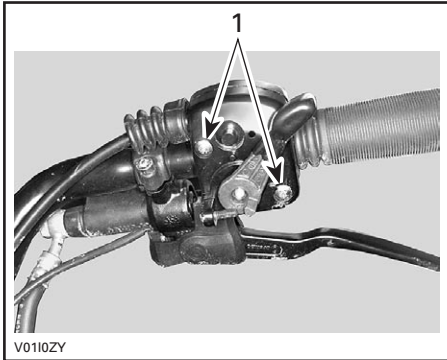

1. Remove screws

Remove:

- the cable from the throttle lever

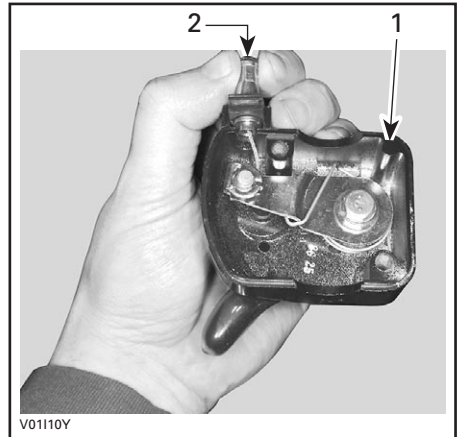

1. Throttle handle housing
2. Throttle cable

**NOTE:** Slide cable in clip slot and remove the end of cable from clip.

- the seal on the throttle cable.

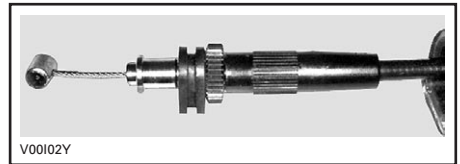

Remove the carburetor side cover.

Install the cable luber (P/N 529 035 738) or an equivalent on the cable.



Insert the needle of spray can in the cable luber hole.

## **WARNING**

**Always wear eye protection and gloves when you lubricate a cable.**

**NOTE:** Place a rag around the cable luber to prevent the lubricant splash.

Put the lubricant until it passes through the cable.

Reinstall the cable.

Spray a little quantity of lubricant on the throttle lever mechanism then close the housing.

Adjust the throttle lever.

## **Throttle Lever Adjustment**

Slide rubber protector back to expose throttle cable adjuster.

Loosen lock nut then turn the adjuster to obtain correct throttle lever free play.

**NOTE:** Measure throttle free play at the tip of throttle lever.

Tighten lock nut and reinstall protector.

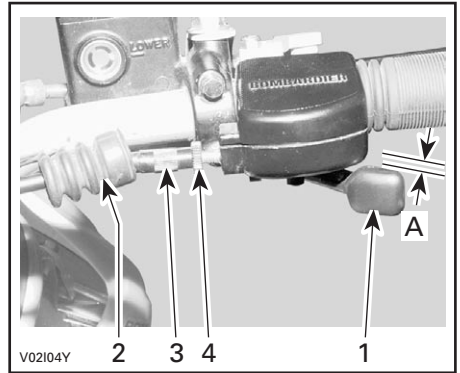

1. Throttle lever
2. Protector
3. Cable adjuster
4. Lock nut

A. 3 to 8 mm (1/8 to 5/16 in)

## **Clutch Adjustment**

Loosen cable tension by closing the cable adjuster on the clutch lever.

Adjust clutch release mechanism as follows.

The release lever must locate on the spline in such a way that dimension A is obtained. See the following illustration.

**NOTE:** If necessary, unscrew the Allen socket screw and withdraw release lever. Replace the lever at the appropriate position then tighten socket screw to 8 N•m (71 lbf•in).

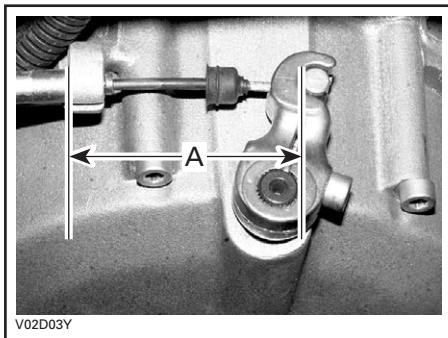

A. 68 to 75 mm (2-11/16 to 2-31/32 in)

Adjust cable free play.

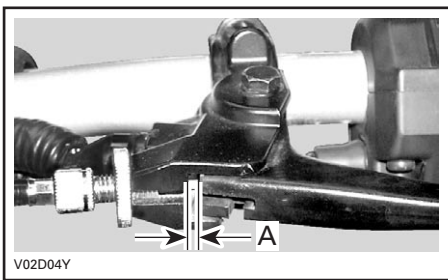

A.  $3.5 \pm 0.5$  mm ( $9/64 \pm 1/64$  in)

## Clutch Cable Lubrication

Remove the cable from the engine.

Remove the cable from the hand lever.

Put the cable luber (P/N 529 035 738) or an equivalent on the cable.

Insert the needle of the spray can in the hole.

Spray silicone lubricant (P/N 293 600 041) or an equivalent until it exits the other end of the cable.

### **WARNING**

Always use a silicone-based lubricant. Using another lubricant (like water-based lubricant) could cause the clutch lever/cable sticking or stiffness.

# SUSPENSION

**CAUTION:** The DS 650 X are equipped with shock protectors. Open or remove them when the ambient temperature is high or when the vehicle is used intensively. Otherwise, performance degradation or damage can be caused to the shock absorbers.

**NOTE:** Do not remove the shock protectors if the vehicle is used on a gravel surface.

## Lubrication

### Front A-Arm

Lubricate front A-arms with a grease gun. Use Bombardier suspension synthetic grease (P/N 293 550 033) or an equivalent.

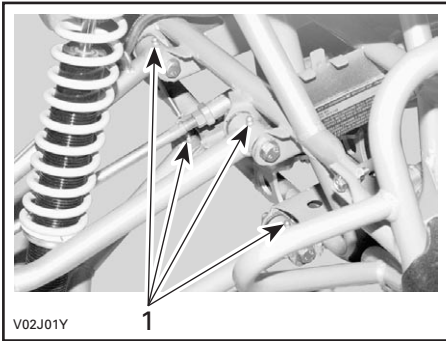

1. Grease fittings

## Inspection

### A-Arms

Check these parts for damages (cracks, excessive play or corrosion pin-holes) at each 25 hours or at each 1250 km (800 m.). If one of these damages is detected **DO NOT USE THE VEHICLE AND SEE AN AUTHORIZED BOMBARDIER ATV DEALER.**

## WARNING

Never ride a vehicle with a defective A-arm.

## Shock Absorbers

Inspect shock absorber for oil leaks and fasteners for tightness. See an authorized Bombardier ATV dealer as necessary.

## Adjustment

### Front Shocks

## WARNING

Adjust both springs to the same load. Uneven adjustment can cause poor handling and loss of stability, and/or control, and increase the risk of an accident.

### Preload Adjustment

Shorten the spring for a firmer ride and rough road condition.

Lengthen the spring for a light load and a smooth road condition.

## WARNING

The front shocks contain high pressure nitrogen gas. Do not attempt to disassemble the shock absorber. Do not dispose of it. See an authorized Bombardier ATV dealer.

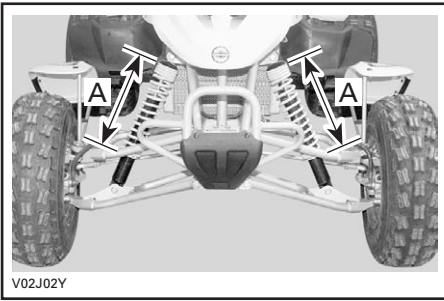

V02J02Y

A. Same length

## Rear Shock

### WARNING

The rear shock includes a damper unit that contains high pressure nitrogen gas. Do not attempt to disassemble the damper. Do not dispose of it. See an authorized Bombardier ATV dealer.

## Spring Preload

Spring preload may vary from rider to rider depending upon their weight. Preload can be changed by setting the two lock nuts up or down to compress the spring to different lengths. Shortening or lengthening the spring length will increase or decrease the preload.

Before adjusting the spring preload, first measure the ATV's height, without rider, from the rear bumper nut to the ground.

**NOTE:** Lift the vehicle by the rear bumper. The shock should be fully extended.

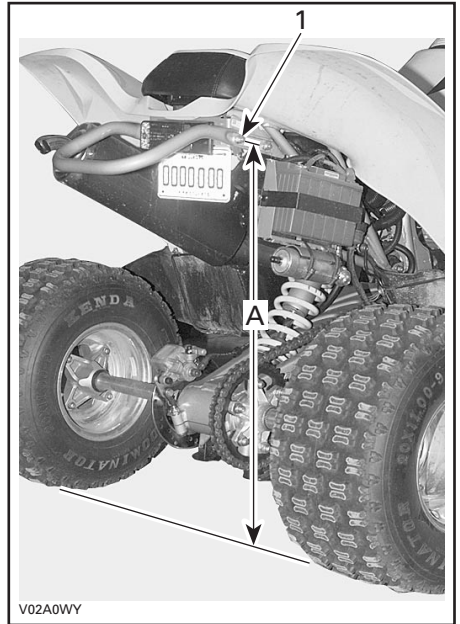

VO2A0WY

1. Rear bumper nut
- A. Measure between rear bumper nut and ground

Next, sit the rider, with gear, on the ATV and measure the distance between the same two points.

**CAUTION:** Add all other loads and accessories before measuring the height of the vehicle with the rider on. Do not exceed the total vehicle load allowed.

Calculate the difference between the two lengths. If the vehicle's height decreases more than 127 mm (5 in), increase the preload by 3 mm (1/8 in) increments. If the vehicle's height decreases of less than 102 mm (4 in), decrease the preload by 3 mm (1/8 in) increments. The optimum adjustment range is between 102 mm (4 in) and 127 mm (5 in) but, for heavier or more aggressive riders, it could be between 76 mm (3 in) and 102 mm (4 in).

## Preload Adjustment:

To reduce: Turn the shock spring adjuster counterclockwise for a light load and smooth condition.

To increase: Turn the shock spring adjuster clockwise for a firmer ride and rough condition.

## Rebound Damping:

To reduce: Turn the shock adjuster counterclockwise for a light load and smooth condition.

To increase: Turn the shock adjuster clockwise for a firmer ride and rough condition.

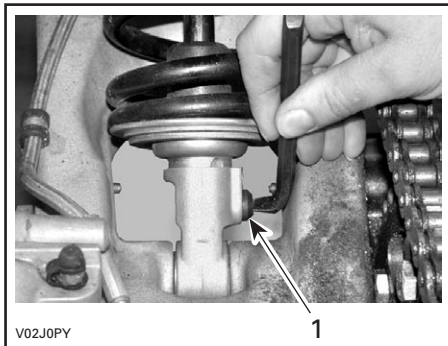

1. Adjuster

**NOTE:** The adjuster tool is included in the tool kit.

## Compression Damping:

To reduce: Turn the damper adjuster counterclockwise for a light load and smooth condition.

To increase: Turn the damper adjuster clockwise for a firmer ride and rough condition.

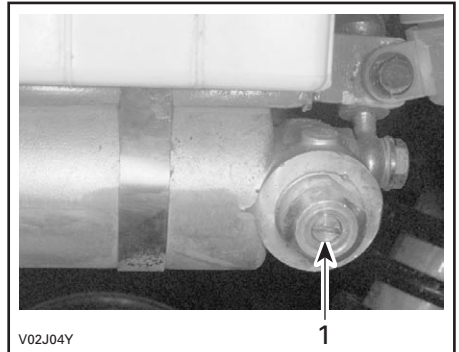

1. Adjuster

---

# **BRAKES**

## **Front and Rear Brakes**

The front and rear brakes are hydraulic disc types. These brakes are self-adjusting and require no adjustment.

Check brake line fittings tightness before every ride.

# BODY/FRAME

## Engine Area

Check engine area for any damage and leaks. Ensure all hose clamps are properly secured and no hose is cracked, kinked or otherwise damaged. Inspect muffler, battery and reservoir fastening devices. Check electrical connections for corrosion and tightness. Replace or have damaged parts repaired.

## Skid Plate

Check tightness of fasteners and condition of plate for cracks or other damage. Properly retighten fasteners as necessary and have skid plate replaced if damaged.

## Front Fenders

Check tightness of fasteners and condition of front fender for cracks or other damage. Properly retighten fasteners as necessary and have front fender replaced if damaged.

### **WARNING**

Never remove the front fenders. The important labels are applied on the front fenders. Operating without front fender, increases your chances of severe injury in the event of an accident.

## Fasteners

Check fastener condition and tightness on the vehicle. Retighten as required.

While reading this Operator's Guide, remember that:

### **WARNING**

Indicates a potential hazard that, if not avoided, could result in serious injury or death.

## Seat Latch

Remove seat and check latch mechanism and pin for wear. See an authorized Bombardier ATV dealer for parts replacement if damaged.

## Frame

Check frame for cracks or other damage. See an authorized Bombardier ATV dealer for replace or repair.

## Vehicle Cleaning and Protection

Painted parts which are damaged should be properly repainted to prevent rust.

When required, wash the body with hot water and soap (only use mild detergent). Apply non-abrasive wax.

**CAUTION:** Never clean plastic parts with strong detergent, degreasing agent, paint thinner, acetone, etc.

**NOTE:** Never use a high pressure washer to clean the vehicle **USE LOW PRESSURE ONLY** (like a garden hose). The high pressure can cause electrical or mechanical damages.



# ***WARRANTY***

---

# **BRP LIMITED WARRANTY NORTH AMERICA: 2006 BOMBARDIER† ATV**

## **1) SCOPE OF THE LIMITED WARRANTY**

Bombardier Recreational Products Inc. ("BRP")\* warrants its 2006 Bombardier ATVs from defects in material or workmanship for the period and under the conditions described below.

All genuine Bombardier parts and accessories, installed by an authorized Bombardier ATV dealer (as hereinafter defined) at the time of delivery of the 2006 Bombardier ATV, carry the same warranty as that of the ATV.

Use of the product for racing or any other competitive activity, at any point, even by a previous owner, will render this warranty null and void.

## **2) WARRANTY COVERAGE PERIOD**

This warranty will be in effect from the date of delivery to the first retail consumer or the date the product is first put into use, whichever occurs first and for a period of:

SIX (6) CONSECUTIVE MONTHS, for private use or commercial use owners.

The repair or replacement of parts or the performance of service under this warranty does not extend the life of this warranty beyond its original expiration date.

## **3) CONDITIONS TO HAVE WARRANTY COVERAGE**

This warranty coverage is available only on 2006 Bombardier ATVs purchased as new and unused by its first owner from a Bombardier dealer authorized to distribute Bombardier ATV products in the country in which the sale occurred ("Bombardier ATV dealer"), and then only after the BRP specified pre-delivery inspection process is completed and documented. Warranty coverage only becomes available upon proper registration of the product by an authorized Bombardier ATV dealer. Moreover, this warranty coverage is only available if the Bombardier ATV is purchased in the country in which the purchaser resides. BRP will not honor this limited warranty to any private use owner or commercial use owner if the preceding conditions have not been met. Such limitations are necessary in order to allow BRP to preserve both the safety of its products, and also that of its consumers and the general public.

Routine maintenance outlined in the *Operator's Guide* must be timely performed in order to maintain warranty coverage. BRP reserves the right to make warranty coverage contingent upon proof of proper maintenance.

## **4) WHAT TO DO TO OBTAIN WARRANTY COVERAGE**

The customer must notify a servicing Bombardier ATV dealer within two (2) days of the appearance of a defect, and provide it with reasonable access to the product and reasonable opportunity to repair it. The customer must also present to the authorized Bombardier dealer, proof of purchase of the product and must sign the repair/work order prior to starting the repair in order to validate the warranty repair. All parts replaced under this limited warranty become the property of BRP.

## **5) WHAT BRP WILL DO**

BRP's obligations under this warranty are limited to, at its sole discretion, repairing parts found defective under normal use, maintenance and service, or replacing such parts with new genuine Bombardier parts without charge for parts and labor, at any authorized Bombardier ATV dealer during the warranty coverage period.

BRP reserves the right to improve or modify products from time to time without assuming any obligation to modify products previously manufactured.

## **6) EXCLUSIONS - ARE NOT WARRANTED**

The following are not warranted under any circumstances:

- Normal wear and tear;
- Routine maintenance items, tune ups, adjustments;
- Damage caused by failure to provide proper maintenance and/or storage, as described in the *Operator's Guide*;
- Damage resulting from removal of parts, improper repairs, service, maintenance, modifications or use of parts not manufactured or approved by BRP or resulting from repairs done by a person that is not an authorized servicing Bombardier ATV dealer;
- Damage caused by abuse, abnormal use, neglect or operation of the product in a manner inconsistent with the recommended operation described in the *Operator's Guide*;
- Damage resulting from accident, submersion, fire, theft, vandalism or any act of God;
- Operation with fuels, oils or lubricants which are not suitable for use with the product (see the *Operator's Guide*);
- Water or snow ingestion;
- Incidental or consequential damages, or damages of any kind including without limitation towing, storage, telephone, rental, taxi, inconvenience, insurance coverage, loan payments, loss of time, loss of income.

## **7) LIMITATIONS OF LIABILITY**

THIS WARRANTY IS EXPRESSLY GIVEN AND ACCEPTED IN LIEU OF ANY AND ALL OTHER WARRANTIES, EXPRESSED OR IMPLIED, INCLUDING WITHOUT LIMITATION ANY WARRANTY OF MERCHANTABILITY OR FITNESS FOR A PARTICULAR PURPOSE. TO THE EXTENT THAT THEY CANNOT BE DISCLAIMED, THE IMPLIED WARRANTIES ARE LIMITED IN DURATION TO THE LIFE OF THE EXPRESS WARRANTY. INCIDENTAL AND CONSEQUENTIAL DAMAGES ARE EXCLUDED FROM COVERAGE UNDER THIS WARRANTY. SOME STATES/ PROVINCES DO NOT ALLOW FOR THE DISCLAIMERS, LIMITATIONS AND EXCLUSIONS IDENTIFIED ABOVE, AS A RESULT, THEY MAY NOT APPLY TO YOU. THIS WARRANTY GIVES YOU SPECIFIC RIGHTS, AND YOU MAY ALSO HAVE OTHER LEGAL RIGHTS WHICH MAY VARY FROM STATE TO STATE, OR PROVINCE TO PROVINCE.

Neither the distributor, any Bombardier ATV dealer nor any other person has been authorized to make any affirmation, representation or warranty regarding the product, other than those contained in this limited warranty, and if made, shall not be enforceable against BRP.

BRP reserves the right to modify this warranty at any time, being understood that such modification will not alter the warranty conditions applicable to the products sold while this warranty is in effect.

## **8) TRANSFER**

If the ownership of a product is transferred during the warranty coverage period, this warranty shall also be transferred and be valid for the remaining coverage period provided that BRP is notified of such transfer of ownership in the following way:

- a) The former owner contacts BRP (at the phone number provided below) or an authorized Bombardier ATV dealer and gives the coordinates of the new owner; or
- b) BRP or an authorized Bombardier ATV dealer receives a proof that the former owner agreed to the transfer of ownership, in addition to the coordinates of the new owner.

## 9) CONSUMER ASSISTANCE

- a) In the event of a controversy or a dispute in connection with this limited warranty, BRP suggests that you try to resolve the issue at the dealership level. We recommend discussing the issue with the authorized dealer's service manager or owner.
- b) If the issue has not yet been resolved, please submit your complaint in writing or call the appropriate number below:

IN CANADA:

BOMBARDIER RECREATIONAL  
PRODUCTS INC.  
BOMBARDIER ATV  
CUSTOMER ASSISTANCE  
CENTER  
VALCOURT, QC, J0E 2L0  
TEL : 1 (819) 566-3366

IN USA:

BRP US INC.  
CUSTOMER SERVICES GROUP  
7575 BOMBARDIER COURT  
WAUSAU WI 54401  
TEL : 1 (715) 848-4957

\* In the USA, products are distributed and serviced by BRP US Inc.

© 2005 Bombardier Recreational Products Inc. All rights reserved.

® Registered trademark and ™ trademarks of Bombardier Recreational Products Inc. or its subsidiaries.

† Bombardier is a trademark of Bombardier Inc. used under license.

---

# **BRP INTERNATIONAL LIMITED WARRANTY: 2006 BOMBARDIER<sup>†</sup> ATV**

## **1) SCOPE OF THE LIMITED WARRANTY**

Bombardier Recreational Products Inc. ("BRP") warrants its 2006 Bombardier ATVs from defects in material or workmanship for the period and under the conditions described below.

All genuine Bombardier parts and accessories, installed by an authorized Bombardier distributor/dealer (as hereinafter defined) at the time of delivery of the 2006 Bombardier ATV, carry the same warranty as that of the ATV.

Use of the product for racing or any other competitive activity, at any point, even by a previous owner; will render this warranty null and void.

## **2) WARRANTY COVERAGE PERIOD**

This warranty will be in effect from the date of delivery to the first retail consumer or the date the product is first put into use, whichever occurs first and for a period of:

SIX (6) CONSECUTIVE MONTHS, for private use or commercial use owners.

The repair or replacement of parts or the performance of service under this warranty does not extend the life of this warranty beyond its original expiration date.

## **3) CONDITIONS TO HAVE WARRANTY COVERAGE**

This warranty coverage is available only on 2006 Bombardier ATVs purchased as new and unused by its first owner from a Bombardier distributor/dealer authorized to distribute Bombardier ATV products in the country in which the sale occurred ("Bombardier ATV distributor/dealer"), and then only after the BRP specified predelivery inspection process is completed and documented. Warranty coverage only becomes available upon proper registration of the product by an authorized Bombardier ATV distributor/dealer. Moreover, this warranty coverage is only available if the Bombardier ATV is purchased in the country in which the purchaser resides. BRP will not honor this limited warranty to any private use owner or commercial use owner if the preceding conditions have not been met. Such limitations are necessary in order to allow BRP to preserve both the safety of its products, and also that of its consumers and the general public.

Routine maintenance outlined in the *Operator's Guide* must be timely performed in order to maintain warranty coverage. BRP reserves the right to make warranty coverage contingent upon proof of proper maintenance.

## **4) WHAT TO DO TO OBTAIN WARRANTY COVERAGE**

The customer must notify a servicing Bombardier ATV distributor/dealer within two (2) days of the appearance of a defect, and provide it with reasonable access to the product and reasonable opportunity to repair it. The customer must also present to the authorized Bombardier distributor/dealer, proof of purchase of the product and must sign the repair/work order prior to starting the repair in order to validate the warranty repair. All parts replaced under this limited warranty become the property of BRP.

## **5) WHAT BRP WILL DO**

BRP's obligations under this warranty are limited to, at its sole discretion, repairing parts found defective under normal use, maintenance and service; or replacing such parts with new genuine Bombardier parts without charge for parts and labour, at any authorized Bombardier distributor/dealer.

BRP reserves the right to improve or modify products from time to time without assuming any obligation to modify products previously manufactured.

## **6) EXCLUSIONS - ARE NOT WARRANTED**

The following are not warranted under any circumstances:

- Normal wear and tear;
- Routine maintenance items, tune ups, adjustments;
- Damage caused by failure to provide proper maintenance and/or storage, as described in the *Operator's Guide*;
- Damage resulting from removal of parts, improper repairs, service, maintenance, modifications or use of parts not manufactured or approved by BRP or resulting from repairs done by a person that is not an authorized servicing Bombardier distributor/dealer;
- Damage caused by abuse, abnormal use, neglect or operation of the product in a manner inconsistent with the recommended operation described in the *Operator's Guide*;
- Damage resulting from accident, submersion, fire, theft, vandalism or any act of God;
- Operation with fuels, oils or lubricants which are not suitable for use with the product (see the *Operator's Guide*);
- Water or snow ingestion;
- Incidental or consequential damages, or damages of any kind including without limitation towing, storage, telephone, rental, taxi, inconvenience, insurance coverage, loan payments, loss of time, loss of income.

## **7) LIMITATIONS OF LIABILITY**

THIS WARRANTY IS EXPRESSLY GIVEN AND ACCEPTED IN LIEU OF ANY AND ALL OTHER WARRANTIES, EXPRESSED OR IMPLIED, INCLUDING WITHOUT LIMITATION ANY WARRANTY OF MERCHANTABILITY OR FITNESS FOR A PARTICULAR PURPOSE. TO THE EXTENT THAT THEY CANNOT BE DISCLAIMED, THE IMPLIED WARRANTIES ARE LIMITED IN DURATION TO THE LIFE OF THE EXPRESS WARRANTY. INCIDENTAL AND CONSEQUENTIAL DAMAGES ARE EXCLUDED FROM COVERAGE UNDER THIS WARRANTY. SOME JURISDICTIONS DO NOT ALLOW FOR THE DISCLAIMERS, LIMITATIONS AND EXCLUSIONS IDENTIFIED ABOVE, AS A RESULT, THEY MAY NOT APPLY TO YOU. THIS WARRANTY GIVES YOU SPECIFIC RIGHTS, AND YOU MAY ALSO HAVE OTHER LEGAL RIGHTS WHICH MAY VARY FROM COUNTRY TO COUNTRY.

Neither the distributor, any BRP dealer nor any other person has been authorized to make any affirmation, representation or warranty regarding the product, other than those contained in this limited warranty, and if made, shall not be enforceable against BRP.

BRP reserves the right to modify this warranty at any time, being understood that such modification will not alter the warranty conditions applicable to the products sold while this warranty is in effect.

## **8) TRANSFER**

If the ownership of a product is transferred during the warranty coverage period, this warranty shall also be transferred and be valid for the remaining coverage period provided BRP or an authorized Bombardier ATV distributor / dealer receives a proof that the former owner agreed to the transfer of ownership, in addition to the coordinates of the new owner.

## **9) CONSUMER ASSISTANCE**

- a) In the event of a controversy or a dispute in connection with this limited warranty, BRP suggests that you try to resolve the issue at the dealership level. We recommend discussing the issue with the authorized dealer's service manager or owner.
- b) If further assistance is required, the distributor's service department should be contacted in order to resolve the matter.
- c) If the matter still remains unresolved then contact BRP by writing to us at the address listed below.

**BOMBARDIER RECREATIONAL PRODUCTS INC.**  
**BOMBARDIER ATV**  
**CUSTOMER ASSISTANCE GROUP**  
**VALCOURT, QC, J0E 2L0**  
**TEL : 1 (819) 566-3366**

© 2005 Bombardier Recreational Products Inc. All rights reserved.

† Bombardier is a trademark of Bombardier Inc. used under license.



---

## **PRIVACY OBLIGATION/DISCLAIMER**

We wish to inform you that your coordinates will be used for safety and warranty purposes. Sometimes, we also use the coordinates of our clients to inform them about our products and to present them offers. Should you prefer not to receive information on our product, services and offers, please let us know by writing to the address below.

Also note that, from time to time, carefully selected and trustworthy organizations may be permitted to use the coordinates of our clients to promote quality products and services. If you prefer not to have your name and address released, please let us know by writing to the address below.

### **Bombardier Recreational Products Inc.**

Warranty Department  
75 J.A. Bombardier Street  
Sherbrooke, Québec J1L 1W3  
Canada  
Fax Number: (819) 566-3590



---

## CHANGE OF ADDRESS/OWNERSHIP

If your address has changed or if you are the new owner of the ATV, be sure to notify BRP by either:

- mailing the card below;
- calling at (715) 848-4957 (USA) or (819) 566-3366 (Canada);
- notifying an authorized Bombardier ATV dealer.

In case of change of ownership, please join a proof that the former owner agreed to the transfer.

Notifying BRP, even after the expiration of the limited warranty, is very important as it enables BRP to reach the ATV owner if necessary, like when safety recalls are initiated. It is the owner's responsibility to notify BRP.

**STOLEN UNITS:** If your personal ATV is stolen, you should notify BRP or an authorized Bombardier ATV dealer. We will ask you to provide your name, address, phone number, the vehicle identification number and the date it was stolen.

AFFIX  
PROPER  
POSTAGE



**Bombardier Recreational Products Inc.**

WARRANTY DEPARTMENT  
75, J.-A. Bombardier Street  
Sherbrooke, Québec  
Canada J1L 1W3

V00A2G

---

## CHANGE OF ADDRESS/OWNERSHIP

If your address has changed or if you are the new owner of the ATV, be sure to notify BRP by either:

- mailing the card below;
- calling at (715) 848-4957 (USA) or (819) 566-3366 (Canada);
- notifying an authorized Bombardier ATV dealer.

In case of change of ownership, please join a proof that the former owner agreed to the transfer.

Notifying BRP, even after the expiration of the limited warranty, is very important as it enables BRP to reach the ATV owner if necessary, like when safety recalls are initiated. It is the owner's responsibility to notify BRP.

**STOLEN UNITS:** If your personal ATV is stolen, you should notify BRP or an authorized Bombardier ATV dealer. We will ask you to provide your name, address, phone number, the vehicle identification number and the date it was stolen.

AFFIX  
PROPER  
POSTAGE



**Bombardier Recreational Products Inc.**

WARRANTY DEPARTMENT  
75, J.-A. Bombardier Street  
Sherbrooke, Québec  
Canada J1L 1W3

V00A2G

**ATV MODEL No.** \_\_\_\_\_

**VEHICLE IDENTIFICATION NUMBER (V.I.N.)** \_\_\_\_\_

**ENGINE IDENTIFICATION NUMBER (E.I.N.)** \_\_\_\_\_

**Owner:** \_\_\_\_\_  
NAME

\_\_\_\_\_  
No. STREET APT

\_\_\_\_\_  
CITY STATE/PROVINCE ZIP/POSTAL CODE

**Purchase Date** \_\_\_\_\_  
YEAR MONTH DAY

**Warranty Expiry Date** \_\_\_\_\_  
YEAR MONTH DAY

To be completed by the dealer at the time of the sale.

DEALER IMPRINT AREA

**Please verify with your dealer to ensure your vehicle has been registered with BRP.**

While reading this Operator's Guide, remember that:



Indicates a potential hazard that, if not avoided, could result in serious injury or death.



## WARNING

**THIS VEHICLE CAN BE HAZARDOUS TO OPERATE.**

A collision or rollover can occur quickly, even during routine maneuvers such as turning and driving on hills or over obstacles, if you fail to take proper precautions.

**SEVERE INJURY OR DEATH** can result if you do not follow these instructions:

- **BEFORE YOU OPERATE THIS ATV, READ THIS OPERATOR'S GUIDE AND ALL ON-PRODUCT LABELS.**
- **NEVER OPERATE THIS ATV WITHOUT PROPER INSTRUCTIONS.** Beginners should complete a certified training course.
- **NEVER CARRY A PASSENGER.** You increase your risk of losing control if you carry a passenger.
- **NEVER OPERATE THIS ATV ON A PAVED SURFACE.** You increase your risk of losing control if you operate this ATV on pavement.
- **NEVER OPERATE THIS ATV ON PUBLIC ROADS.** You can collide with another vehicle if you operate this ATV on a public road.
- **ALWAYS WEAR AN APPROVED HELMET,** eye protection, and protective clothing.
- **NEVER CONSUME ALCOHOL OR DRUGS** before or while operating this vehicle.
- **NEVER OPERATE THIS ATV AT EXCESSIVE SPEEDS.** You increase your risk of losing control if you operate this ATV at speeds too fast for the terrain, visibility conditions, or your experience.
- **NEVER ATTEMPT WHEELIES, JUMPS, OR OTHER STUNTS.**



©™ TRADEMARKS OF BOMBARDIER RECREATIONAL PRODUCTS INC. OR ITS AFFILIATES.

\*TRADEMARK OF BOMBARDIER INC. USED UNDER LICENSE.

©2005 BOMBARDIER RECREATIONAL PRODUCTS INC. ALL RIGHTS RESERVED. PRINTED IN CANADA.

219 000 378

CA

OPERATOR'S GUIDE, DS 650 X / ENGLISH  
GUIDE DU CONDUCTEUR, DS 650 X / ANGLAIS

FAIT AU / MADE IN CANADA

U/M:P.C.



## Free Manuals Download Website

<http://myh66.com>

<http://usermanuals.us>

<http://www.somanuals.com>

<http://www.4manuals.cc>

<http://www.manual-lib.com>

<http://www.404manual.com>

<http://www.luxmanual.com>

<http://aubethermostatmanual.com>

Golf course search by state

<http://golfingnear.com>

Email search by domain

<http://emailbydomain.com>

Auto manuals search

<http://auto.somanuals.com>

TV manuals search

<http://tv.somanuals.com>