



# STRATFORD



**NOTE: This appliance is fitted with a battery powered ignition system. Should the ignition system start to spark slowly - or not at all, the battery will need replacing. See the section on battery replacement.**

## Use and Installation Instructions

The cooker must be installed in accordance with the regulations in force and only used in a well ventilated space.

**Read these instructions prior to installing or using the cooker and retain them for future reference.**

**Part No. 4466200017-01**

---

# CONTENTS

---

	<b>PAGE</b>
INTRODUCTION	3
FOR YOUR SAFETY	4
HOTPLATE	6
GRILL	8
OVEN	9
THE 'SLOW COOK' SETTING	11
OVEN COOKING CHART	12
CARE AND CLEANING / BATTERY REPLACEMENT	14
SOMETHING WRONG	16
INSTALLATION INSTRUCTIONS	18
SERVICE INFORMATION	Back Cover

---

# INTRODUCTION

---

To help you make the best use of your cooker, PLEASE READ THIS BOOKLET CAREFULLY.

Your new cooker is guaranteed and will give lasting service. The guarantee is only applicable if the cooker has been installed in accordance with the Installation Instructions.

The cooker is designed specifically for domestic use and responsibility will not be accepted for use in any other installation.

When first using the cooker ensure that the room is well ventilated (e.g. open a window or use an extractor fan) and that persons who may be sensitive to the odour avoid any fumes. It is suggested that any pets be removed from the room until the smell has ceased. This odour is due to any temporary finish and also any moisture absorbed by the insulation.

Our policy is one of continual improvement in design and development, therefore strict accuracy of illustrations and descriptions cannot be guaranteed.



This appliance conforms to the following EEC Directives:

Gas Appliances  
90/396/EEC

---

## FOR YOUR SAFETY

---

**Please read the precautions below before using your cooker.**

- ALWAYS make sure you understand the controls before using the cooker.
- ALWAYS check that all controls on the cooker are turned off after use.
- ALWAYS stand back when opening an oven door to allow heat to disperse.
- ALWAYS use dry, good quality oven gloves when removing items from the oven.
- ALWAYS take care when removing items from the grill when the oven is on, as the contents may be hot.
- ALWAYS keep the oven and grill doors closed when the cooker is not in use.
- ALWAYS place pans centrally over the hotplate burners and position them so that the handles cannot accidentally be caught or knocked or become heated by other burners.
- ALWAYS keep the cooker clean, as a build up of grease or fat from cooking can cause a fire.
- ALWAYS allow the cooker to cool before cleaning.
- ALWAYS follow the basic principles of food handling and hygiene to prevent the possibility of bacterial growth.
- ALWAYS keep ventilation slots clear of obstructions.
- ALWAYS refer servicing to CORGI registered appliance service engineers.

---

## FOR YOUR SAFETY

---

- NEVER leave children unsupervised where the cooker is installed as all surfaces will get hot during and after use.
- NEVER allow anyone to sit or stand on any part of the cooker.
- NEVER store items that children may attempt to reach above the cooker.
- NEVER heat up unopened food containers as pressure can build up causing the container to burst.
- NEVER store chemicals, food stuffs, pressurised containers in or on the cooker, or in cabinet immediately above or next to the cooker.
- NEVER fill a deep fat frying pan more than 1/3 full of oil, and never use a lid. **DO NOT LEAVE UNATTENDED WHILE COOKING.**
- NEVER place flammable or plastic items on or near the hotplate.
- NEVER use proprietary spillage collectors on the hotplate.
- NEVER use the cooker as a room heater.
- NEVER dry clothes or place other items over or near to the hotplate or oven/grill doors.
- NEVER wear garments with long flowing sleeves whilst cooking.

**NOTE:** The use of a gas cooking appliance results in the production of heat and moisture in the room in which it is installed. Always ensure that the kitchen is well ventilated; keep natural ventilation holes open or install a mechanical ventilation device (mechanical extractor hood).

In particular when using the grill or more than one hotplate burner, open a window if a mechanical ventilation device is not operating.

---

# HOTPLATE

---

The hotplate lid is fitted with a safety device which cuts off the gas supply to the hotplate burners unless the lid is fully open. Do not use the safety device as a means of controlling the hotplate burners.

The hotplate has two high speed burners and two simmering burners which will accommodate pans between 100mm (4") and 230mm (9") diameter. All pans should be positioned centrally over the burners.

## TO USE THE HOTPLATE

1. Remove any items or spillage from the top of the lid and then raise it to its fully open position.
2. Press the ignition button and then push in and turn the control knob of the chosen burner anti-clockwise to the large flame symbol. Continue to press the ignition button until the sparks light the gas.
3. Turn the control knob anti-clockwise to the desired setting. Only turn the control knob between the large flame symbol and the small flame symbol for adjusting the setting.
4. To turn off, turn the control knob fully clockwise to the symbol **O**.

**DO NOT** use the hotplate unless all pan supports are in position.

**DO NOT** use mis-shapen pans which may be unstable.

**DO NOT** use round base woks directly on the pan supports.

**DO NOT** use the glass lid as a working surface.

Each burner is fitted with a spark ignitor for lighting the gas. To ensure rapid lighting of the burners every time they are used, the ignitors must be kept **clean and dry**. Remove any food spillage or cleaning materials from the ignitor using a small nylon brush such as a tooth brush. Access to the ignitor can be achieved by lifting off the loose burner parts carefully when the burners are cool.

When the hotplate burner bodies and caps are removed for cleaning, be careful not to drop any food particles or cleaning materials into the burner bases, to avoid the possibility of blocking the gas jets.

If aluminium based pans are used, a silvery deposit may appear on the top edge of the pan support fingers. See 'Care and Cleaning' section for cleaning information.

When the hotplate burners are turned down, a slight 'popping' noise may be heard. This is perfectly normal.

---

# HOTPLATE

---

## **SAFETY REQUIREMENTS FOR DEEP FAT FRYING**

1. Never fill chip pans more than one third full with oil or fat.
2. Never leave oil or fat unattended during the heating or cooling period.
3. Never heat fat or fry with a lid on the pan.
4. Always dry food thoroughly before frying, and lower it slowly into the hot oil or fat. Frozen foods in particular will cause frothing and spitting if added too quickly.
5. Always keep the outside of the pan clean and free from streaks of oil or fat.

## **HOW TO DEAL WITH A FAT FIRE**

1. Do not move the pan.
2. Turn off the hotplate burners.
3. Smother the flames with a fire blanket or damp cloth to extinguish the fire. Do not use water or a fire extinguisher as the force of it may spread the burning fat or oil over the edge of the pan.
4. Leave the pan for at least 60 minutes before moving it.

---

# GRILL

---

**CAUTION – ACCESSIBLE PARTS MAY BECOME HOT WHEN THE GRILL IS USED. YOUNG CHILDREN SHOULD BE KEPT AWAY.**

## **TO USE THE GRILL**

1. Open the grill door and remove the grill pan.
2. Push in and turn the control knob anti-clockwise to the large flame symbol. Press the ignition button until the spark lights the gas.
3. Turn the control knob anti-clockwise to the desired setting. Only turn the control knob between the large flame symbol and the small flame symbol when adjusting the setting.
4. To turn off, turn the control knob fully clockwise to the symbol **O**.

Slide the grill pan along the chosen runner towards the rear of the grill compartment until it stops.

An odour may be noticed when first using the grill. This should cease after a short period of use.

**DO NOT** use the grill with the door closed.

**DO NOT** cover the grill pan or grid with aluminium foil as this can hold fat, intensify the heat and create a fire hazard.

Grilling can be started from cold but for best results preheat for approximately two minutes. Most cooking is done with the heat on full, but it may be necessary after sealing the food to reduce the heat as required.

For au gratin dishes eg. Macaroni Cheese and meringue toppings eg. Baked Alaska, place the dish on the floor of the grill compartment.

The base of the grill pan can be used for warming fruit garnishes on the reduced setting.

**NOTE:** Strong detergents used in dishwashers may damage the grill pan grid finish; clean in soapy water as described in CARE AND CLEANING section.

Always ensure that the grill pan handle is securely fastened to the grill pan. If necessary tighten any loose screws with a screwdriver

## **RELIGHTING THE BURNER**

In the event of the burner flames being accidentally extinguished, turn off the burner control and do not attempt to re-ignite the burner for at least one minute.



---

# OVEN

---

The oven has different heat zones – the thermostat settings refer to the temperature on the middle shelf position; above this shelf it is hotter and below it is cooler. Two shelves provide five possible cooking levels enabling full use of the different temperatures inside the oven.

Each shelf has a safety stop to prevent it from being pulled out too far when attending to food. Shelves are removed from the oven by pulling them out to the stop and then lifting them at the front to withdraw.

The baking dish and grill pan without the handle can be used in the oven. The maximum size of baking tray that should be used is 300mm x 350mm (12" x 14").

## **TO USE THE OVEN**

1. Place oven shelves in the chosen positions (refer to cooking charts).
2. Push in and turn the oven control knob fully anti-clockwise. Press the ignition button until the spark lights the gas.
3. Turn the control knob clockwise to the required setting (refer to cooking chart). There is a delay of about one minute whilst the safety device operates before the burner comes on full.
4. To turn off, turn the control knob fully clockwise to the symbol **O**.

Never place dishes on the oven base over the burner.

An odour may be noticed when first using the oven – this should cease after a short period of use.

## **RELIGHTING THE BURNER**

In the event of the burner flames being accidentally extinguished, turn off the burner control and do not attempt to re-ignite the burner for at least one minute.

---

# OVEN

---

## **COLD START COOKING**

Anything requiring long slow cooking such as casseroles and rich fruit cakes can be put into a cold oven. Satisfactory results can also be obtained with creamed mixture, rich pastries or yeast mixtures, but for perfection we recommend preheating the oven for about 15 minutes.

## **ROASTING OF LARGE POULTRY**

The maximum weight of poultry that can be accommodated is 25 lbs (11.5 kgs) provided it is of suitable shape.

It is important to check that the bird DOES NOT overhang the burner at the back of the oven.

## **STORAGE AND RE-HEATING OF FOOD**

It is vitally important to strictly adhere to the basic principles of food handling and hygiene to prevent the possibility of bacterial growth.

1. If food is to be frozen or not served immediately, cool it in a clean container as quickly as possible.
2. Completely thaw frozen food in the refrigerator before re-heating.
3. Re-heat food thoroughly and quickly either on the hotplate or in a hot oven, Mk. 6, and then serve immediately.
4. Only re-heat food once.

## **'COOK CHILL' DISHES**

These should always be placed in a pre-heated oven ideally on the first or second shelf position. Follow the packet instructions for cooking time.

## **ALUMINIUM FOIL**

If using Aluminium Foil:

1. Remember that it is important to increase the cooking time by one third.
2. Never allow the foil to touch the sides of the oven.
3. Never cover the oven interior with foil.
4. Never cover the oven shelves with foil.

---

## THE 'SLOW COOK' SETTING

---

The 'Slow Cook' setting on the oven thermostat is used for slow cooking, keeping food warm and warming plates for short periods.

### USING THE 'SLOW COOK' SETTING FOR SLOW COOKING

1. All dishes cooked by the 'Slow Cook' setting should be cooked for a minimum 6 hours. They will 'hold' at this setting for a further hour but marked deterioration in appearance will be noticed in some cases.
2. Joints of meat and poultry should be cooked at Mk. 6 for 30 minutes before turning to the 'Slow Cook' setting and never be cooked lower than the middle shelf position.
3. Joints of meat over 6 lbs (2.7kg) and poultry over 4 lbs 8oz (2 kg) should not be cooked using the 'Slow Cook' setting.
4. Always stand covered joints on a rack over the meat tin to allow good air circulation.
5. Pork joints and poultry must be checked for an internal temperature of at least 88°C.
6. This method is unsuitable for stuffed meat and stuffed poultry.
7. Always bring soups, casseroles and liquids to the boil before putting in the oven.
8. Cover casseroles with foil and then the lid to prevent loss of moisture.
9. Always thaw frozen food completely before cooking.
10. Root vegetables will cook better if cut into small pieces.
11. Adjust seasonings and thickenings at the end of the cooking time.
12. Use the zones of heat in the oven, e.g. meringues and milk puddings can be cooked lower in the oven whilst other dishes requiring greater heat can be cooked above them.
13. Egg and fish dishes need only 1-5 hours cooking and should be included in day cooking sessions, when they can be observed from time to time.
14. Dried red kidney beans must be boiled for a minimum of ten minutes after soaking, before inclusion in any dish.

# OVEN COOKING CHART

The following times and setting are for guidance only. You may wish to alter the setting to give a result more to your satisfaction. When a different setting to that shown below is given in a recipe, the recipe instructions should be followed. Allow 15 minutes preheat for best results. Always turn the thermostat knob to Mark 9 before selecting the appropriate Gas Mark. Shelf position 1 is the highest.

Food	Gas Mark	Shelf Positions	Approx. Cooking Time and Comments
<b>STARTERS</b>			
Patés and Terrines	3 or 4	4	1½ - 2 hrs
<b>FISH</b>			
Oily Fish (whole)	4 or 5	3	25 mins - 1 hr, depending on recipe and size of fish
White Fish (fillets & steaks)	4 or 5	3	25 - 30 mins.
<b>MEAT AND POULTRY</b>			
Veal	5	4	25 mins per lb + 25 mins
Beef	4 or 5	4	25 - 30 mins per lb + 25 mins
Ham	5	4	40 mins per lb covered in foil + 40 mins per lb uncovered
Lamb	5	4	30 - 35 mins per lb + 30 mins
Pork	5	4	40 mins per lb + 40 mins
Chicken	5	4	25 mins per lb + 25 mins
Duckling & gosling	5	4	25 mins per lb + 25 mins
Turkey	4 or 5	4 or 5	15 - 20 mins per lb + 20 mins
Game birds	6	4	50 mins. Remove bacon for last 15 mins. Add extra 15 mins if roasting brace
Casseroles	3	3 or 4	1½ - 6 hrs. (depending on type of meat)
<b>PUDDINGS</b>			
Milk Puddings	3	3 or 4	2¼ - 2½ hrs on a baking tray and started with warm milk
Baked Custard	3	3 or 4	45 mins in bain-marie
Baked sponges	4	3	40 - 50 mins
Baked Apples	3	4	30 - 45 mins depending on the size and type of apples
Meringue puddings	1	4 or 5	15 mins or until 'tinged' with brown
Apple Pie 1x9" (230mm)	6	3	45 - 55 mins on a baking tray
Fruit crumbles	5 or 6	3	35 - 45 mins

If using aluminium foil:

1. Remember it is important to increase the cooking time by one third.
2. Never allow the foil to touch the sides of the oven.
3. Never cover the oven interior with foil.
4. Never cover the oven shelves with foil.

# OVEN COOKING CHART

Food	Gas Mark	Shelf Positions	Approx. Cooking Time and Comments
<b>CAKES, PASTRIES AND BISCUITS</b>			
Small cakes - 2 trays	5	2 & 4	17 - 25 mins
- 1 tray	5	2 or 3 only	"
Victoria sandwich 2x8" (205mm)	4	2 & 4	25 - 35 mins
Fatless sponge 2x7" (180mm) - 3 egg mix	5	2	20 - 25 mins. 2 tins side by side
Christmas cake	2	3 or 4	4 - 6½ hrs depending on recipe
Madeira cake 7" (180mm)	4	3	1¼ - 1½ hrs
Rich Fruit cake 9" (230mm)	2	3	3 - 3½ hrs.
Shortcrust pastry	6	2 or 3	15 mins - 1 hr depending on recipe
Rich Shortcrust pastry - 1 tray	5	2	20 - 40 mins depending on recipe
Flaky & puff pastry - 2 trays	7	1 & 3	10 - 30 mins depending on recipe
- 1 tray		2 or 3	" " " "
Choux pastry - éclairs 1 tray	6	2	35 - 40 mins
Scones - 2 trays	7	2 & 4	10 - 15 mins
- 1 tray		2 or 3	"
Shortbread - 7" (180mm) round	2	4	55 - 1hr depending on thickness
Biscuits - 2 trays	4	1 and 3	15 - 20 mins depending on recipe
- 1 tray		2 or 3	" " " "
<b>YEAST MIXTURES</b>			
Bread	7 or 8	3 or 4	45 - 50 mins
Rolls	7 or 8	2 or 3	15 - 20 mins
Chelsea buns	5	2 or 3	30 - 40 mins
<b>MISCELLANEOUS</b>			
Yorkshire Pudding - large	7	1 or 2	45 - 50 mins
- individual	7	1 or 2	25 - 30 mins
Soufflés	4	3	30 mins
Meringues	Slow Cook	4 & baseplate	2 - 5 hrs starting on shelf 4 until 'set' and then on the baseplate until dried out - turn when necessary.
Baked Potatoes	4 or 5	3	1½ - 3 hrs until soft, depending on size

When baking with two trays or tins on two levels, the top tray is removed first and the lower tray moved up to the top position for a few minutes longer.

**Soft Margarine** – Use the oven settings recommended by the margarine manufacturer and **not** those indicated on the cooking chart.

---

## CARE AND CLEANING

---

**Clean the cooker regularly and wipe up spills soon after they occur to prevent them from becoming burnt on. Never use biological washing powder, caustic cleaners, harsh abrasives, scouring pads, aerosol cleaners or oven chemical cleaners of any kind.**

To move the cooker forward, open the grill door and with both hands positioned under the roof of the compartment lift and pull forward. Replace by pushing the cooker backwards. Check that the cooker is level. Take care to ensure that any floor covering is not damaged.

### **OVEN HEAT CLEAN LININGS**

The oven roof, back and side linings are coated with a special enamel which has a continuous cleaning action. The higher the oven temperature the more effective the action. In most cases this cleaning operation will proceed during normal cooking. However, if high temperatures are not used regularly, it may be necessary to run the oven empty at Mark 8 for a couple of hours.

If desired, they can be wiped over with a soapy cloth followed by a wipe with a clean damp cloth.

### **OVEN DOORS**

The inner glass panel can be removed for easy cleaning. Unscrew the two screws securing the glass panel, taking care not to allow the glass to fall. The glass panel can then be washed at the sink. Refit the glass panel according to the instructions printed on the glass.

### **REPLACING A BATTERY**

The battery is not covered by the guarantee. Use an alkaline AA battery. The battery holder is located in the plinth panel below the oven door. Open the oven door fully. Press the tag on the left hand side of the battery holder/cover and withdraw it just enough to get access to the battery. Fit the new battery with the end marked "+" on the same side of the battery holder as the red lead. Replace the battery holder by pushing it firmly into the hole in the plinth.

## CARE AND CLEANING

COOKER FINISH	CLEANING METHOD
<p><b>Vitreous Enamel</b> Hotplate, pan supports, burner caps, roasting dish, grill pan, oven base, inside of grill compartment, inside of doors.</p>	<p>Cloth wrung out in warm soapy water. Stubborn stains can be removed with a cream paste, liquid cleaner or by rubbing with fine steel wool soap pads. Check that the cleaning agent is approved by the Vitreous Enamel Association.</p>
<p><b>Paint</b> Side trims, plinth, door bottom trims, side panels, door handles, lid rear trim.</p>	<p>Wash with a cloth wrung out in warm soapy water only. <b>DO NOT USE ABRASIVES.</b></p>
<p><b>Aluminium</b> Hotplate side trims, hotplate burner bodies, lid rear trim, rear flue grille.</p>	<p>Similar to paint cleaning above. Use a nylon brush to remove any cleaning materials, water or dirt from the hotplate burner bodies.</p>
<p><b>Glass</b></p>	<p>As for enamel cleaning. Polish with a clean dry cloth or kitchen roll.</p>
<p><b>Chromium Plating</b> Oven shelves, grill pan grid, grill pan handle support</p>	<p>Wipe with a cloth wrung out in warm soapy water. A fine steel wool soap pad e.g. Brillo, Ajax, or a chrome or stainless steel cleaner may be used.</p>
<p><b>Plastic</b> Grill pan handle, control knobs</p>	<p>Wipe with a cloth wrung out in warm soapy water. Stubborn stains can be removed with a cream cleaner.</p>

# SOMETHING WRONG WITH YOUR COOKER

**Before calling a Service Engineer, please check through the following lists.  
THERE MAY BE NOTHING WRONG.**

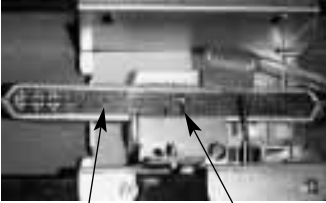
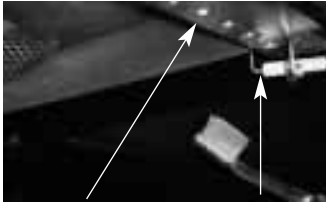
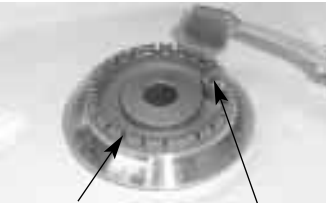
Problem	Check
<p><b>Ignition does not work.</b></p> <p style="text-align: center;">Oven burner</p>  <p style="display: flex; justify-content: space-around; margin-top: 5px;"> <span>Burner ports</span> <span>Ignitor</span> </p>	<p><u>If all burners fail to ignite:</u> Check that sparks appear at the burners; a clicking noise should be heard.</p> <p>If not</p> <p>Check the battery, or fit a known good battery to the product. Batteries are not covered by the guarantee. The battery is easily changed - see the section on battery replacement. (An "AA" size alkaline battery should be used).</p> <p><u>If only one burner fails to ignite:</u></p> <p>Check that the burner is dry and that spillage of food or cleaning fluid remains are not affecting the ignitor or burner ports. Clean away any debris with a dry nylon brush such as an old toothbrush. If a wire wool pad has been used for cleaning around the burner ensure the ignitor is free from any stray strands. Any water on the burner should be dried with a cloth or kitchen towel.</p>
<p style="text-align: center;">Grill burner</p>  <p style="display: flex; justify-content: space-around; margin-top: 5px;"> <span>Burner ports</span> <span>Ignitor</span> </p>	
<p style="text-align: center;">Hotplate burner.</p>  <p style="display: flex; justify-content: space-around; margin-top: 5px;"> <span>Burner ports</span> <span>Ignitor</span> </p>	
<p>On the hotplate make sure that all the burner parts are correctly seated.</p>	



# SOMETHING WRONG WITH YOUR COOKER

**Before contacting your Service Centre or Installer, check the guide below, there may be nothing wrong with your cooker.**

<b>Problem</b>	<b>Check</b>
Slight odour or small amount of smoke when grill / oven used for the first time	This is normal and should cease after a short period.
Oven cooks too fast or too slow	Check that the gas mark and shelf positions are as recommended in the Oven Cooking Charts. However, it may be necessary to increase or decrease the recommended setting slightly to suit your taste.

## **DISPOSAL OF YOUR PRODUCT**

To minimise the risk of injury to children please dispose of your product carefully and safely. Remove all doors and lids (where fitted). Remove the mains cable (where fitted) by cutting off flush with the appliance and always ensure that no plug is left in a condition where it could be connected to the electricity supply.

To help the environment Local Authority instructions should be followed for the disposal of your product.

---

# INSTALLATION INSTRUCTIONS

---

Prior to installation, ensure that the local distribution conditions (nature of the gas and gas pressure) and the adjustment conditions are compatible. The adjustment conditions for this appliance are stated on the data badge which is fitted to the back panel.

This appliance is not designed to be connected to a combustion products evacuation device. It must be installed and connected in accordance with current installation regulations. Particular attention should be given to the relevant requirements regarding ventilation.

## **MODEL NUMBERS 10530G, 10532G, 10535G and 10538G**

Category I<sub>2H</sub> (GB, IE)

These models are set to burn NATURAL GAS (G20) at 20 mbar ONLY and cannot be used on any other gas.

## **MODEL NUMBERS 10531G and 10536G**

Category I<sub>3+</sub> (GB, IE)

These models are set to burn PROPANE GAS (G31) at 37 mbar or BUTANE GAS (G30) at 28 - 30 mbar.

## **GAS SAFETY (INSTALLATION & USE) REGULATIONS**

It is the law that all gas appliances are installed by competent persons in accordance with the current edition of the above regulations. It is in your interest and that of safety to ensure compliance with the law.

In the UK, CORGI registered installers work to safe standards of practice.

The cooker must also be installed in accordance with BS 6172.

Failure to install the cooker correctly could invalidate the warranty liability claims and could lead to prosecution.

## **LOCATION**

The cooker may be located in a kitchen, kitchen/diner or a bed-sitting room, but not in a room containing a bath or shower. The cooker must not be installed in a bed-sitting room of less than 20m<sup>3</sup>.

LPG Models must not be installed in a room or internal space below ground level, eg. in a basement.

## **PROVISION FOR VENTILATION**

The room containing the cooker should have an air supply in accordance with BS 5440:Part 2.

The room must have an opening window or equivalent; some rooms may also require a permanent vent. If the room has a volume between 5 and 10m<sup>3</sup>, it will require an air vent of 50 cm<sup>2</sup> effective area unless it has a door which opens directly to outside. If the room has a volume of less than 5m<sup>3</sup>, it will require an air vent of 100 cm<sup>2</sup> effective area. If there are other fuel burning appliances in the same room, BS 5440: Part 2 should be consulted to determine air vent requirements.

# INSTALLATION INSTRUCTIONS

## TECHNICAL DATA

### DIMENSIONS

Height to hotplate	895 - 910mm
Height overall	900 - 915mm
Width	538mm
Depth	600mm (excluding door handles and control knobs).

### GENERAL

Gas connection	Rp 1/2 (1/2" BSP female)
Pressure test point	Grill injector
Gas rate adjustment	None
Aeration adjustment	None
Battery	1.5V Alkaline AA

BURNER	Natural Gas		L.P.G.	
	HEAT INPUT	INJECTOR	HEAT INPUT	INJECTOR
HOTPLATE Front left and rear right	3.0 kW	134	3.0 kW (220g/h)	90
HOTPLATE Front right and rear left	1.8 kW	109	1.8 kW (130g/h)	72
GRILL	3.9 kW	150	3.3 kW (240g/h)	95
OVEN	2.7 kW	120	2.4 kW (175g/h)	75

# INSTALLATION INSTRUCTIONS

## SPACE FOR FIXING

The cooker can be close fitted below hotplate level. This requires a minimum distance of 540mm between cupboard units of hotplate height.

When installing next to a tall cupboard, partition or wall, for a minimum distance of 400mm above hotplate level, allow a side clearance of at least 65mm.

The diagram below illustrates the minimum clearance between the cooker and adjacent walls, cupboards etc.

The wall behind the cooker between the hotplate and 450mm above, and the width of the cooker, must be a non-combustible material such as ceramic wall tiles.

If the cooker is to be fitted close to a corner on the left hand side, ensure that there is a clearance of at least 50mm to allow the main oven door to open fully for when removing oven shelves.

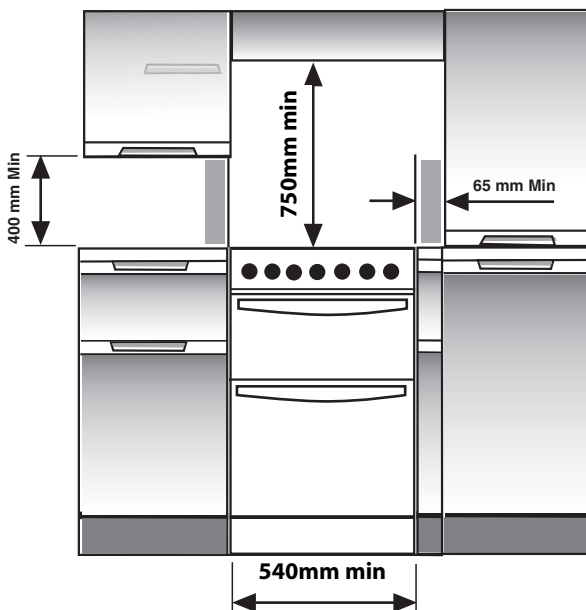

## COOKER HOODS

If a cooker hood is to be installed, refer to the cooker hood manufacturers' instructions regarding fixing height.

---

## UNPACKING

Unpack the components from inside the grill and oven: Check that the following parts are present.

Grill pan and grid  
Meat tin  
Oven shelves (2)  
Battery

Pan supports (4)  
Enamelled burner caps (4)  
Literature pack  
Aluminium burner bodies (4)

## LEVELLING

Four skid feet are fitted which can be screwed in or out to level the cooker. Move the cooker by pushing at both sides on the lower half of the oven door.

**CAUTION:** Some soft floor coverings may get damaged if the cooker is not moved carefully.

## STABILITY BRACKET

The back of the cooker has a slot for engagement of a stability bracket, which can be obtained, as an extra, from the cooker supplier. The leaflet included with the bracket should be read in conjunction with the following instructions.

Push cooker to its intended position.

Draw pencil lines on the floor in line with the front and left side of the plinth.  
Remove the cooker.

Position stability bracket in accordance with Fig. 5 and secure to the floor.

Measure height from floor level to the bottom of the slot in the back of the cooker.

Add 3mm to the dimension and assemble the stability bracket to that height.  
(i.e. from floor level to the underside of the top member)

Fig. 5

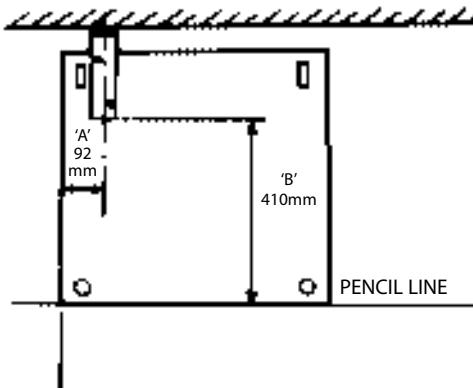
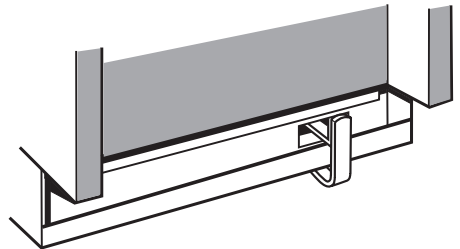
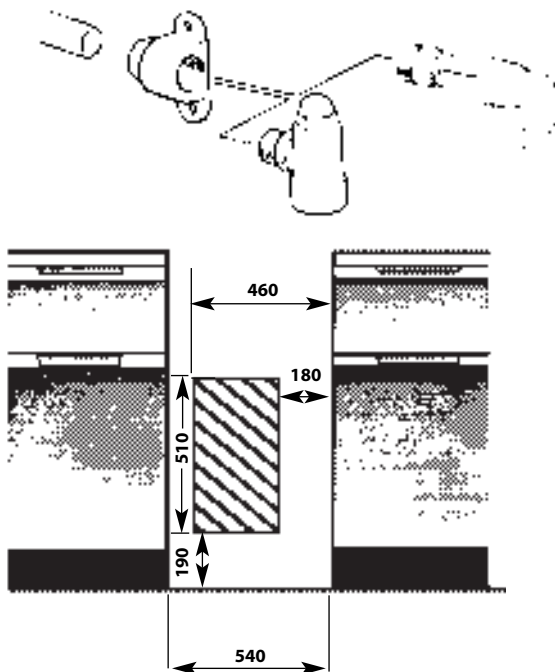

Fig. 6



## CONNECTING TO GAS SUPPLY

The cooker is designed to match the depth of standard 600mm worktops. An adaptor backplate should, therefore, be fitted within the shaded area shown to allow the cooker to be pushed fully to the wall. If a forward facing backplate is used, it must be chased into the wall.



Connection to the cooker should be made with an approved appliance flexible connection to BS 669. LPG cookers should be connected with a hose suitable for LPG and capable of withstanding 50 mbars pressure. A length of 0.9 to 1.25m is recommended. The length of hose chosen should be such that when the cooker is in situ, the hose does not touch the floor.

The temperature rise of areas at the rear of the cooker that are likely to come in contact with the flexible hose do not exceed 70°C.

# INSTALLATION INSTRUCTIONS

## INSTALLATION AND OPERATIONAL CHECKS

After installation, check for gas soundness. The supply pressure can be checked at the grill injector. Access to the injector is by first removing the baffle at the front of the grill fastened by two screws. Then remove the fastening screw on the right hand side of the burner and slide the burner off the injector. Ensure that the grill burner is correctly located under the fixing screw on reassembly.

Fit the battery. Fit the hotplate burner bodies and caps and pan supports. Referring to the instructions for use where necessary,

1. Check that the hotplate and grill burners ignite correctly and burn with a steady flame. Check for a steady flame on the low setting.
2. Check that with the oven set to mark 9, the burner ignites at low rate, and then increases to full rate within 60 seconds. Leave the oven full on with the door closed for 10 minutes, and check that when the control is turned to the 'Slow Cook' setting that the flame reduces.

Instruct the user on the operation of the cooker.

**NOTE:** On the models manufactured for use with LPG, it is normal for the oven and grill burners to burn with yellow tips.

# ***Key Contacts***

## ***Service***

We have the largest appliance manufacturer's service team in Europe, trained specialists directly employed by us to ensure your complete confidence.

## ***Repair Service***

***UK: 08709 066 066***

***Republic of Ireland: 1850 302 200***

You will be asked for the following information:-

Name, address and postcode.

Telephone number

Model / Serial number of the appliance

Clear and concise details of the query or fault

Place and Date of purchase

(Please keep the receipt as evidence will be required when the engineer calls).

## ***Extended Warranty***

***To join: UK 08709 088 088***

***Republic of Ireland: 1850 502 200***

## ***Genuine Parts & Accessories***

### ***Mail Order Hotline***

***UK: 08709 077 077***

***Republic of Ireland: (01) 842 6836***

For further product information 01782 385516



All Cannon Services are offered as an extra benefit and do not affect your statutory rights.  
General Domestic Appliances Limited, Morley Way, Peterborough, PE2 9JB



## Free Manuals Download Website

<http://myh66.com>

<http://usermanuals.us>

<http://www.somanuals.com>

<http://www.4manuals.cc>

<http://www.manual-lib.com>

<http://www.404manual.com>

<http://www.luxmanual.com>

<http://aubethermostatmanual.com>

Golf course search by state

<http://golfingnear.com>

Email search by domain

<http://emailbydomain.com>

Auto manuals search

<http://auto.somanuals.com>

TV manuals search

<http://tv.somanuals.com>