

CANNON 

KENDAL

CONTENTS

	PAGE
Introduction	3
Installation	4
Safety Information	5-6
Features	7
The Controls	8-9
The Timer	10-15
Temperature Conversion Chart	16
Use and Care of the Ceramic Hob	17-19
High Speed Grilling	20-21
Top Oven - Conventional Cooking	22
Cooking Temperature Charts	23-24
Main Oven - Fan Cooking	25
Slow Cooking - Main Oven	26
Care and Cleaning	27-30
Something wrong with your Cooker	31-32
Key Contacts	36

Retention of this Instruction Book

This Instruction Book must be kept handy for reference as it contains important details on the safe and proper use of the appliance.

If you sell or pass the appliance to someone else, or move house and leave it behind, make sure this Book is also provided so the new owner can become familiar with the appliance and safety warnings.

INTRODUCTION

Your new appliance is guaranteed* and will give lasting service. This guarantee is only applicable if the appliance has been installed in accordance with the installation instructions detailed in this booklet. To help make best use of your cooking equipment, please read this booklet carefully. The cooker is designed specifically for domestic use and responsibility will not be accepted for use in any other installation.

When the cooker is first used an odour may be emitted, this will cease after a period of use

When first using the cooker ensure that the room is well ventilated (e.g. open a window or use an extractor fan) and that persons who may be sensitive to the odour avoid any fumes.

It is suggested that any pets be removed from the room until the smell has ceased. This odour is due to temporary finish on oven liners and elements and also any misture absorbed by the insulation.

*** The guarantee is subject to the provisions that the appliance:**

- (a) **Has been used solely in accordance with the Users Instruction Book.**
- (b) **Has been properly connected to a suitable supply voltage as stated on the rating plate attached to this equipment.**
- (c) **Has not been subjected to misuse or accident or been modified or repaired by any person other than the authorised employee or agent.**
- (d) **Has been correctly installed.**

This appliance conforms to the following EEC directives:

Electromagnetic Compatibility; Low Voltage Equipment

- 89/336/EEC

- 2006/95/EEC

- 92/31/EEC

- 93/68/EEC

- 93/68/EEC



Technical Characteristics

Top Oven

Usable Volume: 35 Litres

ENERGY LABEL - Top Oven

Directive 2002/40/EC on the label of electric ovens

Norm EN 50304

Declared energy consumption for

Natural convection Class

heating mode: Conventional

Main Oven

Usable Volume: 65 Litres

ENERGY LABEL - Main Oven

Directive 2002/40/EC on the label of electric ovens

Norm EN 50304

Declared energy consumption for

Natural convection Class

heating mode: Fan Oven

Voltage and Frequency

230-240V~ 50Hz

INSTALLATION

WARNING - THIS APPLIANCE MUST BE EARTHED.

Mains Connection

Your cooker should have been checked to ensure that the voltage corresponds with your supply voltage, this is stated on the rating plate, which is situated on the outer rear panel.

The model number and serial number are located on the front of the cooker, as shown on the Feature's page.

The cooker must be connected by a competent person such as one who is a, NICEIC registered contractor to a suitable double-pole control unit with a minimum rating of 32A and a minimum contact clearance of 3mm (applicable to newer properties, older properties where a 30A double pole control unit and a minimum contact clearance of 3mm is acceptable).

The double pole control unit should be fitted adjacent to the cooker, in accordance with IEE regulations. The control unit must be within 2 metres of but not directly above the appliance and should be easily accessible in the event of an emergency.

The power supply cable should conform to B.S.6004 with a conductor size of 6mm², minimum.

Access to the mains terminals is gained by removing the rear access cover. The mains cable must pass through the cable clamp adjacent to the terminal block. Sufficient cable should be used to allow the cooker to be pulled out for servicing.

Ensure that the mains cable is routed away from any brackets affixed to the rear panel and is not trapped to the rear wall when pushing the cooker into position between cabinets.

Levelling

Four feet are fitted which can be adjusted up or down to set the height (900mm - 930mm) and level the cooker.

The feet can be simply screwed in or out to lower or raise the cooker.

After the correct height is achieved, lock the feet into position by tightening the locking nut using an open ended spanner.

CAUTION: Some soft floor coverings may get damaged if the cooker is not moved carefully.

NOTE: Ensure oven shelves are level by using a spirit level on the rod shelves.

Siting the Cooker

The cooker is designed to fit between kitchen cabinets spaced 600mm apart. The space either side need only be sufficient to allow withdrawal of the cooker for servicing and cleaning.

It can be used with cabinets one side or both as well as in an angled corner setting. It can also be used freestanding.

Adjacent side walls which project above hob level, must not be nearer to the cooker than 150mm and should be protected by heat resistant material. Any overhanging surface or cooker hood should not be nearer than 650mm.

Note: This appliance must NOT be fitted on a platform.

Moving the Cooker

Before moving your cooker, switch off at the cooker control unit, ensure that it is cool.

Open the grill door sufficiently to allow a comfortable grip on the underside front edge of the oven roof, avoiding any grill elements.

Radio Interference

This appliance conforms to EN 55014 regarding suppression of radio and television interference.

Note: Take care in moving the cooker as it is heavy. Take care to ensure that any floor covering is not damaged.

SAFETY INFORMATION

**When used properly your appliance is completely safe but as with any electrical product there are certain precautions that must be observed.
PLEASE READ THE PRECAUTIONS BELOW BEFORE USING YOUR APPLIANCE.**

Always

- Remove all packing from the appliance before switching on for the first time.
- Understand the controls prior to using the appliance.
- Keep children away from the appliance when cooking as the surfaces will get extremely hot during and after use.
- Turn controls **off** when not in use.
- Stand back when opening an oven door to allow any build up of steam or heat to disperse.
- Always use dry good quality oven gloves when removing items from the oven/grill.
- Always place pans centrally over the hotplate making sure handles are kept away from the edge of the hob and cannot become heated by other hotplates or pans.
- Always take care to avoid heat or steam burns when operating the controls.
- Always turn off the electricity supply at the wall switch and allow the appliance to cool before cleaning (or changing an oven lamp if fitted).
- Always make sure the shelves are in the correct position before switching on the oven or grill.
- Always keep the oven/grill door closed when the appliance is not in use.
- Always keep the appliance clean as a build up of grease or fat from cooking can cause a fire.
- Always follow the basic principles of food handling and hygiene to prevent the possibility of bacterial growth.
- Always keep ventilation slots clear of obstructions.
- Always refer servicing to a qualified appliance service engineer.
- Always take care when removing items from the grill compartment when the lower oven is in use as the contents will be hot.
- Always turn off the electricity supply to the appliance at the wall switch should any glass panel (if fitted) crack or shatter and then **DO NOT USE THE APPLIANCE** until repaired.
- During use, the oven becomes hot. Care should be taken to avoid touching heating elements inside the oven.

SAFETY INFORMATION

Never

- Never stare at Halogen heating units.
- Never leave children unsupervised where a cooking appliance is installed as all surfaces will be hot during and after its use.
- Never allow anyone to sit or stand on any part of the appliance.
- Never store items above the appliance that children may attempt to reach.
- Never leave anything on the hob surface when unattended and not in use.
- Never remove the oven shelves whilst the oven is hot.
- Never heat up unopened food containers as pressure can build up causing the container to burst.
- Never store chemicals/food stuffs or pressurised containers in or on the appliance, or in cabinets immediately above or next to the appliance.
- Never place flammable or plastic items on or near the hob.
- Never fill a deep fat frying pan more than 1/3 full of oil, or use a lid. **DO NOT LEAVE DEEP FAT FRYING PANS UNATTENDED WHILE COOKING.**
- Never use the appliance as a room heater.
- Never use the grill to warm plates.
- Never dry any items on either the hob or oven doors.
- Never install the appliance next to curtains or other soft furnishings.
- Never operate the grill with the grill door closed as this will cause the appliance to over heat.
- Never use 'steam cleaners'.

SAFETY ADVICE IN CASE OF A CHIP-PAN FIRE

In the event of a chip pan fire or any other pan fire.

1. TURN OFF THE COOKER APPLIANCE AT THE WALL SWITCH.
2. COVER THE PAN WITH A FIRE BLANKET OR DAMP CLOTH, this will smother the flames and extinguish the fire.
3. LEAVE THE PAN TO COOL FOR AT LEAST 60 MINUTES BEFORE MOVING IT. Injuries are often caused by picking up a hot pan and rushing outside with it.

NEVER USE A FIRE EXTINGUISHER TO PUT OUT A PAN FIRE as the force of the extinguisher is likely to tip the pan over.

Never use water to extinguish oil or fat fires.

! The appliance should not be operated by people (including children) with reduced physical, sensory or mental capacities, by inexperienced individuals or by anyone who is not familiar with the product. These individuals should, at the very least, be supervised by someone who assumes responsibility for their safety or receive preliminary instructions relating to the operation of the appliance.

FEATURES

WARNINGS: DO NOT TOUCH THE OVEN DOORS WHEN THE OVEN IS IN USE AS THESE AREAS CAN BECOME HOT.

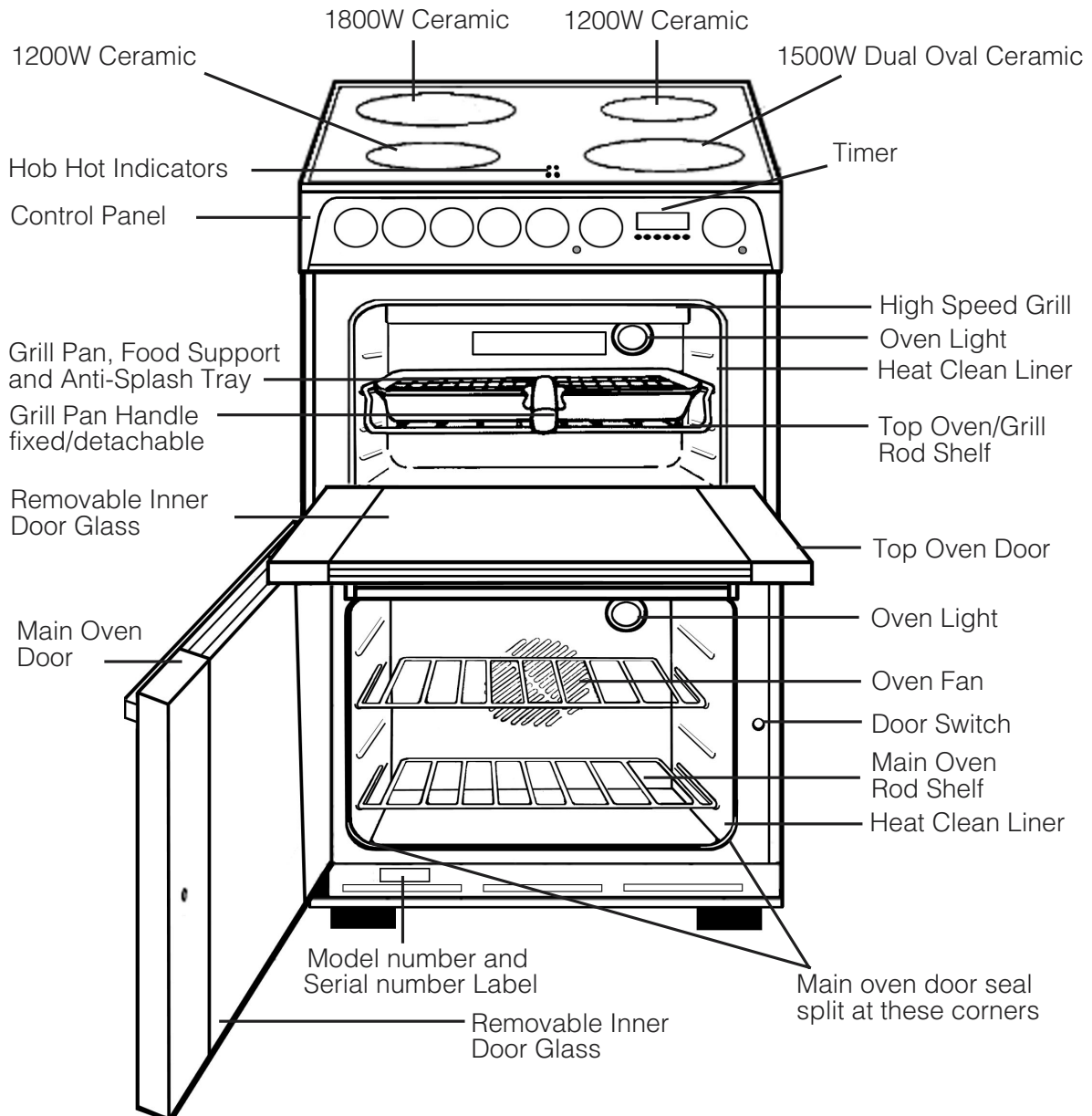

NOTE: To keep the controls cool when the appliance is used, a gentle flow of air may be blown from beneath the control panel. If the appliance is still warm, this cooling fan may run on or restart itself when all controls have been turned off.

This is normal and is not a fault.

The fan will stop once the appliance has cooled.

NOTE: Children should not be allowed to play with the appliance or tamper with the controls.

THE CONTROLS

Switch on the electricity supply to the cooker at the Cooker Control Unit.

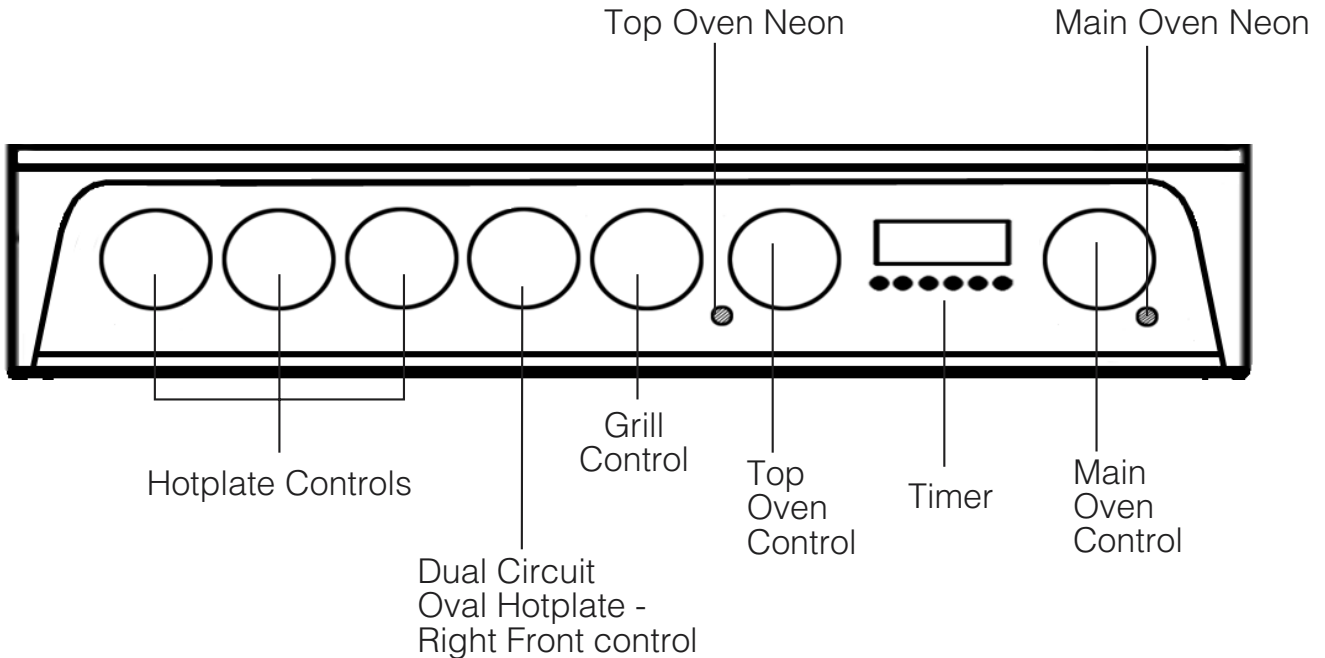

Hotplate Controls

As each control knob is turned clockwise, numbers from 1 - 6 on the control knob increase. Setting 6 is the highest/hottest and gives 100% power. Setting 1 is the lowest/coolest and gives about 7% power. Variable power is obtainable on each of the heating areas by selecting any number between 1 & 6.

Right Front Control

This is to control a dual circuit oval hotplate with two elements. By turning the knob clockwise both parts of the hotplate are switched on, numbers 1-4 on the control knob, 4 is the highest setting. With the knob turned anti-clockwise, only the inner part of the hotplate is switched on, this is also indicated by numbers 1-4 on the control knob, 4 is the highest setting. Variable power for either the whole or the inner part of the hotplate is obtained by selecting any number between 1 & 4.

The off position is identified by an '0'.

The hob hot warning lights will operate soon after each of the heating areas have been switched on. Each warning light will remain illuminated until each heating area has cooled down.

Grill Control-Top Oven

The grill control will not operate unless the top oven control is in the '0' off position. The grill control provides fully variable heat control for either the twin grill or single (left hand side) grill by selecting any number between 1 & 4. When turned clockwise the twin grill will be switched on and any power setting from 1 - 4 can be selected. The power level numbers are indicated on the control knob. When turned anti-clockwise the single grill will be switched on and any power setting from 1 - 4 can be selected. The power level numbers are indicated on the control knob. The off position is identified by an '0'.

Top Oven Control

This control switches on the top and bottom heating elements in the top oven. The temperature in the oven can be set anywhere between 100°C and 220°C. The red thermostat light will glow initially and remain on until the oven reaches the required temperature. It will then cycle off and on, as the oven thermostat maintains the correct temperature. The off position is identified by an '0'.

Main Oven Control

This control switches on the main oven. To select Fan Cooking - Turn the control clockwise and select any temperature between 80°C and 230°C. As the control is turned the fan will start, the oven interior light and the red main oven thermostat light will come on and the heating element around the fan will start heating. The fan and the oven interior light will remain on throughout cooking. The red main oven thermostat light will come on until the oven reaches the required temperature. It will then cycle off and on as the oven thermostat maintains the correct temperature.

Notes

1. Never operate both the top oven control and the grill control together. The grill will not operate unless the top oven control is in the '0' off position.
2. If the main oven does not switch on when the control is turned, check that the Timer is in manual operation.

Slow Setting 'S'

The main oven has an Economy setting to select. Turn the main oven control to the Slow Setting 'S'.

NOTE: Slow Cooking can be cooked automatically (see Timer instructions).

OVEN TIMER OPERATION

Note: Timer must be set to 'Time of Day' and 'Manual' before the oven can be used.

AUTOMATIC COOKING

The Main Oven can be controlled by the Automatic Timer.

HINTS ON AUTOMATIC COOKING

1. Select foods which will require the same cooking time and temperature.
2. To ensure food does not cool down and require reheating, set the end time so the food is ready when you require it.
3. Always ensure that meat and poultry is defrosted before placing in the oven.
4. Whenever possible, take food out of the refrigerator and keep it as cool as possible.
5. If cooking food that requires frying before placing in the oven for automatic cooking, keep the delay time to a minimum.
6. Never place hot or warm food in the oven for delay start cooking as it could cause the oven to be warm and produce harmful bacteria in the food.
7. We advise that dishes containing left-over cooked poultry or meat, e.g. Shepherd's Pie, should not be cooked automatically if there is to be a delay period.
8. Ensure that delay start times are kept to a minimum to prevent bacterial growth in food.
9. Wine or beer may ferment and cream may curdle during the delay period so it is best to add these ingredients just before serving.
10. Foods which discolour should be protected by coating in fat or tossing in water to which lemon juice has been added, prior to placing food in the oven.
11. Dishes containing liquid should not be filled too full to prevent boiling over.
12. Food should be well sealed (but not airtight) in a container to prevent the loss of liquid during cooking. Aluminium foil gives a good seal.
13. Always ensure that food is piping hot and cooked thoroughly before serving.
14. Only reheat food once.

KNOW YOUR TIMER



CLOCKFACE

The timer incorporates a 24 hour clock.

Ensure the correct time of day is always set, before using your cooker.

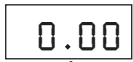

SYMBOLS

A 'bell' symbol will light up when you select a Minute Minder Period and will remain lit for the period set.

At the end of the Minute Minder Period, the timer will emit an audible tone and the 'bell' symbol will disappear.

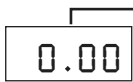

The 'cookpot' symbol will light up either:-

- When the timer is in manual mode, or
- During the actual Cook Period.

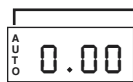

'AUTO' will light up:-

- When the timer is first turned on it will flash. It will go out when a time of day is set or when the timer is set to manual.

The 'AUTO' symbol will flash at the end of an Auto Cooking programme to indicate that the programme has finished.



(When the 'AUTO' symbol is flashing, to return the oven to Manual operation, turn the oven controls off, ensure that the correct time of day is set, and press the "Manual" button - The 'AUTO' symbol will go out).

TIMER FUNCTION BUTTONS

Minute Minder Button

Here you can set a time period of up to 23 hours 59 minutes, that will count down. When it reaches zero, the timer will emit an audible tone.

For Example: If you set 20 minutes, the audible tone will occur 20 minutes later.

AUTO COOKING PROGRAMME

Cook Period Button

Cook Period is the actual length of time for which, the timer will switch the oven(s) on as part of an "Auto Cooking" programme. (e.g. If you set 2 hours, the food will be cooked for 2 hours).

End Time Button

The time of day at which you want an "Auto Cooking" programme to end.

For Example: If you set a "Cook Period" for 2 hours, and "End Time" of 11:00. The timer will switch the oven(s) on at 9:00 and turn the oven(s) off at 11:00. You will hear a audible tone at 11:00, to indicate that the Auto Cooking Programme has finished.

Notes:

- When setting an Auto Cooking programme you will need to set the oven control(s) to the required temperature(s) when you set the timer.
- If an Auto Cooking programme has been set the oven(s) will only operate during the pre-programmed time.

Manual Button

Needs to be pressed to cancel an Auto Cooking programme and return the oven(s) to Manual operation.

"+" and "-" Buttons

Used to adjust the various timer function settings.

ELECTRONIC CLOCK & AUTOMATIC OVEN

TIMER OPERATION

SETTING THE TIME OF DAY

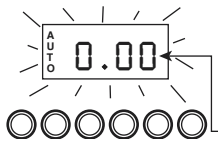

Step 1 Make sure all oven controls are turned Off.

Step 2 Check the electricity supply to the cooker is turned on.

Step 3 When switched on the display will show 0.00 and the Auto symbol, flashing intermittently.

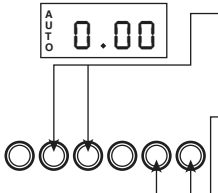

Step 4 Press & hold in both the Cook Period & End Time buttons together.

Step 5 With the Cook Period & End Time buttons still held in, press either the "+" or "-" buttons to set the correct time of day.

Step 6 Release all the buttons simultaneously. THE TIME OF DAY IS NOW SET.

To change the time of day repeat Steps 4, 5 & 6 above.

Note: You cannot adjust the time of day if the timer has been set for an Auto Cooking Programme.

SETTING THE MINUTE MINDER

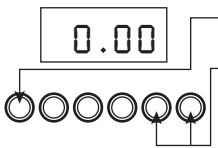

Step 1 Ensure the time of day is set correctly.

Step 2 Press and hold the Minute Minder button.

Step 3 With the Minute Minder button held in, set the required Minute Minder period using the "+" and "-" buttons. A 'bell' symbol will light up.

Release all buttons and the timer display will revert back to the time of day. The 'bell' symbol will remain lit to signify that a Minute Minder period has been set.

At the end of the set time an audible tone will be heard, and the 'bell' symbol will disappear.

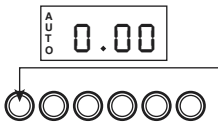

Step 4 To cancel the audible tone press the Minute Minder button.

Note 1 When the Minute Minder has been set, the time remaining can be checked at any time by simply pressing the Minute Minder button.

Note 2 If necessary the Minute Minder can be cancelled before the tone sounds by pressing and holding the Minute Minder button and then at the same time pressing the "-" button until 0.00 appears in the display window.

ELECTRONIC CLOCK & AUTOMATIC OVEN

TIMER OPERATION

AUTO COOKING PROGRAMMES

There are two Auto Cooking programmes that can be selected using your timer:-

- (a) To set the timer to switch the oven(s) On and Off Automatically
- (b) To set timer to switch on immediately and OFF automatically after a set cook period.

a) TO SET THE TIMER TO SWITCH THE OVEN(S) ON AND OFF AUTOMATICALLY

This allows you to cook at a specified time for a chosen period before the oven switches off Automatically.

Step 1 Check that the correct time of day is set, if not follow instructions for setting the time of day.

Step 2 Place food onto the correct shelf position in the oven and close the oven door(s).

Step 3 Press and hold in the Cook Period button. The display will read 0.00 with the 'cookpot' symbol lit.

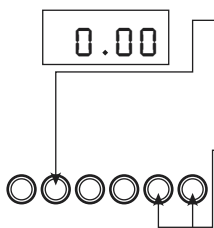

Step 4 With the Cook Period button still held in, set the required Cook Period using the "+" and "-" buttons.

Release the buttons and the timer display will revert to the time of day with the 'Auto' symbol and 'cookpot' symbol lit.

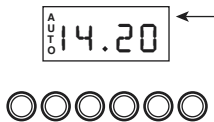

Step 5 Press and hold in the End Time button. The display will read the earliest possible end time for the Cook Period that you have set above. The 'Auto' symbol and 'cookpot' symbol will be lit.

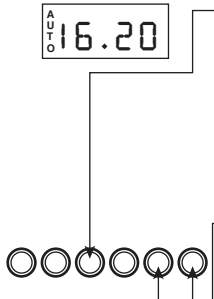

Step 6 With the End Time button still held in, use the "+" and "-" buttons to set the 'End Time' (i.e. The time you require the oven to switch off). Release all the buttons and the timer will revert back to the time of day.

The 'Auto' symbol will remain lit to signify that an Auto Cooking Programme has been set. The 'cookpot' symbol will go out.



Step 7 Turn the oven control(s) to the required temperature, and if necessary select the appropriate oven function.

At the end of the Automatic Cook Period the Auto Symbol will flash and an intermittent beeping sound will be heard.

The audible tone will continue unless cancelled.

The 'Auto' symbol will continue to flash until the timer is returned to Manual operation (see below).

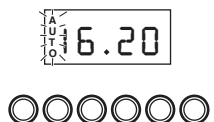

Step 8 Press the Manual button, the audible tone will be cancelled and the oven(s) will be returned to Manual.

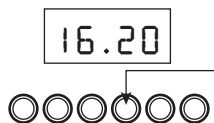

Step 9 Turn the oven control(s) to the OFF position.

ELECTRONIC CLOCK & AUTOMATIC OVEN

TIMER OPERATION

Note 1 When cooking automatically the Cook Period can be checked at any time by simply pressing the Cook Period button.

Note 2 When cooking automatically the End Time can be checked at any time by simply pressing the End Time button.

b) TO SET TIMER TO SWITCH ON IMMEDIATELY AND OFF AUTOMATICALLY AFTER A SET COOK PERIOD

Step 1 Check that the correct time of day is set, if not follow instructions for setting the time of day.

Step 2 Place food onto the correct shelf position in the oven and close the oven door(s).

Step 3 Turn the oven control(s) to the required temperature, and if necessary select the appropriate oven function.

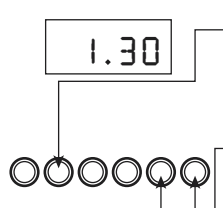

Step 4 Press & hold in the Cook Period button, the display will read 0.00 and the 'cookpot' symbol will light up. With the Cook Period button still held in set the required Cook Period using the "+" and "-" buttons. Example: 1hr 30 minutes (as shown).

Step 5 Release all buttons.

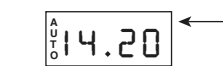

The timer display will revert to the time of day with the 'Auto' symbol lit & 'cookpot' symbol remaining lit.

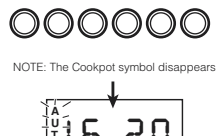

At the end of the Cook Period the 'Auto' symbol will flash and an intermittent audible tone will be heard. The audible tone will continue until cancelled. The 'Auto' symbol will continue to flash until the timer is returned to Manual operation (see below).



Step 6 Press the Manual button. The audible tone will be cancelled and the oven(s) will be returned to Manual.

Step 7 Turn the oven control(s) to the OFF position.

ELECTRONIC CLOCK & AUTOMATIC OVEN

TIMER OPERATION

TO CANCEL AN AUTO COOKING PROGRAMME BEFORE THE COOK PERIOD HAS FINISHED.

Step 1 Turn the oven control to the OFF position.

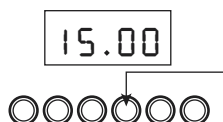

Step 2 Press the Manual button to return the oven to "Manual" operation. The 'Auto' symbol will go out.

Note 1 When cooking automatically the Cook Period can be checked at any time by simply pressing the Cook Period button.

OTHER NOTES ON TIMER OPERATION

1. When cooking Automatically the Cook Period can be checked at any time simply by pressing the Cook Period button.
2. When cooking Automatically the End Time can be checked at any time by simply pressing the End Time button.
3. Having set a Cook Period and End Time an electronic device stores the information. The device within the timer will switch the oven(s) on and off at the required times.
4. When setting an Auto Cooking Programme and a mistake is made, to clear:-
 - (a) Press & release the Manual button.
 - (b) Start the sequence again.
5. If at any time the display shows three flashing zero's 0.00 and 'Auto', it is likely that the electricity supply to the oven has been interrupted. Reset the timer to the correct time of day. ***Food in the oven may, therefore, not have been cooked, before serving check food is thoroughly heated and completely cooked.***
6. To set each function always press and hold the required function button and at the same time press "+" or "-" buttons.

TEMPERATURE CONVERSION CHART

Gas Mark	°F	Main Conventional Oven	Top Conventional Oven	Main Fan Oven
½	250	120	110	100
1	275	140	130	120
2	300	150	140	130
3	325	160	150	140
4	350	180	170	160
5	375	190	180	170
6	400	200	190	180
7	425	220	210	200
8	450	-	220	210
9	475	-	-	220

Temperatures

The recommended temperatures given are for conventional and fan ovens. When using a fan oven it will be necessary to reduce the cooking time by 10 minutes per hour and lower the temperature by up to 20°C. Also, in the majority of cases, it is not necessary to pre-heat the oven. However, pre-heating is recommended when cooking items such as Yorkshire puddings, whisked sponges and bread. Your experience with the cooker will enable you to select the cooking time and temperature best suited for your recipe.

Condensation

Condensation may become evident on the inner door and water may drip through the vent. This is normal when heat and moisture are present and may be a result of any of the following:

1. Kitchen temperature and ventilation.
2. The moisture content of the food eg. meat, roast potatoes, Yorkshire pudding, roasting meat, etc.
3. The quantity of the food being cooked at any one time.

USING THE CERAMIC HOB

WARNING: DO NOT USE THE HOB IF IT IS CRACKED. TO AVOID ELECTRIC SHOCK - SWITCH OFF AT THE COOKER MAINS CONTROL SWITCH IMMEDIATELY AND CONTACT YOUR NEAREST SERVICE OFFICE (see back page).

Ratings of Cooking Zones			
Front Left	Front Right	Back Left	Back Right
Solarglo 1200 W 145mm diameter	Solarglo (Dual Oval) 1500 W 145mm x 250mm diameter	Solarglo 1800 W 180mm diameter	Solarglo 1200 W 145mm diameter

The Working of the Heating Zones

Heating only occurs within the marked circular cooking zones. The zones heat up and cool down quicker, providing greater controllability for sensitive foods. Each heating zone is equipped with a thermal limiter which is a safety cut-out which prevents the ceramic glass from overheating. After several minutes at full power without a pan on the heating zone the thermal limiter will switch the heating elements off and on automatically to avoid any damage to the ceramic glass.

Choice of Saucepans

It is essential that the saucepan's you use on the ceramic hob are suitable.

ALWAYS USE:

- Good quality pans with smooth, flat, heavy bases.
- saucepan's manufactured from aluminium (enamelled or machined) or stainless steel.
- Correct size saucepan's. The base of the pan must cover the heating zone completely.
- saucepan's with lids which are well fitting to reduce cooking time and energy use.

NEVER USE:

- Pans with thin, distorted or uneven bases as these will extend cooking times, waste electricity and cause damaging, local hotspots on the glass surface.
- Pans with ridged or recessed bases.
- Pans with damaged or rough bases which could scratch the glass surface.
- Glass or glass ceramic utensils.

CARE OF THE CERAMIC HOB

Do Not

In order to keep your ceramic hob in good condition, follow these simple guidelines:

- Do not** stare at halogen heating units.
- Do not** cook directly on the hob surface without a cooking utensil, as this will result in damage to the surface of the hob.
- Do not** use the hob as a worktop surface as damage may occur to the smooth surface of the hob.
- Do not** drag or slide utensils on the hob surface, as this will cause scratches in the surface of the hob.
- Do not** allow a cooking utensil to come into contact with the hob surround.
- Do not** place anything between the base of the utensil and the ceramic hob, e.g. do not use asbestos mats, aluminium or wok stand.
- Do not** leave any utensils, food or combustible items on the hob when it is not in use. 
- Do not** place aluminium or plastic foil, or plastic containers on the hob.
- Do not** leave the hotplates or cooking areas switched On unless they are being used.
- Do not** leave heating zones uncovered when they are switched On.

We recommend not to place large preserving pans or fish kettles across two heating areas.

- Do not** leave utensils partly covering the heated areas. Always ensure that they are placed centrally over the heated areas and have the same diameter as the heating area used. 

Do

- Always** ensure that the bottom of the pan is both clean and dry. Dirt or moisture between the pan and the hob can cause pitting of the surface of the glass.

We do not recommend the use of utensils with a base diameter greater than 25cm (10ins).

Pressure cookers or other large pans should be used on the front cooking areas.

- Always** ensure that saucepan handles are positioned safely.
- Always** take extra care when cooking foods with a high sugar content eg. jam, as spillage will cause damage to the surface of the glass.
- Always** clean spills immediately (see Care and Cleaning).

CARE OF THE CERAMIC HOB

IMPORTANT – As with any cooking appliance there could be some fire risk attached to the heating of oil, particularly for deep fat frying, cooking utensils containing oil **must not be left unattended** (e.g. to answer the telephone) on or in close proximity to the patterned cooking areas.

1. Use a deep pan, large enough to completely cover the appropriate heating area.
2. Never fill the pan more than one-third full with fat or oil.
3. Never leave oil or fat unattended during the heating or cooking period.
4. Do not try to fry too much food at a time, especially frozen food. This only lowers the temperature of the oil or fat too much, resulting in greasy food.
5. Always dry food thoroughly before frying, and lower it slowly into the hot oil or fat. Frozen foods, in particular, will cause frothing and spitting, if added too quickly.
6. Never heat fat, or fry, with a lid on the pan.
7. Keep the outside of the pan clean and free from streaks of oil or fat.
8. Never allow excessive splashing of oil onto the hob.

Safety requirements for deep fat frying

In the unfortunate event of a chip pan fire:

1. Switch **Off** the electricity supply.
NEVER attempt to move the pan - burns and injuries are caused almost invariably by picking up the burning pan and rushing outside with it.
2. Smother flames with a fire blanket or damp cloth.
NEVER use a fire extinguisher to put out a pan fire, as the force of the extinguisher is likely to tip the pan over.
NEVER use water to extinguish oil or fat fires.
When smothering the flames **DO ENSURE** that you **FACE** and **ARMS** are **WELL PROTECTED** from the flames to save you from becoming hurt.
3. After the fire has been extinguished **LEAVE THE PAN TO COOL FOR AT LEAST 60 MINUTES BEFORE MOVING IT.**
4. If you fail to put the fire out, call the fire brigade immediately.

HIGH SPEED GRILL

CAUTION: Accessible parts may become hot when the grill is in use - children should be kept away.

Your cooker is not fitted with a conventional type of grill. The high speed grill is designed to reduce your grilling times. It is quicker because it takes less time to warm up from cold. Conventional grills require 5 minutes pre-heat before food is placed beneath them, but for normal grilling the high speed grill can be used from cold without any pre-heat. However, when toasting, optimum performance is achieved by preheating the grill for about 1 minute.

Note:

You will notice that the grill elements are protected by a wire mesh. This stops you from touching live parts.

DO NOT under any circumstances insert objects into the grill mesh as this could damage or break the element tubes OR if the grill is on cause an electric shock.

During use the mesh may become soiled. Do not attempt to clean it while the grill is still on. Turn the cooker off at the control unit and wait until it has cooled down before cleaning.

Care must be taken to ensure the grill mesh is not distorted - DO NOT store the grill pan handle on the grill pan grid when the rod shelf is in the top runner position.

There are two halves to the grill, one on the left and one on the right. You can choose to have both sides on or just the left side on. Turning the control knob clockwise, will switch both sides on. Turning it anticlockwise, will only switch the left side on. The numbers which are displayed indicate the heat setting. Number 4 is the hottest and number 1 the coolest.

GRILLING SHOULD NOT BE UNDERTAKEN WITH THE GRILL/TOP OVEN DOOR CLOSED - This will cause overheating.

The grill will not operate unless the top oven control is in the '0' **Off** position.

Grilling procedure

1. Open the grill/top oven door fully.
2. Position rod shelf as recommended in the chart (next page) for food being cooked.
3. Place the grill pan on the rod shelf, ensuring it is positioned centrally under the element.
4. Never line the grill pan with aluminium foil as this may cause overheating of fat in the grill pan.

HIGH SPEED GRILL

Guide to grilling successfully

Food	Pre-heat	Shelf Position from base of oven	Setting	Approx. Cooking Time	
Toasting of Bread Products	1 min.	3 or 2	Maximum	3-5 minutes. Grill pan and grid.	
Small cuts of meat – Sausages, Bacon	None	3 or 2	Maximum for 4 minutes, then reduce to 3	10-15 minutes. Grill pan and grid.	
Chops, etc. Gammon Steaks, Chicken pieces	None	2	Maximum for 6-8 minutes. reduce to 3-2½	25-30 minutes. Grill pan and grid.	
Fish	Whole:	None	2	Maximum	6-8 minutes.
	Fillet:	None	3 or 2	Maximum	In base of grill pan.
Fish in breadcrumbs	None	3 or 2	3	10-15 minutes. Grill pan and grid.	
Pre-cooked Potato Products	None	3 or 2	3	10-12 minutes.	
Pizzas	None	3 or 2	3	10-15 minutes. Grill pan and grid.	
Browning of Food	1 min.	1 or 2	Maximum	5-7 minutes. Dish placed directly on shelf.	

NOTE:

Position 1 is bottom runner from the base of the oven

Grill pan handle

The grill pan handle is detachable from the pan, to facilitate cleaning and storage. The handle can be either detachable from or fixed to the pan. For a fixed handle remove the screw and washers from the grill pan bracket, tilt the handle over the recess adjacent to the bracket (A), slide it towards the centre of the pan (B) and let the handle locate over the bracket (C). Replace screw and washers and ensure that they are fully tightened up. For a detachable handle remove screw and washers from the grill pan and keep safe. Please note that if a fixed handle is required, the grill pan cannot be kept in the Fan Oven with the door closed but may be stored in the Top Oven when the appliance is not in use. Warning:

Ensure when using grill pan handle in the detachable manner it is centralised and secure.

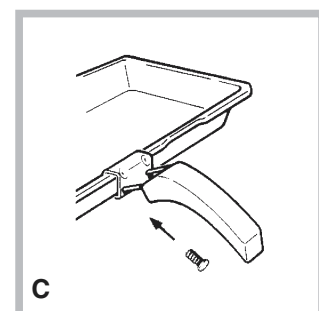
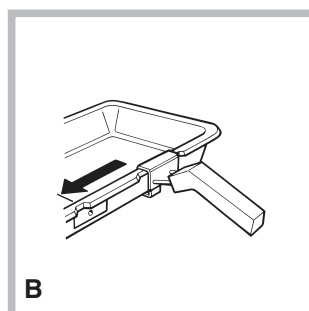
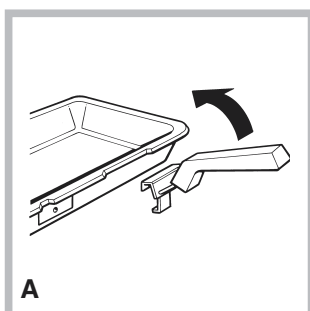

TOP OVEN - CONVENTIONAL COOKING

The heat for conventional cooking in the top oven is provided by the grill element and the element under the floor of the oven. It is ideal for the slow cooking of cheaper cuts of meat in casseroles etc. but can also be used for small joints of meat up to 1.5kg (3lb).

The operation of the controls is covered on "The Controls".

See cooking charts for temperatures and shelf positioning.

The top oven can be used either independently to cook small quantities of food or in conjunction with the main oven to provide additional cooking space.

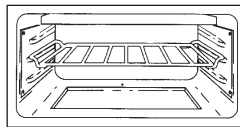

- The shelf should be positioned on the first or second runner from the bottom.

To use the oven proceed as follows:

- Set the top oven control to the required temperature, the top oven light will come on and wait for the thermostat light to go off, indicating that the oven has reached the right temperature.
- The food to be cooked should be placed in the centre of the shelf with a gap of at least 25mm (1in) between it and the grill element. This should avoid burning and ensure even cooking.
- **Do not place food or dishes on the floor of the oven.**

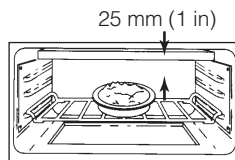

Platwarming in the top oven

Plates and dishes placed on shelf 1 of the top oven will be heated when the main oven is in use.

When the main oven is not in use, for instance when a meal is being cooked on the hob, place the plates and serving dishes on the shelf using the bottom runner and turn the top oven control to approximately 100°C. A maximum time of 10-12 minutes is all that is required to heat the plates and dishes.

NEVER operate the grill control when using the top oven for cooking or warming plates and dishes.

WARNING: DO NOT put delicate items china or items which could be affected by heat into the oven.

TOP OVEN TEMPERATURE CHARTS - BAKING

	Top Oven Cooking			
Baking	Pre-heat	Temperature °C	Time in mins.	Position in Oven
Scones	Yes	210/220	10-15	Runner 2 from bottom of oven
Small Cakes	Yes	180/190	20-25	Runner 2 from bottom of oven
Victoria Sandwich	Yes	170/180	20-30	Runner 2 from bottom of oven
Sponge Sandwich	Yes	180/190	20-25	Runner 2 from bottom of oven
Swiss Roll	Yes	200/210	10-15	Runner 2 from bottom of oven
Semi-rich Fruit cakes	Yes	150/160	60-75 7 inch	Runner 2 from bottom of oven
Rich Fruit Cakes	Yes	140/150	Depending on size	Runner 1 or 2 from bottom of oven
Shortcrust Pastry	Yes	190/200	Depending on size	Runner 2 from bottom of oven
Puff Pastry	Yes	200/210	Depending on size	Runner 2 from bottom of oven
Yorkshire Pudding	Yes	190/200	30-40	Runner 2 from bottom of oven
Individual Yorkshire Pudding	Yes	200/210	20-30	Runner 2 from bottom of oven
Milk Pudding	Yes	140/150	90-120	Runner 2 from bottom of oven
Baked Custard	Yes	150/160	40-50	Runner 2 from bottom of oven
Bread	Yes	200/210	30-45	Runner 1 from bottom of oven
Meringues	Yes	100	150-180	Runner 2 from bottom of oven

	Fan Oven Cooking			
Baking	Pre-heat	Temperature °C	Time in mins.	Position in Oven
Scones	Yes	210/220	8-10	Runner 2 from bottom of oven
Small Cakes		170/180	15-20	Runner 2 from bottom of oven
Victoria Sandwich		160/170	20-25	Runner 2 from bottom of oven
Sponge Sandwich	Yes	170/190	15-20	Runner 2 from bottom of oven
Swiss Roll	Yes	180/190	10-15	Runner 2 from bottom of oven
Semi-rich Fruit cakes		140/150	60-75	Runner 2 from bottom of oven
Rich Fruit Cakes		130/140	Depending on size	Runner 1 or 2 from bottom of oven
Shortcrust Pastry		190/200	45-50	Runner 2 from bottom of oven
Puff Pastry		190/200	Depending on use	Runner 2 from bottom of oven
Yorkshire Pudding	Yes	180/190	40-45	Runner 2 from bottom of oven
Individual Yorkshire Pudding	Yes	190/200	20-25	Runner 2 from bottom of oven
Milk Pudding		130/140	105-135	Runner 2 from bottom of oven
Baked Custard		140/150	40-50	Runner 2 from bottom of oven
Bread	Yes	200/210	40-50	Runner 1 from bottom of oven
Meringues		80-90	180-240	Runner 2 from bottom of oven

Note: If soft margarine is used for cake making, temperatures recommended by the manufacturers should be followed. Temperatures recommended in this chart refer to cakes made with block margarines or butter only.

TOP OVEN TEMPERATURE CHARTS - MEAT

Top Oven Cooking				
Meat	Pre-heat	Temperature °C	Time (approx.)	Position in Oven
Beef/ Lamb (slow roasting)	Yes	170/180	35 mins per 450g (1lb) + 35 mins over.	Runner 1 from bottom of oven.
Beef/ Lamb (foil covered)	Yes	190/200	35-40 mins per 450g (1lb)	
Pork (slow roasting)	Yes	170/180	40 mins per 450g (1lb) + 40 mins over	
Pork (foil covered)	Yes	190/200	40 mins per 450g (1lb)	
Veal (slow roasting)	Yes	170/180	40-45 mins per 450g (1lb) + 40 mins over	
Veal (foil covered)	Yes	190/200	40-45 mins per 450g (1lb)	
Poultry/Game (slow roasting)	Yes	170/180	25-30 mins per 450g (1lb) + 25 mins over	
Poultry/Game (foil covered)	Yes	190/200	25-30 mins per 450g (1lb)	
Casserole Cooking	Yes	150	2-2½ hrs	

If using aluminium foil, never:
1.Allow foil to touch sides of oven. **2.**Cover oven interior with foil. **3.**Cover shelves with foil.

Top Oven Cooking				
Meat	Pre-heat	Temperature °C	Time (approx.)	Position in Oven
Beef/ Lamb (slow roasting)	Yes	170/180	35 mins per 450g (1lb) + 35 mins over.	Runner 1 from bottom of oven.
Beef/ Lamb (foil covered)	Yes	190/200	35-40 mins per 450g (1lb)	
Pork (slow roasting)	Yes	170/180	40 mins per 450g (1lb) + 40 mins over	
Pork (foil covered)	Yes	190/200	40 mins per 450g (1lb)	
Veal (slow roasting)	Yes	170/180	40-45 mins per 450g (1lb) + 40 mins over	
Veal (foil covered)	Yes	190/200	40-45 mins per 450g (1lb)	
Poultry/Game (slow roasting)	Yes	170/180	25-30 mins per 450g (1lb) + 25 mins over	
Poultry/Game (foil covered)	Yes	190/200	25-30 mins per 450g (1lb)	
Casserole Cooking	Yes	150	2-2½ hrs	

If using aluminium foil, never:
1.Allow foil to touch sides of oven. **2.**Cover oven interior with foil. **3.**Cover shelves with foil.

The most accurate method of testing the readiness of joints of meat or whole poultry is to insert a meat thermometer into the thickest part of a joint, or the thickest part of poultry thighs, during the cooking period. The meat thermometer will indicate when the required internal temp has been reached.

Beef -	Rare: 60°C	Lamb: 80°C	Poultry: 90°C
	Medium: 70°C	Pork: 90°C	
	Well Done: 75°C	Veal: 75°C	

MAIN OVEN

- FAN COOKING

The heat for fan cooking in the main oven is provided by an element situated at the back of the oven, around the fan. Fan cooking is ideal for large poultry or joints of meat, reducing cooking times and often eliminating the need for pre-heating the oven. It is also ideal for batch cooking where food is cooked on more than one level, because the forced circulation of hot air gives an even temperature from the top to the bottom of the oven.

The operation of the controls is covered on "The Controls".
See cooking charts for temperatures and shelf positioning.

To use the oven proceed as follows:

- The shelves should be evenly spaced. To avoid unnecessary cleaning, shelves which are not in use should be removed from the oven.
- Set the main oven control to the required temperature. Preheating is not normally necessary, but some foods such as bread, scones and Yorkshire pudding do benefit from being placed in a hot oven (see cooking charts).
- Place the food to be cooked in the centre of each shelf to allow for even air circulation around the food.

USING THE SLOW COOK SETTING 'S'

'S' SLOW setting

This is used for slow cooking, keeping food warm and warming plates for short periods. Extra care should be taken when warming bone china, as it may be damaged in a hot oven.

DO NOT place food or plates directly on the oven floor as this could damage both the oven lining and the plates which are being warmed.

Advantages of "SLOW" cooking are:

- The oven stays cleaner because there is less splashing.
- Timing of food is not as critical, so there is less fear of overcooking.
- Inexpensive joints of meat are tenderised.
- Fully loading the oven can be economical.
- Cooking times can be extended in some cases by up to 2 hours.

Bearing in mind these advantages, it makes sense to cook larger quantities of food than required and store them in a freezer to be used cold or for re-heating. It is important to follow the guidelines given for preparing food using the Slow Setting 'S'.

Storage and re-heating of food:

1. If food is to be frozen or not used immediately, place it in a clean container and cool as soon as possible.
2. Always thaw frozen food completely in the refrigerator before re-heating.
3. Always reheat food thoroughly and ensure it is piping hot before serving.
4. Only re-heat food once.

Operation:

1. Place the prepared food in the main oven and ensure the door is fully closed.
2. Select 'S' (Slow Cooking Temperature) by turning Main Oven Temperature Control clockwise ensuring the oven door is fully closed.

Points to consider when preparing food for "SLOW" cooking:

1. Make sure that the dishes to be used will fit into the oven ensuring enough room for air to circulate.
2. All dishes cooked on the slow setting will require a minimum of 6 hours, however, if they are cooked for 1-2 hours longer then deterioration in their appearance may be noticed.
3. Never cook joints of meat over 2.7kg (6 lb) or poultry over 2.0kg (4 lb 8oz). We do not recommend that joints of meat or poultry are stuffed before cooking on the slow setting.
4. To seal in the meat juices, always cook meat or poultry at 170°C for 30 minutes before wrapping in foil and placing on a rack over a meat tin (to allow good air circulation) before turning the control to the slow setting and cooking immediately.
5. Always ensure that joints of pork and poultry are thoroughly cooked by checking with a meat thermometer before serving.
6. Always thaw frozen foods completely before cooking. We do not recommend placing frozen food in the oven to cook.
7. Always bring soups, liquids and casseroles to the boil before placing in the oven.
8. Ensure that casserole dishes have a good seal (not airtight) and cover food first with foil and then the lid to prevent loss of moisture.
9. Ensure that fruit and vegetables are cut into even sized small pieces to cook properly.
10. Always adjust seasoning before serving.
11. If using dried red kidney beans it is important that the beans are soaked and then boiled for a minimum of 10 minutes before using in any dish to destroy any toxins.
12. Egg and fish dishes need only 1-5 hours cooking and should be included in day cooking sessions, where they can be checked from time to time.

CARE AND CLEANING

WARNING: BEFORE CLEANING, SWITCH THE COOKER OFF AT THE MAINS COOKER CONTROL PANEL AND ALLOW IT TO COOL. IT IS ESSENTIAL THAT THE OVENS ARE CLEANED AND KEPT FREE FROM FATS, OIL AND GREASE.

- ! Never use steam cleaners or pressure cleaners on the appliance.
- ! Clean the glass part of the oven door using a sponge and a non-abrasive cleaning product, then dry thoroughly with a soft cloth. Do not use rough abrasive material or sharp metal scrapers as these could scratch the surface and cause the glass to crack.
- ! The accessories can be washed like everyday crockery (even in your dishwasher).

Cleaning of the Ceramic Hob

- Always** clean spills immediately. If the hob is reused before cleaning, spillage will be baked on and be very difficult to remove.
- Always** switch the cooker OFF at the cooker control panel.

To minimise cleaning:

- Always** take care and avoid spills.
- Always** use a Ceramic Hob Cleaner-Conditioner whenever cleaning is done. The Cleaner-Conditioner forms a protective film on the hob and contains a mild detergent which makes cleaning easier. Hotpoint has a Cleaner-Conditioner which can be obtained, either through a local Hotpoint Service Centre or retailer, part no.6004.

To clean off stubborn stains, the following can be used when the surface has cooled:

1. Cif, non-scratch cream cleaner.
2. Heavy soil can be removed from the surface by carefully using a glass scraper.
3. Hard water stains, grease spots and any discolouration having a metallic sheen can be removed with Solvol Autogol Super or any non abrasive stainless steel cleaner.

After cleaning, always use the Cleaner-Conditioner and finish it off by polishing with a clean, dry paper towel.

- Never** use abrasive or chemical oven cleaners as they can damage the surface of the hob.

The visual effect of any scratches which may occur in use can be minimised by the use of Cleaner-Conditioner. Such scratches cannot be removed but do not affect the function of the hob in any way.

CARE AND CLEANING

WARNING: BEFORE CLEANING, SWITCH THE COOKER OFF AT THE MAINS COOKER CONTROL PANEL AND ALLOW IT TO COOL. IT IS ESSENTIAL THAT THE OVENS ARE CLEANED AND KEPT FREE FROM FATS, OIL AND GREASE.

'Stay Clean' Liners

'Stay Clean' liners are covered with a special enamel which absorbs cooking soils. At higher temperatures the soiling is slowly destroyed. In most cases normal cooking at higher temperatures will permit this cleaning to take place automatically. However, if higher cooking temperatures are not used regularly then it may be necessary, in order to prevent heavy soiling, to run the oven at maximum temperature for at least two hours, from time to time. The 'Stay Clean' liners can be washed in warm soapy water followed by rinsing in clear water. Dry well with a soft cloth.

NOTE: Do not use enzyme washing powder, harsh abrasives or chemical oven cleaners of any kind.

Oven Fittings

The oven shelves can be cleaned either in a dishwasher or by using a fine steel wool soap pad. The grill and meat pans can be cleaned in warm soapy water using a fine steel wool soap pad to remove stubborn stains or in a dishwasher. They should be cleaned after each use.

Oven Interiors

To clean the oven interiors remove all the oven fittings and where applicable the 'Stay Clean' liners.

All types of oven cleaners can be used, but **do not** allow abrasive cleaners or oven spray to come into contact with the 'Stay Clean' liners. Use a fine steel wool soap pad to remove stubborn stains.

Oven Door Cleaning

The inner door glass panel can be removed for easy cleaning, see "Care and Cleaning".

Cooker Exterior

The outside of the cooker should be cleaned regularly to keep it looking like new. Wipe over with a soft cloth wrung out in warm water and dry with a soft clean cloth. You can use mild non abrasive cleaners but always read the manufacturer's instructions first. Always test their suitability on a small area of the cooker not noticeable in normal use.

NOTE: DO NOT use scouring pads or abrasive cleaners as they may scratch the surface.

Wear protective gloves when cleaning any part of your cooker.

CARE AND CLEANING

Door and Control Panel (Glass)

Regularly wipe with a clean, damp cloth and polish with a clean, dry cloth.

High Speed Grill

To clean the high speed grill, use a clean, damp, soapy cloth and wipe over. If stubborn stains remain, gently clean with a well soaped nylon scouring pad and wipe over with a damp cloth.

NOTE: DO NOT use metal cleaning utensils, wire wool or proprietary oven cleaners on the grill element mesh.

WARNING: TO AVOID ELECTRIC SHOCK, BEFORE REPLACING THE OVEN LIGHT, SWITCH THE COOKER OFF AT THE COOKER CONTROL UNIT (and allow to cool if the oven has been used).

Replacement of the Oven Light

Unscrew the glass cover, using a suitable cloth to protect the fingers and remove carefully. Unscrew the existing light bulb, and remove. Screw the new bulb into position and replace the glass cover, with metal washer, until positioned securely.

CARE AND CLEANING

CLEANING THE DOORS

Take particular care not to damage the inner surface of the door inner glass that is coated with a heat reflective layer. Do not use scouring pads, or abrasive powder, which will scratch the glass.

Ensure that the glass panel is not subjected to any sharp mechanical blows.

Stubborn stains can be removed by using a fine steel wool soap pad. For slight soiling the inner glass panel may be cleaned, while still warm, without removing it from the door. After cleaning, rinse and dry with a soft cloth.

SIDE OPENING DOORS

Cleaning the door glass is the same as the drop down doors, except take care to support the weight of the inner glass when removing and refitting.

DROP DOWN DOORS

Remove the door inner glass as follows.

1. Open the door fully and remove the extrusion end caps (This should be done by hand but if it proves too difficult, simply lift the inner glass to ease the end caps out of position).

NOTE: If you need to use a tool - be careful not to damage the extrusion or end cap.

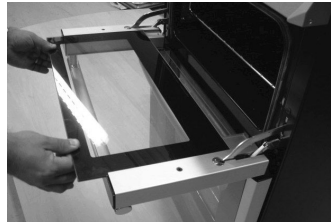

2. Carefully slide the inner glass towards you and withdraw it from its locating slots. Ensure that the door is not allowed to slam shut, due to the reduction in door weight. Clean the glass as described above.
3. The inside of the outer door glass can now be cleaned while still fitted to the cooker.

Refit the door inner glass as follows.

1. Open the door fully.
2. Locate the inner door glass into its slots, so that the printing is readable from the face nearest the oven in the closed position and the widest black band is towards the bottom of the door. The inner door glass has a special reflective coating on one side, in order to minimise surface temperatures and energy consumption during use, it is important it is fitted correctly.
3. Carefully slide the glass into its slots as far as it will go and replace the end caps.

NEVER OPERATE THE COOKER WITHOUT THE INNER DOOR GLASS IN POSITION.

SOMETHING WRONG WITH YOUR COOKER

Before contacting your nearest Service Centre/Installer, check the problem guide below; there may be nothing wrong with your cooker.

Problem	Check
Slight odour or small amount of smoke when grill / oven used for first time	This is normal and should cease after a short period.
Nothing works	If you find that the timer display is blank, then it is likely that there is no electricity supply to your oven. Check: (i) That the main cooker wall is switched on (ii) Other appliances, to see if you have had a power cut (iii) The main circuit breaker for the property
Top Oven and Grill do not work... Main oven works	Operating the cooker under the following conditions may cause a safety device to operate: (a) Grilling with the door closed - Always grill with the door fully open (b) Grilling for an excessively long period at maximum setting - see Grilling guide. Switch off appliance and allow to cool for approx 30 mins. Switch the cooker back on and check that the Grill / Top oven is now operating.
Grill does not work	Ensure that the top oven control is turned fully off.
Grill keeps turning on and off	When the Grill control is operating at less than its maximum setting, the Grill will cycle on and off, this is normal and <u>not</u> a fault.
Timer is showing '0.00'	The power supply to your oven has possibly been interrupted, but has now come back on again. Reset the timer to the correct time of day using the instructions given in the timer section of the book.
Timer buzzer operates continually	To cancel the audible tone: - press the manual button once. - press the minute minder button once.
Oven temperatures too high or low	Check temperature and shelf positions are as recommended in the Oven Temperature Charts. It may be necessary to increase or decrease the recommended temperature slightly to suit your taste.
Oven does not cook evenly	Check: (a) Temperature and shelf positions are as recommended in the Oven Temperature Charts. (b) Oven utensils being used allow sufficient air flow around them.

SOMETHING WRONG WITH YOUR COOKER

Problem	Check
Oven lamp does not work	The oven lamp is not covered by the guarantee. The part is easily changed (see the section on oven lamp replacement). A new lamp may be obtained from our Parts department see Key Contacts, back page.
Draught from beneath control panel	A gentle flow of air will be blown from beneath the control panel when the appliance is used. If the appliance is still warm, this cooling fan may run on, or restart itself when all controls have been turned off. The fan will stop once the appliance has been cooled. This is normal and not a fault.
Condensation on the wall at the rear of the cooker.	Steam and / or condensation may appear from the vent at the rear of the appliance when using an oven particularly for foods with a high water content e.g. frozen chips, roast chicken etc. This is normal, and any excess should be wiped off.
Steam / Condensation in the oven after use.	Steam is a by - product of cooking any food with a high water content. To help minimise always: a) Try to avoid leaving food in the oven to cool after being cooked. b) Use a covered container, wherever possible.

Disposal of your product

To minimise the risk of injury to children please dispose of your product carefully and safely. Remove all doors and lids. Remove the mains cable (where fitted) by cutting off flush with the appliance and always ensure that no plug is left in a condition where it could be connected to the electricity supply.

To help the environment, Local Authority instructions should be followed for the disposal of your product.



Disposal of old electrical appliances

The European Directive 2002/96/EC on Waste Electrical and Electronic Equipment (WEEE), requires that old household electrical appliances must not be disposed of in the normal unsorted municipal waste stream. Old appliances must be collected separately in order to optimise the recovery and recycling of the materials they contain and reduce the impact on human health and the environment.

The crossed out "wheeled bin" symbol on the product reminds you of your obligation, that when you dispose of the appliance it must be separately collected.

Consumers should contact their local authority or retailer for information concerning the correct disposal of their old appliance.







Key Contacts

After Sales Service

Over 1100 trained specialists, directly employed by us, to ensure that you can have complete confidence in both the appliances and services we offer.

Repair Service and Information Help Desk

UK: 08709 066 066

Monday to Friday, 8am to 7.30pm

Saturday, 8.30am to 5.30pm

Sunday, 9.30am to 3.30pm

www.cannonservice.co.uk

Republic of Ireland: 1850 302 200

Note: Our operators will require the following information:

Model number

Serial number

Extended Warranties

UK 08709 088 088

Monday to Sunday, 8am to 8pm

www.cannonservice.co.uk

Republic of Ireland: 1850 502 200

Genuine Parts & Accessories

UK: 08709 077 077

Monday to Friday, 8.30am to 5pm

Saturday, 8.30am to 12noon

www.cannonservice.co.uk

Republic of Ireland: (01) 842 6836

www.cannoncooking.co.uk

Indesit Company UK Limited, Morley Way, Peterborough, PE2 9JB

12/2007 Part no. 195056012.02

Free Manuals Download Website

<http://myh66.com>

<http://usermanuals.us>

<http://www.somanuals.com>

<http://www.4manuals.cc>

<http://www.manual-lib.com>

<http://www.404manual.com>

<http://www.luxmanual.com>

<http://aubethermostatmanual.com>

Golf course search by state

<http://golfingnear.com>

Email search by domain

<http://emailbydomain.com>

Auto manuals search

<http://auto.somanuals.com>

TV manuals search

<http://tv.somanuals.com>