

46259

# Canon

## Power Drive Booster PB-E2



- J** 使用説明書
- E** Instructions
- F** Mode d'emploi
- G** Bedienungsanleitung
- S** Instrucciones

Japanese

English

French

German

Spanish

# Thank you for purchasing a Canon product.

---

Power Drive Booster PB-E2 is a system accessory for the EOS-3, EOS-1N, and EOS-1 to boost the camera's built-in motor drive's performance. When the PB-E2 is coupled to the EOS-3, a maximum shooting speed of about 7 frames per second can be attained. With the EOS-1 or EOS-1N, it can attain about 6 frames per second.

The PB-E2 also has the following vertical-grip controls which give the same camera operation ease as during horizontal shooting.

(1) Shutter button

(2) Main Dial

(3) AE lock button

(4) Focusing point selector

(5) FE lock/multi-spot metering button

- With the EOS-1 and EOS-1N, only the shutter button and AE lock button on the vertical grip will function.

This Instruction booklet uses the following symbols to identify supplementary notes:

 : Cautionary note to prevent malfunction of the camera or Power Drive Booster PB-E2.

 : Helpful tip for operating the camera.

 : Helpful tip for using Power Drive Booster PB-E2 for picture-taking.

- Retain this Instruction booklet handy for future reference.

# Contents

Nomenclature .....	14
Power Requirements .....	15
Battery Installation .....	15
Attachment to a Camera .....	16
Battery Check .....	17
Using the PB-E2 .....	17
Attaching the Hand Strap .....	18
Performance Specifications .....	19

This device complies with Part 15 of the FCC Rules. Operation is subject to the following two conditions: (1) This device may not cause harmful interference, and (2) this device must accept any interference received, including interference that may cause undesired operation.

Do not make any changes or modifications to the equipment unless otherwise specified in the instructions. If such changes or modifications should be made, you could be required to stop operation of the equipment.

This equipment has been tested and found to comply with the limits for a class B digital device, pursuant to part 15 of the FCC Rules. These limits are designed to provide reasonable protection against harmful interference in a residential installation. This equipment generates, uses and can radiate radio frequency energy and, if not installed and used in accordance with the instructions, may cause harmful interference to radio communications.

However, there is no guarantee that interference will not occur in a particular installation. If this equipment does cause harmful interference to radio or television reception, which can be determined by turning the equipment off and on, the user is encouraged to try to correct the interference by one or more of the following measures:

- Reorient or relocate the receiving antenna.
- Increase the separation between the equipment and receiver.
- Consult the dealer or an experienced radio/TV technician for help.

The information in this Instructions booklet is current as of September 1998. For information on using Power Drive Booster PB-E2 with new system accessories introduced after this date, contact your nearest Canon Service Center.

# Nomenclature

Reference page numbers are in parentheses.

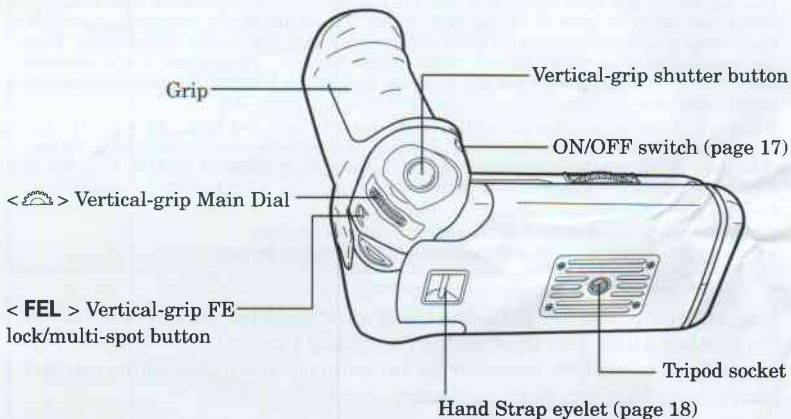
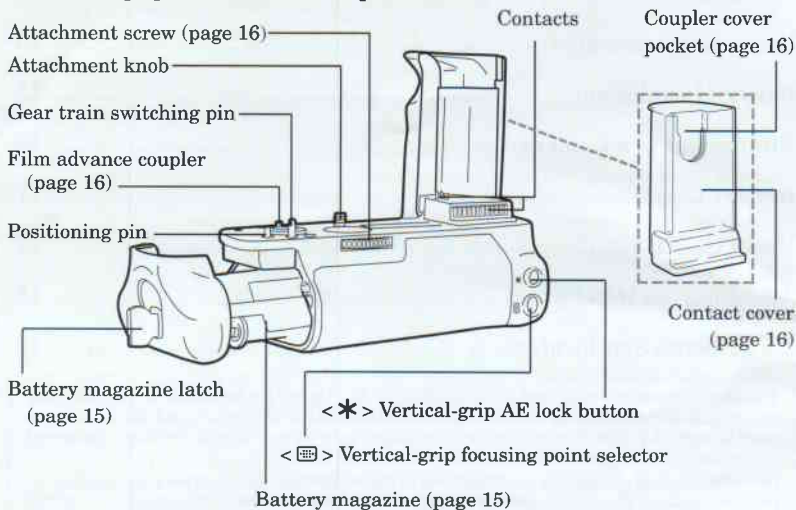

# Power Requirements

Power Drive Booster PB-E2 can use the following power sources (all sold separately):

- (1) 8 size-AA alkaline LR6 batteries
- (2) 8 size-AA Ni-Cd KR15/51 batteries
- (3) 8 size-AA lithium FR6 batteries
- (4) Nickel-Hydride Pack NP-E2

- This can be recharged in about 100 min. with the dedicated Nickel Hydride Charger NC-E2.



- If the Power Drive Booster PB-E2 is used with the EOS-1, do not use size-AA lithium FR6 batteries and the Nickel-Hydride Pack NP-E2. Doing so may damage the camera's electronic circuitry due to the high voltage.
- The Nickel-Hydride Pack NP-E2 cannot be used with the EOS-1N since battery pack performance may be adversely affected if it becomes completely exhausted.
- Power Drive Booster PB-E2 is not compatible with Battery Magazine E1 and Ni-Cd Pack E1.

## Battery Installation

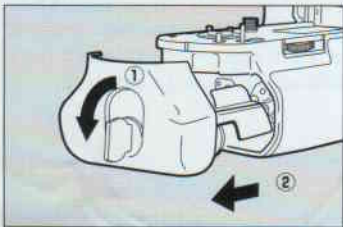

- 1 To remove the battery magazine, turn the Power Drive Booster PB-E2's battery magazine latch as shown by the arrow. Then pull out the magazine.

To reinstall the battery magazine, follow this procedure in reverse.

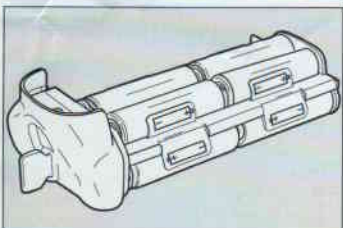

- 2 Install the batteries. Refer to the battery diagram on the magazine and install the batteries in the proper + and - orientation. If any battery is not installed properly, the Power Drive Booster will not operate.

# Attachment to a Camera

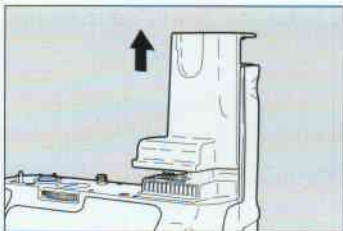

- 1 Slide the contact cover and remove as shown by the arrow.

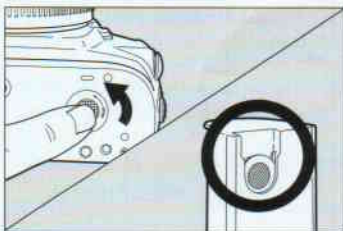

- 2 Use your finger to turn the film advance coupler cover counter-clockwise on the camera bottom.
  - Store the film advance coupler cover inside the coupler cover pocket.

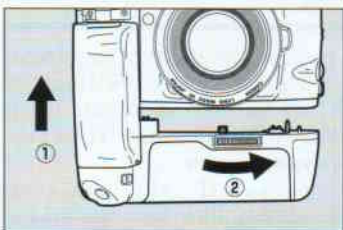

- 3 Keep the camera and PB-E2 parallel to each other and slide the PB-E2's grip portion against the camera. Then turn the attachment knob to tighten.

# Battery Check

Check the battery level with the camera. For details, refer to the camera's Instruction booklet.

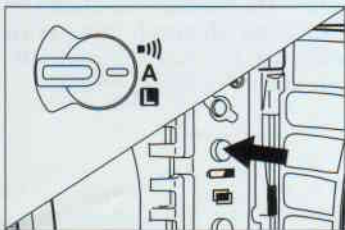

- 1 Set the camera's <img alt="dial icon" data-bbox="785 165 815 185"/> switch to **A**.
- 2 Open the camera's side cover and press the <img alt="battery icon" data-bbox="725 255 755 275"/> button.



- To set the film advance mode, refer to the camera's Instruction booklet.
- For the maximum shooting speeds, see "Performance Specifications."
- For battery life, see "Performance Specifications."

## Using the PB-E2

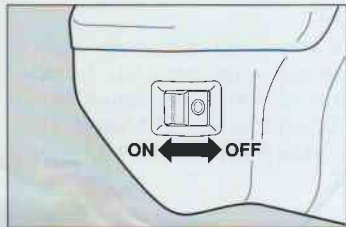

To use the PB-E2's vertical-grip controls, first turn on the PB-E2's ON/OFF switch.

- The camera's controls are not affected by the PB-E2's ON/OFF switch.
- For horizontal shooting, turn off the PB-E2's ON/OFF switch to prevent accidental operation of the vertical-grip controls.

# Attaching Hand Strap EOS-1N

The optional Hand Strap E1 can improve camera holding and carrying ease.

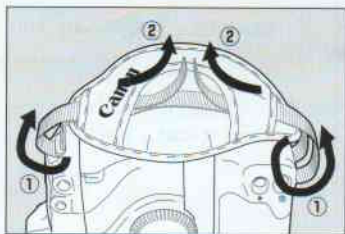

- 1 Remove the buckle and slide the strap ends through the strap eyelets on the camera and PB-E2 as shown in the diagram.

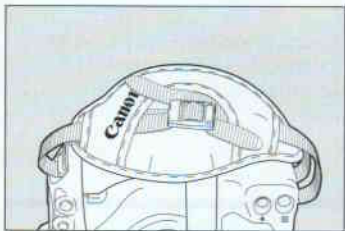

- 2 As shown in the diagram, slip both strap ends through the buckle with one strap end overlapping the other.

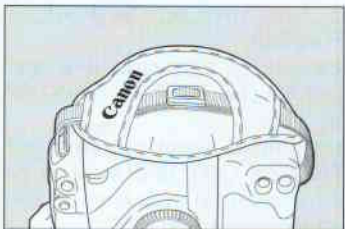





- 3 Pull the strap and make sure it does not slip from the buckle. After adjusting the Hand Strap to fit over your right hand, tuck the strap ends into the strap pad.



# Performance Specifications

## Maximum Continuous Shooting Speed (frames/sec.)

Configuration	Film Advance Mode	AF Mode		Power Source
		One-Shot Manual	AI Servo	
EOS-3+PB-E2	 H	7 fps	7 fps	Nickel-Hydride Pack NP-E2
	 L	6 fps	5 fps	LR6 or FR6
	 L	3 fps	3 fps	
EOS-1N+PB-E2	 H	6 fps	5 fps	LR6 or FR6
	 L	3 fps	2.5 fps	
EOS-1+PB-E2	C <sup>H</sup>	5.5 fps	4.5 fps	LR6
	C <sup>L</sup>	3 fps	2.5 fps	

• The above figures apply when the shutter speed is 1/250 sec. or faster.

- Power Source:
- (1) 8 size-AA alkaline LR6 batteries
  - (2) 8 size-AA Ni-Cd KR15/51 batteries
  - (3) 8 size-AA lithium FR6 batteries
  - (4) Nickel Hydride Battery Pack NP-E2

## Battery Life

Configuration	Temperature	LR6 × 8	FR6 × 8	KR15/51 × 8	Nickel-Hydride Pack
EOS-3+PB-E2	(20 °C)	125(85)	180(120)	50(35)	100(70)
	(-20 °C)	7(5)	75(50)	36(24)	30(20)
EOS-1N+PB-E2	(20 °C)	125(85)	180(120)	50(35)	-
	(-20 °C)	7(5)	75(50)	36(24)	-
EOS-1+PB-E2	(20 °C)	125(85)	-	50(35)	-
	(-20 °C)	7(5)	-	36(24)	-

- The figures in the table above indicate the number of 24-exposure rolls with a new set of batteries and an EF 50mm f/1.4 lens. Figures in parentheses indicate the number of 36-exposure rolls. For the test conditions, refer to the EOS-3's Instruction booklet.
- Depending on the actual shooting conditions, the shooting capacity may be less than the figures indicated in the above table.
- If extra battery power is consumed by pressing the shutter button halfway or autofocus for extended periods, the shooting capacity may be fifty percent or less than the figures in the above table.

Dimensions: 158.7 (W) × 116.4 (H) × 82.5 (D) mm  
6.25(W) × 4.58 (H) × 3.25 (D) in

Weight: 485g/17.1oz (BP-E2 only)

- Subject to change without notice.

### NOTE FOR CUSTOMERS IN EUROPE

NICKEL-CADMIUM BATTERY.  
MUST BE RECYCLED OR DISPOSED OF PROPERLY.

**A L'ATTENTION DE LA CLIENTELE EUROPEENNE.**  
BATTERIE AU NICKEL-CADMIUM.  
DOIT ETRE RECYCLEE OU DUMENT JETEE.

**HINWEIS FÜR KUNDEN IN EUROPA**  
NICKEL-CADMIUM-BATTERIE  
MUSS RECYCELT ODER SACHGEMÄSS ENTSORGT WERDEN.

**NOTA PARA LOS CLIENTES DE EUROPA**  
BATERIA DE NIQUEL-CADMIO.  
DEBARA RECICLAR O TIRARSE ADECUADAMENTE.

### A L'ATTENTION DE LA CLIENTELE SUISSE

Après usage à rapporter au point de vente.

**HINWEIS FÜR KUNDEN IN DER SCHWEIZ**  
Nach Gebrauch der Verkaufsstelle Zurückgeben.



Cd

This digital apparatus does not exceed the Class B limits for radio noise emissions from digital apparatus set out in the Radio Interference Regulations of the Canadian Department of Communications.



- The CE Mark is a Directive conformity mark of the European Community (EC).

### NOTE FOR CUSTOMERS IN THE US AND CANADA



**NICKEL-CADMIUM BATTERY. MUST BE RECYCLED OR DISPOSED OF PROPERLY. FOR MORE INFORMATION, PLEASE CONTACT YOUR LOCAL ENVIRONMENTAL AGENCY.**

The product you have purchased is powered by a nickel-cadmium battery which is recyclable.

Please call 1-800-8-BATTERY for information on how to recycle this battery. RBRC™ RECYCLING SYSTEM IS AVAILABLE IN USA AND CANADA.

The RBRC™ Seal

The RBRC™ Seal on the easily removable nickel-cadmium battery indicates that Canon is voluntarily participating in an industry program to collect and recycle these batteries at the end of their useful lives, when taken out of service within USA and CANADA. The RBRC™ program provides a convenient alternative to placing used nickel-cadmium batteries into the trash or municipal waste, which is illegal in some areas.

Canon's payments to RBRC™ make it easy for you to drop off the spent battery at local retailers of replacement nickel-cadmium batteries, or at authorized Canon product service centers. You may also contact your local recycling center for information on where to return the spent battery. Please call 1-800-8-BATTERY for information on Ni-Cd battery recycling in your area. Canon's involvement in this program is part of its commitment to protecting our environment and conserving natural resources.

Note : RBRC™ is a trademark of the Rechargeable Battery Recycling Corporation.



INCORPORATING OLDTIMER CAMERAS

**OTC Ltd**, 24 Market Place, Hatfield, Herts, AL10 0LN

Tel: 01707 273773 Fax: 01707 273774 Email: [sales@otcworld.co.uk](mailto:sales@otcworld.co.uk) [www.otcworld.co.uk](http://www.otcworld.co.uk)

Download from [www.Softmanuals.com](http://www.Softmanuals.com) All Manuals Search And Download.

## Free Manuals Download Website

<http://myh66.com>

<http://usermanuals.us>

<http://www.somanuals.com>

<http://www.4manuals.cc>

<http://www.manual-lib.com>

<http://www.404manual.com>

<http://www.luxmanual.com>

<http://aubethermostatmanual.com>

Golf course search by state

<http://golfingnear.com>

Email search by domain

<http://emailbydomain.com>

Auto manuals search

<http://auto.somanuals.com>

TV manuals search

<http://tv.somanuals.com>