

23/16-629A

Canon

Speedlite **300EZ**



Download from www.Somanuals.com. All Manuals Search And Download.

E
INSTRUCTIONS English Edition



Especially designed for the EOS cameras, the Canon Speedlite 300EZ is a high-performance, electronic flash unit featuring the A(Advanced)-TTL automatic flash output control, which can respond to a wide range of illumination from dark surroundings to bright (fill-in flash) without troublesome operations.

Please read this instruction booklet carefully for a full understanding.

- The EOS 620 will be available soon.

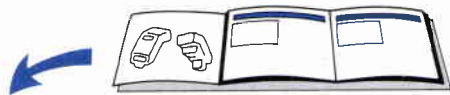

For easy reference to the Speedlite's parts, please unfold the front flap of this booklet.

Table of Contents

Nomenclature	p. 3
--------------------	------

Preliminary Preparations

1. Loading the Batteries	p. 5
2. Mounting the Flash on the Camera	p. 6
3. Ready Lamp and Test Firing	p. 6
SE (Save-Energy) Function	p. 7
Rapid-Fire Flash Capability	p. 8
Auto Internal Zoom Mechanism	p. 9
AF Auxiliary Light	p. 9

Basic Operation	p.10
-----------------------	------

Other Operations

1. Program AE Mode [A-TTL]	p.12
2. Shutter-priority AE Mode [A-TTL] ...	p.14
3. Aperture-priority AE mode [A-TTL] .	p.16
4. Manual Mode [TTL]	p.18
5. Second-curtain Sync Flash Photography	p.21
Notes	p.22
Speedlite Care	p.22
Specifications	p.23

Nomenclature

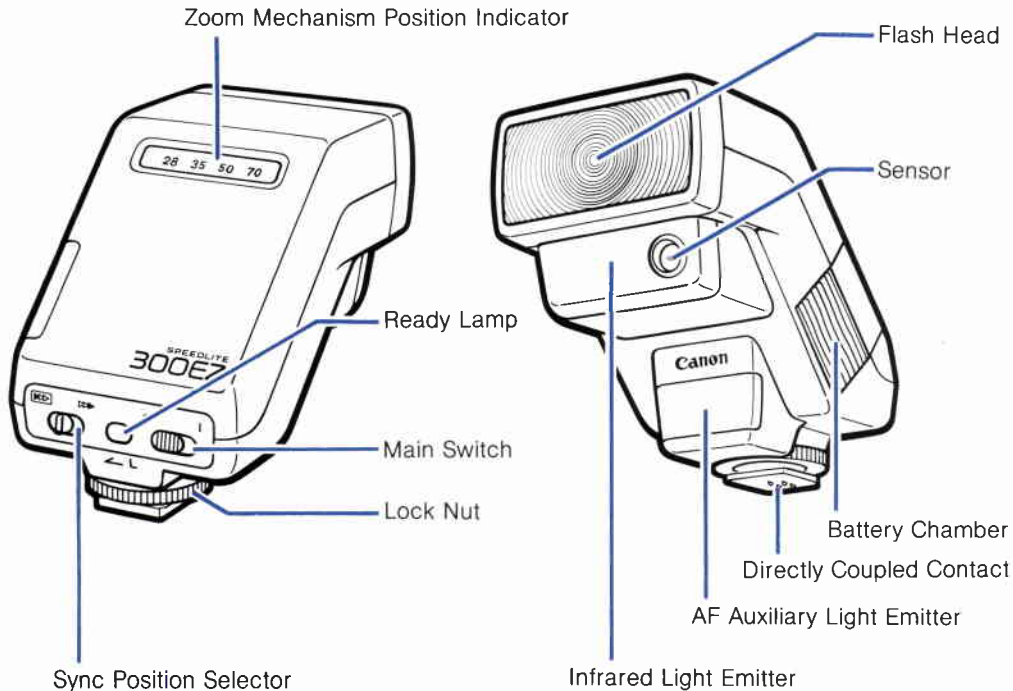

Preliminary Preparations

1. Loading the Batteries

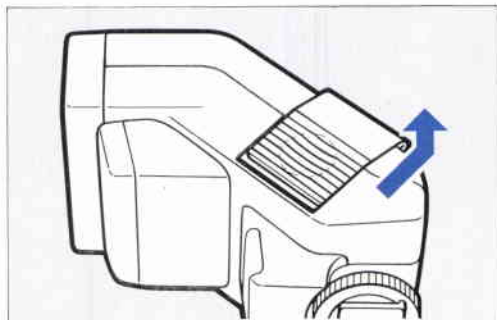

Use four, new, size-AA alkaline (LR6) or Ni-Cd batteries. Carbon-zinc batteries may also be used, but their life is shorter. Wipe the battery terminals with a clean, dry cloth to ensure proper contact.

- 1) Slide the battery chamber cover down in the direction of the arrow to open.
- 2) Load the batteries so that their terminals face in the directions indicated by the diagram inside the battery chamber.
- 3) Finally, push the cover completely down and slide it back to close.

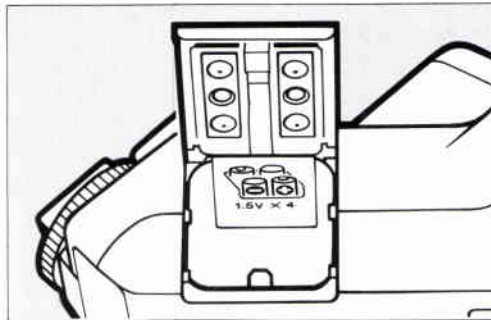

Notes

- When the batteries become exhausted, replace all four at the same time with the same brand.
- Remove the batteries if you do not expect to use the flash unit for about three weeks or longer.
- Battery performance deteriorates in cold temperatures below 0°C/32°F so please keep the batteries warm until just before use. For best results, use fully-charged Ni-Cd batteries in cold temperatures below 0°C/32°F.
- When using Ni-Cd batteries, please note that various brands have different types of terminals. Be sure to use a suitable type. Recharge Ni-Cd batteries according to the manufacturer's instructions.

2. Mounting the Flash on the Camera

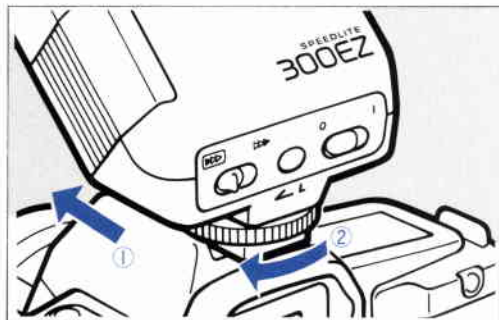

- 1) Loosen the lock nut and slide the flash unit into the camera's accessory shoe. To ensure correct electrical contact, make sure it is pushed in all the way.
- 2) Tighten the lock nut.

3. Ready Lamp and Test Firing

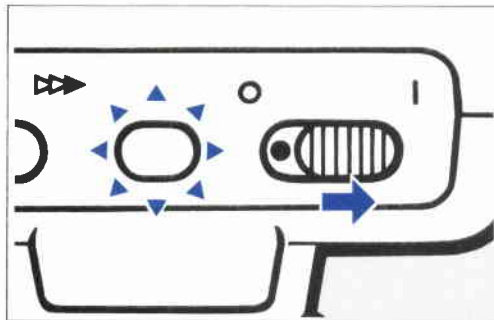

Turn the main switch ON ("I" mark) and wait for the ready lamp to light up. To test functioning, press the ready lamp after it has lit and if the flash fires it is in proper working order.

- If the camera is turned on, test firing does not function.
- Flash charge is also confirmed by the "⚡" mark in the viewfinder.
- When the shutter button is pressed halfway, the flash head position automatically adjusts. (see p.9)

SE (Save-Energy) Function

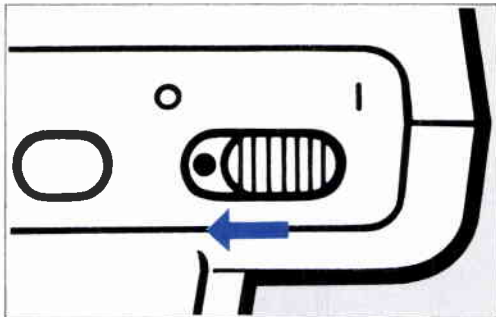

Turn the main switch OFF ("○" mark) when flash photography is finished to prevent unnecessary battery consumption. The Speedlite 300EZ has a built-in SE (Save-Energy) function that automatically turns off power when the flash is not used for approximately five minutes (test firing, preflash, etc.). Press the shutter button halfway down to re-start the flash.

- For interval flash photography, attach the Technical Back E and set the mode to the interval timer or self-timer. The flash charge starts automatically one minute before shutter release.

Rapid-Fire Flash Capability

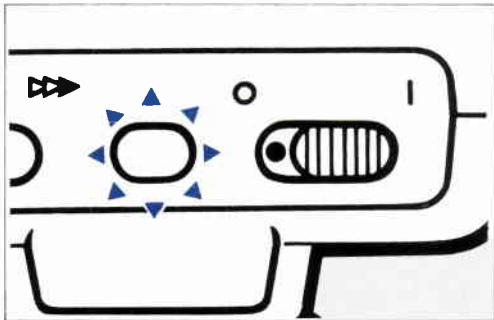

To help capture an unexpected moment in flash photography, the Speedlite 300EZ has rapid-fire flash capability, a short flash recycling time, previously impossible with any other SLR system.

When charged, the color of the ready lamp changes as follows:

- (1) Yellow-green — Indicates the unit in rapid-fire flash status, but fires for correct exposure.
 - (2) Red — Indicates the unit is fully-charged.
- See the guide number table for rapid-fire flash status on p.23.

Replace with new batteries if the yellow-green lamp does not light for 10 seconds after the main switch is turned on.

Auto Internal Zoom Mechanism

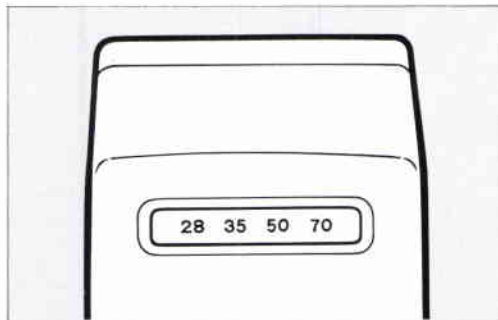

The Speedlite 300EZ has an auto zoom mechanism which automatically adjusts flash coverage angle to use flash energy more effectively.

When the shutter button is pressed halfway, the flash head position automatically adjusts according to the lens focal length. When using a zoom lens, it also switches automatically according to zooming. The position setting of 28, 35, 50 or 70mm will illuminate in the zoom mechanism position indicator on the back of the flash.

- The guide number varies according to the flash head position, see p.23

AF Auxiliary Light

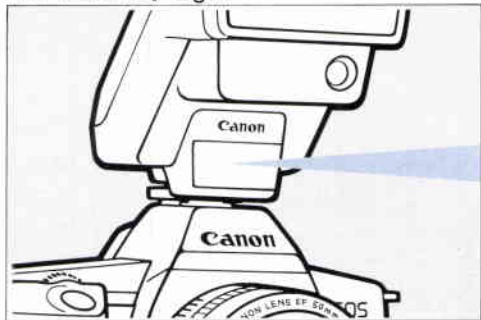

In dark settings difficult for autofocusing, the AF auxiliary light automatically emits to help the camera focus. The effective distance range is approximately 0.9-6m (3-19.7 ft.) If the subject is too far away, the AF in-focus indicator blinks. Remove your finger from the shutter button and move closer to the subject until the AF in-focus indicator stops blinking when repressed.

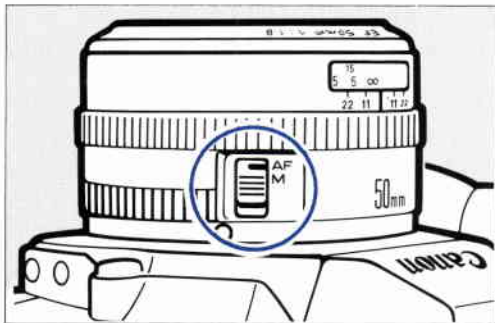

Use the Speedlite 300EZ in conditions ranging from total darkness to supplemental daytime lighting by following these steps:

1) Slide the lens focus mode switch to "AF".

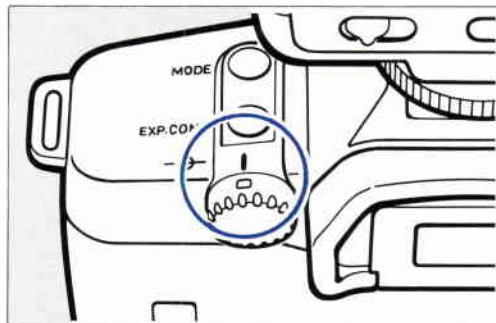

2) Set the camera's main switch to the "Full Auto" position (green "□" mark).

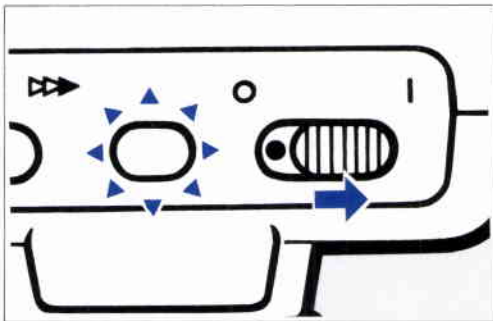

- 3) Turn the flash's main switch on and make sure the ready lamp lights up.
- 4) Cover the main subject with the AF frame and press the shutter button halfway.
 - At this point, the near-infrared light emits from the flash to choose the correct aperture value.
 - Both the X-sync shutter speed and aperture values set automatically.

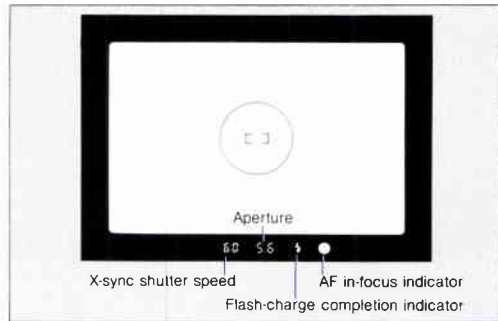

- 5) Exposure will be correct if the X-sync shutter speed and aperture values remain continuously lit.
 - When both values blink, the subject is too far away. Remove your finger from the shutter button and move closer to the subject until both values remain continuously lit when pressed again.
 - When shooting in daylight (fill-in flash), the minimum aperture of the lens in use may blink. The background will be overexposed but the main subject correct. (see p.18)
 - The camera-shake warning does not sound when the flash is turned on.

A-TTL Automatic Mode:

The Speedlite 300EZ features the A (Advanced)-TTL mode which can be used under conditions ranging from total darkness to fill-in flash.

Flash output is controlled by directly measuring the light coming through the lens and reflected from the film surface, using the sensor inside the camera body. Moreover, this A-TTL mode balances the exposure between the main subject illuminated by the flash and the background in ambient light to prevent unnatural effects.

The setting for each shooting mode is slightly different so please read the following carefully.

The camera-shake warning does not sound when the flash is turned on.

When the camera is set to the depth-of-field AE mode with the flash ON, the mode is automatically switched to the program AE mode.

1. Program AE Mode [A-TTL]

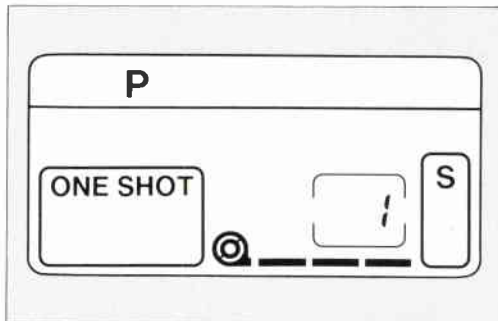

Set the camera to "P" and the X-sync shutter speed and aperture are set automatically so you can concentrate on picture composition. (The X-sync shutter speed is automatically set between 1/60 and 1/250 sec with the EOS 620, and 1/60 and 1/125 sec with the EOS 650.)

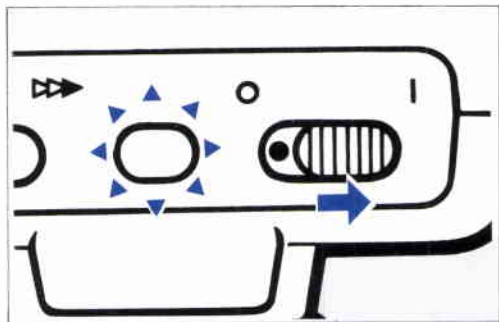

- 1) Turn the main switch ON and make sure the ready lamp lights up.
- 2) Cover the main subject with the AF frame and press the shutter button halfway.
- 3) Exposure will be correct if continuously lit values display.

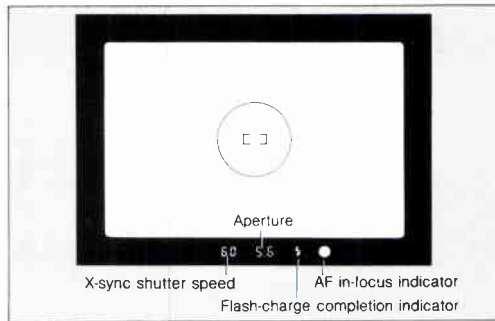

1. When both values blink, the camera is warning that the subject is too far away. Remove your finger from the shutter button and move closer to the subject until both values light steadily when pressed again.
2. In fill-in flash, the aperture value may start blinking; the camera is warning that A-TTL is impossible and the background will be overexposed. The main subject, however, will be correctly exposed since normal TTL (see p.18) functions instead of A-TTL.

2. Shutter-priority AE Mode [A-TTL]

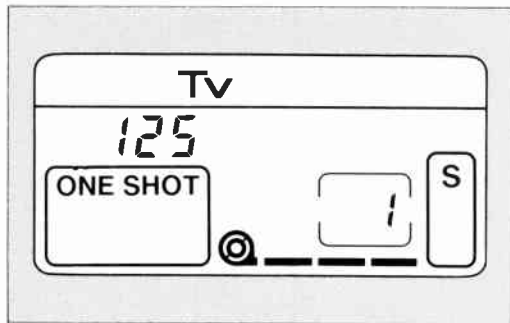

Set the camera to "Tv" to set the desired X-sync speed. The X-sync shutter speed can be set between 30 and 1/250 sec with the EOS 620, and between 30 and 1/125 sec with the EOS 650. The aperture is set automatically.

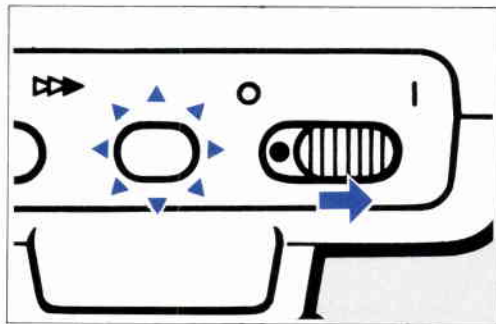

- 1) Turn the main switch ON and make sure the ready lamp lights up.
 - The shutter speed will be set to the fastest possible X-sync speed (1/250 sec with the EOS 620 and 1/125 sec with the EOS 650) automatically if set at a higher value.
- 2) Cover the main subject with the AF frame and press the shutter button halfway.

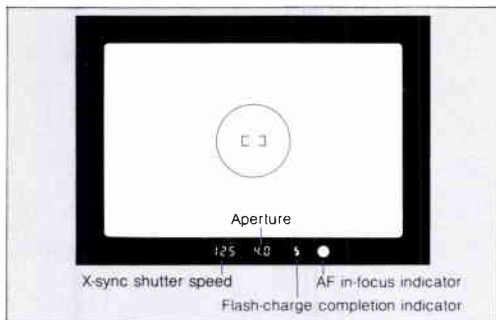

- 3) Exposure will be correct if continuously lit values display.
1. When both values blink, the camera is warning that the subject is too far away. Remove your finger from the shutter button and move closer to the subject until both values light up steadily when pressed again.

2. When the lens maximum aperture blinks, the camera is warning that A-TTL is impossible and the background will be underexposed. The main subject, however, will be exposed correctly since normal TTL (see p.18) functions instead of A-TTL.
 - The maximum aperture value may stop blinking when a slower shutter speed is set: A-TTL is possible but be careful of camera-shake.
3. When the lens minimum aperture blinks, the camera is warning that A-TTL is impossible and the background will be overexposed. The main subject, however, will be exposed correctly since normal TTL (see p.18) functions instead of A-TTL.
 - The minimum aperture may stop blinking when a faster shutter speed is set: A-TTL is possible.

3. Aperture-priority AE Mode [A-TTL]

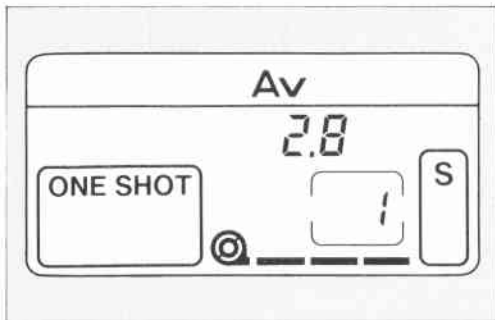

Set the camera to "Av" to take the subject depth of field into account. This setting is best for fill-in flash portraits and slow-sync flash photography. The aperture is set manually while the shutter speed is set automatically (between 30 and 1/250 sec with the EOS 620, and between 30 and 1/125 sec with the EOS 650).

If a smaller aperture is set in the dark, the automatically-set shutter speed will be comparatively slow. Be careful of camera-shake and use a tripod (This warning does not sound.)

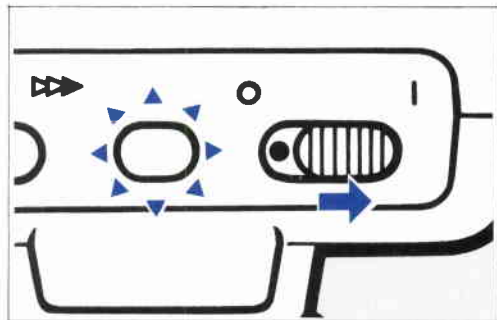

- 1) Turn the main switch ON and make sure the ready lamp lights up.
- 2) Cover the main subject with the AF frame and press the shutter button halfway.

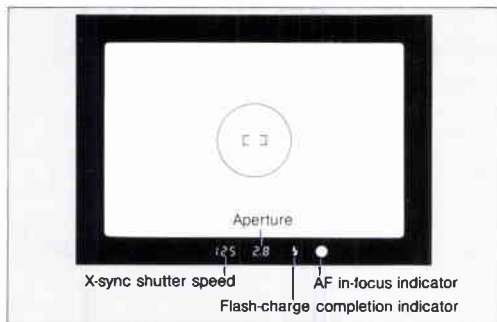

3) Exposure will be correct if continuously lit values display.

1. When both values blink, the camera is warning that the subject is too far away. Remove your finger from the shutter button and move closer to the subject until both values light steadily when pressed again.

2. When the shutter speed of 30" blinks, the camera is warning that A-TTL is impossible and the background will be underexposed. The main subject, however, will be exposed correctly since normal TTL (see p.18) functions instead of A-TTL.

- The shutter speed of 30" may stop blinking when a larger aperture is set and A-TTL is possible but be careful of camera-shake.

3. When the fastest possible X-sync shutter speed (1/250 sec with the EOS 620 and 1/125 sec with the EOS 650) blinks, the camera is warning that A-TTL is impossible and the background will be overexposed. The main subject, however, will be exposed correctly since normal TTL (see p.18) functions instead of A-TTL.

- The shutter speed may stop blinking when a smaller aperture is set. A-TTL is possible.

TTL Automatic Mode:

Use this mode to control the exposure by setting both the shutter speed and the aperture manually. In the TTL mode, correct exposure can be obtained only for the main subject while A-TTL balances exposure between the main subject and the background for correct exposure on both.

4. Manual Mode [TTL]

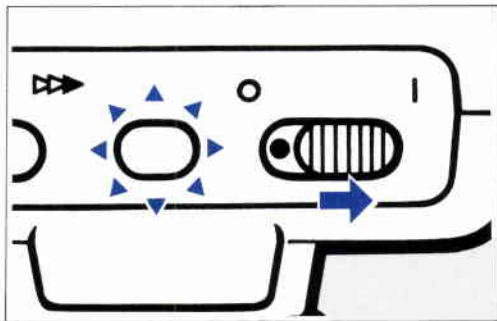

- 1) Turn the main switch ON and make sure the ready lamp lights up.
- 2) Set the camera's shooting mode to "M."

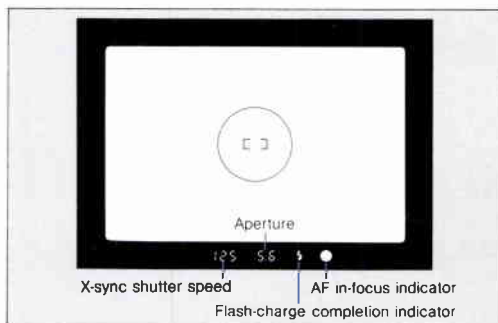
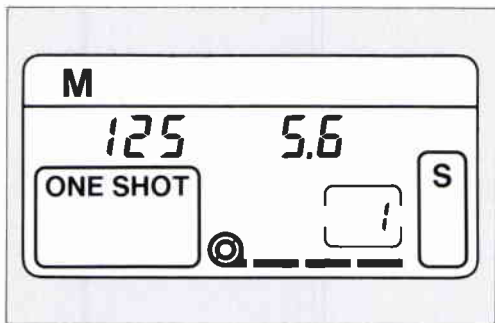

- 3) Set the desired X-sync shutter speed and aperture values on the camera, refer to the camera's instructions.
 - The shutter speed will be set to the fastest possible X-sync speed (1/250 sec with the EOS 620 and 1/125 sec with the EOS 650) automatically if set at a higher value.
- 4) After checking the automatic flash shooting distance range, refer to the table on P.20, then take the picture.

- The automatic shooting distance range changes according to the flash head position, film speed and the aperture value set on the camera.
- Rapid-fire flash is impossible in the TTL mode.

Automatic flash coupling range

(ISO 100)

Flash Head Flash Position Aperture	28mm	35mm	50mm	70mm
1.0	2.8-2.2m (9.2-7.2 ft)	3.2-2.5m (10.5-8.2ft)	3.5-2.8m (11.5-9.1 9ft)	3.8-3.0m (12.5-9.8.4ft)
1.4	2.0-1.6m (6.6-5.2 5ft)	2.2-1.8m (7.2-5.9ft)	2.5-2.0m (8.2-6.5 6ft)	2.7-2.2m (8.9-7.2 2ft)
1.8	1.7-1.3m (5.6-4.2 7ft)	1.9-1.5m (6.2-4.9 2ft)	2.1-1.7m (6.9-5.5 8ft)	2.3-1.8m (7.5-5.9ft)
2.0	1.4-1.1m (4.6-3.6 1ft)	1.6-1.3m (5.2-4.2 7ft)	1.8-1.4m (5.9-4.5 9ft)	1.9-1.5m (6.2-4.9 2ft)
2.8	1.0-7.8m (3.3-2.5 6ft)	1.1-8.9m (3.6-2.9 2ft)	1.3-9.9m (4.3-3.2 5ft)	1.4-1.1m (4.6-3.6 1ft)
3.5	0.9-6.6m (3-2.1 7ft)	1.0-7.5m (3.3-2.4 6ft)	1.1-8.4m (3.6-2.7 6ft)	1.2-9.0m (3.9-2.9 5ft)
4.0	0.7-5.5mm (2.3-1.8ft)	0.8-6.3m (2.6-2.0 7ft)	0.9-7.0m (3-2.3ft)	1.0-7.5m (3.3-2.4 6ft)
4.5	0.7-4.7m (2.3-1.5 4ft)	0.7-5.3m (2.3-1.7 4ft)	0.8-5.9m (2.6-1.9 4ft)	0.8-6.3m (2.6-2.0 7ft)
5.6	0.7-3.9m (2.3-12.8ft)	0.7-4.5m (2.3-14.8ft)	0.7-5.0m (2.3-16.4ft)	0.7-5.3m (2.3-17.4ft)
8.0	0.7-2.8m (2.3-9.2ft)	0.7-3.2m (2.3-10.5ft)	0.7-3.5m (2.3-11.5ft)	0.7-3.8m (2.3-12.5ft)
11	0.7-2.0m (2.3-6.6ft)	0.7-2.2m (2.3-7.2ft)	0.7-2.5m (2.3-8.2ft)	0.7-2.7m (2.3-8.9ft)
16	0.7-1.4m (2.3-4.6ft)	0.7-1.6m (2.3-5.2ft)	0.7-1.8m (2.3-5.9ft)	0.7-1.9m (2.3-6.2ft)
22	0.7-1.0m (2.3-3.3ft)	0.7-1.1m (2.3-3.6ft)	0.7-1.3m (2.3-4.3ft)	0.7-1.4m (2.3-4.6ft)
32	—	0.7-0.8m (2.3-2.6ft)	0.7-0.9m (2.3-3ft)	0.7-1.0m (2.3-3.3ft)

- Use the table to check the automatic flash shooting distance. For example, if the flash head position is set at 50mm and the desired aperture value is f/5.6, the subject will be correctly exposed at a shooting distance between 0.7m (2.3ft) and 5m (16.4ft).

5. Second-Curtain Sync Flash Photography

With focal plane shutters, flash synchronization is made when the first curtain is fully open. With the Speedlite 300EZ, it is also possible to make the flash synchronization just before the second curtain starts running. This is called "second-curtain sync" and is best when a slower shutter speed is used. (The shutter-priority AE mode is recommended.)

When second curtain sync is used with a moving subject and a slow shutter speed, the light from the flash clearly illuminates the subject for a sharp image but creates a trailing image from ambient light for a flowing effect.

To use this function, set the sync position selector to the right side.

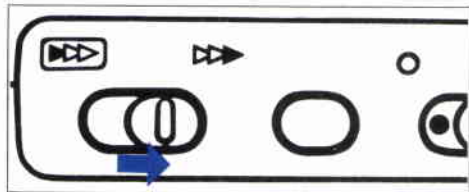

First-Curtain Sync Flash Photography



Second-Curtain Sync Flash Photography

Notes

1. Do not take the flash unit apart. If repair is necessary take it to the nearest Canon Service Facility.
2. Do not get the flash wet. If exposed to rain or snow, immediately wipe it off with a clean, dry cloth.
3. Do not fire the flash too close to the subject's eyes or while holding it against clothing.
4. Do not use the 300EZ with any other camera than Canon because the 300EZ is especially designed for use with Canon EOS cameras.
5. Use a slave unit for multiple flash photography, but before buying make sure it can be used with the 300EZ.

Speedlite Care

1. Remove the batteries if you do not expect to use the flash about three weeks or longer.
2. Do not store the flash in hot or humid places. Keep it out of direct sunlight.
3. After prolonged storage, test-fire the flash from time to time to maintain proper capacitor functioning.

Specifications

Type: Energy-saving, automatic, electronic flash unit uses A-TTL metering system to measure light reflected from the film surface. Clip-on type with directly coupled contacts. For exclusive use with EOS cameras.

Guide Number (at ISO 100):

Zoom position (mm)	28	35	50	70
Normal flash	22 (73)	25 (83)	28 (93)	30 (100)
Rapid-fire flash	5.5-15.5 (18-51)	6.2-17.7 (20-59)	7-19.8 (23-66)	7.5-21.2 (25-70)

(The above figures in parentheses indicate the guide numbers in feet at ISO 100.)

Flash Coverage Angle: Covers more than the fields of view of 28mm, 35mm, 50mm and 70mm using auto internal zoom mechanism.

Recycling Time:

	Alkaline	Ni-Cd
Normal flash	Approx. 0.3 to 8 secs	Approx. 0.3 to 6 secs
Rapid-fire flash	Approx. 0.3 to 1 sec	Approx. 0.3 to 1 sec

Number of Flashes:

	Alkaline	Ni-Cd
Normal flash	Approx. 200 to 2000	Approx. 65 to 650

Based on flash firing at 30 sec intervals with new alkaline or fully-charged Ni-Cd batteries.

Flash Duration: 1 msec or less

X-sync. Shutter Speed:

	EOS 620	EOS 650	Setting
P	1/60-1/250sec	1/60-1/125sec	Automatic
TV	30-1/250sec	30-1/125sec	Manual
Av	30-1/250sec	30-1/125sec	Automatic
M	30-1/250sec	30-1/125sec	Manual

Flash Control System: TTL series control system with preflash function.

Flash Exposure Level Control: A maximum of 1.5 BV steps in the A-TTL mode when subject brightness is more than BV5 according to the camera's metering system.

Film Speed Setting: Automatically set by the camera.

Automatic Shooting Distance Range:

A-TTL normal flash	Approx. 0.7 to 17m (approx. 2.3 to 55.8 ft)
A-TTL rapid-fire flash (min.)	Approx. 0.7 to 3.9m (approx. 2.3 to 12.8 ft)
A-TTL rapid-fire flash (max.)	Approx. 0.7 to 12m (approx. 2.3 to 39.4 ft)

Based on EF 50mm f/1.8 lens at ISO 100.
(The automatic shooting distance range extends according to film speed.)

Out-of-Coupling Range Warning: If a subject is too far away, the shutter speed and the aperture value blink in the viewfinder at the first stroke of the shutter button.

AF Auxiliary Light: Ultra-bright red LED (Peak sensitivity: 700nm) Projected at subject for AF flash photography. The effective distance is approx. 0.9-6m (3-19.7ft.)

Save-Energy Function: Power automatically turns off after five minutes of non-use when the main switch is left on.

Ready Lamp: As soon as it glows, the camera automatically switches to flash circuit. Yellow-green in the rapid-fire flash status, when sufficiently charged, the color turns to red. Test firing is possible by pressing the ready lamp after flash charge completion.

Power Source: Four size-AA (LR6) alkaline or Ni-Cd batteries. Carbon-zinc batteries may also be used.

Dimensions: 66(W) × 89(H) × 100.5(D)mm
(2-5/8" × 3-1/2" × 3-15/16")

Weight: 215g (7-9/16 ozs) without batteries;
315g (11-1/8 ozs) with batteries.
(All data is based on Canon's Standard Test Method.)

Subject to change without notice.

Free Manuals Download Website

<http://myh66.com>

<http://usermanuals.us>

<http://www.somanuals.com>

<http://www.4manuals.cc>

<http://www.manual-lib.com>

<http://www.404manual.com>

<http://www.luxmanual.com>

<http://aubethermostatmanual.com>

Golf course search by state

<http://golfingnear.com>

Email search by domain

<http://emailbydomain.com>

Auto manuals search

<http://auto.somanuals.com>

TV manuals search

<http://tv.somanuals.com>