

Canon

SPEEDLITE 577G



E

INSTRUCTIONS

Download from www.Somanuals.com. All Manuals Search And Download.

INTRODUCTION

The Speedlite 577G is Canon's most powerful electronic computer flash unit with many impressive automatic and professional features. With Canon SLR cameras, it goes well beyond the conventional meaning of automatic in flash photography. On a Canon New F-1, A-1, AE-1 PROGRAM, AE-1, AL-1 or AV-1 camera, it will automatically switch the shutter speed to the flash sync speed of 1/60 second. (1/90 second in the case of the New F-1.) Even the aperture will be set automatically for the New F-1 (Shutter-Priority Mode), A-1, AE-1 PROGRAM, and AE-1 as long as the lens is on "A". If using one of the New F-1's or A-1's slower shutter speeds is desirable, that is possible too. Flash photography with the 577G is as easy as turning on its power switch, selecting one of three apertures by sliding one switch and waiting for its pilot lamp to glow. Its many spe-

cial features and accessories offer all of the necessary options for obtaining beautiful and professional results. For control of shadows and better modeling of the subject, the flashhead tilts upward up to 120° and swings to the left and right 120° each way. Its unique bracket design insures quick release of the flash unit for varying the distance between the flash and the camera. And since it has a carefully mated, separate sensor which remains in the camera's hot shoe, correct exposure is obtained even when the flash itself is not aimed directly at the subject.

The 577G normally covers the angle of view of lenses having a focal length of at least 35mm, but with its Wide Adapter 577G-24, flash photography can also be done with 24 or 28mm lenses. Even flash photography with a 20mm lens can be accomplished by attaching the Wide

Adapter 577G-20, an optional accessory. With special synchro cords which are available on the market for connecting other Canon Speedlites, synchronized multiple flash is another option.

* Since the Canon Speedlite 577G does not have an internal power source, use of the Canon Transistor Pack G, which accepts either six C-size batteries or the Canon rechargeable Ni-Cd Pack TP, is required.

c3114-182

BASICS

Assembly.....	p.6
Transistor Pack G	p.9
How Automatic Flash Control Works.....	p.11
Setting the ASA Film Speed	p. 12
Setting the Shutter Speed	p. 12
Setting an Aperture on the Flash	p. 14
Setting the Aperture on the Camera	p. 15
Pre-Shooting Checks	p. 16
Shooting	p. 20

PARTS





CLAMPING BRACE

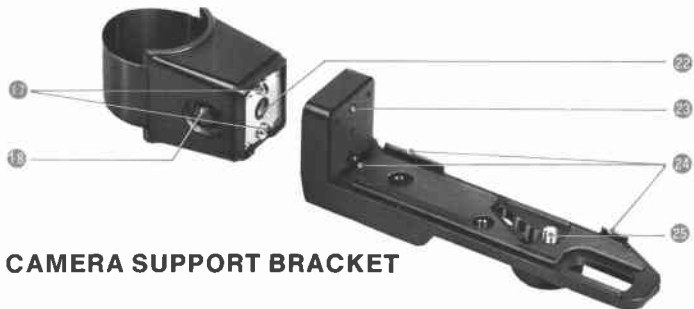

CAMERA SUPPORT BRACKET

- ① Flash Head
- ② Slow-Sync AUTO/MANU Switch
- ③ Transistor Pack G Connecting Socket
- ④ Synchro Cord Socket
- ⑤ Auto Shooting Distance Range Scales
- ⑥ ASA Film Speed Setting Dial
- ⑦ Attachment Groove for Wide and Tele Adapters
- ⑧ Aperture Selection Window
- ⑨ Aperture Selection Switch
- ⑩ Tilting Angle Indicator Window

- ⑪ AUTO/MANU Switch
- ⑫ Pilot Lamp (Flash Test Button)
- ⑬ Auto Check Lamp
- ⑭ Sensor Unit Socket
- ⑮ Positioning Groove
- ⑯ Bracket Coupling Pin
- ⑰ Tightening Screws
- ⑱ Slide Lock Release Button
- ⑲ Threaded Attachment Point
- ⑳ Camera Placement Positioning Groove
- ㉑ Tripod Screw Socket
- ㉒ Bracket Coupling Pin Socket



SENSOR UNIT



TRANSISTOR PACK G

- ㉓ Motor Drive MF Adapter Attachment Site
- ㉔ Framing Guides
- ㉕ Tripod Socket Screw
- ㉖ Wide Adapter 577G-24
- ㉗ Lock Nut
- ㉘ Synchro Cord A Socket
- ㉙ Sensor
- ㉚ Connecting Plug
- ㉛ Coupling Index
- ㉜ Pilot Lamp
- ㉝ Power Switch

ASSEMBLY

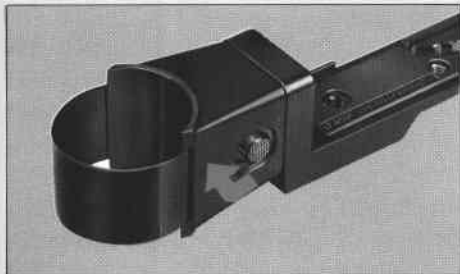

1 Slide lock button to left. While holding it in, pull flash section apart from camera support.



2 Screw large tripod-type screw into the threaded end of the groove.



3 Adjust position of support before completing.



4 Align the index on the clamp with positioning groove on the grip.



5 After sliding clamp on grip, re-tighten the two screws on flash section.

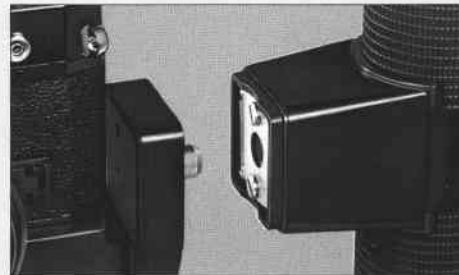

6 Align flash section with camera support section and push them together.

(1) Bracket to Camera

1. Slide the lock button on the flash section of the bracket to the left and, while holding the button in, separate the flash section from the camera support section (Photo 1).
2. Screw the large tripod-type screw into the camera support section of the bracket to the screw thread at one end of the groove (Photo 2).
3. Screw the tripod-type screw part-way into the tripod socket on the camera's base. Before screwing it in the rest of the way, shift the camera support back and forth until the ridges across the front of it are right up against the front of the camera. Make sure the camera is not sitting on top of these ridges. Also adjust the support sideways for the best fit. Then finish tightening the screw (Photo 3).

(2) Bracket to 577G's Grip

1. With a coin or a similar object, loosen the two large screws on the flash section. Separate the clamp from the rest of the section.
2. Align the index on the clamp with the positioning groove on the grip and slide the clamp as far up around the grip as you want (Photo 4).
3. Realign the flash section with the clamp and retighten the two screws (Photo 5). The clamp should be positioned on the grip so that, when assembly is completed, the flash will be facing straight ahead, in the same direction as the lens.

(3) Flash Section to Camera Support Section

Align the flash and camera support sections of the bracket and push them together (Photo 6). The lock button on the flash section will spring to the right when the two parts are locked together.

- * To separate the two sections of the bracket, slide the lock button on the flash section to the left and push it in. The lock button must also be in this position for coupling the two sections as above.

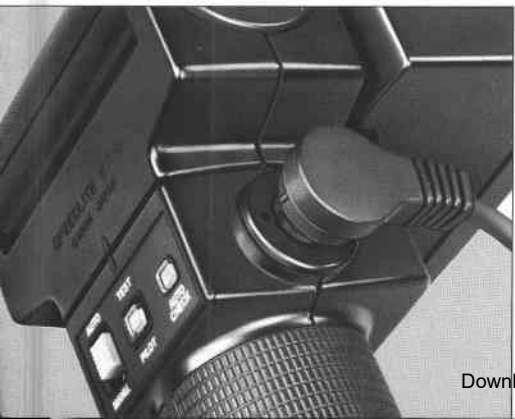
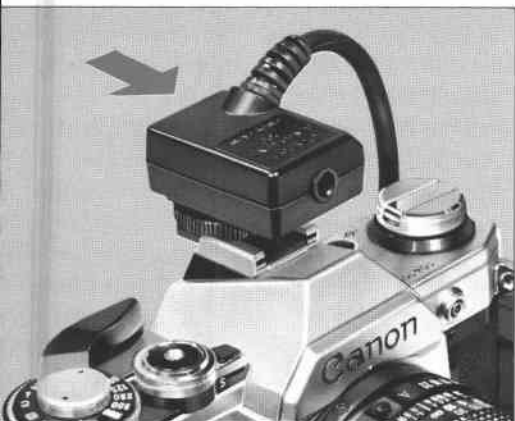

(4) Sensor Unit G20 to Camera and Flash

Rather than having a built-in sensor, the 577G has a separate one which slips into the camera's accessory shoe. It is very finely attuned to the particular Speedlite 577G with which it comes so that it can give the best results possible.

1. Loosen the sensor's lock nut and slide it into the camera's accessory shoe so that its eye is facing forward. If the accessory shoe is a hot shoe, be careful to push the sensor all the way in so that proper electrical connection will be made. Then tighten the lock nut.

2. To connect the sensor with the 577G, align the index on the plug at the end of its cord with the index on the 577G's sensor socket and push the plug in all the way.

* If the camera does not have a hot shoe, Synchro-Cord A, an optional accessory, must also be

attached. See p. 31.

- * A flash coupler must be used to attach the sensor to the Canon F-1. Three are available as optional accessories. Flash Coupler F is especially for this combination. Flash Coupler D or L may also be used.
- * Since the 577G and the sensor provided with it are so carefully matched to each other, they should be considered a set. Do not use the 577G with a different sensor unit G20.

TRANSISTOR PACK G

This accessory provides power for Speedlite 577G.

Proper Batteries: Six new C-size alkaline-manganese batteries or the Canon Ni-Cd Pack TP (optional

accessory), which is rechargeable. The Ni-Cd pack should be fully charged.

1



Turn off the transistor pack's power switch.

2



Insert the set of six alkaline-manganese batteries into battery magazine TP.

3



Insert the transistor pack into its case and rehook the cord.

4



Align the plug's index with the 577G's power source socket index. Push plug into socket.

5



Turn on transistor pack's power switch. Lamp next to it should light up.

6



Turn 577G's AUTO/MANU switch to AUTO for automatic flash control.

1. Unhook the Transistor Pack G's cord from its case and remove the pack from the case.
2. Turn off the transistor pack's power switch (Photo 1).
3. Insert the set of six alkaline-manganese batteries into battery magazine TP as illustrated. Then align the contact on the magazine with the transistor pack's and insert the one into the other (Photo 2).
OR
Insert a fully-charged Ni-Cd Pack TP into Transistor Pack G the same way as battery magazine TP is inserted.
4. Reinsert the transistor pack into its case as shown in the photo. Then rehook the cord (Photo 3).
5. Align the index on the plug at the end of the transistor pack's cord with the index on the 577G's external power source socket. Push the plug securely into the socket

(Photo 4).

6. Turn on the transistor pack's power switch. The lamp next to the power switch should light up (Photo 5).
 7. Make sure the usual preparations as described in the following pages have been made on camera, flash and lens and wait for the 577G's pilot lamp to glow. Then take the picture (Photo 6).
- * The transistor pack's operation lamp glows as long as the power switch is on and there is power. However, even when it is glowing, the batteries should be replaced with new ones or the Ni-Cd Pack TP should be recharged if the flash unit's recycling time becomes longer than usual.
 - * When the batteries wear out, replace all of them at the same time with a set of new ones which are all of the same brand.

- * If you do not expect to use Transistor Pack G for a long time, remove the alkaline-manganese batteries from the magazine. Ni-Cd Pack TP may be left inserted but the power switch must be off to prevent corrosive battery leakage and other potential damage.
- * Be sure the transistor pack's power switch is off whenever it is not in use.
- * Should the battery temperature rise in continuous shooting with C-size batteries, you may rest at ease, for it is a normal condition.
- * There is a protective lining between Battery Magazine TP and Transistor Pack G. Before using, remove this lining. It may be thrown away.

HOW AUTOMATIC FLASH CONTROL WORKS

The 577G's sensor acts something like the camera's photocell; it measures the intensity of light from the flash which is reflected back from the subject. When it decides that the subject has received enough light, it automatically cuts off flash emission.

In order to do this properly, the sensor must, like a camera's photocell, be as close to the film as possible and facing the subject. Since the 577G's sensor is separate in the camera's accessory shoe, it is always in the best position to measure the light correctly even while the flash unit itself can be aimed in many different directions for the best lighting effect.

To make its decision on when the subject has received enough light, the sensor must know three things: 1) the film speed, 2) the aperture and 3) the shutter speed. You must always set the ASA film speed on the flash by hand, but depending on the camera you use, the flash may set the aperture, the shutter speed or both automatically. The table on the left shows the various ways that the aperture and shutter speed may be set with various cameras.

Flash Mode	Camera	Shutter Speed Setting	Aperture Setting
Full Autoflash	A-1, AE-1 PROGRAM, AE-1, New F-1 (Shutter-Priority AE Mode)	Automatically switches to X-sync unless on "B"	Automatic (When using FD lens set on "A" mark)
Automatic Shutter Setting Autoflash	AL-1, AV-1, New F-1 (Aperture-Priority AE or Manual Mode)	Automatically switches to X-sync unless on "B"	Manual
Normal Autoflash	F-1 or other cameras	Manual (to X-sync)	Manual

SETTING THE ASA FILM SPEED

The sensor must know the ASA film speed to give correct exposure. Make sure it is set correctly on both the camera and the flash. To set it on the 577G, rotate the calculator dial until the film speed index is aligned with the ASA speed which corresponds to that of the film in the camera.

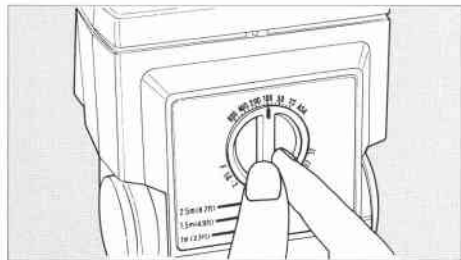

SETTING THE SHUTTER SPEED

Canon New F-1

Normal Flash Photography: Once the 577G is attached to the camera and its pilot lamp is glowing, the camera switches automatically to a sync speed of 1/90 sec., provided the shutter dial is not on "B".

Slow Sync Flash: Set the 577G's slow sync switch to MANU. Then turn the camera's shutter dial to any speed from 1/60 sec. to 8 sec.

Canon A-1 Camera

Normal Flash Photography: Make sure the 577G's slow-sync AUTO/MANU switch is on "AUTO". Except for "B" (Bulb), the AT dial and AE mode selector may be on any setting and the shutter speed will switch to 1/60 sec., the flash synchronization speed, *automatically* as soon as the 577G's pilot lamp glows. If the AT dial is set to "B", you will be in control of exposure duration just as you normally are with "B".

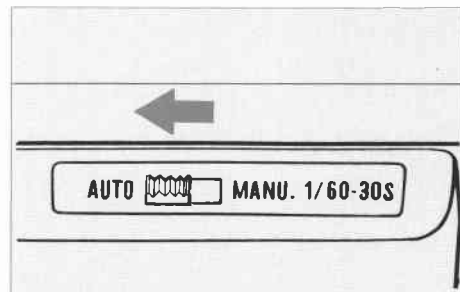

Slow Sync Flash: Set the 577G's slow-sync AUTO/MANU switch on "MANU". Set the AT dial to a shutter speed from 1/60 sec. to 30 sec. The picture will be taken at the speed to which the dial is set.

Canon AE-1 PROGRAM, AE-1, and AL-1

Except for "B", the shutter speed dial may be on any setting and the shutter speed switch to the flash sync speed of 1/60 sec. *automatically* as soon as the 577G's pilot lamp glows. If the dial is set to "B", "B" will be the exposure duration.

Canon AV-1

The shutter speed will switch to the flash sync speed of 1/60 sec. automatically when the 577G's pilot lamp glows if the selector dial is on the red  (the preferable setting). It will stay on 1/60 sec. continuously if the dial is set to "60 1/2". If the dial is on "A Self" or "Self 1/2", the shutter speed will be 1/60 sec. and the flash will be synchronized with the camera for a delayed shot by self-timer.

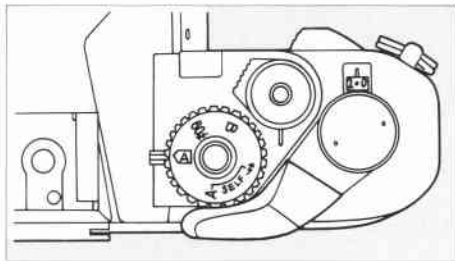

Other Cameras

Set the shutter speed dial by hand to the camera's X flash synchronization speed: e.g., to 1/60 sec. or slower on the Canon F-1.

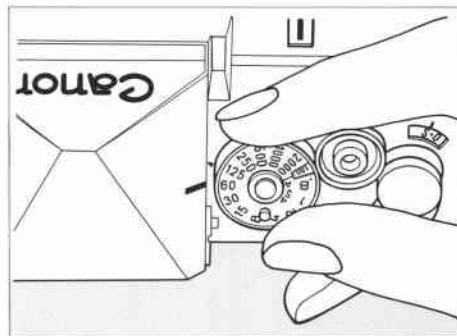

SETTING AN APERTURE ON THE FLASH

You set an aperture with the aperture selection switch on the back of the 577G. The switch has three color-coded positions: red, green and yellow. As you slide the switch, the color of the position you have set will appear in one of three windows on the back of the flash.

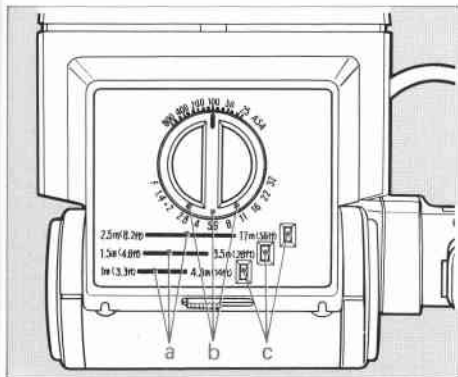

- a) Auto Shooting Distance Ranges
- b) Auto Aperture Indices
- c) Selection Switch Position Indicators

Each position has a corresponding aperture and auto shooting distance range. The auto aperture is the f-number which is directly opposite the dot which is the same color as the position of the aperture selection switch. It changes with the ASA film speed you have set on the calculator dial. For instance, if you have set the aperture selection switch to the red position, the auto aperture will be f/2.8 at ASA 100 but f/5.6 at ASA 400.

The auto shooting distance range is indicated by the straight white line which is directly opposite the setting of the aperture selection switch. There are three lines, one for each position of the switch. Each represents the range of distances from the subject for which that position of the selection switch will give correct exposure. If the camera is out of that range, the subject will be over- or underexposed. There are two ways

to check that the camera is within that range: either by reading the lens' distance scale after focusing or by the auto check lamp (see p. 16). When you are deciding which of the three positions of the selection switch you should set, place prime importance on the shooting distance range. If the actual shooting distance falls within the range of two or all three positions, take depth of field into account.

* The indicated auto shooting distance ranges only hold true if the flash is pointing straight at the subject. If the flash head is tilted or swung for bounce flash, or if the flash is held some distance from the camera, rely on the auto check lamp to tell you if you are within the correct range (see p. 26). These ranges also change if a wide or tele adapter is attached. See p. 23 and "Specifications", p. 35.

SETTING THE APERTURE ON THE CAMERA

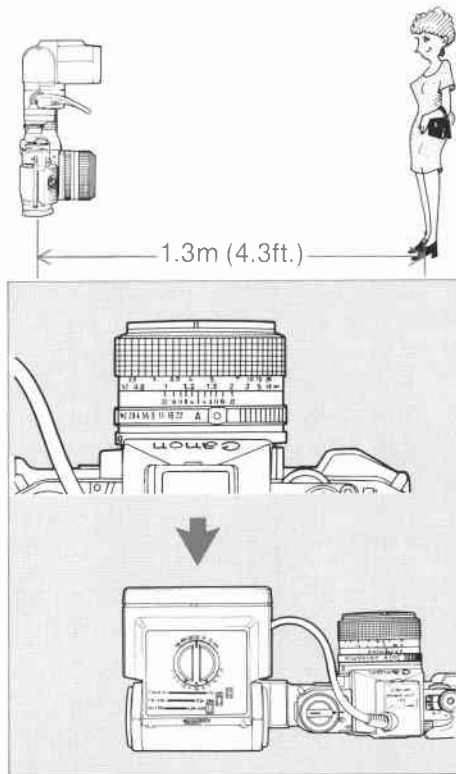

New F-1 (Shutter-Priority Mode), A-1, AE-1 PROGRAM, and AE-1

- **FD Lens:** Leave the lens on "A". The aperture you have set on the flash will be set on the camera automatically when the 577G's pilot lamp glows. The settings of the A-1's AE mode selector and AT dial do not matter (except in relation to shutter speed, p. 12). [If you wish, you may remove the aperture ring from "A" and turn it to the auto aperture you have set on the flash or to a different aperture to make an exposure correction. In this case, remember to reset the aperture each time you reset the selection switch on the 577G.]

- **FL Lens:** See "Other Cameras", next column.

New F-1 (Manual, Aperture-Priority Modes) and Other Cameras

Turn the aperture ring to the same aperture you have set with the selection switch on the flash or to a different aperture if you wish to correct exposure.

PRE-SHOOTING CHECKS

I. Test Firing and Auto Shooting Check

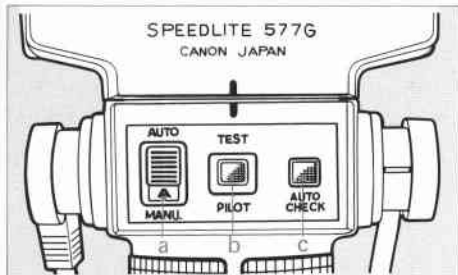

- a) AUTO/MANU Switch
- b) Pilot lamp
- c) Auto Check Lamp

Now that all camera, lens and flash settings have been made, turn on the power switch on Transistor Pack G. After the flash reaches sufficient charge for firing, the pilot lamp will glow and you can take a flash picture anytime. If you wish to check the flash and whether the shooting distance is

correct, press the pilot lamp after it glows. A flash should be fired. If the auto check lamp next to the pilot lamp lights up right afterwards for about two seconds, it means that your shooting distance will give correct exposure. If it does not glow, either set the aperture selection switch to a better position or move closer to your subject. This method of checking shooting distance is especially helpful when the flash is tilted or swung for bounce flash (p. 25).

- * The auto check lamp tells you whether you are close enough to your subject but not whether you are far enough away. Even if you are too close to get a well-exposed picture, it will still glow, so always keep the shooting ranges given on the back of the flash in mind and double check the lens' distance scale if you think you might be too close.

II. Checking Viewfinder Information

The Canon New F-1, A-1, AE-1 PROGRAM, AL-1, AE-1 and AV-1 have special viewfinder information for flash photography. You can check it by pressing the shutter button halfway after the pilot lamp glows.

New F-1 Information

- (1) Full Autoflash Mode: Shutter-Priority AE Mode (with AE Motor Drive FN or AE Power Winder FN attached, FD lens on "A" and shutter dial not on "B").

(example)



30

Film Speed of ASA 100; Aperture Selection Switch at red position; Slow-Sync AUTO/MANU Switch on AUTO.

* Shutter speed is automatically set to 1/90 sec., even though shutter speed display shows what has been set on the shutter dial.

(2) Automatic Shutter Setting Autoflash Mode: Manual Mode or Aperture-Priority AE Mode (the latter mode with AE Finder FN, shutter dial on "A").

(example)



30

Manual Mode: Turn the lens aperture ring to the same aperture set on the flash. The aperture needle points to the aperture that has been set on the lens.

Aperture-Priority AE Mode: Film Speed of ASA 100; Aperture Selection Switch at red position; Slow-Sync AUTO/MANU Switch on AUTO.



2.8

* Manually set the aperture to the lens the same aperture that has been selected for the flash.

* The camera switches automatically to X-sync (1/90 sec.) and the meter needle points to the right of 1/60 sec.

A-1 Information

(1) Full Autoflash Mode: FD lens on "A" and AT dial not on "B".

(example)



Film Speed: ASA 100, Aperture Selection Switch: Red position, Slow-sync AUTO/MANU Switch: on AUTO.

(2) Automatic Shutter Setting Autoflash Mode: FD lens off "A" and AT dial not on "B".

(example)



Film Speed: ASA 64, Aperture Selection Switch: Yellow position, Slow-sync AUTO/MANU Switch: on AUTO.

60indicates shutter speed is 1/60 second.

Findicates sufficient charge for firing flash.

2.8, 9.5...is the aperture set on flash. Even if you turn the aperture ring to a different aperture from that set on the flash, the viewfinder will still show the aperture on the flash. However, the picture will be taken at the aperture you have set on the lens.

Mreminds you that you have taken the aperture ring off "A" to set an aperture by hand.

* With an FL lens, viewfinder information on aperture is not always reliable. Make sure the aperture ring is set to the aperture chosen on the flash.

* If the AT dial is on "B", "bu" replaces shutter speed information

in the viewfinder for both flash modes. Automatic flash control is possible on "B".

(example)



* The aperture display may be one half f/stop off the one set on the flash. This is because the aperture display is rounded off to half f/stops; it will not affect exposure.

A-1 Warnings

1. Aperture display blinks showing maximum aperture: means the aperture set on the flash is probably larger than the lens' maximum aperture. Set the aperture selection switch to a smaller aperture. *Be sure to check the aperture set on the flash if this happens.*

(If the display blinks with an aperture which is the same as the lens' maximum aperture, exposure will be correct anyway.)

2. Aperture display blinks showing aperture of 1/16 to f/32: means aperture set on flash *may be* too small. Check the aperture set on the flash. If it is the same or larger than the lens' minimum aperture, exposure will be correct. Otherwise, set the 577G's aperture selection switch to a larger aperture.

(example)



AE-1 PROGRAM, AE-1 Information

- (1) Full Autoflash Mode: FD lens on "A" and shutter speed dial not on "B".

(example)

Film Speed: ASA 100; Aperture Selection Switch: Red position.

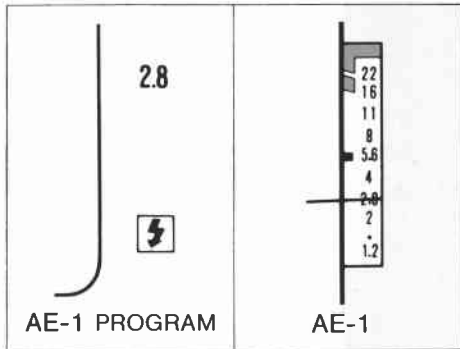

- (2) Automatic Shutter Setting Autoflash Mode: FD lens off "A" or FL lens. ("M" mark will flash in AE-1 viewfinder, and will light up in AE-1 PROGRAM view-

finder. It reminds you that you have taken the aperture ring off "A" for manual aperture setting.)

AE-1 PROGRAM Warnings

The aperture selected on the flash will blink in the viewfinder if that aperture is larger than the maximum aperture of the lens.

AE-1 Warnings

1. Underexposure warning lamp blinks: means the aperture set on the flash is larger than the lens' maximum aperture. Set the aperture selection switch to a smaller aperture (lamp should stop blinking).
2. Meter needle swings into overexposure warning zone: means aperture set on flash *may be* too small. Check it. If it is the same or larger than the lens' minimum aperture, exposure will be correct. If it is smaller, set the aperture selection switch to a larger aperture.

AL-1, AV-1 Information

- (1) Automatic Shutter Setting Autoflash Mode: Selector dial not on "B".

- * Synchronized flash photography is possible only when the meter needle points to 1/60 second.

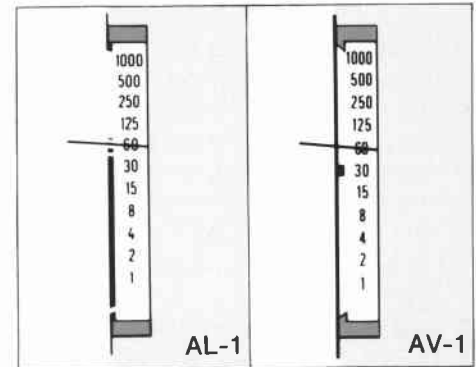

SHOOTING

Once all preparations detailed on the preceding pages have been made, make sure the subject is in focus and that the 577G's pilot lamp is glowing. Then press the shutter button to take the picture. If the auto check lamp glows immediately afterwards, it means that you were close enough to the subject for correct exposure.

- * In delayed flash photography with the camera's self-timer, do not press the shutter button to set the timer until the pilot lamp glows.
- * When the shooting distance is less than one meter, the difference between the optical axes of the lens and the flash may result in uneven lighting.
- * Since it is possible for viewfinder information in the New F-1, AE-1, AL-1, or AV-1 to be the same in flash photography as in normal AE photography, it is advisable to check that the pilot lamp is glowing before shooting.

- * You can continue flash photography if the pilot lamp is still glowing after the shutter is released. If the pilot lamp does go out after a flash shot, you can take a shot in the normal AE mode while waiting for it to glow again. (This, however, does not apply when the shutter speed is set to "B" or when the camera is not set for AE photography.) Make sure that the shutter speed or aperture which will be used for normal AE photography will give correct exposure, too.
- * When the flash is no longer necessary, be sure to turn off the Transistor Pack G's power switch to prevent battery drain. With the power switch off, it is possible to shoot normally without detaching the flash or the sensor.
- * While performing normal AE photography as the flash recycles, there is a possibility that, while the

shutter curtain is open, the 577G's pilot lamp will glow and the flash may fire. In this case, correct exposure cannot be guaranteed.

PROBLEM BACKGROUNDS

Certain types of background may lead to incorrect exposure. A very small subject against a very dark or distant background may turn out overexposed. On the other hand, if the surroundings are bright white with strong reflections, the subject may be underexposed.



SPECIAL FEATURES

Wide Adapter 577G-24.....	p. 23
Manual Flash Photography	p. 24
Bounce Flash.....	p. 25
Bounce Flash on Manual.....	p. 26
Slow-Sync Flash Photography.....	p. 28
(with Canon New F-1 and A-1 only)	
Multiple Flash	p. 30
Use of 577G on Camera without Hot Shoe	p. 31

WIDE ADAPTER 577G-24

Normally, light from the 577G is spread wide enough to cover the angle of view of a 35mm or longer lens. If it were used with a wider angle lens, the edges of the picture would be too dark. With the Wide Adapter 577G-24, the flash unit's light is diffused enough to cover the angle of view of 24mm and 28mm lenses also. (It may also be used with lenses longer than 28mm). At the same time, the unit's power is reduced and the farthest distances at which you can shoot are closer than they usually are.

To attach the wide adapter, simply slide it in the grooves of the flash head so that the colored distance scales on its one side are facing the back of the flash. These distance scales, which show the reduced shooting ranges, replace the ones below the calculator dial. They are color-coded to match the three positions of the aperture selection dial.

In all other respects, the flash may be used as usual.

- * With Wide Adapter 577G-24 attached, the 577G's guide number becomes 28 at ASA100.
- * If you use the flash with Wide Adapter 577G-24 and a 24mm lens to copy a flat subject, the picture will be dark around the edges. This combination is mainly for taking pictures of three-dimensional subjects.
- * For using the flash with a lens having a focal length down to 20mm, Wide Adapter 577G-20 is available as an optional accessory.



MANUAL FLASH PHOTOGRAPHY

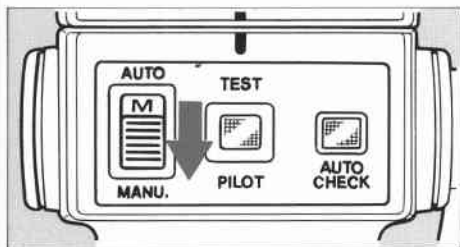

Setting the flash mode switch on the back of the 577G to MANU puts the unit on manual operation. While on automatic the 577G's sensor automatically cuts off the flash duration at the correct point, on manual the flash operates at maximum duration for every firing. The shutter speed should be set as usual (p. 12), but the correct aperture can no longer be found with the unit's calculator dial. Instead, it must be calculated using a guide number formula, which follows:

$$f/\text{stop} = \frac{\text{Guide Number}}{\text{Shooting distance}}$$

Since the guide number changes with film speed, the 577G is provided with a sticker which gives the guide numbers in meters for various ASA film speeds. Guide numbers are also given for when a Tele Adapter 577G or Wide Adapter 577G-24 or 577G-20 is attached. The sticker should be attached to a convenient place on the flash unit, such as on the underside of the flashhead.

Since these guide numbers are expressed in meters, the shooting distance in the guide number formula should also be in meters. When the flash is used normally, pointed straight at the subject and neither tilted or swung nor held away from the camera, the shooting distance may be read directly from the lens' distance scale after focusing. If the flash is held away from the camera, the shooting distance means the distance from flash to subject, which should be measured with a tape

measure if necessary. (Remember that for holding the flash away from the camera a synchro cord is necessary.)

The 577G's pilot lamp lights up once the flash has reached sufficient charge, which does not mean that it is fully charged yet. While compensation for this is automatic when the flash is on automatic operation, it is not when the flash is on manual. Therefore, it is necessary to wait for about 15 seconds after the pilot lamp lights (i.e., until the flash reaches maximum charge), before you press the shutter button. If you are not using new or fully charged batteries, it will be necessary to wait longer. If it is absolutely necessary to fire the flash immediately after the pilot lamp glows, open the lens around one f/stop to make up for the fact that the flash is not yet fully charged.

BOUNCE FLASH

Using the 577G on manual operation is recommended whenever you run into a problem background (p.20), when you are shooting at very close range or when you are attempting special effects, such as a high or low-key picture, or using the flash as fill in daylight.

Light from a flash pointed directly at the subject tends to be harsh and bright, creating a large difference between dark and bright areas of the picture. A softer, less contrasty, often more pleasing light, which usually does a more effective job of modeling the subject, can be created by bouncing the flash off a nearby wall or ceiling.

The 577G's head can be tilted upwards up to 120° with click-stops at 60°, 75° and 90° for bouncing the light off the ceiling. It can also be swung 120° to the left or right with click-stops at 60°, 75°, 90° and 105° for bouncing the light off a wall. The flash head may be both tilted and swung at the same time, taking into account the distance from flash to wall or ceiling and from wall or ceiling to subject, for the best overall results. It need not be set to a click-stop position for firing.



BOUNCE FLASH ON MANUAL

When the flash is bounced off a wall or ceiling before it reaches the subject, it is actually traveling a longer distance than it would be if it were aimed directly at the subject. As a result, the light intensity is weaker and it is necessary to take this extra distance into account to be sure of correct exposure. As long as the auto check lamp (p. 16) lights up after actual or test firing, there will be enough light. It is important to remember that the distance scales on the back of the unit do not apply when the flash is bounced. Other than that, the flash may be used as usual.

The surface off which the flash is bounced should preferably be white or near-white, fairly large and highly reflective. If the reflecting surface is colored, the subject may turn out tinted that color. The color may also be disappointing if the surface is a poor reflector. A very high ceiling

does not make a good surface for bounce flash; a better solution would be to bounce the flash off a white-card reflector. Generally, the closer the flash is to the surface, the brighter and higher in contrast the picture.

It is generally said that there is a loss of light intensity of about two f/stops when the flash is bounced off a 2.5 meter high ceiling. Losses of this order require an adjustment in the f/stop calculated by guide number formula when the flash mode switch is on MANU. Since the exact correction depends on the distance of the reflecting surface from the flash and subject, its color and its reflectivity, it is best to bracket exposure.



Direct Flash Photography



Bounce Flash Photography

SLOW-SYNC FLASH PHOTOGRAPHY (WITH NEW F-1 AND A-1 ONLY)

In normal use, the best shutter speed for flash photography with most Canon SLRs, including the New F-1 and A-1, is the X-sync speed (1/90 sec. for New F-1 and 1/60 sec. for A-1). It is just slow enough for the first shutter curtain to travel across the film before the second shutter curtain is released, which means that the entire film will be exposed to the flash. On the other hand, it is just fast enough to stop the motion of most subjects requiring flash.

When you use this flash on a Canon New F-1 or A-1, however, you have the option of taking a flash picture at a shutter speed slower than X-sync. Simply set the 577G's slow-sync AUTO/MANU switch to MANU and the camera's shutter speed to a speed slower than X-sync. Thus, for the New F-1, set the shutter dial to any speed between 1/60 sec. and 8 sec.; for the A-1, set the AT dial to

any speed between 1/30 sec. and 30 seconds. The picture will be taken at the speed you have set on the camera, and the flash will fire after release of the first shutter curtain. The advantage of using a shutter speed slower than X-sync is that the background will look lighter. But, even with the switch set to MANU, if the shutter speed that has been set on the camera is at X-sync or faster (i.e., 1/90 sec. or faster with the New F-1, and 1/60 sec. or faster with the A-1), the actual shutter speed will be set automatically to the X-sync. In all other respects, use of the flash remains the same.



- * The shutter speed display in the A-1's viewfinder will show the one set with the AT dial.
- * With any camera other than the New F-1 or A-1, it does not matter whether the slow-sync AUTO/MANU switch is on AUTO. The shutter speed is set according to information on p. 12.

EFFECT OF AUTO/MANU POSITIONS AND A-1's "AT" DIAL ON ACTUAL SHUTTER SPEED

Setting of Slow-Sync AUTO/MANU Switch	AT Dial Setting	Actual Shooting Shutter Speed
AUTO	any setting but "B"	1/60 sec.
	"B"	"B"
MANU	1/60 sec. - 1/1000 sec.	1/60 sec.
	1/30 sec. - 30 sec.	speed set on AT dial
	"B"	"B"



Normal Flash Photography



Slow-Synch Flash Photography

MULTIPLE FLASH

It is possible to synchronize another Canon Speedlite, such as the 155A, 177A or 199A, with the 577G by connecting them together with a Y-shaped synchro cord. Three or more of these flashes may be fired simultaneously by equipping those which are not on the camera with slave units. Y-shaped synchro cords and slave units are optionally available on the market. The following illustrations show how to make the necessary connections.

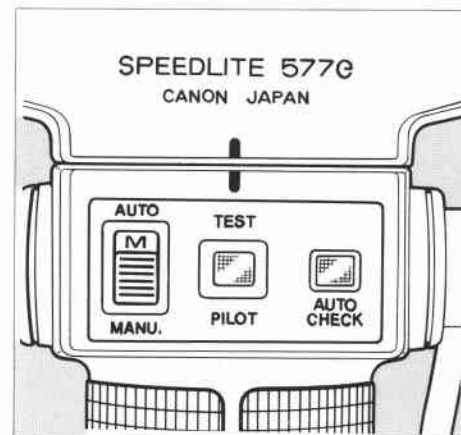
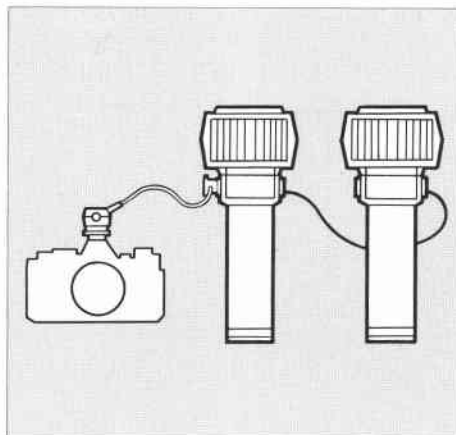

All of the flash units, including the 577G, should be used on manual. If the flash has an AUTO/MANU mode switch, slide it to MANU.

The proper aperture may be found by guide number formula (p.24) based on an overall guide number which can be calculated with the following equation:

$$G = \sqrt{G_1^2 + G_2^2 + G_3^2 + \dots G_n^2}$$

G = effective guide number

G₁, G₂, G₃ ... guide number of each Speedlite

USE OF 577G ON CAMERA WITHOUT HOT SHOE

The aperture found by putting this guide number into the guide number formula must then be set on the lens by hand no matter what the camera. Please note that the above equation is only useful when all of the flashes are placed close to the camera and pointed straight at the subject.

- * If a multi-flash setup is used with a Canon AL-1 or AV-1 camera, use a Canon Hot-Shoe Adapter (optional accessory).
- * When using the 577G with the New F-1, A-1, AE-1 PROGRAM, or AE-1, set the shutter speed at X-sync or slower. Set the lens aperture manually off the "A" mark using the guide number formula.

If the camera does not have electrical contacts for flash photography in its accessory shoe, a synchro cord must be connected between the sensor and the camera for proper synchronization. Available for this is an optional accessory called Canon Synchro Cord A. First make sure the Transistor Pack G's power switch is off. Plug the two-pronged end of the cord into the socket on the side of Sensor Unit G20. Plug the other end into the camera's PC socket. For setting the shutter speed and aperture, see "Other Cameras", pp. 13, 15.

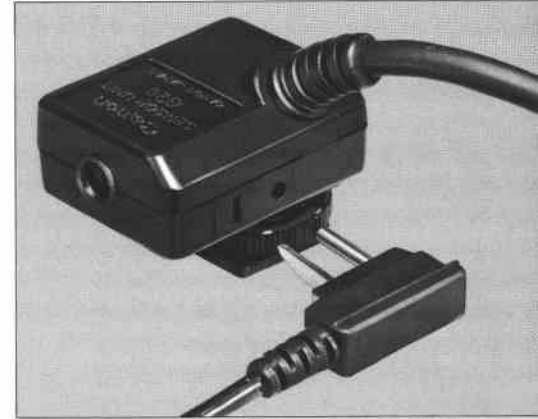

RELATED OPTIONAL ACCESSORIES

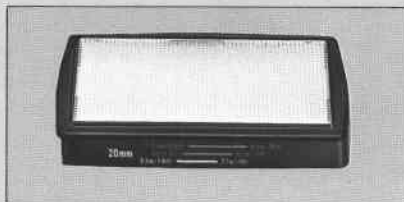

Wide Adapter 577G-20



Sensor Unit G100



Tele Adapter 577G



Flash Coupler F



Adapter For Motor Drive MF

Wide Adapter 577G-20

This accessory performs the same function as Wide Adapter 577G-24 except it makes it possible to use the 577G with lenses down to 20mm in focal length. It should be attached in the same way as Wide Adapter 577G-24 and also has color-coded distance ranges on its side which replace those on the flash. In all other respects, the flash may be used as usual. With this accessory, the 577G's guide number becomes 24 at ASA 100.

Tele Adapter 577G

This screen is for using the 577G with a lens having a focal length of 100mm or more. Simply slide it over the flashhead in the same way as the Wide Adapter 577G-24 so that the colored distance ranges on its side can be seen from the back of the camera.

Sensor Unit G100

This accessory assures correct exposure measurement when the flash is detached and used up to about one meter away from the camera. It may be attached in the same way as Sensor Unit G20.

Flash Coupler F

This accessory is specially designed for mounting the 577G's sensor on a Canon F-1 camera. Further details may be found in its individual instructions.

Adapter for Motor Drive MF

With this accessory, the bracket may be mounted on the base of a Canon Motor Drive MF. Screw it into the socket on the side of the camera support section of the bracket as illustrated. The pin should be inserted into the socket on the side of the motor drive. Position the motor drive properly on the support before finally tightening the attachment screw.

HANDLING PRECAUTIONS

1. Since a high-voltage circuit is built into the flash, it would be dangerous to take it apart by yourself. If repair is necessary, take it to the nearest Canon service station.
2. Do not let the flash get wet. If it is exposed to rain or snow, immediately wipe it off with a dry cloth.
3. Do not fire the flash too close to your subject's eyes or while holding it against clothing.
4. For safety's sake, do not touch the external power source socket or additional-light socket with a pointed object, such as tweezers.

CARE OF THE FLASH

1. Remove the batteries from the magazine if you do not expect to use the flash for a long time.
2. Do not store the flash in hot or humid areas. Keep it out of direct sunlight.
3. If the flash is not used for a long time, it is necessary to test fire it from time to time to maintain proper function of the capacitor.

SPECIFICATIONS

SPEEDLITE 577G

Type: Electronic computer flash with a series control system.

Attachment: By Canon One-Touch Bracket.

Synchronization: By direct contact in separate sensor unit which mounts in camera's hot shoe. Tightened by lock nut.

Guide Numbers:

48 (ASA 100, m), 80 (ASA 25, ft) without any adapter

28 (ASA 100, m), 46 (ASA 25, ft) with Wide Adapter 577G-24

24 (ASA 100, m), 40 (ASA 25, ft) with Wide Adapter 577G-20

63 (ASA 100, m), 100 (ASA 25, ft) with Tele Adapter 577G

Reached after pilot lamp lights up when new batteries are loaded.

Flash Coverage: For 35mm format, covers an angle of view of

35mm lens without adapters,

24mm lens with Wide Adapter 577G-24,

20mm lens with Wide Adapter 577G-20,

100mm lens with Tele Adapter 577G.

Recycling Time:

Alkaline-Manganese batteries: About 0.2-18 sec.

after ten firings when the batteries are new.

Ni-Cd batteries: About 0.2-7 sec. after ten firings when the batteries are fully charged.

Recycling time means interval between firing on flash and relighting of pilot lamp with new or fully-charged batteries.

Number of Flashes:

Alkaline-Manganese batteries: About 100-1000 times allowing 30 sec. between each firing.

Ni-Cd batteries: About 75-750 times allowing 30 sec. between each firing.

Number of flashes is counted when the flash is fired in 30 sec. intervals with new or fully-charged batteries.

Color Temperature: Same as that of daylight.

Flash Duration: 1/400-1/50,000 sec.

Flash Control System: The sensor measures the light reflected back from the subject and automatically cuts flash output when subject has had enough. Series control system saves unused energy for next firing.

Metering Sensitivity Pattern: Even distribution over entire area for average measurement.

Auto Flash System: Selection of three color-coded positions (red, green, yellow) with corresponding

auto apertures and auto working distance ranges.

Auto Apertures at ASA 100: Red—f/2.8, Green—f/5.6, Yellow—f/11.

Auto Distance Ranges:

	Red	Green	Yellow
No Adapters	2.5m-17m 8.2ft.-56ft.	1.5m-8.5m 4.9ft.-27.9ft.	1m-4.3m 3.3ft.-14ft.
With Wide Adapter 577G-24	1.5m-10m 4.9ft.-33ft.	1m-5m 3.3ft.-16.5ft.	0.5m-2.5m 1.6ft.-8.2ft.
With Wide Adapter 577G-20	1.5m-8.5m 4.9ft.-28ft.	1m-4.2m 3.3ft.-14ft.	0.5m-2.1m 1.6ft.-7ft.
With Tele-Adapter 577G	2.5m-22.5m 8.2ft.-74ft.	2.5m-11.2m 8.2ft.-37ft.	2.5m-5.6m 8.2ft.-18.5ft.

Film Speed Scale: ASA 25 to ASA 800 (DIN 15 to DIN 30).

Aperture Scale: f/1.4 - f/32.

Pilot Lamp: Glows to indicate the flash has enough charge to fire a flash. As soon as it glows, the Canon A-series cameras and New F-1 automatically switch to flash circuit. The pilot goes out when the

main switch is turned off.

Test Firing: By pressing pilot lamp after it glows.

Auto Check: By check lamp which will glow after test or actual firing to show that flash is close enough to subject.

AUTO/MANU switch: for manual operation. Proper f/stop must be determined by using guide number formula and synchronization speed must be manually set.

Slow Sync (New F-1 and A-1 only): The use of shutter speeds between 1/60 sec. and 8 sec. for the New F-1 or 1/30 sec. and 30 secs. for the A-1 is possible by setting the slow sync AUTO/MANU switch to the MANU. position.

Bounce Flash: Maximum upward tilt of 120° with detents at 0°, 60°, 75°, 90°, and 120°. Bounce angle is displayed. 120° shift to both left and right with detents at 0°, 60°, 75°, 90°, 105° and 120°.

Contacts: Synchro terminal, sensor unit connecting socket, external power source connecting socket.

Power Source: External using Canon Transistor Pack G which takes six C-size alkaline-manganese batteries or rechargeable Ni-Cd Pack TP.

Size and Weight: Grip diameter 44mm (1-1/4 inch). 99 x 107 x 245mm, 600g
2-7/8 x 4-1/4 x 9-5/8 inch., 21-3/16 ozs.

(without batteries, with the flash head in direct forward position)

Subject to change without notice.

TRANSISTOR PACK G

Type: Portable with strap

Battery Chamber: Battery Magazine TP for C-size alkaline-manganese batteries or Canon Ni-Cd Pack TP are usable.

Power Switch: OFF/ON rotating switch

Pilot Lamp: Lights up when the power switch is on assuring proper operation.

Power Cord: Three-ply spiral cord (approximately 1.5m, 5 ft.)

Booster Circuit: Built-in

Recycling time and Number of Flashes:

Refer to the 577G's specifications.

Size and Weight: 91 x 194 x 34.5mm, 320g

(3-9/16 x 7-5/8 x 1-3/8 inch, 11-5/16 ozs.)

Including Battery Magazine TP without batteries.

SENSOR UNIT G20, G100

Type: Directly coupled contact. Slides into accessory shoe and is secured by lock nut.

Function:

1. Sensor for automatic flash control.
2. Direct contact providing X-synchronization.
3. Automatically sets flash X-synchronization speed when using with New F-1 (Aperture-Priority or Manual), AL-1 or AV-1;
Automatically sets aperture and flash X-synchronization speed when using with New F-1 (Shutter-Priority), A-1, AE-1 PROGRAM, or AE-1.
4. Equipped with synchro socket for Synchro Cord A (optional accessory for use with camera having no direct contact).

Size and Weight:

Sensor Unit G20:

30 x 39 x 28mm, 35g

(1-3/16 x 1-3/8 x 1 inch, 1-1/4 ozs)

Sensor Unit G100:

30 x 39 x 28mm, 85g

(1-3/16 x 1-3/8 x 1 inch, 3 ozs)

Length of Cord:

Sensor Unit G20: 200mm (7-7/8 inch)

Sensor Unit G100: about 1000mm (39-3/8 inch)

Subject to change without notice.

CANON SPEEDLITE SYSTEM

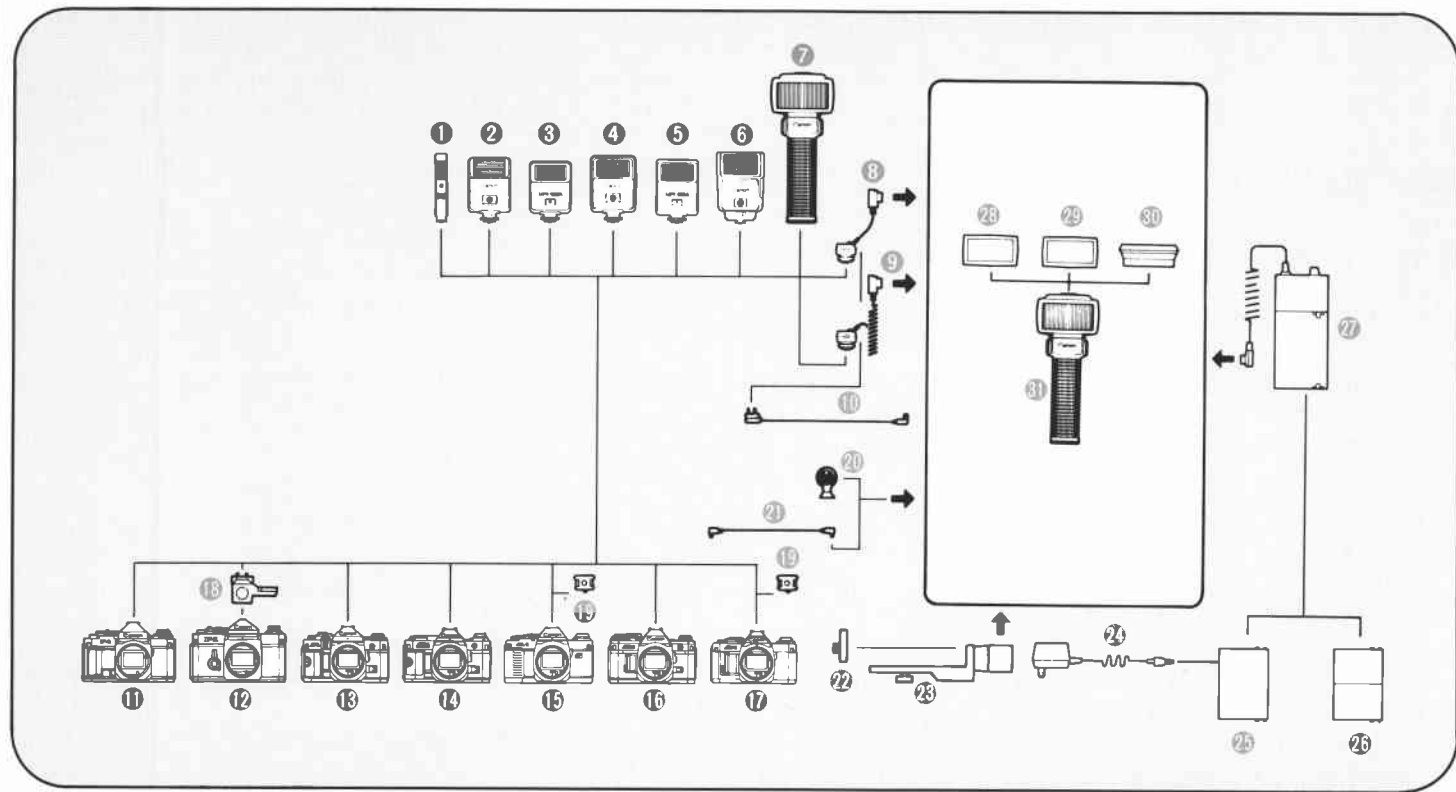

- ① Speedlite 011A
- ② Speedlite 155A
- ③ Speedlite 166A
- ④ Speedlite 177A
- ⑤ Speedlite 188A
- ⑥ Speedlite 199A
- ⑦ Speedlite 533G
- ⑧ Sensor Unit G20
- ⑨ Sensor Unit G100
- ⑩ Synchro Cord A
- ⑪ Canon New F-1
- ⑫ Canon F-1
- ⑬ Canon A-1
- ⑭ Canon AE-1 PROGRAM
- ⑮ Canon AL-1
- ⑯ Canon AE-1
- ⑰ Canon AV-1
- ⑱ Flash Coupler F
- ⑲ Hot-Shoe Adapter
- ⑳ Slave Unit*
- ㉑ Synchro Cord*
- ㉒ Adapter for Motor Drive MF
- ㉓ One-Touch Bracket G
- ㉔ Ni-Cd Charger TP
- ㉕ Ni-Cd Pack TP

- ㉖ Battery Magazine TP
- ㉗ Transistor Pack G
- ㉘ Wide Adapter 577G-20
- ㉙ Wide Adapter 577G-24
- ㉚ Tele Adapter 577G
- ㉛ Speedlite 577G

* Canon does not produce these items. Currently they are available on the market.

Canon

CANON INC. 7-1, Nishi-Shinjuku 2-Chome, Shinjuku-ku, Tokyo 160, Japan
Mailing address: P.O. Box 5050, Dai-ichi Seimei Building, Tokyo 160, Japan

U.S.A. _____ **CANON U.S.A., INC. HEADQUARTERS**
One Canon Plaza, Lake Success, N.Y. 11042, U.S.A.
CANON U.S.A., INC. MANHATTAN SERVICE CENTER
600 Third Avenue, New York, N.Y. 10016, U.S.A.
CANON U.S.A., INC. ATLANTA BRANCH
6380 Peachtree Industrial Blvd., Norcross, Georgia 30071, U.S.A.
CANON U.S.A., INC. CHICAGO BRANCH
140 Industrial Drive, Elmhurst, Illinois 60126, U.S.A.
CANON U.S.A., INC. LOS ANGELES BRANCH
123 Paularino Avenue East, Costa Mesa, California 92626, U.S.A.
CANON U.S.A., INC. LOS ANGELES SERVICE CENTER
3321 Wilshire Blvd., Los Angeles, California 90010, U.S.A.
CANON U.S.A., INC. SAN FRANCISCO OFFICE
775 Market Street, San Francisco, California 94102, U.S.A.
CANON U.S.A., INC. DALLAS OFFICE
2035, Royal Lane, Suite 290, Dallas, Texas 75229, U.S.A.
CANON U.S.A., INC. HONOLULU OFFICE
Bldg. B-2, 1050 Ala Moana Blvd., Honolulu, Hawaii 96814, U.S.A.

CANADA _____ **CANON CANADA INC. HEADQUARTERS**
3245 American Drive, Mississauga, Ontario L4V 1N4, Canada
CANON CANADA INC. MONTREAL SERVICE CENTRE
10652 Côte de Liesse, Lachine, Quebec H8T 1A5, Canada
CANON CANADA INC. CALGARY OFFICE
2828, 16th Street, N.E. Calgary, Alberta T2E 7K7, Canada

EUROPE, AFRICA
& MIDDLE EAST _____ **CANON EUROPA N.V.**
P.O. Box 7907, 1008 AC Amsterdam, The Netherlands
CANON FRANCE-PHOTO CINEMA S.A.
30, boulevard Vital-Bouhot, Ile de la Jatte, 92521 Neuilly-sur-Seine, France
CANON UK LTD.
Units 4 & 5, Brant Trading Centre, North Circular Road, London N10 0JF, United Kingdom

CENTRAL &
SOUTH AMERICA _____ **CANON LATIN AMERICA, INC. DEPTO. DE VENTAS**
Apartado 7022, Panamá 6, República de Panamá
CANON LATIN AMERICA, INC. CENTRO DE SERVICIO Y REPARACION
Apartado 2019, Zona Libre de Colón, República de Panamá

SOUTHEAST ASIA _____ **CANON HONGKONG TRADING CO., LTD.**
Golden Bear Industrial Centre, 7/F., 86-82 Chai Wan Kok Street,
Tsuen Wan, New Territories, Hong Kong
CANON SINGAPORE PTE. LTD.
60-B Martin Road, #10-01/0B, Singapore Warehouse, Block C, Singapore 0823

OCEANIA _____ **CANON AUSTRALIA PTY. LTD.**
Unit 1/37, Waterloo Road, North Ryde (Macquarie Park), N.S.W. 2113, Australia

JAPAN _____ **CANON SALES CO., INC.**
11-26, Mita, 3-Chome, Minato-ku, Tokyo 108, Japan

PUB. C-IE-083F © CANON INC. 1980 PRINTED IN JAPAN
0584N1.5

Free Manuals Download Website

<http://myh66.com>

<http://usermanuals.us>

<http://www.somanuals.com>

<http://www.4manuals.cc>

<http://www.manual-lib.com>

<http://www.404manual.com>

<http://www.luxmanual.com>

<http://aubethermostatmanual.com>

Golf course search by state

<http://golfingnear.com>

Email search by domain

<http://emailbydomain.com>

Auto manuals search

<http://auto.somanuals.com>

TV manuals search

<http://tv.somanuals.com>