

# Canon EF LENS

## EF24-70mm f/4L IS USM



IMAGE STABILIZER

 ULTRASONIC

ENG

Instructions

## Thank you for purchasing a Canon product.

Canon's EF24-70mm f/4L IS USM is a high-performance standard zoom lens, for use with EOS cameras. The lens is installed with an Image Stabilizer, and allows for close-up shooting up to a magnification of 0.7x when the zoom ring is set to macro.

- "IS" stands for Image Stabilizer.
- "USM" stands for Ultrasonic Motor.

### Features

---

1. The Image Stabilizer provides the effect of having a shutter speed about four stops faster during normal shooting.\*  
This function provides optimal image stabilization depending on shooting conditions (such as shooting still subjects, following shots, and close-up shooting).
2. And with the vibration gyro and acceleration sensor, the image stabilization is highly effective even for close-up shots. (Equipped with a Hybrid IS)
3. Use of UD lens elements and two types of aspherical lens elements giving superior definition.

4. Setting the zoom ring to macro allows for macro shooting up to a magnification of 0.7x.
5. Using a fluorine coating on the foremost and rearmost lens surfaces allows adhered dirt to be removed more easily than before.
6. Ultrasonic motor (USM) for fast, quiet autofocus.
7. Manual focusing is available after the subject comes into focus in autofocus mode (ONE SHOT AF).
8. Circular aperture for producing beautiful softfocus images.
9. Tight seal structure ensures excellent dustproof and drip-proof performance.

\* Based on [1/focal length] second.  
Generally, it requires a shutter speed [1/focal length] second or faster to prevent camera shake.

## Safety Precautions

### Handling Cautions

- **If the lens is taken from a cold environment into a warm one, condensation may develop on the lens surface and internal parts.** To prevent condensation in this case, first put the lens into an airtight plastic bag before taking it from a cold to warm environment. Then take out the lens after it has warmed gradually. Do the same when taking the lens from a warm environment into a cold one.
- Do not leave the lens in excessive heat such as in a car in direct sunlight. **High temperatures can cause the lens to malfunction.**

### Safety Precautions

- **Do not look at the sun or a bright light source through the lens or camera.** Doing so could result in loss of vision. Looking at the sun directly through the lens is especially hazardous.
- **Whether it is attached to the camera or not, do not leave the lens under the sun without the lens cap attached.** This is to prevent the lens from concentrating the sun's rays, which could cause a fire.

### Conventions used in this instruction



Warning to prevent lens or camera malfunction or damage.



Supplementary notes on using the lens and taking pictures.

## Safety Precautions

This device complies with Part 15 of the FCC Rules.

Operation is subject to the following two conditions: (1) This device may not cause harmful interference, and (2) this device must accept any interference received, including interference that may cause undesired operation.

Do not make any changes or modifications to the equipment unless otherwise specified in the instructions. If such changes or modifications should be made, you could be required to stop operation of the equipment.

This equipment has been tested and found to comply with the limits for a class B digital device, pursuant to part 15 of the FCC Rules. These limits are designed to provide reasonable protection against harmful interference in a residential installation. This equipment generates, uses and can radiate radio frequency energy and, if not installed and used in accordance with the instructions, may cause harmful interference to radio communications.

However, there is no guarantee that interference will not occur in a particular installation. If this equipment does cause harmful interference to radio or television reception, which can be determined by turning the equipment off and on, the user is encouraged to try to correct the interference by one or more of the following measures:

- Reorient or relocate the receiving antenna.
- Increase the separation between the equipment and receiver.
- Consult the dealer or an experienced radio/TV technician for help.

---

This Class B digital apparatus complies with Canadian ICES-003.

---

# Nomenclature

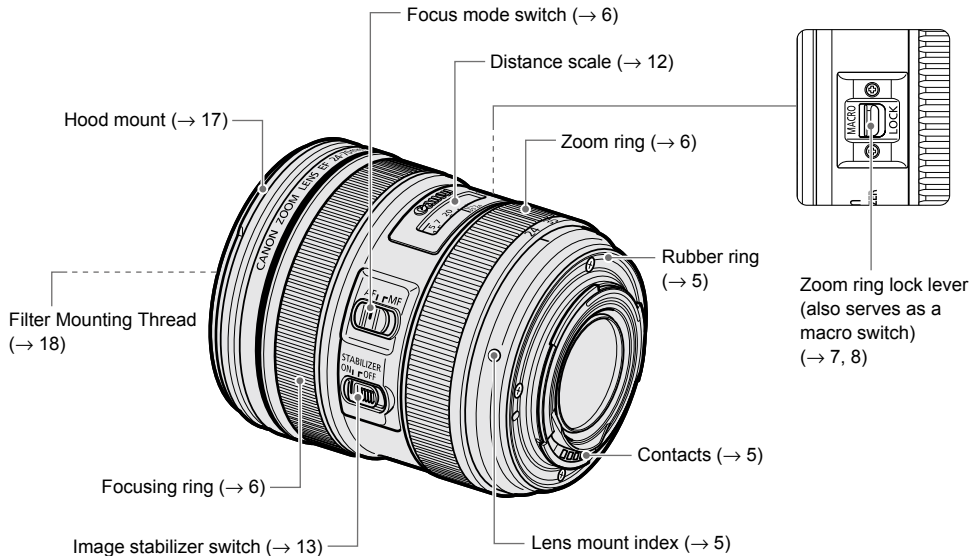

● For detailed information, reference page numbers are provided in parentheses (→ \*\*).

# 1. Mounting and Detaching the Lens

See your camera's instructions for details on mounting and detaching the lens.

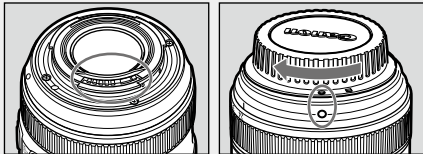

- After detaching the lens, place the lens with the rear end up to prevent the lens surface and contacts from getting scratched.
- If the contacts get soiled, scratched, or have fingerprints on them, corrosion or faulty connections can result. The camera and lens may not operate properly.
- If the contacts get soiled or have fingerprints on them, clean them with a soft cloth.
- If you remove the lens, cover it with the dust cap. To attach it properly, align the lens mount index and the  index of the dust cap as shown in the diagram, and turn clockwise. To remove it, reverse the order.



The lens mount has a rubber ring for enhanced dust- and water-resistance. The rubber ring may cause slight abrasions around the camera's lens mount, but this will not cause any problems. If the rubber ring becomes worn, it is replaceable by a Canon Service Center at cost.

## 2. Setting the Focus Mode

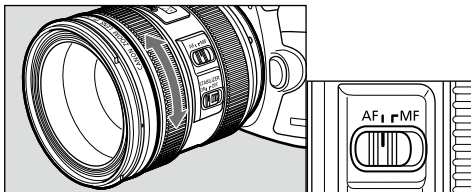

To shoot in autofocus (AF) mode, set the focus mode switch to AF.

To shoot in manual focus (MF) mode, set the focus mode switch to MF, and focus by turning the focusing ring.

The focusing ring always works, regardless of the focus mode.

 After autofocusing in ONE SHOT AF mode, focus manually by pressing the shutter button halfway and turning the focusing ring. (Full-time manual focus)

## 3. Zooming

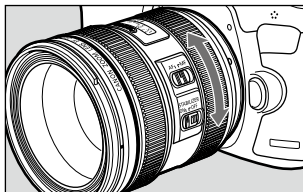

To zoom, rotate the zoom ring.

 Be sure to finish zooming before focusing. Zooming after focusing can affect the focus.

## 4. Fixing the Zoom Ring

The zoom ring can be fixed to keep the lens at the shortest point. This function is convenient for carrying a camera on a strap because it prevents the lens from extending.

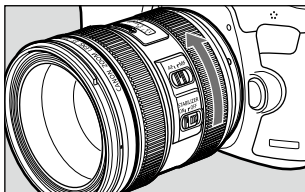
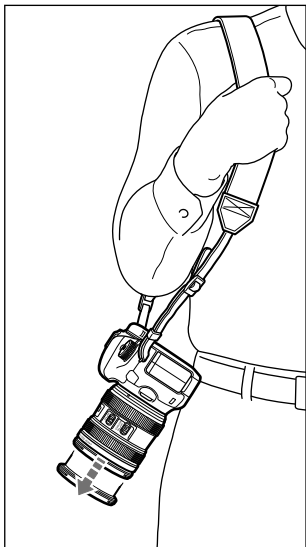

**1** Rotate the zoom ring to the widest position (24 mm).

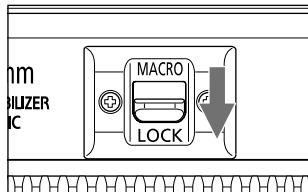

**2** Slide the zoom ring lock lever in the direction indicated by the arrow.

- To release the zoom ring, slide the zoom ring lock lever in the direction opposite to the arrow.

**!** The zoom ring can only be locked at maximum wide angle.



## 5. Setting for Close-up Shooting

Setting the zoom ring to macro allows for close-up shooting.

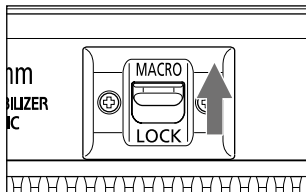

**1** Slide the macro switch (zoom ring lock lever) to MACRO. Keep your finger on the lever so that it does not slide back to its normal position.

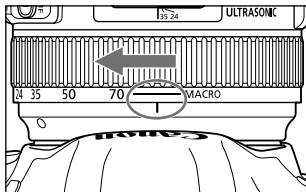

**2** Rotate the zoom ring past the telephoto end (70 mm) into the macro range indicated by the yellow line.

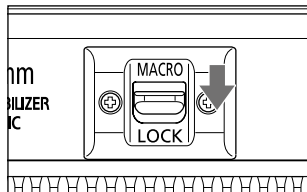

**3** Release the macro switch.

- After the zoom ring has been set to macro, the zoom ring can only be operated within the macro range (indicated by the yellow line).
- To set the zoom ring back to the normal zoom range, slide the macro switch (zoom ring lock lever) to MACRO (just as in step 1). While keeping your finger on the lever, rotate the zoom ring toward the wide end. Release the lever once the zoom ring is set to the normal zoom range.



- Magnification refers to the comparison of the size of a subject to the size of its image in the imaging area.
- Setting the zoom ring to the macro range allows for close-up shooting (minimum focusing distance of 20 cm) up to a maximum magnification of 0.7x. The focusing distance refers to the distance between the subject and imaging area. In addition, the distance between the end of the lens and the subject (working distance) is approximately 3 cm.

## 6. Close-up Shooting

The yellow line on the distance scale indicates the range in which image degradation is minimal during close-up shooting.\* The following procedure shows how to focus within the range indicated by the yellow line in order to capture photos with high definition.

\* However, maximum magnification is 0.5x when shooting within the range indicated by the yellow line on the distance scale.

We recommend using a tripod for close-up (macro) shooting.

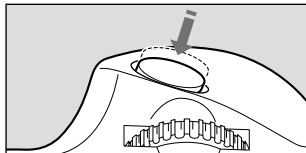
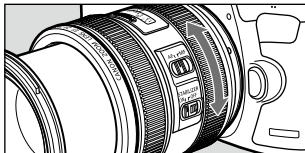
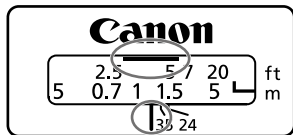

**1** After setting the zoom ring to macro, position the focusing ring so that the indicator appears in the center of the yellow line on the distance scale.

- Maximum magnification is 0.5x when shooting within the range indicated by the yellow line on the distance scale. When shooting at a higher magnification, please move out of the range indicated by the yellow line to focus.

**2** Adjust the zoom ring and position the camera by moving it forward or back. Set the magnification and obtain a rough focus by using the zoom ring to adjust the focusing distance.

- A rough focus is obtained so that the user can focus when shooting within the range indicated by the yellow line on the distance scale.

**3** Press the shutter button halfway and focus using AF or MF before shooting.

- In order to achieve a sharp focus in manual focus (MF) mode, please use the magnified view feature\* which is found in cameras that offer Live View shooting.
- \* For information about this feature, see the camera's instruction manual. In addition, please also read the Live View shooting cautions section found in the camera's instruction manual.

## Close-up Shooting

- Please focus carefully since the depth of field with close-ups is shallow.
- The focusing ring distance scale is designed to display distances during normal shooting. As a result, it does not display distances during close-up shooting.
- When the zoom ring is set to the macro range, there are cameras that will record the focal length information into the image at a value between the range from above 70 mm to 80 mm due to system issues.\* However, the actually focal length will never exceed 70 mm.

\* Depending on cameras.



- The magnification of this lens is determined by the combination of the following three factors: the focusing ring position, zoom ring position, and focusing distance. Therefore, the number of combinations for achieving a certain level of magnification is countless. The method for close-up shooting described here involves trying as much as possible to keep the focus position within the range indicated by the yellow line on the distance scale. However, please keep in mind that this is just one method of many.
- To check depth of field, please use the camera's depth of field function.
- For information on taking hand-held close-ups, please refer to page 15.

## 7. Exposure during Close-up Shooting

### Setting the Exposure

When taking photographs using TTL metering, no exposure compensation is necessary to meter the light coming through the lens. With TTL metering, AE (autoexposure) is possible at all focusing distances. Just set the desired picture-taking mode, then check the shutter speed and aperture before taking the picture.

### Magnification and Effective f-number

The aperture displayed by the camera assumes that the focus is set to infinity. The actual aperture (effective f-number) becomes darker (effective f-number increases) at closer focusing distances (magnification increases). This does not cause exposure problems for normal picture-taking. However, for closeup photography, you cannot ignore the change in the effective f-number.

When you use a handheld exposure meter to set the exposure, you must take into account the exposure factor shown in the following table.

Magnification	1 : 5	1 : 3	1 : 2	1 : 1.5
Effective f/No.	4.71	5.06	5.66	5.66
Exposure Factor (stops)*	+1/3	+2/3	+1	+1
	+1/2	+1/2	+1	+1

\* Upper values: 1/3 stops. Lower values: 1/2 stops.



- The correct exposure for a close-up shot largely depends on the subject. Therefore, try to bracket the exposure for the same subject.
- Using aperture-priority AE (**Av**) or Manual (**M**) picture-taking modes are recommended for macro photography as it is easy to adjust depth of field and exposure in these modes.

## 8. Infinity Compensation Mark

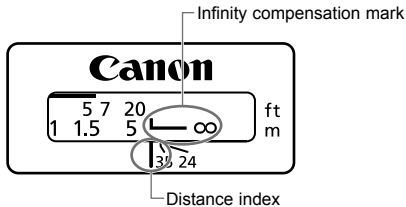

To compensate for shifting of the infinity focus point that results from changes in temperature. The infinity position at normal temperature is the point at which the vertical line of the distance scale L mark is aligned with the distance index.

 For accurate manual focusing of subjects at infinity, look through the viewfinder or look at the magnified image\* on the LCD screen while rotating the focusing ring.

\* For cameras with Live View shooting capability.

## 9. Infrared Index

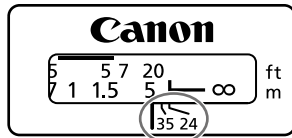

The infrared index corrects the focus setting when using monochrome infrared film. Focus on the subject manually, then adjust the distance setting by moving the focusing ring to the corresponding infrared index mark.

 Some EOS cameras cannot use infrared film. See the instructions for your EOS camera.

-  ● The infrared index position is based on a wavelength of 800 nm.
- The compensation amount differs depending on the focal length. Use the indicated focal length as a guide when setting the compensation amount.
- Be sure to observe the manufacturer's instructions when using infrared film.
- Use a red filter when you take the picture.

## 10. Image Stabilizer

You can use the image stabilizer in AF or MF mode. This function provides optimal image stabilization depending on shooting conditions (such as shooting still subjects, following shots, and close-up shooting).

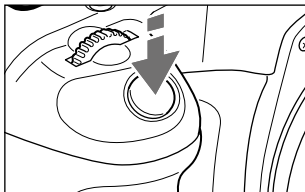
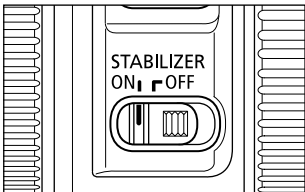

### 1 Set the STABILIZER switch to ON.

- The Hybrid IS is activated during close-up shooting (see page 8) which provides highly effective image stabilization.
- If you are not going to use the image stabilizer function, set the switch to OFF.

### 2 When you press the shutter button halfway, the Image Stabilizer will start operating.

- Make sure the image in the viewfinder is stable, then press the shutter button the rest of the way down to take the picture.



ON



OFF

The image stabilizer in this lens is effective for hand-held shots under the following conditions.

- Close-up shooting.
- In semi-darkened areas such as indoors or outdoors at night.
- In locations where flash photography is prohibited, such as art museums and theater stages.
- In situations where your footing is uncertain.
- When panning subjects in motion.
- In situations where fast shutter settings cannot be used.

## Image Stabilizer

- The shorter the subject distance from the camera, the lesser the Image Stabilizer effect will be.
- The Image Stabilizer cannot compensate for a blurred shot caused by a subject that moved.
- Set the STABILIZER switch to OFF when you are taking pictures using the Bulb setting (long exposures). If the STABILIZER switch is set to ON, the image stabilizer function may introduce errors.
- The Image Stabilizer may not be fully effective if you shoot from a violently shaking vehicle or other transportation.
- The Image Stabilizer consumes more power than normal shooting, so fewer shots can be taken if you use the function.
- The image stabilizer operates for about two seconds even when your finger is off the shutter button. Do not remove the lens while the stabilizer is in operation. This will cause a malfunction.
- With the EOS-1V/HS, 3, ELAN 7E/ELAN 7/30/33, ELAN 7NE/ELAN 7N/30V/33V, ELAN II/ELAN IIE/50/50E, REBEL 2000/300, IX, and D30, the Image Stabilizer will not work during self-timer operation.



- When shooting a still subject, it compensates for camera shake in all directions.
- It compensates for vertical camera shake during following shots in a horizontal direction, and compensates for horizontal camera shake during following shots in a vertical direction.
- When you use a tripod, the Image Stabilizer should be turned off to save battery power.
- The stabilizer is equally effective for hand-held photography and photography with a monopod. The Image Stabilizer effect may be reduced, however, depending on the shooting environment.
- The image stabilizer function also operates when the lens is used with an Extension Tube EF12 II or EF25 II.
- Pictures may look distorted after being taken depending on the camera, but this doesn't affect shooting.
- If you set the camera's Custom Function to change the assigned button to operate the AF, the Image Stabilizer will operate when you press the newly assigned AF button.

## 11. Image Stabilization during Close-up Shooting

For normal close-up shooting, the higher the magnification, the faster the shutter speed must be to prevent blur caused by camera shake. Although it depends on the shooting conditions, usually the shutter speed must be at least one or two stops faster than normal.

The EF24-70mm f/4L IS USM is installed with an Image Stabilizer that gives the equivalent effect of a shutter speed approximately 3 steps faster when shooting at a magnification of 0.5x, and approximately 2.5 steps faster when shooting at 0.7x.\*

\* Depending on shooting conditions.



The magnification refers to the ratio between the subject's size and the corresponding image size on the focal plane.



## 12. Taking Hand-held Close-ups

Close-up shots are more prone to be affected by camera shake than with normal shooting. The Image Stabilizer's corrective effect is therefore less during close-ups than during normal shooting even with the same degree of camera shake.

The depth of field also becomes very shallow with close-ups, and moving forward or back even slightly will throw off the focus.

When hand-holding the camera for close-up shooting, minimize camera shake and blurred focus with the following techniques:

### Hold the camera firmly

As shown on the right, hold the camera firmly so it does not move while shooting.

### Use AI Servo AF

For close-up shots, set the camera's AF mode to AI Servo AF. Using autofocus is recommended. The AI Servo AF mode can minimize blurred focus during close-up shooting. For details, see the camera's instruction manual.



Place both elbows on a steady surface such as a table.



Use your knee to support an arm holding the camera.



Lean against a steady object like a wall.

## 13. Hood

The EW-83L hood cuts out unwanted light and protects the front of the lens from rain, snow, and dust.

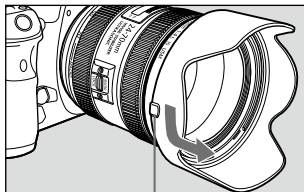
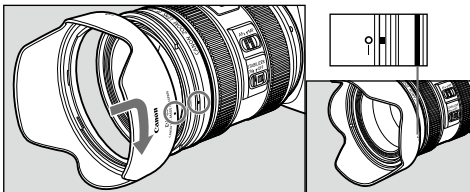

Button

### ●Attaching

To attach the hood, align the hood's attachment position mark with the red dot on the front of the lens, then turn the hood as shown by the arrow until the lens' red dot is aligned with the hood's stop position mark.

### ●Removing

To remove the hood, hold down the button on the side and turn the hood in the direction of the arrow until the position mark on the hood aligns with the red dot. The hood can be reverse-mounted on the lens for storage.



- If the hood is not attached properly, vignetting (darkening of the perimeter of the picture) may occur.
- When attaching or detaching the hood, grasp the base of the hood to turn it. To prevent deformation, do not grasp the rim of the hood to turn it.

## 14. Filters (Sold separately)

You can attach filters to the filter mounting thread on the front of the lens.

- If you need a polarizing filter, use the Canon Circular Polarizing Filter PL-C B (77 mm).
- To adjust the polarizing filter, first remove the lens hood.

## 15. Close-up Lenses (Sold separately)

Attaching a 500D (77mm) Close-up Lens enables close-up photography. Magnification will be 0.05x – 0.29x. Magnification will be 0.16x – 0.74x within the macro range.

- Close-up Lens 250D cannot be attached because there is no size that fits the lens.
- MF mode is recommended for accurate focusing.

## 16. Extension Tubes (Sold separately)

You can attach extension tube EF12 II or EF25 II for magnified shots. The shooting distance and magnification are shown below.

		Focusing Distance Range (mm)		Magnification (×)	
		Close distance	Long distance	Close distance	Long distance
EF12 II	24mm	163	174	0.63	0.50
	70mm	258	523	0.44	0.18
EF25 II	24mm	Incompatible			
	70mm	226	332	0.72	0.4

- An extension tube cannot be used when the zoom ring is set to macro.

- MF mode is recommended for accurate focusing.

# Specifications

<b>Focal Length/Aperture</b>	24-70mm f/4
<b>Lens Construction</b>	12 groups, 15 elements
<b>Minimum Aperture</b>	f/22
<b>Angle of View</b>	Diagonal: 84° – 34°, Vertical: 53° – 19° 30', Horizontal: 74° – 29°
<b>Min. Focusing Distance</b>	0.38 m/1.25 ft. (0.2 m/0.66 ft. in the macro range; working distance of approx. 3 cm/1.18 in.)
<b>Max. Magnification</b>	0.21x (at 70mm); 0.7x in the macro range
<b>Field of View</b>	Approx. 287 x 439 – 115 x 172.5 mm/ 11.30 x 17.28 – 4.53 x 6.79 inch (at 0.38 m/1.25 ft.)
<b>Filter Diameter</b>	77 mm/3.03 inch
<b>Max. Diameter and Length</b>	83.4 x 93 mm/3.28 x 3.66 inch
<b>Weight</b>	Approx. 600 g/21.2 oz
<b>Hood</b>	EW-83L
<b>Lens Cap</b>	E-77 II
<b>Case</b>	LP1219

- The lens length is measured from the mount surface to the front end of the lens. Add 24.2 mm when including the lens cap and dust cap.
- The size and weight listed are for the lens only, except as indicated.
- Extenders cannot be used with this lens.
- Aperture settings are specified on the camera.
- All data listed is measured according to Canon standards.
- Product specifications and appearance are subject to change without notice.

# Canon

## Free Manuals Download Website

<http://myh66.com>

<http://usermanuals.us>

<http://www.somanuals.com>

<http://www.4manuals.cc>

<http://www.manual-lib.com>

<http://www.404manual.com>

<http://www.luxmanual.com>

<http://aubethermostatmanual.com>

Golf course search by state

<http://golfingnear.com>

Email search by domain

<http://emailbydomain.com>

Auto manuals search

<http://auto.somanuals.com>

TV manuals search

<http://tv.somanuals.com>