

Canon

EF Lens

EF50mm f/1.8 II

Instruction

Nomenclature

- ① Focus mode switch
- ② Lens mount index
- ③ Contacts
- ④ Focusing ring

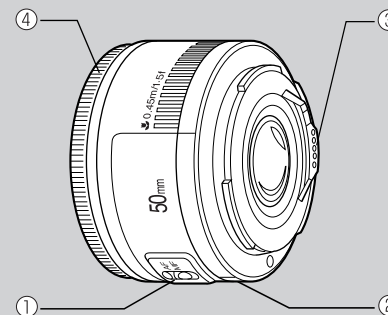

Thank you for purchasing a Canon product.

⚠ Safety Precautions

1. Do not look at the sun or a bright light source through the lens or camera. Doing so could result in loss of vision. Looking at the sun directly through the lens is especially hazardous.
2. Whether it is attached to the camera or not, do not leave the lens under the sun without the lens cap attached. This is to prevent the lens from concentrating the sun's rays, which could cause a fire.

⚠ Handling Cautions

If the lens is taken from a cold environment into a warm one, condensation may develop on the lens surface and internal parts. To prevent condensation in this case, first put the lens into an airtight plastic bag before taking it from a cold to warm environment. Then take out the lens after it has warmed gradually. Do the same when taking the lens from a warm environment into a cold one.

1. Mounting and Detaching the Lens

See your camera's instructions for details on mounting and detaching the lens.

- After detaching the lens, place the lens with the rear end up to prevent the lens surface and contacts from getting scratched.
- If the contacts get soiled, scratched, or have fingerprints on them, corrosion or faulty connections can result. The camera and lens may not operate properly.
- If the contacts get soiled or have fingerprints on them, clean them with a soft cloth.
- If you remove the lens, cover it with the dust cap. To attach it properly, align the lens mount index and the O index of the dust cap as shown in diagram ①, and turn clockwise. To remove it, reverse the order.

2. Setting the Focus Mode

To shoot in autofocus (AF) mode, set the focus mode switch to AF ④.

To shoot in manual focus (MF) mode, set the focus mode switch to MF, and focus by turning the focusing ring.

- Do not touch the rotating parts of the lens while AF is active.
- Do not focus in MF when the focus mode switch is set to AF.

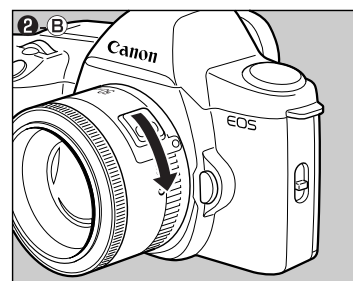
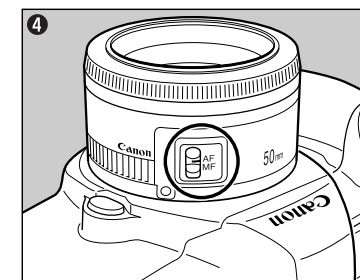
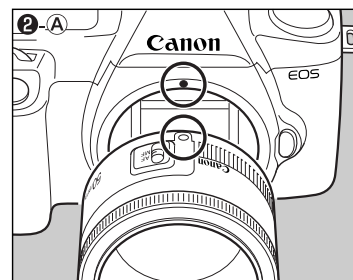
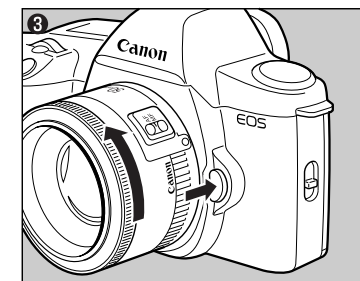
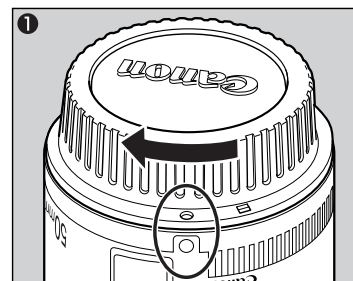

3. Hood (Sold Separately)

The ES-62 lens hood can keep unwanted light out of the lens, and also protects the lens from rain, snow, and dust. The supplied hood adapter is required when mounting the ES-62 lens hood.

- 1) Screw the hood adapter onto the filter mounting thread of the lens.
 - 2) Attach the hood to the hood adapter ⑤.
- The hood can be reverse-mounted on the lens for storage.

4. Filters (Sold Separately)

You can attach filters to the filter mounting thread on the front of the lens.

- Only one filter may be attached.
- When using the hood, screw the filter onto the hood adapter.
- Use a polarizing Canon filter (52mm).

Specifications

Angle of View	Diagonal	46°
	Vertical	27°
	Horizontal	40°
Lens Construction	5 groups, 6 elements	
Minimum Aperture	f/22	
Min. Focusing Distance	0.45 m/1.5 ft.	
Max. Magnification and Field of View	0.15×/160 × 240 mm/6.3 × 9.4 inch (at 0.45 m/1.5 ft.)	
Filter Diameter/Usable Number	52 mm/1	
Max. Diameter and Length	68.2 × 41 mm 2.7 × 1.6 inch	
Weight	130 g/4.6 oz	
Hood	ES-62 (with hood adapter: sold separately)	
Case	LP1014 (sold separately)	

- The lens length is measured from the mount surface to the front end of the lens. Add 21.5 mm when including the lens cap and dust cap.
- The size and weight listed are for the lens only, except as indicated.
- Aperture settings are specified on the camera.
- All data listed is measured according to Canon standards.
- Product specifications and appearance are subject to change without notice.

This device complies with Part 15 of the FCC Rules. Operation is subject to the following two conditions: (1) This device may not cause harmful interference, and (2) this device must accept any interference received, including interference that may cause undesired operation.

Do not make any changes or modifications to the equipment unless otherwise specified in the instructions. If such changes or modifications should be made, you could be required to stop operation of the equipment.

This equipment has been tested and found to comply with the limits for a class B digital device, pursuant to part 15 of the FCC Rules.

These limits are designed to provide reasonable protection against harmful interference in a residential installation. This equipment generates, uses and can radiate radio frequency energy and, if not installed and used in accordance with the instructions, may cause harmful interference to radio communications. However, there is no guarantee that interference will not occur in a particular installation. If this equipment does cause harmful interference to radio or television reception, which can be determined by turning the equipment off and on, the user is encouraged to try to correct the interference by one or more of the following measures:

- Reorient or relocate the receiving antenna.
- Increase the separation between the equipment and receiver.
- Consult the dealer or an experienced radio/TV technician for help.

This Class B digital apparatus complies with Canadian ICES-003.

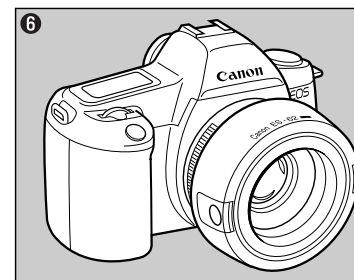
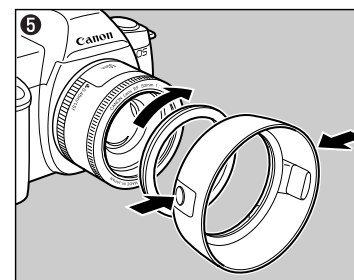

Free Manuals Download Website

<http://myh66.com>

<http://usermanuals.us>

<http://www.somanuals.com>

<http://www.4manuals.cc>

<http://www.manual-lib.com>

<http://www.404manual.com>

<http://www.luxmanual.com>

<http://aubethermostatmanual.com>

Golf course search by state

<http://golfingnear.com>

Email search by domain

<http://emailbydomain.com>

Auto manuals search

<http://auto.somanuals.com>

TV manuals search

<http://tv.somanuals.com>