

# Canon EF LENS

EF135mm f/2L USM

EF200mm f/2.8L II USM

EF300mm f/4L USM

EF400mm f/5.6L USM



**ULTRASONIC**

**ENG**  
Instructions

# Thank you for purchasing a Canon product.

The Canon EF135mm f/2L USM, the EF200mm f/2.8L II USM, the EF300mm f/4L USM, and the EF400mm f/5.6L USM are high-performance telephoto lenses designed for EOS cameras.

- “USM” stands for Ultrasonic Motor.

## Features

---

1. UD lens elements (in the EF135mm f/2L USM, the EF200mm f/2.8L II USM, the EF300mm f/4L USM, and the EF400mm f/5.6L USM) and super UD lens elements (in the EF400mm f/5.6L USM) for excellent imaging performance.
2. Ultrasonic motor (USM) for quick and quiet autofocusing.
3. Manual focusing is available after the subject comes into focus in autofocus mode (ONE SHOT AF).
4. The lens is compatible with Extender EF1.4X II and EF2X II.

## Conventions used in this instruction



Warning to prevent lens or camera malfunction or damage.



Supplementary notes on using the lens and taking pictures.



## Safety Precautions



### Safety Precautions

- **Do not look at the sun or a bright light source through the lens or camera.** Doing so could result in loss of vision. Looking at the sun directly through the lens is especially hazardous.
- **Whether it is attached to the camera or not, do not leave the lens under the sun without the lens cap attached.** This is to prevent the lens from concentrating the sun's rays, which could cause a fire.

### Handling Cautions

- **If the lens is taken from a cold environment into a warm one, condensation may develop on the lens surface and internal parts.** To prevent condensation in this case, first put the lens into an airtight plastic bag before taking it from a cold to warm environment. Then take out the lens after it has warmed gradually. Do the same when taking the lens from a warm environment into a cold one.
- Do not leave the lens in excessive heat such as in a car in direct sunlight. **High temperatures can cause the lens to malfunction.**

This device complies with Part 15 of the FCC Rules. Operation is subject to the following two conditions: (1) This device may not cause harmful interference, and (2) this device must accept any interference received, including interference that may cause undesired operation.

Do not make any changes or modifications to the equipment unless otherwise specified in the instructions. If such changes or modifications should be made, you could be required to stop operation of the equipment.

This equipment has been tested and found to comply with the limits for a class B digital device, pursuant to part 15 of the FCC Rules. These limits are designed to provide reasonable protection against harmful interference in a residential installation. This equipment generates, uses and can radiate radio frequency energy and, if not installed and used in accordance with the instructions, may cause harmful interference to radio communications.

However, there is no guarantee that interference will not occur in a particular installation. If this equipment does cause harmful interference to radio or television reception, which can be determined by turning the equipment off and on, the user is encouraged to try to correct the interference by one or more of the following measures:

- Reorient or relocate the receiving antenna.
- Increase the separation between the equipment and receiver.
- Consult the dealer or an experienced radio/TV technician for help.

---

This Class B digital apparatus complies with Canadian ICES-003.

# Nomenclature

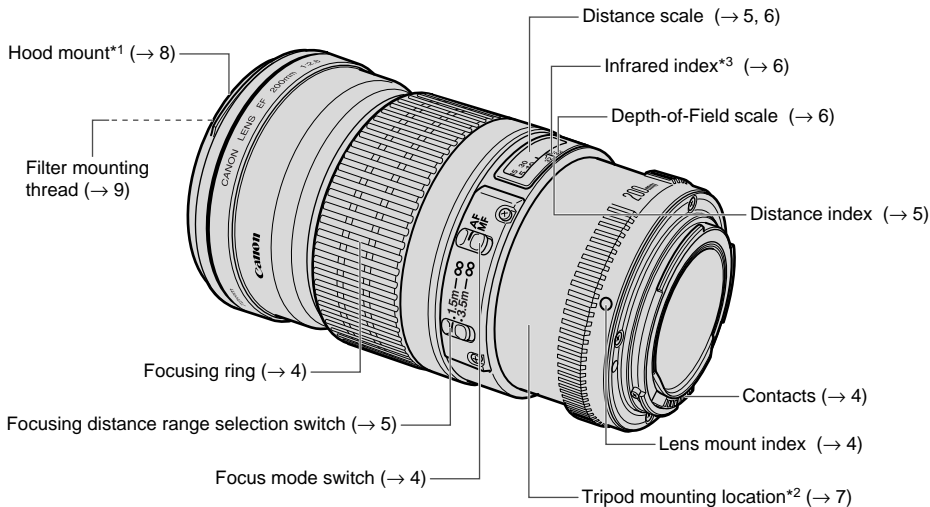

\*1) EF135mm f/2L USM • EF200mm f/2.8L II USM

\*2,3) EF200mm f/2.8L II USM • EF300mm f/4L USM • EF400mm f/5.6L USM

For detailed information, reference page numbers are provided in parentheses (→ \*\*).

## 1. Mounting and Detaching the Lens

See your camera's instructions for details on mounting and detaching the lens.

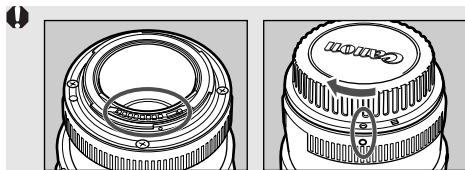

- After detaching the lens, place the lens with the rear end up to prevent the lens surface and electrical contacts from getting scratched.
- If the contacts get soiled, scratched, or have fingerprints on them, corrosion or faulty connections can result. The camera and lens may not operate properly.
- If the contacts get soiled or have fingerprints on them, clean them with a soft cloth.
- If you remove the lens, cover it with the dust cap. To attach it properly, align the lens mount index and the  index of the dust cap as shown in the diagram, and turn clockwise. To remove it, reverse the order.

## 2. Setting the Focus Mode

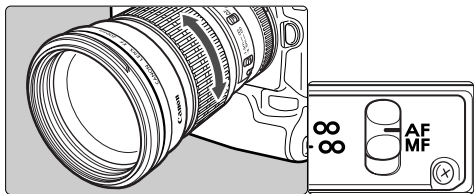

To shoot in autofocus (AF) mode, set the focus mode switch to AF.

To use only manual focusing (MF), set the focus mode switch to MF, and focus by turning the focusing ring. The focusing ring always works, regardless of the focus mode.

-  After autofocusing in ONE SHOT AF mode, focus manually by pressing the shutter halfway and turning the focusing ring. (Full-time manual focus)

### 3. Switching the Focusing Distance Range

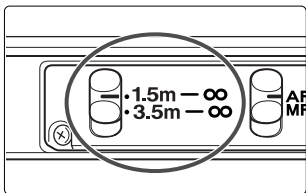

You can choose the focusing distance range with a switch. By setting a suitable focusing distance range, actual autofocus time can be shorter.

● EF135mm f/2L USM :

① 0.9 m / 3.0 ft. - ∞    ② 1.6 m / 5.2 ft. - ∞

● EF200mm f/2.8L II USM :

① 1.5 m / 4.9 ft. - ∞    ② 3.5 m / 11.5 ft. - ∞

● EF300mm f/4L USM :

① 2.5 m / 8.2 ft. - ∞    ② 6 m / 19.7 ft. - ∞

● EF400mm f/5.6L USM :

① 3.5 m / 11.5 ft. - ∞    ② 8.5 m / 27.9 ft. - ∞

⚠ If you autofocus outside the set focusing distance range, the lens may stop focusing at the start of the focusing range; however, this is not a malfunction. Press the shutter release button halfway again.

### 4. Infinity Compensation Mark

Infinity compensation mark

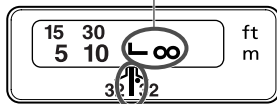

Distance index

To compensate for shifting of the infinity focus point that results from changes in temperature. The infinity position at normal temperature is the point at which the vertical line of the L mark is aligned with the distance indicator on the distance scale.

⚠ For accurate manual focusing on subjects at infinity distance, look through the viewfinder while rotating the focusing ring.

## 5. Infrared Index

(EF200mm f/2.8L II USM • EF300mm f/4L USM • EF400mm f/5.6L USM)

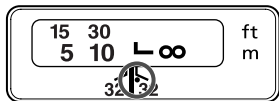

The infrared index corrects the focus setting when using monochrome infrared film. Focus on the subject manually, then adjust the distance setting by moving the focusing ring to the corresponding infrared index mark.

 Some EOS cameras cannot use infrared film. See the instructions for your EOS camera.

- 
- The infrared index position is based on a wavelength of 800 nm.
  - Be sure to observe the manufacturer's instructions when using infrared film.
  - Use a red filter also when you take the picture.

## 6. Depth-of-Field Scale

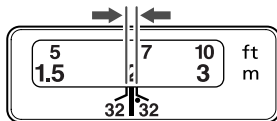

The depth of field is the distance in front of and behind the plane of focus on the subject that appears sharp. The depth of field is indicated by the area between the depth-of-field scale lines below the distance scale.

The number on the scale is the F value.

 The depth-of-field scale is an approximate indicator.

## 7. Using the Tripod Mount (EF200mm f/2.8L II USM • EF300mm f/4L USM • EF400mm f/5.6L USM)

### Adjusting the Revolving Mount

You can loosen the orientation lock-knob on the tripod mount to allow it to rotate as needed to fit a particular camera model for switching between vertical and horizontal positions.

The EF200mm f/2.8L II USM lens can be used with the A II (B) tripod mount ring, sold separately.

### Detaching

Use the following procedures to remove and attach the tripod mount.

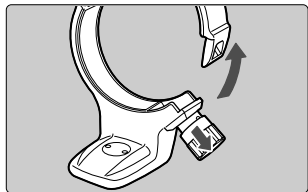

- 1 Turn the locking knob counterclockwise until it becomes loose (about 3 turns), and pull the knob in the direction of the arrow to release the collar.

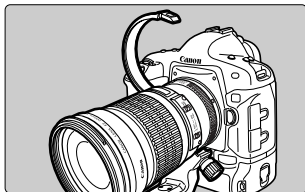

- 2 With the collar open, remove the tripod mount.

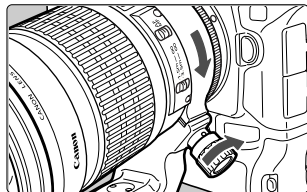

- 3 To install, while pulling the locking knob, bring the collar to the original position, and tighten the locking knob securely.

 If the foot of the tripod mount overlaps the switch, loosen the orientation locking knob on the tripod mount to move the foot.

 The tripod mount can be attached to or detached from the lens while the lens is attached to the camera.



## 8. Hood

The lens hood can reduce unwanted reflections and also protects the front of the lens from rain, snow, dust, and other substances.

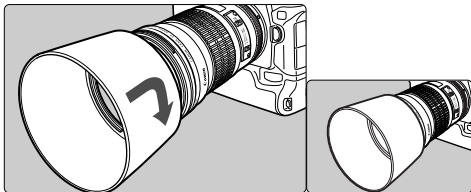

### **EF135mm f/2L USM • EF200mm f/2.8L II USM**

Attach and align the hood to the hood mount on the front of the lens, and turn the hood as shown by the arrow to secure it.

The hood can be reverse-mounted on the lens for storage.

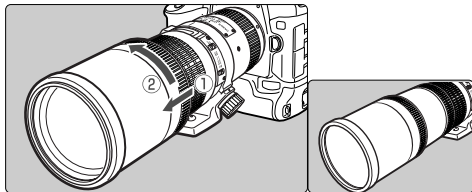

### **EF300mm f/4L USM**

Bring the hood out from the end of the lens until it stops. For storage, reverse the procedure.

### **EF400mm f/5.6L USM**

Bring the hood out from the end of the lens until it stops and turn in the direction of the arrow. For storage, reverse the procedure.

### **ⓘ EF135mm f/2L USM • EF200mm f/2.8L II USM**

- Part of the picture may be blocked if the hood is not attached properly.
- When attaching or detaching the hood, grasp the base of the hood to turn it. To prevent deformation, do not grasp the rim of the hood to turn it.

## 9. Filters (Sold separately)

You can attach filters to the filter mounting thread on the front of the lens.



- If you need a polarizing filter, use the Canon Circular Polarizing Filter.
- To adjust the polarizing filter, first remove or store the lens hood.

## 10. Close-up Lenses (Sold separately)

Attaching a 500D Close-up Lens enables close-up photography.

The magnification will be as follows:

- EF135mm f/2L USM (72mm)  
0.48× – 0.27×
- EF200mm f/2.8L II USM (72mm)  
0.57× – 0.39×
- EF300mm f/4L USM (77mm)  
0.82× – 0.59×
- EF400mm f/5.6L USM (77mm)  
0.91× – 0.78×



- Close-up Lens 250D cannot be attached because there is no size that fits the lens.
- Manual focusing is recommended for accurate focusing.

## 11. Extension Tubes (Sold separately)

You can attach Extension Tube EF12 II or EF25 II for magnified shots. The shooting distance and magnification are shown below.

### EF135mm f/2L USM

	Camera-to-Subject Distance (mm)		Magnification	
	Near	Far	Near	Far
EF12 II	691	1661	0.29×	0.09×
EF25 II	579	883	0.41×	0.20×

### EF300mm f/4L USM

	Camera-to-Subject Distance (mm)		Magnification	
	Near	Far	Near	Far
EF12 II	1986	7786	0.18×	0.04×
EF25 II	1661	3925	0.24×	0.09×

### EF200mm f/2.8L II USM

	Camera-to-Subject Distance (mm)		Magnification	
	Near	Far	Near	Far
EF12 II	1169	3284	0.23×	0.06×
EF25 II	977	1801	0.32×	0.14×

### EF400mm f/5.6L USM

	Camera-to-Subject Distance (mm)		Magnification	
	Near	Far	Near	Far
EF12 II	2893	13449	0.16×	0.03×
EF25 II	2460	6610	0.21×	0.07×



Manual focusing is recommended for accurate focusing.

## 12. Extenders (Sold separately)

With Extender EF1.4X II or EF2X II attached, the lens specifications will change as follows:

### EF135mm f/2L USM

	Focal length (mm)	Aperture	Angle of view			Maximum magnification (x)
			Diagonal	Vertical	Horizontal	
EF1.4X II	189	f/2.8-45	13° 35'	7° 25'	11° 5'	0.27
EF2X II	270	f/4-64	9° 15'	5° 10'	7° 40'	0.38

### EF200mm f/2.8L II USM

	Focal length (mm)	Aperture	Angle of view			Maximum magnification (x)
			Diagonal	Vertical	Horizontal	
EF1.4X II	280	f/4-45	9° 20'	5° 10'	7° 40'	0.22
EF2X II	400	f/5.6-64	8° 50'	4° 55'	7° 20'	0.32

### EF300mm f/4L USM

	Focal length (mm)	Aperture	Angle of view			Maximum magnification (x)
			Diagonal	Vertical	Horizontal	
EF1.4X II	420	f/5.6-45	6° 10'	3° 20'	5°	0.18
EF2X II	600	f/8-64	4° 10'	2° 20'	3° 30'	0.26

### EF400mm f/5.6L USM

	Focal length (mm)	Aperture	Angle of view			Maximum magnification (x)
			Diagonal	Vertical	Horizontal	
EF1.4X II	560	f/8-45	4° 25'	2° 25'	3° 40'	0.18
EF2X II	800	f/11-64	3° 5'	1° 40'	2° 35'	0.25

## Extenders (Sold separately)



### **EF300mm f/4L USM**

- With Extender EF2X II attached to the lens, only manual focus is possible. However, with the EOS-1Ds Mark III, EOS-1Ds Mark II, EOS-1Ds, EOS-1D Mark III, EOS-1D Mark II N, EOS-1D Mark II, EOS-1D, EOS-1V/HS, EOS-3 camera, autofocusing with the center focusing point is possible.

### **EF400mm f/5.6L USM**

- With Extender EF1.4X II attached to the lens, only manual focus is possible. However, with the EOS-1Ds Mark III, EOS-1Ds Mark II, EOS-1Ds, EOS-1D Mark III, EOS-1D Mark II N, EOS-1D Mark II, EOS-1D, EOS-1V/HS, EOS-3 camera, autofocusing with the center focusing point is possible.
- With Extender EF2X II attached to the lens, only manual focus is possible.

### **For all lenses**

- First attach the Extender to the lens, then attach the lens to the camera. Detach it from the camera in the reverse order. If you attach the lens to the camera first, misoperation may occur.
- Only one Extender can be attached to the lens and camera.
- If you use an Extender on the lens mounted on a EOS A2/A2E/5, set the exposure compensation to -1/2 stop for the EF1.4X II or -1 stop for the EF2X II.



When an Extender is attached, the AF speed will become slower by design to retain proper AF control.

# Specifications

	EF135mm f/2L USM	EF200mm f/2.8L II USM	EF300mm f/4L USM	EF400mm f/5.6L USM
<b>Focal Length/Aperture</b>	135 mm f/2	200 mm f/2.8	300 mm f/4	400 mm f/5.6
<b>Lens Construction</b>	8 groups, 10 elements	7 groups, 9 elements	7 groups, 8 elements	6 groups, 7 elements
<b>Minimum Aperture</b>	f/32	f/32	f/32	f/32
<b>Angle of View</b>	Diagonal: 18° Vertical: 10° Horizontal: 15°	Diagonal: 12° Vertical: 7° Horizontal: 10°	Diagonal: 8° 15' Vertical: 4° 35' Horizontal: 6° 50'	Diagonal: 6° 10' Vertical: 3° 30' Horizontal: 5° 10'
<b>Min. Focusing Distance</b>	0.9 m / 3.0 ft.	1.5 m / 4.9 ft.	2.5 m / 8.2 ft.	3.5 m / 11.5 ft.
<b>Max. Magnification</b>	0.19 ×	0.16 ×	0.13 ×	0.12 ×
<b>Field of View</b>	124 × 185 mm / 4.9 × 7.3 inch (at 0.9 m)	152 × 226 mm / 6.0 × 8.9 inch (at 1.5 m)	185 × 275 mm / 7.3 × 10.8 inch (at 2.5 m)	194 × 291 mm / 7.6 × 11.5 inch (at 3.5 m)
<b>Filter Diameter</b>	72 mm / 2.8 inch	72 mm / 2.8 inch	77 mm / 3.0 inch	77 mm / 3.0 inch
<b>Max. Diameter and Length</b>	82.5 × 112 mm / 3.2 × 4.4 inch	83.2 × 136.2 mm / 3.3 × 5.4 inch	90 × 213.5 mm / 3.5 × 8.4 inch	90 × 256.5 mm / 3.5 × 10.1 inch
<b>Weight</b>	750 g / 26.5 oz	765 g / 27.0 oz	1165 g / 41.1 oz	1250 g / 44.1 oz
<b>Hood</b>	ET-78 II	ET-83B II	Built-in	Built-in
<b>Lens Cap</b>	E-72U/E-72 II	E-72U/E-72 II	E-77U/E-77 II	E-77U/E-77 II
<b>Case</b>	LP1219	LP1222	LZ1128	LZ1132
<b>Tripod Collar</b>	—	Ring-type tripod mounting socket A II (B) (Sold separately)	Ring-type tripod mounting socket A II (W)	Ring-type tripod mounting socket A II (W)

- The lens length is measured from the mount surface to the front end of the lens. Add 21.5 mm to include the E-72U/E-77U lens cap and dust cap, and 24.2 mm for the E-72 II/E-77 II.
- The size and weight listed are for the lens only, except as indicated.
- Aperture settings are specified on the camera.
- All data listed is measured according to Canon standards.
- Product specifications and appearance are subject to change without notice.

# Canon

## Free Manuals Download Website

<http://myh66.com>

<http://usermanuals.us>

<http://www.somanuals.com>

<http://www.4manuals.cc>

<http://www.manual-lib.com>

<http://www.404manual.com>

<http://www.luxmanual.com>

<http://aubethermostatmanual.com>

Golf course search by state

<http://golfingnear.com>

Email search by domain

<http://emailbydomain.com>

Auto manuals search

<http://auto.somanuals.com>

TV manuals search

<http://tv.somanuals.com>