

Canon

EOS  
**REBEL T1i**  
EOS 500D



Canon

EOS  
REBEL T1i

EOS 500D

INSTRUCTION MANUAL



E

INSTRUCTION  
MANUAL

# Thank you for purchasing a Canon product.

The EOS REBEL T1i/EOS 500D is a high-performance, digital single-lens reflex camera featuring fine-detail CMOS sensor with 15.10 effective megapixels, DIGIC 4, high-precision and high-speed 9-point AF, approx. 3.4 fps continuous shooting, Live View shooting, and Full HD (Full High-Definition) movie shooting.

The camera is highly responsive for shooting at anytime, provides many features for demanding shots, and has many other features.

## Take a Few Test Shots to Familiarize Yourself with the Camera

With a digital camera, you can immediately view the image you have captured. While reading this manual, take a few test shots and see how they come out. You can then better understand the camera.

To avoid botched pictures and accidents, read the Safety Warnings (p.219,220) and Handling Precautions (p.12,13).

## Testing the Camera Before Using and Liability

After shooting, playback and check whether the image has been properly recorded. If the camera or memory card is faulty and the images cannot be recorded or downloaded to a computer, Canon cannot be held liable for any loss or inconvenience caused.

## Copyrights

Copyright laws in your country may prohibit the use of your recorded images of people and certain subjects for anything but private enjoyment. Also be aware that certain public performances, exhibitions, etc., may prohibit photography even for private enjoyment.



This camera is compatible with SD memory cards and SDHC memory cards. This manual will refer to all these cards as just "card."  
**\* The camera does not come with a card for recording images.**  
Please purchase it separately.

# Item Check List

Before starting, check that all the following items have been included with your camera. If anything is missing, contact your dealer.

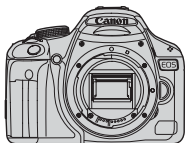

**Camera**  
(with eyecup and  
body cap)



**Battery Pack LP-E5**  
(with protective cover)



**Battery Charger**  
**LC-E5/LC-E5E\***



**Wide Strap**  
**EW-100DB III**



**Interface Cable**  
**IFC-200U**



**AV Cable**  
**AVC-DC400**



**EOS DIGITAL**  
**Solution Disk**  
(Software)



**Software Instruction**  
**Manual**

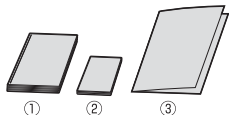

- (1) **Instruction Manual** (this booklet)
- (2) **Pocket Guide**
- (3) **CD-ROM Guide**

Quick start guide to shooting.



Guide to the provided software (EOS DIGITAL Solution Disk) and Software Instruction Manuals.

\* Battery Charger LC-E5 or LC-E5E is provided. (The LC-E5E comes with a power cord.)

- If you purchased a Lens Kit, check that the lens is included.
- Depending on the Lens Kit type, the lens instruction manual might also be included.
- Be careful not to lose any of the above items.

# Conventions Used in this Manual

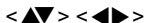
## Icons in this Manual

-  : Indicates the Main Dial.
-  : Indicate the <⬆> cross keys.
-  : Indicates the setting button.
-  : Indicates that the respective function remains active for 4 sec., 6 sec., 10 sec., or 16 sec. respectively after you let go of the button.

\* In this manual, the icons and markings indicating the camera's buttons, dials, and settings correspond to the icons and markings on the camera and on the LCD monitor.

**MENU** : Indicates a function which can be changed by pressing the <MENU> button and changing the setting.

★ : When shown on the upper right of the page, it indicates that the function is available only in the Creative Zone modes (p.20).

(p.\*\*): Reference page numbers for more information.

 : Tip or advice for better shooting.

 : Problem-solving advice.

 : Warning to prevent shooting problems.

 : Supplemental information.

## Basic Assumptions

- All operations explained in this manual assume that the power switch is already set to <ON>.
- It is assumed that all the menu settings and Custom Functions are set to the default.
- For explanatory purposes, the instructions show the camera attached with an EF-S18-55mm f/3.5-5.6 IS lens.

# Chapters

For first-time users, chapters 1 and 2 explain the camera's basic operations and shooting procedures.

	<b>Introduction</b> Camera basics.	2
<b>1</b>	<b>Getting Started</b>	23
<b>2</b>	<b>Basic Shooting and Image Playback</b> Fully automatic shooting for different subjects.	43
<b>3</b>	<b>Advanced Shooting Techniques</b> Shooting features for specific types of subjects.	57
<b>4</b>	<b>More Advanced Techniques</b> Advanced shooting features.	75
<b>5</b>	<b>Live View Shooting</b> Shoot while viewing the LCD monitor.	105
<b>6</b>	<b>Shooting Movies</b>	121
<b>7</b>	<b>Handy Features</b> Convenient menu-based functions.	129
<b>8</b>	<b>Image Playback</b>	147
<b>9</b>	<b>Printing Images and Transferring Images to a Computer</b>	163
<b>10</b>	<b>Customizing the Camera</b>	181
<b>11</b>	<b>Reference</b>	191

# Contents









## Introduction

Item Check List.....	3
Conventions Used in this Manual.....	4
Chapters.....	5
Contents at a Glance.....	10
Handling Precautions.....	12
Quick Start Guide.....	14
Nomenclature.....	16

## 1 Getting Started 23

Charging the Battery.....	24
Installing and Removing the Battery.....	26
Turning on the Power.....	27
Setting the Date and Time.....	29
Selecting the Interface Language.....	30
Installing and Removing the SD Card.....	31
Attaching and Detaching a Lens.....	33
About the Lens Image Stabilizer.....	35
Basic Operation.....	36
<b>MENU</b> Menu Operations.....	38
Formatting the Card.....	40
Switching the LCD Monitor Screen.....	42

## 2 Basic Shooting and Image Playback 43











<input type="checkbox"/> Fully Automatic Shooting.....	44
<input type="checkbox"/> Full Auto Techniques.....	46
 Shooting Portraits.....	47
 Shooting Landscapes.....	48
 Shooting Close-ups.....	49
 Shooting Moving Subjects.....	50
 Shooting Portraits at Night.....	51
 Disabling Flash.....	52
 Creative Auto Shooting.....	53
 Image Playback.....	56

### 3 Advanced Shooting Techniques 57

P: Program AE .....	58
ISO: Changing the ISO Speed .....	60
⚡ Using the Built-in Flash .....	62
AF: Changing the AF Mode .....	64
📷 Selecting the AF Point .....	66
MF: Manual Focusing .....	67
📷 Continuous Shooting .....	68
⌚ Using the Self-timer .....	69
Setting the Image-recording Quality .....	70
📷 Selecting a Picture Style .....	73

### 4 More Advanced Techniques 75



Tv: Action Shots .....	76
Av: Changing the Depth of Field .....	78
Depth of Field Preview .....	80
M: Manual Exposure .....	81
A-DEP: Automatic Depth-of-Field AE .....	82
📷 Changing the Metering Mode .....	83
Av 📷 ⚡ Setting Exposure Compensation .....	84
Auto Exposure Bracketing .....	86
📷 Customizing a Picture Style .....	88
📷 Registering a Picture Style .....	91
Setting the Color Space .....	93
✳ AE Lock .....	94
✳ FE Lock .....	95
WB: Setting the White Balance .....	96
📷 White Balance Correction .....	98
Lens Peripheral Illumination Correction .....	100
Ⓢ Using the Quick Control Screen .....	102
Preventing Camera Shake .....	104

<b>5</b>	<b>Live View Shooting</b>	<b>105</b>
	 Live View Shooting.....	106
	 Setting Shooting Functions .....	108
	Using AF to Focus.....	111
	Focusing Manually.....	118
<b>6</b>	<b>Shooting Movies</b>	<b>121</b>
	 Shooting Movies.....	122
	Movie Settings.....	123
<b>7</b>	<b>Handy Features</b>	<b>129</b>
	Handy Features.....	130
	Silencing the Beeper .....	130
	Card Reminder .....	130
	Setting the Image Review Time .....	130
	Setting the Auto Power-off Time.....	131
	Adjusting the LCD Monitor Brightness .....	131
	File Numbering Methods .....	132
	Auto Rotate of Vertical Images.....	134
	DISP. Checking Camera Settings.....	135
	Reverting the Camera to the Default Settings.....	136
	About Copyright Information.....	137
	Preventing the LCD Monitor from Turning off Automatically .....	138
	Changing the Shooting Settings Screen Color.....	138
	Setting the Flash .....	139
	 Automatic Sensor Cleaning .....	142
	Appending Dust Delete Data .....	143
	Manual Sensor Cleaning .....	145
<b>8</b>	<b>Image Playback</b>	<b>147</b>
	  Searching for Images Quickly.....	148
	 /  Magnified View.....	150
	 Rotating the Image.....	151
	 Playing Movies .....	152



Slide Show (Auto Playback).....	154
Viewing the Images on TV .....	156
 Protecting Images.....	158
 Erasing Images .....	159
DISP. Shooting Information Display .....	161

## **9 Printing Images and Transferring Images to a Computer 163**

Preparing to Print .....	164
 Printing.....	166
Trimming the Image .....	171
 Digital Print Order Format (DPOF).....	173
Direct Printing with DPOF .....	176
 Transferring Images to a Computer.....	177

## **10 Customizing the Camera 181**

Setting Custom Functions .....	182
Custom Function Settings.....	184
Registering My Menu .....	190

## **11 Reference 191**

When Autofocus Fails .....	192
Using a Household Power Outlet .....	193
Remote Control Shooting.....	194
External Speedlites .....	196
Function Availability Table .....	198
Menu Settings .....	200
Troubleshooting Guide.....	203
Error Codes.....	209
System Map .....	210
Specifications .....	212
Index .....	223

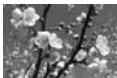

## Contents at a Glance

### Shooting

- **Shoot automatically** → **p.43 - 55** (Basic Zone modes)
- **Shoot continuously** → **p.47, 50, 68** (📷 Continuous shooting)
- **Take a picture of myself in a group** → **p.69** (🕒 Self-timer)
- **Freeze the action**
- **Blur the action** → **p.76** (Tv Shutter-priority AE)
- **Blur the background**
- **Keep the background in sharp focus** → **p.78** (Av Aperture-priority AE)
- **Adjust the image brightness (exposure)** → **p.84** (Exposure compensation)
- **Shoot under low light** → **p.44, 60, 62** (⚡ Flash photography)
- **Shoot without flash** → **p.52** (🚫 Flash Off)
- **Photograph fireworks at night** → **p.81** (Bulb exposure)
- **Shoot while viewing the LCD monitor** → **p.106** (📺 Live View shooting)
- **Shoot movies** → **p.122** (🎬 Movie shooting)

### Image Quality

- **Shoot with image effects matching the subject** → **p.73** (Selecting a Picture Style)





- **Make a large size print of the picture** → p.70 (▲L, ■L, RAW)
- **Take many pictures** → p.70 (▲S, ■S)

## Focusing

- **Change the point of focus** → p.66 (☒ AF point selection)
- **Shoot a moving subject** → p.50, 65 (AI Servo AF)

## Playback

- **View the images with the camera** → p.56 (▶ Playback)
- **Search for pictures quickly** → p.148 (☒ Index display)
- **Prevent important images from accidental deletion** → p.158 (☒ Image protect)
- **Delete unnecessary images** → p.159 (🗑 Delete)
- **View the images on a TV set** → p.156 (Video OUT)
- **Set the LCD brightness** → p.131 (LCD brightness)

## Printing

- **Print pictures easily** → p.163 (Direct printing)



# Handling Precautions

## Camera Care

- This camera is a precision instrument. Do not drop it or subject it to physical shock.
- The camera is not waterproof and cannot be used underwater. If you accidentally drop the camera into water, promptly consult your nearest Canon Service Center. Wipe off any water droplets with a dry cloth. If the camera has been exposed to salty air, wipe it with a well-wrung wet cloth.
- Never leave the camera near anything having a strong magnetic field such as a magnet or electric motor. Also avoid using or leaving the camera near anything emitting strong radio waves such as a large antenna. Strong magnetic fields can cause camera misoperation or destroy image data.
- Do not leave the camera in excessive heat such as in a car in direct sunlight. High temperatures can cause the camera to malfunction.
- The camera contains precision electronic circuitry. Never attempt to disassemble the camera yourself.
- Use a blower to blow away dust on the lens, viewfinder, reflex mirror, and focusing screen. Do not use cleaners that contain organic solvents to clean the camera body or lens. For stubborn dirt, take the camera to the nearest Canon Service Center.
- Do not touch the camera's electrical contacts with your fingers. This is to prevent the contacts from corroding. Corroded contacts can cause camera misoperation.
- If the camera is suddenly brought in from the cold into a warm room, condensation may form on the camera and internal parts. To prevent condensation, first put the camera in a sealed plastic bag and let it adjust to the warmer temperature before taking it out of the bag.
- If condensation forms on the camera, do not use the camera. This is to avoid damaging the camera. If there is condensation, remove the lens, card and battery from the camera, and wait until the condensation has evaporated before using the camera.
- If the camera will not be used for an extended period, remove the battery and store the camera in a cool, dry, well-ventilated location. Even while the camera is in storage, press the shutter button a few times once in a while to check that the camera is still working.
- Avoid storing the camera where there are corrosive chemicals such as a darkroom or chemical lab.
- If the camera has not been used for an extended period, test all its functions before using it. If you have not used the camera for some time or if there is an important shoot coming up, have the camera checked by your Canon dealer or check the camera yourself and make sure it is working properly.

## LCD Monitor

- Although the LCD monitor is manufactured with very high precision technology with over 99.99% effective pixels, there might be a few dead pixels among the remaining 0.01% or less pixels. Dead pixels displaying only black or red, etc., are not a malfunction. They do not affect the images recorded.
- If the LCD monitor is left on for a prolonged period, screen burn-in may occur where you see remnants of what was displayed. However, this is only temporary and will disappear when the camera is left unused for a few days.
- In low or high temperatures, the LCD monitor display may seem slow or it might look black. It will return to normal at room temperature.

## Cards

To protect the card and its recorded data, note the following:

- Do not drop, bend, or wet the card. Do not subject it to excessive force, physical shock, or vibration.
- Do not store or use the card near anything having a strong magnetic field such as a TV set, speakers, or magnet. Also avoid places prone to having static electricity.
- Do not leave the card in direct sunlight or near a heat source.
- Store the card in a case.
- Do not store the card in hot, dusty, or humid locations.

## Lens

After detaching the lens from the camera, attach the lens caps or put down the lens with the rear end up to avoid scratching the lens surface and electrical contacts.



## Cautions During Prolonged Use

If you use continuous shooting, Live View shooting, or movie shooting for a prolonged period, the camera may become hot. Although this is not a malfunction, holding the hot camera for a long period can cause slight skin burns.

# Quick Start Guide

1

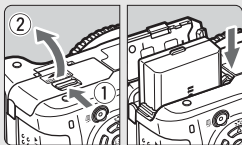

**Insert the battery.** (p.26)

To charge the battery, see page 24.

2

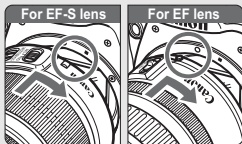

**Attach the lens.** (p.33)

When attaching an EF-S lens, align it with the white index on the camera.  
For other lenses, align it with the red index.

3

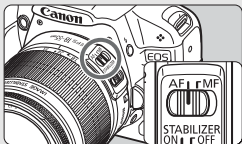

**Set the lens focus mode switch to <AF>.** (p.33)

4

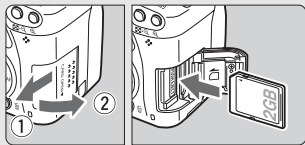

**Open the slot cover and insert a card.** (p.31)

With the card's label facing you, insert it into the slot.

5

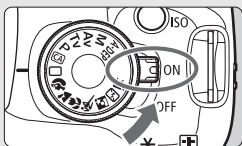

**Set the power switch to <ON>.** (p.27)

- When the LCD monitor displays the Date/Time setting screen, see page 29.

6



**Set the Mode Dial to  (Full Auto).** (p.44)

All the necessary camera settings will be set automatically.

7



**Focus the subject.** (p.37)

Look through the viewfinder and aim the viewfinder center over the subject. Press the shutter button halfway, and the camera will focus the subject.

8

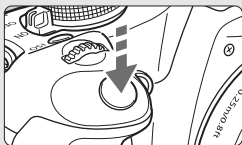

**Take the picture.** (p.37)

Press the shutter button completely to take the picture.

9



**Review the picture.** (p.130)

The captured image will be displayed for about 2 sec. on the LCD monitor. To display the image again, press the  button (p.56).

- The shooting settings displayed on the LCD monitor will turn off when your eye nears the viewfinder eyepiece.
- To delete an image, see “Erasing Images” (p.159).

# Nomenclature

The names in bold indicate the parts explained up until the “Basic Shooting and Image Playback” section.

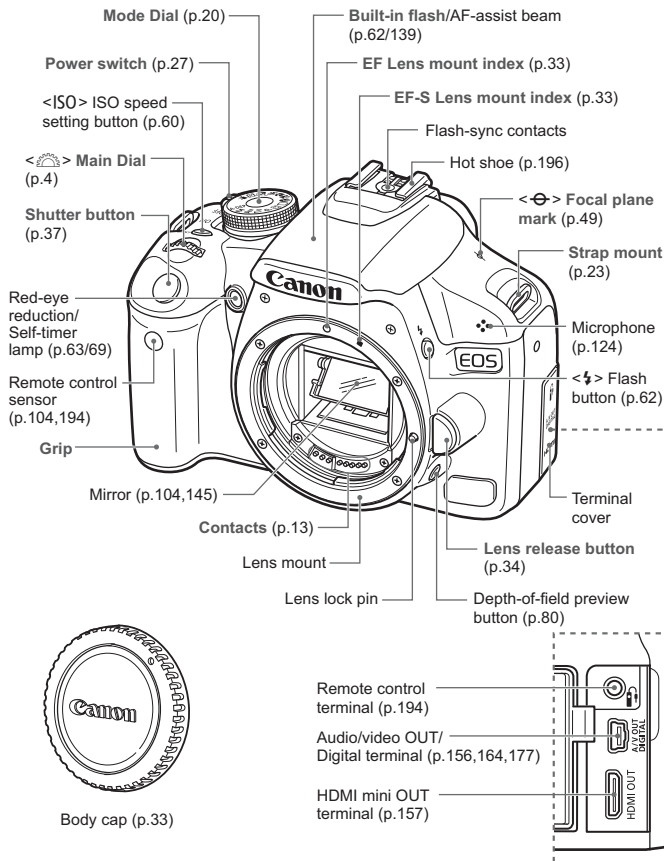



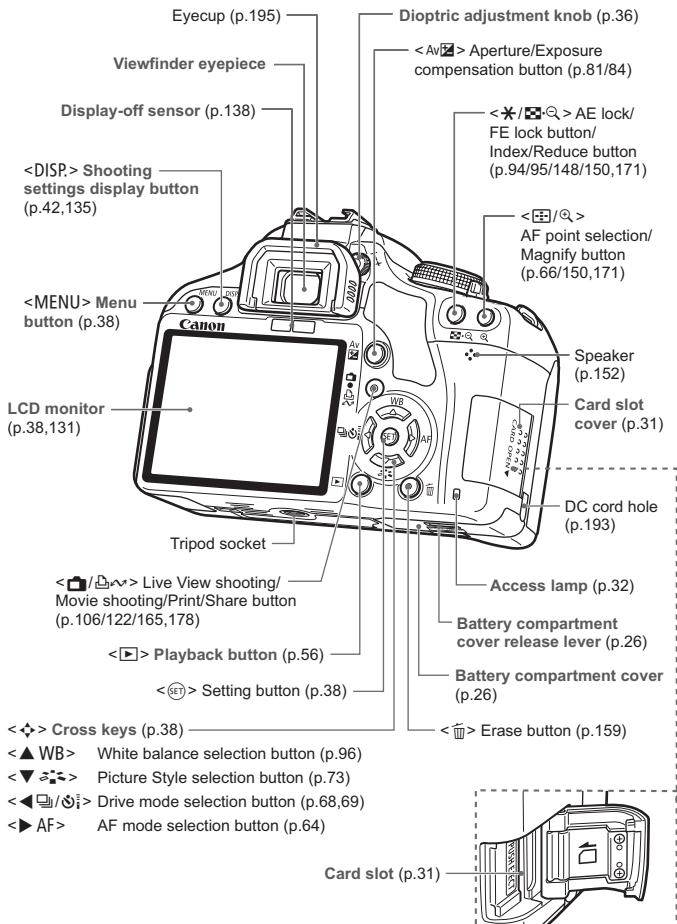

## Shooting Settings Display

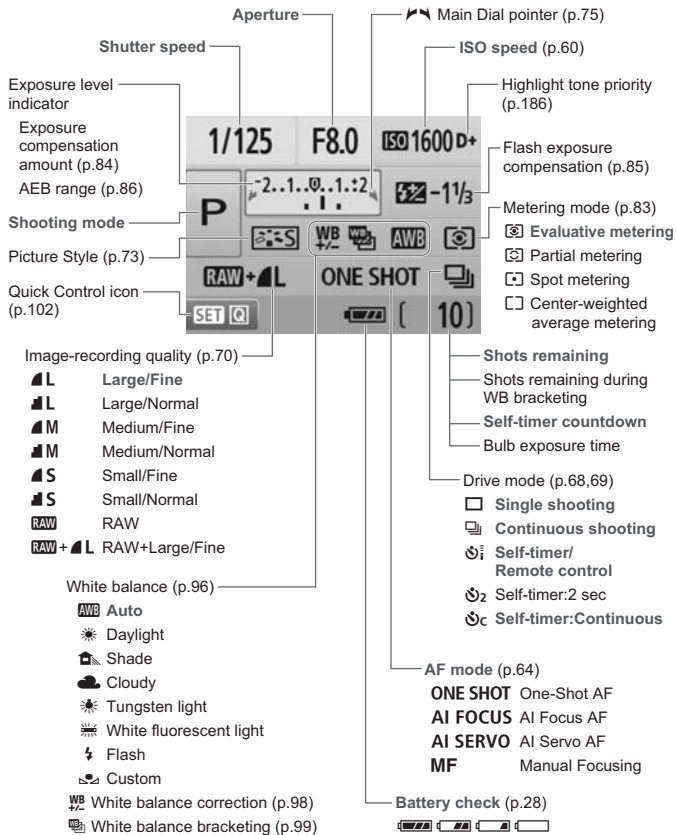

The display will show only the settings currently applied.

## Viewfinder Information

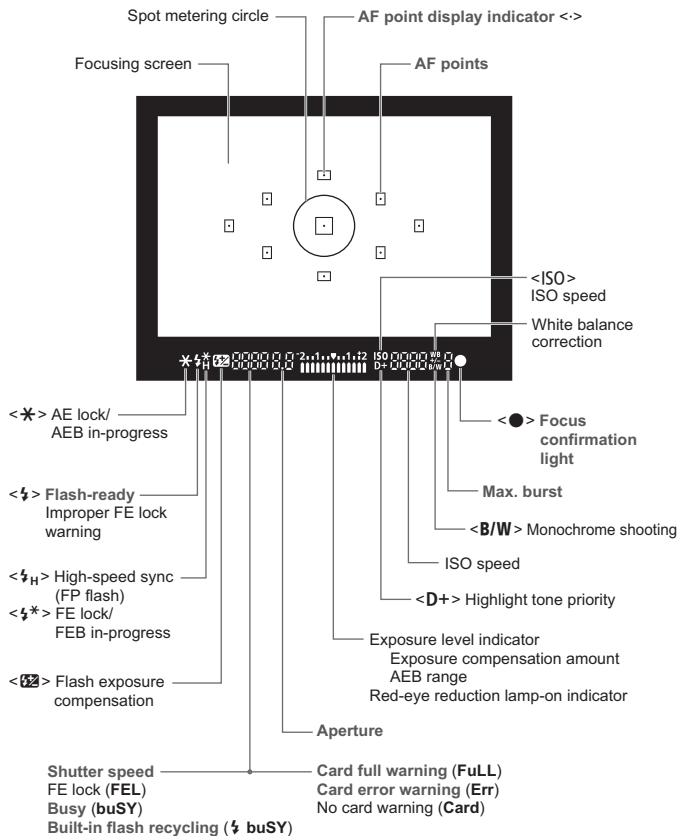

The display will show only the settings currently applied.

## Mode Dial

The Mode Dial has the Basic Zone modes, Creative Zone modes, and Movie shooting mode.



### Creative Zone

These modes give you more control for shooting various subjects.

- P** : Program AE (p.58)
- Tv** : Shutter-priority AE (p.76)
- Av** : Aperture-priority AE (p.78)
- M** : Manual exposure (p.81)
- A-DEP** : Automatic depth-of-field AE (p.82)

### Basic Zone

All you do is press the shutter button. Fully-automatic shooting suitable for the subject.

-  : **Full Auto** (p.44)
-  : **Creative Auto** (p.53)

### Image Zone

-  : **Portrait** (p.47)
-  : **Landscape** (p.48)
-  : **Close-up** (p.49)
-  : **Sports** (p.50)
-  : **Night Portrait** (p.51)
-  : **Flash Off** (p.52)

-  : **Movie shooting** (p.121)

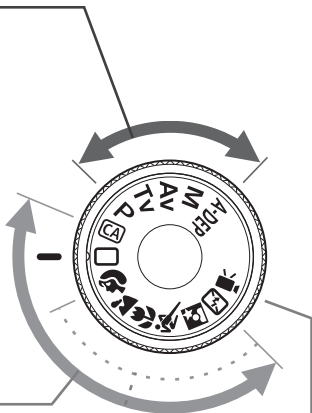

## EF-S18-55mm f/3.5-5.6 IS lens

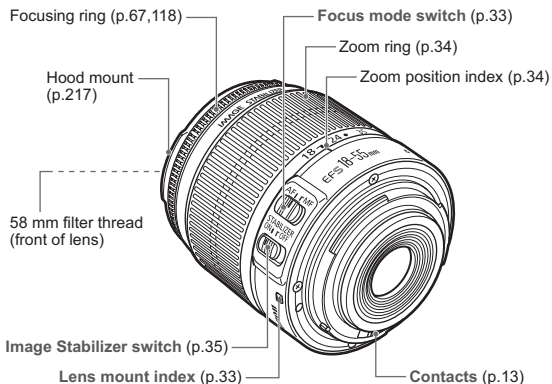

## EF-S18-200mm f/3.5-5.6 IS lens

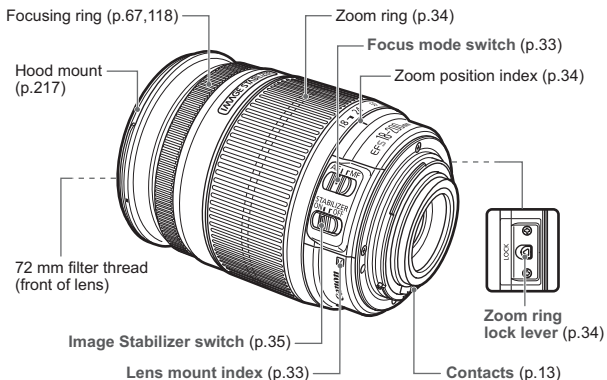

## Battery Charger LC-E5

Charger for Battery Pack LP-E5 (p.24).

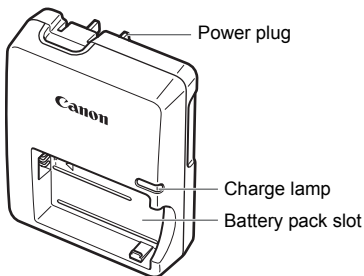

This power unit is intended to be correctly orientated in a vertical or floor mount position.

**IMPORTANT SAFETY INSTRUCTIONS-SAVE THESE INSTRUCTIONS.  
DANGER-TO REDUCE THE RISK OF FIRE OR ELECTRIC SHOCK,  
CAREFULLY FOLLOW THESE INSTRUCTIONS.**

For connection to a supply not in the U.S.A., use an attachment plug adapter of the proper configuration for the power outlet.

## Battery Charger LC-E5E

Charger for Battery Pack LP-E5 (p.24).

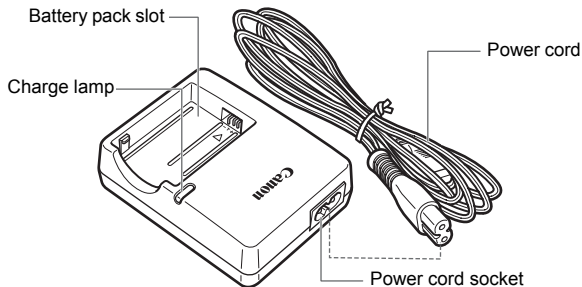

# 1

## Getting Started

This chapter explains preparatory steps before you start shooting and basic camera operations.

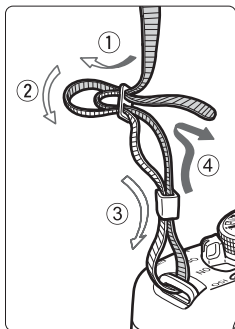

### Attaching the Strap

Pass the end of the strap through the camera's strap mount eyelet from the bottom. Then pass it through the strap's buckle as shown in the illustration. Pull the strap to take up any slack and make sure the strap will not loosen from the buckle.

- The eyepiece cover is also attached to the strap (p.195).

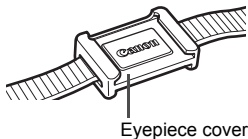

# Charging the Battery

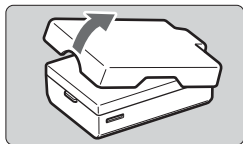

**1** Remove the protective cover.

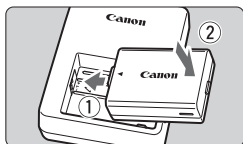

**2** Attach the battery.

- As shown in the illustration, attach the battery securely.
- To detach the battery, follow the above procedure in reverse.

## LC-E5

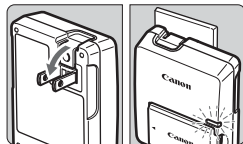

**3** Recharge the battery.

### For LC-E5

- As shown by the arrow, flip out the battery charger's prongs and insert the prongs into a power outlet.

## LC-E5E

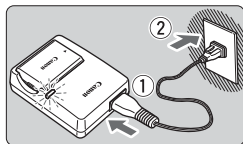

### For LC-E5E

- Connect the power cord to the charger and insert the plug into the power outlet.
- ▶ Recharging starts automatically and the charge lamp turns red.
- ▶ When the battery is fully recharged, the charge lamp will turn green.
- **It takes about 2 hours to fully recharge a completely exhausted battery.**

**The time required to recharge the battery depends on the ambient temperature and battery's charge level.**





## Tips for Using the Battery and Charger

- **Recharge the battery on the day before or on the day it is to be used.**  
Even during non-use or storage, a charged battery will gradually discharge and lose its power.
- **After recharging the battery, detach it and unplug the charger from the power outlet.**
- **When not using the camera, remove the battery.**  
If the battery is left in the camera for a prolonged period, a small amount of power current is released, resulting in excess discharge and shorter battery life. Store the battery with the protective cover attached. Storing the battery after it is fully charged can lower the battery's performance.
- **The battery charger can also be used in foreign countries.**  
The battery charger is compatible with a 100 V AC to 240 V AC 50/60 Hz power source. If necessary, attach a commercially-available plug adapter for the respective country or region. Do not attach any portable voltage transformer to the battery charger. Doing so can damage the battery charger.
- **If the battery becomes exhausted quickly even after being fully charged, the battery has worn out.**  
Purchase a new battery.



- Do not charge any battery other than Battery Pack LP-E5.
- Battery Pack LP-E5 is dedicated to Canon products only. Using it with an incompatible battery charger or product may result in malfunction or accidents for which Canon cannot be held liable.

# Installing and Removing the Battery

## Installing the Battery

Load a fully charged Battery Pack LP-E5 into the camera.

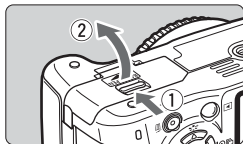

### 1 Open the battery compartment cover.

- Slide the lever as shown by the arrow and open the cover.

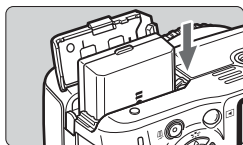

### 2 Insert the battery.

- Insert the end with the battery contacts.
- Insert the battery until it locks in place.

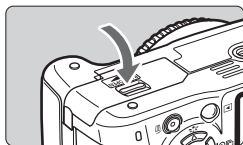

### 3 Close the cover.

- Press the cover until it snaps shut.

## Removing the Battery

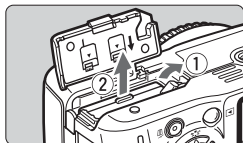

### Open the cover and remove the battery.

- Press the battery release lever as shown by the arrow and remove the battery.
- To prevent short circuiting, be sure to attach the protective cover to the battery.

 After opening the battery compartment cover, be careful not to swing it back further. Otherwise, the hinge might break.

## Turning on the Power

When you turn on the power switch and the **date/time setting screen** appears, see **page 29** to set the date/time.

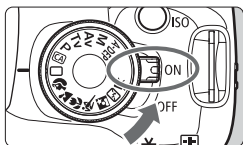

<ON> : The camera turns on.

<OFF> : The camera is turned off and does not operate. Set to this position when not using the camera.

### About the Automatic Self-Cleaning Sensor

- Whenever you set the power switch to <ON> or <OFF>, the sensor cleaning will be executed automatically. During the sensor cleaning, the LCD monitor will display <□>. Even during the sensor cleaning, you can still shoot by pressing the shutter button halfway (p.37) to stop the sensor cleaning and take a picture.
- If you turn <ON>/<OFF> the power switch at a short interval, the <□> icon might not be displayed. This is normal and not a problem.

### About Auto Power Off

- To save battery power, the camera turns off automatically after about 30 seconds of non-operation. To turn on the camera again, just press the shutter button halfway (p.37).
- You can change the auto power-off time with the menu's [**Auto power off**] setting (p.131).



If you set the power switch to <OFF> while an image is being recorded to the card, [**Recording ...**] will be displayed and the power will turn off after the card finishes recording the image.

## Checking the Battery Level

When the power switch is set to <ON>, the battery level will be indicated in one of four levels:



 : Battery level is OK.

 : Battery level is slightly down, but adequate power remains.

 : Battery will be exhausted soon.

 : Battery must be recharged.

## Battery Life

[Approx. number of shots]

Temperature	Shooting Conditions	
	No Flash	50% Flash Use
At 23°C / 73°F	500	400
At 0°C / 32°F	490	380

- The figures above are based on a fully-charged Battery Pack LP-E5, shooting through the viewfinder, and CIPA (Camera & Imaging Products Association) testing standards.



- The actual number of shots may be fewer than indicated above depending on the shooting conditions.
- Pressing the shutter button halfway for long periods or operating only the autofocus can also reduce the number of possible shots.
- The number of possible shots will decrease with more frequent use of the LCD monitor.
- The lens operation is powered by the camera's battery. Depending on the lens used, the number of possible shots may be lower.
- Using the Image Stabilizer of the lens will decrease the number of possible shots (shorter battery life).
- For battery life with Live View shooting, see page 107.

## MENU Setting the Date and Time

When you turn on the power for the first time or if the date/time has been reset, the Date/Time setting screen will appear. Follow steps 3 and 4 to set the date/time. **Note that the date/time appended to recorded images will be based on this Date/Time setting. Be sure to set the date/time.**

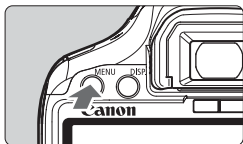

### 1 Display the menu.

- Press the <MENU> button to display the menu.



### 2 Under the [Date/Time] tab, select [Date/Time].

- Press the <◀▶> key to select the [Date/Time] tab.
- Press the <▲▼> key to select [Date/Time], then press <SET>.

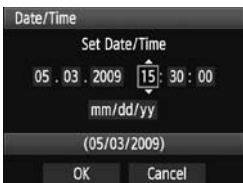

### 3 Set the date and time.

- Press the <◀▶> key to select the date or time number.
- Press <SET> so  $\square$  is displayed.
- Press the <▲▼> key to set the number, then press <SET>. (Returns to  $\square$ .)

### 4 Exit the setting.

- Press the <◀▶> key to select [OK], then press <SET>.
- ▶ The date/time will be set.
- Press the <MENU> button to return to the shooting settings display.



- The date/time set will start from when you press <SET> in step 4.
- If you store the camera without the battery or if the camera's battery becomes exhausted, the date/time might be reset. If this happens, set the date/time again.

## MENU Selecting the Interface Language

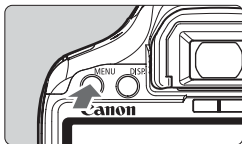

### 1 Display the menu.

- Press the <MENU> button to display the menu.



### 2 Under the [Language] tab, select [Language].

- Press the <◀▶> key to select the [Language] tab.
- Press the <▲▼> key to select [Language] (the third item from the top), then press <SET>.

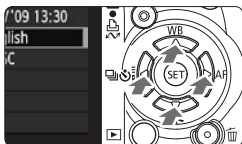

### 3 Set the desired language.

- Press the <⬤> key to select the language, then press <SET>.
- ▶ The language will change.
- Press the <MENU> button to return to the shooting settings display.

English	Norsk	Română
Deutsch	Svenska	Türkçe
Français	Español	العربية
Nederlands	Ελληνικά	ภาษาไทย
Dansk	Русский	简体中文
Português	Polski	繁體中文
Suomi	Čeština	한국어
Italiano	Magyar	日本語
Українська		

# Installing and Removing the SD Card

The captured image is recorded onto the card (sold separately).

- **Make sure the card's write protect switch is set upward to enable writing/erasing.**

## Installing the Card

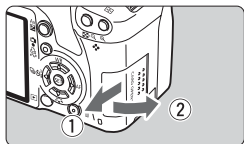

### 1 Open the cover.

- Slide the cover as shown by the arrow to open it.

Card's write  
protect switch

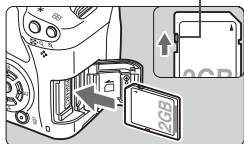

### 2 Insert the card.

- As shown by the illustration, face the card's label side toward you and insert it until it clicks in place.

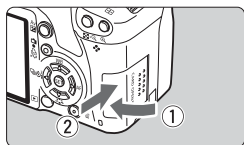

### 3 Close the cover.

- Close the cover and slide it in the direction shown by the arrow until it snaps shut.
- When you set the power switch to <ON>, the number of remaining shots will be displayed on the LCD monitor.



Shots remaining



- The number of shots remaining depends on the remaining capacity of the card, image-recording quality, ISO speed, etc.
- Setting the [Release shutter without card] menu option to [Disable] will prevent you from forgetting to install a card (p.130).

## Removing the Card

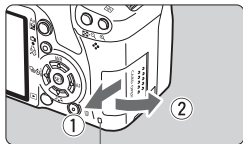

Access lamp

### 1 Open the cover.

- Set the power switch to <OFF>.
- Check that "Recording..." is not displayed on the LCD monitor.
- **Make sure the access lamp is off, then open the cover.**

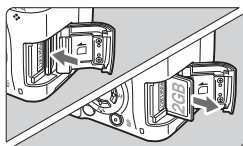

### 2 Remove the card.

- Gently push in the card, then let go. The card will stick out.
- Pull the card straight out, then close the cover.

- **When the access lamp is lit or blinking, it indicates that the images are being written to or read by the card, being erased, or data is being transferred. While the access lamp is lit or blinking, never do any of the following. Doing so may damage the image data. It may also damage the card or camera.**
    - **Opening the card slot cover.**
    - **Removing the battery.**
    - **Shaking or banging the camera around.**
  - If the card already contains recorded images, the image number might not start from 0001 (p.132).
  - Do not touch the card's contacts with your fingers or metal objects.
  - If a card-related error message is displayed on the LCD monitor, remove and reinstall the card. If the error persists, use a different card.
- If you can transfer all the images in the card to a computer, transfer all the images and then format the card (p.40). The card may then return to normal.



# Attaching and Detaching a Lens

## Attaching a Lens

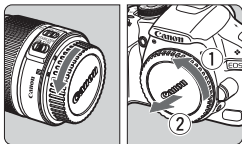

### 1 Remove the caps.

- Remove the rear lens cap and the body cap by turning them as shown by the arrow.

### EF-S lens mount index

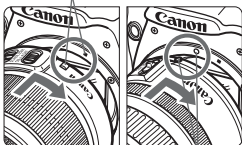

EF lens mount index

### 2 Attach the lens.

- Align the EF-S lens with the camera's white EF-S lens mount index and turn the lens as shown by the arrow until it clicks in place.
- When attaching a lens other than an EF-S lens, align the lens with the red EF lens mount index.

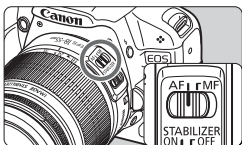

### 3 On the lens, set the focus mode switch to <AF> (autofocus).

- If it is set to <MF> (manual focus), autofocus will not operate.

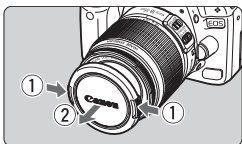

### 4 Remove the front lens cap.

#### Minimizing Dust

- When changing lenses, do it in a place with minimal dust.
- When storing the camera without a lens attached, be sure to attach the body cap to the camera.
- Remove dust on the body cap before attaching it.

## About Zooming

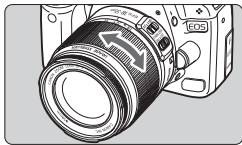

To zoom, turn the zoom ring on the lens with your fingers.

**If you want to zoom, do it before focusing. Turning the zoom ring after achieving focus may throw off the focus slightly.**

## Detaching the Lens



**While pressing the lens release button, turn the lens as shown by the arrow.**

- Turn the lens until it stops, then detach it.
- Attach the rear lens cap to the detached lens.

## To owners of the EF-S18-200mm f/3.5-5.6 IS kit lens:

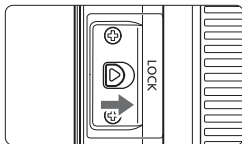

You can prevent the lens from extending out while you are carrying it around. Set the zoom ring to the 18mm wide-angle end, then slide the zoom ring lock lever to <b>LOCK</b>. The zoom ring can be locked only at the wide-angle end.

- Do not look at the sun directly through any lens. Doing so may cause loss of vision.
- If the front part (focusing ring) of the lens rotates during autofocus, do not touch the rotating part.



### Image Conversion Factor

Since the image sensor size is smaller than the 35mm film format, it will look like the lens focal length is increased by 1.6x.



# About the Lens Image Stabilizer

When you use the IS lens' built-in Image Stabilizer, camera shake is corrected to obtain a less blurred shot. The procedure explained here is based on the EF-S18-55mm f/3.5-5.6 IS lens as an example.

\* IS stands for Image Stabilizer.

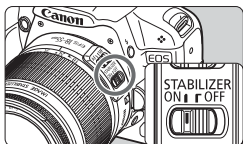

## 1 Set the IS switch to <ON>.

- Set the camera's power switch to <ON>.

## 2 Press the shutter button halfway.

- ▶ The Image Stabilizer will operate.

## 3 Take the picture.

- When the picture looks steady in the viewfinder, press the shutter button completely to take the picture.



- The Image Stabilizer is not effective for moving subjects.
- The Image Stabilizer may not be effective for excessive shaking such as on a rocking boat.



- The Image Stabilizer can operate with the focus mode switch set to either <AF> or <MF>.
- If the camera is mounted on a tripod, you can save battery power by switching the IS switch to <OFF>.
- The Image Stabilizer is effective even when the camera is mounted on a monopod.
- Some IS lenses enable you to switch the IS mode manually to suit the shooting conditions. However, the EF-S18-55mm f/3.5-5.6 IS and EF-S18-200mm f/3.5-5.6 IS lenses switch the IS mode automatically.

# Basic Operation

## Adjusting the Viewfinder Clarity

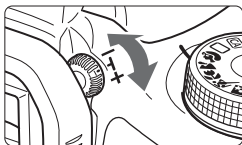

### Turn the dioptic adjustment knob.

- Turn the knob left or right so that the nine AF points in the viewfinder look sharp.

If the camera's dioptic adjustment still cannot provide a sharp viewfinder image, using Dioptic Adjustment Lens E (10 types, sold separately) is recommended.

## Holding the Camera

To obtain sharp images, hold the camera still to minimize camera shake.

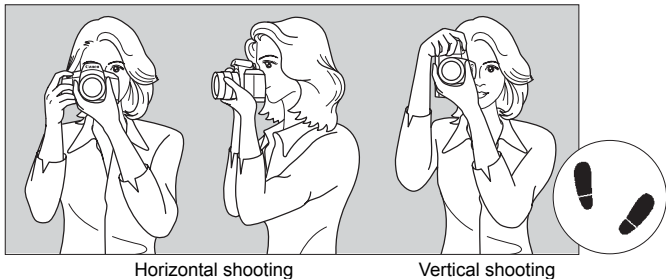

1. Wrap your right hand around the camera grip firmly.
2. Hold the lens bottom with your left hand.
3. Press the shutter button lightly with your right hand's index finger.
4. Press your arms and elbows lightly against the front of your body.
5. Press the camera against your face and look through the viewfinder.
6. To maintain a stable stance, place one foot in front of the other.

For shooting while looking at the LCD monitor, see page 105.

## Shutter Button

The shutter button has two steps. You can press the shutter button halfway. Then you can further press the shutter button completely.

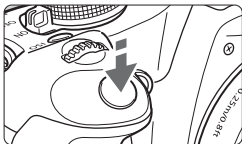

### Pressing halfway

This activates autofocus and automatic exposure metering that sets the shutter speed and aperture. The exposure setting (shutter speed and aperture) is displayed in the viewfinder. (ⓘ4)

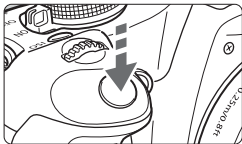

### Pressing completely

This releases the shutter and takes the picture.

## Preventing Camera Shake

Camera movement during the moment of exposure is called camera shake. Camera shake can cause blurred pictures. To prevent camera shake, note the following:

- Hold and steady the camera as shown on the previous page.
- Press the shutter button halfway to autofocus, then press the shutter button completely.



- If you press the shutter button completely without pressing it halfway first or if you press the shutter button halfway and then press it completely immediately, the camera will take a moment before it takes the picture.
- Even during the menu display, image playback, and image recording, you can instantly go back to shooting-ready by pressing the shutter button halfway.

## MENU Menu Operations

You can set various functions with the menus such as the image-recording quality, date/time, etc. While looking at the LCD monitor, use the <MENU> button, <⬅➡> cross keys, and <SET> button on the camera back.

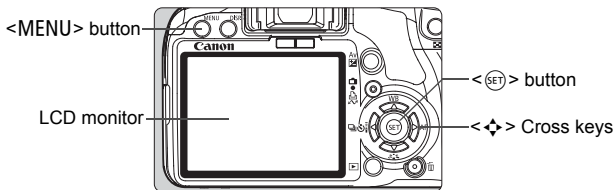

### Menu Screen

#### Basic Zone modes



#### Movie shooting mode



\* In the Basic Zone modes and Movie shooting mode, certain tabs and menu options will not be displayed.

#### Creative Zone modes

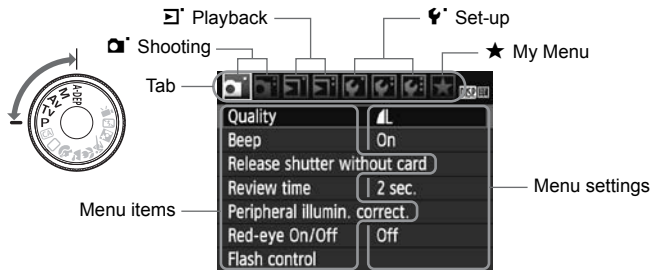

## Menu Setting Procedure

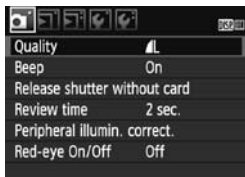

### 1 Display the menu.

- Press the <MENU> button to display the menu.

### 2 Select a tab.

- Press the <◀▶> key to select a tab.
- You can also turn the <☀> dial to select a tab.

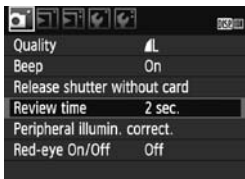

### 3 Select the desired item.

- Press the <▲▼> key to select the item, then press <SET>.

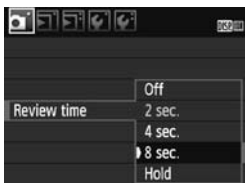

### 4 Select the setting.

- Press the <▲▼> or <◀▶> key to select the setting. (Some settings require you to press either the <▲▼> or <◀▶> key to select it.)
- The current setting is indicated in blue.

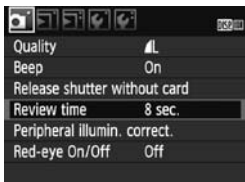

### 5 Set the desired setting.

- Press <SET> to set it.

### 6 Exit the menu.

- Press the <MENU> button to return to the shooting settings display.



- The explanation of menu functions hereinafter assumes that you have pressed the <MENU> button to display the menu screen.
- A list of menu functions is on page 200.

## MENU Formatting the Card

If the card is new or was previously formatted by another camera or computer, format the card with the camera.

**⚠ When the card is formatted, all images and data in the card will be erased. Even protected images will be erased, so make sure there is nothing you need to keep. If necessary, transfer the images to a computer, etc., before formatting the card.**

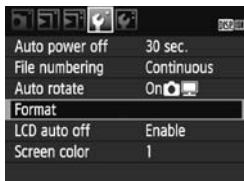

### 1 Select [Format].

- Under the [**F**] tab, select [**Format**], then press <[SET]>.



### 2 Format the card.

- Select [**OK**], then press <[SET]>.
  - ▶ The card will be formatted.
  - ▶ When the formatting is completed, the menu will reappear.
- 
- For low-level formatting, press the <[L]> button, checkmark [**Low level format**] with <[✓]>, then select [**OK**].







## Execute [Format] in the following cases:

- The card is new.
- The card was formatted by a different camera or a computer.
- The card is full with images or data.
- A card-related error is displayed (p.209).

### About Low-level Formatting

- Do low-level formatting if the card's recording or reading speed seems slow.
- Since low-level formatting will erase all recordable sectors in the card, the formatting will take slightly longer than normal formatting.
- You can stop the low-level formatting by selecting **[Cancel]**. Even in this case, normal formatting will have been completed and you can use the card as usual.



When the card is formatted or data is erased, only the file management information is changed. The actual data is not completely erased. Be aware of this when selling or discarding the card. When discarding the card, execute low-level formatting or destroy the card physically to prevent the data from being leaked.



The card capacity displayed on the card format screen might be smaller than the capacity indicated on the card.

# Switching the LCD Monitor Screen

The LCD monitor can display the shooting settings screen, menu screen, image, etc.

## Shooting Settings



- Displayed when the camera is turned on.
- When your eye nears the viewfinder eyepiece, the display-off sensor (p.17, 138) turns off the LCD monitor automatically. This prevents the bright LCD monitor from interfering with your view. The LCD monitor turns on again when your eye leaves the viewfinder eyepiece.
- While the menu screen or image is displayed as shown below, you can instantly return to the shooting settings screen (shown on the left) by pressing the shutter button halfway.
- Pressing the <DISP.> button turns the display on or off.

- If you look at the viewfinder while wearing sunglasses, the LCD monitor might not turn off automatically. In such a case, press the <DISP.> button to turn off the monitor.
- If a fluorescent light is nearby, the LCD monitor might turn off. If this happens, take the camera away from the fluorescent light.

## Menus

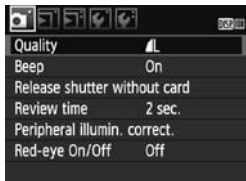

- Appears when you press the <MENU> button. Press the button again to return to the previous screen.

## Captured Image



- Appears when you press the <▶> button. Press the button again to return to the previous screen.

# 2

## Basic Shooting and Image Playback

This chapter explains how to use the Basic Zone modes on the Mode Dial for best results and how to playback images.

With the Basic Zone modes, all you do is point and shoot and the camera sets everything automatically (p.198). Also, to prevent botched pictures due to mistaken operations, major shooting settings cannot be changed in the Basic Zone modes. The settings (functions set automatically) which cannot be set by the user are grayed out.

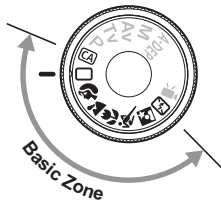

### About the Auto Lighting Optimizer

In the Basic Zone modes, the Auto Lighting Optimizer will adjust the image automatically to obtain the optimum brightness and contrast. It is also enabled by default in the Creative Zone modes (p.186).

## ☐ Fully Automatic Shooting



**1** Set the Mode Dial to <☐>.

AF point

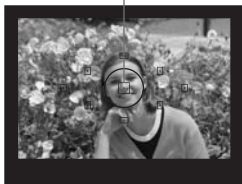

**2** Aim any AF point over the subject.

- All the AF points will be used to focus, and generally the closest object will be focused.
- Aiming the center AF point over the subject will make focusing easier.

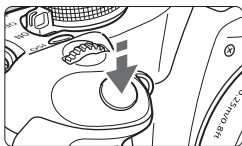

**3** Focus the subject.

- Press the shutter button halfway, and the lens will adjust the focus.
- ▶ The dot inside the AF point achieving focus flashes briefly in red. At the same time, the beeper will sound and the focus confirmation light <●> in the viewfinder will light.
- ▶ If necessary, the built-in flash will pop-up automatically.



Focus confirmation light



**4** Take the picture.

- Press the shutter button completely to take the picture.
- ▶ The captured image will be displayed for about 2 sec. on the LCD monitor.
- If the built-in flash has popped up, you can push it back down with your fingers.

## ? FAQ

- **The focus confirmation light <●> blinks and focus is not achieved.**  
Aim the AF point over an area having good contrast, then press the shutter button halfway (p.192). If you are too close to the subject, move away and try again.
- **Sometimes multiple AF points flash simultaneously.**  
This indicates that focus has been achieved at all those AF points. As long as the AF point covering the desired subject flashes, you can take the picture.
- **The beeper continues to beep softly. (The focus confirmation light <●> also does not light.)**  
It indicates that the camera is focusing continuously on a moving subject. (The focus confirmation light <●> does not light.) While the beeper is beeping, you can press the shutter button completely to shoot a moving subject in focus.
- **Pressing the shutter button halfway does not focus the subject.**  
When the focus mode switch on the lens is set to <MF> (Manual Focus), the camera does not focus. Set the focus mode switch to <AF> (Auto Focus).
- **Although it is daylight, the flash popped up.**  
For a backlit subject, the flash may pop up to help reduce harsh shadows on the subject.
- **In low light, the built-in flash fired a series of flashes.**  
To assist the autofocusing, pressing the shutter button halfway may trigger the built-in flash to fire a series of flashes. This is called AF-assist beam. It is effective up to approx. 4 meters/13.1 feet away.
- **Although flash was used, the picture came out dark.**  
The subject was too far away. The subject should be within 5 meters/16.4 feet from the camera.
- **When flash was used, the bottom part of the picture came out unnaturally dark.**  
The subject was too close to the camera, and a shadow was created by the lens. The subject should be at least 1 meter/3.3 feet away from the camera. If a hood has been attached to the lens, remove it before taking the flash picture.

## Full Auto Techniques

### Recomposing the Shot



Depending on the scene, position the subject toward the left or right to create a balanced background and good perspective.



In the <> (Full Auto) mode, while you press the shutter button halfway to focus a still subject, the focus will be locked. You can then recompose the shot and press the shutter button completely to take the picture. This is called “focus lock”. Focus lock is also possible in other Basic Zone modes (except < > Sports).

### Shooting a Moving Subject



In the <> (Full Auto) mode, if the subject moves (distance to camera changes) during or after you focus, AI Servo AF will take effect to focus the subject continuously. As long as you keep aiming the AF point at the subject while pressing the shutter button halfway, the focusing will be continuous. When you want to take the picture, press the shutter button completely.

## Shooting Portraits

The  (Portrait) mode blurs the background to make the human subject stand out. It also makes flesh tones and the hair look softer than with the  (Full Auto) mode.



### Shooting Tips

- **The farther the distance between the subject and background, the better.**



The further the distance between the subject and background, the more blurred the background will look. The subject will also stand out better in front of a plain, dark background.

- **Use a telephoto lens.**  
If you have a zoom lens, use the telephoto end to fill the frame with the subject from the waist up. Move in closer if necessary.
- **Focus the face.**  
Check that the AF point covering the face flashes in red.



- If you hold down the shutter button, you can shoot continuously to obtain different poses and facial expressions. (max. approx. 3.4 shots/sec.)
- If necessary, the built-in flash will pop up automatically.

## Shooting Landscapes

Use the <  > (Landscape) mode for wide scenery, night scenes, or to have everything in focus from near to far. The greens and blues also become more vivid and sharper than with <  > (Full Auto).

---

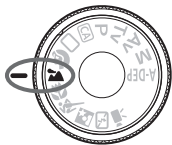

### Shooting Tips

- **With a zoom lens, use the wide-angle end.**

When using the wide-angle end of a zoom lens, objects near and far will be in focus better than at the telephoto end. It also adds breadth to landscapes.

- **Shooting night scenes.**

Since the built-in flash will be disabled, this mode is also good for night scenes. Use a tripod to prevent camera shake. If you want to photograph a person against a night scene, set the Mode Dial to <  > (Night Portrait) and use a tripod (p.51).







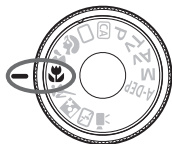

## Shooting Close-ups

When you want to photograph flowers or small things up close, use the  (Close-up) mode. To make small things appear much larger, use a macro lens (sold separately).

---



### Shooting Tips

- **Use a simple background.**  
A simple background makes the flower, etc., stand out better.
- **Move to the subject as close as possible.**  
Check the lens for its minimum focusing distance. Some lenses have indications such as  **0.25m/0.8ft**. The lens minimum focusing distance is measured from the  (focal plane) mark on the camera to the subject. If you are too close to the subject, the focus confirmation light  will blink.  
Under low light, the built-in flash will fire. If you are too close to the subject and the bottom of the picture looks dark, move away from the subject.
- **With a zoom lens, use the telephoto end.**  
If you have a zoom lens, using the telephoto end will make the subject look larger.

## Shooting Moving Subjects

To photograph a moving subject, whether it is a child running or a moving vehicle, use the  (Sports) mode.

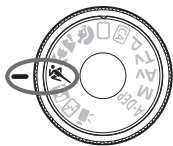

### Shooting Tips

- **Use a telephoto lens.**

Using a telephoto lens is recommended so you can shoot from afar.

- **Use the center AF point to focus.**

Aim the center AF point over the subject, then press the shutter button halfway to auto focus. During autofocusing, the beeper will continue beeping softly. If focus cannot be achieved, the focus confirmation light  will blink.

When you want to take the picture, press the shutter button completely. If you hold down the shutter button, continuous shooting (max. approx. 3.4 shots per sec.) and autofocusing will take effect.



 Under low light when camera shake is prone to occur, the viewfinder's shutter speed display on the bottom left will blink. Hold the camera steady and shoot.

## Shooting Portraits at Night

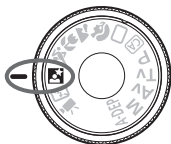
To shoot someone at night and obtain a natural-looking exposure in the background, use the  (Night Portrait) mode.



### Shooting Tips

- **Use a wide-angle lens and a tripod.**  
When using a zoom lens, use the wide-angle end to obtain a wide night view. Also, use a tripod to prevent camera shake.
- **Keep the person within 5 meters/16.4 feet from the camera.**  
Under low light, the built-in flash will fire automatically to obtain a good exposure of the person. The effective distance of the built-in flash is 5 meters/16.4 feet from the camera.
- **Shoot also with  (Full Auto).**  
Since camera shake is prone to occur with night shots, shooting also with  (Full Auto) is recommended.



- Tell the subject to keep still even after the flash fires.
- If the self-timer is also used, the self-timer lamp will flash after the picture is taken.

## Disabling Flash

In places where flash photography is prohibited, use the <> (Flash Off) mode. This mode is also effective for candlelight scenes when you want to capture the ambient light.

---

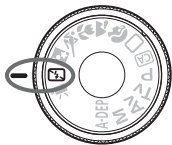

### Shooting Tips

- **If the numeric display in the viewfinder blinks, take care to prevent camera shake.**

Under low light when camera shake is prone to occur, the viewfinder's shutter speed display will blink. Hold the camera steady or use a tripod. When using a zoom lens, use the wide-angle end to reduce blur caused by camera shake.

- **Taking portraits without flash.**

Under low light, the person must not move until the picture is taken. If the person moves during the exposure, he or she might look blurred in the picture.

## **CA** Creative Auto Shooting

Basic Zone modes except <CA> (Creative Auto) take care of everything, whereas the <CA> Creative Auto mode enables you to easily change the picture's brightness, depth of field, color tone (Picture Style), etc. The default settings are the same as the <□> (Full Auto) mode.

\* CA stands for Creative Auto.



### **1** Set the Mode Dial to <CA>.

- ▶ The Creative Auto screen appears on the LCD monitor.

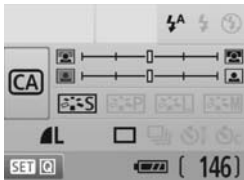

### **2** Press <SET>.

- You can use the <⬆> key to select the function. (⌚10)
- For details about each function, see page 54-55.



### **3** Set the desired setting.

- Press the <⬆> key to select the function.
- ▶ A brief description of the selected function is displayed on the screen's bottom.
- Turn the <⚙> dial to change the setting.
- Press the shutter button halfway to return to the screen in step 2.

### **4** Take the picture.

- Press the shutter button completely to take the picture.



If you change the shooting mode or if the power turns off via auto power off (p.131) or by setting the power switch to <OFF>, the Creative Auto settings will revert to the default. However, the image-recording quality, self-timer and remote control settings will be retained.

Shutter speed and aperture

(1)

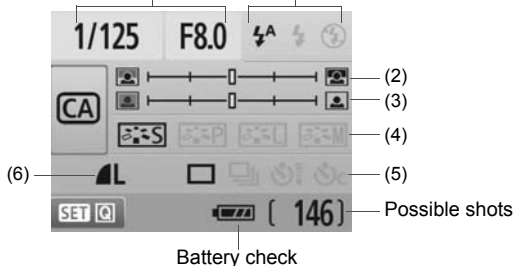

### (1) Flash firing



<⚡<sup>A</sup>> (Auto firing), <⚡> (Flash on), or <⚡/> (Flash off) can be selected.

If you set <⚡/> (Flash off), see “Disabling Flash” on page 52.

### (2) Blurring/sharpening the background

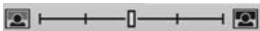

If you move the index mark toward the left, the background will look more blurred. If you move it toward the right, the background will look more in focus. If you want to blur the background, see “Shooting Portraits” on page 47.

Depending on the lens and shooting conditions, the background might not look so blurred. This cannot be set (grayed out) while the built-in flash is popped up. When flash is used, this setting will not be applied.

### (3) Adjusting the picture brightness

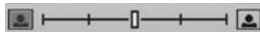

If you move the index mark toward the left, the picture will look darker. If you move it toward the right, the picture will look brighter.

#### (4) Image effects



Besides the standard image effect, you can set it for portraits, landscapes, or black-and-white photos. (p.73: Picture Style)

< > (Standard): Standard image effect applicable to most scenes.

< > (Smooth skin tones): Effective for close-ups of women or children.

< > (Vivid blues and greens): For impressive landscapes.

< > (Monochrome image): Creates black-and-white photos.

#### (5) Single, continuous, and self-timer shooting



< > (Continuous shooting): Shoot continuously at a maximum of about 3.4 frames per second (fps).

< > (Self-timer/Remote control): See the “Using the Self-timer” note ( ) on p.69. Remote control shooting is also possible. (p.194)

< > (Self-timer:Continuous): After 10 sec., the set number of shots is taken continuously. Press the < > key to set the number of multiple shots (2 to 10) to be taken with the self-timer.

\* By pressing < >, you can display the [Drive mode] selection screen and set the same settings.

#### (6) Image-recording quality



To set the image-recording quality, see “Setting the Image-recording Quality” on page 70-72. By pressing < >, you can display the [Quality] selection screen and set the same settings.

## Image Playback

The easiest way to playback images is explained below. For more details on the playback procedure, see page 147.



### 1 Playback the image.

- When you press the <▶> button, the last captured image will be displayed.



### 2 Select the image.

- To view images starting with the last image, press the <◀> key. To view images starting with the first (oldest) image, press the <▶> key.
- Press the <DISP.> button to change the display format.



Single image display



Single image display +  
Image-recording quality

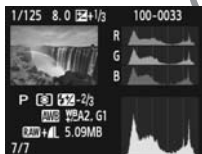

Histogram display

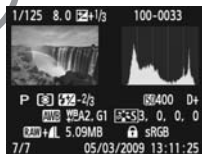

Shooting information display

### 3 Exit the image playback.

- Press the <▶> button to exit the image playback and return to the shooting settings display.



# 3

## Advanced Shooting Techniques

In the Basic Zone modes, to prevent spoiled shots, most functions are set automatically and cannot be changed. In the <P> (Program AE) mode, you can set various functions and be more creative.

- In the <P> (Program AE) mode, the camera sets the shutter speed and aperture automatically to obtain the standard exposure.
- The difference between the Basic Zone modes and <P> is explained on page 198.

\* <P> stands for Program.

\* AE stands for Auto Exposure.

# P: Program AE

To obtain a good exposure of the subject, the camera sets the exposure (shutter speed and aperture) automatically. This is called Program AE.



## 1 Set the Mode Dial to <P>.



## 2 Focus the subject.

- Look through the viewfinder and aim the selected AF point over the subject. Then press the shutter button halfway.
- ▶ The dot inside the AF point achieving focus flashes briefly in red, and the focus confirmation light <●> in the viewfinder's bottom right lights (with One Shot AF + automatic AF point selection).
- ▶ The shutter speed and aperture will be set automatically and displayed in the viewfinder.



## 3 Check the shutter speed and aperture display.

- A correct exposure will be obtained as long as the shutter speed and aperture display do not blink.

## 4 Take the picture.

- Compose the shot and press the shutter button completely.



## Shooting Tips

- **Changing the ISO speed and using the built-in flash.**  
To match the subject and ambient lighting level, you can change the ISO speed (p.60) or use the built-in flash (p.62). In the <P> mode, the built-in flash will not fire automatically. So under low light, press the <⚡> (Flash) button to pop up the built-in flash.
- **The program can be shifted. (Program shift)**  
After pressing the shutter button halfway, turn the <☀> dial to change the shutter speed and aperture setting combination (program). After you take the picture, the program shift will be canceled. Program shift is not possible with flash.



In very low light or very bright light, the shutter speed and aperture display will blink when you press the shutter button halfway, as shown in the figure. In low light (**30'' 3.5**), either increase the ISO speed (p.60) or use flash (p.62). In bright light (**4000 22**), decrease the ISO speed.



### Differences Between <P> and <□> (Full Auto)

With <□>, many functions such as the AF mode, drive mode, and metering mode are set automatically to prevent spoiled shots. The functions you can set are limited. With <P>, only the shutter speed and aperture are set automatically. You can freely set the AF mode, drive mode, and other functions (p.198).

# ISO: Changing the ISO Speed ☆

Set the ISO speed (image sensor's sensitivity to light) to suit the ambient light level. In the Basic Zone modes, the ISO speed is set automatically (p.61).

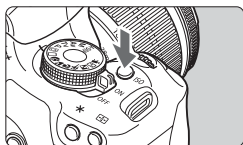

## 1 Press the <ISO> button. (ⓘ6)

▶ [ISO speed] will appear.

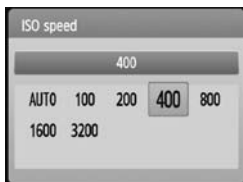

## 2 Select the ISO speed.

- Turn the <☀> dial or press the <◀▶> key to select the ISO speed.
- You can also set the ISO speed in the viewfinder while turning the <☀> dial.
- With "AUTO" selected, the ISO speed will be set automatically (p.61).

## ISO Speed Guide

ISO Speed	Shooting Situation (No flash)	Flash Range
100 - 200	Sunny outdoors	The higher the ISO speed, the farther the flash range will be (p.62).
400 - 800	Overcast skies, evening	
1600 - 6400, H	Dark indoors or night	

- Under the [☿: Custom Functions (C.Fn)] menu, if [Highlight tone priority] is set to [1: Enable], the settable ISO speed range will be ISO 200 - 3200 (p.186).
- Using a high ISO speed or shooting in high-temperature conditions may result in more grainy images. Long exposures can also cause irregular colors in the image.
- When you shoot at high ISO speeds, noise (horizontal banding, light dots, etc.) may appear.

Under the [☿: Custom Functions (C.Fn)] menu, if [ISO expansion] is set to [1: On], ISO 6400 and "H" (ISO 12800) can also be set (p.184).

## About “AUTO” for Automatic ISO Speed

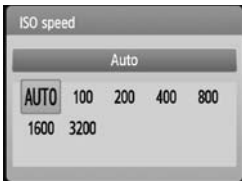

If the ISO speed is set to “**AUTO**”, the actual ISO speed to be set will be displayed when you press the shutter button halfway. As indicated below, the ISO speed will be set automatically to suit the shooting mode.

Shooting Mode	ISO Speed Setting
P/Tv/Av/A-DEP	Automatically set within ISO 100 - 1600
A	Fixed at ISO 100
<b>M</b>	Fixed at ISO 400
With flash	Fixed at ISO 400*

\* If fill flash results in overexposure, ISO 100 or a higher ISO will be set.

\* If an external Speedlite is used for bounce flash, ISO 400 - 1600 will be set automatically.

When “**AUTO**” is set, the ISO speed will be displayed in whole-stop increments of 100, 200, 400, 800, or 1600. However, the actual ISO speed may be set more precisely. Therefore, in the image’s shooting information, you may find an ISO speed like 125 or 640 displayed as the ISO speed.

## ⚡ Using the Built-in Flash

In indoors, low light, or backlit conditions in daylight, just pop up the built-in flash and press the shutter button to take flash pictures. In the <P> mode, the shutter speed (1/60 sec. - 1/200 sec.) will be set automatically to prevent camera shake.

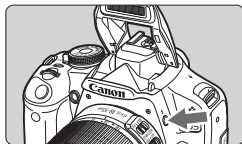

### 1 Press the <⚡> button.

- In Creative Zone modes, you can press the <⚡> button anytime to take flash pictures.
- While the flash is recycling, “⚡buSY” is displayed in the viewfinder, and [BUSY⚡] is displayed on the LCD monitor.



### 2 Press the shutter button halfway.

- In the bottom left of the viewfinder, check that the <⚡> icon is lit.

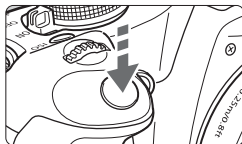

### 3 Take the picture.

- When focus is achieved and you press the shutter button completely, the flash will fire for the picture.

### Effective Flash Range

[Approx. in meters / feet]

ISO Speed	EF-S18-55mm f/3.5-5.6 IS / EF-S18-200mm f/3.5-5.6 IS	
	Wide Angle: 18mm	Telephoto: 55mm
100	1 - 3.5 / 3.5 - 12	1 - 2.5 / 3.5 - 7.5
200	1 - 5.5 / 3.5 - 17	1 - 3.5 / 3.5 - 11
400/AUTO	1 - 7.5 / 3.5 - 24	1 - 4.5 / 3.5 - 15
800	1 - 11 / 3.5 - 34	1 - 6.5 / 3.5 - 22
1600	1 - 15 / 3.5 - 49	1 - 9.5 / 3.5 - 31
3200	1 - 21 / 3.5 - 69	1 - 13 / 3.5 - 43
6400	1 - 30 / 3.5 - 97	1 - 19 / 3.5 - 61
H: 12800	1 - 42 / 3.5 - 138	1 - 26 / 3.5 - 86

## 💡 Shooting Tips

- **If the subject is far away, increase the ISO speed.**  
By increasing the ISO speed, you can extend the flash range.
- **In bright light, decrease the ISO speed.**  
If the exposure setting in the viewfinder blinks, decrease the ISO speed.
- **Detach the lens hood and keep at least 1 meter/3.3 feet away from the subject.**  
If the lens has a hood attached or you are too close to the subject, the bottom of the picture might look dark due to the obstructed flash. For important shots, check the image on the LCD monitor to make sure the flash exposure looks good (not dark at the bottom).

## MENU Using Red-eye Reduction

Using the red-eye reduction lamp before taking a flash picture can reduce red eye.

Red-eye reduction will work in any shooting mode except < 🏠 > < 📷 > < 📷 > < 📷 >.



- Under the [ 📷 ] tab, select [Red-eye On/Off], then press < (SET) >. Select [On], then press < (SET) >.
- For flash photography, when you press the shutter button halfway, the red-eye reduction lamp will light. Then when you press the shutter button completely, the picture will be taken.



- The red-eye reduction feature is most effective when the subject looks at the red-eye reduction lamp, when the room is well lit, or when you go closer to the subject.
- When you press the shutter button halfway, the viewfinder display on the bottom will gradually turn off. For best results, take the picture after this display turns off.
- The effectiveness of red-eye reduction varies depending on the subject.



# AF: Changing the AF Mode ☆

Select the AF mode suiting the shooting conditions or subject. In the Basic Zone modes, the optimum AF mode is set automatically.

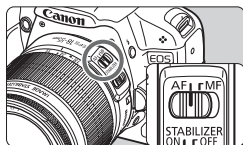

- 1 On the lens, set the focus mode switch to <AF>.

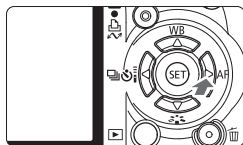

- 2 Press the <▶ AF> button.

▶ [AF mode] will appear.

- 3 Select the AF mode.

- Press the <◀▶> key to select the AF mode, then press <SET>.

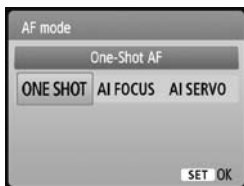

- 4 Focus the subject.

- Aim the AF point over the subject and press the shutter button halfway. The camera will then autofocus in the selected AF mode.

## One-Shot AF for Still Subjects

**Suited for still subjects. When you press the shutter button halfway, the camera will focus only once.**

- When focus is achieved, the dot inside the AF point achieving focus flashes briefly in red, and the focus confirmation light <●> in the viewfinder will also light.
- With evaluative metering (p.83), the exposure setting will be set at the same time focus is achieved.
- While you hold down the shutter button halfway, the focus will be locked. You can then recompose the shot if desired.





- If focus cannot be achieved, the focus confirmation light <●> in the viewfinder will blink. If this occurs, a picture cannot be taken even if the shutter button is pressed completely. Recompose the picture and try to focus again. Or see “When Autofocus Fails” (p.192).
- If the [Beep] menu is set to [Off], the beeper will not sound when focus is achieved.

## AI Servo AF for Moving Subjects

**This AF mode is for moving subjects when the focusing distance keeps changing. While you hold down the shutter button halfway, the subject will be focused continuously.**

- The exposure is set at the moment the picture is taken.
- When the AF point selection (p.66) is automatic, the camera first uses the center AF point to focus. During autofocusing, if the subject moves away from the center AF point, focus tracking continues as long as the subject is covered by another AF point.



With AI Servo AF, the beeper will not sound even when focus is achieved. Also, the focus confirmation light <●> in the viewfinder will not light.

## AI Focus AF for Automatic Switching of AF Mode

**AI Focus AF switches the AF mode from One-Shot AF to AI Servo AF automatically if the still subject starts moving.**

- After the subject is focused in the One-Shot AF mode, if the subject starts moving, the camera will detect the movement and change the AF mode automatically to AI Servo AF.



When focus is achieved in the AI Focus AF mode with the Servo mode active, the beeper will sound softly. However, the focus confirmation light <●> in the viewfinder will not light.

## Selecting the AF Point ☆

In the Basic Zone modes, all the AF points are active. Generally, the AF point covering the closest subject will be selected to focus. Therefore, the camera sometimes may not focus the subject you want.

With the <P> (Program AE), <Tv>, <Av>, and <M> modes, you can select one AF point to focus where you want.

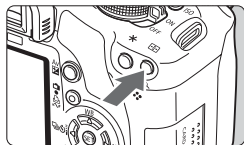

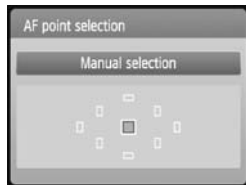

### 1 Press the button. (6)

- ▶ The selected AF point will be displayed on the LCD monitor and in the viewfinder.
- When all AF points light up, automatic AF point selection will be set.



### 2 Select the AF point.

- Press the  key to select the AF point.
- While looking at the viewfinder, you can select the AF point by turning the  dial until the desired AF point flashes in red.
- Pressing  toggles the AF point selection between the center AF point and automatic AF point selection.

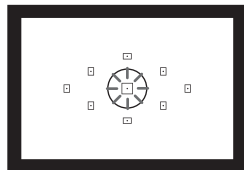

### 3 Focus the subject.

- Aim the selected AF point over the subject and press the shutter button halfway to focus.



## Shooting Tips

- **When shooting a portrait up close, use One-Shot AF and focus the eyes.**  
If you focus the eyes first, you can then recompose and the face will remain sharp.
- **If it is difficult to focus, select and use the center AF point.**  
The center AF point is the most sensitive among the nine AF points. Also, with a fast lens from f/1.0 to f/2.8, high-precision focusing is possible with the center AF point.
- **To make it easier to focus a moving subject, set the camera to automatic AF point selection and AI Servo AF.**  
First use the center AF point to focus. If the subject moves away from the center AF point, the other AF points will continue to focus-track the subject automatically.

## MF: Manual Focusing

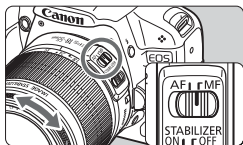

Focusing ring

- 1 **Set the lens focus mode switch to <MF>.**
- 2 **Focus the subject.**
  - Focus by turning the lens focusing ring until the subject looks sharp in the viewfinder.



- If you press the shutter button halfway during manual focusing, the AF point achieving focus flashes in red briefly and the focus confirmation light <●> in the viewfinder will light.
- <AF> stands for Auto Focus. <MF> stands for Manual Focus.

## Continuous Shooting ☆

You can shoot up to about 3.4 shots per sec. This is effective for shooting your child running toward you and capturing the different facial expressions.

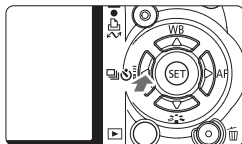

1 Press the <◀   ▶> button.

2 Select < >.

- Press the <◀▶> key to select < >, then press <SET>.

3 Take the picture.

- The camera shoots continuously while you hold down the shutter button fully.

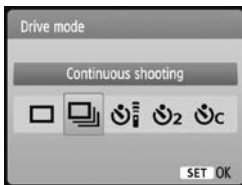

### Shooting Tips

- **Also set the AF mode matching the subject.**

- **For moving subject**

When AI Servo AF is set, focusing will be continuous during continuous shooting.

- **For still subjects**

When One-Shot AF is set, the camera will focus only once during continuous shooting.

- **Flash can also be used.**

Since the flash will require recharging time, the continuous shooting speed will be slower.

- If the [: Custom Functions (C.Fn)] menu's [**High ISO speed noise reduction**] (p.185) is set to [**2: Strong**], the continuous shooting burst will decrease.
- In the AI Servo AF mode, the continuous shooting speed may become slightly slower depending on the subject and the lens used.

## Using the Self-timer

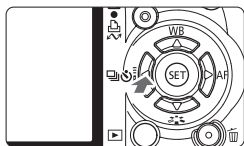

1 Press the **< [Self-timer icon] >** button.

2 Select the self-timer.

- Press the **< [Left/Right] >** key to select the desired self-timer, then press **< [SET] >**.



**[Self-timer icon]: 10-sec. self-timer**

The remote control can also be used. (p.194)

**[2s icon]: 2-sec. self-timer\*** (p.104)

**[10s icon]: 10-sec. self-timer plus continuous shots**

Press the **< [Up/Down] >** key to set the number of multiple shots (2 to 10) to be taken with the self-timer.



3 Take the picture.

- Focus the subject and press the shutter button completely.
- ▶ You can check the self-timer operation with the self-timer lamp, beeper, and countdown display (in seconds) on the LCD monitor.
- ▶ Two seconds before the picture is taken, the self-timer lamp will stay on and the beeper will sound faster.

With **< [10s icon] >**, the interval between the multiple shots may be prolonged depending on the image-recording quality and flash.



- After taking self-timer shots, you should check the image for proper focus and exposure (p.56).
- If you will not look through the viewfinder when you press the shutter button, attach the eyepiece cover (p.195). If stray light enters the viewfinder when you press the shutter button, it may throw off the exposure.
- When using the self-timer to shoot only yourself, use focus lock (p.46) for an object at about the same distance as where you will be.
- To cancel the self-timer after it starts, press the **< [Self-timer icon] >** button.

## MENU Setting the Image-recording Quality

You can select the number of megapixels to record (approx. 15.1, 8.0, or 3.7 megapixels) and the image quality.

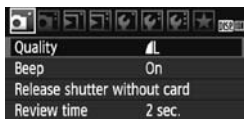

### 1 Select [Quality].

- Under the [Q] tab, select [Quality], then press <SET>.
- [Quality] will appear.

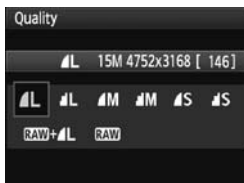

### 2 Select the image-recording quality.

- For your reference, the respective quality's megapixel count (\*\*M), image size in pixels (\*\*\*\*x\*\*\*\*), and the number of possible shots [\*\*\*] will be displayed. Select the desired quality, then press <SET>.

### Guide to Image-recording Quality Settings (Approx.)

Quality		Pixels	File Size (MB)	Possible Shots	Maximum Burst
L	High quality	Approx. 15.1 megapixels (15M)	5.0	370	170
			2.5	740	740
M	Medium quality	Approx. 8.0 megapixels (8M)	3.0	610	610
			1.6	1190	1190
S	Low quality	Approx. 3.7 megapixels (3.7M)	1.7	1080	1080
			0.9	2030	2030
RAW	High quality	Approx. 15.1 megapixels (15M)	20.2	90	9
RAW + L			20.2+5.0	72	4

\* Based on Canon's testing standards with a 2GB card, ISO 100, and Standard Picture Style.

\* The file size, number of possible shots, and maximum burst will vary depending on the subject, card brand, ISO speed, Custom Functions, and other settings.

## FAQ

- I want to select the quality matching the paper size for printing.

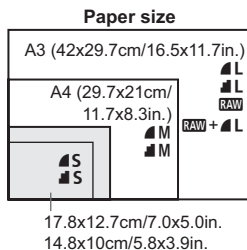

Refer to the diagram on the left when choosing the image-recording quality. If you want to crop the image, selecting a higher quality (more pixels) such as **L**, **L**, **L**, **RAW**, or **RAW + L** is recommended.

- What's the difference between **L** and **L**?**  
 It indicates a different image quality due to a different compression rate. Even with the same number of pixels, the **L** image has higher image quality. If **L** is selected, the image quality will be slightly lower, but more images can be saved to the card.
- I took more shots than the number of possible shots indicated.**  
 Depending on the shooting conditions, you may be able to take more shots than was indicated. Or, it might be fewer than indicated. The possible shots displayed is only an estimate.
- Does the camera display the maximum burst?**  
 The maximum burst is displayed in the viewfinder's right side. Since it is only a single-digit indicator 0 - 9, any number higher than 9 will be displayed only as "9." Note that this number will also be displayed even when no card is installed in the camera. Be careful not to shoot without a card in the camera.
- When do I use the **RAW** mode?**  
**RAW** images require processing with your computer. For details, see "About **RAW**" and "About **RAW + L**" on the next page. Other than **RAW**, the images will be in the JPEG type commonly used in digital cameras.

## About RAW

RAW is the raw image data before it is made into a L or other images. Although RAW images require software like Digital Photo Professional (provided) so they can be displayed on the computer, they also offer flexibility for image adjustments possible only with RAW. RAW is effective when you want to precisely modify the image yourself or shoot an important subject.

## About RAW + L

RAW + L records both a RAW and L image with a single shot. The two images are saved to the card simultaneously. The two images will be saved in the same folder with the same file numbers (file extension .JPG for JPEG and .CR2 for RAW). L images can be viewed or printed even with a computer which does not have the camera's provided software.

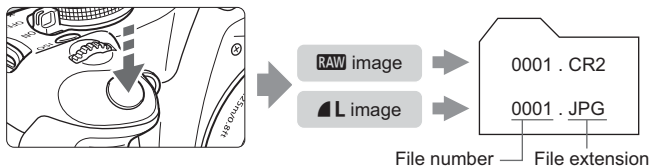

## ! RAW, RAW + L and [C.Fn: Custom Functions (C.Fn)] menu's [High ISO speed noise reduction]

Although the [C.Fn: Custom Functions (C.Fn)] menu's [High ISO speed noise reduction] (p.185) settings (Standard/Low/Strong/Disable) are applied to the recorded images, the images are displayed without noise reduction during image playback (on the LCD monitor and on a TV screen) or direct printing. (Noise may be noticeable in the images.) You can check the noise reduction result or print noise-reduced images with Digital Photo Professional (provided software).

 Commercial software might not be able to display RAW images. Using the provided software is recommended.



## Selecting a Picture Style ☆

By selecting a Picture Style, you can obtain image effects matching your photographic expression or the subject.

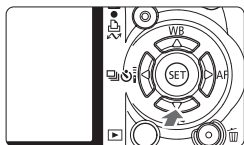

### 1 Press the <▼ > button.

- ▶ [Picture Style] will appear.

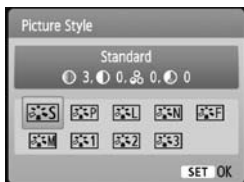

### 2 Select a Picture Style.

- Press the <◀▶> key to select a Picture Style, then press <SET>.

### 3 Take the picture.

- Focus and press the shutter button completely. The picture will be taken with the selected Picture Style applied.

## Picture Style Effects

### **Standard** (CA): Standard)

The image looks vivid, sharp, and crisp. This is a general-purpose Picture Style suitable for most scenes.

### **Portrait** (CA): Smooth skin tones)

For nice skin tones. The image looks softer. Effective for close-ups of women or children. This Picture Style is also selected automatically when the Mode Dial is set to <👤>.

By changing the [Color tone] (p.89), you can adjust the skin tone.

### **Landscape** (CA): Vivid blues and greens)

For vivid blues and greens, and very sharp and crisp images. Effective for impressive landscapes. This Picture Style is also selected automatically when the Mode Dial is set to <🏞️>.

### **Neutral**

This Picture Style is for users who prefer to process images with their computer. For natural colors and subdued images.

### **Faithful**

This Picture Style is for users who prefer to process images with their computer. When the subject is captured under a color temperature of 5200K, the color is adjusted colorimetrically to match the subject's color. The image is dull and subdued.

### **Monochrome** (CA: Monochrome image)

Creates black-and-white images.



Other than with **RAW**, the black-and-white image cannot be reverted to color. If you want to later shoot pictures in color, make sure the **[Monochrome]** setting has been canceled. When **[Monochrome]** is selected, <**B/W**> will appear in the viewfinder.

### **User Def. 1-3**

You can register a basic style such as **[Portrait]**, **[Landscape]**, a Picture Style file, etc., and adjust it as desired (p.88). Any User Defined Picture Style which has not been set will have the same settings as the Standard Picture Style.

# 4

## More Advanced Techniques

This chapter builds on the previous chapter and introduces more ways to shoot creatively.



- The first half of this chapter explains how to use the <Tv> <Av> <M> <A-DEP> modes on the Mode Dial. Except for <A-DEP>, all the shooting modes can be used in combination with the functions introduced in Chapter 3.
- The second half of this chapter, starting with “Changing the Metering Mode” explains the methods to adjust the exposure and the Picture Styles. All the functions introduced in this chapter can also be used with the <P> (Program AE) mode introduced in Chapter 3.

### About the Main Dial Pointer

 1/125

 F8.0

 -2..1..0..1..2

The pointer icon < > displayed together with the shutter speed, aperture setting, or exposure compensation amount indicates that you can turn the < > dial to adjust the respective setting.

## Tv: Action Shots

You can either freeze the action or create motion blur with the **<Tv>** (Shutter-priority AE) mode on the Mode Dial.

\* **<Tv>** stands for Time value.



Frozen action  
(Fast shutter speed)



Blurred motion  
(Slow shutter speed)



### 1 Set the Mode Dial to **<Tv>**.

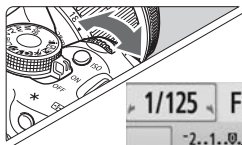

### 2 Set the desired shutter speed.

- See "Shooting Tips" for advice on setting the shutter speed.
- Turning the  dial to the right sets a faster shutter speed, and turning it to the left sets a slower one.



### 3 Take the picture.

- When you focus and press the shutter button completely, the picture will be taken at the selected shutter speed.



#### Shutter Speed Display

The LCD monitor displays the shutter speed as a fraction. However, the viewfinder displays only the denominator. Also, "0"5" indicates 0.5 sec. and "15"" is 15 sec.



## Shooting Tips

- **To freeze the action or moving subject.**

Use a fast shutter speed such as 1/4000 sec. to 1/500 sec.

- **To blur a running child or animal giving the impression of fast movement.**

Use a medium shutter speed such as 1/250 sec. to 1/30 sec. Follow the moving subject through the viewfinder and press the shutter button to take the picture. If you use a telephoto lens, hold it steady to prevent camera shake.

- **How to blur a flowing river or water fountain.**

Use a slow shutter speed of 1/15 sec. or slower. Use a tripod to prevent camera shake.

- **Set the shutter speed so that the aperture display does not blink in the viewfinder.**

If you press the shutter button halfway and change the shutter speed while the aperture is displayed, the aperture display will also change to maintain the same exposure (amount of light reaching the image sensor). If you exceed the adjustable aperture range, the aperture display will blink to indicate that the standard exposure cannot be obtained.

If the exposure will be too dark, the lowest aperture will blink. If this happens, turn the  dial to the left to set a slower shutter speed or increase the ISO speed.

If the exposure will be too bright, the highest aperture will blink. If this happens, turn the  dial to the right to set a faster shutter speed or decrease the ISO speed.



## Using the Built-in Flash

To obtain a correct flash exposure, the flash output will be set automatically (autoflash exposure) to match the automatically-set aperture. The flash sync speed can be set from 1/200 sec. to 30 sec.

# Av: Changing the Depth of Field

To obtain a blurry background or to make everything near and far look sharp, set the Mode Dial to <Av> (Aperture-priority AE) to adjust the depth of field (range of acceptable focus).

\* <Av> stands for Aperture value which is the size of the diaphragm hole inside the lens.



Sharp foreground and background  
(With a small aperture opening)



Blurred background  
(With a large aperture opening)



## 1 Set the Mode Dial to <Av>.

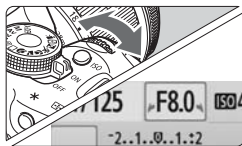

## 2 Set the desired aperture.

- The higher the aperture, the sharper the picture will look with a wider depth of field.
- Turning the <aperture> dial to the right will set a higher f-number, and turning it to the left will set a lower f-number.



## 3 Take the picture.

- Focus and press the shutter button completely. The picture will be taken with the selected aperture.



### Aperture Display

The larger the f/number, the smaller the aperture opening will be. The apertures displayed will differ depending on the lens. If no lens is attached to the camera, "00" will be displayed for the aperture.



## Shooting Tips

- **When using a high aperture, note that camera shake can occur in low light scenes.**

A higher aperture will make the shutter speed slower. Under low light, the shutter speed can be as long as 30 sec. In such cases, increase the ISO speed and hold the camera steady or use a tripod.

- **The depth of field depends not only on the aperture, but also the lens and subject distance.**

Since wide-angle lenses have a wide depth of field (range of acceptable focus in front of and behind the point of focus), you need not set a high aperture to obtain a sharp picture from the foreground to the background. On the other hand, a telephoto lens has a narrow depth of field.

And the closer the subject, the narrower the depth of field. A farther subject will have a wider depth of field.

- **Set the aperture so that the shutter speed display does not blink in the viewfinder.**

If you press the shutter button halfway and change the aperture while the shutter speed is displayed, the shutter speed display will also change to maintain the same exposure (amount of light reaching the image sensor). If you exceed the adjustable shutter speed range, the shutter speed display will blink to indicate that the standard exposure cannot be obtained.

If the picture will be too dark, the “30” (30 sec.) shutter speed display will blink. If this happens, turn the  dial to the left to set a lower aperture or increase the ISO speed.

If the picture will be too bright, the “4000” (1/4000 sec.) shutter speed display will blink. If this happens, turn the  dial to the right to set a higher aperture or decrease the ISO speed.



## Using the Built-in Flash

To obtain a correct flash exposure, the flash output will be set automatically to match the set aperture (autoflash exposure). The shutter speed will be set automatically between 1/200 sec. - 30 sec. to suit the scene's brightness.

In low light, the main subject is exposed with the automatic flash, and the background is exposed with a slow shutter speed set automatically. Both the subject and background look properly exposed (automatic slow-speed flash sync). If you are handholding the camera, keep it steady to prevent camera shake. Using a tripod is recommended.

If you do not want a slow shutter speed to be used, set the [**4**: Custom Functions (C.Fn)] menu's [**Flash sync. speed in Av mode**] to [**1: 1/200-1/60 sec. auto**] or [**2: 1/200 sec. (fixed)**] (p.184).

## Depth of Field Preview ☆

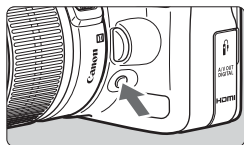

Press the depth-of-field preview button to stop down to the lens's current aperture setting. You can check the depth of field (range of acceptable focus) through the viewfinder.

 The depth-of-field effect can be clearly seen on the Live View image as you change the aperture and press the depth-of-field preview button (p.106).



# M: Manual Exposure

You can set both the shutter speed and aperture as desired. With flash, the flash exposure will be set automatically to match the aperture that was set. The flash sync speed can be set within 1/200 sec. to 1/30 sec. or to bulb.



\* <M> stands for Manual.

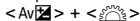
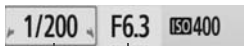

## 1 Set the Mode Dial to <M>.



## 2 Set the shutter speed and aperture.

- To set the shutter speed, turn the <  > dial.
- To set the aperture, hold down the < Av  > button and turn the <  > dial.

Standard exposure index



Exposure level mark

## 3 Set the exposure and take the picture.

- The exposure level indicator in the viewfinder indicates the exposure level up to  $\pm 2$  stops from the standard exposure index at the center. While you change the shutter speed and aperture, the exposure level mark will move. You can decide which exposure level to set.

## Bulb Exposures

In step 2, turn the <  > dial to the left to set <BULB>. A bulb exposure keeps the shutter open for as long as you hold down the shutter button. It can be used to photograph fireworks, etc. The elapsed exposure time will be displayed on the LCD monitor.

For bulb exposures, using a tripod and Remote Switch (p.194) is recommended.



- Since bulb exposures produce more noise than usual, the image might look rough or grainy. You can reduce this noise by setting the [: Custom Functions (C.Fn)] menu's [Long exp. noise reduction] to [1: Auto] or [2: On] (p.185).
- The Auto Lighting Optimizer (p.186) will not work.

# A-DEP: Automatic Depth-of-Field AE

Objects in the foreground and background will be in focus automatically. All the AF points will function to detect the subject, and the aperture required to attain the necessary depth of field will be set automatically.

\* <A-DEP> stands for Auto-Depth of field. This mode sets the depth of field automatically.



## 1 Set the Mode Dial to <A-DEP>.



## 2 Focus the subject.

- Aim the AF points over the subjects and press the shutter button halfway. (4)
- All the subjects covered by the AF points flashing in red will be in focus.

## 3 Take the picture.

### ? FAQ

#### ● The aperture display in the viewfinder blinks.

The exposure is correct, but the desired depth of field cannot be obtained. Either use a wide-angle lens or move farther away from the subjects.

#### ● The shutter speed display in the viewfinder blinks.

If the "30" shutter speed blinks, it means that the subject is too dark. Increase the ISO speed. If the "4000" shutter speed blinks, it means that the subject is too bright. Decrease the ISO speed.

#### ● A slow shutter speed has been set.

Use a tripod.



#### ● I want to use flash.

Flash can be used, however, the result will be the same as using the <P> mode with flash. The desired depth of field will not be obtained.

## Changing the Metering Mode <sup>☆</sup>



The metering mode determines the exposure. Different metering modes measure the subject brightness differently. Normally, evaluative metering is recommended.

### 1 Select the [Metering mode].

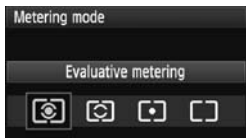
- Under the [] tab, select [Metering mode], then press <>.



### 2 Set the metering mode.

- Press the < <img alt="Right arrow" data-bbox="435 295 465 325"/> > key to select the metering mode, then press <>.

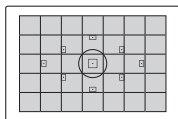

#### Evaluative metering

This is an all-around metering mode suited for portraits and even backlit subjects. The camera sets the exposure automatically to suit the scene. This metering mode is set automatically in the Basic Zone modes.

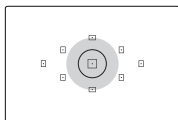

#### Partial metering

Effective when the background is much brighter than the subject due to backlighting, etc. The gray area in the figure is where the metering is weighted to obtain the standard exposure.

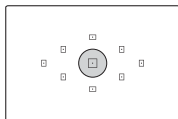

#### Spot metering

This is for metering a specific part of the subject or scene. The gray area in the left figure is where the metering is weighted to obtain the standard exposure. This metering mode is for advanced users.

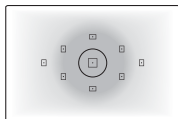

#### Center-weighted average metering

The metering is weighted at the center and then averaged for the entire scene. This metering mode is for advanced users.

# Setting Exposure Compensation ☆

Exposure compensation is used to alter the standard exposure set by the camera. You can make the image look brighter (increased exposure) or darker (decreased exposure). **The exposure compensation setting will not be automatically canceled when you turn off the camera. After taking the picture, reset the exposure compensation to zero.**

## Av Setting Exposure Compensation

Set exposure compensation if the exposure (without flash) does not come out as desired. This feature can be used in the Creative Zone modes (except <M>).

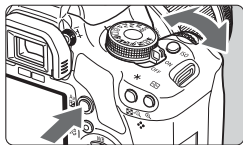



Increased exposure for a brighter image





Decreased exposure for a darker image





### Making it brighter

Hold down the <Av  > button and turn the < > dial to the right.  
(Increased exposure)

### Making it darker

Hold down the <Av  > button and turn the < > dial to the left.  
(Decreased exposure)

- ▶ As shown in the figure, the exposure level is displayed on the LCD monitor and in the viewfinder.
- After taking the picture, hold down the <Av  > button and turn the < > dial to reset the exposure compensation to zero.



Exposure is dark



Increased exposure for a brighter image

## Flash Exposure Compensation ☆

Set flash exposure compensation if the flash exposure of the subject does not come out as desired.

### 1 Select [Flash control].

- Under the [] tab, select [Flash control], then press < >.

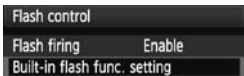

### 2 Select [Built-in flash func. setting].

- Select [Built-in flash func. setting], then press < >.

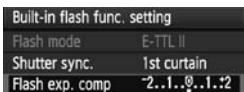



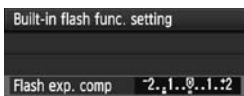

### 3 Select [Flash exp. comp].



- Select [Flash exp. comp], then press < >.





### 4 Set the flash exposure compensation amount.

- To make the flash exposure brighter, press the < > key. (Increased exposure)  
Or to make it darker, press the < > key. (Decreased exposure)
- After setting the flash exposure compensation amount, press < >.
- ▶ When you press the shutter button halfway, the < > icon and flash exposure compensation amount will be displayed on the LCD monitor and the < > icon will appear in the viewfinder.
- After taking the picture, do steps 1 to 4 to return the flash exposure compensation amount to zero.



 If the [: Custom Functions (C.Fn)] menu's [Auto Lighting Optimizer] (p.186) is set to a setting other than [3: Disable], the image may look bright even if a decreased exposure compensation or flash exposure compensation has been set.

-  ● The flash exposure compensation amount can also be set or canceled with the Quick Control screen (p.102).
- The exposure compensation can also be set with [: Expo. comp./AEB] menu (p.86).

## MENU Auto Exposure Bracketing ☆

This feature takes exposure compensation a step further by varying the exposure automatically with three shots as shown below. You can then choose the best exposure. This is called AEB (Auto Exposure Bracketing).



Standard exposure



Darker exposure  
(Decreased exposure)



Brighter exposure  
(Increased exposure)



### 1 Select [Expo. comp./AEB].

- Under the [AEB] tab, select [Expo. comp./AEB], then press <SET>.

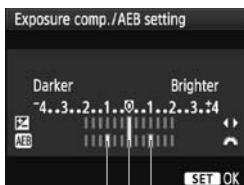

### 2 Set the AEB amount.

- Turn the <DIAL> dial to set the AEB amount.
- Press the <LEFT/RIGHT> key to set the exposure compensation amount. If AEB is combined with exposure compensation, AEB will be applied centering on the exposure compensation amount.
- Press <SET> to set it.
- When you press the shutter button halfway, the AEB amount will be displayed on the LCD monitor.

AEB amount



### 3 Take the picture.

- Focus and press the shutter button completely. The three bracketed shots will be taken in this sequence: Standard, decreased exposure, and increased exposure.

## Canceling AEB

- Follow steps 1 and 2 to turn off the AEB amount display.
- The AEB setting will be canceled automatically if the power switch is set to <OFF>, flash recycling is complete, etc.



## Shooting Tips

- **Using AEB with continuous shooting.**  
If <[ ]> continuous shooting (p.68) has been set and you press the shutter button completely, the three bracketed shots will be taken continuously in this sequence: Standard, decreased exposure, and increased exposure.
- **Using AEB with <[ ]> single shooting.**  
Press the shutter button three times to take the three bracketed shots. The three bracketed shots will be exposed in the following sequence: Standard, decreased exposure, and increased exposure.
- **Using AEB with exposure compensation.**  
Centering on the exposure compensation amount, AEB will be applied.
- **Using AEB with the self-timer or wireless remote control.**  
With the self-timer or wireless remote control (<[ ]> or <[ ]>), you can take three continuous shots. With <[ ]> set, the number of continuous shots will be three times the number set (p.55).



- Neither flash nor bulb exposures can be used with AEB.
- If the [ ]: Custom Functions (C.Fn)] menu's [Auto Lighting Optimizer] (p.186) is set to other than [3: Disable], the AEB may not be so effective.

# Customizing a Picture Style ☆

You can customize a Picture Style by adjusting individual parameters like **[Sharpness]** and **[Contrast]**. To see the resulting effects, take test shots. To customize **[Monochrome]**, see page 90.



## 1 Select [Picture Style].

- Under the **[P]** tab, select **[Picture Style]**, then press **<SET>**.
- ▶ The Picture Style selection screen will appear.



## 2 Select a Picture Style.

- Select a Picture Style, then press the **<DISP.>** button.
- ▶ The Detail set. screen will appear.



## 3 Select a parameter.

- Select a parameter such as **[Sharpness]**, then press **<SET>**.



## 4 Set the parameter.

- Press the **<◀▶>** key to adjust the parameter as desired, then press **<SET>**.
- Press the **<MENU>** button to save the adjusted parameter. The Picture Style selection screen will reappear.
- ▶ Any parameter settings different from the default will be displayed in blue.





## Parameter Settings and Effects

### Sharpness

**Adjusts the sharpness of the image.**

To make it less sharp, set it toward the **0** end. The closer it is to **0**, the softer the image will look.

To make it sharper, set it toward the **7** end. The closer it is to **7**, the sharper the image will look.

### Contrast

**Adjusts the image contrast and the vividness of colors.**

To decrease the contrast, set it toward the minus end. The closer it is to **-**, the blander the image will look.

To increase the contrast, set it toward the plus end. The closer it is to **+**, the crisper the image will look.

### Saturation

**The image's color saturation can be adjusted.**

To decrease the color saturation, set it toward the minus end.

The closer it is to **-**, the lighter the colors will look.

To increase the color saturation, set it toward the plus end. The closer it is to **+**, the deeper the colors will look.

### Color tone

**The skin tones can be adjusted.**

To make the skin tone redder, set it toward the minus end. The closer it is to **-**, the redder the skin tone will look.

To make the skin tone less red, set it toward the plus end. The closer it is to **+**, the more yellow the skin tone will look.



- By selecting [**Default set.**] in step 3, you can revert the respective Picture Style to its default parameter settings.
- The above adjustments will not be applied to the Picture Styles used in the <CA> (Creative Auto) mode.

## Monochrome Adjustment

For Monochrome, you can also set **[Filter effect]** and **[Toning effect]** in addition to **[Sharpness]** and **[Contrast]** explained on the preceding page.

### Filter Effect



With a filter effect applied to a monochrome image, you can make white clouds or green trees stand out more.

Filter	Sample Effects
N: None	Normal black-and-white image with no filter effects.
Ye: Yellow	The blue sky will look more natural, and the white clouds will look crisper.
Or: Orange	The blue sky will look slightly darker. The sunset will look more brilliant.
R: Red	The blue sky will look quite dark. Fall leaves will look crisper and brighter.
G: Green	Skin tones and lips will look fine. Tree leaves will look crisper and brighter.

Increasing the **[Contrast]** will make the filter effect more pronounced.

### Toning Effect

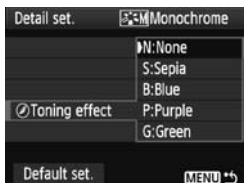

By applying a toning effect, you can create a monochrome image in that color. It can make the image look more impressive.

The following can be selected: **[N:None]** **[S:Sepia]** **[B:Blue]** **[P:Purple]** **[G:Green]**.

## ✱ Registering a Picture Style ☆

You can select a base Picture Style such as [Portrait] or [Landscape], adjust its parameters as desired and register it under [User Def. 1], [User Def. 2], or [User Def. 3].

You can create Picture Styles whose parameter settings such as for sharpness and contrast are different. You can also adjust the parameters of a Picture Style which has been registered to the camera with the provided software.

### 1 Select [Picture Style].

- Under the [P] tab, select [Picture Style], then press <SET>.
- ▶ The Picture Style selection screen will appear.



### 2 Select [User Def.].

- Select [User Def. \*], then press the <DISP.> button.
- ▶ The Detail set. screen will appear.

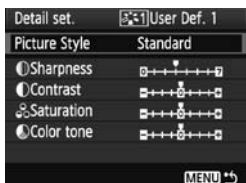

### 3 Press <SET>.

- With [Picture Style] selected, press <SET>.



### 4 Select the base Picture Style.

- Press the <▲▼> key to select the base Picture Style, then press <SET>.
- To adjust the parameters of a Picture Style which has been registered to the camera with the provided software, select the Picture Style here.

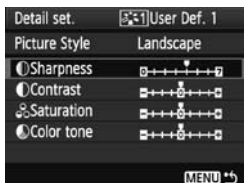

## 5 Select a parameter.

- Select a parameter such as **[Sharpness]**, then press **<SET>**.

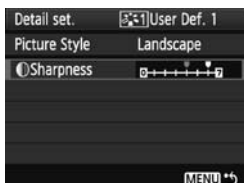

## 6 Set the parameter.

- Press the **<◀▶>** key to adjust the parameter as desired, then press **<SET>**.

For details, see “Customizing a Picture Style” on pages 88-90.



- Press the **<MENU>** button to register the new Picture Style. The Picture Style selection screen will then reappear.
  - ▶ The base Picture Style will be indicated on the right of **[User Def. \*]**.
  - ▶ The name of the Picture Style having any modified settings (different from the default) registered under **[User Def. \*]** will be displayed in blue.

⚠ If a Picture Style has already been registered under **[User Def. \*]**, changing the base Picture Style in step 4 will nullify the parameter settings of the registered Picture Style.

📷 To shoot with the registered Picture Style, follow step 2 on page 73 to select **[User Def. \*]** and then shoot.

## MENU Setting the Color Space ☆

The color space refers to the range of reproducible colors. With this camera, you can set the color space for captured images to sRGB or Adobe RGB. For normal shooting, sRGB is recommended. In the Basic Zone modes, sRGB is set automatically.

### 1 Select [Color space].

- Under the [M:] tab, select [Color space], then press <SET>.

### 2 Set the desired color space.

- Select [sRGB] or [Adobe RGB], then press <SET>.



### About Adobe RGB

This color space is mainly used for commercial printing and other industrial uses. This setting is not recommended if you do not know about image processing, Adobe RGB, and Design rule for Camera File System 2.0 (Exif 2.21).

Since the image will look very subdued with an sRGB computer environment and printers not compatible with Design rule for Camera File System 2.0 (Exif 2.21), post-processing of the image with software will be required.



- If the image is captured with the color space set to Adobe RGB, the file name will start with “\_MG\_” (first character is an underscore).
- The ICC profile is not appended. The ICC profile is explained in the Software Instruction Manual in the CD-ROM.

# \* AE Lock ☆

Use AE lock when the area of focus is to be different from the exposure metering area or when you want to take multiple shots at the same exposure setting. Press the < \* > button to lock the exposure, then recompose and take the shot. This is called AE lock. It is effective for backlit subjects.

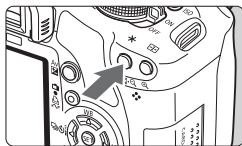

## 1 Focus the subject.

- Press the shutter button halfway.
- ▶ The exposure setting will be displayed.

## 2 Press the < \* > button. (⊙4)

- ▶ The < \* > icon lights in the viewfinder to indicate that the exposure setting is locked (AE lock).
- Each time you press the < \* > button, it locks the current auto exposure setting.



## 3 Recompose and take the picture.

- If you want to maintain the AE lock while taking more shots, hold down the < \* > button and press the shutter button to take another shot.

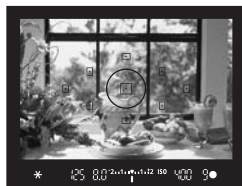

## AE Lock Effects

Metering Mode (p.83)	AF Point Selection Method (p.66)	
	Automatic Selection	Manual Selection
*	AE lock is applied at the AF point that achieved focus.	AE lock is applied at the selected AF point.
	AE lock is applied at the center AF point.	

\* When the lens' focus mode switch is set to < MF >, AE lock is applied at the center AF point.

## ✳ FE Lock ☆

FE lock locks the flash exposure setting over the desired area of the subject. This feature can also be used with a Canon EX-series Speedlite.

\* FE stands for Flash Exposure.

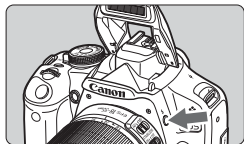

### 1 Press the <⚡> button to pop up the built-in flash.

- Press the shutter button halfway and look in the viewfinder to check that the <⚡> icon is lit.



### 2 Focus the subject.

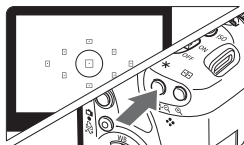

### 3 Press the <✳> button. (Ⓜ16)

- Aim the viewfinder center over the subject where you want to lock the flash exposure, then press the <✳> button.
- ▶ The flash will fire a preflash and the required flash output is calculated and retained in memory.
- ▶ In the viewfinder, "FEL" is displayed for a moment and <⚡\*> will light.
- Each time you press the <✳> button, a preflash is fired and the required flash output is calculated and retained in memory.



### 4 Take the picture.

- Compose the shot and press the shutter button completely.
- ▶ The flash is fired to take the picture.



⚠ If the subject is too far away and beyond the effective range of the flash, the <⚡> icon will blink. Get closer to the subject and repeat steps 2 to 4.

# WB: Setting the White Balance ☆

White balance (WB) is for making the white areas look white. Normally, the <AWB> (Auto) setting will obtain the correct white balance. If natural-looking colors cannot be obtained with <AWB>, you can select the white balance settings for different sources or set it manually by shooting a white object. In the Basic Zone modes, <AWB> will be set automatically.

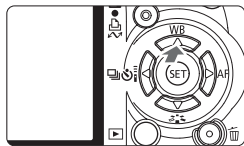

## 1 Press the <▲ WB> button.

▶ [White balance] will appear.

## 2 Select the white balance.

- Press the <◀▶> key to select the desired white balance, then press <SET>.
- The "Approx. \*\*\*\*K" (K: Kelvin) displayed for the selected white balance <☀> <🏠> <☁> <🌞> <🌧> is the respective color temperature.



## 📷 Custom White Balance

Custom white balance enables you to manually set the white balance for a specific light source for better accuracy. Do this procedure under the actual light source to be used.

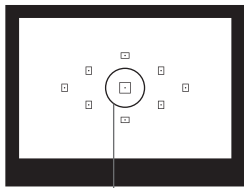

Spot metering circle

## 1 Photograph a white object.

- The plain, white object should fill the spot metering circle.
- Focus manually and set the standard exposure for the white object.
- You can set any white balance.





## 2 Select [Custom WB].

- Under the [WB] tab, select [Custom WB], then press <SET>.
- ▶ The custom white balance selection screen will appear.

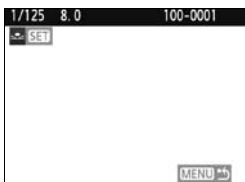

## 3 Import the white balance data.

- Select the image that was captured in step 1, then press <SET>.
- ▶ On the dialog screen which appears, select [OK] and the data will be imported.
- When the menu reappears, press the <MENU> button to exit the menu.

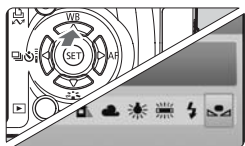

## 4 Select the custom white balance.

- Press the <▲ WB> button.
- Press the <◀▶> key to select <WB>, then press <SET>.



- If the exposure obtained in step 1 is way off, a correct white balance might not be obtained.
- If the image was captured while the Picture Style was set to [Monochrome] (p.74), it cannot be selected in step 3.



- Instead of a white object, an 18% gray card (commercially available) can produce a more accurate white balance.
- The personal white balance registered with the provided software will be registered under <WB>. If you do step 3, the data for the registered personal white balance will be erased.

# WB $\pm$ White Balance Correction $\star$

You can correct the white balance that has been set. This adjustment will have the same effect as using a commercially-available color temperature conversion filter or color compensating filter. Each color can be corrected to one of nine levels.

This is for advanced users who are familiar with using color temperature conversion or color compensating filters.

## White Balance Correction



### 1 Select [WB SHIFT/BKT].

- Under the [WB] tab, select [WB SHIFT/BKT], then press <SET>.
- The WB correction/WB bracketing screen will appear.

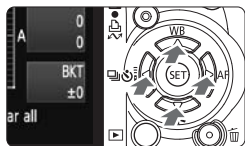

### 2 Set the white balance correction.

- Press the <4-way> key to move the "■" mark to the desired position.
- B is for blue, A is amber, M is magenta, and G is green. The color in the respective direction will be corrected.
- On the upper right, "SHIFT" indicates the direction and correction amount.
- Pressing the <DISP.> button will cancel all the [WB SHIFT/BKT] settings.
- Press <SET> to exit the setting and return to the menu.

Sample setting: A2, G1

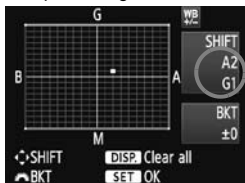

- During the white balance correction, <WB  $\pm$ > will be displayed in the viewfinder and on the LCD monitor.
- One level of the blue/amber correction is equivalent to 5 mireds of a color temperature conversion filter. (Mired: Measuring unit indicating the density of a color temperature conversion filter.)

## White Balance Auto Bracketing

With just one shot, three images having a different color tone can be recorded simultaneously. Based on the color temperature of the current white balance setting, the image will be bracketed with a blue/amber bias or magenta/green bias. This is called white balance bracketing (WB-BKT). White balance bracketing is possible up to  $\pm 3$  levels in single-level increments.

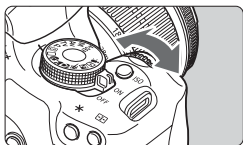

B/A bias  $\pm 3$  levels

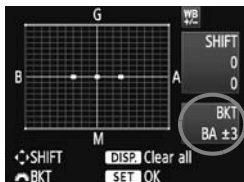

### Set the white balance bracketing amount.

- In step 2 for white balance correction, when you turn the <gear> dial, the "■" mark on the screen will change to "■■■" (3 points). Turning the dial to the right sets the B/A bracketing, and turning it to the left sets the M/G bracketing.
- ▶ On the right side of the screen, "BKT" indicates the bracketing direction and the bracketing amount.
- Pressing the <DISP.> button will cancel all the [WB SHIFT/BKT] settings.
- Press <SET> to exit the setting and return to the menu.

### Bracketing Sequence

The images will be bracketed in the following sequence: 1. Standard white balance, 2. Blue (B) bias, 3. Amber (A) bias, or 1. Standard white balance, 2. Magenta (M) bias, 3. Green (G) bias.

ⓘ During WB bracketing, the maximum burst for continuous shooting will be lower and the number of possible shots will also decrease to one-third the normal number.

- ⓘ ● Since three images are recorded for one shot, the card will take longer to record the shot.
- "BKT" stands for Bracketing.

## MENU Lens Peripheral Illumination Correction

Due to the lens characteristics, the four corners of the picture might look darker. This is called lens light fall-off or drop in peripheral illumination. This can be corrected. For JPEG images, lens light fall-off is corrected when the image is captured. For RAW images, it can be corrected with Digital Photo Professional (provided software).

The default setting is **[Enable]**.

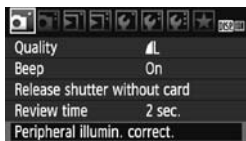

### 1 Select **[Peripheral illumin. correct.]**.

- Under the [] tab, select **[Peripheral illumin. correct.]**, then press <SET>.

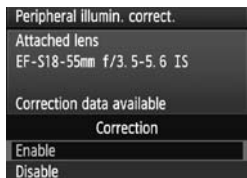

### 2 Set the correction setting.

- On the screen, check that the attached lens' **[Correction data available]** is displayed.
- If **[Correction data not available]** is displayed, see "About the Lens Correction Data" on the next page.
- Press the <▲▼> key to select **[Enable]**, then press <SET>.

### 3 Take the picture.

- The image will be recorded with the corrected peripheral illumination.



Correction enabled



Correction disabled

## About the Lens Correction Data

The camera already contains lens peripheral illumination correction data for about 25 lenses. In step 2, if you select **[Enable]**, the peripheral light correction will be applied automatically for any lens whose correction data has been registered in the camera.

With the EOS Utility (provided software), you can check which lenses have their correction data registered in the camera. You can also register the correction data for unregistered lenses. For details, see the Software Instruction Manual (CD-ROM) for EOS Utility.



- Lens peripheral light correction cannot be applied to JPEG images already captured.
- Depending on shooting conditions, noise might appear on the image periphery.
- When using a third-party lens, setting the correction to **[Disable]** is recommended, even if **[Correction data available]** is displayed.





- Lens peripheral light correction is applied even when an Extender is attached.
- If the correction data for the attached lens has not been registered to the camera, the result will be the same as when the correction is set to **[Disable]**.
- The correction amount applied will be slightly lower than the maximum correction amount settable with Digital Photo Professional (provided software).
- If the lens does not have distance information, the correction amount will be lower.
- The higher the ISO speed, the lower the correction amount will be.

## Using the Quick Control Screen

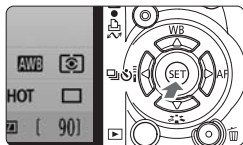
The shooting settings are displayed on the LCD monitor where you can directly select and set the functions. This is called the Quick Control screen.



### 1 Display the Quick Control screen.

- When the shooting settings are displayed, press <  >.
- ▶ The Quick Control screen will appear (10).





Basic Zone modes





Creative Zone modes

### 2 Set the desired setting.

- Press the <  > key to select a function.
- In the Basic Zone modes, you can select certain drive modes (p.68) and the image-recording quality (p.70).
- ▶ A brief description of the selected function is displayed on the screen's bottom.
- Turn the <  > dial to change the setting.

### 3 Take the picture.

- Press the shutter button completely to take the picture.

 If the setting of the [ **Custom Functions (C.Fn)**] menu's [**Assign SET button**] (p.188) is set to other than [**0: Quick Control screen**], the Quick Control screen cannot be displayed in the Creative Zone modes.

## Quick Control Screen Nomenclature

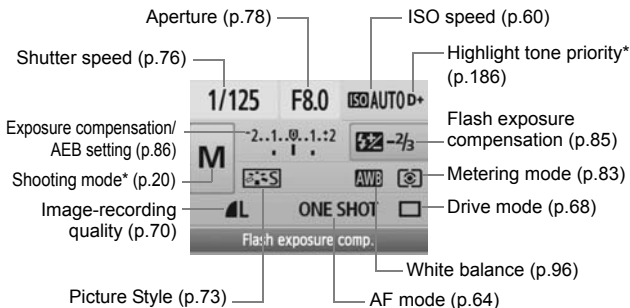

Asterisked functions cannot be set with the Quick Control screen.

## Function Setting Display

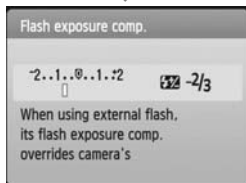

- On the Quick Control screen, select the function and press  $\langle \text{SET} \rangle$ . The respective setting screen will then appear (except for the shutter speed and aperture).
- Turn the  $\langle \text{DIAL} \rangle$  dial to change the setting. You can also press the  $\langle \text{LEFT/RIGHT} \rangle$  key to change the setting.
- Press  $\langle \text{SET} \rangle$  to finalize the setting and return to the Quick Control screen.

# Preventing Camera Shake <sup>☆</sup>

The camera's mechanical shake caused by the reflex mirror action can affect images taken with a super telephoto lens or close-up (macro) lens. In such cases, mirror lockup is effective.

**Mirror lockup is enabled by selecting the [Fn: Custom Functions (C.Fn)] menu's [Mirror lockup] and setting it to [1: Enable] (p.187).**

## 1 Focus the subject, press the shutter button completely and release it.

- ▶ The mirror will swing up.

## 2 Press the shutter button completely again.

- ▶ The picture is taken and the mirror goes back down.



### Shooting Tips

#### ● Using the self-timer <S><sub>2</sub> with mirror lockup.

When you press the shutter button completely, the mirror locks up, then the picture is taken 2 sec. later.

#### ● Remote control shooting.

Since you do not touch the camera when the picture is taken, remote control shooting together with mirror lockup can further prevent camera shake. With Remote Controller RC-5, pressing the transmit button locks up the mirror before the shot is taken 2 sec. later. With Remote Controller RC-1, set it to 2-sec. delay, then shoot.



- Do not point the camera toward the sun. The sun's heat can scorch and damage the shutter curtains.
- If you use bulb exposures, the self-timer, and mirror lockup in combination, keep pressing the shutter button completely (self-timer delay time + bulb exposure time). If you let go of the shutter button during the self-timer countdown, there will be a shutter-release sound. However, this is not the actual shutter release (no picture is taken).



- Even if <C> (Continuous shooting) has been set, single shooting will still take effect.
- The mirror locks up, and after 30 seconds, it will go back down automatically. Pressing the shutter button completely again locks up the mirror again.



# 5

## Live View Shooting

You can shoot while viewing the picture on the camera's LCD monitor. This is called "Live View shooting."

**Live View shooting is effective for still subjects which do not move.**

**If you handhold the camera and shoot while viewing the LCD monitor, camera shake can cause blurred images. Using a tripod is recommended.**



### About Remote Live View Shooting

With EOS Utility (provided software) installed in your computer, you can connect the camera to the computer and shoot remotely while viewing the computer screen. For details, see the Software Instruction Manual in the CD-ROM.

# Live View Shooting <sup>☆</sup>

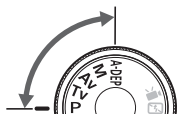

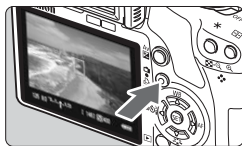

## 1 Set the shooting mode.

- Set the shooting mode to a Creative Zone mode.
- **Live View shooting cannot be used in Basic Zone modes.**



## 2 Display the Live View image.

- Press the  button.
- ▶ The Live View image will appear on the LCD monitor.
- The Live View image will closely reflect the brightness level of the actual image you capture.
- If the standard exposure has not been obtained, turn the  dial.
- The image's field of view is about 100%.



## 3 Focus the subject.

- Before shooting, focus with AF or manual focus (p.111-118).
- Press the  button to focus in the current AF mode.

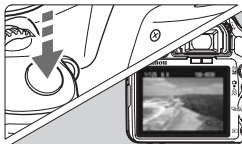

## 4 Take the picture.

- Press the shutter button completely.
- ▶ The picture will be taken and the captured image is displayed on the LCD monitor.
- ▶ After the image review ends, the camera will return to Live View shooting automatically.
- Press the  button to end the Live View shooting.

## To Enable Live View Shooting

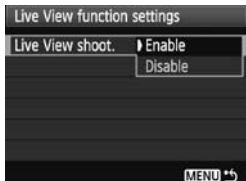

Under [: **Live View function settings**], set [**Live View shoot.**] to [**Enable**].

## Battery Life with Live View Shooting [Approx. number of shots]

Temperature	Shooting Conditions	
	No Flash	50% Flash Use
At 23°C / 73°F	190	170
At 0°C / 32°F	180	160

- The figures above are based on a fully-charged Battery Pack LP-E5 and CIPA (Camera & Imaging Products Association) testing standards.
- Continuous Live View shooting is possible for about 1 hour at 23°C/73°F (with a fully-charged Battery Pack LP-E5).



- During Live View shooting, do not point the lens toward the sun. The sun's heat can damage the camera's internal components.
- **Cautions for using Live View shooting are on pages 119-120.**



In the following cases, the shutter will sound like it took two shots, but only one shot will be taken. During continuous shooting, only the first shot will make two shutter sounds.

- Flash shots.
- ISO 3200 or higher is set.

# Setting Shooting Functions <sup>☆</sup>

Function settings particular to Live View shooting are explained here.

## Functions Set with a Menu

Live View function settings	
Live View shoot.	Enable
Grid display	Off
Metering timer	4 sec.
AF mode	Live mode

MENU 

Under the [] tab, the [**Live View function settings**] menu options, [**Grid display**], [**Metering timer**], and [**AF mode**] are as described below.

- **Grid display**

With [**Grid 1** ] or [**Grid 2** ], you can display grid lines.

- **Metering timer**

You can change the display time of the exposure setting.

- **AF mode**

You can select [**Live mode**] (p.111), [ **Live mode**] (p.112), or [**Quick mode**] (p.116).

## Settable Functions when the Camera is ready to shoot



While the Live View image is displayed on the LCD monitor, press  so that the AF mode, Picture Style, white balance, drive mode, and image-recording quality can be set.











### 1 Press .

- ▶ The current settable function will be highlighted in blue.
- When  is selected, the AF points will also be displayed.

## 2 Select the function and set it.

- Press the <  > key to select the function to be set.
- ▶ The name of the selected function is displayed at the bottom.
- Turn the <  > dial to change the setting.



- Even while the Live View image is displayed, you can still set <MENU> functions and execute playback <  >. If you select [: **Dust Delete Data**], [: **Sensor cleaning**], [: **Clear settings**], or [: **Firmware Ver.**], the Live View shooting will be terminated.
- The metering mode will be fixed to evaluative metering for Live View shooting.
- Under the [: **Custom Functions (C.Fn)**] menu, if [**Shutter/AE lock button**] (p.188) is set to [**1: AE lock/AF**], you can use AE lock by pressing the shutter button halfway.
- To check the depth of field, press the depth-of-field preview button.
- During continuous shooting, the exposure set for the first shot will also be applied to subsequent shots.
- Using < **A-DEP** > will be the same as using < **P** >.
- If the camera is not operated for a prolonged period, the power will turn off automatically as set with [: **Auto power off**] (p.131). If [: **Auto power off**] is set to [**Off**], the Live View shooting will stop automatically after 30 min. (camera power remains on).
- With the AV cable (provided) or HDMI cable (sold separately), you can display the Live View image on a TV (p.156-157).
- You can also use a remote controller (sold separately, p.194) for Live View shooting.

## About the Information Display

- Each time you press the <DISP.> button, the information display will change.

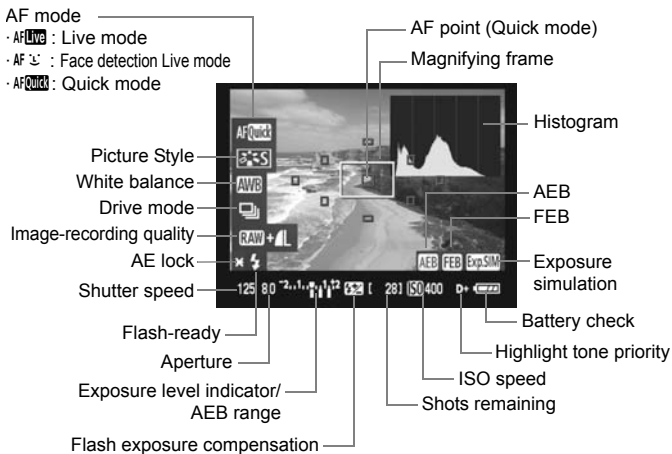

- When <Exp.SIM> is displayed in white, it indicates that the Live View image brightness is close to what the captured image will look like.
- If <Exp.SIM> is blinking, it indicates that the Live View image is not being displayed at the suitable brightness due to low or bright light conditions. However, the captured image will reflect the exposure setting.
- If flash is used or bulb is set, the <Exp.SIM> icon and histogram will be grayed out (for your reference). The histogram might not be properly displayed in low or bright light conditions.

# Using AF to Focus ☆

## Selecting the AF Mode

The AF modes available are [**Live mode**], [**Live mode**] (face detection, p.112), and [**Quick mode**] (p.116).

If you want to achieve precise focusing, set the lens focus mode switch to <MF>, magnify the image, and focus manually (p.118).

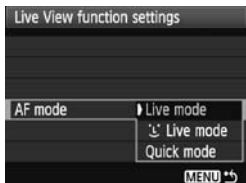

## Select the AF mode.

- Under [**Live View function settings**], select [**AF mode**].
- While the Live View image is displayed, you can press <SET> to select the AF mode on the Quick Control screen.

## Live Mode: AF Live

The image sensor is used to focus. Although AF is possible with the Live View image displayed, **the AF operation will take longer than with the Quick mode**. Also, achieving focus may be more difficult than with the Quick mode.



## 1 Display the Live View image.

- Press the <CAMERA> button.
- ▶ The Live View image will appear on the LCD monitor.
- ▶ The AF point <□> will appear.

## 2 Move the AF point.

- You can press the <AF-ON> key to move the AF point to where you want to focus (it cannot go to the edges of the picture).
- To return the AF point to the center, press the <AF-ON> button.

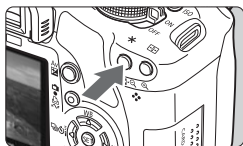

### 3 Focus the subject.

- Aim the AF point over the subject, and hold down the < \* > button.
- ▶ When focus is achieved, the AF point will turn green and the beeper will sound.
- ▶ If focus is not achieved, the AF point will turn red.



### 4 Take the picture.

- Check the focus and exposure, then press the shutter button to take the picture (p.106).

### ☺ (Face detection) Live Mode: AF ☺

With the same AF method as the Live mode, human faces are detected and focused. Have the target person face the camera.



### 1 Display the Live View image.

- Press the < [ ] > button.
- ▶ The Live View image will appear on the LCD monitor.
- When a face is detected, the < [ ] > frame will appear over the face to be focused.
- If multiple faces are detected, < [ ] > will be displayed. Press the < [ ] > key to move the < [ ] > frame over the target face.



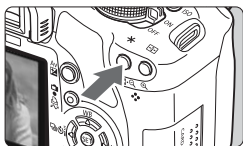

## 2 Focus the subject.

- Press the < \* > button to focus the face covered by the < □ > frame.
- ▶ When focus is achieved, the AF point will turn green and the beeper will sound.
- ▶ If focus is not achieved, the AF point will turn red.
- If a face cannot be detected, the < □ > AF point will be displayed and the center AF point will be used for focusing.



## 3 Take the picture.

- Check the focus and exposure, then press the shutter button to take the picture (p.106).







- If the focus is way off, face detection will not be possible. If the lens enables manual focusing even while the lens focus switch is set to < AF >, turn the focusing ring to attain rough focus. The face will then be detected and < □ > will be displayed.
- An object other than a human face might be detected as a face.
- Face detection will not work if the face is very small or large in the picture, too bright or too dark, tilted horizontally or diagonally, or partially hidden.
- The < □ > focusing frame might cover only part of the face.



- When you press the < 𐄂 > button, the AF mode will switch to the Live mode (p.111). You can press the < 𐄃 > key to switch to another AF point. Press the < 𐄂 > button again to return to the 'L' (face detection) Live mode.
- Since AF is not possible with a face detected near the edge of the picture, the < □ > will be grayed out. Then if you press the < \* > button, the center AF point < □ > will be used to focus.

## Live Mode and (Face Detection) Live Mode Notes

### AF operation

- Focusing will take slightly longer.
- Even when focus has been achieved, pressing the < > button will focus again.
- The image brightness may change during and after the AF operation.
- If the light source changes while the Live View image is displayed, the screen might flicker and focusing can be difficult. If this happens, stop the Live View shooting and autofocus under the actual light source first.
- If you press the < > button in the Live mode, the AF point area will be magnified. If it is difficult to focus in the magnified view, return to the normal view and autofocus. Note that the AF speed may differ between the normal and magnified views.
- If you autofocus in the Live mode's normal view and then magnify the image, the focus might be off.
- In the  Live mode, pressing the < > button will not magnify the image.



- In the Live mode or  (face detection) Live mode, if you shoot a peripheral subject and the target subject is slightly out of focus, aim the center AF point over the subject to focus, then take the picture.
  - The AF-assist beam will not be emitted.
  - AF is not possible with Remote Switch RS-60E3 (sold separately).

**Shooting conditions which can make focusing difficult:**

- Low-contrast subjects such as the blue sky and solid-color, flat surfaces.
- Subjects in low light.
- Stripes and other patterns where there is contrast only in the horizontal direction.
- Under a light source whose brightness, color, or pattern keeps changing.
- Night scenes or points of light.
- Under fluorescent lighting or when the image flickers.
- Extremely small subjects.
- Subjects at the edge of the picture.
- Subjects strongly reflecting light.
- The AF point covers both a near and faraway subject (such as an animal in a cage).
- Subjects which keep moving within the AF point and cannot keep still due to camera shake or subject blur.
- A subject approaching or moving away from the camera.
- Autofocusing while the subject is way out of focus.
- Soft focus effect is applied with a soft focus lens.
- A special effects filter is used.

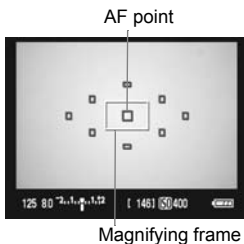

**Quick Mode: AFQuick**

The dedicated AF sensor is used to focus in the One-Shot AF mode (p.64), using the same AF method as with viewfinder shooting. Although you can focus the target area quickly, **the Live View image will be interrupted momentarily during the AF operation.**

**1 Display the Live View image.**

- Press the <  > button.
- ▶ The Live View image will appear on the LCD monitor.
- The small boxes on the screen are the AF points, and the larger box is the magnifying frame.

**2 Select the AF point.**

- When you press <  >, the Quick Control screen will appear.
- ▶ The current settable function will be highlighted in blue.
- Press the <  > key to make the AF point selectable.
- Turn the <  > dial to select the AF point.

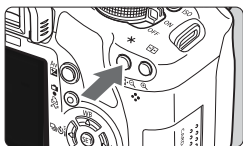

### 3 Focus the subject.

- Aim the AF point over the subject, and hold down the < \* > button.
- ▶ The Live View image will turn off, the reflex mirror will go back down, and AF will be executed.
- ▶ When focus is achieved, the beeper will sound and the Live View image will reappear.
- ▶ The AF point used to focus will be displayed in red.



### 4 Take the picture.

- Check the focus and exposure, then press the shutter button to take the picture (p.106).



- You cannot take a picture during autofocusing. Take the picture only while the Live View image is displayed.
- AF is not possible with Remote Switch RS-60E3 (sold separately).

# Focusing Manually <sup>☆</sup>

You can magnify the image and focus precisely manually.

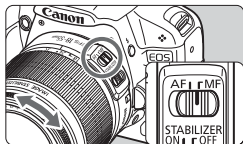

## 1 Set the lens focus mode switch to <MF>.

- Turn the lens focusing ring to focus roughly.

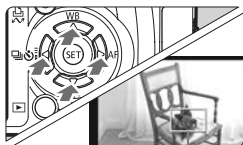

## 2 Move the magnifying frame.

- Press the <⬆> key to move the magnifying frame to the position where you want to focus.
- To return the AF point to the center, press the <⏏> button.

Magnifying frame

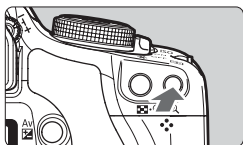

## 3 Magnify the image.

- Press the <Ⓜ> button.
- ▶ The image within the magnifying frame will be magnified.
- Each time you press the <Ⓜ> button, the display format will change as follows:

→ 5x → 10x → Normal view →



## 4 Focus manually.

- While looking at the magnified image, turn the lens focusing ring to focus.
- After achieving focus, press the <Ⓜ> button to return to the normal view.

AE lock

Magnified area position

Magnification

## 5 Take the picture.

- Check the focus and exposure, then press the shutter button to take the picture (p.106).



## Notes About the Live View Image

- Under low or bright light conditions, the Live View image might not reflect the brightness of the captured image.
- If the light source within the image changes, the screen might flicker. If this happens, stop and resume the Live View shooting under the actual light source to be used.
- If you point the camera in a different direction, it might throw off the Live View image's correct brightness momentarily. Wait until the brightness level stabilizes before shooting.
- If there is a very bright light source in the picture, such as the sun, the bright area might appear black on the LCD monitor. However, the actual captured image will correctly show the bright area.
- In low light, if you set the [**⚡**: LCD brightness] to a bright setting, chrominance noise may appear in the Live View image. However, the chrominance noise will not be recorded in the captured image.
- When you magnify the image, the image sharpness may look more pronounced than it really is.

## About the <🔥> icon

- If Live View shooting is used under direct sunlight or in other hot environments, the <🔥> icon (warning for the camera's high internal temperature) may appear on the screen. If Live View shooting continues with a high internal temperature, it may degrade image quality. You should therefore stop Live View shooting if the warning icon appears.
- If Live View shooting continues while the <🔥> warning icon is displayed and the camera's internal temperature increases, the Live View shooting will stop automatically. Live View shooting will be disabled until the camera's internal temperature decreases.

## Notes About the Shooting Results

- When you shoot continuously with the Live View function for a long period, the camera's internal temperature may increase and it can degrade image quality. Terminate Live View shooting when not shooting images.
- Before taking a long exposure, stop Live View shooting temporarily and wait several minutes before shooting. This is to prevent image degradation.
- Live View shooting in high temperatures and at high ISO speeds may cause noise or irregular colors.
- When you shoot at high ISO speeds, noise (horizontal banding, light dots, etc.) may appear.
- If you take the picture during magnified view, the exposure might not come out as desired. Return to the normal view before taking the picture. During the magnified view, the shutter speed and aperture will be displayed in red. Even if you take the picture during magnified view, the captured image will show the normal view.

### Custom Function Notes

- During Live View shooting, certain Custom Function settings will be disabled (p.183).
- If the [**4**: Custom Functions (C.Fn)] menu's [**Auto Lighting Optimizer**] (p.186) is set to a setting other than [**3: Disable**], the image may look bright even if a decreased exposure compensation or flash exposure compensation has been set.

### Notes About Lenses and Flash

- The focus preset feature on super telephoto lenses cannot be used.
- FE lock is not possible when the built-in flash or an external Speedlite is used. Modeling flash and test flash will not fire if an external Speedlite is used.



# 6

## Shooting Movies

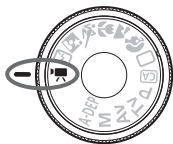

Set the Mode Dial to <[Movie Camera Icon]> to shoot movies. The movie file format will be MOV.

### SD Cards for Movie Shooting

When shooting movies, use a card with an SD speed Class 6 “CLASS 6” or higher. If you use a card with a slower SD speed Class, the movie shooting and playback might not work properly.

Also, a large-capacity card is recommended for movie shooting.



### About Full HD 1080

Full HD 1080 indicates compatibility with High-Definition with 1080 vertical pixels (scanning lines).



# Shooting Movies

Connecting the camera to a TV set is recommended to playback movies (p.156-157).



## 1 Set the Mode Dial to <Movie>.

- ▶ The reflex mirror will make a sound, then the image will appear on the LCD monitor.

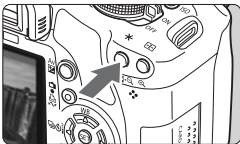

## 2 Focus the subject.

- Before shooting a movie, autofocus or manual focus (p.111-118).
- Press the < \* > button to focus in the current AF mode.



## 3 Shoot the movie.

- Press the <Movie> button to start shooting the movie. To stop shooting the movie, press <Movie> again.
- ▶ While the movie is being shot, the "●" mark will be displayed on the upper right of the screen.

- During movie shooting, do not point the lens toward the sun. The sun's heat can damage the camera's internal components.
- **Cautions for movie shooting are on pages 127-128.**
- **If necessary, also read the Live View shooting cautions on pages 119 and 120.**

- One continuous movie shoot will be recorded as one file.
- AE lock is possible by pressing the <ISO> button. To cancel AE lock, press the <Fn> button.
- The ISO speed, shutter speed, and aperture are set automatically.
- Pressing the shutter button halfway displays the shutter speed and aperture (p.126) at the screen bottom left. This is the exposure setting for taking a still photo.
- With a fully-charged Battery Pack LP-E5, the total shooting time will be as follows: At 23°C/73°F: Approx. 1 hr. 10 min., At 0°C/32°F: Approx. 1 hr.

# Movie Settings

Function settings particular to movie shooting are explained here.

## Functions Set with a Menu



### Display the movie menu.

- Select the [ ] menu tab.
- The menu options displayed are explained below.

- **Movie-recording size**

[1920x1080] : Full HD (Full High-Definition) recording quality.

[1280x720] : HD (High-Definition) recording quality.

[640x480] : Standard recording quality. The screen format will be 4:3.

### Total Movie Recording Time and File Size Per Minute

Movie-recording Size	Total Recording Time		File Size
	4GB Card	16GB Card	
[1920x1080]	12 min.	49 min.	330 MB/min.
[1280x720]	18 min.	1 hr. 13 min.	222 MB/min.
[640x480]	24 min.	1 hr. 39 min.	165 MB/min.



- At [1920x1080], the movie is recorded at 20 frames per second (fps). At [1280x720] and [640x480], it will be 30 fps.
- The semi-transparent parts on the top and bottom or on the left and right will not be recorded.
- With ZoomBrowser EX/ImageBrowser (provided software), you can extract a still image from the movie. The still image quality will be as follows: Approx. 2 megapixels at [1920x1080], approx. 1 megapixel at [1280x720], and approx. 300,000 pixels at [640x480].

- **AF mode**

The AF mode will be the same as described on pages 111-117. You can select [Live mode], [Live mode], or [Quick mode]. Note that continuous focusing of a moving subject cannot be done.

- **Grid display**

With [Grid 1  $\equiv$ ] or [Grid 2  $\equiv$ ], you can display grid lines.

- **Metering timer**

You can change how long the AE lock is to be maintained with the <ISO> button.

- **Sound recording**

When the sound recording is set to [On], monaural sound will be recorded with the built-in microphone. (An external microphone cannot be used.) The sound recording level will be adjusted automatically.

- **Remote control**

You can use Remote Controller RC-1/RC-5 (sold separately, p.194) to start and stop the movie shooting. With RC-1, set the timing switch to <2> (2-sec. delay), then press the transmit button. If the switch is set to <●> (immediate shooting), still photo shooting will take effect.

## Settable Functions During Camera Ready

While the image is displayed on the LCD monitor, press <SET> so that the AF mode, Picture Style, white balance, movie-recording size, and still image-recording quality can be set.



### 1 Press <SET>.

- ▶ The current settable function will be highlighted in blue.
- When <AF Quick> is selected, the AF points will also be displayed.

### 2 Select the function and set it.

- Press the <◀▶> key to select the function to be set.
- ▶ The name of the selected function is displayed at the bottom.
- Turn the <⚙> dial to change the setting.



- By holding down the <Av/☒> button and turning the <☀> dial, you can set the exposure compensation.
- In the movie shooting mode and Creative Zone modes, the setting will be the same for the Picture Style, white balance, image-recording quality, and exposure compensation (except **M**).

## Shooting Still Photos

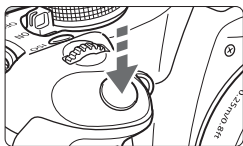

You can take a still photo at anytime by pressing the shutter button completely, even during movie shooting.

### Taking Still Photos During Movie Shooting

- The still photo will record the entire screen including the semi-transparent mask.
- If you take a still photo during movie shooting, the movie will have a still segment for about 1 sec.
- The captured still photo will be recorded to the card, and the movie shooting will resume automatically when the Live View image is displayed.
- The card will record the movie and still photo as separate files.
- Functions particular to still shooting are shown below. Other functions will be the same as for movie shooting.

Function	Setting
<b>Image-recording quality</b>	As set in the [ <b>Quality</b> ] menu.
<b>Exposure compensation</b>	Shutter speed and aperture automatically set. Displayed when the shutter button is pressed halfway.
<b>Drive mode</b>	Single shooting (Self-timer not possible)
<b>Flash</b>	Flash off

## About the Information Display

- Each time you press the <DISP.> button, the information display will change.

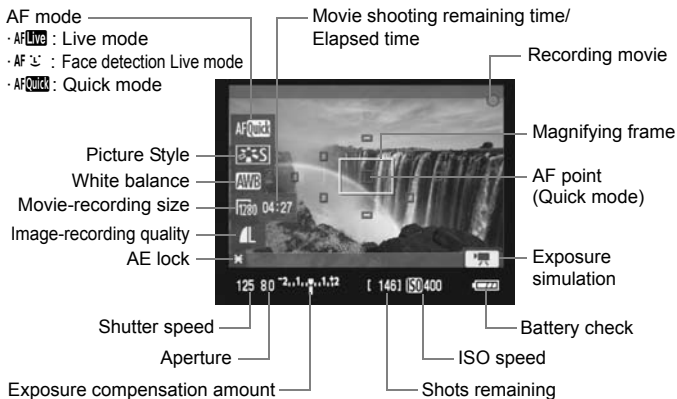

- If there is no card in the camera, the movie-recording size and movie shooting remaining time will be displayed in red.
- When movie shooting starts, the movie shooting remaining time will change to the elapsed time.
- When < > is displayed in white, it indicates that the Live View image brightness is close to what the actual movie will look like. If < > is blinking, it indicates that the Live View image is not being displayed at the suitable brightness due to low or bright light conditions. However, the actual movie recorded will reflect the exposure setting.

## Notes on Movie Shooting

### Recording and Image Quality

- At [1920x1080], the recorded frame rate is slower, so fast-moving subjects or scenes may look a little jerky.
- If a single movie's file size reaches 4 GB, the movie shooting will stop automatically. To start movie shooting again, press the <  > button. (A new movie file starts being recorded.)
- If the attached lens has an Image Stabilizer, the Image Stabilizer will operate at all times even if you do not press the shutter button halfway. The Image Stabilizer may cause the total movie shooting time or the number of possible shots to decrease. If you use a tripod or if the Image Stabilizer is not necessary, you should set the IS switch to <OFF>.
- The camera's built-in microphone will also pick up camera operation sounds. If you do not want to record any sound, set the sound recording to [Off].
- Autofocusing during movie shooting is not recommended since it might momentarily throw the focus way off or change the exposure. Even if the AF mode has been set to [Quick mode], it will switch to the Live mode during movie shooting.
- If the movie shooting is not possible due to the insufficient remaining capacity of the card, the movie recording size and movie shooting remaining time (p.126) will be displayed in red.
- If you use a card having a slow writing speed, the five-level indicator might appear on the right of the screen during movie shooting. It indicates how much data has not yet been written to the card (remaining capacity of the internal buffer memory). The slower the card, the faster the indicator will climb upward. If the indicator becomes full, movie shooting will stop automatically.



Indicator

If the card has a fast writing speed, the indicator will either not appear or the level (if displayed) will hardly go upward.



First, shoot a few test movies to see if the card can write fast enough.

If you take still photos during the movie shooting, the movie shooting might stop. If the still image recording quality has been set low, it might be improved.

- During movie shooting mode, certain Custom Function settings will be disabled (p.183).

## Notes on Movie Shooting

### Camera's internal temperature increase and image degradation

- If you continue to shoot movies for a prolonged period, the camera's internal temperature will increase. This can degrade the image quality. While not shooting, turn off the power.
- If you shoot under direct sunlight or high-temperature conditions, the  icon (high internal temperature warning) may appear on the screen. If you keep shooting a movie with the warning icon displayed, the image quality might degrade. You should turn off the power and allow the camera to rest for a while.
- If the  icon is displayed and you keep shooting movies until the camera's internal temperature increases further, the movie shooting will stop automatically. If this happens, you will not be able to shoot again until the camera's internal temperature decreases. Turn off the power and let the camera rest for a while.

### Playback and TV connection

- If the brightness changes during movie shooting, that part might freeze momentarily.
- If you connect the camera to a TV set with an HDMI cable (p.157) and shoot a movie in [1920x1080] or [1280x720], the movie being shot will be displayed at a small size on the TV. However, the actual movie will be properly recorded at the movie recording size that was set.
- If you connect the camera to a TV set (p.156-157) and shoot a movie, the TV will not output any sound during the shooting. However, the sound will be properly recorded.



# 7

## Handy Features

---

- Silencing the Beeper (p.130)
- Card Reminder (p.130)
- Setting the Image Review Time (p.130)
- Setting the Auto Power-off Time (p.131)
- Adjusting the LCD Monitor Brightness (p.131)
- File Numbering Methods (p.132)
- Auto Rotate of Vertical Images (p.134)
- Checking Camera Settings (p.135)
- Reverting the Camera to the Default Settings (p.136)
- About Copyright Information (p.137)
- Preventing the LCD Monitor from Turning off Automatically (p.138)
- Changing the Shooting Settings Screen Color (p.138)
- Setting the Flash (p.139)
- Automatic Sensor Cleaning (p.142)
- Appending Dust Delete Data (p.143)
- Manual Sensor Cleaning (p.145)

# Handy Features

## MENU Silencing the Beeper

You can prevent the beeper from sounding when focus is achieved or during self-timer operation.



Under the [**☑**] tab, select [**Beeper**], then press < (SET) >. Select [**Off**], then press < (SET) >.

## MENU Card Reminder

This prevents shooting if there is no card in the camera.



Under the [**☑**] tab, select [**Release shutter without card**], then press < (SET) >. Select [**Disable**], then press < (SET) >.

If there is no card installed and you press the shutter button, "**Card**" will be displayed in the viewfinder, and you cannot release the shutter.

## MENU Setting the Image Review Time

You can set how long the image is displayed on the LCD monitor immediately after capture. If [**Off**] is set, the image will not be displayed immediately after image capture. If [**Hold**] is set, the image review will be displayed up until the [**Auto power off**] time. During the image review, if you operate any camera controls such as pressing the shutter button halfway, the image display will end.

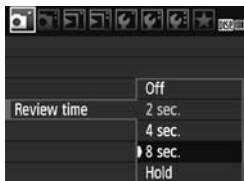

Under the [**☑**] tab, select [**Review time**], then press < (SET) >. Set the time, then press < (SET) >.

## MENU Setting the Auto Power-off Time

To save battery power, the camera turns off automatically after the set time of idle operation elapses. You can set this auto power-off time. When the camera has turned off due to auto power off, you can wake up the camera by pressing the shutter button halfway or any of the following buttons: <MENU> <DISP.> <▶> etc.

If [Off] has been set, either turn off the camera yourself or press the <DISP.> button to turn off the shooting settings display to save battery power.

If [Off] has been set and the camera is not used for 30 min., the LCD monitor will turn off automatically. To turn on the LCD monitor again, press the <DISP.> button.



Under the [] tab, select [Auto power off], then press <SET>. Set the time, then press <SET>.

## MENU Adjusting the LCD Monitor Brightness

You can adjust the brightness of the LCD monitor to make it easier to read.



Under the [] tab, select [LCD brightness], then press <SET>. With the adjustment screen displayed, press the <◀▶> key to adjust the brightness, then press <SET>.



When checking the exposure of an image, set the LCD monitor brightness to 4 and prevent the ambient light from affecting the reviewed image.

**MENU File Numbering Methods**

The file number is like the frame number on a roll of film. The captured images are assigned a sequential file number from 0001 to 9999 and saved in one folder. You can change how the file number is assigned. The file number will appear on a computer in this format:  
**IMG\_0001.JPG.**

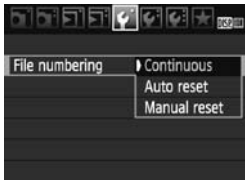

Under the [**F**] tab, select [**File numbering**], then press <SET>. Follow the steps below to select a file numbering method, then press <SET>.

- **[Continuous]: The file numbering continues in sequence even after the card is replaced.**

Even after you replace the card, the file numbering continues in sequence up to 9999. This is convenient when you want to save the images numbered anywhere between 0001 to 9999 from multiple cards into one folder in your computer.

If the replacement card contains images recorded previously, the file numbering of the new images might continue from the file numbering of the existing images in the card. If you want to use continuous file numbering, you should use a newly-formatted card each time.

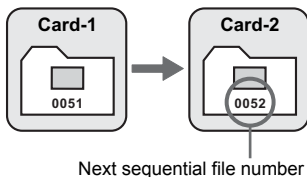
**File numbering after replacing the card**

- **[Auto reset]: Resets the file numbering to 0001 whenever the card is replaced.**

Each time you replace the card, the file numbering restarts from 0001. This is convenient if you want to organize images according to cards. If the replacement card contains images recorded previously, the file numbering of the new images might continue from the file numbering of the existing images in the card. To restart the file numbering from 0001, you should use a newly-formatted card.

#### File numbering after replacing the card

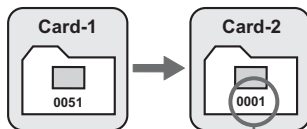

File numbering is reset

- **[Manual reset]: To reset the file numbering to 0001 manually or to start from file number 0001 in a new folder**

When you reset the file numbering manually, a new folder is created automatically and the file numbering of images saved to that folder starts from 0001.

This is convenient when you want to use different folders for the images taken yesterday and the ones taken today, for example. After the manual reset, the file numbering returns to continuous or auto reset.



If the file number in folder No. 999 reaches 9999, shooting will not be possible even if the card still has storage capacity. The LCD monitor will display a message to replace the card. Replace with a new card.



For both JPEG and RAW images, the file name will start with "IMG\_". Movie file names will start with "MVI\_". The extension will be ".JPG" for JPEG images, ".CR2" for RAW images, and ".MOV" for movies.

**MENU Auto Rotate of Vertical Images**

Vertical images are rotated automatically so they are displayed vertically on the camera's LCD monitor and computer instead of horizontally. The setting of this feature can be changed.

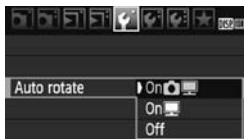

Under the [**⚙**] tab, select [**Auto rotate**], then press <[**SET**]>. The available settings are described below. Select one, then press <[**SET**]>.

- [**On** ] : The vertical image is automatically rotated during playback on both the camera's LCD monitor and on the computer.
- [**On** ] : The vertical image is automatically rotated only on the computer.
- [**Off**] : The vertical image is not automatically rotated at all.

**? FAQ**

- **The vertical image is not rotated during the image review immediately after it is captured.**  
Press the <[**▶**]> button and the image playback will display the rotated image.
- **[On ] is set, but the image does not rotate during playback.**  
Auto rotate will not work with vertical images captured while [**Auto rotate**] was set to [**Off**]. Also, if the vertical image is taken while the camera is pointed up or down, the image might not rotate for playback. In such a case, see "Rotating the Image" on page 151.
- **On the camera's LCD monitor, I want to rotate an image captured when [On ] had been set.**  
Set [**On** ], then playback the image. It will be rotated.
- **The vertical image does not rotate on the computer screen.**  
The software used is not compatible with image rotation. Use the camera's provided software instead.

## DISP. Checking Camera Settings

While the menu is displayed, press the <DISP.> button to display the camera's current settings.

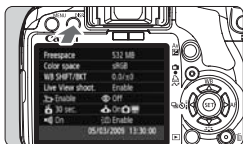

- While the menu is displayed, press the <DISP.> button to display the settings.
- Press the <DISP.> button again to return to the menu.
- Press the shutter button halfway to return to the shooting settings display.

### Settings Display

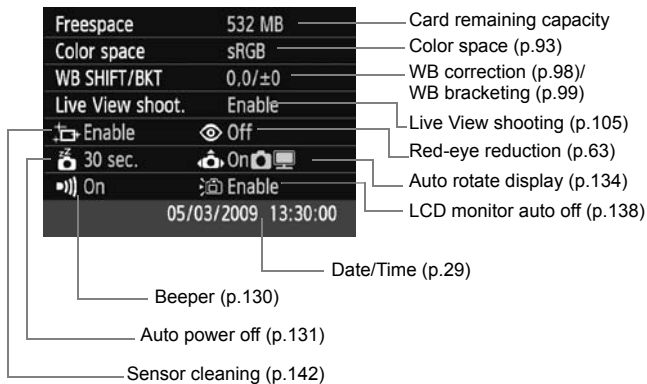

**MENU Reverting the Camera to the Default Settings** ☆

This is for reverting all the camera's shooting settings and Custom Functions to the default settings. This works in the <P> and other Creative Zone modes.

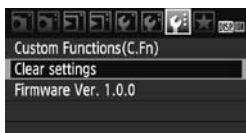
**1 Select [Clear settings].**

- Under the [**☛**] tab, select [**Clear settings**], then press <SET>.

**2 Select the desired setting.**

- To revert the shooting settings to the default, select [**Clear all camera settings**], then press <SET>.
- To revert the Custom Functions to the default settings, select [**Clear all Custom Func. (C.Fn)**], then press <SET>.

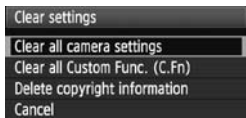
**3 Select [OK].**

- Select [**OK**], then press <SET>.
- ▶ Setting [**Clear all camera settings**] will reset the camera to the following default settings:

**Shooting Settings**





<b>AF mode</b>	One-Shot AF
<b>AF point selection</b>	Automatic selection
<b>Metering mode</b>	(Evaluative metering)
<b>ISO speed</b>	AUTO (Auto)
<b>Drive mode</b>	<input type="checkbox"/> (Single shooting)
<b>Exposure compensation/AEB</b>	Canceled
<b>Flash exposure compensation</b>	0 (Zero)
<b>Live View shooting</b>	Enable

**Image-recording Settings**

<b>Quality</b>	L
<b>Picture Style</b>	Standard
<b>Color space</b>	sRGB
<b>White balance</b>	(Auto)
<b>WB correction</b>	Canceled
<b>WB-BKT</b>	Canceled
<b>Peripheral illumination correction</b>	Enable/ Correction data retained
<b>File numbering</b>	Continuous
<b>Auto cleaning</b>	Enable
<b>Dust Delete Data</b>	Erased



### Camera Settings

Auto power off	30 sec.
Beep	On
Release shutter without card	Enable
Review time	2 sec.
Image jump w/ 	10 images
Auto rotate	On 
LCD brightness	  

### Movie Settings

Movie-recording size	1280x720
AF mode	Live mode
Sound recording	On
Grid display	Off
Metering timer	16 sec.
Remote control	Disable



Custom Function settings, date/time, interface language, video system, and My Menu items will not change.

### **MENU** About Copyright Information <sup>★</sup>

If you use EOS Utility (provided software) to set your copyright information, the copyright information will be added to the image's Exif information. With the camera, the copyright information can only be viewed or deleted. If your copyright information has not been set, it will be grayed out on the screen and unusable.

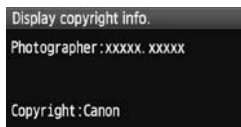
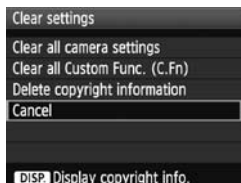

- With the **[Clear settings]** screen displayed, press the <DISP.> button to display the copyright information.
- Press the <MENU> button to return to the **[Clear settings]** screen.
- To delete the copyright information, select **[Delete copyright information]** on the **[Clear settings]** screen.

**MENU Preventing the LCD Monitor from Turning off Automatically**

This prevents the display-off sensor from turning off the shooting settings display automatically when your eye nears the viewfinder eyepiece.

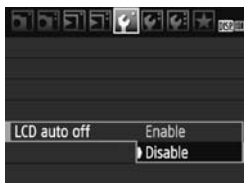
**Select [LCD auto off].**

- Under the [**F**] tab, select [**LCD auto off**], then press <SET>. Select [**Disable**], then press <SET>.

**MENU Changing the Shooting Settings Screen Color**

You can change the background color of the shooting settings screen.

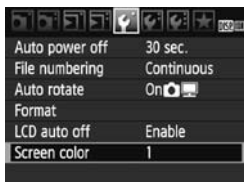
**Select [Screen color].**

- Under the [**F**] tab, select [**Screen color**], then press <SET>.
- Select the desired color, then press <SET>.
- When you exit the menu, the selected color will be displayed for the shooting settings screen.

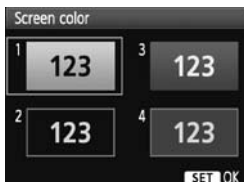

## MENU Setting the Flash ☆

The built-in flash and external Speedlite settings can be set with the menu. The [External flash \*\*\*] menu options for external Speedlites will be applicable only to an attached **EX-series Speedlite compatible with the respective functions**.

The setting procedure is the same as setting a camera menu function.

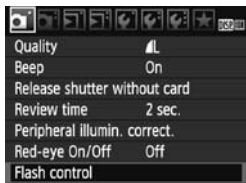

### Select [Flash control].

- Under the [ ] tab, select [Flash control], then press < (SET) >.
- ▶ The flash control screen will appear.

### [Flash firing]

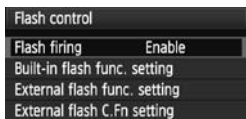

- Normally, set this to [Enable].
- If [Disable] is set, both the built-in flash and external Speedlite will not fire. This is useful when you only want to use the AF-assist beam.

### [Built-in flash func. setting] and [External flash func. setting]

The [Built-in flash func. setting] and [External flash func. setting] menus can set the functions listed on the next page. The functions displayed under [External flash func. setting] will vary depending on the Speedlite model.

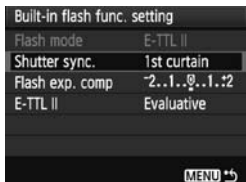

- Select [Built-in flash func. setting] or [External flash func. setting].
- ▶ The flash functions will be displayed. The functions not dimmed can be set or selected.

## [Built-in flash func. setting] and [External flash func. setting] Settable Functions

Function	[Built-in flash func. setting]	[External flash func. setting]	Page
Flash mode	Fixed at E-TTL II	○	140
Shutter sync.		○	140
FEB*	–	○	–
Flash exposure compensation		○	85
E-TTL II		○	141
Zoom*	–	○	–
Wireless setting*	–	○	–

\* Regarding the [FEB] (Flash exposure bracketing), [Zoom], and [Wireless set.], refer to the Speedlite's instruction manual.

### ● Flash mode

With an external Speedlite, you can select the flash mode to suit your flash shooting.

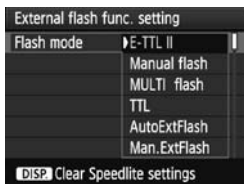

- [E-TTL II] is the standard mode for EX-series Speedlites for automatic flash shooting.
- [Manual flash] enables you to set the flash output yourself. This is for advanced users.
- Regarding other flash modes, refer to your Speedlite's instruction manual.

### ● Shutter sync.

Normally, set this to [1st curtain] so that the flash fires immediately after the exposure starts.

If [2nd curtain] is set, the flash will fire right before the exposure ends. When this is combined with a slow sync speed, you can create a trail of light such as from car headlights at night. With 2nd curtain sync, two flashes will be fired, once when you press the shutter button completely, and once immediately before the exposure ends. If an external Speedlite is attached, you can also set [Hi-speed]. For details, see the Speedlite's instruction manual.

- **Flash exposure compensation**

See “ Flash Exposure Compensation” on page 85.

- **E-TTL II**

For normal flash exposures, set it to **[Evaluative]**.

If **[Average]** is set, the flash exposure will be averaged for the entire metered scene as with an external metering flash. Flash exposure compensation may be necessary depending on the scene, so this setting is for advanced users.

- **Clear Speedlite settings**

On the **[External flash func. setting]** screen, press the <DISP.> button to display the screen to clear the flash settings. When you select **[OK]**, the settings for the built-in flash and external Speedlite will be cleared.

## Setting the External Speedlite Custom Functions

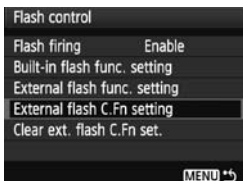

### 1 Display the Custom Function.

- Select **[External flash C.Fn setting]**, then press <SET>.

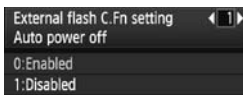

### 2 Set the Custom Function.

- Press the <◀▶> key, then press <SET>.
- To clear all the Custom Function settings, select **[Clear ext. flash C.Fn set.]** in step 1.

## Automatic Sensor Cleaning

Whenever you set the power switch to <ON> or <OFF>, the Self Cleaning Sensor Unit operates to automatically shake off the dust on the front of the sensor. Normally, you need not pay attention to this operation. However, you can execute the sensor cleaning at anytime as well as disable it.

### Cleaning the Sensor Now



#### 1 Select [Sensor cleaning].

- Under the [>] tab, select [**Sensor cleaning**], then press <SET>.

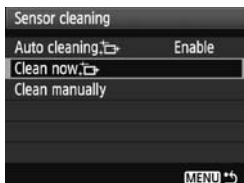

#### 2 Select [Clean now >].

- Select [**Clean now >**], then press <SET>.
- Select [**OK**] on the dialog screen, then press <SET>.
- ▶ The screen will indicate that the sensor is being cleaned. Although there will be a shutter sound, a picture is not taken.



- For best results, do the sensor cleaning while the camera bottom is placed on a table or other flat surface.
- Even if you repeat the sensor cleaning, the result will not improve that much. Right after the sensor cleaning is finished, the [**Clean now >**] option will remain disabled temporarily.

### Disabling Automatic Sensor Cleaning

- In step 2, select [**Auto cleaning >**] and set it to [**Disable**].
- ▶ The sensor cleaning will no longer be executed when you set the power switch to <ON> or <OFF>.

## MENU Appending Dust Delete Data ☆

Normally, the Self Cleaning Sensor Unit will eliminate most of the dust that might be visible on captured images. However, in case visible dust still remains, you can append the Dust Delete Data to the image to later erase the dust spots. The Dust Delete Data is used by Digital Photo Professional (provided software) to erase the dust spots automatically.

### Preparation

- Get a solid-white object (paper, etc.).
- Set the lens focal length to 50mm or longer.
- Set the lens focus mode switch to <MF> and set the focus to infinity (∞). If the lens has no distance scale, look at the front of the lens and turn the focusing ring clockwise all the way.

### Obtain the Dust Delete Data



#### 1 Select [Dust Delete Data].

- Under the [M] tab, select [Dust Delete Data], then press <SET>.

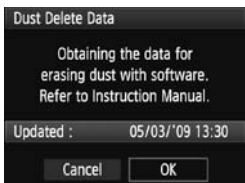

#### 2 Select [OK].

- Select [OK] and press <SET>. The automatic self-cleaning of the sensor will be performed, then a message screen will appear. Although there will be a shutter sound, a picture is not taken.

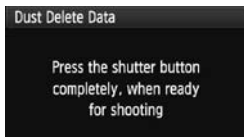

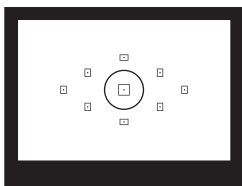

### 3 Photograph a solid-white object.

- At a distance of 20 cm - 30 cm / 0.7 ft. - 1.0 ft., fill the viewfinder with a patternless, solid-white object and take a picture.
- ▶ The picture will be taken in the aperture-priority AE mode with an aperture of f/22.
- Since the image will not be saved, the data can still be obtained even if there is no card in the camera.
- ▶ When the picture is taken, the camera will start obtaining the Dust Delete Data. When the Dust Delete Data is obtained, a message will appear. Select [OK], and the menu will reappear.
- If the data was not obtained successfully, a message to that effect will appear. Follow the "Preparation" procedure on the preceding page, then select [OK]. Take the picture again.

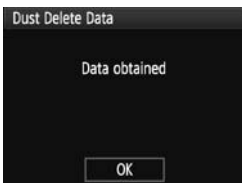

## About the Dust Delete Data

After the Dust Delete Data is obtained, it is appended to all the JPEG and RAW images captured thereafter. Before an important shoot, you should update the Dust Delete Data by obtaining it again.

To erase dust spots automatically with the provided software, see the Software Instruction Manual in the CD-ROM.

The Dust Delete Data appended to the image is so small that it hardly affects the image file size.

 Be sure to use a solid-white object such as a new sheet of white paper. If the paper has any pattern or design, it may be recognized as dust data and affect the accuracy of the dust deletion with the software.



## MENU Manual Sensor Cleaning ☆

Dust which could not be removed by the automatic sensor cleaning can be removed manually with a blower, etc.

**The surface of the image sensor is extremely delicate. If the sensor needs to be cleaned directly, having it done by a Canon Service Center is recommended.**

Before cleaning the sensor, detach the lens from the camera.



### 1 Select [Sensor cleaning].

- Under the [] tab, select [**Sensor cleaning**], then press <SET>.

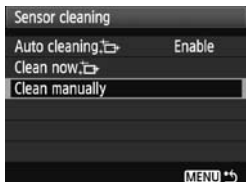

### 2 Select [Clean manually].

- Select [**Clean manually**], then press <SET>.



### 3 Select [OK].

- Select [**OK**], then press <SET>.
- ▶ In a moment, the reflex mirror will lockup and the shutter will open.

### 4 End the cleaning.

- Set the power switch to <OFF>.



- As power source, using the AC Adapter Kit ACK-E5 (sold separately) is recommended.
- If you use the battery, make sure it is fully recharged. If a battery grip with size-AA/LR6 batteries is attached, manual sensor cleaning will not be possible.

- **While cleaning the sensor, never do any of the following. If the power is cut off, the shutter will close and the shutter curtains and image sensor might get damaged.**
  - **Setting the power switch to <OFF>.**
  - **Opening the battery compartment cover.**
  - **Opening the card slot cover.**
- The surface of the image sensor is extremely delicate. Clean the sensor with care.
- Use a plain blower without any brush attached. A brush can scratch the sensor.
- Do not insert the blower tip inside the camera beyond the lens mount. If the power is turned off, the shutter will close and the shutter curtains or reflex mirror might get damaged.
- Never use canned air or gas to clean the sensor. The blowing force can damage the sensor or the spray gas can freeze on the sensor.

# 8

## Image Playback

This chapter explains features related to viewing photos and movies, going into more detail than in Chapter 2 “Basic Shooting and Image Playback” which explained the playback procedure. Here you will learn how to playback and erase photos and movies with the camera and viewing them on a TV set.

**About images taken with another camera:**

The camera might not be able to properly display images captured with a different camera or edited with a computer or whose file name was changed.

## ▶ Searching for Images Quickly

### ☒ Display Multiple Images on One Screen (Index display)

Search for images quickly with the index display showing four or nine images on one screen.



#### 1 Playback the image.

- When you press the <▶> button, the last captured image will be displayed.



#### 2 Turn on the index display.

- Press the <☒·Q> button.
- ▶ The 4-image index display will appear. The currently-selected image will be highlighted in a blue frame.
- Press the <☒·Q> button again to switch to the 9-image index display.



#### 3 Select the image.



- Press the <◀▶> key to move the blue frame to select the image.
- Turn the <☀> dial to see the next screen of index images.
- Press the <Q> button to display the selected image in the normal view. (9 images → 4 images → 1 image)

## Jump through Images (Jump display)

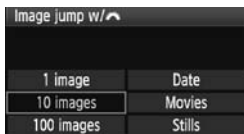
With the single image display, you can turn the  dial to jump through the images.



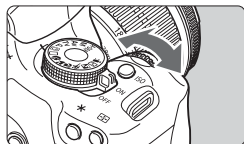

### 1 Select the jump method.

- In the [ Image jump w/ ] menu, select the desired jump method from [1 image/10 images/100 images/Date/Movies/Stills], then press .



### 2 Browse by jumping.

- Press the  button to playback the image.
- On the single-image display, turn the  dial.
- ▶ The jump display will proceed according to the selected jump method.
- ▶ On the bottom right, the jump method and current image location are indicated.
- To change the jump method, press the  key.



Jump method

Image location





- To search images according to the shooting date, select [Date]. During image playback, turn the  dial to display the shooting date.
- If the card has both [Movies] and [Stills], select either one to display only movies or stills.

## Magnified View

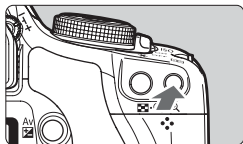
You can magnify the image by 1.5x to 10x on the LCD monitor.



### 1 Magnify the image.



- During image playback, press the  button.
- ▶ The image will be magnified.
- To increase the magnification, hold down the  button. The image will continue to be magnified until it reaches the maximum magnification.
- Press the  button to reduce the magnification. If you hold down the button, the magnification will continue to reduce to the single image display.

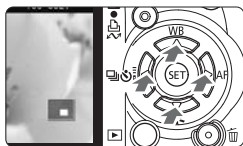

Magnified area position



### 2 Scroll around the image.

- Use the  key to scroll around the magnified image.
- To exit the magnified display, press the  button and the single-image display will return.





- You can turn the  dial to view another image while the magnification is maintained.
- Magnified view is not possible during the image review immediately after the image is taken.
- A movie cannot be magnified.

## Rotating the Image

You can rotate the displayed image to the desired orientation.



### 1 Select [Rotate].

- Under the [] tab, select [**Rotate**], then press < >.



### 2 Select the image.







- Press the < > key to select the image to be rotated.
- You can also select an image on the index display.



### 3 Rotate the image.

- Each time you press < >, the image will rotate clockwise as follows: 90° → 270° → 0°
- To rotate another image, repeat steps 2 and 3.
- To exit and return to the menu, press the <MENU> button.



- If you have set [ **Auto rotate**] to [**On**  ] (p.134) before taking vertical shots, you need not rotate the image as described above.
- If the rotated image is not displayed in the rotated orientation during image playback, set the [ **Auto rotate**] menu to [**On**  ].
- A movie cannot be rotated.

# ▶▶ Playing Movies



## 1 Playback the image.

- Press the <▶> button to display the image.



## 2 Select a movie.

- Press the <◀▶> key to select the image.
- During the single-image display, the <▶▶ SET > icon displayed on the upper left indicates that it is a movie.
- During the index display, the perforation on the left edge of the image indicates that it is a movie.

**Movies cannot be played on the index display, so press the <Ⓢ> button to switch to the single-image display.**



## 3 Press <Ⓢ>.



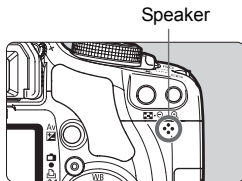













- On the single-image display, press <Ⓢ>.
- ▶ The movie playback panel will appear on the bottom.



## 4 Playback the movie.

- Select [▶] (Play), then press <Ⓢ>.
- ▶ The movie will start playing.
- You can pause the movie playback by pressing <Ⓢ>.
- During movie playback, you can adjust the sound volume by turning the <☀> dial.
- For more details on the playback procedure, see the next page.



Function	Playback Description
 <b>Exit</b>	Returns to the single-image display.
 <b>Play</b>	Pressing <  > toggles between play and pause.
 <b>Slow motion</b>	Adjust the slow motion speed by pressing the <  > key. The slow-motion speed is indicated on the upper right.
 <b>First frame</b>	Displays the movie's first frame.
 <b>Previous frame</b>	Each time you press <  >, a single previous frame is displayed. If you hold down <  >, it will rewind the movie.
 <b>Next frame</b>	Each time you press <  >, the movie will play frame-by-frame. If you hold down <  >, it will fast forward the movie.
 <b>Last frame</b>	Displays the movie's last frame.
	Playback position
mm' ss"	Playback time
 <b>Volume</b>	You can adjust the built-in speaker's (p.17) sound volume by turning the <  > dial.



- With a fully-charged Battery Pack LP-E5, the continuous playback time will be as follows: At 23°C/73°F: Approx. 2 hr. 30 min.
- During the single-image display, press the <DISP.> button to switch the shooting information display (p.161).
- If you took a still photo when you shot the movie, the still photo will be displayed for about 1 sec. during the movie playback.
- If you connect the camera to a TV set (p.156-157) to playback a movie, adjust the sound volume with the TV set. (Turning the <  > dial will not adjust the sound volume.)
- To edit a movie, use ZoomBrowser EX/ImageBrowser (provided software).

## MENU Slide Show (Auto Playback)

You can playback the images in the card as an automatic slide show.



### 1 Select [Slide show].

- Under the [ ] tab, select [Slide show], then press <SET>.

Number of images to be played



### 2 Select the images to be played back.

- Press the <▲▼> key to select the top menu item, then press <SET>. Press the <▲▼> key to select one of the following: [ ] All images/ [ ] Stills/ [ ] Movies/ [ ] Date]. Then press <SET>.
- If you selected [ ] Date, press the <DISP.> button while <DISP. ↓> is displayed brightly.
- The [Select date] screen will appear. Press the <▲▼> key to select the date, then press <SET>.



Function	Playback Description
[ ] All images	All the still photos and movies in the card will be played back.
[ ] Date	Still photos and movies taken on the selected shooting date will be played back.
[ ] Movies	Only the movies in the card will be played back.
[ ] Stills	Only the still photos in the card will be played back.



### 3 Set the play time and repeat option.

- Press the <▲▼> key to select [Set up], then press <SET>.
- For still photos, set the [Play time] and [Repeat] options, then press the <MENU> button.

[Play time]



[Repeat]



### 4 Start the slide show.

- Press the <▲▼> key to select [Start], then press <SET>.
- ▶ After [Loading image...] is displayed, the slide show will start.
- To pause the slide show, press <SET> ([||] displayed on upper left). Press <SET> again to resume playback.

### 5 Quit the slide show.

- To quit the slide show and return to the setting screen, press the <MENU> button.



- During auto playback, you can press the <DISP.> button to change the still photo display format.
- During movie playback, you can adjust the sound volume by turning the <VOLUME>.
- During pause, you can press the <◀▶> key to view another image.
- During the slide show, auto power off will not work.
- The display time may vary depending on the image.
- To view the slide show on a TV set, see page 156-157.

# Viewing the Images on TV

You can also view the still photos and movies on a TV set. Before connecting or disconnecting the cable between the camera and television, turn off the camera and television.

\* Adjust the movie's sound volume with the TV set.

\* Depending on the TV set, part of the image displayed might be cut off.

## Viewing on Non-HD (High-Definition) TV Sets

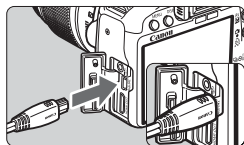

### 1 Connect the provided AV cable to the camera.

- Connect the AV cable to the camera's <A/V OUT/DIGITAL> terminal.
- With the plug's <Canon> logo facing the back of the camera, insert it into the <A/V OUT/DIGITAL> terminal.

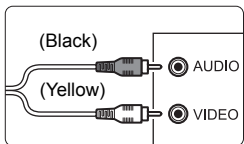

### 2 Connect the AV cable to the TV set.

- Connect the AV cable to the TV's video IN terminal and to the audio IN terminal.

### 3 Turn on the TV and switch the TV's video input to select the connected terminal.

### 4 Set the camera's power switch to <ON>.

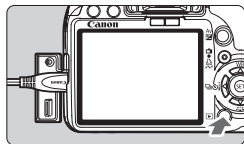

### 5 Press the <▶> button.

- ▶ The image will appear on the TV screen. (Nothing will be displayed on the camera's LCD monitor.)
- To playback movies, see page 152.

- ⓘ ● If the video system format does not match the TV's, the images will not be displayed properly. Set the proper video system format with [**Video system**].
- Do not use any AV cable other than the one provided. Images might not be displayed if you use a different cable.

## Viewing on HD (High-Definition) TV Sets

The HDMI Cable HTC-100 (sold separately) is required.

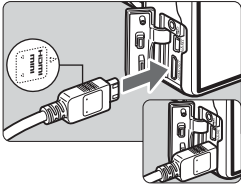

### 1 Connect the HDMI cable to the camera.

- Connect the HDMI cable to the camera's <HDMI OUT> terminal.
- With the plug's <▲HDMI MINI> logo facing the front of the camera, insert it into the <HDMI OUT> terminal.

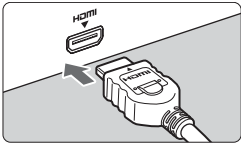

### 2 Connect the HDMI cable to the TV set.

- Connect the HDMI cable to the TV's HDMI IN port.

### 3 Turn on the TV and switch the TV's video input to select the connected port.

### 4 Set the camera's power switch to <ON>.

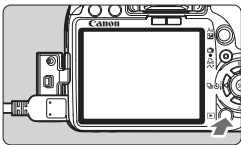

### 5 Press the <▶> button.

- ▶ The image will appear on the TV screen. (Nothing will be displayed on the camera's LCD monitor.)
- The images will be displayed automatically at the TV's optimum resolution.
- To playback movies, see page 152.



- Do not connect any other device's output to the camera's <HDMI OUT> terminal. Doing so may cause a malfunction.
- Some TVs might not be able to display the captured images. In such a case, use the provided AV cable to connect to the TV.
- The camera's <A/V OUT/DIGITAL> terminal and <HDMI OUT> terminal cannot be used at the same time.

## Protecting Images

Protecting the image prevents it from being erased accidentally.





Image protect icon



### 1 Select [Protect images].

- Under the [] tab, select [Protect images], then press <SET>.
- ▶ The protect setting screen will appear.

### 2 Select the image and protect it.

- Press the <◀▶> key to select the image to be protected, then press <SET>.
- ▶ When an image is protected, the <> icon will appear on the screen.
- To cancel the image protection, press <SET> again. The <> icon will disappear.
- To protect another image, repeat step 2.
- To exit the image protection, press the <MENU> button. The menu will reappear.

 **If you format the card (p.40), the protected images will also be erased.**

- Once an image is protected, it cannot be erased by the camera's erase function. To erase a protected image, you must first cancel the protection.
- If you erase all the images (p.160), only the protected images will remain. This is convenient when you want to erase unnecessary images all at once.

## Erasing Images

You can either select and erase images one by one or erase them in one batch. Protected images (p.158) will not be erased.

- ⚠ **Once an image is erased, it cannot be recovered. Make sure you no longer need the image before erasing it. To prevent important images from being erased accidentally, protect it. Erasing a **RAW** + **L** image will erase both the RAW and JPEG images.**

### Erasing a Single Image

- 1 Playback the image to be erased.



- 2 Press the **<  >** button.

- ▶ The erase menu will appear at the bottom of the screen.



- 3 Erase the image.



- Select **[Erase]**, then press **<  >**. The image displayed will be erased.

### **MENU** Checkmarking **< >** Images to be Erased in a Batch

By checkmarking the images to be erased, you can erase multiple images at one time.



- 1 Select **[Erase images]**.

- Under the **[  ]** tab, select **[Erase images]**, then press **<  >**.

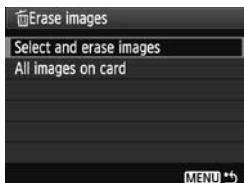

## 2 Select [Select and erase images].

- Select [**Select and erase images**], then press <SET>.
- ▶ An image will appear.
- Press the <[Image]·Q> button to display the three-image view. To return to the single-image display, press the <Q> button.



## 3 Select the images to be erased.

- Select the images to be erased and press the <▲▼> key.
- ▶ The <✓> icon will be displayed on the upper left.
- To erase other images, repeat step 3.



## 4 Erase the images.

- Press the <[Trash]> button.
- Select [**OK**], then press <SET>.
- ▶ The selected images will be erased.

### **MENU** Erasing All Images in the Card

You can also erase all the images in the card. When the [**Erase images**] menu is set to [**All images on card**], all the images in the card will be erased.

 To also erase protected images, format the card instead (p.40).



# DISP. Shooting Information Display

When you press the <DISP.> button during single-image playback, you can switch the shooting information display. The most detailed shooting information is shown below.

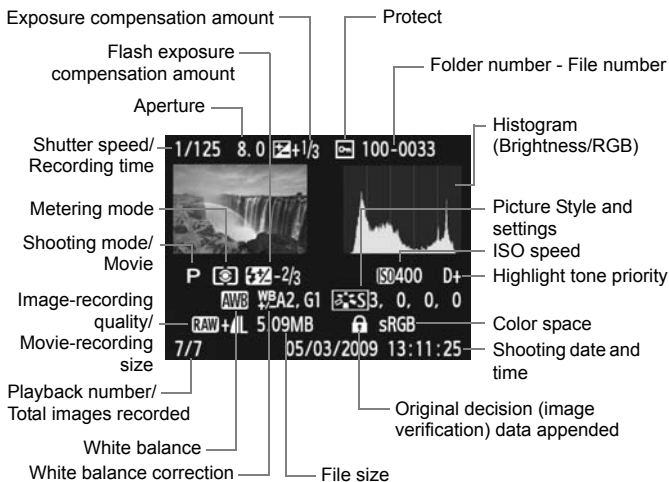

\* With **RAW** + **L** images, the **L** file size is displayed.

\* In the case of movies, the movie icon <MOV>, file type **[MOV]**, and recording size (**[1920]**, **[1280]**, **[640]**) will be displayed. The ISO speed and certain other shooting information will not be displayed.

## ● About the Highlight Alert

When the shooting information is displayed, any overexposed areas of the image will blink. To obtain more image detail in the overexposed areas, set the exposure compensation to a negative amount and shoot again.

## ● About the Histogram

The brightness histogram display shows the exposure level distribution and overall brightness. The RGB histogram display is for checking the color saturation and gradation. The display can be switched with the [  Histogram ] menu.

### [Brightness] Display

This histogram is a graph showing the distribution of the image's brightness level. The horizontal axis indicates the brightness level (darker on the left and brighter on the right), while the vertical axis indicates how many pixels exist for each brightness level. The more pixels there are toward the left, the darker the image. And the more pixels there are toward the right, the brighter the image. If there are too many pixels on the left, the shadow detail will be lost. And if there are too many pixels on the right, the highlight detail will be lost. The gradation in-between will be reproduced. By checking the image and its brightness histogram, you can see the exposure level inclination and the overall tone reproduction.

#### Sample Histograms



Dark image



Normal brightness



Bright image

### [RGB] Display

This histogram is a graph showing the distribution of each primary color's brightness level in the image (RGB or red, green, and blue). The horizontal axis indicates the color's brightness level (darker on the left and brighter on the right), while the vertical axis indicates how many pixels exist for each color brightness level. The more pixels there are toward the left, the darker and less prominent the color. And the more pixels there are toward the right, the brighter and denser the color. If there are too many pixels on the left, the respective color information will be lacking. And if there are too many pixels on the right, the color will be too saturated with no detail. By checking the image's RGB histogram, you can see the color's saturation and gradation condition and white balance inclination.

# 9

## Printing Images and Transferring Images to a Computer

---

- **Printing** (p.164)  
You can connect the camera directly to a printer and print out the images in the card. The camera is compatible with “PictBridge” which is the standard for direct printing.
- **Digital Print Order Format (DPOF)** (p.173)  
DPOF (Digital Print Order Format) enables you to print images recorded in the card according to your printing instructions such as the image selection, quantity to print, etc. You can print multiple images in one batch or give the print order to a photofinisher.
- **Transferring Images to a Computer** (p.177)  
By connecting the camera to a computer, you can transfer images from the camera's card by operating the camera.

# Preparing to Print

The direct printing procedure is done entirely with the camera while you look at the LCD monitor.

## Connecting the Camera to a Printer

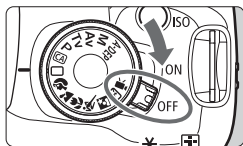

**1** Set the camera's power switch to <OFF>.

**2** Set up the printer.

- For details, see the printer's instruction manual.

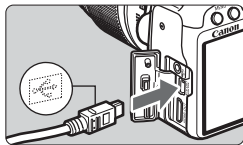

**3** Connect the camera to the printer.

- Use the interface cable provided with the camera.
- When connecting the cable plug to the camera's <A/V OUT/DIGITAL> terminal, the cable plug's <↔> icon must face the front side of the camera.
- To connect to the printer, refer to the printer's instruction manual.

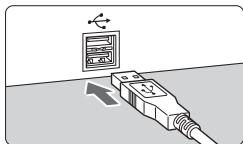

**4** Turn on the printer.

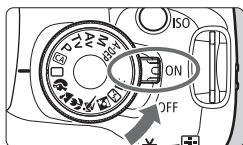

**5** Set the camera's power switch to <ON>.

- ▶ Some printers may make a beeping sound.

## PictBridge



## 6 Playback the image.

- Press the <▶> button.
- ▶ The image will appear, and the <📷> icon will appear on the upper left to indicate that the camera is connected to a printer.
- ▶ The <📷> button lamp will light in blue.



- Movies cannot be printed.
- The camera cannot be used with printers compatible only with CP Direct or Bubble Jet Direct.
- Do not use any interface cable other than the one provided.
- If there is a long beeping sound in step 5, it indicates a problem with the printer. To find out what's wrong, do the following:
  1. Press the <▶> button to playback the image.
  2. Press <SET>.
  3. On the print setting screen, select **[Print]**.

The error message will be displayed on the LCD monitor (p.172).



- If you use the battery to power the camera, make sure it is fully charged. With a fully-charged Battery Pack LP-E5, printing up to about 4 hours is possible.
- Before disconnecting the cable, turn off the camera and printer first. Hold the plug (not the cord) to pull out the cable.
- For direct printing, using the AC Adapter Kit ACK-E5 (sold separately) to power the camera is recommended.

# Printing

The screen display and setting options will differ depending on the printer. Some settings might not be available. For details, see the printer's instruction manual.



## 1 Select the image to be printed.

- Check that the <☞> icon is displayed on the upper left of the LCD monitor.
- Press the <◀▶> key to select the image to be printed.

## 2 Press <SET>.

- ▶ The print setting screen will appear.

### Print setting screen

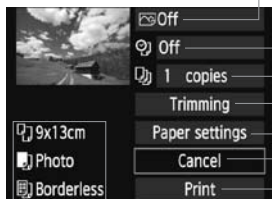

— Sets the printing effects (p.168).

— Sets the date or file number imprinting to on or off.

— Sets the quantity to be printed.

— Sets the trimming (p.171).

— Sets the paper size, type, and layout.

— Returns to step 1.

— Starts the printing.

The paper size, type, and layout you have set are displayed.

\* Depending on the printer, settings such as the date and file number imprinting and trimming might not be available.

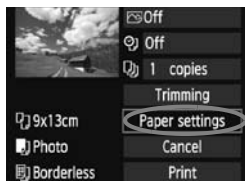

## 3 Select [Paper settings].

- Select [Paper settings], then press <SET>.
- ▶ The paper settings screen will appear.

## Setting the Paper Size

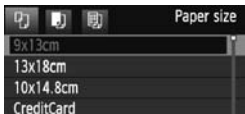

- Select the size of the paper loaded in the printer, then press **<SET>**.
- ▶ The paper type screen will appear.

## Setting the Paper Type

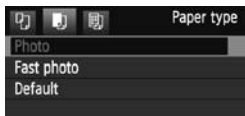

- Select the type of the paper loaded in the printer, then press **<SET>**.
- When using a Canon printer and Canon paper, read the printer's instruction manual to check what paper types can be used.
- ▶ The page layout screen will appear.

## Setting the Page Layout



- Select the page layout, then press **<SET>**.
- ▶ The print setting screen will reappear.

<b>Bordered</b>	The print will have white borders along the edges.
<b>Borderless</b>	The print will have no white borders. If your printer cannot print borderless prints, the print will have borders.
<b>Bordered [i]</b>	The shooting information* will be imprinted on the border on 9x13cm and larger prints.
<b>xx-up</b>	Option to print 2, 4, 8, 9, 16, or 20 images on one sheet.
<b>20-up [i]</b> <b>35-up [i]</b>	On A4 or Letter size paper, 20 or 35 thumbnails of the images ordered through DPOF (p.173) will be printed. • <b>[20-up [i]]</b> will have the shooting information* imprinted.
<b>Default</b>	The page layout will vary depending on the printer type or its settings.

\* From the Exif data, the camera name, lens name, shooting mode, shutter speed, aperture, exposure compensation amount, ISO speed, white balance, etc., will be imprinted.

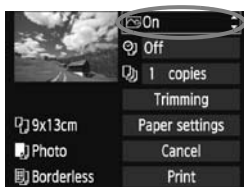

## 4 Set the printing effects.

- Set as necessary. If you need not set any printing effects, go to step 5.
- **The screen display may differ depending on the printer.**
- Select the option on the upper right, then press < **SET** >.
- Select the desired printing effect, then press < **SET** >.
- If the < **DISP.** > icon is displayed next to < **DISP.** >, you can also adjust the printing effect (p.170).

Function	Description
<b>On</b>	The image will be printed according to the printer's standard colors. The image's Exif data is used to make automatic corrections.
<b>Off</b>	No automatic correction will be performed.
<b>Vivid</b>	The image will be printed with higher saturation to produce more vivid blues and greens.
<b>NR</b>	The image noise is reduced before printing.
<b>B/W B/W</b>	Prints in black-and-white with true blacks.
<b>B/W Cool tone</b>	Prints in black-and-white with cool, bluish blacks.
<b>B/W Warm tone</b>	Prints in black-and-white with warm, yellowish blacks.
<b>Natural</b>	Prints the image in the actual colors and contrast. No automatic color adjustments will be applied.
<b>Natural M</b>	The printing characteristics are the same as the "Natural" setting. However, this setting enables finer printing adjustments than with "Natural."
<b>Default</b>	The printing will differ depending on the printer. For details, see the printer's instruction manual.

\* When you change the printing effects, it is reflected in the image displayed on the upper left. Note that the printed image might look slightly different from the displayed image which is only an approximation. This also applies to [Brightness] and [Adjust levels] on page 170.





## 5 Set the date and file number imprinting.

- Set as necessary.
- Select <[Both]>, then press <[SET]>.
- Set as desired, then press <[SET]>.

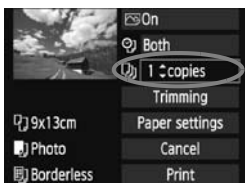

## 6 Set the number of copies.

- Set as necessary.
- Select <[1]>, then press <[SET]>.
- Set the number of copies, then press <[SET]>.



## 7 Start printing.

- Select [**Print**], then press <[SET]>.
- ▶ The <[Print]> button's blue lamp will blink and the printing will start.



- With Easy printing, you can print another image with the same settings. Just select the image and press the <[Print]> button lit in blue. With Easy printing, the number of copies will always be 1. (You cannot set the number of copies.) Also, any trimming (p.171) will not be applied.
- The [**Default**] setting for printing effects and other options are the printer's own default settings as set by the printer's manufacturer. See the printer's instruction manual to find out what the [**Default**] settings are.
- Depending on the image's file size and image-recording quality, it may take some time for the printing to start after you select [**Print**].
- If image tilt correction (p.171) has been applied, it will take longer to print the image.
- To stop the printing, press <[SET]> while [**Stop**] is displayed, then select [**OK**].
- If you execute [**Clear all camera settings**] (p.136), all the settings will revert to the default.

## Adjustment of Printing Effects

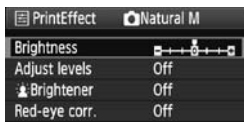
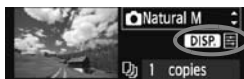

In step 4 on page 168, select the printing effect. When the  icon is displayed next to **<DISP.>**, press the **<DISP.>** button. You can then adjust the printing effect. What can be adjusted or what is displayed will depend on the selection made in step 4.

### ● Brightness

The image brightness can be adjusted.

### ● Adjust levels

When you select **[Manual]**, you can change the histogram's distribution and adjust the image's brightness and contrast.

With the Adjust levels screen displayed, press the **<DISP.>** button to change the position of the . Press the **<◀▶>** key to freely adjust the shadow level (0 - 127) or highlight level (128 - 255).



### ● Brightener

Effective in backlit conditions which can make the subject's face look dark. When **[On]** is set, the face will be brightened for printing.

### ● Red-eye corr.

Effective in flash images where the subject has red eye. When **[On]** is set, the red eye will be corrected for printing.



- The **[ Brightener]** and **[Red-eye corr.]** effects will not show on the screen.
- When you select **[Detail set.]**, you can adjust the **[Contrast]**, **[Saturation]**, **[Color tone]**, and **[Color balance]**. To adjust the **[Color balance]**, use the **<◊>** keys. B is for blue, A is amber, M is magenta, and G is green. The color in the respective direction will be corrected.
- If you select **[Clear all]**, all the printing effect settings will be reverted to the default.

## Trimming the Image



You can crop the image and print only the trimmed portion as if the image was recomposed. **Do the trimming right before printing.** If you set the trimming and then set the print settings, you may have to set the trimming again.

- 1 On the print setting screen, select [Trimming].
- 2 Set the trimming frame size, position, and aspect ratio.
  - The image area within the trimming frame will be printed. The trimming frame's aspect ratio can be changed with [Paper settings].

### Changing the trimming frame size

When you press the  $\langle \text{Q} \rangle$  or  $\langle \text{Q} \cdot \text{Q} \rangle$  button, the size of the trimming frame will change. The smaller the trimming frame, the larger the image magnification will be for printing.

### Moving the trimming frame

Press the  $\langle \text{D} \rangle$  key to move the frame over the image vertically or horizontally. Move the trimming frame until it covers the desired image area.

### Rotating the frame

Each time you press the  $\langle \text{DISP} \rangle$  button, the trimming frame will toggle between the vertical and horizontal orientations. This enables you to create a vertical-oriented print from a horizontal image.

### Image tilt correction

By turning the  $\langle \text{Dial} \rangle$ , you can adjust the image tilt angle up to  $\pm 10$  degrees in 0.5-degree increments. When you adjust the image tilt, the  $\langle \text{Dial} \rangle$  icon on the screen will turn blue.

- 3 Press  $\langle \text{SET} \rangle$  to exit the trimming.

- ▶ The print setting screen will reappear.
- You can check the trimmed image area on the upper left of the print setting screen.

- Depending on the printer, the trimmed image area might not be printed as you specified.
- The smaller you make the trimming frame, the grainier the picture will look on the print.
- While trimming the image, look at the camera's LCD monitor. If you look at the image on a TV screen, the trimming frame might not be displayed accurately.



### Handling Printer Errors

If you resolve a printer error (no ink, no paper, etc.) and select **[Continue]** to resume printing but it does not resume, operate the buttons on the printer to resume printing. For details, see the printer's instruction manual.

#### Error Messages

If a problem occurs during printing, an error message will appear on the camera's LCD monitor. Press <  > to stop printing. After fixing the problem, resume printing. For details on how to fix a printing problem, refer to the printer's instruction manual.

#### Paper Error

Check whether the paper is properly loaded in the printer.

#### Ink Error

Check the printer's ink level, and check the waste ink tank.

#### Hardware Error

Check for any printer problems other than paper and ink problems.

#### File Error

The selected image cannot be printed via PictBridge. Images taken with a different camera or images edited with a computer might not be printable.

# Digital Print Order Format (DPOF)

You can set the print type, date imprinting, and file No. imprinting. The print settings will be applied to all print-ordered images. (They cannot be set individually for each image.)

## Setting the Printing Options



### 1 Select [Print order].

- ▶ Under the [ ] tab, select [Print order], then press <SET>.



### 2 Select [Set up].

- Select [Set up], then press <SET>.

### 3 Set the option as desired.

- Set the [Print type], [Date], and [File No.].
- Select the option, then press <SET>. Select the setting, then press <SET>.

[Print type]

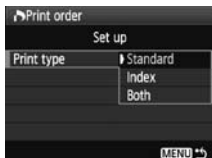

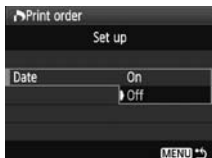

[Date]

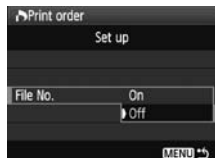

[File No.]



Print type	 Standard	Prints one image on one sheet.
	 Index	Multiple, thumbnail images are printed on one sheet.
	 Both	Prints both the standard and index prints.
Date	On	[On] imprints the recorded date on the print.
	Off	
File number	On	[On] imprints the file No. on the print.
	Off	

#### 4 Exit the setting.

- Press the <MENU> button.
- ▶ The print order screen will reappear.
- Next, select [**Sel.Image**] or [**All image**] to order the images to be printed.

- 
- Even if [**Date**] and [**File No.**] are set to [**On**], the date or file No. might not be imprinted depending on the print type setting and printer model.
  - When printing with DPOF, you must use the card whose print order specifications have been set. It will not work if you just extract images from the card and try to print them.
  - Certain DPOF-compatible printers and photofinishers might not be able to print the images as you specified. If this happens with your printer, refer to the printer's instruction manual. Or check with your photofinisher about compatibility when ordering prints.
  - Do not insert into the camera a card whose print order was set by a different camera and then try to specify a print order. The print order may not work or may be overwritten. Also, depending on the image type, the print order may not be possible.

- 
- RAW images and movies cannot be print ordered.
  - With [**Index**] prints, both the [**Date**] and [**File No.**] cannot be set to [**On**] at the same time.

## Print Ordering

### ● Sel.Image

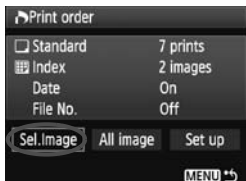

Select and order images one by one. Press the **< [Image] - Q >** button to display the three-image view. To return to the single-image display, press the **< Q >** button. After completing the print order, press the **< MENU >** button to save the print order to the card.



### [Standard] [Both]

Press the **< ▲ ▼ >** key to set the number of copies to be printed for the displayed image.



### [Index]

Press the **< ▲ ▼ >** key to checkmark the box **< ✓ >** and the image will be included in the index print.

### ● All image

If you select **[Mark all on card]**, one copy of all the images in the card will be set for printing. If you select **[Clear all on card]**, the print order will be cleared for all the images in the card.



- If you select "All image", RAW images and movies will not be included in the print order.
- When using a PictBridge printer, print no more than 400 images for one print order. If you specify more than this, all the images might not be printed.

# Direct Printing with DPOF



With a PictBridge printer, you can easily print images with DPOF.

## 1 Preparing to print.

- See page 164. Follow the “Connecting the Camera to a Printer” procedure up to step 5.

## 2 Under the [P] tab, select [Print order].

## 3 Select [Print].

- [Print] will be displayed only if the camera is connected to the printer and printing is possible.

## 4 Set the [Paper settings]. (p.166)

- Set the printing effects (p.168) if necessary.

## 5 Select [OK].

- Before printing, be sure to set the paper size.
- Certain printers cannot imprint the file No.
- If [Bordered] is set, the date might be imprinted on the border, depending on the printer.
- Depending on the printer, the date might look light if it is imprinted on a bright background or on the border.

- Under [Adjust levels], [Manual] cannot be selected.
- If you stopped the printing and want to resume printing the remaining images, select [Resume]. Note that printing will not resume if you stop the printing and any of the following occurs:
  - Before resuming the printing, you changed the print order or deleted print-ordered images.
  - When you set the index, you changed the paper setting before resuming the printing.
  - When you paused the printing, the card's remaining capacity was low.
- If a problem occurs during printing, see page 172.





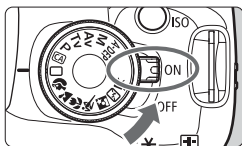

## 4 Set the camera's power switch to <ON>.

- When the program selection dialog window appears on the computer, select **[EOS Utility]**.
- ▶ The **[EOS Utility]** window will appear on the computer, and the direct image transfer screen will appear on the camera's LCD monitor.

- If the **[EOS Utility]** window does not appear automatically, startup EOS Utility manually.
- Before disconnecting the cable, turn off the camera. Pull out the cable by grasping the plug (instead of the cord).

## Transferring Images to a Computer

The images sent to the computer will be saved in the **[My Pictures]** folder or **[Pictures]** folder in subfolders organized according to the shooting date.

### ● All images

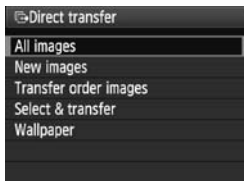

This is to transfer all the images in the card to the computer.

- Select **[All Images]**, then press the <⏏> button.
- ▶ The <⏏> button's blue lamp will blink and the image transfer will start.
- ▶ When the image transfer is completed, the lamp will stay on.

- Since movie files are larger than still photo files, they will take longer to transfer.
- During the file transfer, do not disconnect the cable.
- Shooting will be disabled while the direct transfer screen is displayed.

Options other than **[All images]** are explained below. To start the image transfer, press the <  > button.

- **New images**

Images which have not yet been transferred to the computer will be selected by the camera automatically and transferred.

- **Transfer order images**

You select the images and they are transferred to the computer in a batch. To select the images, see page 180.

- **Select & transfer**



You select the images to be transferred individually. To exit, press the <MENU> button.

- **Wallpaper**

The image you select and transfer will appear as the computer's wallpaper. To exit, press the <MENU> button.



- If you press <SET> instead of the <  > button, a confirmation dialog will appear. Select [OK], then press <SET> to start the transfer.
- RAW images and movies cannot be transferred as wallpaper.

## MENU Selecting the Images to be Transferred



Under the [MENU] tab, you can use [Transfer order] to select the images to be transferred to a computer.

When you select [Transfer order images] on page 179, you can transfer the images set by the transfer order.

### ● Sel. Image



Select and order images one by one. Press the <▲▼> key to include the displayed image in the transfer order. The <✓> mark will also appear on the upper left.

After completing the transfer order, press the <MENU> button to save the transfer order to the card.

### ● All image

If you select [Mark all on card], all the images in the card will be in the transfer order. If you select [Clear all on card], the transfer order will be cleared for all the images in the card.

⚠ Do not put into the camera any images whose transfer order was set by a different camera and then try to specify another transfer order. The images in the transfer order might all be overwritten. Also, depending on the image type, the transfer order may not be possible.

- For the transfer order, if you select an image captured in the RAW+L mode, it will be counted as one image. During the direct image transfer, both the RAW and JPEG images will be transferred to the computer.
- If you want to transfer more than 999 images in one batch, select [All images] on the direct transfer screen (p.178).

# 10

## Customizing the Camera

You can customize various camera features to suit your picture-taking preferences. You can do it with Custom Functions. Custom Functions can be set and used only in Creative Zone modes.

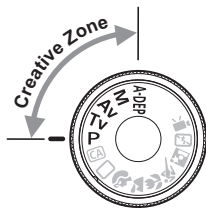

## MENU Setting Custom Functions ☆

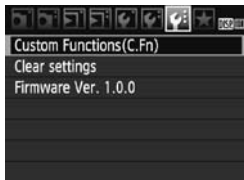

### 1 Select [Custom Functions (C.Fn)].

- Under the [☛] tab, select [Custom Functions (C.Fn)], then press <SET>.

Custom Function No.

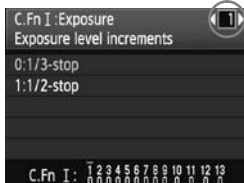

### 2 Select the Custom Function number.

- Press the <◀▶> key to select the Custom Function No., then press <SET>.

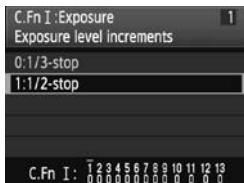

### 3 Change the setting as desired.

- Press the <▲▼> key to select the setting (number), then press <SET>.
- Repeat steps 2 and 3 if you want to set other Custom Functions.
- At the bottom of the screen, the current Custom Function settings are indicated below the respective function numbers.

### 4 Exit the setting.



- Press the <MENU> button.
- ▶ The screen for step 1 will reappear.

## Clearing All Custom Functions

On the [☛: Clear settings] menu, select [Clear all Custom Func. (C.Fn)] to clear all the Custom Function settings (p.136).

## Custom Functions

### C.Fn I: Exposure

			 LV shooting	 Movie shooting
1	Exposure level increments	p.184	<input type="radio"/>	
2	ISO expansion		<input type="radio"/>	
3	Flash sync. speed in Av mode		<input type="radio"/>	

### C.Fn II: Image

4	Long exposure noise reduction	p.185	<input type="radio"/>	
5	High ISO speed noise reduction		<input type="radio"/>	
6	Highlight tone priority	p.186	<input type="radio"/>	
7	Auto Lighting Optimizer		<input type="radio"/>	(0 works)

### C.Fn III: Autofocus/Drive

8	AF-assist beam firing	p.187	<input type="radio"/>	
9	Mirror lockup			

### C.Fn IV: Operation/Others

10	Shutter/AE lock button	p.188	(1 works)	
11	Assign SET button		(0 works)	
12	LCD display when power ON	p.189	<input type="radio"/>	
13	Add original decision data		<input type="radio"/>	



The shaded Custom Functions do not function during Live View (Live View shooting) and/or movie shooting. (Settings are disabled.)

## MENU Custom Function Settings ☆

Custom Functions are organized into four groups based on the function type: C.Fn I: Exposure, C.Fn II: Image, C.Fn III: Auto focus/Drive, C.Fn IV: Operation/Others.

### C.Fn I: Exposure

#### C.Fn-1 Exposure level increments

**0: 1/3-stop**

**1: 1/2-stop**

Sets 1/2-stop increments for the shutter speed, aperture, exposure compensation, AEB, flash exposure compensation, etc. Effective when you prefer to control the exposure in less fine increments than 1/3-stop increments.

 The exposure level will be displayed in the viewfinder and on the LCD monitor as shown below.



#### C.Fn-2 ISO expansion

**0: Off**

**1: On**

Enables ISO 6400 and H (equivalent to ISO 12800) to be set.

#### C.Fn-3 Flash sync. speed in Av (Aperture-priority AE) mode

**0: Auto**

The flash sync speed is set automatically within a range of 1/200 sec. to 30 sec. to suit the scene's brightness.

**1: 1/200-1/60 sec. auto**

When flash is used with aperture-priority AE (**Av**), this prevents a slow flash-sync speed from being set automatically in low-light conditions. It is effective for preventing subject blur and camera shake. However, while the subject will be properly exposed with the flash, the background will come out dark.

**2: 1/200 sec. (fixed)**

The flash-sync speed is fixed to 1/200 sec. This more effectively prevents subject blur and camera shake than with setting 1. However, the background will come out darker than with setting 1.



## C.Fn II: Image

### C.Fn-4 Long exposure noise reduction

**0: Off**

**1: Auto**

For 1 sec. or longer exposures, noise reduction is performed automatically if noise typical of long exposures is detected. This **[Auto]** setting is effective in most cases.

**2: On**

Noise reduction is performed for all exposures of 1 sec. or longer. The **[On]** setting may be effective for noise that cannot be detected or reduced with the **[Auto]** setting.



- After the picture is taken, the noise reduction process may take the same amount of time as the exposure. You cannot take another picture until the noise reduction process is completed.
- At ISO 1600 and higher, noise might be more pronounced at the 2 setting than at the 0 or 1 setting.
- With setting 2, if a long exposure is used during Live View shooting, "BUSY" will be displayed and the Live View display will not appear until the noise reduction process is completed. (You cannot take another picture.)

### C.Fn-5 High ISO speed noise reduction

Reduces the noise generated in the image. Although noise reduction is applied at all ISO speeds, it is particularly effective at high ISO speeds. At low ISO speeds, the noise in the shadow areas is further reduced. Change the setting to suit the noise level.

**0: Standard**

**1: Low**

**2: Strong**

**3: Disable**



With setting 2, the maximum burst for continuous shooting will decrease.

## C.Fn-6 Highlight tone priority

**0: Disable**

**1: Enable**

Improves the highlight detail. The dynamic range is expanded from the standard 18% gray to bright highlights. The gradation between the grays and highlights becomes smoother.

⚠ With setting 1, noise in the shadow areas may be slightly more than usual.

📄 With setting 1, the settable ISO speed range will be 200 - 3200. Also, the <D+> icon will be displayed on the LCD monitor and in the viewfinder when highlight tone priority is enabled.

## C.Fn-7 Auto Lighting Optimizer

If the images comes out dark or the contrast is low, the brightness and contrast are corrected automatically.

The settings made with the camera can be reflected in RAW images when the images are processed with Digital Photo Professional (provided software).

**0: Standard**

**1: Low**

**2: Strong**

**3: Disable**



⚠

- Depending on the shooting conditions, noise might increase.
- This function will not work if manual exposure or bulb exposure has been set.

📄 In the Basic Zone modes, [**Standard**] is set automatically.

## C.Fn III: Autofocus/Drive

### C.Fn-8 AF-assist beam firing

The AF-assist beam can be emitted by the camera's built-in flash or by the external, EOS-dedicated Speedlite.

**0: Enable**

**1: Disable**

The AF-assist beam is not emitted.

**2: Only external flash emits**

If an external, EOS-dedicated Speedlite is attached, it will emit the AF-assist beam when necessary. The camera's built-in flash will not fire the AF-assist beam.



If the external, EOS-dedicated Speedlite's **[AF-assist beam firing]** Custom Function is set to **[Disabled]**, the Speedlite will not emit the AF-assist beam even if the camera's C.Fn-8-0/2 is set.

### C.Fn-9 Mirror lockup

**0: Disable**

**1: Enable**

Prevents camera vibrations caused by the reflex mirror action which can disturb shooting with super telephoto lenses or close-up (macro) shooting. See page 104 for the mirror lockup procedure.

## C.Fn IV: Operation/Others

### C.Fn-10 Shutter/AE lock button

#### 0: AF/AE lock

#### 1: AE lock/AF

Convenient when you want to focus and meter separately. Press the <★> button to autofocus and press the shutter button halfway to perform AE lock.

#### 2: AF/AF lock, no AE lock

In the AI Servo AF mode, you can press the <★> button to stop the AF operation momentarily. This prevents the AF from being thrown off by any obstacle passing between the camera and subject. The exposure is set at the moment the picture is taken.

#### 3: AE/AF, no AE lock

This is useful for subjects which keep moving and stopping repeatedly. In the AI Servo AF mode, you can press the <★> button to start or stop the AI Servo AF operation. The exposure is set at the moment the picture is taken. Thus, the optimum focusing and exposure will always be achieved as you wait for the decisive moment.

### C.Fn-11 Assign SET button

You can assign a frequently-used function to <SET>. When the camera is ready to shoot, you can press <SET>.

#### 0: Quick Control screen

When you press <SET>, the Quick Control screen will appear. Press the <⬅➡> key to select the desired function, then turn the <🌀> dial to set it.

#### 1: Image quality

Press <SET> to display the image-recording quality setting screen on the LCD monitor.

Press the <⬅➡> key to select the image-recording quality, then press <SET>.

#### 2: Flash exposure compensation

When you press <SET>, the flash exposure compensation setting screen will appear.

#### 3: LCD monitor On/Off

Assigns the same function as the <DISP.> button.

#### 4: Menu display

Assigns the same function as the <MENU> button.

#### 5: Disabled

**C.Fn-12 LCD display when power ON****0: Display**

When the power switch is turned on, the shooting settings will be displayed (p.42).

**1: Retain power OFF status**

If you pressed the <DISP.> button and turned off the camera while the LCD monitor was off, the shooting settings will not be displayed when you turn on the camera again. This helps to save battery power. The menu screens and image playback will still be displayed when used. If you pressed the <DISP.> button and turned off the camera while the LCD monitor was on, the shooting settings will be displayed when you turn on the camera again.

**C.Fn-13 Add original decision data****0: Off****1: On**

Data for verifying whether the image is original or not is appended to the image automatically. When the shooting information of an image appended with the verification data is displayed (p.161), the <> icon will appear.

To verify whether the image is original, the Original Data Security Kit OSK-E3 (sold separately) is required.



The images are not compatible with the image encryption/decryption features of Original Data Security Kit OSK-E3.

## MENU Registering My Menu ☆

Under the My Menu tab, you can register up to six menu options and Custom Functions whose settings you change frequently.

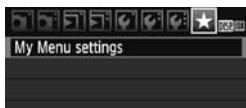

- 1 **Select [My Menu settings].**
  - Under the [★] tab, select [My Menu settings], then press <SET>.

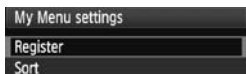

- 2 **Select [Register].**
  - Select [Register], then press <SET>.

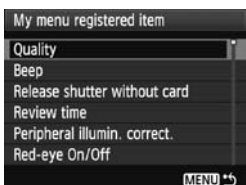

- 3 **Register the desired items.**
  - Select the item, then press <SET>.
  - On the confirmation dialog, select [OK] and press <SET> to register the menu item.
  - You can register up to six items in My Menu.
  - To return to the screen in step 2, press the <MENU> button.

### About My Menu settings

- **Sort**

You can change the order of the registered menu items in My Menu. Select [Sort] and select the menu item whose order you want to change. Then press <SET>. With [◆] displayed, press the <▲▼> key to change the order, then press <SET>.
- **Delete / Delete all items**

Deletes the registered menu items. [Delete] deletes one menu item at a time, and [Delete all items] deletes all menu items.
- **Display from My Menu**

When [Enable] is set, the [★] tab will be displayed first when you display the menu screen.

# 11

## Reference

This chapter provides reference information for camera features, system accessories, etc. The back of this chapter also has an index to make it easier to look up needed information.

## When Autofocus Fails

Autofocus can fail to achieve focus (the focus confirmation light <●> blinks) with certain subjects such as the following:



### Subjects difficult to focus

- Low-contrast subjects  
(Example: Blue sky, solid-color walls, etc.)
- Subjects in low light
- Extremely backlit or reflective subjects  
(Example: Car with a reflective body, etc.)
- Near and far subjects covered by an AF point  
(Example: Animal in a cage, etc.)
- Repetitive patterns  
(Example: Skyscraper windows, computer keyboards, etc.)

In such cases, do one of the following:

- (1) With One-Shot AF, focus an object at the same distance as the subject and lock the focus before recomposing (p.46).
- (2) Set the lens focus mode switch to <MF> and focus manually.



- If an Extender (sold separately) is attached and the maximum aperture of the lens is f/5.6 or smaller (larger f/number), AF will not be possible (except Live mode/ Live mode AF). For details, see the Extender's instruction manual.
- For the situations where AF can fail to achieve focus with Live mode/ Live mode AF, see page 115.



# Using a Household Power Outlet

With AC Adapter Kit ACK-E5 (sold separately), you can connect the camera to a household power outlet and not worry about the battery level.

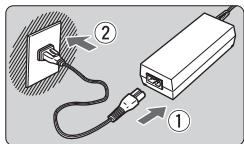

## 1 Connect the power cord.

- Connect the power cord as shown in the illustration.
- After using the camera, unplug the power plug from the power outlet.

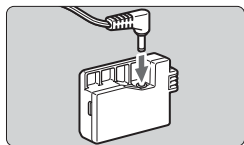

## 2 Connect the DC Coupler.

- Connect the cord's plug to the DC Coupler.

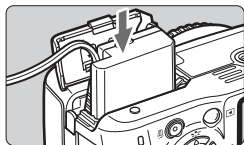

## 3 Insert the DC Coupler.

- Open the cover and insert the DC Coupler until it locks in place.

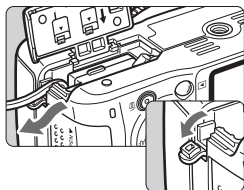

## 4 Push in the DC cord.

- Open the DC cord hole cover and install the cord as shown.
- Close the cover.



Do not connect or disconnect the power cord while the camera's power switch is set to <ON>.

# Remote Control Shooting

## Remote Controller RC-1/RC-5 (Sold separately)

Remote controllers to shoot wirelessly up to about 5 meters/16.4 feet from the camera. The RC-1 can trip the shutter immediately or after a 2-sec. delay, and the RC-5 trips the shutter after a 2-sec. delay.



RC-1



RC-5

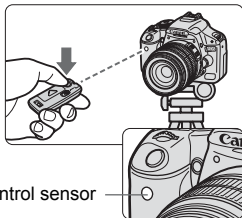

- Set the drive mode to  $\langle \text{☺} \bar{i} \rangle$  (p.55).
- Point the remote controller toward the camera's remote control sensor and press the transmit button.
- ▶ The camera will autofocus.
- ▶ When focus is achieved, the self-timer lamp will light and the picture will be taken.

 Camera misoperation may occur near certain types of fluorescent lights. During wireless remote control, try to keep the camera away from fluorescent light.

## Remote Switch RS-60E3 (Sold separately)

Remote switch with a 60 cm/2.0 feet cord for pressing the shutter button halfway or completely. It connects to the camera's remote control terminal.

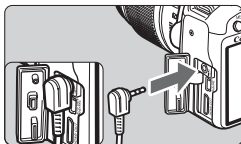

## Using the Eyepiece Cover

If you take a picture without looking at the viewfinder, light entering the eyepiece can throw off the exposure. To prevent this, use the eyepiece cover (p.23) attached to the camera strap.

**During Live View shooting and movie shooting, attaching the eyepiece cover is unnecessary.**

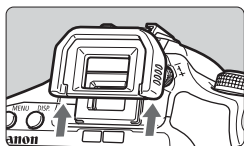

### 1 Remove the eyecup.

- Push the bottom of the eyecup upward.

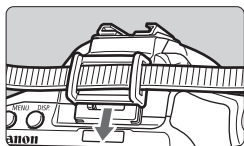

### 2 Attaching the eyepiece cover.

- Slide the eyepiece cover down into the eyepiece groove to attach it.

# External Speedlites

## EOS-dedicated, EX-series Speedlites

**Basically operates like a built-in flash for easy operation.**

When an EX-series Speedlite (sold separately) is attached to the camera, almost all the autoflash control is done by the camera. In other words, it is like a high-output flash attached externally in place of the built-in flash.



**For detailed instructions, see the EX-series Speedlite's instruction manual.** This camera is a Type-A camera that can use all the features of EX-series Speedlites.



Shoe-mount Speedlites



Macro Lites

- With an EX-series Speedlite not controllable by the camera, only [**Flash exp. comp**] and [**E-TTL II**] can be settable for [**External flash func. setting**] (p.139).  
(Certain EX-series Speedlites also enable [**Shutter sync.**] to be set.)
- If flash exposure compensation is set with the external Speedlite, the flash exposure compensation icon displayed on the camera's LCD monitor will change from  to .
- When the flash metering mode is set to TTL autoflash with the flash's Custom Function, the flash will fire at full output only.

## Canon Speedlites other than the EX-series

- **With an EZ/E/EG/ML/TL-series Speedlite set in TTL or A-TTL autoflash mode, the flash can be fired at full output only.** Set the camera's shooting mode to <M> (manual exposure) or <Av> (aperture-priority AE) and adjust the aperture setting before shooting.
- When using a Speedlite which has manual flash mode, shoot in the manual flash mode.

## Using Non-Canon Flash Units

### Sync Speed

The camera can synchronize with compact, non-Canon flash units at 1/200 sec. or slower. Be sure to test the flash unit beforehand to make sure it synchronizes properly with the camera.

### Cautions for Live View shooting

A non-Canon flash will not fire during Live View shooting.



- If the camera is used with a flash unit or flash accessory dedicated to another camera brand, the camera may not operate properly and malfunction may result.
- Do not attach a high-voltage flash unit on the camera's hot shoe. It might not fire.

# Function Availability Table

● : Set automatically ○ : User selectable □ : Not selectable

Mode Dial		Basic Zone							Creative Zone					Movie shooting	
		□							CA	P	Tv	Av	M	A-DEP	
Quality	JPEG	○	○	○	○	○	○	○	○	○	○	○	○	○	○
	RAW	○	○	○	○	○	○	○	○	○	○	○	○	○	○
	RAW +	○	○	○	○	○	○	○	○	○	○	○	○	○	○
ISO speed	Auto	●	●	●	●	●	●	●	○	○	○	○	○	○	●
	Manual	□	□	□	□	□	□	□	○	○	○	○	○	○	□
Picture Style	Standard	●	□	□	●	●	●	●	○	○	○	○	○	○	○
	Portrait	□	●	□	□	□	□	□	○	○	○	○	○	○	○
	Landscape	□	□	●	□	□	□	□	○	○	○	○	○	○	○
	Neutral	□	□	□	□	□	□	□	○	○	○	○	○	○	○
	Faithful	□	□	□	□	□	□	□	○	○	○	○	○	○	○
	Monochrome	□	□	□	□	□	□	□	○	○	○	○	○	○	○
	User Defined	□	□	□	□	□	□	□	○	○	○	○	○	○	○
White balance	Auto WB	●	●	●	●	●	●	●	○	○	○	○	○	○	○
	Preset WB	□	□	□	□	□	□	□	○	○	○	○	○	○	○
	Custom WB	□	□	□	□	□	□	□	○	○	○	○	○	○	○
	WB correction	□	□	□	□	□	□	□	○	○	○	○	○	○	□
	WB bracketing	□	□	□	□	□	□	□	○	○	○	○	○	○	□
Auto Lighting Optimizer		●	●	●	●	●	●	●	○	○	○	□	○	●	
Peripheral illumination correction		○	○	○	○	○	○	○	○	○	○	○	○	○	○
Long exposure noise reduction		●	●	●	●	●	●	●	○	○	○	○	○	○	●
AF	One-Shot	□	●	●	●	□	●	□	○	○	○	○	●	●	
	AI Servo	□	□	□	□	●	□	□	○	○	○	○	□	□	
	AI Focus	●	□	□	□	□	□	●	○	○	○	○	□	□	
	AF point selection	Auto	●	●	●	●	●	●	●	○	○	○	○	●	○
		Manual	□	□	□	□	□	□	□	○	○	○	○	□	○
AF-assist beam		●	●	□	●	□	●	□	○	○	○	○	○	□	

●: Set automatically ○: User selectable □: Not selectable

Mode Dial		Basic Zone							Creative Zone					Movie shooting	
									CA	P	Tv	Av	M	A-DEP	
Metering mode	Evaluative	●	●	●	●	●	●	●	●	○	○	○	○	○	
	Partial									○	○	○	○	○	
	Spot									○	○	○	○	○	
	Center-weighted average									○	○	○	○	○	
Exposure	Program shift								○*1	○					
	Exposure compensation								○*2	○	○	○		○	○
	AEB									○	○	○	○	○	
	AE lock									○	○	○		○	
	Depth-of-field preview									○	○	○	○	○	
Drive	Single	●		●	●		●	●	○	○	○	○	○	○	●
	Continuous		●			●			○	○	○	○	○	○	
	Self-timer/Remote control	○	○	○	○	○	○	○	○	○	○	○	○	○	○*3
	Self-timer:2 sec									○	○	○	○	○	
	Self-timer:Continuous	○	○	○	○	○	○	○	○	○	○	○	○	○	
Built-in flash	Auto	●	●		●		●		○						
	Manual								○	○	○	○	○	○	
	Flash off			●		●		●	○						●
	Red-eye reduction	○	○		○		○		○	○	○	○	○	○	
	FE lock									○	○	○	○	○	
	Flash exposure compensation								○*2	○	○	○	○	○	
Color space	sRGB	●	●	●	●	●	●	●	●	○	○	○	○	○	●
	Adobe RGB									○	○	○	○	○	
Live View shooting										○	○	○	○	○	●

\*1: Refers to "(2) Blurring/sharpening the background" function on page 54.

\*2: Refers to "(3) Adjusting the picture brightness" function on page 54.

\*3: On the movie shooting mode menu, **[Remote control]** can be set.

# Menu Settings

## ☑ Shooting 1 (Red)

Page

Quality	L /  M /  S /  RAW +  L /  RAW	70
Beep	On / Off	130
Release shutter without card	Enable / Disable	130
Review time	Off / 2 sec. / 4 sec. / 8 sec. / Hold	130
Peripheral illumination correction	Enable / Disable	100
Red-eye On/Off	Off / On	63
Flash control	Flash firing / Built-in flash function setting / External flash function setting / External flash C.Fn setting / Clear external flash C.Fn setting	139

## ☑ Shooting 2 (Red)

Exposure compensation/AEB	1/3-stop increments, ±2 stops	86
Metering mode	/  /  /	83
Custom WB	Manual setting of white balance	96
WB SHIFT/BKT	WB correction: White balance correction	98
	WB-BKT: White balance bracketing	99
Color space	sRGB / Adobe RGB	93
Picture Style	Standard /  Portrait /  Landscape /	73
	Neutral /  Faithful /  Monochrome /	88
	User Def. 1, 2, 3	91
Dust Delete Data	Obtains data to be used to erase dust spots	143

## ☑ Playback 1 (Blue)

Protect images	Erase-protect images	158
Rotate	Rotate vertical images	151
Erase images	Erase images	159
Print order	Specifies images to be printed (DPOF)	173
Transfer order	Select images to be transferred to a computer	180

- The [☑] Shooting 2, [☑] Set-up 3, and [★] My Menu screens (tabs) are not displayed in Basic Zone modes.
- Shaded menu items are not displayed in Basic Zone modes.





## ▢ Playback 2 (Blue)

Page

<b>Histogram</b>	Brightness / RGB	162
<b>Slide show</b>	Select the images, set the Play time and repeat settings for automatic playback	154
<b>Image jump w/ </b>	1 image / 10 images / 100 images / Date / Movies / Stills	149

## ⚡ Set-up 1 (Yellow)

<b>Auto power off</b>	30 sec. / 1min. / 2 min. / 4 min. / 8 min. / 15 min. / Off	131
<b>File numbering</b>	Continuous / Auto reset / Manual reset	132
<b>Auto rotate</b>	On  / On  / Off	134
<b>Format</b>	Initialize and erase data in the card	40
<b>LCD auto off</b>	Enable / Disable	138
<b>Screen color</b>	Select the background color	138

## ⚡ Set-up 2 (Yellow)

<b>LCD brightness</b>	Seven brightness levels provided	131
<b>Date/Time</b>	Set the date (year, month, day) and time (hour, min., sec.)	29
<b>Language </b>	Select the interface language	30
<b>Video system</b>	NTSC / PAL	156
<b>Sensor cleaning</b>	Auto cleaning: Enable / Disable	142
	Clean now	
	Clean manually	145
<b>Live View function settings</b>	Live View shooting / AF mode / Grid display / Metering timer	106

## ⚡ Set-up 3 (Yellow)

<b>Custom Functions (C.Fn)</b>	Customize the camera as desired	182
<b>Clear settings</b>	Clear all camera settings / Clear all Custom Func. (C.Fn) / Delete copyright information	136
<b>Firmware Ver.</b>	For updating the firmware	–



## ★ My Menu (Green)

<b>My Menu settings</b>	Register frequently-used menu items and Custom Functions	190
-------------------------	--	-----









## Movie Shooting Mode Menu

### Movie (Red)

Page

<b>Grid display</b>	Off / Grid 1  / Grid 2 	124
<b>Metering timer</b>	4 sec. / 16 sec. / 30 sec. / 1 min. / 10 min. / 30 min.	124
<b>Movie recording size</b>	1920x1080 / 1280x720 / 640x480	123
<b>AF mode</b>	Live mode /  Live mode / Quick mode	123
<b>Sound recording</b>	On / Off	124
<b>Remote control</b>	Disable / Enable	124

### About the menu screen during the movie shooting mode

- The [] screen (tab) is displayed only when the movie shooting mode is set.
- The [] Set-up 3 and [] My Menu screens (tabs) will not be displayed.
- Under the [] tab, the [**Expo. comp./AEB**] item will become [**Exposure comp.**].
- The following menu items will not be displayed:
  - []: Red-eye On/Off, Flash control
  - []: Metering mode, WB SHIFT/BKT, Color space, Dust Delete Data
  - []: LCD auto off, Screen color
  - []: Sensor cleaning, Live View function settings

# Troubleshooting Guide

If a problem occurs, first refer to this Troubleshooting Guide. If this Troubleshooting Guide does not resolve the problem, contact your dealer or nearest Canon Service Center.

## Power-Related Problems

### The battery cannot be recharged with the battery charger provided.

- Do not recharge any battery pack other than genuine Canon Battery Pack LP-E5.

### The camera does not operate even when the power switch is set to <ON>.

- The battery is not properly installed in the camera (p.26).
- Recharge the battery (p.24).
- Make sure the battery compartment cover is closed (p.26).
- Make sure the card slot cover is closed (p.31).
- Press the <DISP.> button (p.42).

### The access lamp still blinks even when the power switch is set to <OFF>.

- If the power is cut off while an image is being recorded to the card, the access lamp will light/blink for a few sec. When the image recording is completed, the power will turn off automatically.

### The battery becomes exhausted quickly.

- Use a fully-charged battery (p.24).
- The rechargeable battery will degrade after repeated use. Purchase a new one.
- If you use Live View shooting or shoot movies for a prolonged period (p.105, 121), the number of possible shots will decrease.

### The camera turns off by itself.

- Auto power off is in effect. If you do not want auto power off to take effect, set [**☺** **Auto power off**] to [**Off**].
- Even if [**☺** **Auto power off**] has been set to [**Off**], the LCD monitor will still turn off after the camera is idle for 30 min. Press the <DISP.> button to turn on the LCD monitor.

## Shooting-Related Problems

### No images can be shot or recorded.

- The card is not properly inserted (p.31).
- If the card is full, replace the card or delete unnecessary images to make room (p.31, 159).
- If you try to focus in One-Shot AF mode while the focus confirmation light <●> in the viewfinder blinks, a picture cannot be taken. Press the shutter button halfway again to focus, or focus manually (p.37, 67).
- Slide the card's write-protect switch to the Write/Erase setting (p.31).

### The image is out of focus.

- Set the lens focus mode switch to <AF> (p.33).
- To prevent camera shake, hold the camera still and press the shutter button gently (p.36, 37).
- If the lens has an Image Stabilizer, set the IS switch to <ON>.

### The card cannot be used.

- If a card error message is displayed, see page 40 or 209.

**The maximum burst during continuous shooting is lower.**

- Set the [**F**: **Custom Functions (C.Fn)**] menu's [**High ISO speed noise reduction**] to [**Standard**], [**Low**], or [**Disable**]. If it is set to [**Strong**], the maximum burst during continuous shooting will decrease (p.185).
- If you shoot a subject which has fine detail (field of grass, etc.), the file size will be larger and the actual maximum burst will be lower than the number mentioned on page 70.

**ISO 100 cannot be set.**

- Under the [**F**: **Custom Functions (C.Fn)**] menu, if [**Highlight tone priority**] is set to [**Enable**], ISO 100 cannot be set. When [**Disable**] is set, ISO 100 can be set (p.186).

**When I use the <Av> mode with flash, the shutter speed becomes slow.**

- If you shoot night scenes, the shutter speed becomes slow automatically (slow-sync shooting) so that both the subject and background are properly exposed. If you do not want a slow shutter speed to be set, set the [**F**: **Custom Functions (C.Fn)**] menu's [**Flash sync. speed in Av mode**] to 1 or 2 (p.184).

**The built-in flash does not fire.**

- If you shoot continuously with the built-in flash at short intervals, the flash might stop operating to protect the flash unit.

### **The camera makes a noise when it is shaken.**

- The built-in flash's pop-up mechanism moves slightly. This is normal.

### **The shutter makes two shooting sounds during Live View shooting.**

- If you use flash or if ISO 3200 or higher is set, the shutter will make two sounds each time you shoot (p.107).

### **The movie shooting terminates by itself.**

- If the card's writing speed is slow, movie shooting may stop automatically. Use an SD Speed Class 6 "CLASS 6" or faster card. To find out the card's read/write speed, see the card manufacturer's Web site.
- If the movie file size reaches 4 GB or if the movie recording time reaches 29 min. 59 sec., movie shooting will stop automatically.

### **The 1920x1080 movie looks distorted.**

- When shooting movies at 1920x1080 with this camera, only 20 frames are recorded per second (20 fps). Therefore, if there is fast movement in the movie scene, the picture might look distorted. This distortion will be resolved if you shoot at the 1280x720 recording size (p.123).

### **When the movie is played, camera operation noise can be heard.**

- If you operate the camera's dial or lens during movie shooting, the respective operation noise will also be recorded (p.127).

## Display & Operation Problems

### The LCD monitor does not display a clear image.

- If dust is adhering to the LCD monitor, wipe its surface with a lens cloth or soft cloth.
- In low or high temperatures, the LCD monitor display may seem slow or might look black. It will return to normal at room temperature.

### Few tabs and options are displayed on the menu screen.

- In the Basic Zone modes and movie shooting mode, certain tabs and menu options are not displayed. Set the shooting mode to a Creative Zone mode (p.38).

### The image cannot be erased.

- If the image has been protected, it cannot be erased (p.158).

### The file name's first character is an underscore (“\_MG\_”).

- Set the color space to sRGB. If Adobe RGB is set, the first character will be an underscore (p.93).

### The file numbering does not start from 0001.

- If you use a card which already has images recorded, the file numbering might start from the last image in the card (p.132).

### **The shooting date and time displayed is incorrect.**

- The correct date and time has not been set (p.29).

### **No image appears on the TV screen.**

- Make sure the AV cable or HDMI cable's plug is connected all the way in (p.156, 157).
- Set the video OUT format (NTSC/PAL) to the same video format as the TV (p.201).
- Use the AV cable that came with the camera (p.156).

## **Printing-Related Problems**

### **There are fewer printing effects than listed in the instruction manual.**

- What the screen will display may differ depending on the printer. This instruction manual lists all the printing effects available (p.168).



# Error Codes

Error No. If there is a problem with the camera, an error message will appear. Follow the on-screen instructions.

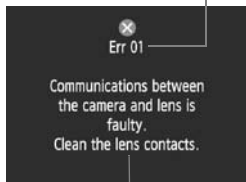

Countermeasures

No.	Error Message & Solution
01	<b>Communications between the camera and lens is faulty. Clean the lens contacts.</b>
	→ Clean the electrical contacts on the camera and lens and use a Canon lens. (p.13, 16)
02	<b>Card cannot be accessed. Reinsert/change card or format card with camera.</b>
	→ Remove and install the card again, replace the card, or format the card (p.31, 40).
04	<b>Cannot save images because card is full. Replace card.</b>
	→ Replace the card, erase unnecessary images, or format the card (p.31, 159, 40).
05	<b>The built-in flash could not be raised. Turn the camera off and on again.</b>
	→ Power switch operation (p.27).
06	<b>Sensor cleaning is not possible. Turn the camera off and on again.</b>
	→ Power switch operation (p.27).
10, 20, 30, 40, 50, 60, 70, 80	<b>Shooting is not possible due to an error. Turn the camera off and on again.</b>
	→ Operate the power switch, remove and install the battery again, or use a Canon lens (p.27, 26).

\* If the error still persists, write down the error No. and contact your nearest Canon Service Center.

# System Map

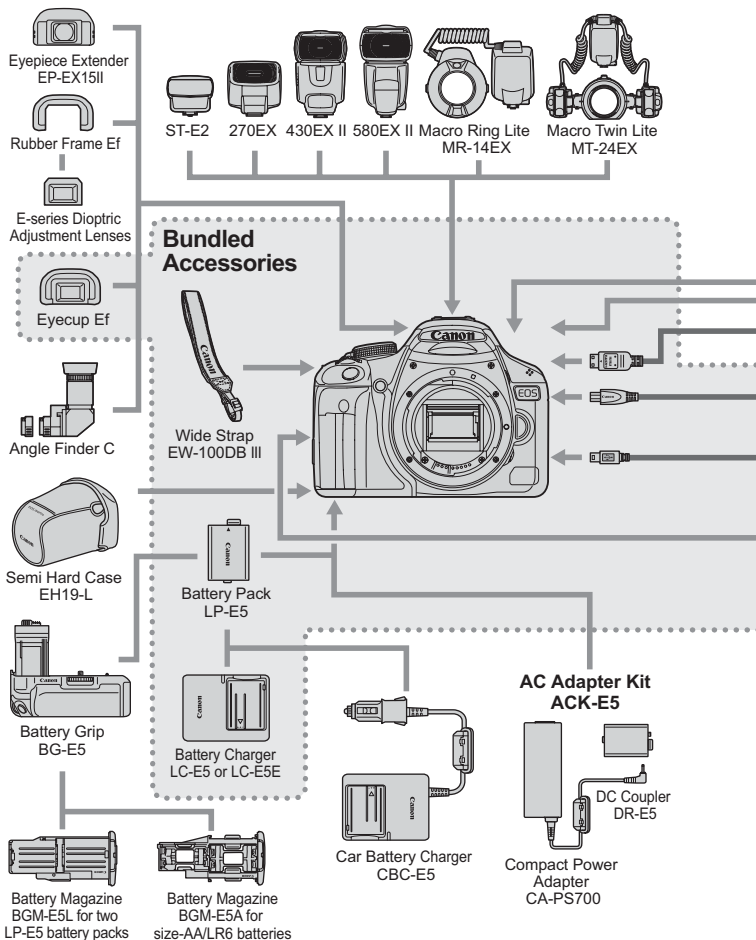

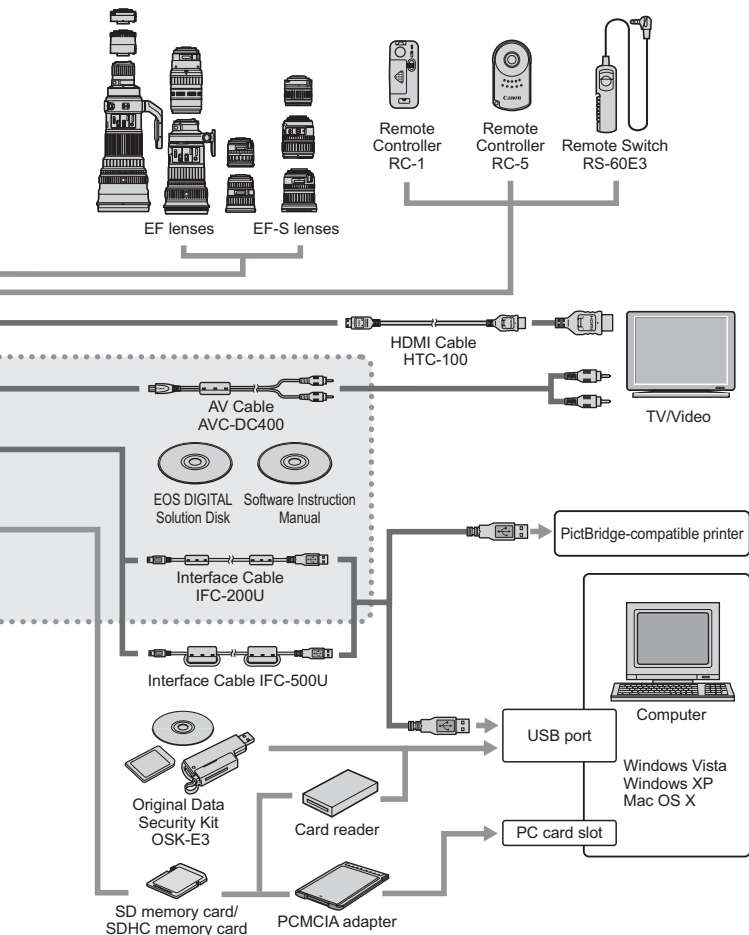

# Specifications

## • Type

Type:	Digital, single-lens reflex, AF/AE camera with built-in flash
Recording media:	SD memory card, SDHC memory card
Image sensor size:	22.3 x 14.9 mm
Compatible lenses:	Canon EF lenses (including EF-S lenses) (35mm-equivalent focal length is approx. 1.6 times the lens focal length)
Lens mount:	Canon EF mount

## • Image Sensor

Type:	CMOS sensor
Effective pixels:	Approx. 15.10 megapixels
Aspect ratio:	3:2
Dust delete feature:	Auto, Manual, Dust Delete Data appending

## • Recording System

Recording format:	Design rule for Camera File System 2.0
Image type:	JPEG, RAW (14-bit Canon original) RAW+JPEG simultaneous recording possible
Recorded pixels:	Large : Approx. 15.10 megapixels (4752 x 3168) Medium: Approx. 8.00 megapixels (3456 x 2304) Small : Approx. 3.70 megapixels (2352 x 1568) RAW : Approx. 15.10 megapixels (4752 x 3168)

## • Image Processing

Picture Style:	Standard, Portrait, Landscape, Neutral, Faithful, Monochrome, User Def. 1 - 3
White balance:	Auto, Preset (Daylight, Shade, Cloudy, Tungsten light, White fluorescent light, Flash), Custom White balance correction and white balance bracketing features provided * Color temperature information transmission enabled
Noise reduction:	Applicable to long exposures and high ISO speed shots
Automatic image brightness correction:	Auto Lighting Optimizer
Highlight tone priority:	Provided
Lens peripheral illumination correction:	Provided

## • Viewfinder

Type:	Eye-level pentamirror
Coverage:	Vertical/Horizontal approx. 95%

Magnification:	Approx. 0.87x (-1 m <sup>-1</sup> with 50mm lens at infinity)
Eye point:	Approx. 19 mm (From eyepiece lens center at -1 m <sup>-1</sup> )
Built-in dioptic adjustment:	-3.0 - +1.0 m <sup>-1</sup> (dpt)
Focusing screen:	Fixed, Precision Matte
Mirror:	Quick-return type
Depth-of-field preview:	Provided

### • Autofocus

Type:	TTL secondary image-registration, phase detection
AF points:	9 AF points
Metering range:	EV -0.5 - 18 (at 23°C/73°F, ISO 100)
Focus modes:	One-Shot AF, AI Servo AF, AI Focus AF, Manual focusing (MF)
AF-assist beam:	Small series of flashes fired by built-in flash

### • Exposure Control

Metering modes:	35-zone TTL full-aperture metering <ul style="list-style-type: none"> <li>• Evaluative metering (linkable to any AF point)</li> <li>• Partial metering (approx. 9% of viewfinder at center)</li> <li>• Spot metering (approx. 4% of viewfinder at center)</li> <li>• Center-weighted average metering</li> </ul>
Metering range:	EV 1 - 20 (at 23°C/73°F with EF50mm f/1.4 USM lens, ISO 100)
Exposure control:	Program AE (Full Auto, Portrait, Landscape, Close-up, Sports, Night Portrait, Flash Off, Creative Auto, Program), shutter-priority AE, aperture-priority AE, depth-of-field AE, manual exposure
ISO speed: (Recommended exposure index)	Basic Zone modes: ISO 100 - 1600 set automatically Creative Zone modes: ISO 100 - 3200 (in 1-stop increments), Auto, or ISO speed can be expanded to ISO 6400 or ISO 12800
Exposure compensation:	Manual and AEB (Settable in combination with manual exposure compensation) Settable amount: ±2 stops in 1/3- or 1/2-stop increments
AE lock:	Auto: Applied in One-Shot AF mode with evaluative metering when focus is achieved Manual: By AE lock button

### • Shutter

Type:	Electronically-controlled, focal-plane shutter
Shutter speeds:	1/4000 sec. to 1/60 sec. (Full Auto mode), X-sync at 1/200 sec. 1/4000 sec. to 30 sec., bulb (Total shutter speed range. Available range varies by shooting mode.)

### • Flash

Built-in flash:	Retractable, auto pop-up flash Guide No.: 13/43 (ISO 100, in meters/feet) Flash coverage: 17mm lens angle of view Recycling time approx. 3 sec.
External flash:	EX-series Speedlite (Functions settable with the camera)
Flash metering:	E-TTL II autoflash
Flash exposure compensation:	±2 stops in 1/3- or 1/2-stop increments
FE lock:	Provided
PC terminal:	None

### • Drive System

Drive mode:	Single shooting, continuous shooting, self-timer with 10-sec. or 2-sec. delay and 10-sec. delay with continuous shooting
Continuous shooting speed:	Max. approx. 3.4 shots/sec.
Max. burst:	JPEG Large/Fine: Approx. 170 shots RAW: Approx. 9 shots RAW+JPEG Large/Fine: Approx. 4 shots * Figures are based on Canon's testing standards (ISO 100 and Standard Picture Style) using a 2GB card.

### • Live View Shooting

Focusing:	Live mode, Face detection Live mode (Contrast detection) Quick mode (Phase-difference detection) Manual focusing (5x/10x magnification possible)
Metering modes:	Evaluative metering with the image sensor
Metering range:	EV 0 - 20 (at 23°C/73°F with EF50mm f/1.4 USM lens, ISO 100)

### • Movie Shooting

Movie type:	MOV (Video: H.264, Audio: Linear PCM)
Recording size/ Frame rate:	1920x1080 / 20 fps (Full HD), 1280x720 / 30 fps (HD), 640x480 / 30 fps (SD)
File size:	1920x1080: Approx. 330 MB/min., 1280x720: Approx. 222 MB/min., 640x480: Approx. 165 MB/min.
Focusing:	Same as focusing with Live View shooting
Metering range:	EV 0 - 20 (at 23°C/73°F with EF50mm f/1.4 USM lens, ISO 100)
Continuous shooting time:	Approx. 1 hr. 10 min. at 23°C/73°F Approx. 1 hr. at 0°C/32°F (With fully-charged Battery Pack LP-E5)

### • LCD Monitor

Type:	TFT color liquid-crystal monitor (Brightness adjustable to 7 levels)
Monitor size and dots:	3-in. with approx. 920,000 dots (VGA)
Coverage:	Approx. 100%
Interface languages:	25

### • Image Playback

Image display formats:	Single, Single + Info (Image-recording quality, shooting information, histogram), 4-image index, 9-image index, image rotate possible
Zoom magnification:	Approx. 1.5x - 10x
Image browsing methods:	Single image, jump by 10 or 100 images, by shooting date, by movie, by stills
Highlight alert:	Overexposed highlights blink
Movie playback:	Enabled (LCD monitor, video/audio OUT, HDMI OUT) Built-in speaker

### • Direct Printing

Compatible printers:	PictBridge-compatible printers
Printable images:	JPEG and RAW images
Print ordering:	DPOF Version 1.1 compatible

### • Customization

Custom Functions:	13
My Menu registration:	Provided

### • Interface

Digital terminal:	For computer communication and direct printing (Hi-Speed USB) For video/audio output (NTSC/PAL selectable)
HDMI mini OUT terminal:	Type C (Auto switching of resolution)
Remote control terminal:	For Remote Switch RS-60E3
Wireless remote control:	Compatible with Remote Controller RC-1/RC-5

### • Power Source

Battery:	Battery Pack LP-E5 (Quantity 1) * AC power can be supplied via AC Adapter Kit ACK-E5 * With Battery Grip BG-E5 attached, size-AA/LR6 batteries can be used
----------	--

Battery life:	With viewfinder shooting:
(Based on CIPA testing standards)	Approx. 400 shots at 23°C/73°F, approx. 380 shots at 0°C/32°F
	With Live View shooting:
	Approx. 170 shots at 23°C/73°F, approx. 160 shots at 0°C/32°F

### • Dimensions and Weight

Dimensions (W x H x D): 128.8 x 97.5 x 61.9 mm / 5.1 x 3.8 x 2.4 in.

Weight: Approx. 480 g / 16.9 oz. (body only)

### • Operation Environment

Working temperature range: 0°C - 40°C / 32°F - 104°F

Working humidity: 85% or less

### • Battery Pack LP-E5

Type: Rechargeable lithium-ion battery

Rated voltage: 7.4 V DC

Battery capacity: 1080 mAh

Dimensions (W x H x D): 36 x 14.7 x 53.1 mm / 1.4 x 0.6 x 2.1 in.

Weight: Approx. 50 g / 1.8 oz.

### • Battery Charger LC-E5

Compatible battery: Battery Pack LP-E5

Recharging time: Approx. 2 hours

Rated input: 100 - 240 V AC (50/60 Hz)

Rated output: 8.4 V DC

Working temperature range: 0°C - 40°C / 32°F - 104°F

Working humidity: 85% or less

Dimensions (W x H x D): 67 x 26 x 87.5 mm / 2.6 x 1.0 x 3.4 in.

Weight: Approx. 80 g / 2.8 oz.

### • Battery Charger LC-E5E

Compatible battery: Battery Pack LP-E5

Power cord length: Approx. 2 m / 6.6 ft.

Recharging time: Approx. 2 hours

Rated input: 100 - 240 V AC (50/60 Hz)

Rated output: 8.4 V DC

Working temperature range: 0°C - 40°C / 32°F - 104°F

Working humidity: 85% or less

Dimensions (W x H x D): 67 x 26 x 87.5 mm / 2.6 x 1.0 x 3.4 in.

Weight: Approx. 75 g / 2.6 oz.



### • EF-S18-55mm f/3.5-5.6 IS

Angle of view:	Diagonal extent: 74°20' - 27°50' Horizontal extent: 64°30' - 23°20' Vertical extent: 45°30' - 15°40'
Lens construction:	11 elements in 9 groups
Minimum aperture:	f/22 - 36
Closest focusing distance:	0.25 m / 0.82 ft. (From image sensor plane)
Max. magnification:	0.34x (at 55 mm)
Field of view:	207 x 134 - 67 x 45 mm / 8.1 x 5.3 - 2.6 x 1.8 in. (at 0.25 m)
Image Stabilizer:	Lens shift type
Filter size:	58 mm
Lens cap:	E-58
Max. diameter x length:	68.5 x 70 mm / 2.7 x 2.8 in.
Weight:	Approx. 200 g / 7.1 oz.
Hood:	EW-60C (sold separately)
Case:	LP814 (sold separately)

### • EF-S18-200mm f/3.5-5.6 IS

Angle of view:	Diagonal extent: 74°20' - 7°50' Horizontal extent: 64°30' - 6°30' Vertical extent: 45°30' - 4°20'
Lens construction:	16 elements in 12 groups
Minimum aperture:	f/22 - 36
Closest focusing distance:	0.45 m / 1.48 ft. (From image sensor plane)
Max. magnification:	0.24x (at 200 mm)
Field of view:	452 x 291 - 93 x 62 mm / 17.8 x 11.5 - 3.7 x 2.4 in. (at 0.45 m)
Image Stabilizer:	Lens shift type
Filter size:	72 mm
Lens cap:	E-72
Max. diameter x length:	78.6 x 102 mm / 3.1 x 4.0 in.
Weight:	Approx. 595 g / 21.0 oz.
Hood:	EW-78D (sold separately)
Case:	LP1116 (sold separately)

- All specifications above are based on Canon's testing standards.
- The camera's specifications and exterior are subject to change without notice.
- If a problem occurs with a non-Canon lens attached to the camera, consult the respective lens maker.

## Trademarks

- Adobe is a trademark of Adobe Systems Incorporated.
  - Windows is a trademark or registered trademark of Microsoft Corporation in the United States and other countries.
  - Macintosh and Mac OS is a trademark or registered trademark of Apple Inc. in the United States and other countries.
  - The SDHC logo is a trademark.
  - HDMI, HDMI logo, and High-Definition Multimedia Interface are a trademark or registered trademark of HDMI Licensing LLC.
  - All other corporate and product names and trademarks mentioned in this manual are the property of their respective owners.
- \* This digital camera supports Design rule for Camera File System 2.0 and Exif 2.21 (also called "Exif Print"). Exif Print is a standard that enhances compatibility between digital cameras and printers. By connecting the camera to an Exif Print-compliant printer, the shooting information is incorporated to optimize the print output.

## About MPEG-4 Licensing

"This product is licensed under AT&T patents for the MPEG-4 standard and may be used for encoding MPEG-4 compliant video and/or decoding MPEG-4 compliant video that was encoded only (1) for a personal and non-commercial purpose or (2) by a video provider licensed under the AT&T patents to provide MPEG-4 compliant video. No license is granted or implied for any other use for MPEG-4 standard."

\* Notice displayed in English as required.

### Use of genuine Canon accessories is recommended

This product is designed to achieve excellent performance when used with genuine Canon accessories. Canon shall not be liable for any damage to this product and/or accidents such as fire, etc., caused by the malfunction of non-genuine Canon accessories (e.g., a leakage and/or explosion of a battery pack). Please note that this warranty does not apply to repairs arising out of the malfunction of non-genuine Canon accessories, although you may request such repairs on a chargeable basis.

## Safety Warnings

Follow these safeguards and use the equipment properly to prevent injury, death, and material damage.

### Preventing Serious Injury or Death

- To prevent fire, excessive heat, chemical leakage, and explosions, follow the safeguards below:
  - Do not use any batteries, power sources, and accessories not specified in this booklet. Do not use any home-made or modified batteries.
  - Do not short-circuit, disassemble, or modify the battery pack or back-up battery. Do not apply heat or apply solder to the battery pack or back-up battery. Do not expose the battery pack or back-up battery to fire or water. And do not subject the battery pack or back-up battery to strong physical shock.
  - Do not install the battery pack or back-up battery in reversed polarity (+ -). Do not mix new and old or different types of batteries.
  - Do not recharge the battery pack outside the allowable ambient temperature range of 0°C - 40°C (32°F - 104°F). Also, do not exceed the recharging time.
  - Do not insert any foreign metallic objects into the electrical contacts of the camera, accessories, connecting cables, etc.
- Keep the back-up battery away from children. If a child swallows the battery, consult a physician immediately. (Battery chemicals may harm the stomach and intestines.)
- When disposing of a battery pack or back-up battery, insulate the electrical contacts with tape to prevent contact with other metallic objects or batteries. This is to prevent fire or an explosion.
- If excessive heat, smoke, or fumes are emitted during battery pack recharging, immediately unplug the battery charger from the power outlet to stop the recharging and prevent a fire.
- If the battery pack or back-up battery leaks, changes color, deforms, or emits smoke or fumes, remove it immediately. Be careful not to get burned in the process.
- Prevent any battery leakage from contacting your eyes, skin, and clothing. It can cause blindness or skin problems. If the battery leakage contacts your eyes, skin, or clothing, flush the affected area with lots of clean water without rubbing it. See a physician immediately.
- During the recharging, keep the equipment away from the reach of children. The cord can accidentally choke the child or give an electrical shock.
- Do not leave any cords near a heat source. It can deform the cord or melt the insulation and cause a fire or electrical shock.
- Do not fire the flash at someone driving a car. It may cause an accident.
- Do not fire the flash near a person's eyes. It may impair the person's vision. When using flash to photograph an infant, keep at least 1 meter away.
- Before storing the camera or accessory when not in use, remove the battery pack and disconnect the power plug. This is to prevent electrical shock, heat generation, and fire.
- Do not use the equipment where there is flammable gas. This is to prevent an explosion or fire.

- 
- If you drop the equipment and the casing breaks open to expose the internal parts, do not touch the internal parts due to the possibility of electrical shock.
  - Do not disassemble or modify the equipment. High-voltage internal parts can cause electrical shock.
  - Do not look at the sun or an extremely bright light source through the camera or lens. Doing so may damage your vision.
  - Keep the camera from the reach of small children. The neck strap can accidentally choke the child.
  - Do not store the equipment in dusty or humid places. This is to prevent fire and electrical shock.
  - Before using the camera inside an airplane or hospital, check if it is allowed. Electromagnetic waves emitted by the camera may interfere with the plane's instruments or the hospital's medical equipment.
  - To prevent fire and electrical shock, follow the safeguards below:
    - Always insert the power plug all the way in.
    - Do not handle a power plug with wet hands.
    - When unplugging a power plug, grasp and pull the plug instead of the cord.
    - Do not scratch, cut, or excessively bend the cord or put a heavy object on the cord. Also do not twist or tie the cords.
    - Do not connect too many power plugs to the same power outlet.
    - Do not use a cord whose insulation has been damaged.
  - Occasionally unplug the power plug and use a dry cloth to clean off the dust around the power outlet. If the surrounding is dusty, humid, or oily, the dust on the power outlet may become moist and short-circuit the outlet to cause a fire.
- 

## Preventing Injury or Equipment Damage

- Do not leave equipment inside a car under the hot sun or near a heat source. The equipment may become hot and cause skin burns.
  - Do not carry the camera around while it is attached to a tripod. Doing so may cause injury. Also make sure the tripod is sturdy enough to support the camera and lens.
  - Do not leave a lens or lens-attached camera under the sun without the lens cap attached. Otherwise, the lens may concentrate the sun's rays and cause a fire.
  - Do not cover or wrap the battery-recharging apparatus with a cloth. Doing so may trap heat within and cause the casing to deform or catch fire.
  - If you drop the camera in water or if water or metal fragments enter inside the camera, promptly remove the battery pack and back-up battery. This is to prevent fire and electrical shock.
  - Do not use or leave the battery pack or back-up battery in a hot environment. Doing so may cause battery leakage or a shorter battery life. The battery pack or back-up battery can also become hot and cause skin burns.
  - Do not use paint thinner, benzene, or other organic solvents to clean the equipment. Doing so may cause fire or a health hazard.
- 

**If the product does not work properly or requires repair, contact your dealer or your nearest Canon Service Center.**

## Digital Camera Model DS126231 Systems

This device complies with Part 15 of the FCC Rules. Operation is subject to the following two conditions: (1) This device may not cause harmful interference, and (2) this device must accept any interference received, including interference that may cause undesired operation.

**Note:** This equipment has been tested and found to comply with the limits for class B digital devices, pursuant to Part 15 of the FCC Rules. These limits are designed to provide reasonable protection against harmful interference in a residential installation. This equipment generates, uses and can radiate radio frequency energy and, if not installed and used in accordance with the instructions, may cause harmful interference to radio communications. However, there is no guarantee that interference will not occur in a particular installation. If this equipment does cause harmful interference to radio or television reception, which can be determined by turning the equipment off and on, the user is encouraged to try to correct the interference by one or more of the following measures:

- Reorient or relocate the receiving antenna.
- Increase the separation between the equipment and receiver.
- Connect the equipment into an outlet on a circuit different from that to which the receiver is connected.
- Consult the dealer or an experienced radio/TV technician for help.

The cable with the ferrite core provided with the digital camera must be used with this equipment in order to comply with Class B limits in Subpart B of Part 15 of the FCC rules.

Do not make any changes or modifications to the equipment unless otherwise specified in the manual. If such changes or modifications should be made, you could be required to stop operation of the equipment.

Canon U.S.A. Inc.  
One Canon Plaza, Lake Success, NY 11042, U.S.A.  
Tel No. (516)328-5600

This Class B digital apparatus complies with Canadian ICES-003.



When connecting to and using a household power outlet, use only AC Adapter Kit ACK-E5 (rated input: 100-240 V AC 50/60 Hz, rated output: 12.6 V DC). Using anything else can cause fire, overheating, or electrical shock.

## IMPORTANT SAFETY INSTRUCTIONS

1. **SAVE THESE INSTRUCTIONS** — This manual contains important safety and operating instructions for Battery Charger LC-E5 & LC-E5E.
2. Before using the charger, read all instructions and cautionary remarks on (1) the charger, (2) the battery pack, and (3) the product using the battery pack.
3. **CAUTION** — To reduce risk of injury, charge only the Battery Pack LP-E5. Other types of batteries may burst, causing personal injury and other damage.
4. Do not expose the charger to rain or snow.
5. Use of an attachment not recommended or sold by Canon may result in fire, electric shock, or personal injury.
6. To reduce risk of damage to electric plug and cord, pull by plug rather than by cord when disconnecting charger.
7. Make sure cord is located so that it will not be stepped on, tripped over, or otherwise subjected to damage or stress.
8. Do not operate the charger with damaged cord or plug - replace them immediately.
9. Do not operate the charger if it has received a sharp blow, been dropped, or otherwise damaged in any way; take it to a qualified serviceman.
10. Do not disassemble the charger; take it to a qualified serviceman when service or repair is required. Incorrect reassembly may result in a risk of electric shock or fire.
11. To reduce risk of electric shock, unplug charger from outlet before attempting any maintenance or cleaning.

## MAINTENANCE INSTRUCTION

Unless otherwise stated in this manual, there are no user serviceable parts inside. Refer servicing to qualified serviceman.



USA and Canada only:

The Lithium ion/polymer battery that powers the product is recyclable. Please call 1-800-8-BATTERY for information on how to recycle this battery.

For CA, USA only

Included lithium battery contains Perchlorate Material – special handling may apply.

See [www.dtsc.ca.gov/hazardouswaste/perchlorate/](http://www.dtsc.ca.gov/hazardouswaste/perchlorate/) for details.

# Index

1st-curtain sync.....	140
2nd-curtain sync.....	140
2-sec. self-timer .....	69
4- or 9-image index display.....	148

## A

AV OUT terminal.....	156
AC Adapter Kit .....	193
Access lamp.....	32
A-DEP (Automatic depth-of-field AE).....	82
Adobe RGB.....	93
AE lock.....	94, 124
AEB.....	86
AF → Focusing	
AI FOCUS (AI Focus AF).....	65
AI SERVO (AI Servo AF) .....	65
Aperture-priority AE .....	78
Audio/video OUT terminal.....	156
Auto Lighting Optimizer.....	43, 186
Auto playback → Slide show	
Auto power off.....	27, 131
Autofocus → Focusing	
Av (Aperture-priority AE).....	78

## B

B/W (Monochrome).....	74
Basic Zone modes .....	20
Battery → Power	
Battery check .....	28
Battery Grip BG-E5.....	210
Beeper .....	130
Black-and-white image.....	74, 90
Built-in flash .....	62, 77, 80
Bulb.....	81

BULB (Bulb exposure).....	81
---------------------------	----

## C

 (Creative Auto).....	53
Cable.....	3, 211
Camera	
Camera shake.....	104
Clear settings .....	136
Holding the camera.....	36
Settings display.....	135
Camera shake .....	35 - 37
Card.....	2, 13, 31
Card reminder .....	31, 130
Format.....	40
Problem.....	32, 209
SD speed class .....	121
SDHC.....	2
Center-weighted average metering ...	83
Cleaning (image sensor) .....	142
Clock → Date/Time	
Close-up .....	49
Color space .....	93
Color temperature .....	96
Color tone.....	89
Continuous shooting.....	68
Contrast.....	89
Copyright information .....	137
Cord.....	3, 211
Creative Auto.....	53
Creative Zone modes .....	20
Custom Functions .....	182
Clear all.....	182
List .....	183

## D

Date/Time .....	29
-----------------	----

Depth-of-field preview .....	80
Digital terminal .....	164, 177
Dioptric adjustment .....	36
Direct printing → Printing	
DPOF .....	173
Drive mode .....	68
Dust Delete Data .....	143

**E**

Erase (image) .....	159
Error codes .....	209
Evaluative metering .....	83
Exposure compensation .....	84
Extension .....	133
External Speedlite .....	139, 196
Eyepiece cover .....	23, 195

**F**

Face detection Live mode (AF).....	112
Faithful .....	74
FE lock .....	95
File number .....	132
File size .....	70, 123, 161
Filter effect (Monochrome).....	90
Firmware Ver.....	201

Flash .....	62
2nd-curtain sync .....	140
Built-in flash .....	62
Custom Functions .....	141
Effective range .....	62
External Speedlite .....	139, 196
FE lock .....	95
Flash exposure compensation ..	85
Flash off .....	52, 54
Flash-sync speed .....	184
Menu setting .....	139
Red-eye reduction .....	63
Flash exposure compensation .....	85
Focus lock .....	46
Focus mode switch .....	33, 67

**Focusing**

AF mode .....	64, 111
AF point selection .....	66
AF-assist beam .....	45, 187
Beeper .....	130
Difficult-to-focus subjects ..	115, 192
Manual focusing .....	67, 118
Out of focus .....	45, 115, 192
Recompose .....	46

Format (card initialization).....	40
Full Auto .....	44
Full HD .....	121, 123
Full High-Definition .....	123
Function availability table .....	198

**G**

Grid display .....	108, 124
--------------------	----------

**H**

HDMI .....	157
High-Definition .....	123, 157
Highlight alert .....	161



Highlight detail loss ..... 161  
 Highlight tone priority ..... 60, 186  
 Histogram (Brightness/RGB) ..... 162

**I**

ICC profile ..... 93  
 Image  
   Auto playback ..... 154  
   Erase ..... 159  
   Highlight alert ..... 161  
   Histogram ..... 162  
   Index ..... 148  
   Jump display ..... 149  
   Magnified view ..... 150  
   Playback ..... 56, 147  
   Protect ..... 158  
   Rotate ..... 134, 151  
   Shooting information ..... 110, 161  
   Transfer ..... 177  
   Transfer to computer ..... 177  
   View on TV ..... 156  
 Image area ..... 34  
 Image dust prevention ..... 143  
 Image review time ..... 130  
 Image Zone ..... 20  
 Image-recording quality ..... 70  
 Index display ..... 148  
 ISO speed ..... 60  
   Automatic setting ..... 61  
   ISO expansion ..... 60, 184

**J**

JPEG ..... 70  
 Jump display ..... 149

**L**

Landscape ..... 48, 73

Language selection ..... 30  
 LCD monitor ..... 13  
   Auto off ..... 138  
   Brightness adjustment ..... 131  
   Display switching ..... 42  
   Image playback ..... 56, 147  
   Menu settings ..... 38  
   Screen color ..... 138  
   Shooting settings display ..... 18  
 Lens ..... 21, 33 - 35  
   Attaching/Detaching ..... 33  
 Lens peripheral illumination  
   correction ..... 100  
 Live mode (AF) ..... 111  
 Live View shooting ..... 105  
   Focusing ..... 111  
   Grid display ..... 108  
   Possible shots ..... 107  
 Long exposures → Bulb  
 Low level format ..... 40, 41









**M**

M (Manual exposure) ..... 81  
 Magnified view ..... 118, 150  
 Main Dial ..... 16, 75  
 Malfunction ..... 203  
 Manual exposure ..... 81  
 Manual focusing ..... 67, 118  
 Maximum burst ..... 71  
 Memory card → Card  
 Menu  
   Menu settings ..... 200  
   My Menu ..... 190  
   Setting operation ..... 38  
 Metering mode ..... 83  
 Metering timer ..... 108, 124  
 MF (Manual focusing) ..... 67, 118

- Microphone ..... 124
- Mirror lockup ..... 104, 187
- Mode Dial ..... 20
- Monochrome ..... 74
- Movie
- Playback ..... 152
  - Recording size ..... 123
  - Shooting ..... 121
  - Still image shooting ..... 125
  - View on TV ..... 156
- My Menu ..... 190
- N**
- Neutral ..... 74
- Night Portrait ..... 51
- Night scene ..... 48
- Noise reduction
- High ISO speed ..... 68, 72, 185
  - Long exposure ..... 81, 185
- Nomenclature ..... 16 - 22
- NTSC ..... 201
- O**
- ONE SHOT (One-Shot AF) ..... 64
- Original decision  
(image verification) data ..... 189
- P**
- P (Program AE) ..... 58
- PAL ..... 201
- Paper settings (printing) ..... 166
- Partial metering ..... 83
- Peripheral illumination correction ... 100
- PictBridge ..... 163
- Picture Style
- Adjustment ..... 88
  - Selection ..... 73
  - User defined ..... 91
- Pixels ..... 70
- Playback ..... 56, 147
- Portrait ..... 47, 51, 73
- Possible shots ..... 28, 107
- Power
- Auto power off ..... 27, 131
  - Battery check ..... 28
  - Household power ..... 193
  - Possible shots ..... 28, 107
  - Recharge ..... 24
  - Switch ..... 27
- Printing ..... 164
- Page layout ..... 167
  - Paper settings ..... 167
  - Print Order (DPOF) ..... 173
  - Printing effects ..... 168, 170
  - Tilt correction ..... 171
  - Trimming ..... 171
- Program AE ..... 58
- Program shift ..... 59
- Protect (image erase-protection) .... 158
- Q**
- Quick Control screen ..... 102
- Quick mode (AF) ..... 116
- R**
- RAW ..... 70 - 72
- RAW+JPEG ..... 70 - 72
- Recharge ..... 24
- Red-eye reduction ..... 63
- Release shutter without card ..... 31

Remote control	
shooting .....	55, 69, 124, 194
Revert to default settings .....	136
Rotate (image) .....	134, 151

**S**

Safety warnings .....	219
Saturation .....	89
SD/SDHC card → Card	
Self-timer .....	69
Sensor cleaning .....	27, 142, 145
Sepia (Monochrome) .....	90
Sharpness .....	89
Shooting information	
display .....	110, 126, 161
Shooting mode .....	20
A-DEP	
(Automatic depth-of-field AE) .....	82
M (Manual exposure) .....	81
Av (Aperture-priority AE) .....	78
Tv (Shutter-priority AE) .....	76
P (Program AE) .....	58
 (Creative Auto) .....	53
 (Full Auto) .....	44
 (Portrait) .....	47
 (Landscape) .....	48
 (Close-up) .....	49
 (Sports) .....	50
 (Night Portrait) .....	51
 (Flash Off) .....	52
 (Movie shooting) .....	121
Shooting settings display .....	18
Shutter button .....	37
Shutter-priority AE .....	76
Slide show .....	154
Sound recording .....	124
Speaker .....	152

Sports .....	50
Spot metering .....	83
Standard .....	73
Stopped-down aperture .....	80
Strap .....	23
System map .....	210

**T**

Tone priority .....	186
Toning effect (Monochrome) .....	90
Trimming (printing) .....	171
Tv (Shutter-priority AE) .....	76

**V**

Video system .....	156, 201
View on TV .....	156
Viewfinder .....	19
Dioptic adjustment .....	36
Volume (Movie playback) .....	153

**W**

WB → White balance	
White balance .....	96
Bracketing .....	99
Correction .....	98
Custom .....	96
Personal .....	97

**Z**

Zoom ring lock .....	34
----------------------	----



**CANON INC.** 30-2, Shimomaruko 3-chome, Ohta-ku, Tokyo 146-8501, Japan

**U.S.A.** ————— **CANON U.S.A. INC.**

One Canon Plaza, Lake Success, NY 11042-1198, U.S.A.  
For all inquiries concerning this product, call toll free in the U.S.  
1-800-OK-CANON

**CANADA** ————— **CANON CANADA INC. HEADQUARTERS**

6390 Dixie Road, Mississauga, Ontario L5T 1P7, Canada  
**CANON CANADA INC. MONTREAL BRANCH**  
5990, Côte-de-Liesse, Montréal Québec H4T 1V7, Canada  
**CANON CANADA INC. CALGARY OFFICE**  
2828, 16th Street, N.E. Calgary, Alberta T2E 7K7, Canada  
For all inquiries concerning this product, call toll free in Canada  
1-800-OK-CANON

**EUROPE,** ————— **CANON EUROPA N.V.**

**AFRICA &** Bovenkerkerweg 59-61, 1185 XB Amstelveen, The Netherlands

**MIDDLE EAST** **CANON FRANCE S.A.S.**

17, Quai du Président Paul Doumer, 92414 Courbevoie Cedex, France

**CANON UK LTD.**

Woodhatch Reigate, Surrey RH2 8BF, United Kingdom

**CANON DEUTSCHLAND GmbH**

Europark Fichtenhain A10, 47807 Krefeld, Germany

**CANON ITALIA S.p.A.**

Via Milano 8, 20097 San Donato Milanese, (MI), Italy

**CANON Schweiz A.G.**

Industriestrasse 12, 8305 Dietlikon, Switzerland

**Canon GmbH**

Zetschegasse 11, A-1230 Vienna, Austria

**CANON España, S.A.**

Av. De Europa, 6 Alcobendas 28108 Madrid, Spain

**CANON Portugal S.A.**

Rua Alfredo da Silva, 14 Alfragide 2610-016 Amadora, Portugal

**CENTRAL &** ————— **CANON LATIN AMERICA, INC.**

**SOUTH AMERICA** 703 Waterford Way, Suite 400 Miami, FL 33126, U.S.A.

**ASIA** ————— **CANON (China) Co., LTD.**

15F Jinbao Building No.89 Jinbao Street, Dongcheng District, Beijing 100005, China

**CANON HONGKONG CO., LTD.**

19/F., The Metropolis Tower, 10 Metropolis Drive, Hunghom, Kowloon, Hong Kong

**CANON SINGAPORE PTE. LTD.**

1 HarbourFront Avenue, #04-01 Keppel Bay Tower, Singapore 098632

**CANON KOREA CONSUMER IMAGING INC.**

Gangnam Finance Center 17F, 737, Yeoksam-Dong, Gangnam-Gu, Seoul, 135-984, Korea

**OCEANIA** ————— **CANON AUSTRALIA PTY. LTD.**

1 Thomas Holt Drive, North Ryde, Sydney N.S.W. 2113, Australia

**CANON NEW ZEALAND LTD.**

Akoranga Business Park, Akoranga Drive, Northcote, Auckland, New Zealand

**JAPAN** ————— **CANON MARKETING JAPAN INC.**

16-6, Kohnan 2-chome, Minato-ku, Tokyo 108-8011, Japan

This Instruction Manual booklet is current as of April 2009. For information on the camera's compatibility with any accessories and lenses introduced after this date, contact any Canon Service Center.

## Free Manuals Download Website

<http://myh66.com>

<http://usermanuals.us>

<http://www.somanuals.com>

<http://www.4manuals.cc>

<http://www.manual-lib.com>

<http://www.404manual.com>

<http://www.luxmanual.com>

<http://aubethermostatmanual.com>

Golf course search by state

<http://golfingnear.com>

Email search by domain

<http://emailbydomain.com>

Auto manuals search

<http://auto.somanuals.com>

TV manuals search

<http://tv.somanuals.com>