

Canon EF LENS

EF16-35mm f/4L IS USM



IMAGE STABILIZER

ULTRASONIC

ENG

Instructions

Thank you for purchasing a Canon product.

Canon's EF16-35mm f/4L IS USM is a high-performance ultra-wide angle zoom lens, for use with EOS cameras. The lens is installed with an Image Stabilizer.

- "IS" stands for Image Stabilizer.
- "USM" stands for Ultrasonic Motor.

Features

1. Equipped with an Image Stabilizer that provides an image stabilization effect equivalent to a shutter speed 4 stops* faster (at 35 mm, when used with the EOS-1D X).
This function provides optimal image stabilization depending on shooting conditions (such as shooting still subjects and following shots).
2. Use of UD and aspherical lens elements giving superior definition.
3. Using a fluorine coating on the foremost and rearmost lens surfaces allows adhered dirt to be removed more easily than before.

4. Ultrasonic motor (USM) for fast, quiet autofocus.
5. Manual focusing is available after the subject comes into focus in autofocus mode (ONE SHOT AF).
6. Circular aperture for producing beautiful softfocus images.
7. Tight seal structure ensures excellent dustproof and drip-proof performance.
 - **Since the front element of this lens moves when zooming, you need to attach a Canon PROTECT filter sold separately for adequate dust-and water-resistant performance. Without a filter, the lens is not dust or water resistant.**

* Image stabilization performance based on CIPA (Camera & Imaging Products Association) Standards.

Safety Precautions

Handling Cautions

- **If the lens is taken from a cold environment into a warm one, condensation may develop on the lens surface and internal parts.** To prevent condensation in this case, first put the lens into an airtight plastic bag before taking it from a cold to warm environment. Then take out the lens after it has warmed gradually. Do the same when taking the lens from a warm environment into a cold one.
- Do not leave the lens in excessive heat such as in a car in direct sunlight. **High temperatures can cause the lens to malfunction.**

Safety Precautions

- **Do not look at the sun or a bright light source through the lens or camera.** Doing so could result in loss of vision. Looking at the sun directly through the lens is especially hazardous.
- **Whether it is attached to the camera or not, do not leave the lens under the sun without the lens cap attached.** This is to prevent the lens from concentrating the sun's rays, which could cause a fire.

Conventions used in this instruction



Warning to prevent lens or camera malfunction or damage.



Supplementary notes on using the lens and taking pictures.

Safety Precautions

This device complies with Part 15 of the FCC Rules.

Operation is subject to the following two conditions: (1) This device may not cause harmful interference, and (2) this device must accept any interference received, including interference that may cause undesired operation.

Do not make any changes or modifications to the equipment unless otherwise specified in the instructions. If such changes or modifications should be made, you could be required to stop operation of the equipment.

This equipment has been tested and found to comply with the limits for a class B digital device, pursuant to part 15 of the FCC Rules. These limits are designed to provide reasonable protection against harmful interference in a residential installation. This equipment generates, uses and can radiate radio frequency energy and, if not installed and used in accordance with the instructions, may cause harmful interference to radio communications.

However, there is no guarantee that interference will not occur in a particular installation. If this equipment does cause harmful interference to radio or television reception, which can be determined by turning the equipment off and on, the user is encouraged to try to correct the interference by one or more of the following measures:

- Reorient or relocate the receiving antenna.
- Increase the separation between the equipment and receiver.
- Connect the equipment into an outlet on a circuit different from that to which the receiver is connected.
- Consult the dealer or an experienced radio/TV technician for help.

CAN ICES-3 (B) / NMB-3 (B)

Nomenclature

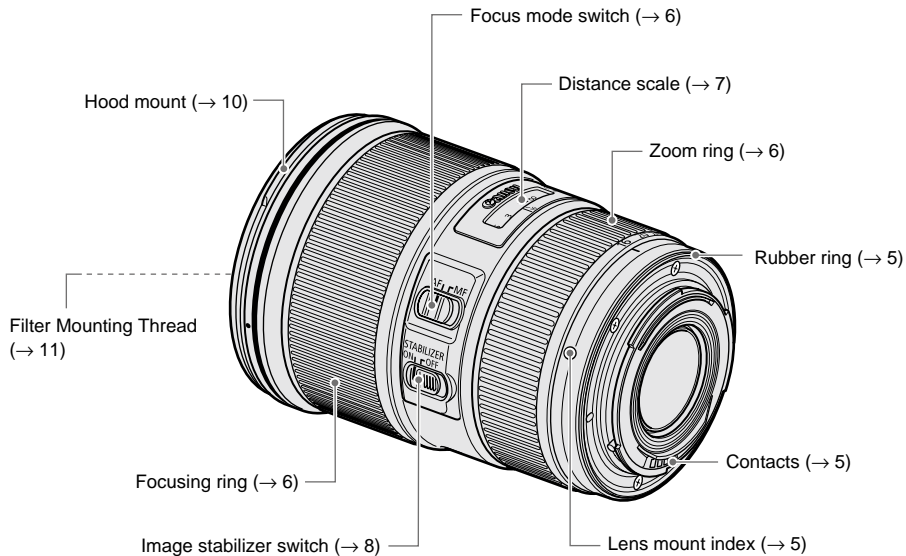

- For detailed information, reference page numbers are provided in parentheses (→ **).

1. Mounting and Detaching the Lens

See your camera's instructions for details on mounting and detaching the lens.

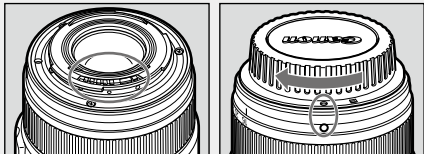

- After detaching the lens, place the lens with the rear end up to prevent the lens surface and contacts from getting scratched.
- If the contacts get soiled, scratched, or have fingerprints on them, corrosion or faulty connections can result. The camera and lens may not operate properly.
- If the contacts get soiled or have fingerprints on them, clean them with a soft cloth.
- If you remove the lens, cover it with the dust cap. To attach it properly, align the lens mount index and the  index of the dust cap as shown in the diagram, and turn clockwise. To remove it, reverse the order.



The lens mount has a rubber ring for enhanced dust- and water-resistance. The rubber ring may cause slight abrasions around the camera's lens mount, but this will not cause any problems. If the rubber ring becomes worn, it is replaceable by a Canon Service Center at cost.

2. Setting the Focus Mode

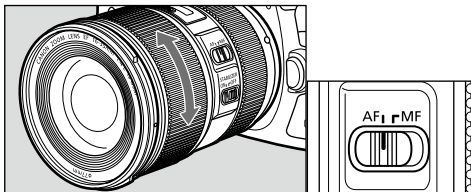

To shoot in autofocus (AF) mode, set the focus mode switch to AF.

To shoot in manual focus (MF) mode, set the focus mode switch to MF, and focus by turning the focusing ring.

The focusing ring always works, regardless of the focus mode.

 After autofocus in ONE SHOT AF mode, focus manually by pressing the shutter button halfway and turning the focusing ring. (Full-time manual focus)

3. Zooming

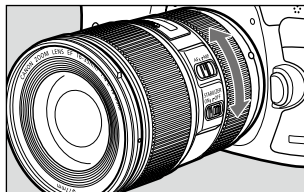

To zoom, rotate the zoom ring.

 Be sure to finish zooming before focusing. Zooming after focusing can affect the focus.

4. Infinity Compensation Mark

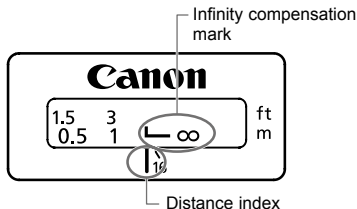

To compensate for shifting of the infinity focus point that results from changes in temperature. The infinity position at normal temperature is the point at which the vertical line of the distance scale L mark is aligned with the distance index.

🔍 For accurate manual focusing of subjects at infinity, look through the viewfinder or look at the magnified image* on the LCD screen while rotating the focusing ring.

* For cameras with Live View shooting capability.

5. Infrared Index

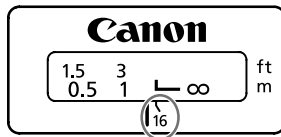

The infrared index corrects the focus setting when using monochrome infrared film. Focus on the subject manually, then adjust the distance setting by moving the focusing ring to the corresponding infrared index mark.

🔍 Some EOS cameras cannot use infrared film. See the instructions for your EOS camera.

- 📖
- The infrared index position is based on a wavelength of 800 nm.
 - The compensation amount differs depending on the focal length. Use the indicated focal length as a guide when setting the compensation amount.
 - Be sure to observe the manufacturer's instructions when using infrared film.
 - Use a red filter when you take the picture.

6. Image Stabilizer

You can use the image stabilizer in AF or MF mode. This function provides optimal image stabilization depending on shooting conditions (such as shooting still subjects and following shots).

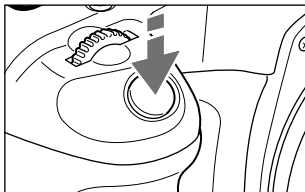
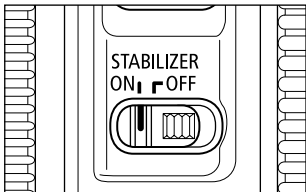

ON



OFF

1 Set the STABILIZER switch to ON.

- If you are not going to use the image stabilizer function, set the switch to OFF.

2 When you press the shutter button halfway, the Image Stabilizer will start operating.

- Make sure the image in the viewfinder is stable, then press the shutter button the rest of the way down to take the picture.

The image stabilizer in this lens is effective for hand-held shots under the following conditions.

- In semi-darkened areas such as indoors or outdoors at night.
- In locations where flash photography is prohibited, such as art museums and theater stages.
- In situations where your footing is uncertain.
- When panning subjects in motion.
- In situations where fast shutter settings cannot be used.

Image Stabilizer

- The Image Stabilizer cannot compensate for a blurred shot caused by a subject that moved.
 - Set the STABILIZER switch to OFF when you are taking pictures using the Bulb setting (long exposures). If the STABILIZER switch is set to ON, the image stabilizer function may introduce errors.
 - The Image Stabilizer may not be fully effective if you shoot from a violently shaking vehicle or other transportation.
 - The Image Stabilizer consumes more power than normal shooting, resulting in fewer shots and a shorter movie shooting time.
 - The image stabilizer operates for about two seconds even when your finger is off the shutter button. Do not remove the lens while the stabilizer is in operation. This will cause a malfunction.
 - With the EOS-1V/HS, 3, ELAN 7E/ELAN 7/30/33, ELAN 7NE/ELAN 7N/30V/33V, ELAN II/ELAN IIE/50/50E, REBEL 2000/300, IX, and D30, the Image Stabilizer will not work during self-timer operation.
- When shooting a still subject, it compensates for camera shake in all directions.
 - It compensates for vertical camera shake during following shots in a horizontal direction, and compensates for horizontal camera shake during following shots in a vertical direction.
 - When you use a tripod, the Image Stabilizer should be turned off to save battery power.
 - The stabilizer is equally effective for hand-held photography and photography with a monopod. The Image Stabilizer effect may be reduced, however, depending on the shooting environment.
 - The image stabilizer function also operates when the lens is used with an Extension Tube EF12 II or EF25 II.
 - Pictures may look distorted after being taken depending on the camera, but this doesn't affect shooting.
 - If you set the camera's Custom Function to change the assigned button to operate the AF, the Image Stabilizer will operate when you press the newly assigned AF button.

7. Hood

The EW-82 hood cuts out unwanted light and protects the front of the lens from rain, snow, and dust.

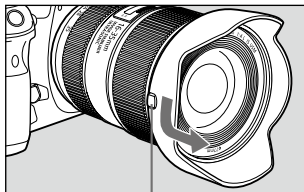
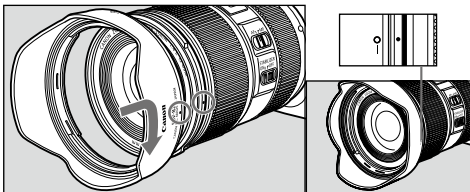

Button

● Attaching

To attach the hood, align the hood's attachment position mark with the red dot on the front of the lens, then turn the hood as shown by the arrow until the lens' red dot is aligned with the hood's stop position mark.

● Removing

To remove the hood, hold down the button on the side and turn the hood in the direction of the arrow until the position mark on the hood aligns with the red dot. The hood can be reverse-mounted on the lens for storage.



- If the hood is not attached properly, vignetting (darkening of the perimeter of the picture) may occur.
- When attaching or detaching the hood, grasp the base of the hood to turn it. To prevent deformation, do not grasp the rim of the hood to turn it.

8. Filters (Sold separately)

You can attach filters to the filter mounting thread on the front of the lens.

- To ensure dust- and water-resistant performance, attach a Canon PROTECT filter (77mm).
- Only one filter may be attached.
- If you need a polarizing filter, use the Canon Circular Polarizing Filter PL-C B (77 mm).
- To adjust the polarizing filter, first remove the lens hood.

9. Close-up Lenses (Sold separately)

Attaching a 500D (77mm) Close-up Lens enables close-up photography.

Compatibility with Close-up Lenses is as follows.

- Can be used at the 35mm end (magnification 0.07x - 0.28x)

- Close-up Lens 250D cannot be attached because there is no size that fits the lens.
- MF mode is recommended for accurate focusing.

10. Extension Tubes (Sold separately)

You can attach extension tube EF12 II or EF25 II for magnified shots. The shooting distance and magnification are shown below.

		Focusing Distance Range (mm)		Magnification (×)	
		Close distance	Long distance	Close distance	Long distance
EF12 II	16mm	Incompatible			
	35mm	206	253	0.63	0.36
EF25 II	16mm	Incompatible			
	35mm	200	216	1.12	0.80

- MF mode is recommended for accurate focusing.

Specifications

Focal Length/Aperture	16-35mm f/4
Lens Construction	12 groups, 16 elements
Minimum Aperture	f/22
Angle of View	Diagonal: 108° 10' – 63°, Vertical: 74° 10' – 38°, Horizontal: 98° – 54°
Min. Focusing Distance	0.28 m/0.92 ft.
Max. Magnification	0.23x (at 35mm)
Field of View	Approx. 222 x 343 – 105 x 157 mm/ 8.74 x 13.50 – 4.13 x 6.18 inch (at 0.28 m/0.92 ft.)
Filter Diameter	77 mm/3.03 inch
Max. Diameter and Length	82.6 x 112.8 mm/3.25 x 4.44 inch
Weight	Approx. 615 g/21.7 oz.
Hood	EW-82
Lens Cap	E-77 II
Case	LP1219

- The lens length is measured from the mount surface to the front end of the lens. Add 24.2 mm when including the lens cap and dust cap.
- The size and weight listed are for the lens only, except as indicated.
- Extenders cannot be used with this lens.
- Aperture settings are specified on the camera.
- All data listed is measured according to Canon standards.
- Product specifications and appearance are subject to change without notice.

Canon

Free Manuals Download Website

<http://myh66.com>

<http://usermanuals.us>

<http://www.somanuals.com>

<http://www.4manuals.cc>

<http://www.manual-lib.com>

<http://www.404manual.com>

<http://www.luxmanual.com>

<http://aubethermostatmanual.com>

Golf course search by state

<http://golfingnear.com>

Email search by domain

<http://emailbydomain.com>

Auto manuals search

<http://auto.somanuals.com>

TV manuals search

<http://tv.somanuals.com>