

Canon EF LENS

EF100-400mm f/4.5-5.6L IS USM



 **ULTRASONIC**

IMAGE STABILIZER

100-400mm

ENG

Instruction

Thank you for purchasing a Canon product.

The Canon EF100–400mm f/4.5–5.6L IS USM lens is a high-performance telephoto zoom lens for EOS cameras.

- “IS” stands for Image Stabilizer.
- “USM” stands for Ultrasonic Motor.

Handling Cautions

- **If the lens is taken from a cold environment into a warm one, condensation may develop on the lens surface and internal parts.** To prevent condensation in this case, first put the lens into an airtight plastic bag before taking it from a cold to warm environment. Then take out the lens after it has warmed gradually. Do the same when taking the lens from a warm environment into a cold one.
- Do not leave the lens in excessive heat such as in a car in direct sunlight. **High temperatures can cause the lens to malfunction.**

Conventions used in this instruction



Warning to prevent lens or camera malfunction or damage.



Supplementary notes on using the lens and taking pictures.

Features

1. The Image Stabilizer gives the equivalent effect of a shutter speed two stops* faster. A second image stabilizer mode that is optimized for continuous shooting (MODE 2) is provided.
2. Fluorite and super UD lens elements for truly exceptional imaging capability.
3. Ultrasonic motor (USM) for fast, quiet autofocus.
4. Manual focusing is available after the subject comes into focus in autofocus mode (ONE SHOT AF).
5. Adjustable zoom ring touch lets you lock at any focal length.
6. Can be used with EF1.4× II/EF2× II extenders.

* Based on [1/focal length] second.
Generally, it requires a shutter speed [1/focal length] second or faster to prevent camera shake.



Safety Precautions



Safety Precautions

- **Do not look at the sun or a bright light source through the lens or camera.** Doing so could result in loss of vision. Looking at the sun directly through the lens is especially hazardous.
- **Whether it is attached to the camera or not, do not leave the lens under the sun without the lens cap attached.** This is to prevent the lens from concentrating the sun's rays, which could cause a fire.

This device complies with Part 15 of the FCC Rules. Operation is subject to the following two conditions: (1) This device may not cause harmful interference, and (2) this device must accept any interference received, including interference that may cause undesired operation.

Do not make any changes or modifications to the equipment unless otherwise specified in the instructions. If such changes or modifications should be made, you could be required to stop operation of the equipment.

This equipment has been tested and found to comply with the limits for a class B digital device, pursuant to part 15 of the FCC Rules. These limits are designed to provide reasonable protection against harmful interference in a residential installation. This equipment generates, uses and can radiate radio frequency energy and, if not installed and used in accordance with the instructions, may cause harmful interference to radio communications.

However, there is no guarantee that interference will not occur in a particular installation. If this equipment does cause harmful

interference to radio or television reception, which can be determined by turning the equipment off and on, the user is encouraged to try to correct the interference by one or more of the following measures:

- Reorient or relocate the receiving antenna.
- Increase the separation between the equipment and receiver.
- Consult the dealer or an experienced radio/TV technician for help.

This Class B digital apparatus complies with Canadian ICES-003.

Precautions for shooting with EOS-1N RS

- When using this lens to shoot with EOS-1N RS, use $-2/3$ step or $-1/2$ step exposure compensation.

Nomenclature

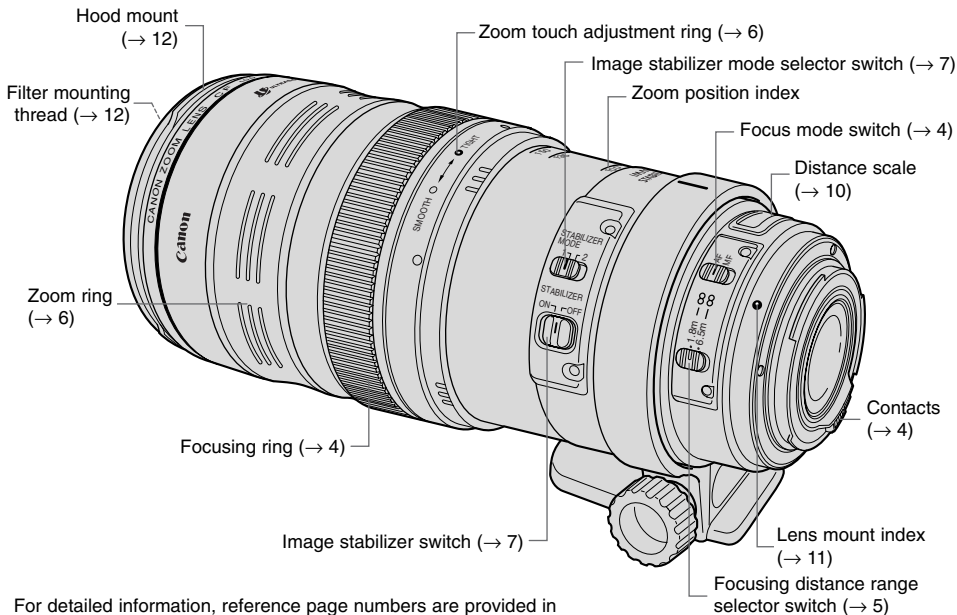

For detailed information, reference page numbers are provided in parentheses (→ **).

1. Mounting and Detaching the Lens

See your camera's instructions for details on mounting and detaching the lens.

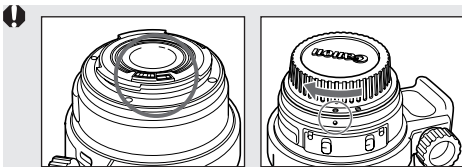

- After detaching the lens, place the lens with the rear end up to prevent the lens surface and contacts from getting scratched.
- If the contacts get soiled, scratched, or have fingerprints on them, corrosion or faulty connections can result. The camera and lens may not operate properly.
- If the contacts get soiled or have fingerprints on them, clean them with a soft cloth.
- If you remove the lens, cover it with the dust cap. To attach it properly, align the lens mount index and the ○ index of the dust cap as shown in the diagram, and turn clockwise. To remove it, reverse the order.

2. Setting the Focus Mode

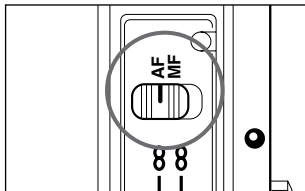

To shoot in autofocus (AF) mode, set the focus mode switch to AF.

To shoot in manual focus (MF) mode, set the focus mode switch to MF, and focus by turning the focusing ring. The focusing ring always works, regardless of the focus mode.

 After autofocusing in ONE SHOT AF mode, focus manually by pressing the shutter button halfway and turning the focusing ring. (Full-time manual focus)

3. Switching the Focusing Distance Range

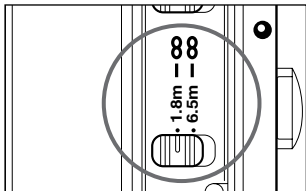

You can set the focusing distance range to 1.8 m/5.9 ft. to infinity or 6.5 m/21.3 ft. to infinity. By setting the suitable focusing distance range, the actual autofocusing time will be shorter.

! If you use AF from outside the specified focusing distance range, the lens may stop focusing when it reaches the limit of the range. This is not a malfunction. If this occurs, press the shutter button halfway down again.

4. Adjusting Zooming Resistance

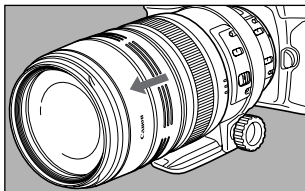

Move the zoom ring forward or backward to zoom.

- Be sure to finish zooming before focusing. Changing the zoom ring after focusing can affect the focus.
- To prevent unintended extension of the front of the lens, be careful not to set the zoom ring too loose.

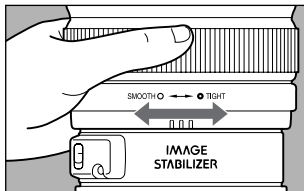

You can adjust the zoom ring “touch” (resistance) as needed by holding the focusing ring in place and turning the zoom touch adjustment ring.

- ☞ Turn the zoom touch adjustment ring towards the word SMOOTH to reduce the zooming touch, or towards TIGHT to increase it. To lock the zoom ring in place, turn the zoom touch adjustment ring towards TIGHT until it stops.

5. Image Stabilizer

You can use the image stabilizer in AF or MF mode.

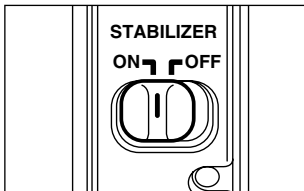

1 Set the STABILIZER switch to ON.

- If you are not going to use the image stabilizer function, set the switch to OFF.

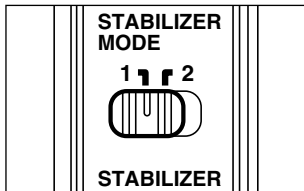

2 Select the stabilizer mode.

- **MODE 1:** Corrects vibrations in all directions. It is mainly effective for shooting still subjects.
- **MODE 2:** Corrects vertical camera shake during following shots in a horizontal direction, and corrects horizontal camera shake during following shots in a vertical direction.

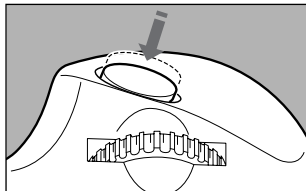

3 When you press the shutter button halfway, the Image Stabilizer will start operating.

- Make sure the image in the viewfinder is stable, then press the shutter button the rest of the way down to take the picture.

6. Tips on Using the Image Stabilizer

The image stabilizer in this lens is effective for hand-held shots under the following conditions.

● MODE 1



ON

OFF

- In semi-darkened areas such as indoors or outdoors at night.
- In locations where flash photography is prohibited, such as art museums and theater stages.
- In situations where your footing is uncertain.
- In situations where fast shutter settings cannot be used.

● MODE 2



ON

OFF

- When panning subjects in motion.

Tips on Using the Image Stabilizer

- The Image Stabilizer cannot compensate for a blurred shot caused by a subject that moved.
 - Set the STABILIZER switch to OFF when using the camera on a tripod. If the switch is set to ON, the Image Stabilizer may introduce errors.
 - Set the STABILIZER switch to OFF when you are taking pictures using the Bulb setting (long exposures). If the STABILIZER switch is set to ON, the image stabilizer function may introduce errors.
 - The Image Stabilizer might not be fully effective in the following cases:
 - You shoot from a violently moving vehicle.
 - You move the camera dramatically for a panning shot in Mode 1.
 - You shoot using techniques other than following shots in Mode 2.
 - The Image Stabilizer consumes more power than normal shooting, so fewer shots can be taken if you use the function.
 - The image stabilizer operates for about two seconds even when your finger is off the shutter button. Do not remove the lens while the stabilizer is in operation. This will cause a malfunction.
 - With the EOS-1V/HS, 3, ELAN 7E/ELAN 7/30/33, ELAN 7NE/ELAN 7N/30V/33V, ELAN II/ELAN II E/50/50E, REBEL 2000/300, IX, IX Lite/IX7, and D30, the Image Stabilizer will not work during self-timer operation.
- The stabilizer is equally effective for hand-held photography and photography with a monopod.
 - The image stabilizer function also operates when the lens is used with an extension tube EF12 II or EF25 II.
 - When using extender EF1.4× II/EF2× II, you can use the Image Stabilizer with the following cameras: EOS-1Ds Mark III, EOS-1Ds Mark II, EOS-1Ds, EOS-1D Mark III, EOS-1D Mark II N, EOS-1D Mark II, EOS-1D, EOS 40D, 30D, 20D, 20Da, 10D, 5D, EOS DIGITAL REBEL XSi/EOS 450D, EOS DIGITAL REBEL XT/400D DIGITAL, EOS DIGITAL REBEL XT/350D DIGITAL, EOS DIGITAL REBEL/300D DIGITAL, EOS D60, D30, EOS DCS1, DCS3, D2000, D6000, EOS-1V/HS, EOS-1N/DP/HS/RS, 3, ELAN 7E/ELAN 7/30/33, ELAN 7NE/ELAN 7N/30V/33V, ELAN II/ELAN II E/50/50E, 3000/88, REBEL XS/500, REBEL 2000/300, REBEL Ti/300V, REBEL T2/300X, REBEL K2/3000V, IX, IX Lite/IX7
 - Depending on the camera there may be image shake, such as after releasing the shutter. However, this does not affect shooting.
 - If you set the camera's Custom Function to change the assigned button to operate the AF, the Image Stabilizer will operate when you press the newly assigned AF button.

7. Infinity Compensation Mark

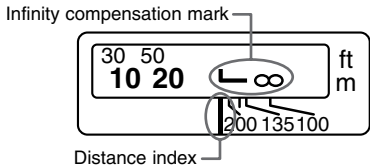

To compensate for shifting of the infinity focus point that results from changes in temperature. The infinity position at normal temperature is the point at which the vertical line of the L mark is aligned with the distance indicator on the distance scale.

- For accurate focusing in MF on subjects at infinity distance, look through the viewfinder while rotating the focusing ring.

8. Infrared Index

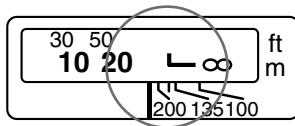

The infrared index corrects the focus setting when using monochrome infrared film. Focus on the subject in MF, then adjust the distance setting by moving the focusing ring to the corresponding infrared index mark. The intermediate marker between 200 and 135 is 150 mm.

- Some EOS cameras cannot use infrared film. See the instructions for your EOS camera.

- The infrared index position is based on a wavelength of 800 nm.
- The compensation amount differs depending on the focal length. Use the indicated focal length as a guide when setting the compensation amount.
- Be sure to observe the manufacturer's instructions when using infrared film.
- Use a red filter also when you take the picture.

9. Using the Tripod Mount

Adjusting the Tripod Mount

By loosening the orientation locking knob on the tripod mount you can rotate the camera to set the image for any vertical or horizontal position.

Detaching the Tripod Mount

First remove the lens from the camera and then remove the tripod mount from the lens as shown below. To attach the tripod mount, reverse the procedure.

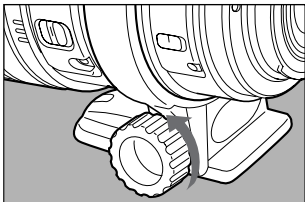

- 1** Loosen the orientation locking knob.

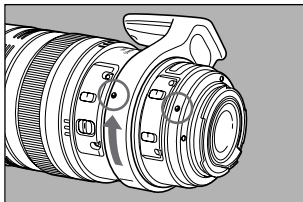

- 2** Align the red mark on the tripod mount with the lens mount index.

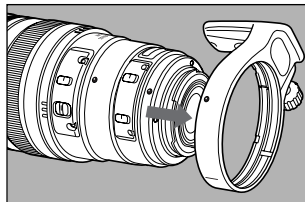

- 3** Slide off the tripod collar away from the rear of the lens.

10. Hood

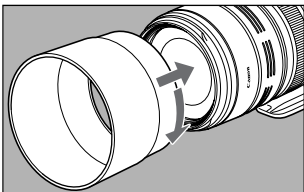

The ET-83C hood can keep unwanted light out of the lens, and also protects the lens from rain, snow, and dust. Fit the hood to the hood mount, then turn it in the direction of the arrow to attach it securely. The hood can be reverse-mounted on the lens for storage.

- Part of the picture may be blocked if the hood is not attached properly.
- When attaching or detaching the hood, grasp the base of the hood to turn it. To prevent deformation, do not grasp the rim of the hood to turn it.

11. Filters (Sold Separately)

You can attach filters to the filter mounting thread on the front of the lens.

- Use a polarizing Canon filter (77mm).
- To adjust the polarizing filter, first remove the lens hood.

12. Extension Tubes

(Sold Separately)

You can attach extension tube EF12 II or EF25 II for magnified shots. The shooting distance and magnification are shown below.

		Focusing Distance Range (mm)		Magnification (×)	
		Close distance	Long distance	Close distance	Long distance
EF12 II	100mm	755	1122	0.19	0.12
	400mm	1569	13224	0.25	0.03
EF25 II	100mm	544	666	0.35	0.27
	400mm	1393	6491	0.31	0.07

 MF mode is recommended for accurate focusing.

13. Close-up Lenses

(Sold Separately)

Attaching a close-up lens 500D (77mm) enables close-up photography. Magnification is from 0.80 to 0.21 times.

-  ● Close-up lens 250D cannot be attached because there is no size that fits the lens.
- MF mode is recommended for accurate focusing.

14. Extenders (Sold Separately)

Lens specifications when using extender EF1.4× II/EF2× II are as follows.

Item			With EF1.4× II Extender	With EF2× II Extender
Focal length (mm)			140 – 560	200 – 800
Aperture	1/3 steps	100mm	f/6.3 – 45	f/9 – 64
		400mm	f/8 – 57	f/11 – 81
	1/2 steps	100mm	f/6.7 – 45	f/9.5 – 64
		400mm	f/8 – 54	f/11 – 76
Angle of view	Diagonal		17° 35' – 4° 25'	12° – 3° 5'
	Vertical		9° 50' – 2° 25'	7° – 1° 40'
	Horizontal		14° 40' – 3° 40'	10° – 2° 35'
Maximum magnification (×)			0.28	0.41

- Attach the extender to the lens, and then attach the lens to the camera. To remove it, reverse the order. Errors may occur if you attach the extender to the camera first.
- When using extender EF1.4× II, the focusing mode is MF mode. However, AF shooting is possible only with the center focusing point when the camera is EOS-1Ds Mark III, EOS-1Ds Mark II, EOS-1Ds, EOS-1D Mark III, EOS-1D Mark II N, EOS-1D Mark II, EOS-1D, EOS-1V/HS, or EOS-3.
- When using extender EF2× II, the focusing mode is MF mode.
- Extenders cannot be used more than one at a time.
- Use –1/2 step exposure compensation for EF1.4× II, and –1 step exposure compensation for EF2× II when shooting with EOS A2/A2E/5.

Specifications

Focal Length/Aperture	100 – 400 mm f/4.5 – 5.6
Lens Construction	14 groups, 17 elements
Minimum Aperture	f/32 – 40 *
Angle of View	Diagonal: 24° – 6° 10' Vertical: 14° – 3° 30' Horizontal: 20° – 5° 10'
Min. Focusing Distance	1.8 m/5.9 ft.
Max. Magnification	0.2× (at 400 mm)
Field of View	Approx. 120 × 180 mm/4.7 × 7.1 inch (at 1.8 m/5.9 ft.)
Filter Diameter	77 mm/2.8 inch
Max. Diameter and Length	92 × 189 mm/3.6 × 7.4 inch
Weight	1380 g/48 oz
Hood	ET-83C
Lens Cap	E-77U
Case	LZ1324

* Values shown are for models with aperture settings shown in 1/3-stop increments. For models with 1/2-stop aperture increments, the values are f/32 to f/38.

- The lens length is measured from the mount surface to the front end of the lens. Add 21.5 mm when including the lens cap and dust cap.
- The size and weight listed are for the lens only, except as indicated.
- Aperture settings are specified on the camera. The camera automatically compensates for variations in the aperture setting when the camera is zoomed in or out.
- All data listed is measured according to Canon standards.
- Product specifications and appearance are subject to change without notice.

Canon

Free Manuals Download Website

<http://myh66.com>

<http://usermanuals.us>

<http://www.somanuals.com>

<http://www.4manuals.cc>

<http://www.manual-lib.com>

<http://www.404manual.com>

<http://www.luxmanual.com>

<http://aubethermostatmanual.com>

Golf course search by state

<http://golfingnear.com>

Email search by domain

<http://emailbydomain.com>

Auto manuals search

<http://auto.somanuals.com>

TV manuals search

<http://tv.somanuals.com>