

# Canon EF LENS

# EF70-300mm F4-5.6 IS USM

Instruction

IMAGE STABILIZER

**ULTRASONIC**

使用本镜头前，请仔细阅读本说明书。  
请将说明书妥善保存，以备将来参考。

# Thank you for purchasing a Canon USM lens.

Dedicated to EOS cameras, the Canon EF70-300mm f/4-5.6 IS USM lens is a high-performance telephoto zoom lens equipped with an Image Stabilizer.

The Image Stabilizer helps to prevent blurred shots during hand-held shooting at slow shutter speeds.

- “IS” stands for Image Stabilizer.
- “USM” stands for Ultrasonic Motor.

## Features

---

1. The Image Stabilizer gives the equivalent effect of a shutter speed three stops faster.
2. UD lens elements for excellent imaging performance.
3. The Image Stabilizer mode is available according to shooting conditions.
4. The zoom ring can be fixed at the widest position.
5. USM for fast, quiet focusing.
6. A truly round aperture hole results in a nicer background blur.

## Conventions used in this instruction



Warning to prevent lens or camera malfunction or damage.



Supplementary notes on using the lens and taking pictures.

## Safety Precautions

### Safety Precautions

1. **Do not look at the sun or a bright light source through the lens or camera.** Doing so could result in loss of vision. Looking at the sun directly through the lens is especially hazardous.
2. **Whether it is attached to the camera or not, do not leave the lens under the sun without the lens cap attached.** This is to prevent the lens from concentrating the sun's rays, which could cause a fire.

### Handling Cautions

**If the lens is taken from a cold environment into a warm one, condensation may develop on the lens surface and internal parts.** To prevent condensation in this case, first put the lens into an airtight plastic bag before taking it from a cold to warm environment. Then take out the lens after it has warmed gradually. Do the same when taking the lens from a warm environment into a cold one.

This device complies with Part 15 of the FCC Rules. Operation is subject to the following two conditions: (1) This device may not cause harmful interference, and (2) this device must accept any interference received, including interference that may cause undesired operation.

Do not make any changes or modifications to the equipment unless otherwise specified in the instructions. If such changes or modifications should be made, you could be required to stop operation of the equipment.

This equipment has been tested and found to comply with the limits for a class B digital device, pursuant to part 15 of the FCC Rules. These limits are designed to provide reasonable protection against harmful interference in a residential installation. This equipment generates, uses and can radiate radio frequency energy and, if not installed and used in accordance with the instructions, may cause harmful interference to radio communications.

However, there is no guarantee that interference will not occur in a particular installation. If this equipment does cause harmful interference to radio or television reception, which can be determined by turning the equipment off and on, the user is encouraged to try to correct the interference by one or more of the following measures:

- Reorient or relocate the receiving antenna.
- Increase the separation between the equipment and receiver.
- Consult the dealer or an experienced radio/TV technician for help.

This digital apparatus does not exceed the Class B limits for radio noise emissions from digital apparatus as set out in the interference-causing equipment standard entitled "Digital Apparatus", ICES-003 of the Industry Canada.



N118

# Nomenclature

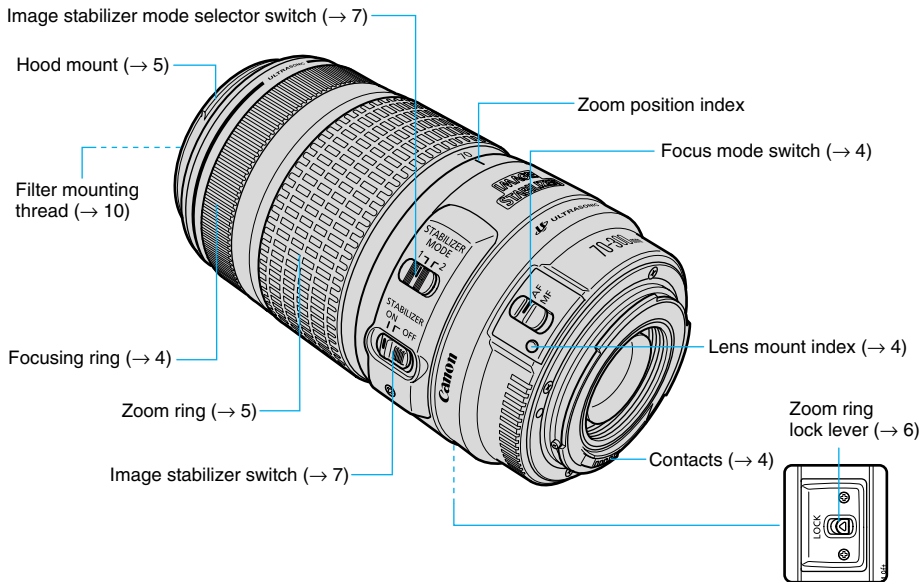

For detailed information, reference page numbers are provided in parentheses (→ \*\*).

## 1. Mounting and Detaching the Lens

See your camera's instructions for details on mounting and detaching the lens.

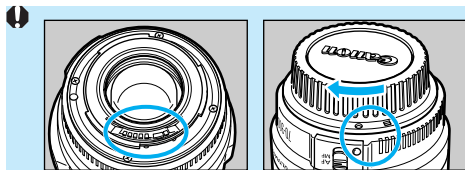

- After detaching the lens, place the lens with the rear end up to prevent the lens surface and electrical contacts from getting scratched.
- If the contacts get soiled, scratched, or have fingerprints on them, corrosion or faulty connections can result. The camera and lens may not operate properly.
- If the contacts get soiled or have fingerprints on them, clean them with a soft cloth.
- If you remove the lens, cover it with the dust cap. To attach it properly, align the lens mount index and the ○ index of the dust cap as shown in the diagram, and turn clockwise. To remove it, reverse the order.

## 2. Setting the Focus Mode

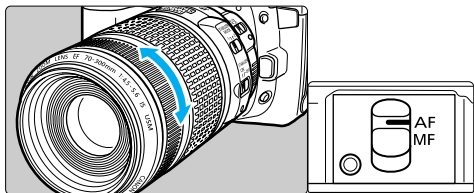

To shoot in autofocus mode, set the focus mode switch to AF.

To use only manual focusing, set the focus mode switch to MF, and focus by turning the focusing ring.

- Unless the focus mode switch is set to MF, you cannot focus manually.
- Do not touch the focusing ring or rotating parts of the lens while autofocus is in action.

### 3. Hood (Sold separately)

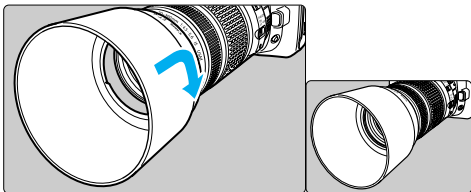

The ET-65B hood reduces annoying flare and also protects the front of the lens from rain, snow, dust, etc.

To attach the hood, connect the hood's tabs to the hood attachment tabs on the front end of the lens, then turn the hood clockwise to secure it. The hood can be reverse-mounted on the lens for storage.



- The front end of the lens rotates, so hold it when attaching the hood.
- Part of the picture may be blocked if the hood is not attached properly.
- When attaching or detaching the hood, grasp the base of the hood to turn it. To prevent deformation, do not grasp the rim of the hood to turn it.

### 4. Zooming

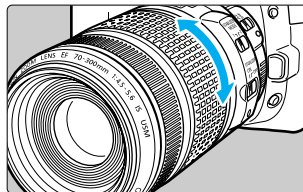

To zoom, turn the lens' zoom ring.



Be sure to finish zooming before focusing. Changing the zoom ring after focusing can affect the focus.

## 5. Fixing the Zoom Ring

The zoom ring can be fixed at the widest position. This function is convenient for carrying a camera on a strap because it prevents the lens from extending.

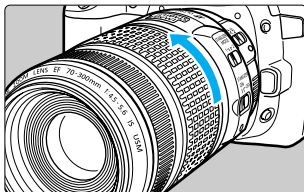
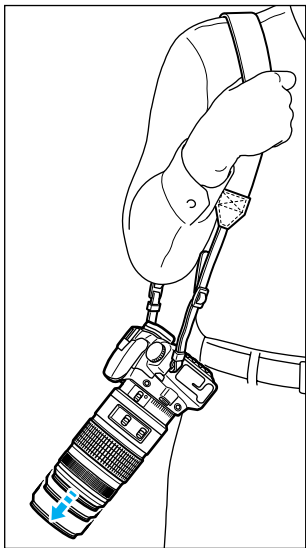

**1** Turn the zoom ring to the widest position (70mm).

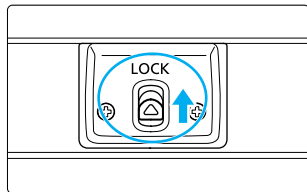

**2** Slide the zoom ring lock lever in the direction indicated by the arrow.

- To release the zoom ring, slide the zoom ring lock lever in the direction opposite to the arrow.



The zoom ring can only be locked at maximum wide angle.

## 6. Image Stabilizer

You can use the image stabilizer in AF or MF mode.

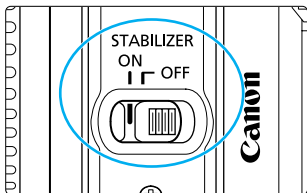

### 1 Set the STABILIZER switch to ON.

- If you are not going to use the image stabilizer function, set the switch to OFF.

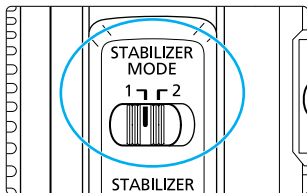

### 2 Selecting the Image Stabilizer mode.

- Use MODE 1 for normal photography. MODE 1 provides image stabilization in all directions.
- Use MODE 2 for continuous shots of moving subjects. MODE 2 provides image stabilization only in the direction of camera movement.

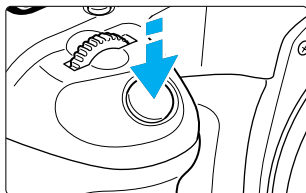

### 3 Press the shutter button halfway to verify the effect of the image stabilizer.

- Make sure the image in the viewfinder is stable, then press the shutter button the rest of the way down to take the picture.



## 7. Tips on Using the Image Stabilizer

The image stabilizer is effective particularly for hand-held shots under the following conditions.

### ● MODE 1



ON

OFF

- Dimly lit scenes, such as at dusk or indoors
- Locations such as art galleries or theater stages where flash photography is forbidden
- Situations in which your footing is uncertain

### ● MODE 2



ON

OFF

- If you are taking continuous shots of a moving subject
- If you are tracking an erratically moving subject

\* MODE 1 should be used in all other situations.

## Tips on Using the Image Stabilizer



- The Image Stabilizer cannot compensate for a blurred shot caused by a subject that moved.
- Set the STABILIZER switch to OFF when you are taking pictures using the Bulb setting (long exposures). If the STABILIZER switch is set to ON, the image stabilizer function may introduce errors.
- The Image Stabilizer might not be fully effective in the following cases:
  - You move the camera for a panned shot.
  - You shoot while riding on a bumpy road.
- Compared to using a normal non-IS lens, fewer shots can be taken when you use an Image Stabilizer lens because more power is consumed.
- The image stabilizer operates for about two seconds even when your finger is off the shutter button. Do not remove the lens while the stabilizer is in operation. This will cause a malfunction.



- With the EOS-1V/HS, 3, 30/33/Elan7/7E, 30V/33V/Elan7N/7NE, Elan II/Elan II E/50/50 E, 300/Rebel2000, IX, and D30, the Image Stabilizer will not work during self-timer operation.



- When you use a tripod, the Image Stabilizer should be turned off to save battery power.
- The stabilizer is equally effective for hand-held photography and photography with a monopod.
- The image stabilizer function also operates when the lens is used with an Extension Tube EF12 II or EF25 II.
- If you set the camera's Custom Function to change the assigned button to operate the AF, the Image Stabilizer will operate when you press the newly assigned AF button.

## 8. Filters (Sold separately)

**You can attach filters to the filter mounting thread on the front of the lens.**



- The front end of the lens rotates, so hold it when attaching the filter.
- Only one filter may be attached.
- If you need a polarizing filter, use Canon's PL-C 58mm polarizing filter.
- To adjust the polarizing filter, first remove the lens hood.
- When the PL-C 58mm polarizing filter is attached, the lens cap cannot be attached.

## 9. Gelatin Filter Holder (Sold separately)

With the Gelatin Filter Holder, you can use filters to create various effects.

The Gelatin Filter Holder compatibility is shown below.

- Gelatin Filter Holder III:  
Compatible (Up to two hoods can be used)
- Gelatin Filter Holder IV:  
Compatible (Up to three hoods can be used)



Focus manually when the Gelatin Filter Holder is used.

## 10. Extension Tubes (Sold separately)

With Extension Tube EF 12 II or EF 25 II, the camera-to-subject distance and image magnification will be as follows:

		Camera-to-Subject Distance (mm)		Magnification	
		Near	Far	Near	Far
EF12 II	70mm	584	638	0.22×	0.17×
	300mm	1361	7629	0.32×	0.04×
EF25 II	70mm	420	428	0.40×	0.38×
	300mm	1254	3890	0.39×	0.09×

 When an Extension Tube is attached, focus manually.

## 11. Close-up Lenses (Sold separately)

Attaching a 500/500D or 250D (58mm) Close-up Lens enables close-up photography. The magnification will be as follows:

	Magnification	
	500/500D	250D
70mm	0.14× - 0.22×	0.29× - 0.38×
300mm	0.58× - 0.90×	Incompatible

-  Sales of the 500 Close-up Lens may already be terminated in some areas.
- When using a Close-up Lens, focus manually.

# Specifications

<b>Image Size</b>	24 × 36 mm
<b>Focal Length/Aperture</b>	70-300 mm f/4-5.6
<b>Lens Construction</b>	10 groups, 15 elements
<b>Minimum Aperture</b>	f/32-45
<b>Angle of View</b>	Diagonal: 34° - 8° 15'    Vertical: 19° 30' - 4° 35'    Horizontal: 29° - 6° 50'
<b>Min. Focusing Distance</b>	1.5 m/4.9 ft.
<b>Max. Magnification</b>	0.26 × (at 300 mm)
<b>Field of View</b>	approx. 394 × 596 mm - 92 × 136 mm/15.5 × 23.5 inch - 3.6 × 5.4 inch (at 1.5 m)
<b>Filter Diameter</b>	58 mm/2.3 inch
<b>Max. Diameter and Length</b>	76.5 × 142.8 mm/3.0 × 5.6 inch
<b>Weight</b>	630 g/22.2 oz
<b>Hood</b>	ET-65B (Sold separately)
<b>Lens Cap</b>	E-58U
<b>Case</b>	LP1222 (Sold separately)

- The lens length is measured from the mount surface to the front end of the lens. Add 21.5 mm when including the lens cap and dust cap.
- The size and weight listed are for the lens only, except as indicated.
- Aperture settings are specified on the camera.
- The EF1.4X II/EF2X II extenders cannot be used with this lens.
- All data listed is measured according to Canon standards.
- Product specifications and appearance are subject to change without notice.

# Canon

## Free Manuals Download Website

<http://myh66.com>

<http://usermanuals.us>

<http://www.somanuals.com>

<http://www.4manuals.cc>

<http://www.manual-lib.com>

<http://www.404manual.com>

<http://www.luxmanual.com>

<http://aubethermostatmanual.com>

Golf course search by state

<http://golfingnear.com>

Email search by domain

<http://emailbydomain.com>

Auto manuals search

<http://auto.somanuals.com>

TV manuals search

<http://tv.somanuals.com>