

Canon

# KT17ex4.3B

*Superb performance in 1/3 inch HDTV lens series*



**INNOVATION**  
In TV Optics Since 1958



# KT17ex4.3B **HDGC**

## Canon's Philosophy :

Canon has always developed new technology with four basic philosophies, "High Quality of Picture", "Ease of Operation", "High Specification" and "Minimize Environmental Impact". Canon's HDTV lenses are, so to speak, a compilation of our basic philosophies. Now, Canon reassembles these philosophies in the launching of a second generation HDgc lens series.

## Superb performance in 1/3 inch HDTV lens series

The recent expansion of HDTV broadcasting has seen the range of HD camcorders with interchangeable lenses increasingly encompass the 1/3-inch image format size. This format size offers a more compact, mobile, and cost effective HD acquisition system. In support of these 1/3-inch systems, Canon had earlier released two lenses – the KT20x5B high-performance model and the KT14x4.4B KRS multipurpose model. They have proven popular in cost-effective HD program origination. Now Canon introduces a new 1/3-inch lens specifically tailored to HD ENG and lower-budget HD production. The KT17ex4.3B IRSE offers a modest wide-angle field of view, and generous focal range that is further augmented with a 2x extender.



## Main Features

### Excellent operational performance with 2x extender and ergonomic Digital Drive unit

To meet the flexible shooting needs of broadcast News and General HD production, it is desirable that the lens combine high optical performance with rich operational features. The KT17ex4.3B IRSE lens was designed to squarely meet these requirements. High attention to overall optical performance is allied with excellent optomechanical ruggedness, an ergonomic digital drive unit identical to that used in the highest-end Canon lenses, and the all-important 2x extender.

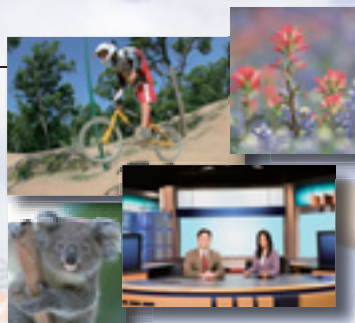

### Outstanding Optical Performance

Canon mobilized the best in optical design and optical materials to produce a lens worthy of the best in contemporary 1/3-inch camera systems. Advanced optical and optomechanical design have produced a remarkably compact and lightweight lens. The KT17ex4.3B IRSE deploys large aspheric lens elements design to enhance corner resolution while tightly controlling comatic aberration and geometric distortion. A range of optical glass elements include the use of Fluorite and Hi-UD glasses identical to those used in the high-end HD lenses. Lens contrast is extended, flare and veiling glare reduced, chromatic aberration is lowered, center and corner resolution elevated – all combining to produce a significant enhancement to overall picture sharpness.



Specially designed optical lens elements

### Improved Operability and Reduced Operator Fatigue

Coupled with innovations in optical performance, is a totally new design of the digital drive unit. Refined by long-term market research and worldwide experience, Canon utilized the latest in 3D CAD-CAM design to significantly improve the human tactile interface to the control of zoom, iris, and focus. Canon's research produced the following physical enhancements:



#### Reduced Physical Stress

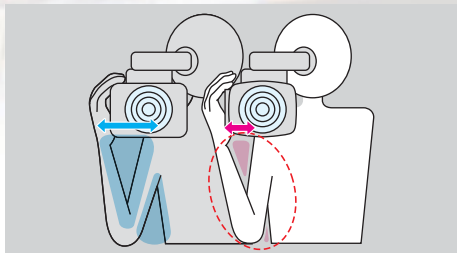

By reducing the width of the drive unit, the palm of the camera operator's hand is positioned closer to the optical axis, thus reducing the degree of arm bend which in turn lessens physical stress during prolonged shooting.

#### Improved Ease of Operation

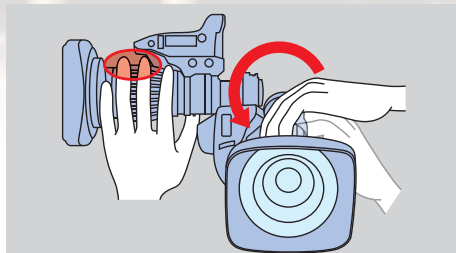

The spacing between the focus ring and drive unit has been opened to avoid accidental interference with the drive unit while manipulating the focus control.

#### Ergonomic Design

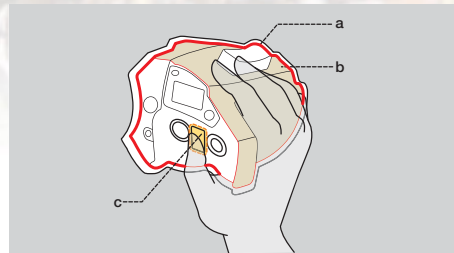

The size and curvature size have been optimized to more comfortably fit in the palm of the operator's hand (a). Newly developed coatings improve the tactile interface between the user and the drive unit (b) together with the new Rubber Grip Support (c).



## Enhanced Digital Drive Unit

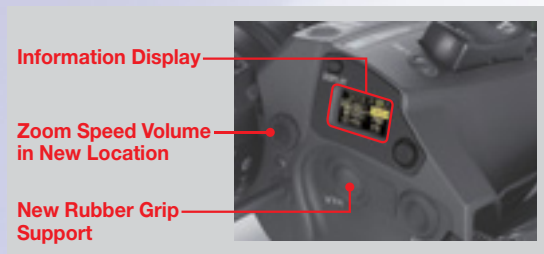

With the introduction of miniature 16-bit high resolution Rotary Encoder Devices into the enhanced digital drive unit, the lens features;

- Superior precision lens control.
- Precise repeatability in zoom, focus and iris control which supports the creative digital operational functions.
- Simple integration into virtual digital studio systems without any options.
- Dynamic zoom speed range of 0.5 sec. to over a 5 min. super slow zoom.

Moreover, Canon's original Information Display is able to customize the enhanced digital functions much more easily and precisely.

## Enhanced Digital Functions

### Shuttle Shot

By memorizing any two focal lengths, the Digital Drive can automatically "shuttle" between the two points, moving in either direction.

### Frame Preset

An angle of view can be preset in either of two memories and the lens will zoom at the highest speed or in a preset zoom speed to the preset position by pushing a simple button.

### Speed Preset

A specific zoom speed can be preset in memory and it is possible to repeat the zoom speed as often as you like by pushing a simple button.

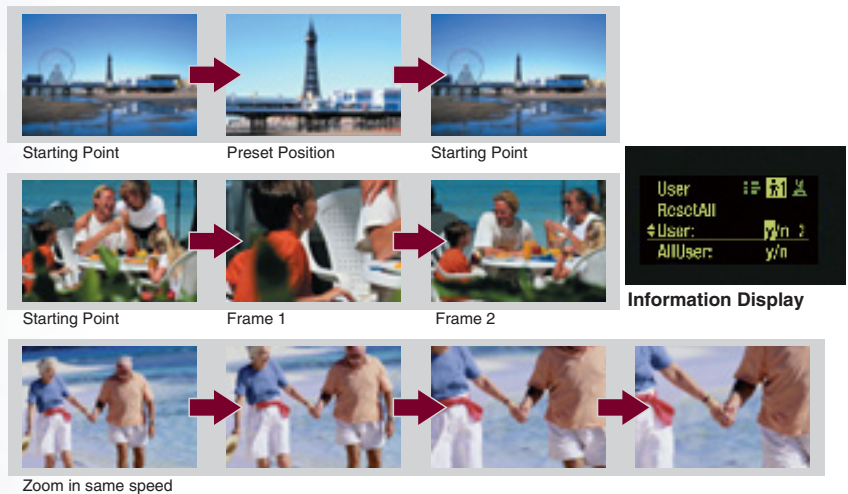

## SPECIFICATIONS

### KT17ex4.3B IRSE

	16:9		4:3	
	1.0x	2.0x	1.0x	2.0x
Built-in extender	1.0x	2.0x	1.0x	2.0x
Zoom Ratio	17x			
Range of Focal Length	4.3–73mm	8.6–146mm	4.3–73mm	8.6–146mm
Maximum Relative Aperture	1:1.4 at 4.3–73mm	1:2.8 at 8.6–146mm	1:1.4 at 4.3–73mm	1:2.8 at 8.6–146mm
Angular Field of View	62.6°×37.7° (at 4.3mm) 4.1°×2.3° (at 73mm)	33.8°×19.4° (at 8.6mm) 2.1°×1.2° (at 146mm)	58.3°×45.4° (at 4.3mm) 3.8°×2.8° (at 73mm)	31.2°×23.6° (at 8.6mm) 1.9°×1.4° (at 146mm)
Minimum Object Distance (M.O.D)	0.6m(10mm with Macro)			
Object Dimensions at M.O.D	66.9×37.6cm at 4.3mm 4.1×2.3cm at 73mm	33.5×18.8cm at 8.6mm 2.1×1.2cm at 146mm	61.5×46.1cm at 4.3mm 3.8×2.9cm at 73mm	30.8×23.1cm at 8.6mm 1.9×1.5cm at 146mm
Approx. Size	W×H×L=159.3×106.6×197.3mm			
Approx. Mass	1.48Kg(3.26lbs)			

## LENS CONTROLLERS

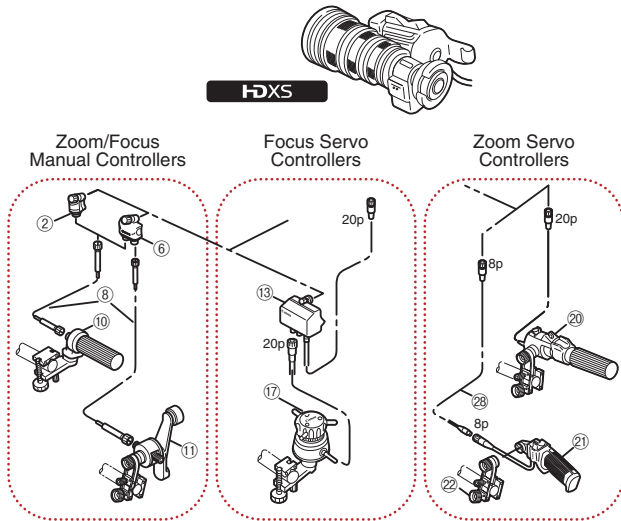

#	Unit	Description	#	Unit	Description
2	FFM-100	Flex Focus Module	17	FPD-400D	Focus Positional Demand
6	FFM-200	Flex Dual Module	20	ZSD-300D	Zoom Servo Demand
8	FC-40	Flex Cable	21	ZSG-200M	Zoom Servo Grip
10	FFC-200	Flex Focus Controller	22	CR-10	Clamper
11	FZC-100	Flex Zoom Controller	28	EC-80	Zoom Extension Cable (8P)
13	FPM-420D	Focus Positional Servo Module			

## DIMENSIONS

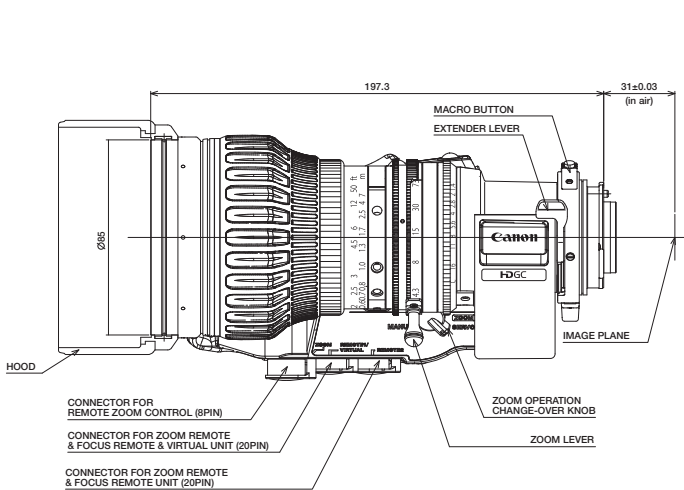

## OPTICAL ACCESSORIES

### 1. CONVERTERS/ATTACHMENTS

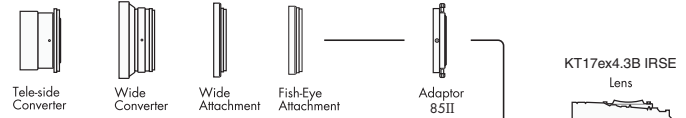

### 2. FILTERS ※1

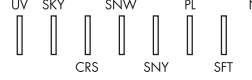

### 3. CLOSE UP LENSES

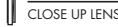

TYPE	MODEL	TYPE	MODEL
Tele-side Converter	T15-II	Ultra Violet	UV/82P0.75
	T15HD-2 ※2	Sky Light	SKY/82P0.75
Wide Converter	W80-IIIb	Cross Screen	CRS/82P0.75
	W80HD ※2	Snow Cross	SNW/82P0.75
Wide Attachment	WA75-II	Sunny Cross	SNY/82P0.75
	WA75HD ※2	Polarized Light	PL/82P0.75
Fish-eye Attachment	FEA-IIIb	Soft	SFT/82P0.75
	FEA-HD ※2	ND4(25%Transmittance)	ND4/82P0.75
Adaptor	Adaptor85II	ND8(12.5%Transmittance)	ND8/82P0.75
		Close Up Lens	82CL-UP800H
		Close Up Lens	82CL-UP1300H

※1 The filters are to be attached to front of lens.

※2 The HD quality accessories offer higher optical performance.

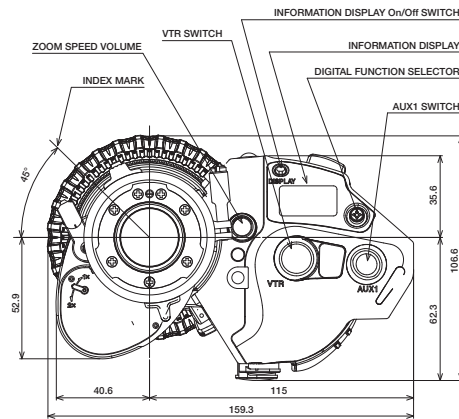

**North & South America**  
**Canon U.S.A., Inc.**  
 Broadcast & Communications Div.(Headquarters)  
 65 Challenger Road, Ridgefield Park, NJ 07660  
 Tel:(201)807-3300/(800)321-4388  
 Fax:(201)807-3333  
 Email:bctv@cusa.canon.com  
<http://www.canonbroadcast.com/>

**Chicago**  
 100 Park Blvd. Itasca, IL 60143  
 Tel:(630)250-6236 Fax:(630)250-0399

**Atlanta**  
 5625 Oakbrook Pkwy. Norcross, GA 30093  
 Tel:(770)849-7890 Fax:(770)849-7888

**Los Angeles**  
 15955 Alton Parkway Irvine, CA 92618  
 Tel:(949)753-4330 Fax:(949)753-4337

**Dallas**  
 3200 Regent Blvd. Irving, TX 75063  
 Tel:(972)409-8871 Fax:(972)409-8869

**Latin America**  
 Tel:(954)349-6975 Fax:(201)807-3333

**Canada**  
**Canon Canada, Inc.**  
 Broadcast and Communications Div.  
 6390 Dixie Road  
 Mississauga, Ontario, L5T 1P7, Canada  
 Tel:(905)795-2012 Fax:(905)795-2140

**Europe/Africa/Middle East**  
**Canon Europa N.V.**  
 Broadcast and Communications Div.  
 Bovenkerkerweg 59-61  
 1185 XB Amstelveen  
 Tel:+31(0)20-5458905 Fax:+31(0)20-5458203  
 Email:tvprod@canon-europe.com  
<http://www.canon-europe.com/tv-products>

**Australia**  
**Canon Australia Pty. Ltd.**  
 Optical Products Division  
 1 Thomas Holt Drive, North Ryde, NSW 2113,  
 Australia  
 Tel:+61(0)2-9805-2000 Fax:+61(0)2-9805-2444

**Asia/Japan**  
**Canon Inc.**  
**(Broadcast Equipment Group)**  
 23-10, Kiyohara-Kogyo-Danchi, Utsunomiya-shi,  
 Tochigi-ken, 321-3298, Japan  
 Tel:+81(0)28-667-8669 Fax:+81(0)28-667-8672  
<http://www.canon.com/bctv>

Distributed by

## Free Manuals Download Website

<http://myh66.com>

<http://usermanuals.us>

<http://www.somanuals.com>

<http://www.4manuals.cc>

<http://www.manual-lib.com>

<http://www.404manual.com>

<http://www.luxmanual.com>

<http://aubethermostatmanual.com>

Golf course search by state

<http://golfingnear.com>

Email search by domain

<http://emailbydomain.com>

Auto manuals search

<http://auto.somanuals.com>

TV manuals search

<http://tv.somanuals.com>