

Canon

EOS 5D

DIGITAL



Exif Print

DPOF

PictBridge

DIRECT
PRINT

BUBBLE JET
DIRECT

E

INSTRUCTION
MANUAL

Download from www.Somanuals.com. All Manuals Search And Download.

Canon
EOS 5D
DIGITAL

INSTRUCTION MANUAL

Thank you for purchasing a Canon product.

The EOS 5D is a high-performance, digital AF SLR camera with a large, 35.8 x 23.9mm CMOS sensor with 12.8 effective megapixels. The camera has nine high-precision AF points, and it is compatible with all Canon EF lenses (except EF-S lenses). Designed for quick shooting at all times, the camera has many features for all types of shooting from fully automatic snapshooting to creative work.

Before using the camera, try it out while reading this Instruction Manual to familiarize yourself with camera operations.

To prevent accidents and damage, read the Safety Warnings (p.8,9) and Handling Precautions (p.10,11).

Test the Camera Before Using

Before using the camera, take a few test shots and check that the images are properly recorded on the memory card.

If the camera or memory card is faulty and the images cannot be recorded or read by a personal computer, Canon cannot be held liable for any loss or inconvenience caused.

Copyrights

Copyright laws in your country may prohibit the use of your recorded images of people and certain subjects for anything but private enjoyment. Also be aware that certain public performances, exhibitions, etc., may prohibit photography even for private enjoyment.

- Canon and EOS are trademarks of Canon Inc.
- Adobe and Photoshop are trademarks of Adobe Systems Incorporated.
- CompactFlash is a trademark of SanDisk Corporation.
- Windows is a trademark or registered trademark of Microsoft Corporation in the United States and other countries.
- Macintosh is a registered trademark of Apple Corporation in the United States and other countries.
- All other corporate names and trademarks mentioned in this manual are the property of their respective owners.

* This digital camera supports Design rule for Camera File System 2.0 and Exif 2.21 (also called "Exif Print"). Exif Print is a standard that enhances compatibility between digital cameras and printers. By connecting to an Exif Print-compliant printer, the shooting information is incorporated to optimize the print output.

Item Check List

Check that all the following items have been included with your camera. If anything is missing, contact your dealer.

- EOS 5D** / Camera body (with Eyecup, body cap and lithium backup battery for the date and time)
 - Battery Pack BP-511A** (with protective cover)
 - Battery Charger CG-580/CB-5L** * CG-580 or CB-5L is included.
 - Power code for battery charger** * For CB-5L.
 - Interface Cable IFC-400PCU**
 - Video Cable VC-100**
 - Wide Strap EW-100DGR** (with eyepiece cover)
-
- EOS DIGITAL Solution Disk** (CD-ROM)
 - Software Instruction Manual** (CD-ROM, PDF)
-
- Pocket Guide**
Quick start guide to shooting.
 - EOS 5D INSTRUCTION MANUAL** (this booklet)
 - Software Guide**
Gives an overview of the bundled software and explains the software installation procedure.
-
- Warranty card of camera**
-

* Be careful not to lose any of the above items.

* **No CF card (for recording images) is included.** Please purchase it separately. CF cards made by Canon are recommended.

Contents

Introduction

Item Check List.....	3
Contents at a Glance.....	6
Handling Precautions	10
Quick Start Guide	12
Nomenclature	14
Conventions Used in this Manual	20

1 Getting Started 21

Recharging the Battery.....	22
Installing and Removing the Battery.....	24
Using a Household Power Outlet	26
Mounting and Detaching a Lens.....	27
Installing and Removing the CF Card.....	28
Basic Operation	30
Menu Operations	33
Setting the Language	38
Set the power-off time/Auto power off	39
Setting the Date and Time.....	40
Replacing the Date/Time Battery.....	41
Cleaning the CMOS sensor.....	42
Dioptic Adjustment	44
Holding the Camera.....	44

2 Fully Automatic Shooting 45

Using Full Auto	46
Self-timer Operation	48

3 Image Settings 49

Setting the Image-recording Quality.....	50
Selecting a Picture Style.....	53
Customizing the Picture Style.....	55
Registering the Picture Style	58
Setting the ISO Speed.....	60
Setting the White Balance	61
Custom White Balance	62
Setting the Color Temperature	63
White Balance Correction.....	64
White Balance Auto Bracketing.....	65
Setting the Color Space	67
Creating and Selecting a Folder	68
File Numbering Methods	70
Checking Camera Settings.....	72

4 Setting the AF, Metering, and Drive Modes 73

Selecting the AF Mode	74
-----------------------------	----

Selecting the AF Point.....	77
Focusing an Off-Center Subject.....	79
When Autofocus Fails (Manual Focusing)	80
Selecting the Metering Mode	81
Selecting the Drive Mode.....	82

5 Advanced Operations 83

Program AE.....	84
Shutter-Priority AE	86
Aperture-Priority AE	88
Depth of Field Preview	89
Manual Exposure	90
Setting Exposure Compensation.....	92
Auto Exposure Bracketing (AEB)	93
AE Lock.....	95
Bulb Exposures	96
Mirror Lockup	97
LCD Panel Illumination.....	98
Using the Eyepiece Cover	98
You can also silence the beeper	99
CF Card Reminder	99
Flash Photography	100
Using Non-Canon Flash Units.....	102

6 Image Playback 103

Setting the Image Review Time	104
Auto Image Rotation	105
Setting the LCD Brightness.....	106
Image Playback.....	107
Single image display, Index Display, Magnified View.....	107 - 111
Auto playback, Rotating an Image.....	112 - 113
Jump Display.....	114
Viewing the Images on a TV	116
Protecting Images	117
Erasing Images	118
Formatting the CF Card	120

7 Direct Printing from the Camera 121

Preparing to Print	123
PictBridge / CP Direct / Bubble Jet Direct	126 - 135
Easy Printing	138

8 DPOF: Digital Print Order Format 139

9 Customizing the Camera 147



10 Reference 159



Contents at a Glance

Image Quality

- **Set picture effects** → p.53 (Selecting a Picture Style)

- **Set custom picture effects** → p.55
(Customizing the Picture Style)

- **Print the image to a large size** → p.50 ( **L**,  **L**, **RAW**)

- **Take many photos** → p.50 ( **S**,  **S**)

- **Adjust the color tone** → p.64 (WB correction)

- **Take black-and-white or sepia photos** → p.53 (Monochrome)

Focusing

- **Change the AF point** → p.77 ( Selecting the AF point)

- **Select the AF point quickly** → p.154 (C.Fn-13-1/2)

- **Photograph a still subject** → p.75 (One-Shot AF)

- **Photograph a moving subject** → p.75 (AI Servo AF)

Drive

- **Take continuous shots** → p.82 ( Continuous shooting)

- **Take a picture of myself** → p.48 ( Self-timer)

Shooting

- **Shoot fully automatically** → p.46 (Using Full Auto)

-
- **Freeze or blur the action** → p.86 (**Tv** Shutter-priority AE)

 - **Blur or the background or make everything look sharp**
→ p.88 (**Av** Aperture-priority AE)

 - **Adjust the image brightness (exposure)**
→ p.92 (Exposure compensation)

 - **Photograph fireworks** → p.96 (Bulb exposures)

 - **Photograph dark scenes** → p.100 (Flash photography)
-

Image Playback and Printing

- **View images with the camera** → p.107 ( Playback)

 - **Erase an image** → p.118 ( Erase)

 - **Prevent accidental erasure of an image** → p.117 ( Protect)

 - **View images on TV** → p.116 (Video OUT)

 - **Print images easily** → p.121 (Direct printing)

 - **Adjust the LCD monitor brightness** → p.106 (LCD brightness)
-

Power Source

- **Use a household power outlet** → p.26 (AC adapter kit)

 - **Change the auto power off time** → p.39 (Auto power off)
-

Safety Warnings

Follow these safeguards and use the equipment properly to prevent injury, death, and material damage.

Preventing Serious Injury or Death

- To prevent fire, excessive heat, chemical leakage, and explosions, follow the safeguards below:
 - Do not use any batteries, power sources, and accessories not specified in this booklet. Do not use any home-made or modified batteries.
 - Do not short-circuit, disassemble, or modify the battery pack or back-up battery. Do not apply heat or apply solder to the battery pack or back-up battery. Do not expose the battery pack or back-up battery to fire or water. And do not subject the battery pack or back-up battery to strong physical shock.
 - Do not install the battery pack or back-up battery in reversed polarity (+ -). Do not mix new and old or different types of batteries.
 - Do not recharge the battery pack outside the allowable ambient temperature range of 0°C - 40°C (32°F - 104°F). Also, do not exceed the recharging time.
 - Do not insert any foreign metallic objects into the electrical contacts of the camera, accessories, connecting cables, etc.
- Keep the back-up battery away from children. If a child swallows the battery, consult a physician immediately. (Battery chemicals may harm the stomach and intestines.)
- When disposing of a battery pack or back-up battery, insulate the electrical contacts with tape to prevent contact with other metallic objects or batteries. This is to prevent fire or an explosion.
- If excessive heat, smoke, or fumes are emitted during battery pack recharging, immediately unplug the battery charger from the power outlet to stop the recharging and prevent a fire.
- If the battery pack or back-up battery leaks, changes color, deforms, or emits smoke or fumes, remove it immediately. Be careful not to get burned in the process.
- Prevent any battery leakage from contacting your eyes, skin, and clothing. It can cause blindness or skin problems. If the battery leakage contacts your eyes, skin, or clothing, flush the affected area with lots of clean water without rubbing it. See a physician immediately.
- During the recharging, keep the equipment away from the reach of children. The cord can accidentally choke the child or give an electrical shock.
- Do not leave any cords near a heat source. It can deform the cord or melt the insulation and cause a fire or electrical shock.
- Do not fire the flash at someone driving a car. It may cause an accident.
- Do not fire the flash near a person's eyes. It may impair the person's vision. When using flash to photograph an infant, keep at least 1 meter away.
- Before storing the camera or accessory when not in use, remove the battery pack and disconnect the power plug. This is to prevent electrical shock, heat generation, and fire.
- Do not use the equipment where there is flammable gas. This is to prevent an explosion or fire.

-
- If you drop the equipment and the casing breaks open to expose the internal parts, do not touch the internal parts due to the possibility of electrical shock.
 - Do not disassemble or modify the equipment. High-voltage internal parts can cause electrical shock.
 - Do not look at the sun or an extremely bright light source through the camera or lens. Doing so may damage your vision.
 - Keep the camera from the reach of small children. The neck strap can accidentally choke the child.
 - Do not store the equipment in dusty or humid places. This is to prevent fire and electrical shock.
 - Before using the camera inside an airplane or hospital, check if it is allowed. Electromagnetic waves emitted by the camera may interfere with the plane's instruments or the hospital's medical equipment.
 - To prevent fire and electrical shock, follow the safeguards below:
 - Always insert the power plug all the way in.
 - Do not handle a power plug with wet hands.
 - When unplugging a power plug, grasp and pull the plug instead of the cord.
 - Do not scratch, cut, or excessively bend the cord or put a heavy object on the cord. Also do not twist or tie the cords.
 - Do not connect too many power plugs to the same power outlet.
 - Do not use a cord whose insulation has been damaged.
 - Occasionally unplug the power plug and use a dry cloth to clean off the dust around the power outlet. If the surrounding is dusty, humid, or oily, the dust on the power outlet may become moist and short-circuit the outlet to cause a fire.
-

Preventing Injury or Equipment Damage

- Do not leave equipment inside a car under the hot sun or near a heat source. The equipment may become hot and cause skin burns.
 - Do not carry the camera around while it is attached to a tripod. Doing so may cause injury. Also make sure the tripod is sturdy enough to support the camera and lens.
 - Do not leave a lens or lens-attached camera under the sun without the lens cap attached. Otherwise, the lens may concentrate the sun's rays and cause a fire.
 - Do not cover or wrap the battery-recharging apparatus with a cloth. Doing so may trap heat within and cause the casing to deform or catch fire.
 - If you drop the camera in water or if water or metal fragments enter inside the camera, promptly remove the battery pack and back-up battery. This is to prevent fire and electrical shock.
 - Do not use or leave the battery pack or back-up battery in a hot environment. Doing so may cause battery leakage or a shorter battery life. The battery pack or back-up battery can also become hot and cause skin burns.
 - Do not use paint thinner, benzene, or other organic solvents to clean the equipment. Doing so may cause fire or a health hazard.
-

If the product does not work properly or requires repair, contact your dealer or your nearest Canon Service Center.

Handling Precautions

Camera Care

- This camera is a precision instrument. Do not drop it or subject it to physical shock.
- The camera is not waterproof and cannot be used underwater. If you accidentally drop the camera into water, promptly consult your nearest Canon Service Center. Wipe off any water droplets with a dry cloth. If the camera has been exposed to salty air, wipe with a well-wrung wet cloth.
- Never leave the camera near anything having a strong magnetic field such as a magnet or electric motor. Also avoid using or leaving the camera near anything emitting strong radio waves such as a large antenna. Strong magnetic fields can cause camera misoperation or destroy image data.
- Do not leave the camera in excessive heat such as in a car in direct sunlight. High temperatures can cause the camera to malfunction.
- The camera contains precision electronic circuitry. Never attempt to disassemble the camera yourself.
- Use a blower to blow away dust on the lens, viewfinder, mirror, and focusing screen. Do not use cleaners that contain organic solvents to clean the camera body or lens. For stubborn dirt, take the camera to a Canon Service Center.
- Do not touch the camera's electrical contacts with your fingers. This is to prevent the contacts from corroding. Corroded contacts can cause camera misoperation.
- If the camera is suddenly brought in from the cold into a warm room, condensation may form on the camera and internal parts. To prevent condensation, first put the camera in a sealed plastic bag and let it adjust to the warmer temperature before taking it out of the bag.
- If condensation forms on the camera, do not use the camera. This is to avoid damaging the camera. If this occurs, remove the lens, CF card and battery from the camera, and wait until the condensation has evaporated before using the camera.
- If the camera will not be used for an extended period, remove the battery and store the camera in a cool, dry, well-ventilated location. Even while the camera is in storage, press the shutter button a few times once in a while to check that the camera is still working.
- Avoid storing the camera where there are corrosive chemicals such as a darkroom or chemical lab.
- If the camera has not been used for an extended period, test all its functions before using the camera. If you have not used the camera for some time or if there is an important shoot coming up, have the camera checked by your Canon dealer or check the camera yourself and make sure it is working properly.

LCD Panel and LCD Monitor

- Although the LCD monitor is manufactured with very high precision technology with over 99.99% active pixels, there might be a few dead pixels among the remaining 0.01% or less pixels. Dead pixels displaying only black or red, etc., are not a malfunction. They do not affect the images recorded.
- At low temperatures, the liquid-crystal display response may become slower. And at high temperatures, the display may blacken. In either case, the display will return to normal at room temperature.

CF Card

- The CF card is a precision device. Do not drop the memory card or subject it to vibration. Doing so could damage the images recorded on them.
- Do not store or use a memory card near anything having a strong magnetic field such as a TV set, speakers, or magnet. Also avoid places prone to having static electricity. Otherwise, the images recorded on the CF card might be lost.
- Do not leave memory cards in direct sunlight or near a heat source. Doing so can warp the cards and make them unusable.
- Do not spill any liquid onto the CF card.
- Always store your CF cards in a case to protect the data stored on them.
- Non-Canon CF cards may not be able to record and playback images. Using Canon CF cards is recommended.
- Do not bend the card or subject it to any excessive force or physical shock.
- Do not store CF cards in hot, dusty, or humid locations.

Lens Electrical Contacts

After detaching the lens from the camera, attach the lens caps or put down the lens with the rear end up to avoid scratching the lens surface and electrical contacts.



Quick Start Guide

1

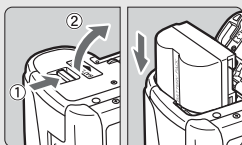

Insert the battery. (p.24)

To recharge the battery, see page 22.

2

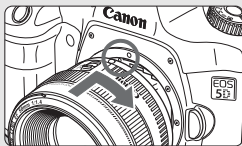

Attach the lens. (p.27)

Align the red dot.

3

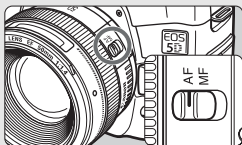

Set the lens focus mode switch to <AF>. (p.27)

4

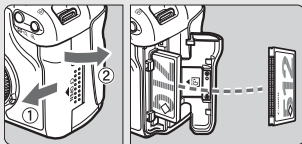

Open the cover and insert a CF card. (p.28)

Face the label side toward you and insert the end with the small holes into the camera.

5

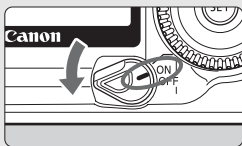

Set the power switch to <ON>. (p.30)

6



Set the Mode Dial to <□> (Full Auto). (p.46)

All the necessary camera settings will be set automatically.

7



Focus the subject. (p.30)

Aim the AF point over the subject and press the shutter button halfway to autofocus.

8

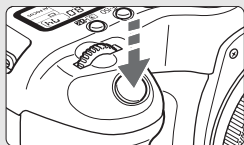

Take the picture. (p.30)

Press the shutter button fully to take the picture.

9



Review the picture on the LCD monitor. (p.104)

The captured image will be displayed for about 2 sec. on the LCD monitor.

- To view images captured so far, see “Image Playback” (p.107).
- To delete an image, see “Erasing Images” (p.118).

Nomenclature

For detailed information, reference page numbers are provided in parentheses (p. **).

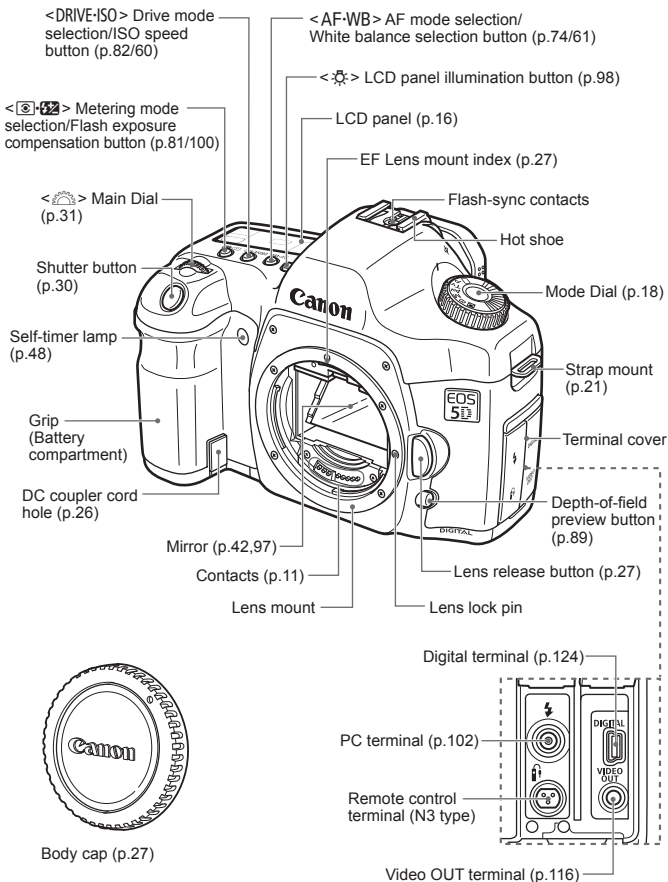

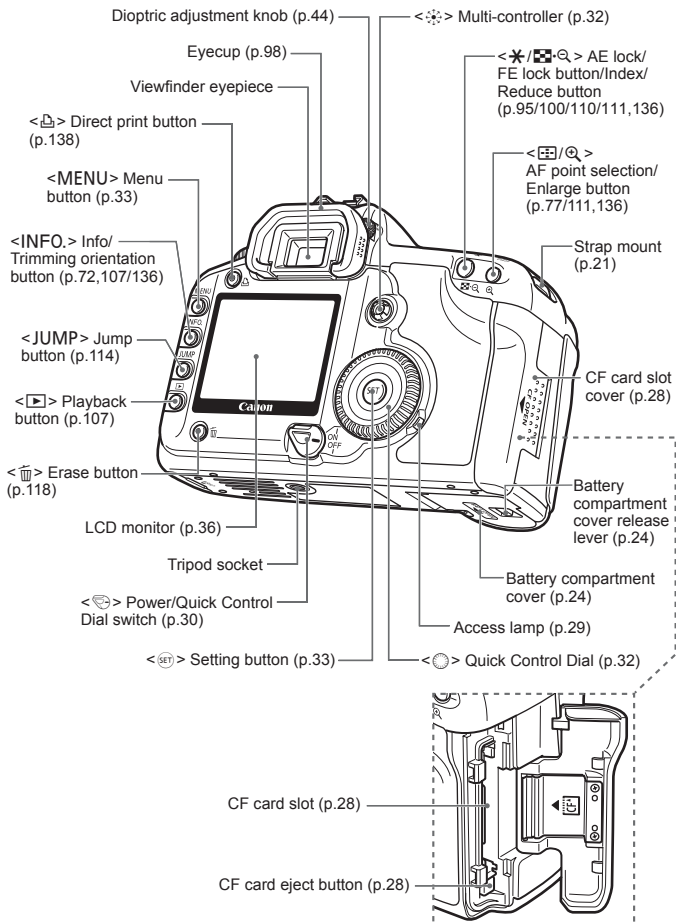

LCD Panel

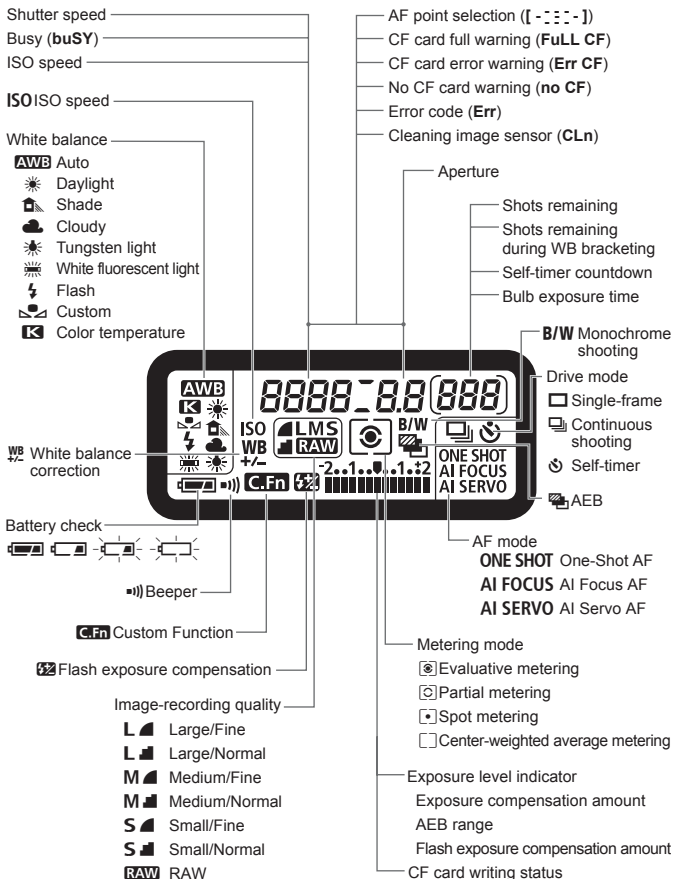

The actual display will show only the applicable items.

Viewfinder Information

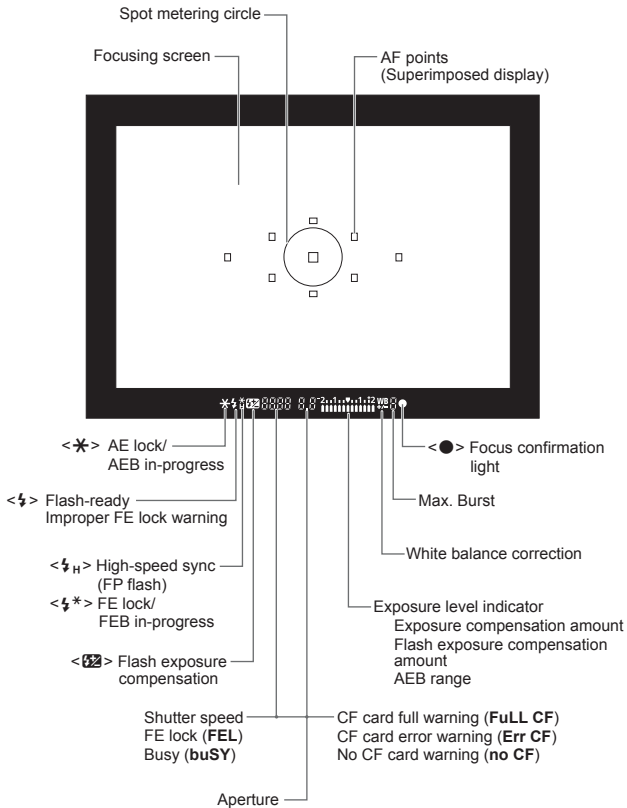

The actual display will show only the applicable items.

Mode Dial

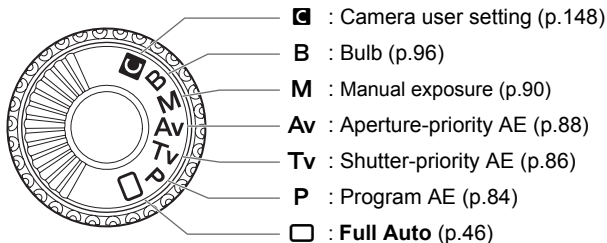

Battery Charger CG-580

This is a battery pack charger. (p.22)

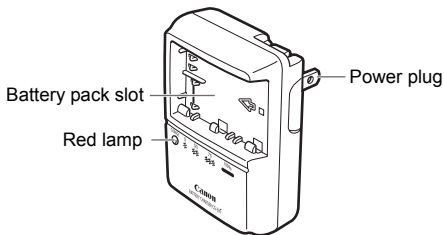

Battery Charger CB-5L

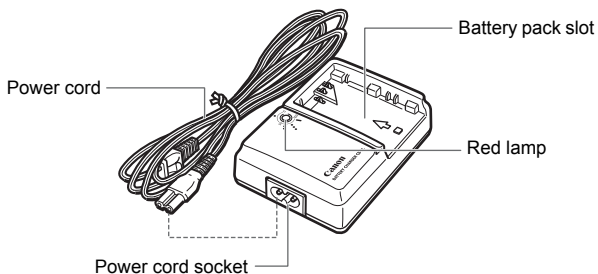

This is a battery pack charger. (p.22)



Do not use any AC adapters or compact power adapters other than the ones (rated input: 100-240 V AC, 50/60 Hz, rated output: 7.8-8.1 V DC) shown on the system map (p.168). Using such incompatible adapters may result in fire, overheating, or electrical shock.

Conventions Used in this Manual





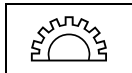

- In the text, the  icon indicates the power switch.
- All operations described in this manual assume that the  switch is set to <ON> or .

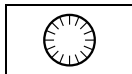

- The  icon indicates the Main Dial.



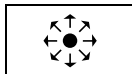

- The  icon indicates the Quick Control Dial.
- Operations with the  dial assume that the  switch is already set to . Be sure it is set to .



- In the text, the  icon indicates the Multi-controller.



- In the text, the  icon indicates the SET button. It is used for menu functions and Custom Functions.

- In this manual, the icons and markings indicating the camera's buttons, dials, and settings correspond to the icons and markings on the camera.
- For more information, reference page numbers are provided in parentheses (p. **).
- The asterisk ★ appended on the right of the page title indicates that the respective feature cannot be changed in the  (Full Auto) mode.
- The procedures assume that the menu settings and Custom Functions are set to the default settings.
- The **MENU** icon indicates that the setting can be changed with the menu.
- (🕒4), (🕒6) or (🕒16) indicates that the respective function remains active for 4 sec., 6 sec., or 16 sec. respectively after you let go of the button.
- This manual uses the following alert symbols:

 : The Caution symbol indicates a warning to prevent shooting problems.

 : The Note symbol gives supplemental information.

1

Getting Started

This chapter explains a few preliminary steps and basic camera operations.

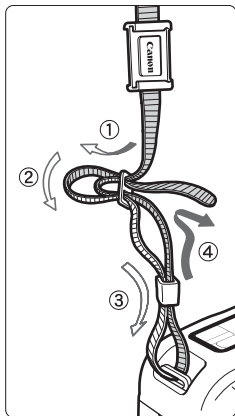

Attaching the Strap

Pass the end of the strap through the camera's strap mount from the bottom. Then pass it through the strap's buckle as shown in the illustration. Pull the strap to take up any slack and make sure the strap will not loosen from the buckle.

- The eyepiece cover is also attached to the strap. (p.98)

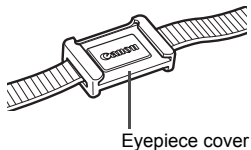

Recharging the Battery

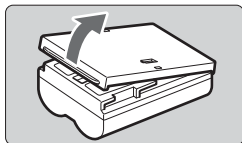

1 Remove the cover.

- When you remove the battery from the camera, be sure to reattach the cover to protect against short circuit.

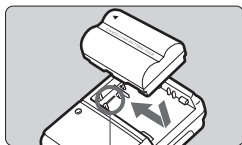

2 Attach the battery.

- Align the battery front edge with the \leftrightarrow mark on the battery charger. While pressing down the battery, slide it in the direction of the arrow.
- To detach the battery, follow the above procedure in reverse.

\leftrightarrow mark

CG-580

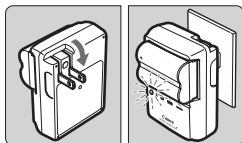

3 For CG-580

Flip out the prongs and recharge the battery.

- As shown by the arrow, flip out the battery charger's prongs.
- Insert the prongs into a power outlet.

CB-5L

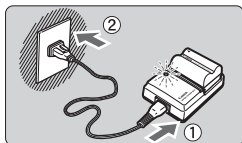

For CB-5L

Connect the power cord and recharge the battery.

- Connect the power cord to the charger and insert the plug into the power outlet.
- ▶ Recharging starts automatically and the red lamp starts blinking.
- ▶ **The recharging time for a completely exhausted battery is as follows:**
BP-511A and BP-514: Approx. 100 min.
BP-511 and BP-512: Approx. 90 min.

Recharge Level	Red lamp
0-50%	Blinks once per second
50-75%	Blinks twice per second
75-90%	Blinks three times per second
90% or higher	Lights on

- The numbers and markings on the battery charger correspond to the table on the left.



- Do not recharge any battery pack other than Battery Pack BP-511A, BP-514, BP-511, or BP-512.
- If the battery is left in the camera for a prolonged period without the camera being used, a low electrical current may be discharged excessively and the battery's service life may be affected. When not using the camera, remove the battery and attach the protective cover to prevent shorting. Before using the camera again, be sure to recharge the battery.
- Storing the battery while fully charged may reduce its service life or performance.
- Battery Packs BP-511A, BP-514, BP-511, and BP-512 are dedicated to Canon products. Using them with a non-Canon battery charger or product may result in malfunction or accidents for which Canon cannot be held liable.



- **After the red lamp lights, continue to recharge the battery for an hour to attain a full charge.**
- Even a recharged, unused battery will gradually drain its power. Recharge the battery on the day before or on the day you plan to use it.
- By referring to the marking, you can attach the protective cover to the battery to indicate whether the battery has been recharged or not.
- After recharging the battery, detach it and unplug the power cord from the power outlet.
- The time required to recharge the battery depends on the ambient temperature and battery's recharge level.
- The battery pack can operate in temperatures from 0°C to 40°C (32°F to 104°F). However, for full operating performance, using it between 10°C (50°F) and 30°C (86°F) is recommended. In cold locations such as ski areas, battery performance temporarily decreases and the operating time may be shorter.
- If operating time is sharply reduced even after normal recharging, the battery pack may have reached its service life. Replace it with a new battery.

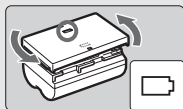

Installing and Removing the Battery

Installing the Battery

Load a fully charged BP-511A battery pack into the camera.

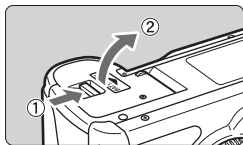

1 Open the battery compartment cover.

- Slide the lever as shown by the arrow and open the cover.

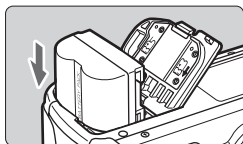

2 Insert the battery.

- Point the battery contacts downward.
- Insert the battery until it locks into place.

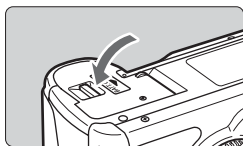



3 Close the cover.

- Press the cover until it snaps shut.

 Battery Pack BP-514, BP-511, or BP-512 can also be used.

Checking the Battery Level

When the  switch is set to <ON> or  (p.30), the battery level will be indicated at one of four levels.

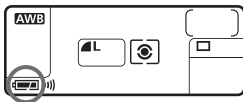

 : Battery level OK.

 : Battery level is low.

 : Battery will be exhausted soon.

 : Battery must be recharged.

Battery Life

Temperature	Shots remaining
At 20°C / 68°F	Approx. 800
At 0°C / 32°F	Approx. 400

- The figures above are based on a fully-charged BP-511A and CIPA (Camera & Imaging Products Association) testing criteria.



- The actual number of shots may be fewer than indicated above depending on the shooting conditions.
- The number of possible shots will decrease with more frequent use of the LCD monitor.
- Pressing the shutter button halfway for long periods or operating the autofocus only can reduce the number of possible shots.
- The number of possible shots with the BP-514 is the same as indicated in the table.
- The number of possible shots with the BP-511 or BP-512 will be about 75% of the figures in the table for 20°C. At 0°C, the figures will be about the same as in the table.

Removing the Battery

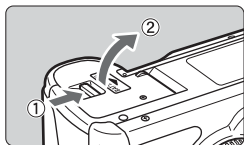

1 Open the battery compartment cover.

- Slide the lever as shown by the arrow and open the cover.

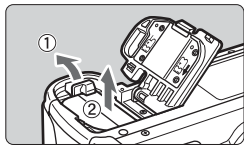

2 Remove the battery.

- Slide the battery lock lever as shown by the arrow and remove the battery.

Using a Household Power Outlet

With AC Adapter Kit ACK-E2 (optional), you can connect the camera to a household power outlet and not worry about the battery level.

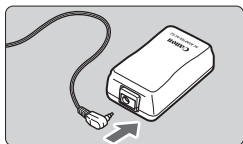

1 Connect the DC Coupler.

- Connect the DC Coupler's plug to the AC adapter's socket.

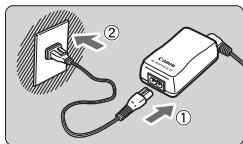

2 Connect the power cord.

- Connect the power cord to the AC adapter.
- Insert the plug into a power outlet.
- When you are finished, disconnect the plug from the power outlet.

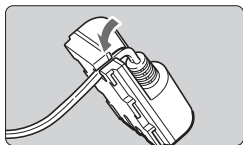

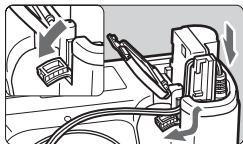

3 Place the cord in the groove.

- Carefully insert the cord into the groove without damaging it.



4 Insert the DC Coupler.

- Open the battery compartment cover and open the DC Coupler cord notch cover.
- Insert the DC Coupler until the lock position and put the cord through the notch.
- Close the cover.

 Do not connect or disconnect the power cord while the camera's  switch is set to <ON> or < >.

Mounting and Detaching a Lens

Mounting a Lens

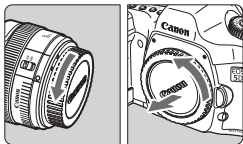

1 Remove the caps.

- Remove the rear lens cap and the body cap by turning them as shown by the arrow.

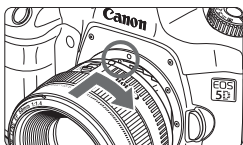

2 Attach the lens.

- Align the red dots on the lens and camera and turn the lens as shown by the arrow until it snaps in place.

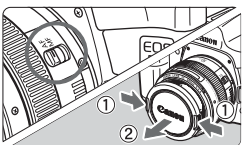

3 On the lens, set the focus mode switch to <AF>.

- If it is set to <MF>, autofocus will not be possible.

4 Remove the front lens cap.

Detaching the Lens

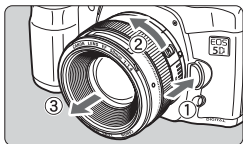

While pressing the lens release button, turn the lens as shown by the arrow.

- Turn the lens until it stops, then detach it.



When attaching or detaching the lens, take care to prevent dust from entering the camera through the lens mount.

Installing and Removing the CF Card

The captured image will be recorded onto the CF card (optional). Although the thickness is different, a Type I or Type II CF card can be inserted into the camera. The camera is also compatible with Microdrive and CF cards with 2 GB or higher capacity.

Installing the Card

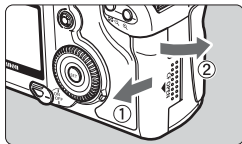

1 Open the cover.

- Slide the cover as shown by the arrow to open it.

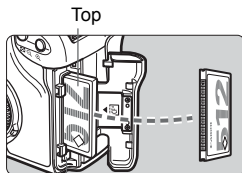

Top

CF card
eject button

2 Insert the CF card.

- Using Canon CF cards is recommended.
- **If the CF card is inserted in the wrong way, it may damage the camera. As shown by the arrow, face the label side toward you and insert the end with the small holes into the camera.**

▶ The CF card eject button pops out.

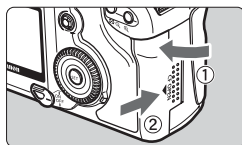

Shots remaining

3 Close the cover.

- Close the cover and slide it in the direction shown by the arrow until it snaps shut.
- ▶ When the switch is set to <ON> or , the shots remaining is displayed on the LCD panel.

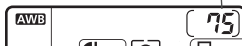

The shots remaining depends on the remaining capacity of the CF card or the image recording quality setting, the ISO speed setting, etc.

Removing the CF Card

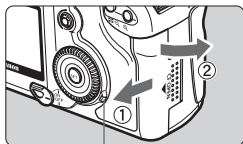

Access lamp

1 Open the cover.

- Turn the switch to <OFF>.
- Check that the “buSY” message is not displayed on the LCD panel.
- Make sure the access lamp is off, then open the cover.

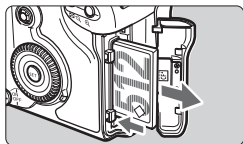

2 Remove the CF card.

- Press the Eject button.
- ▶ The CF card will be ejected.
- Close the cover.



- **When the access lamp is lit or blinking, it indicates that the images are being written to or read by the CF card or being erased. While the access lamp is lit or blinking, do not do any of the following. Doing so may damage the image data, CF card, or camera.**
 - Shaking or banging the camera around.
 - Open the CF card slot cover.
 - Removing the battery.
- If “Err CF” (Error CF) is displayed on the LCD panel, see page 120.
- If you use a low-capacity CF card, it might not be able to record large images.
- A Microdrive is vulnerable to vibration and physical shock. If you use a Microdrive, be careful not to subject the camera to vibration or physical shock especially while recording or displaying images.



On the menu, if you set the [ Shoot w/o card] to [Off], it will prevent shooting without a CF card. (p.99)

Basic Operation



Power Switch

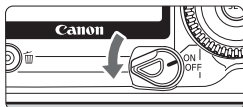

The camera can operate only after the <  > switch is turned on.



<OFF>: The camera is turned off and does not operate.

<ON> : The camera operates.

<  > : The camera and <  > operate. (p.32)

- To save battery power, the camera turns off automatically after 1 minute of non-operation. To turn on the camera again, press the shutter button or other button.
- You can change the auto power-off time with the menu's [**Auto power off**] setting. (p.39)
- If you turn the <  > switch to <OFF> while the captured images are being recorded onto the CF card, the remaining number of captured images to be recorded will be indicated on the top LCD panel with the number of <  >. When all the images are finished recording, the display will turn off and the camera will turn off.

Shutter Button

The shutter button has two steps. You can press the shutter button halfway. Then you can further press the shutter button completely.



Pressing halfway

This activates autofocus (AF) and automatic exposure (AE) that sets the shutter speed and aperture.

The exposure setting (shutter speed and aperture) is displayed on the top LCD panel and in the viewfinder. ( 4)

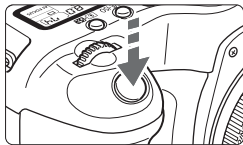

Pressing completely

This releases the shutter and takes the picture.



- If you press the shutter button halfway and (⌚4) elapse, you must press it halfway again and wait a moment before pressing it completely to take a picture. If you press the shutter button completely without pressing it halfway first or if you press the shutter button halfway and then press it completely immediately, the camera will take a moment before it takes the picture.
- No matter what state the camera is in (image playback, menu operation, image recording, etc.), you can return to shooting instantly just by pressing the shutter button halfway (except during direct printing).
- Camera movement during the moment of exposure is called camera shake. Camera shake can cause blurred pictures. To prevent camera shake, note the advice below. Also see “Holding the Camera” (p.44).
 - Hold the camera steady.
 - Put your finger tip on the shutter button, hold the camera with your right hand, then press the shutter button gently.

Operating the < > Dial

The <  > dial is mainly used for shooting-related settings.

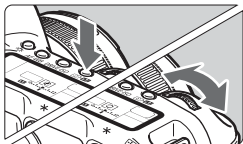

(1) After pressing a button, turn the < > dial.

When you press a button, its function remains active for 6 seconds (⌚6). During this time, you can turn the <  > dial to set the desired setting. When the timer runs out or if you press the shutter button down halfway, the camera will be ready to shoot.

- In this way, you can set the AF mode, drive mode, and metering mode and select or set the AF point.







(2) Turn the < > dial only.

While looking at the LCD panel or viewfinder, turn the <  > dial to set the desired setting.



- In this way, you can set the shutter speed, aperture, etc.

Operating the < > Dial

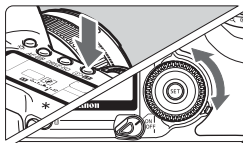
The <  > dial is mainly used for shooting-related settings and selecting LCD monitor items. When you want to use the <  > dial to prepare for shooting, set the <  > switch to <  > first.



(1) After pressing a button, turn the < > dial.

When you press a button, its function remains active for 6 seconds ( 6). During this time, you can turn the <  > dial to set the desired setting. When the timer ends or if you press the shutter button down halfway, the camera will be ready to shoot.

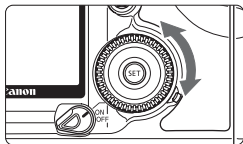

- You can select the AF point or set the white balance, ISO speed, and flash exposure compensation.
- When using the LCD monitor, you can select menu operations and select images during playback.



(2) Turn the < > dial only.

While looking at the LCD panel or viewfinder, turn the <  > dial to set the desired setting.

- You can set the exposure compensation or the aperture in the < **M** > mode.

 You can also operate (1) when the <  > switch is set to < ON >.

Operating the < >

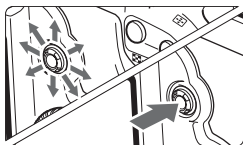

The <  > consists of eight direction keys and a button at the center. Use it to select an AF point, set white balance correction, scroll around a magnified image display, and move the trimming frame for direct printing.

Menu Operations

By setting various optional settings with the menus, you can set the image recording quality, Picture Style, the date/time, Custom Functions, etc. While looking at the LCD monitor, you use the <MENU> button, <SET> button, and <Q.C.D.> dial on the camera back to proceed to the next step.

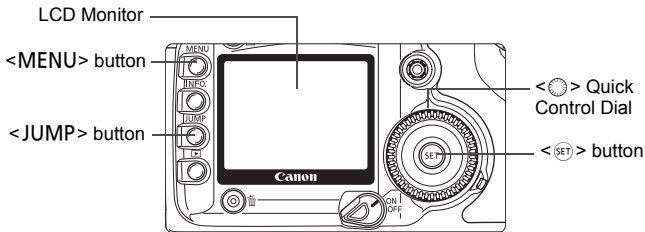

The menu screen is color coded for the three menu categories.

Icon	Color	Category	Description
	Red	Shooting menu	Shooting-related menu
	Blue	Playback menu	Image playback-related menu
	Yellow	Set-up menu	Camera's basic settings



- Press the <JUMP> button to jump to the first item of each menu category.
- You can use the <Q.C.D.> dial even when the <ON/OFF> switch is <ON>.
- Even while the menu is displayed, you can instantly go back to shooting by pressing the shutter button halfway.

Menu Setting Procedure



1 Display the menu.

- Press the <MENU> button to display the menu. To turn off the menu, press the button again.

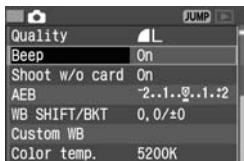

2 Select a menu item.

- Turn the <◉> dial to select the menu item, then press <SET>.
- Press the <JUMP> button to jump to the first item of each menu category.

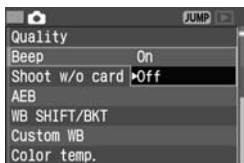

3 Select the menu setting.

- Turn the <◉> dial to select the desired setting.



4 Set the desired setting.

- Press <SET> to set it.

5 Exit the menu.

- Press the <MENU> button to exit the menu display.













- Certain menu items are not displayed in the <□> (Full Auto) mode. (p.35)
- You can also use the <◉> dial to select menu items or playback images.
- The explanation of menu functions hereinafter assumes that you pressed the <MENU> button to display the menu screen.
- Menu operation will also work after the picture is taken while the image is being recorded to the CF card (access lamp blinks).

Menu Settings



< > Shooting menu (Red)

Reference
pages

Quality	     / RAW/ RAW+  / +  / +  / +  / +  / + 	50
Beep	On / Off	99
Shoot w/o card	On / Off	99
AEB	1/3-stop increments, ± 2 stops	93
WB SHIFT/BKT	9 levels of B/A/M/G color bias / B/A and M/G bias 1 level, ± 3 levels	64,65
Custom WB	Manual setting of white balance	62
Color temp.	Set to 2800K - 10000K (100K increments)	63
Color space	sRGB / Adobe RGB	67
Picture Style	Standard / Portrait / Landscape / Neutral / Faithful / Monochrome / User Defined 1, 2, 3	53,55, 58

< > Playback menu (Blue)

Protect	Protect image	117
Rotate	Rotate image	113
Print order	Specifies images to be printed (DPOF).	139
Auto play	Auto playback of images	112
Review time	Off / 2 sec. / 4 sec. / 8 sec. / Hold	104
AF points	Display / Not display	108
Histogram	Bright. / RGB	109

-  Items not displayed in the <  > (Full Auto) mode.
- In the <  > (Full Auto) mode, the RAW and RAW+JPEG recording quality modes are not displayed.

<M> Set-up menu (Yellow)

Auto power off	1min. / 2 min. / 4 min. / 8 min. / 15 min. / 30 min. / Off	39
Auto rotate	On / Off	105
LCD brightness	5 levels	106
Date/Time	Setting the Date/Time	40
File numbering	Continuous / Auto reset / Manual reset	70
Select folder	Folder selection and creation	68
Language	15 languages provided (English, German, French, Dutch, Danish, Finnish, Italian, Norwegian, Swedish, Spanish, Russian, Simplified Chinese, Traditional Chinese, Korean, and Japanese.)	38
Video system	NTSC / PAL	116
Communication	Print/PTP / PC connect.	123
Format	Initializes and erases card	120
Custom Functions (C.Fn)	Customize the camera	149
Clear settings	Clear all camera settings (Reset the camera to the default settings.)	37
	Clear all Custom Functions (Resets all Custom Function settings to the default.)	150
	Clear registered camera set. (Resets the Mode Dial's <M> setting to the default.)	148
Register camera settings	Register current camera settings to the Mode Dial's <M> setting.	148
Sensor cleaning	Select to clean the sensor.	42
Image transfer (LAN) settings	Displayed when Wireless File Transmitter WFT-E1/E1A is used.	-
Firmware Ver.	Select to update the firmware.	-

-  Items not displayed in the <A> (Full Auto) mode.

About the LCD Monitor

- The LCD monitor cannot be used as a viewfinder for shooting.
- You can adjust the brightness of the LCD monitor to one of five levels. (p.106)

Restoring the Camera's Default Settings ★

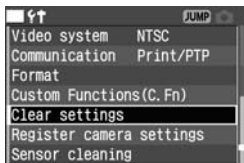

1 Select [Clear settings].

- Turn the <⦿> dial to select [**↑** Clear settings], then press <SET>.

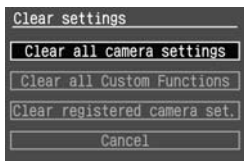

2 Select [Clear all camera settings].

- Turn the <⦿> dial to select [**Clear all camera settings**], then press <SET>.

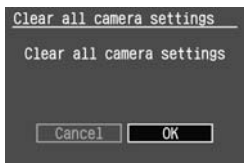

3 Select [OK].

- Turn the <⦿> dial to select [**OK**], then press <SET>. The default settings will be restored.
- ▶ The camera's default settings will be as shown below.

Shooting Settings

AF mode	One-Shot AF
AF point selection	Automatic AF point selection
Metering mode	Evaluative metering
Drive mode	Single shooting
Exposure compensation	0 (Zero)
AEB	Off
Flash exposure compensation	0 (Zero)
Custom Functions	Current settings retained

Image-Recording Settings

Quality	L
ISO speed	100
Color space	sRGB
White balance	AWB
Color temperature	5200K
WB correction	Off
WB-BKT	Off
Picture Style	Standard

- The Picture Styles will also be reset to their default settings.

MENU Setting the Language

The LCD monitor's interface language can be set to one of fifteen languages.

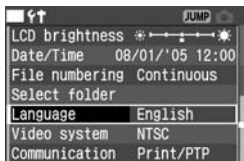

1 Select [Language].

- Turn the <⊙> dial to select [**Language**], then press <SET>.
- ▶ The Language screen will appear.



2 Set the desired language.

- Turn the <⊙> dial to select the language, then press <SET>.
- ▶ The language will change.

English	English
Deutsch	German
Français	French
Nederlands	Dutch
Dansk	Danish
Suomi	Finnish
Italiano	Italian
Norsk	Norwegian
Svenska	Swedish
Español	Spanish
Русский	Russian
简体中文	Simplified Chinese
繁體中文	Traditional Chinese
한국어	Korean
日本語	Japanese

MENU Set the power-off time/Auto power off

You can set the auto power-off time for the camera to turn off automatically after a set time of idle operation. If you do not want the camera to turn off automatically, set this to **[Off]**. After the power turns off, you can turn on the camera again by pressing the shutter button or other button.

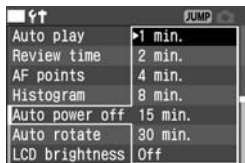

1 Select **[Auto power off]**.

- Turn the <⦿> dial to select **[Auto power off]**, then press <SET>.

2 Set the desired time.

- Turn the <⦿> dial to select the desired time, then press <SET>.



- After auto power off, you can turn on the camera again with any of the following buttons: Shutter button, <DRIVE-ISO> button, and <MENU> button. Pressing the <⦿>, <🗑️>, or <JUMP> button will not turn on the camera.
- If auto power off is **[OFF]**, and the LCD monitor is left on, the LCD monitor will turn off after 30 min.

MENU Setting the Date and Time

Set the date and time as shown below.

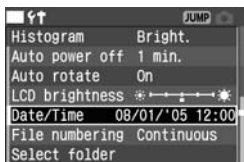

1 Select [Date/Time].

- Turn the dial to select [Date/Time], then press .
- ▶ The date/time screen will appear.

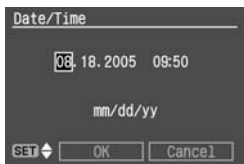

2 Set the date and time.

- Pressing the button toggles the orange box between and .
- With the box displayed, turn the dial to select the date or time to be corrected, then press .
- With the box displayed, turn the dial to select the correct numeral, then press .

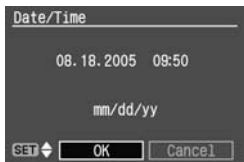

3 Confirm the setting.

- With the box displayed, turn the dial to select [OK], then press .
- ▶ The date/time will be set and the menu will reappear. The minute that was set will then start from 0 sec.

Each captured image is recorded with the date and time it was taken. If the date and time are not properly set, the wrong date/time will be recorded. Make sure you set the date and time correctly.

Replacing the Date/Time Battery

The date/time (back-up) battery maintains the camera's date and time. The battery's service life is about 5 years. If the date/time is reset when the battery is replaced, replace the back-up battery with a new CR2016 lithium battery as described below.

The date/time setting will also be reset, so you must set the correct date/time.

1 Turn the  switch to <OFF>.

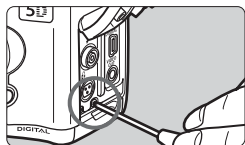

2 Unscrew the battery holder screw.

- Use a small Philips screwdriver.
- Be careful not to lose the screw.

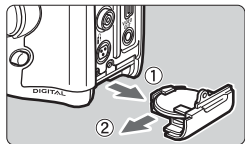

3 Take off the battery holder.

- Push out the battery in direction ②.

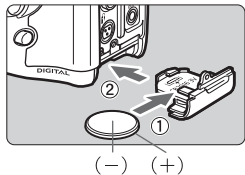

4 Replace the battery in the battery holder.

- Make sure the battery is in the proper + - orientation.

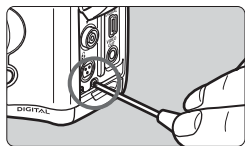

5 Tighten the battery holder screw.

 For the date/time battery, be sure to use a CR2016 lithium battery.

MENU Cleaning the CMOS sensor [★]

The image sensor is like the film in a film camera. If any dust adheres on the image sensor, it may show up as a dark speck on the images. To avoid this, follow the procedure below to clean the image sensor. Using the AC Adapter Kit ACK-E2 (optional, see page 166) is recommended. If you use a battery, make sure the battery level is sufficient.

1 Install the DC Coupler (p.26) or a battery and turn the <☺> switch to <ON>.

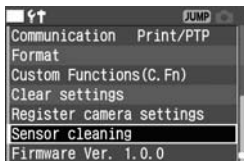

2 Select [Sensor cleaning].

- Turn the <☉> dial to select [**☽** **Sensor cleaning**], then press <SET>.
- ▶ If you are using a battery with sufficient power, the screen shown in step 3 will appear.
- If the battery is exhausted, a warning message will appear and you will not be able to proceed further. Either recharge the battery or use a DC coupler and start from step 1 again.

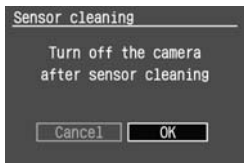

3 Select [OK].

- Turn the <☉> dial to select [**OK**], then press <SET>.
- ▶ The mirror will lock up and the shutter will open.
- ▶ “CLn” will blink on the LCD panel.

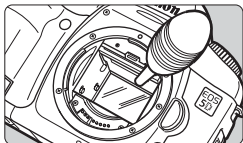

4 Clean the image sensor.

- Use a rubber blower to carefully blow away any dust, etc., on the surface of the image sensor.

5 Stop the cleaning.

- Turn the <☺> switch to <OFF>.
- ▶ The camera will turn off, the shutter will close, and the mirror will go back down.
- Set the <☺> switch to <ON>. The camera will then be ready to shoot.



- **During the sensor cleaning, never do any of the following that would turn off the power. If the power is cut off, the shutter will close and it may damage the shutter curtains and image sensor.**
 - Turn the <☺> switch to <OFF>.
 - Open the CF card slot cover.
 - Open the battery compartment cover.
- Do not insert the blower tip inside the camera beyond the lens mount. If the power goes out, the shutter will close and the shutter curtains and image sensor may be damaged.
- Use a blower not attached with a brush. A brush can scratch the sensor.
- Never use canned air or gas to clean the sensor. The blowing force can damage the sensor or the spray gas can freeze on the sensor.
- When the battery is exhausted, the beeper will sound and the <☺> icon will blink on the LCD panel. Set the <☺> switch to <OFF> and replace the battery. Then start over again.
- You cannot clean the sensor if Battery Grip BG-E4 (optional) is attached to the camera and size-AA batteries supply the power. Use AC Adapter Kit ACK-E2 (optional) or use a battery having sufficient power.

If you cannot remove all of the dust, consult a Canon Service Center.

Dioptic Adjustment

By adjusting the diopter to suit your eyesight, you can see a sharp viewfinder image even without eyeglasses. The camera's adjustable dioptic range is -3 to +1 dpt.

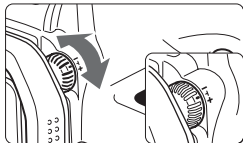

Turn the dioptic adjustment knob.

- Turn the knob left or right so that the AF points in the viewfinder look sharp.
- The illustration shows the knob at the standard setting (-1 dpt).

If the camera's dioptic adjustment still cannot provide a sharp viewfinder image, using Dioptic Adjustment Lens E (10 types, optional) is recommended.

Holding the Camera

To obtain sharp images, hold the camera still to minimize camera shake.

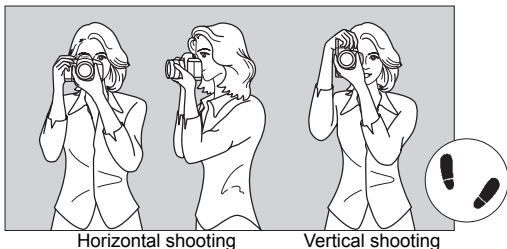

- Firmly grasp the camera grip with your right hand, and press your both elbows lightly against your body.
- Hold the lens bottom with your left hand.
- Press the camera against your face and look through the viewfinder.
- To maintain a stable stance, place one foot in front of the other instead of lining up both feet.

Using Full Auto

All you do is point the camera and press the shutter button for quick and easy shooting. With nine AF points to focus the subject, anyone can easily take nice pictures.



1 Set the Mode Dial to <Full Auto>.

- ▶ Automatically, the AF mode will be set to <AI FOCUS>, the drive mode will be set to <Single>, and the metering mode will be set to <Matrix>.

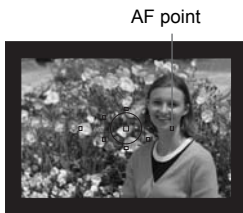

2 Aim any AF point over the subject.

- Out of the nine AF points, the one covering the closest subject is selected automatically to achieve focus.

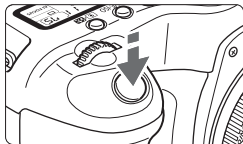

3 Focus the subject.

- Press the shutter button halfway to focus.
- ▶ The AF point which achieves focus flashes in red briefly. At the same time, the beeper will sound and the focus confirmation light <Red dot> in the viewfinder will light.

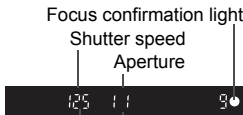

4 Check the display.

- ▶ The shutter speed and aperture value will be set automatically and displayed in the viewfinder and on the LCD panel.



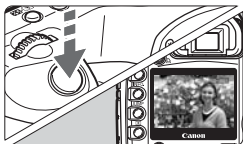

5 Take the picture.

- Compose the shot and press the shutter button completely.
- ▶ The captured image will be displayed for about 2 sec. on the LCD monitor.
- To view the images recorded on the CF card, press the <▶> button. (p.107)



- If you want to zoom, do it before focusing. Turning the zoom ring after achieving focus may throw off the focus.
- When the CF card becomes full, the CF Full warning "**FuLL CF**" will appear in the viewfinder and on the LCD panel and shooting will be disabled. Replace the CF card with one that has room.
- Using a non-Canon lens with an EOS camera may not result in proper camera or lens operation.



- When focus is achieved, the focus and exposure setting will also be locked.
- If the focus confirmation light <●> blinks, the picture cannot be taken. (p.80)
- Multiple AF points may flash simultaneously in red. This indicates that focus has been achieved at all those AF points.
- You can disable the beeper from sounding when focus is achieved. (p.99)
- The image review time after image capture can be changed with the menu's [**▶ Review time**] setting. (p.104)
- If you want to select the AF point to be used for focusing, set the Mode Dial to <P>, then follow "Selecting the AF Point" (p.77) to select the AF point.

Self-timer Operation

Use the self-timer when you want to be in the picture.

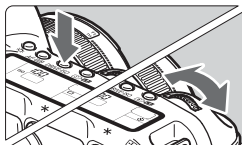

1 Press the <DRIVE-ISO> button. (ⓘ)

2 Select <ⓘ>.

- Look at the LCD panel and turn the <ⓘ> dial to select <ⓘ>.



3 Focus the subject.

- Look in the viewfinder and press the shutter button halfway to check that the focus confirmation light is on and the exposure setting is displayed.

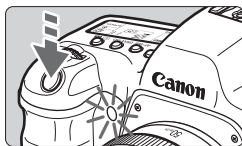

4 Take the picture.

- Look through the viewfinder and press the shutter button completely.
- ▶ The beeper will sound, the self-timer lamp will blink, and the shot will be taken about 10 sec. later. During the first 8 sec., the beeper beeps slowly and the lamp blinks slowly. Then during the final 2 sec., the beeper beeps faster and the lamp stays lit.
- ▶ During the self-timer operation, the LCD panel counts down the seconds until the picture is taken.

! Do not stand in front of the camera when you press the shutter button to start the self-timer. Doing so will throw off the focus.

- Use a tripod when you use the self-timer.
- To cancel the self-timer after it starts, press the <DRIVE-ISO> button.
- When using the self-timer to shoot only yourself, use focus lock (p.79) for an object at about the same distance as where you will be.
- You can also silence the beeper. (p.99)

3

Image Settings

This chapter explains the digital image settings for the image-recording quality, Picture Style, ISO speed, white balance, and color space.

- In the <□> (Full Auto) mode, only the following settings explained in this chapter can be set: Recording quality (except RAW and RAW+JPEG), file numbering method selection, folder selection and creation, and checking camera settings.
- The asterisk ★ appended on the right of the page title indicates that the respective feature cannot be changed in the <□> (Full Auto) mode.

MENU Setting the Image-recording Quality

The **L**/**L**/**M**/**M**/**S**/**S** modes record the image in the widely-used JPEG. In the **RAW** mode, the captured image will require post-processing with the software provided. The **RAW**+**L**/**L**/**L**/**L**+**M**/**M**/**M**+**M**/**S**/**S** (RAW+ JPEG) modes simultaneously record the image in both RAW and JPEG. **Note that in the <[]> (Full Auto) mode, RAW or RAW+JPEG cannot be set.**

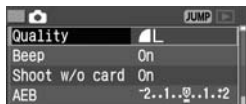

1 Select [Quality].

- Turn the <[]> dial to select [**Quality**], then press <[SET]>.
- The recording quality screen will appear.



2 Set the desired recording quality.













- Turn the <[]> dial to select the desired recording quality, then press <[SET]>.

Image-recording Quality Settings

Image-recording Quality	Image Type (extension)	Pixels	Print Size
L (Large Fine)	JPEG (.JPG)	4368 x 2912 (Approx. 12.7 million)	A3 or larger
L (Large Normal)			
M (Medium Fine)			
M (Medium Normal)			
S (Small Fine)			
S (Small Normal)			
RAW (RAW)	RAW (.CR2)	4368 x 2912 (Approx. 12.7 million)	A3 or larger

- The (Fine) and (Normal) icons indicate the image's compression rate. For better image quality, select <[]> for low compression. To save space so you can record more images, select a higher compression <[]>.
- With RAW+JPEG, the RAW and JPEG images will be saved under the same file No. in the same folder.

Image File Size and CF Card Capacity According to Image-Recording Quality

Image-recording Quality	Image File Size (Approx. MB)	Possible Shots
 L	4.6	101
 L	2.3	196
 M	2.7	168
 M	1.4	319
 S	2.0	233
 S	1.0	446
RAW +  L	-	22
RAW +  L		25
RAW +  M		24
RAW +  M		26
RAW +  S		25
RAW +  S		27
RAW		12.9

- The number of possible shots and maximum burst (p.52) apply to a Canon 512MB CF card.
- The single image size, number of possible shots, and maximum burst during continuous shooting are based on Canon's testing standards (ISO 100, Picture Style: [**Standard**]). The actual single image size, number of possible shots, and maximum burst will vary depending on the subject, shooting mode, ISO speed, Picture Style, etc.
- In the case of monochrome images (p.53), the file size will be smaller so the number of possible shots will be higher.
- On the top LCD panel, you can check the remaining number of images the CF card can record.

About the RAW

The RAW assumes that the image will undergo post-processing with a personal computer. Special knowledge is required, but you can use the bundled software to obtain the desired effect.

Image processing refers to adjusting the RAW image's white balance, contrast, etc., to create the desired image.

Note that direct printing and print ordering (DPOF) will not work with RAW images.

Max. Burst During Continuous Shooting

The maximum burst during continuous shooting depends on the image-recording quality. The approx. maximum burst during continuous shooting is indicated below for each image-recording quality. Note that with high-speed CF cards, the maximum burst may be higher than shown in the table below depending on the shooting conditions.

Image-recording Quality	L	L	M	M	S	S	RAW	RAW+JPEG
Max. Burst	60	150	120	319*	200	446*	17	12

* Continuous shooting is possible until the CF card becomes full.

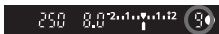

Max. Burst

- The number of shots remaining during the maximum burst is displayed on the lower right of the viewfinder.
- If “9” is displayed, it indicates that the maximum burst is nine or more shots. If “6” is displayed, it is six shots.
- While you are shooting and the number of shots remaining in the maximum burst is fewer than 9, the viewfinder will display “8”, “7”, etc. If you stop the continuous shooting, the maximum burst will increase.

After all the captured images are processed and written to the CF card, the above table's figures for the maximum burst will apply.

- With white balance bracketing (p.65), the maximum burst will be lower.
- The maximum burst is displayed even when the drive mode is set to (Single) or . The maximum burst is displayed even when a CF card is not in the camera. Therefore, before shooting, make sure that a CF card is installed in the camera.

MENU Selecting a Picture Style ★

By selecting a Picture Style, you can obtain the desired image effects. You can also adjust the settings of each Picture Style to obtain custom image effects.



1 Select [Picture Style].

- Turn the < > dial to select [**Picture Style**], then press < >.
- ▶ The Picture Style selection screen will appear.



2 Select a Picture Style.

- Turn the < > dial to select the desired Picture Style, then press < >.

Picture Style Effects

• Standard

The image looks vivid, sharp, and crisp. This is the Picture Style used in the < > (Full Auto) mode.

• Portrait

For nice skin tones. The image looks slightly sharp and crisp. By changing the [**Color tone**] (p.54), you can adjust the skin tone.

• Landscape

For vivid blues and greens, and very sharp and crisp images.

• Neutral

For natural colors and subdued images. No sharpness is applied.

• Faithful

When the subject is photographed under a color temperature of 5200K, the color is adjusted colorimetrically to match the subject's color. No sharpness is applied.

• Monochrome

For black-and-white images.



- To obtain natural-looking, black-and-white images, set a suitable white balance.
- JPEG black-and-white images captured with the **[Monochrome]** setting cannot be converted into color images even with image-editing software.



RAW images captured with the **[Monochrome]** setting can be converted into color images with the bundled software.

• User Defined 1-3

You can register your own Picture Style settings (p.58). Any User Defined Picture Style which has not been set will have the same settings as the Standard Picture Style.

About the Picture Style selection screen

The symbols on the upper right of the Picture Style selection screen refer to the sharpness, contrast, color saturation, color tone, filter effect, and color toning.

The numerals indicate the settings for each.

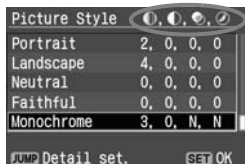
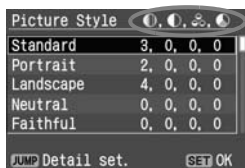

Symbols

	Sharpness
	Contrast
	Color saturation
	Color tone
	Filter effect (Monochrome)
	Color toning (Monochrome)

MENU Customizing the Picture Style★

You can customize the Picture Style by changing the individual parameters like [Sharpness] and [Contrast]. To customize [Monochrome], see page 56.



1 Select [Picture Style].

- Turn the <☉> dial to select [📷 Picture Style], then press <SET>.
- ▶ The Picture Style selection screen will appear.

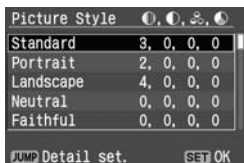

2 Select a Picture Style.

- Turn the <☉> dial to select the desired Picture Style other than [Monochrome], then press <JUMP>.
- ▶ The setting screen will appear.



3 Set the parameters.

- Turn the <☉> dial to select a parameter like [Sharpness], then press <SET>.
- Turn the <☉> dial to set the desired setting, then press <SET>.
- To return to the Picture Style selection screen, press the <MENU> button.
- ▶ Any settings different from the default will be displayed in blue.

Parameters and Their Settings

Sharpness	[0] : Less sharp outline	[+7] : Sharp outline
Contrast	[-4] : Low contrast	[+4] : High contrast
Color saturation	[-4] : Low saturation	[+4] : High saturation
Color tone	[-4] : Reddish skin tone	[+4] : Yellowish skin tone

Monochrome Adjustment

For Monochrome, you can also set [Filter effect] and [Toning effect] (p.57) in addition to [Sharpness] and [Contrast].

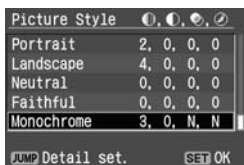

1 Select [Monochrome].

- Follow step 2 on page 53 to select [Monochrome], then press the <JUMP> button.
- ▶ The setting screen will appear.

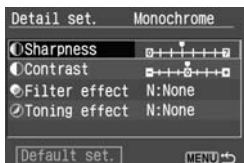

2 Set the parameters.

- Turn the <DISP> dial to select a parameter like [Sharpness], then press <SET>.
- Turn the <DISP> dial to set the desired setting, then press <SET>.
- To return to the Picture Style selection screen, press the <MENU> button.
- ▶ Any settings different from the default will be displayed in blue.
- When the camera returns to shooting, <B/W> will be displayed on the LCD panel.

Filter effects

The same effect as using filters with black-and-white film can be obtained with digital images. A color can be brightened by using a filter having a similar or same color. At the same time, the complementary colors will be darkened.

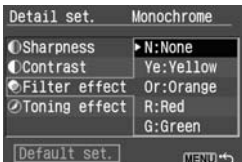

Filter	Sample effects
N: None	Normal black-and-white image with no filter effects.
Ye: Yellow	The blue sky will look more natural, and the white clouds will look clearer.
Or: Orange	The blue sky will look slightly darker. The sunset will look more brilliant.
R: Red	The blue sky will look quite dark. Fall leaves will look crisper and brighter.
G: Green	Skin tones and lips will look fine. Tree leaves will look crisper and brighter.

 Setting the **[Contrast]** to the plus side will make the filter effect more pronounced.

Toning Effect

When color toning is set, color toning will be applied to the captured black-and-white image before being recorded to the CF card. It can make the image look more impressive.

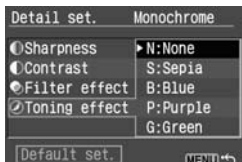

The following can be selected:

**[N:None] [S:Sepia] [B:Blue] [P:Purple]
[G:Green]**

MENU Registering the Picture Style★

You can register your own Picture Style in User Defined 1 to 3. You can set the Sharpness, Contrast, and other parameters to suit your preferences. You can also select a Picture Style already set with the provided software.



1 Select [Picture Style].

- Turn the <⊙> dial to select [📷 **Picture Style**], then press <ⓈET>.
- ▶ The Picture Style selection screen will appear.



2 Select [User Defined]

- Turn the <⊙> dial to select [User **Defined 1/2/3**], then press <JUMP> button.
- ▶ The setting screen will appear.

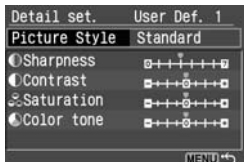

3 Select the base Picture Style.

- With the [Picture Style] selected, press <ⓈET>.

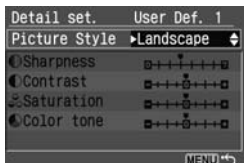

- Turn the <⊙> dial to select the base Picture Style, then press <ⓈET>.
- If you have a Picture Style already set with the provided software, select it here.

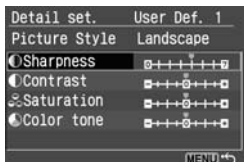

4 Set the parameters.

- Turn the <⦿> dial to select a parameter like [**Sharpness**], then press <SET>.
- Turn the <⦿> dial to set the desired setting, then press <SET>. For details, see “Customizing the Picture Style” on pages 55-57.
- Press the <MENU> button to register the new Picture Style. The Picture Style selection screen will then reappear.
 - ▶ The base Picture Style will be displayed on the right of [**User Defined 1/2/3**].
 - ▶ When the parameter like [**Sharpness**] is changed from the default, the name of the base Picture Style will be displayed in blue.



Changing the Picture Style setting inadvertently

If a User Defined Picture Style is already registered with your own Picture Style, following the procedure on page 58 up to step 3 for that User Defined Picture Style will revert it back to the default setting.

If you do not want to change the User Defined Picture Style, do not repeat this procedure.

ISO Setting the ISO Speed★

The ISO speed is a numeric indication of the sensitivity to light. A higher ISO speed number indicates a higher sensitivity to light. Therefore, a high ISO speed is suited for low light and moving subjects. However, the image may look more coarse with noise, etc. On the other hand, a low ISO speed is not suited for low light or action shots, but the image will look cleaner.

The camera can be set between ISO 100 and 1600 in 1/3-stop increments.

In the <□> (Full Auto) mode, the ISO speed will be set automatically within ISO 100-400.

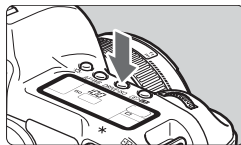

1 Press the <DRIVE-ISO> button. (⦿6)

- ▶ The current ISO speed will be displayed on the LCD panel.
- In the <□> (Full Auto) mode, “Auto” will be displayed on the LCD panel.

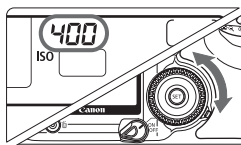

2 Setting the ISO Speed.

- While looking at the top LCD panel, turn the <⦿> dial.

- At higher ISO speeds and higher ambient temperatures, the image will have more noise.
- High temperatures, high ISO speeds, or long exposures may cause irregular colors in the image.

- When C.Fn-08 [ISO expansion] is set to [1: On] (p.153), “L” (ISO 50) and “H” (ISO 3200) can also be set.
- When you press the <DRIVE-ISO> button, the viewfinder will show the current ISO speed or “Auto”.

WB Setting the White Balance [★]

Normally, the <AWB> setting will set the optimum white balance automatically. If natural-looking colors cannot be obtained with <AWB>, you can set the white balance manually to suit the respective light source. In the <□> (Full Auto) mode, <AWB> will be set automatically.

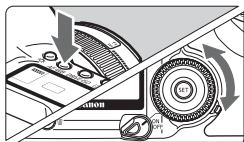

1 Press the <AF·WB> button. (☉6)

2 Select the white balance setting.

- While looking at the top LCD panel, turn the <☉> dial.

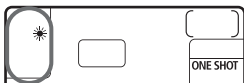

Display	Mode	Color temperature (Approx. K)
AWB	Auto	3000 - 7000
	Daylight	5200
	Shade	7000
	Cloudy, twilight, sunset	6000
	Tungsten	3200
	White fluorescent light	4000
	Flash	6000
	Custom*	2000 - 10000
	Color temperature	2800 - 10000

* Set the optimum white balance manually to suit the lighting. (p.62)

About White Balance

The three RGB (red, green, and blue) primary colors exist in the light source in varying proportions depending on the color temperature. When the color temperature is high, there is more blue. And when the color temperature is low, there is more red. To the human eye, a white object looks white regardless of the type of lighting. With a digital camera, the color temperature can be adjusted with software so that the colors in the image look more natural. The subject's white color is used as the criteria for adjusting the other colors. The camera's <AWB> setting uses the CMOS sensor for auto white balance.

MENU Custom White Balance★

With custom white balance, you shoot a white object that will serve as the basis for the white balance setting. By selecting this image, you import its white balance data for the white balance setting.

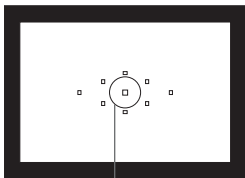

Spot metering

1 Photograph a white object.

- The plain, white object should fill the spot metering circle.
- Set the lens focus mode switch to <MF>, then focus manually. (p.80)
- Set any white balance setting. (p.61)
- Shoot the white object so that a standard exposure is obtained.

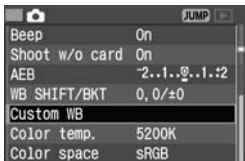

2 Select [Custom WB].

- Turn the <DISP> dial to select [📷 Custom WB], then press <SET>.
- ▶ The custom white balance screen will appear.



3 Select the image.

- Turn the <DISP> dial to select the image captured in step 1, then press <SET>.
- ▶ The image's white balance data will be imported and the menu will reappear.

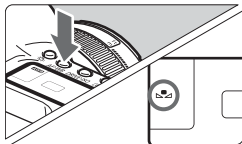

4 Select the custom white balance.

- After exiting the menu, press the <AF-WB> button.
- Look at the LCD panel and turn the <DISP> dial to select <WB>.



- If the exposure obtained in step 1 is underexposed or overexposed, a correct white balance might not be obtained.
- If an image was captured while the Picture Style was set to **[Monochrome]** (p.54), it cannot be selected in step 3.



Instead of a white object, an 18% gray card (commercially available) can produce a more accurate white balance.

MENU Setting the Color Temperature*

You can numerically set the white balance's color temperature.

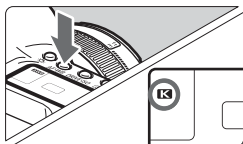

1 Press the <AF-WB> button. (ⓘ6)

2 Select the color temperature.

- Look at the LCD panel and turn the <⊙> dial to select <K>.

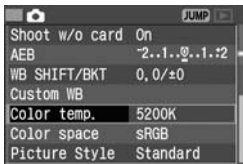

3 On the menu, select [Color temp.].

- Turn the <⊙> dial to select [Color temp.], then press <SET>.

4 Set the color temperature.

- Turn the <⊙> dial to select the desired color temperature, then press <SET>.
- The color temperature can be set from 2800K to 10000K in 100K increments.



- When setting the color temperature for an artificial light source, set white balance correction (magenta or green bias) as necessary.
- If you want to set <K> to the reading taken with a color temperature meter, take test shots and adjust the setting to compensate for the difference between the color temperature meter's reading and the camera's color temperature reading.

MENU White Balance Correction [★]

You can correct the standard color temperature for the white balance setting. This adjustment will have the same effect as using a color temperature conversion or color compensating filter. Each color can be corrected to one of nine levels. Users familiar with using color temperature conversion or color compensating filters will find this feature handy.



1 Select [WB SHIFT/BKT].

- Turn the <◉> dial to select [WB SHIFT/BKT], then press <SET>.
- ▶ The WB correction/WB bracketing screen will appear.

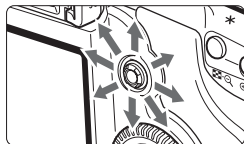

2 White Balance Correction

- Use <◉> to move the “■” to the desired position on the screen.
- B is blue, A is amber, M is magenta, and G is green. The color in the respective direction will be corrected.
- The upper right of the “SHIFT” screen will show the bias direction and correction amount.
- To cancel the white balance correction, use <◉> to move the “■” to the center so that the “SHIFT” is “0, 0”.
- Press <SET> to exit the setting and return to the menu.

Sample setting : A2, G1

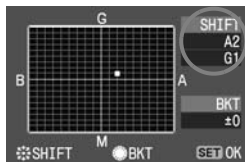

- During the white balance correction, <WB> will be displayed in the viewfinder and on the LCD panel.
- One level of the blue/amber correction is equivalent to 5 mireds of a color temperature conversion filter. (Mired: A measurement unit indicating the density of a color temperature conversion filter.)
- You can also set white balance bracketing and AEB shooting in combination with white balance correction.
- If you turn the <◉> dial in step 2, WB bracketing will be set. (p.65)

MENU White Balance Auto Bracketing [★]

With just one shot, three images having a different color tone can be recorded simultaneously. Based on the white balance mode's standard color temperature, the image will be bracketed with a blue/amber bias or magenta/green bias. This is called white balance bracketing. It can be set up to ± 3 levels in single-level increments.



1 Select [WB SHIFT/BKT].

- Turn the dial to select [WB SHIFT/BKT], then press .
- ▶ The WB correction/WB bracketing screen will appear.

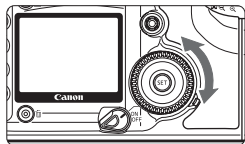

2 Set the bracketing amount.

- Turn the dial to set the bracketing direction and bracketing level.
- When you turn the dial, “■” on the screen will change to “■■■” (3 points). Turning the dial to the right sets the B/A bracketing, and turning it to the left sets the M/G bracketing.
- Set the bracketing level for the B/A or M/G bias up to ± 3 levels in single-level increments. (The bracketing level cannot be set for both the B/A and M/G bias.)
- ▶ On the right side of the screen, “BKT” indicates the bracketing direction and the bracketing level is also displayed.
- Press to exit the setting and return to the menu.

B/A bias ± 3 levels

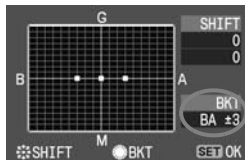

M/G bias ± 3 levels

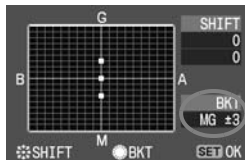

3 Take the picture.

- ▶ When B/A bracketing has been set, the three images will be recorded onto the CF card in the following sequence: Standard WB, B (blue) bias, and A (amber) bias. If M/G bracketing has been set, the sequence will be Standard WB, M (magenta) bias, and G (green) bias.

Canceling White Balance Auto Bracketing

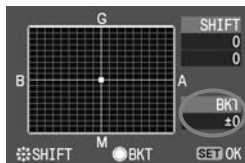

- In step 2, set “BKT” to “±0” (“■■■” to “■” (1 point)).

⚠ With white balance bracketing, the maximum burst will be lower.

- When white balance bracketing is set, the white balance icon will blink on the LCD panel and the remaining shots will decrease to about 1/3.
- Since three images are recorded for one shot, the CF card will take longer to record the shot.
- You can also set white balance correction and AEB shooting in combination with white balance bracketing. If you set AEB in combination with white balance bracketing, a total of nine images will be recorded for a single shot.
- “BKT” stands for bracketing.

MENU Setting the Color Space [★]

The color space refers to the range of reproducible colors. With this camera, you can set the color space for captured images to sRGB or Adobe RGB. For normal images, sRGB is recommended. In the <□> (Full Auto) mode, sRGB will be set automatically.

1 Select [Color space].

- Turn the <☉> dial to select [ **Color space**], then press <SET>.



2 Set the desired color space.

- Turn the <☉> dial to select [**sRGB**] or [**Adobe RGB**], then press <SET>.

About Adobe RGB

This is mainly used for commercial printing and other industrial uses. This setting is not recommended if you do not know about image processing, Adobe RGB, and Design rule for Camera File System 2.0 (Exif 2.21).

Since the image will look very subdued with sRGB personal computers and printers not compatible with Design rule for Camera File System 2.0 (Exif 2.21), post-processing of the image with software will be required.



- If the image is captured with the color space set to Adobe RGB, the file name will start with “_MG_” (first character is an underscore).
- The ICC profile is not appended. The ICC profile is explained in the Software Instruction Manual (PDF).

MENU Creating and Selecting a Folder

You can freely create and select the folder where the captured images are to be saved. This is optional since a folder will be created automatically for saving captured images.

Creating a Folder

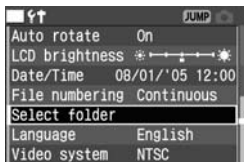

1 Go to the Create folder screen.

- Turn the <⊙> dial to select [**↑↑** Select folder], then press <ⓈET>.
- ▶ The Select/Create folder screen will appear.

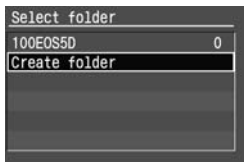

2 Select [Create folder].

- Turn the <⊙> dial to select [**Create folder**], then press <ⓈET>.
- ▶ The Create folder screen will appear.

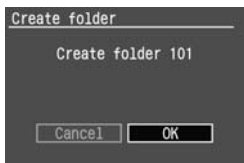

3 Create a new folder.

- Turn the <⊙> dial to select [**OK**], then press <ⓈET>.
- ▶ A new folder will be created.



- A folder can have up to 9999 images.
- If the active folder reaches 9999 images, a new folder will be created automatically to save images captured thereafter.
- Up to 900 folders can be created.

Selecting a Folder

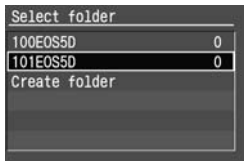

- With the Select/Create folder screen displayed, turn the <◁⊙▷> dial to select the desired folder, then press <ⓈET>.
- ▶ Captured images will be saved in the selected folder.
- “**100EOS5D**” is the folder No. and the number on the right is the number of images contained in the folder.

 You cannot select a folder to playback the images inside.

Creating Folders with a Personal Computer

With the memory card open on the screen, create a new folder named “Dcim.”

Open the Dcim folder and create as many folders as necessary to save and organize your images.

The folder names must start with three digits from 100 to 999 followed by five letters, like **100ABC_D**. The five letters can be a combination of upper or lower case letters from A to Z and an underscore. There can be no spaces in the folder name. Also, if there are folder numbers with the same three-digit number (regardless of the letters) such as “**100ABC_C**” and “**100ABC_D**”, the camera will not recognize the folders.

MENU File Numbering Methods

The file number is like the frame number on a roll of film. It can start counting in one of three different ways: **[Continuous]**, **[Auto reset]**, and **[Manual reset]**. The images you take are automatically assigned a file number from 0001 to 9999. The images are saved in the selected folder.

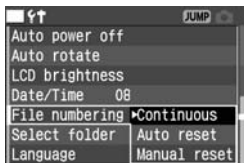

- 1 Select [File numbering].**
 - Turn the <⊙> dial to select [**File numbering**], then press <SET>.
- 2 Select the file numbering method.**
 - Turn the <⊙> dial to select **[Continuous]**, **[Auto reset]**, or **[Manual reset]**, then press <SET>.

Continuous

The file numbering continues in sequence even after you replace the CF card. This prevents images from having the same file number, so image management with a personal computer is easier. Note that if the replacement CF card already contains images captured with the camera, the file numbering will start after the highest file number in that CF card or after the last captured image's file number, whichever is higher.

File numbering after changing the CF card



Next sequential file number

Auto Reset

Each time you replace the CF card, the file numbering will be reset to the first file number (**0001**). Since the file number starts from **0001** in each CF card, you can organize images according to CF card. Note that if the replacement CF card already contains images, the file numbering will start after the highest file number in that CF card.

File numbering after changing the CF card

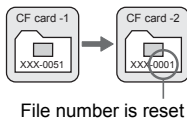

Manual Reset

This creates a new folder automatically and resets the file number to **0001**. Images captured thereafter are saved in this new folder. The file numbering method (Auto reset or Continuous) that was in effect before the manual reset will continue to take effect.



If file No. 9999 is created, **“FuLL”** will be displayed on the LCD panel and in the viewfinder. Replace the CF card with a new one.



For both JPEG and RAW images, the file name will start with “IMG_”. The extension will be “.JPG” for JPEG images and “.CR2” for RAW images.

INFO. Checking Camera Settings

When the camera is ready to shoot, press the <INFO.> button to view the current camera settings on the LCD monitor.



Display the camera settings.

- Press the <INFO.> button.
- ▶ The current camera settings appear on the LCD monitor.
- To turn off the LCD monitor, press the <INFO.> button again.

Camera Setting Display

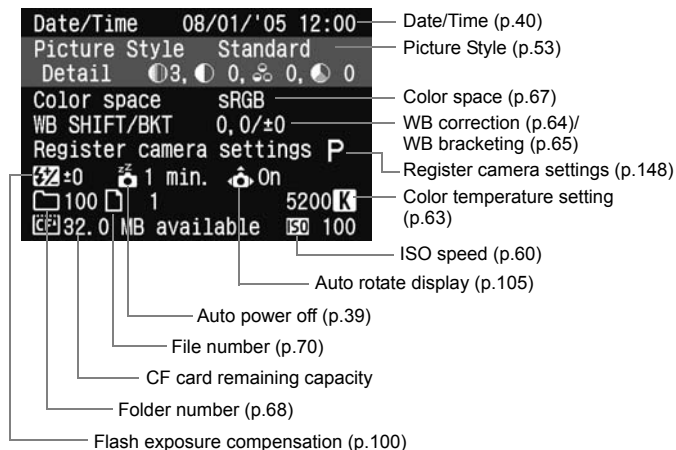

For details on the image info. during playback, see “Shooting Information Display” (p.108).

4

Setting the AF, Metering, and Drive Modes

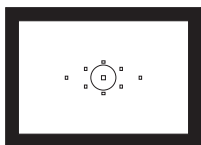

The viewfinder has 9 AF points. By selecting a suitable AF point, you can shoot with autofocus while framing the subject as desired. You can also set the AF mode to suit the subject or obtain the desired effect.

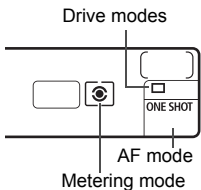

Evaluative, partial, spot, and center-weighted average metering modes are provided. Single, continuous, and Self-timer drive modes are provided. Select the metering mode that suits the subject or your photographic intention.

- The asterisk ★ appended on the right of the page title indicates that the respective feature cannot be changed in the <□> (Full Auto) mode.
- The AF mode, AF point selection, metering mode, and drive mode will be set automatically in the <□> (Full Auto) mode.

AF Selecting the AF Mode [★]

The AF mode is the autofocus operation method. Three AF modes are provided. One-Shot AF is suited for still subjects, while AI Servo AF is for moving subjects. And AI Focus AF switches from One-Shot AF to AI Servo AF automatically if the still subject starts moving. In the <□> (Full Auto) mode, AI Focus AF will be set automatically.

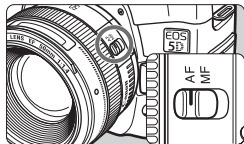

1 On the lens, set the focus mode switch to <AF>.

2 Set the Mode Dial to any setting except <□> (Full Auto).

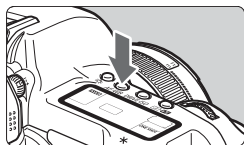

3 Press the <AF·WB> button. (⓪6)

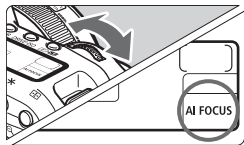

4 Select the AF mode.

- While looking at the LCD panel, turn the <☀> dial.

ONE SHOT : One-Shot AF

AI FOCUS : AI Focus AF

AI SERVO : AI Servo AF

! If an Extender (optional) is attached and the maximum aperture of the lens is f/5.6 or smaller, AF will not be possible. For details, see the Extender's instructions.

! <AF> stands for auto focus. <MF> stands for manual focus.

One-Shot AF for Still Subjects



AF point

Focus
confirmation
light

Pressing the shutter button halfway activates the autofocus and achieves focus once.

- ▶ The AF point which achieves focus flashes briefly. At the same time, the focus confirmation light <●> in the viewfinder is displayed.
- ▶ With evaluative metering, the exposure setting (shutter speed and aperture) will be set when focus is achieved. The exposure setting and focus will be locked as long as the shutter button is pressed halfway. (p.79) You can then recompose the shot while retaining the exposure setting and point of focus.



If focus cannot be achieved, the focus confirmation light <●> in the viewfinder will blink. If this occurs, a picture cannot be taken even if the shutter button is pressed fully. Recompose the picture and try to focus again. Or see “When Autofocus Fails (Manual Focusing)” (p.80).

AI Servo AF for Moving Subjects

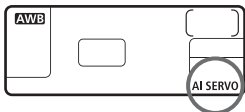

While you press the shutter button halfway, the camera focuses continuously.

- This AF mode is for moving subjects when the focusing distance keeps changing.
- ▶ With predictive AF*, the camera can also focus track a subject which steadily approaches or retreats from the camera.
- ▶ The exposure is set at the moment the picture is taken.

* About Predictive AF

If the subject approaches or retreats from the camera at a constant rate, the camera tracks the subject and predicts the focusing distance immediately before the picture is taken. This is for obtaining correct focus at the moment of exposure.

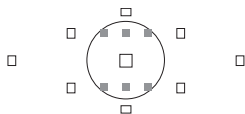

- When the AF point selection is automatic, first the center AF point will focus the subject. Within the spot metering circle, there are six invisible Assist AF points (■ in diagram) that function in the AI SERVO AF mode. So even if the subject moves slightly away from the center AF point, the camera can still continue focusing. If the subject moves completely away from the center AF point during focusing, the adjacent AF point will continue focusing the subject as long as it covers the subject.
- With a manually selected AF point, the selected AF point will focus track the subject.

AI Focus AF for Automatic Switching of AF Mode

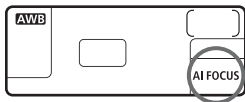

AI Focus AF switches the AF mode from One-Shot AF to AI Servo AF automatically if the still subject starts moving.

After the subject is focused in the One-Shot AF mode, if the subject starts moving, the camera will detect the movement and change the AF mode automatically to AI Servo AF.

When focus is achieved in the AI Focus AF mode with the Servo mode active, the beeper will sound softly. The focus confirmation light <●> in the viewfinder will not light.

Selecting the AF Point ★

The AF point is used for focusing. The AF point can be selected automatically by the camera or manually by you.

In the <> (Full Auto) mode, automatic selection will be set.

Automatic AF point selection

The camera selects the AF point automatically according to the shooting conditions. **All the AF points in the viewfinder will light in red.**

Manual AF Point Selection

You can select any of the nine AF points manually. This is best when you want to focus on a particular subject, or autofocus quickly while composing the shot.

Selecting with the Multi-controller

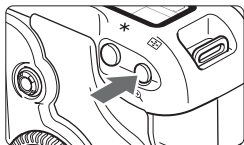



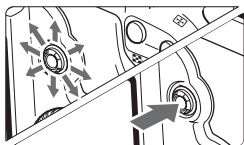

1 Press the <> button. ()

- ▶ The selected AF point will be displayed in the viewfinder and on the LCD panel.





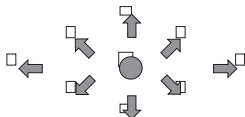

2 Select the AF point.

- While looking at the viewfinder or LCD panel, use <>.
- The AF point in the direction where you press the <> will be selected.
- If you press <> straight down, the center AF point will be selected.
- If you push the <> in the same direction as the currently-selected AF point, all the AF points will light and automatic AF point selection will be set.

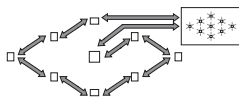

Selecting with the Dial



- Press the  button, then turn the  dial or  dial to select the AF point in the looping sequence shown on the left.

- When looking at the LCD panel to select the AF point, note the following: Automatic selection [- - - -], center [-], right [-], top [-]
- If focus cannot be achieved with an EOS-dedicated, external Speedlite's AF-assist beam, select the center AF point.

Lens' Maximum Aperture and AF Sensitivity

The EOS 5D will execute high-precision AF with lenses whose maximum aperture is f/2.8 or larger.

With lenses whose maximum aperture is f/2.8 or larger*



With the center AF point, high-precision, cross-type AF sensitive to both vertical and horizontal lines is possible. With cross-type AF, vertical-line detection is twice as sensitive as horizontal-line detection. The other eight AF points are horizontal-line sensitive or vertical-line sensitive.

* Except with the EF28-80mm f/2.8-4L USM and EF50mm f/2.5 Compact Macro lenses.

With lenses whose maximum aperture is larger than f/5.6

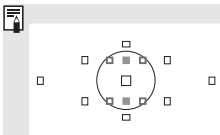
The center AF point is a cross-type AF sensor. The other eight AF points are horizontal-line sensitive or vertical-line sensitive.



The spot metering circle has six invisible Assist AF points (see left illustration) that function in the AI SERVO AF mode. The  Assist AF points have the same vertical-line sensitivity as the center AF point at f/2.8, and the  Assist AF points have horizontal-line sensitivity at f/5.6.

Focusing an Off-Center Subject

After achieving focus, you can lock the focus on a subject and recompose the shot. This is called “focus lock.” Focus lock works only in the One-Shot AF mode.

1 Set the Mode Dial to any setting except $\langle \square \rangle$ (Full Auto).

2 Select the desired AF point.



3 Focus the subject.

- Move the AF point over the subject and press the shutter button halfway.



4 Keep pressing the shutter button halfway and recompose the picture as desired.

5 Take the picture.

 If the AF mode is AI Servo AF (or AI Focus AF set to Servo mode), focus lock will not work.

When Autofocus Fails (Manual Focusing) ■

Autofocus can fail to achieve focus (the focus confirmation light <●> blinks) with certain subjects such as the following:

Subjects difficult to focus

- (a) Low-contrast subjects
Example: Blue sky, solid-color walls, etc.
- (b) Subjects in low light
- (c) Extremely backlit and reflective subjects
Example: Car with a reflective body, etc.
- (d) Overlapping near and far objects
Example: Animal in a cage, etc.
- (e) Repetitive patterns
Example: Skyscraper windows, computer keyboards, etc.

In such cases, do one of the following:

- (1) Focus an object at the same distance as the subject and lock the focus before recomposing.
- (2) Set the lens focus mode switch to <MF> and focus manually.

Manual Focusing

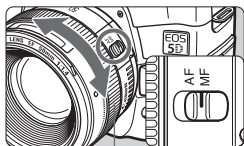

Focusing ring

1 On the lens, set the focus mode switch to <MF>.

2 Focus the subject.

- Focus by turning the lens focusing ring until the subject is in focus in the viewfinder.

 If you press the shutter button halfway during manual focusing, the active AF point and the focus confirmation light <●> in the viewfinder will light when focus is achieved.

Selecting the Metering Mode ★

Four metering modes are provided: Evaluative, partial, spot, and center-weighted average metering. In the  (Full Auto) mode, evaluative metering is set automatically.

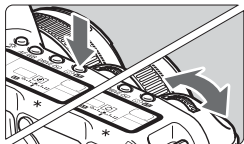

1 Press the   button. (06)

2 Select the metering mode.

- While looking at the LCD panel, turn the  dial.

: Evaluative Metering

: Partial Metering

: Spot Metering

: Center-weighted Average Metering

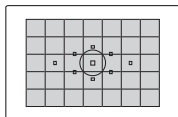
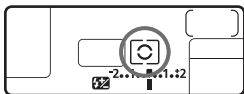

Evaluative Metering

This is the camera's standard metering mode suited for most subjects even under backlit conditions. After detecting the main subject's position, brightness, background, front and back lighting, etc., the camera sets the proper exposure.

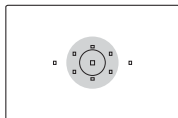

Partial Metering

Effective when the background is much brighter than the subject due to backlighting, etc. Partial metering covers about 8% of the viewfinder area at the center. The area covered by partial metering is shown on the left.

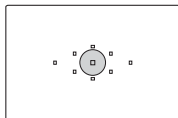

Spot Metering

This is for metering a specific part of the subject or scene. The metering is weighted at the center covering about 3.5% of the viewfinder area. The area covered by spot metering is shown on the left.

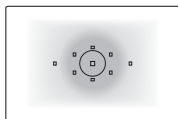

Center-weighted Average Metering

The metering is weighted at the center and then averaged for the entire scene.

Selecting the Drive Mode [★]

Single and continuous drive modes are provided. In the <□> (Full Auto) mode, single shooting is set automatically.

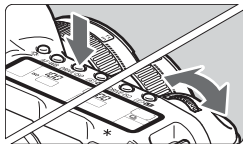

1 Press the <DRIVE-ISO> button. (⊕6)

2 Select the drive mode.

- While looking at the LCD panel, turn the <⚙> dial.



 : **Single shooting**

When you press the shutter button completely, one shot will be taken.

 : **Continuous shooting** (Max. 3 shots per sec.)

While you press the shutter button completely, shots will be taken continuously.

 : **Self-timer Operation** (p.48)

-  ● During continuous shooting, the captured images are first stored in the camera's internal memory and then successively transferred to the CF card. When the internal memory becomes full during continuous shooting, "buSY" will be displayed on the LCD panel and in the viewfinder and the camera cannot take any more shots. As the captured images are transferred to the CF card, you will be able to capture more images. Press the shutter button halfway to check in the viewfinder's bottom right the current remaining shots of the maximum burst.
- 
Max. Burst
- If "FuLL CF" is displayed in the viewfinder and on the LCD panel, wait until the access lamp stops blinking, then replace the CF card.
 - When the battery level is low, the maximum burst will be slightly lower.

5

Advanced Operations

In shooting modes other than <□> (Full Auto), you can freely set the shutter speed or aperture to obtain the desired result.

- The asterisk ★ appended on the right of the page title indicates that the respective feature cannot be changed in the <□> (Full Auto) mode.
- After you press the shutter button halfway and let go, the timer operation will keep the LCD panel and viewfinder information displayed for about 4 sec. (⌚4).



First set the <⌚> switch to <↗>.

P Program AE



Like <□> (Full Auto) mode, this is a general-purpose shooting mode. The camera automatically sets the shutter speed and aperture value to suit the subject's brightness. This is called Program AE.

* <P> stands for Program

* AE stands for Auto Exposure



1 Set the Mode Dial to <P>.

AF point



2 Focus the subject.

- Look through the viewfinder and aim any AF point over the subject. Then press the shutter button halfway.

Shutter speed

Aperture

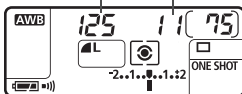

3 Check the display.

- ▶ The shutter speed and aperture value will be set automatically and displayed in the viewfinder and on the LCD panel.
- A correct exposure will be obtained as long as the shutter speed and aperture value display do not blink.

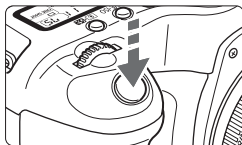

4 Take the picture.

- Compose the shot and press the shutter button completely.



- If “30” and the maximum aperture blink, it indicates underexposure. Increase the ISO speed or use flash.
- If “8000” and the minimum aperture blink, it indicates overexposure. Decrease the ISO speed or use an ND filter (optional) to reduce the amount of light entering the lens.



Differences Between <P> and <□> (Full Auto)

- In both modes, the automatically-set shutter speed and aperture combination are the same.
- In the <P> mode, you can set or use the functions below, but not in the <□> mode.

Shooting Settings

- AF mode selection
- AF point selection
- Drive mode selection
- ISO speed
- Metering mode selection
- Program Shift
- Exposure compensation
- AEB
- AE lock with <★> button
- Depth-of-field preview
- Register camera settings
- Clear registered camera set.
- Clear all camera settings
- Custom Function (C.Fn)
- Clear all Custom Functions
- Sensor cleaning

Flash Settings (EX-series Speedlite)

- Manual/stroboscopic flash
- High-speed sync (FP flash)
- FE lock
- Flash ratio control
- Flash exposure compensation
- FEB
- 2nd-curtain sync
- Modeling flash

Image-Recording Settings

- RAW and RAW+JPEG selection
- Picture Style selection/customize/registration
- White balance selection
- Custom white balance selection
- White balance correction
- WB bracketing
- Color temperature setting
- Color space selection

About Program Shift

- In Program AE mode, you can freely change the shutter speed and aperture value combination (program) set by the camera while maintaining the same exposure value. This is called program shift.
- To do this, press the shutter button down halfway, then turn the <☀> dial until the desired shutter speed or aperture value is displayed.
- Program shift is canceled automatically after the image is captured.
- If you use a flash, you cannot use program shift.

Tv Shutter-Priority AE

In this mode, you set the shutter speed and the camera automatically sets the aperture value to suit the brightness of the subject. This is called Shutter-Priority AE. A fast shutter speed can freeze the motion of a fast-moving subject and a slow shutter speed can blur the subject to give the impression of motion.

* <Tv> stands for Time value.



Fast shutter speed



Slow shutter speed



1 Set the Mode Dial to <Tv>.

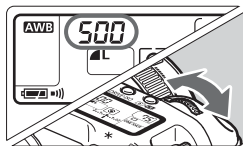

2 Set the desired shutter speed.

- While looking at the LCD panel, turn the <⚙> dial.
- It can be set in 1/3-stop increments.

3 Focus the subject.

- Press the shutter button halfway.
- ▶ The aperture value is set automatically.



4 Check the viewfinder display and shoot.

- As long as the aperture value is not blinking, the exposure will be correct.

Av Aperture-Priority AE

In this mode, you set the desired aperture and the camera sets the shutter speed automatically to suit the subject brightness. This is called aperture-priority AE. A larger aperture opening (smaller f/number) will result in a blurred background ideal for portraits. This occurs because a lower f/number decreases the depth of field (range of acceptable focus). On the other hand, a smaller aperture opening (larger f/number) will make more of the foreground and background fall within acceptable focus. A smaller aperture opening increases the depth of field.

* <Av> stands for Aperture value.



With a large aperture opening



With a small aperture opening



1 Set the Mode Dial to <Av>.

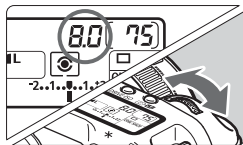

2 Set the desired aperture value.

- While looking at the LCD panel, turn the <gear> dial.
- It can be set in 1/3-stop increments.

3 Focus the subject.

- Press the shutter button halfway.
- ▶ The shutter speed is set automatically.

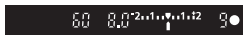

4 Check the viewfinder display and shoot.

- As long as the shutter speed is not blinking, the exposure will be correct.



- If the “30” shutter speed blinks, it indicates underexposure. Turn the  dial to set a larger aperture (smaller f/number) until the blinking stops or set a higher ISO speed.



- If the “8000” shutter speed blinks, it indicates overexposure. Turn the  dial to set a smaller aperture (larger f/number) until the blinking stops or set a lower ISO speed.



Aperture Value Display

The larger the f/number, the smaller the aperture opening will be. The aperture values displayed will differ depending on the lens. If no lens is attached to the camera, “00” will be displayed for the aperture value.

1.0	1.1	1.2	1.4	1.6	1.8	2.0	2.2	2.5	2.8	3.2	3.5	4.0
4.5	5.0	5.6	6.3	7.1	8.0	9.0	10	11	13	14	16	18
20	22	25	29	32	36	40	45	51	57	64	72	81
91												

Depth of Field Preview ★

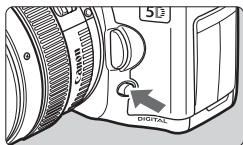

Press the depth-of-field preview button to stop down to the current aperture setting. The diaphragm in the lens will be set to the current aperture so you can check the depth of field (range of acceptable focus) through the viewfinder.



The exposure is locked (AE lock) while the Depth-of-Field Preview button is pressed.

M Manual Exposure



In this mode, you set both the shutter speed and aperture value as desired. To determine the exposure, refer to the exposure level indicator in the viewfinder or use a handheld exposure meter. This method is called manual exposure.

* <M> stands for Manual.



1 Set the Mode Dial to <M>.

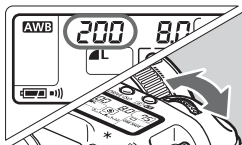

2 Set the desired shutter speed.

- While looking at the LCD panel, turn the <shutter speed> dial.

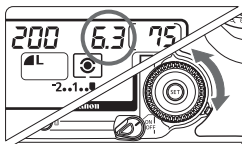

3 Set the desired aperture value.

- Set the <aperture> switch to <open>, and while looking at the LCD panel, turn the <aperture> dial.

Standard exposure index

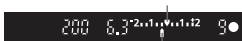

Exposure level mark

4 Focus the subject.

- Press the shutter button halfway.
- ▶ The exposure setting will be displayed in the viewfinder and on the LCD panel.
- The exposure level icon <exposure level> lets you see how far you are from the standard exposure level.

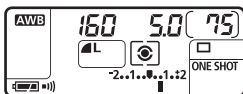

5 Set the exposure.

- Check the exposure level and set the desired shutter speed and aperture value.

 : Standard exposure level.

 : To set it to the standard exposure level, set a slower shutter speed or a larger aperture.

 : To set it to the standard exposure level, set a faster shutter speed or a smaller aperture.

6 Take the picture.



If the exposure level mark  blinks at the $\langle +2 \rangle$ or $\langle -2 \rangle$ level, it indicates that the exposure level exceeds the standard exposure by ± 2 stops.

Setting Exposure Compensation ★

Exposure compensation is used to alter the standard exposure setting set by the camera. You can make the image look lighter (increased exposure) or darker (decreased exposure). You can set the exposure compensation up to ± 2 stops in 1/3-stop increments.

1 Set the Mode Dial to **<P>**, **<Tv>**, or **<Av>**.

2 Check the exposure level indicator.

- Press the shutter button halfway and check the exposure level indicator.

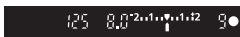

3 Set the exposure compensation amount.

- Set the **<Fn>** switch to **<ON>**, and while looking at the viewfinder or LCD panel, turn the **<QD>** dial.
- Turn the **<QD>** dial while pressing the shutter button halfway or within **(1/4)** after pressing the shutter button halfway.
- To cancel the exposure compensation, set the exposure compensation amount back to **<0>**.

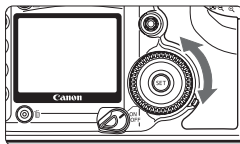

Increased exposure



Decreased exposure



Standard exposure index

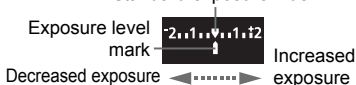

4 Take the picture.

- The exposure compensation amount will remain in effect even after the **<Fn>** switch is set to **<OFF>**.
- If the standard exposure setting is 1/125 sec. and f/8.0, setting the exposure compensation amount to plus or minus one stop will be the same as setting the shutter speed or aperture value as follows:

	-1 stop ← 0 → +1 stop
Shutter speed	250 ← 125 → 60
Aperture value	11 ← 8.0 → 5.6

- Take care not to turn the **<QD>** dial and change the exposure compensation inadvertently. To prevent this, turn the **<Fn>** switch to **<ON>**.

MENU Auto Exposure Bracketing (AEB)★

By changing the shutter speed or aperture automatically, the camera brackets the exposure up to ± 2 stops in $1/3$ -stop increments for three successive shots. This is called Auto Exposure Bracketing (AEB).



Standard exposure



Decreased exposure



Increased exposure

1 Select [AEB].

- Turn the $\langle \odot \rangle$ dial to select [AEB], then press $\langle \text{SET} \rangle$.

2 Set the AEB amount.

- Turn the $\langle \odot \rangle$ dial to set the AEB amount, then press $\langle \text{SET} \rangle$.
- ▶ When you exit the menu, $\langle \text{MENU} \rangle$ and the AEB level will be displayed on the LCD panel.

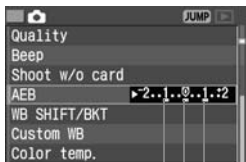

AEB amount

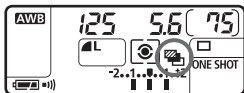

Standard exposure

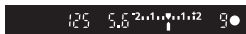

Decreased exposure

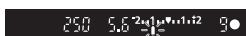

Increased exposure

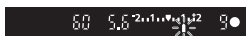

3 Take the picture.

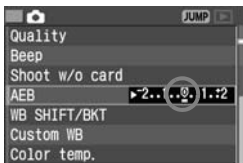

- ▶ The three bracketed shots will be exposed in the following sequence: standard exposure, decreased exposure, and increased exposure.
- ▶ As shown on the left, the respective bracketing amount will be displayed as each bracketed shot is taken.
- ▶ The current drive mode (p.82) will be used for the shooting.

Canceling AEB



- Follow steps 1 and 2 to set the AEB amount to <2.0>.
- It will also be canceled if you set the <OFF> switch to <OFF>, change the lens, attain flash ready, replace the battery, or replace the CF card.

 Neither flash nor bulb exposures can be used with AEB.

-  ● If the drive mode is set to continuous () , the three bracketed shots will be taken continuously and then the shooting will stop automatically. If the drive mode is set to single image () , you must press the shutter button three times.
- If the self-timer has been set, the three bracketed shots will be taken continuously.
- If C.Fn-12-1 is set for mirror lockup and AEB is set, only one bracketed shot will be taken at a time even in the continuous shooting mode.
- AEB can be combined with exposure compensation.

✳ AE Lock ✳

AE lock enables you to lock the exposure at a different place from the point of focus. After locking the exposure, you can recompose the shot while maintaining the desired exposure setting. This is called AE lock. It is effective for backlit subjects.

1 Focus the subject.

- Press the shutter button halfway.
- ▶ The exposure setting will be displayed.

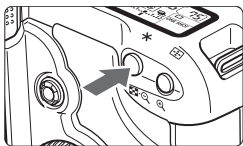

2 Press the <✳> button. (4)

- ▶ <✳> lights in the viewfinder to indicate that the exposure setting is locked (AE lock).
- Each time you press the <✳> button, it locks the current exposure setting.

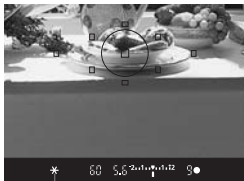

AE lock indicator

3 Recompose and take the picture.

- If you want to maintain the AE lock while taking more shots, hold down the <✳> button and press the shutter button to take another shot.



- If One-Shot AF or AI Focus AF (when not AI Servo AF) is set, pressing the shutter button halfway to focus will automatically set AE lock at the same time.
- The AE lock effect will differ depending on the AF point and metering mode. For details, see "AE lock" (p.160).

Bulb Exposures

When bulb is set, the shutter stays open while you hold down the shutter button fully, and closes when you let go of the shutter button. This is called bulb exposure. Use bulb exposures for night scenes, fireworks, the heavens, and other subjects requiring long exposures.



1 Set the Mode Dial to .

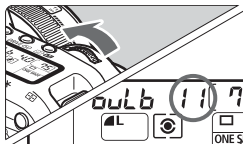

2 Set the desired aperture value.

- Look at the LCD panel and turn the <aperture> dial.

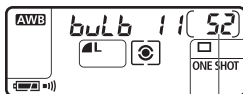

Elapsed exposure time

3 Take the picture.

- Press the shutter button completely.
- ▶ The elapsed exposure time will be displayed on the LCD panel. (Displays 1 sec. to 999 sec.)
- The exposure continues as long as you hold down the shutter button.

⚠ Since bulb exposures will have more noise than usual, the image will look rough or grainy.

- Bulb exposures may result in grainy images due to picture noise. If C.Fn-02 [Long exp. noise reduction] is set to [1: Auto noise reduction] or [2: On] (p.151), noise can be reduced.
- For bulb exposures, using Remote Switch RS-80N3 or Timer Remote Controller TC-80N3 (both optional) is recommended.

Mirror Lockup★

Mirror lockup is enabled with C.Fn-12 [**Mirror lockup**] set to [1: **Enable**] (p.154). The mirror can be swung up separately from when the exposure is made. This prevents mirror vibrations which may blur the image during close-ups or when a super telephoto lens is used. Set Custom Functions with [**ft Custom Functions (C.Fn)**].

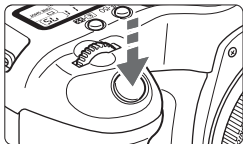

1 Press the shutter button completely.

- ▶ The mirror will swing up.

2 Again press the shutter button completely.

- ▶ The picture is taken and the mirror goes back down.



- In very bright light such as at the beach or ski area on a sunny day, take the picture promptly after mirror lockup.
- During mirror lockup, do not point the camera lens at the sun. The sun's heat can scorch and damage the shutter curtains.
- If you use bulb exposures, the self-timer, and mirror lockup in combination, keep pressing the shutter button completely (2 sec. self-timer + bulb exposure time). During the self-timer countdown, if you let go of the shutter button, there will be a shutter-release sound. This is not the shutter release (no picture is taken).





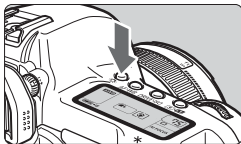

- During mirror lockup, the drive mode will be single shooting regardless of the current drive mode (single or continuous).
- If you use the self-timer and mirror lockup, the shot will be taken 2 sec. after the mirror goes up when you press the shutter button completely.
- The mirror locks up, and after 30 seconds, it will go back down automatically. Pressing the shutter button completely again locks up the mirror again.
- For mirror lockup shots, using Remote Switch RS-80N3 or Timer Remote Controller TC-80N3 (both optional) is recommended.

LCD Panel Illumination



The LCD panel is provided with illumination.

Each time you press the < > button, the LCD panel illumination will turn on or off. Use it to read the LCD panel in the dark ( 6). The illumination will turn off automatically after the shot is taken.

-  Pressing any shooting-related button or turning the Mode Dial while the LCD panel is illuminated prolongs the illumination.
- During a bulb exposure, pressing the shutter button completely will turn off the LCD panel illumination. However, you can turn on the illumination for 6 sec. by pressing the < > button.

Using the Eyepiece Cover

During self-timer or remote switch (optional) operation when your eye does not cover the viewfinder eyepiece, stray light may enter the eyepiece and affect the exposure when the image is captured. In such a case, use the eyepiece cover (p.21).

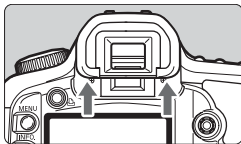

1 Remove the eyepiece.

- From the bottom of the eyepiece, push it upward.

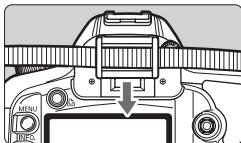



2 Attaching the Eyepiece Cover.

- Slide the eyepiece cover down into the eyepiece groove to attach it.

MENU You can also silence the beeper



You can silence the beeper so it does not sound in any shooting mode.

1 Select [Beep].

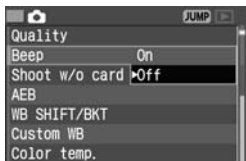
- Turn the <  > dial to select [ **Beep**], then press <  >.





2 Select [Off].

- Turn the <  > dial to select [**Off**], then press <  >.

MENU CF Card Reminder



This prevents shooting if there is no CF card in the camera. This can be set in all shooting modes.

1 Select [Shoot w/o card].

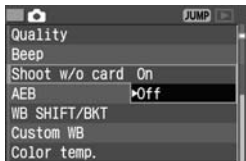
- Turn the <  > dial to select [ **Shoot w/o card**], then press <  >.



2 Select [Off].

- Turn the <  > dial to select [**Off**], then press <  >.

 If [**Off**] has been set and you press the shutter button while there is no CF card in the camera, “no CF” will be displayed in the viewfinder and LCD panel.

Flash Photography

With EX-series Speedlites

An EOS-dedicated, EX-series Speedlite makes flash photography as easy as any AE mode. For details on using the EX-series Speedlite, refer to the Speedlite's instruction manual. The EOS 5D is a Type-A camera compatible with all EX-series Speedlites providing the features below.

• E-TTL II Autoflash

E-TTL II incorporates an improved flash exposure control and lens focusing distance information, making it more precise than the previous E-TTL autofocus exposure system (evaluative flash metering with preflash). The camera can execute E-TTL II autofocus with any EX-series Speedlite.

• High-Speed Sync (FP flash)

High-speed sync (FP or focal-plane flash) enables flash synchronization with all shutter speeds from 30 sec. to 1/8000 sec.

• FE (Flash Exposure) Lock

Press the camera's **<★>** button to lock the flash exposure at the desired part of the subject. This is the flash equivalent of AE lock.

Aim the center of the viewfinder over the part of the subject where you want to obtain a correct exposure, then press the **<★>** button. During FE lock, **<★*>** will be displayed in the viewfinder.

• Flash Exposure Compensation

In the same way as normal exposure compensation, you can set exposure compensation for flash. The flash exposure compensation amount can be set with the camera up to ± 2 stops in 1/3-stop increments. With Speedlites which you can set the flash exposure compensation, it can be set up to ± 3 stops in 1/3-stop increments.

• FEB (Flash Exposure Bracketing)

FEB is the flash version of AEB. (Only with FEB-compatible Speedlites.) Set flash exposure bracketing up to ± 3 stops in 1/3-stop increments.

During FEB, **<★*>** will blink in the viewfinder.



If you use flash, you can set flash exposure compensation by holding down the **<Ⓢ/Ⓜ>** button and turning the **<○>** dial.

• E-TTL II Wireless Autoflash with Multiple Speedlites

Like with wired, multiple Speedlites, E-TTL II wireless autoflash with multiple Speedlites provides all the above features. Since connection cords are unnecessary, flexible and sophisticated lighting setups are possible. (Only with wireless-compatible Speedlites.)

TTL and A-TTL Autoflash Speedlites

- With TTL and A-TTL autoflash Speedlites (EZ-, E-, EG-, ML-, TL-series) set in the TTL or A-TTL autoflash mode, the flash will be fired only at full output. If you set the camera's shooting mode to manual or aperture-priority AE, you can adjust the aperture and fire the flash at full output. Meanwhile, the Speedlite will remain in the TTL or A-TTL autoflash mode.
- When the 580EX or 550EX is set to C.Fn-03-1, the flash will always be fired at full output even in the TTL autoflash mode.

Using Non-Canon Flash Units

Sync Speed

The EOS 5D can synchronize with compact, non-Canon flash units at 1/200 sec. or slower shutter speeds. With large studio flash, the sync speed is 1/125 sec. or slower. Be sure to test the flash to see if it synchronizes properly with the camera.

PC Terminal

- The camera's PC terminal is provided for flash units having a sync cord. The PC terminal is threaded to prevent inadvertent disconnection.
- The camera's PC terminal has no polarity so you can connect any sync cord regardless of its polarity.

- ⚠ ● If the camera is used with a flash unit (with dedicated flash contacts) or flash accessory dedicated to another camera brand, the camera may not operate properly and camera malfunction may result. Also, do not connect to the camera's PC terminal any flash unit requiring 250 V or higher voltage.
 - Do not attach a high voltage flash unit on the camera's hot shoe. It might not work.

 A Speedlite attached to the camera's hot shoe and a flash unit connected to the PC terminal can be used at the same time.

6

Image Playback

This chapter explains image playback operations such as how to view and erase captured images and how to connect the camera to a TV monitor.



For images taken with another camera:

The camera might not be able to properly display images captured with a different camera or edited with a personal computer or whose file name was changed.



MENU Setting the Image Review Time

You can set how long the image is to be displayed on the LCD monitor right after it is captured. To keep the image displayed, set **[Hold]**. To not have the image displayed, set **[Off]**.



1 Select **[Review time]**.

- Turn the <  > dial to select **[Review time]**, then press <  >.

2 Set the desired review time.

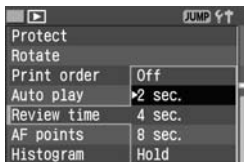
- Turn the <  > dial to select the desired setting, then press <  >.





- If you press the <  > button during the image review right after shooting, you can change the display format.
- The **[Hold]** setting keeps displaying the image until you press the shutter button halfway. However, if auto power off has been set, the camera will turn off automatically after the auto power off time elapses.
- During the image review for single-shooting, you can delete the displayed image by pressing the <  > button and selecting **[OK]**.
- To view images captured so far, see “Image Playback” (p.107).

MENU Auto Image Rotation



Vertical shots can be rotated automatically so that they are displayed upright during playback.

1 Select [Auto rotate].

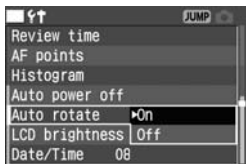
- Turn the <  > dial to select [**Auto rotate**], then press <  >.



2 Select [On].

- Turn the <  > dial to select [**On**], then press <  >.

3 Take a vertical shot.

- For the image review right after image capture, the image will not be displayed vertically on the LCD monitor.

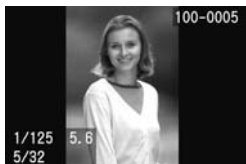

4 Playback the image.

- Press the <  > button.
- ▶ The vertical shot will be displayed vertically as shown on the left.



- Auto rotate will work only if [**Auto rotate**] has been set to [**On**]. Auto rotate will not work with vertical images captured while [**Auto rotate**] was [**Off**].
- If the vertical image is taken while the camera is pointed up or down, the image might not rotate automatically for playback.



When you change the camera's orientation between horizontal and vertical, the camera orientation sensor will make a small sound. This is normal and not a defect.

MENU Setting the LCD Brightness

You can adjust the brightness of the LCD monitor to one of five levels.

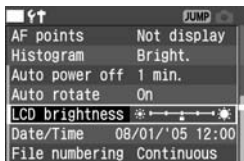

1 Select [LCD brightness].

- Turn the <⊙> dial to select [**↑↑ LCD brightness**], then press <SET>.
- ▶ The brightness adjustment screen will appear.



2 Adjust the brightness.

- While looking at the gray chart on the left, turn the <⊙> dial to adjust.
- Press <SET> to exit the setting and return to the menu.

 To check the image's exposure, look at the histogram (p.109).

Image Playback

You can select any captured image to view. You can view a single image, the shooting information, an index display, or a magnified view.

▶ Single image display



1 Playback the image.

- Press the <▶> button.
- ▶ The last captured image will appear on the LCD monitor.

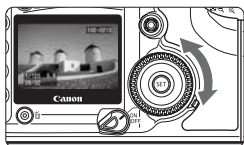

2 Select the image.

- To playback images starting with the last image, turn the dial counterclockwise. To playback images starting with the first captured image, turn the <◉> dial clockwise.
- Press the <INFO.> button to switch the display format.

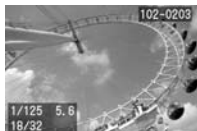

Single image display
(with basic info)

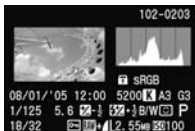

Shooting information



Single image display
(no shooting info)

- To quit the playback, press the <▶> button. The LCD monitor will turn off.



- Even in display formats other than single image (index display, magnified view, etc.), you can press the <INFO.> button to display or hide the basic info.
- While data is being written to the CF card (access lamp blinking) after continuous shooting, press the <▶> button to display the last image which has been written to the CF card. Turn the <◉> dial to select the image. After all the images have been written to the CF card, they can be displayed in sequence.

Shooting Information Display

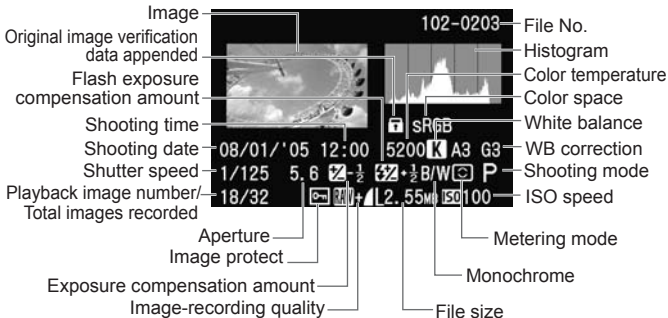

Highlight Alert

When the shooting information is displayed, any overexposed areas of the image will blink. To obtain more image detail in the overexposed areas, set the exposure compensation to a negative amount and shoot again.

MENU AF Point Display

On the menu, if [**AF points**] is set to [**Display**], the AF point will also be displayed on the shooting information screen.

If the image was taken in the One-Shot AF mode, the AF point which achieved focus will be displayed. If automatic AF point selection was used, you may see multiple AF points which achieved focus.

If the image was captured in the AI SERVO AF mode, the AF point which was selected will be displayed. If automatic AF point selection was used, the AF points which achieved focus will be displayed.

 If the image was taken in the AI SERVO AF mode with the center AF point and C.Fn-17-01 (AF point activation area: Expanded) set, the center AF point and Assist AF points (p.76) above and below it will also be displayed.

MENU Histogram

On the menu's [**Histogram**] setting, you can select [**Bright.**] or [**RGB**].

[Bright.] Display

This histogram is a graph showing the distribution of the image's brightness level. The horizontal axis indicates the brightness level (darker on the left and brighter on the right), while the vertical axis indicates how many pixels exist for each brightness level.

The more pixels there are toward the left, the darker the image. And the more pixels there are toward the right, the brighter the image.

If there are too many pixels on the left, the shadow detail will be lost. And if there are too many pixels on the right, the highlight detail will be lost. The tones in-between will be reproduced.

By checking the image's brightness histogram, you can see the exposure level bias and the overall tone reproduction condition.

Sample Histograms

Dark image



Normal image



Bright image

[RGB] Display

This histogram is a graph showing the distribution of the image's brightness level of each primary color (RGB or red, blue, and green). The horizontal axis indicates the color's brightness level (darker on the left and brighter on the right), while the vertical axis indicates how many pixels exist for each color brightness level. The more pixels there are toward the left, the darker and less prominent the color. And the more pixels there are toward the right, the brighter and denser the color. If there are too many pixels on the left, the respective color information will be lacking. And if there are too many pixels on the right, the color will be too saturated with no detail.

By checking the image's RGB histogram, you can see the color's saturation and gradation condition and white balance bias.

Index Display



Nine thumbnail images are displayed on one screen.

1 Set the camera for playback.

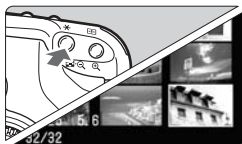
- Press the < > button.
- ▶ The last captured image will appear on the LCD monitor.



2 Display the index images.

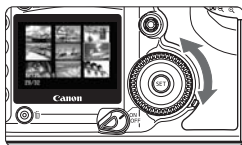

- Press the < < > button.
- ▶ The selected thumbnail will be highlighted with a green frame.





3 Select the image.

- Turn the < > dial to move the green frame.

Switching from the index display to another display format

- To display a single image, press the < > button.
- Pressing the < > button switches to the single image display and pressing it again switches to magnified view.

 While the index is displayed, press the <JUMP> button and turn the < > dial to jump nine images ahead or back. (p.114)

🔍/🔍 Magnified View

You can magnify the image by 1.5x to 10x on the LCD monitor.

1 Display the image.

- Display the image in the single-image or image info. display mode.

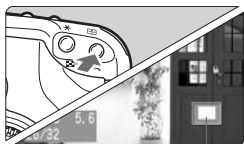

Magnified area

2 Magnify the image.

- Press the <🔍> button.
- ▶ First, the center of the image will be magnified.
- To increase the magnification, hold down the <🔍> button.
- Press the <🔍🔍> button to reduce the magnification. Hold down the button to continue reducing the magnification until it reaches the size in step 1.

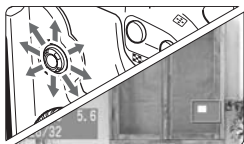

3 Scroll around the image.

- Use <🌀> to scroll around the image in any direction.
- Repeat steps 2 and 3 to magnify other areas of the image.
- To exit the magnified display, press the <▶> button.



- During the magnified view, you can turn the <🌀> or <🌀> dial to view the next or previous image at the same magnification and scroll position.
- With C.Fn-18-1 set, you can hold down the <🔍> button and press the <🔍> or <🔍🔍> button to magnify or reduce the image.

MENU Automated Playback of Images (Auto playback)

You can playback the CF card's images in an automatic slide show. Each image will be displayed for about 3 sec.

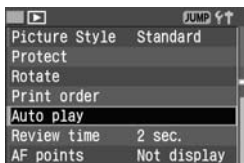

1 Select [Auto play].

- Turn the <◀▶> dial to select [▶], then press <SET>.
- ▶ The auto play screen will appear.



2 Start the auto play.

- ▶ After [Loading image...] is displayed for a few seconds, auto play will start.
- To pause the auto play, press <SET>.
- During pause, [||] will be displayed on the upper left of the image. Press <SET> again to resume the auto play.



3 Stop the auto play.

- To stop the auto play and return to the menu, press the <MENU> button.



- During auto play, auto power off will not work.
- The display time may vary depending on the image.



- During auto play, you can press the <INFO.> button to change the display format.
- During pause, you can turn the <◀▶> dial to view another image.

MENU Rotating an Image

You can rotate an image by 90° or 270° clockwise. Images will then be displayed in the correct orientation during playback.

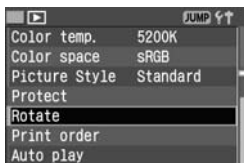

1 Select [Rotate].

- Turn the < [DIAL] > dial to select [▶ **Rotate**], then press < [SET] >.
- ▶ The Rotate screen will appear.



2 Rotate the image.

- Turn the < [DIAL] > dial to select the image to be rotated, then press < [SET] >.
- ▶ Each time you press < [SET] >, the image will rotate clockwise.
- To rotate another image, repeat step 2.
- To stop rotating the image, press the < [MENU] > button. The menu will reappear.



- If you have set [▶ **Auto rotate**] to [On] (p.105) before taking the vertical shots, you need not rotate the image as described above.
- You can rotate the image even after you change the display format to shooting info display, magnified view, or index display after step 1.

JUMP Jump Display

During the single image, image with shooting information, index, or magnified image display, you can jump forward or back to images stored on the CF card.

1 Playback the image.

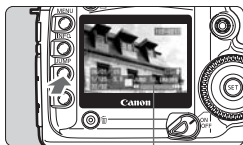

Jump bar

2 Go to the jump display.

- Press the <JUMP> button.
- ▶ The jump bar will appear at the bottom of the screen.



3 Jump forward or back.

- Turn the <◉> dial.
- To quit the image jump, press the <JUMP> button. The jump bar will disappear.
- Turn the <◉> dial to view the next or previous image.

Single Image and Information Display

During the single image and information display, you can use the Jump feature (by 10 or 100 images, date, or folder).



- At step 2 above, press the <JUMP> button, then press <SET> and turn the <◉> dial.
- ▶ The Jump method indicated on the Jump bar will change (p.115).
- Press <SET> to confirm the Jump method.
- Turn the <◉> dial to jump according to the selected jump method.

Jumping during the single image or image with shooting information display

Jump 10 images / Jump 100 images

Turn the <⊙> dial clockwise to jump forward by 10 or 100 images. Or turn it counterclockwise to jump backward by 10 or 100 images.

Jump shot date

You can jump to a picture taken on a specific date. (If there are multiple pictures taken on the same date, the display will jump to the first picture taken on that date.) Turn the <⊙> dial to jump to the previous or next date.

Jump folder

Jump by folder. Turn the <⊙> dial to jump to the previous or next folder. The folder's first image will be displayed.

Jumping in the magnified view

Turn the <⊙> dial counterclockwise to jump ten images backward, or turn it clockwise to jump ten images forward. The magnified position and magnification will be maintained during the image jump.

Jumping in the index display mode

Turn the <⊙> dial counterclockwise to jump to the previous 9th image or turn it clockwise to jump to the next 9th image.



Image jump is also possible during [Protect], [Rotate] and [Custom WB].

Viewing the Images on a TV

By connecting the camera to a TV set with the video cable (provided), you can view the captured images on a TV set. Always turn off the camera and the television before connecting or disconnecting them.

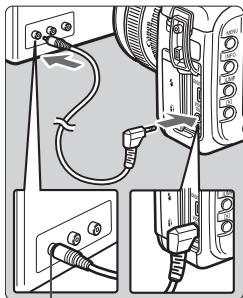

Video IN terminal

1 Connect the camera to the TV.

- Open the camera's terminal cover.
- Use the video cable (provided) to connect the camera's <VIDEO OUT> terminal to the TV monitor's VIDEO IN terminal.
- Insert the cable plug all the way in.

2 Turn on the TV and switch the TV's line input to Video IN.

3 Set the <TV> switch to <ON> or </>.

4 Press the <▶> button.

- ▶ The image will appear on the TV screen. (Nothing will be displayed on the camera's LCD monitor.)
- After you finish, set the <TV> switch to <OFF>, turn the TV off, then disconnect the video cable.

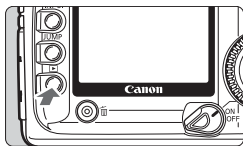

- If the proper video system format is not set, the image will not be displayed properly. Set the proper video system format with [F Video system].
- Depending on the TV monitor, the four corners might look dark.

MENU Protecting Images

This prevents the image from being erased accidentally.

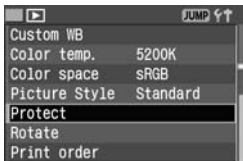

1 Select [Protect].

- Turn the <DIAL> dial to select [], then press <SET>.
- ▶ The protect setting screen will appear.



Image protect icon

2 Protect the image.

- Turn the <DIAL> dial to select the image to be protected, then press <SET>.
- ▶ When an image is protected, the <Protect icon> icon will appear below the image.
- To cancel the image protection, press <SET> again. The <Protect icon> icon will disappear.
- To protect another image, repeat step 2.
- To exit the image protection, press the <MENU> button. The menu will reappear.



- Once an image is protected, it cannot be erased by the camera's Erase function. To erase a protected image, you must first cancel the protection.
- If you erase all the images (p.119), only the protected images will remain. This is convenient when you want to erase unnecessary images all at once.
- You can protect the image even after you change the display format to shooting info display, magnified view, or index display after step 1.

Erasing Images

You can erase images individually or erase all the images at one time in the CF card. Only protected images will not be erased.

- ⚠ **Once an image is erased, it cannot be recovered. Make sure you no longer need the image before erasing it. To prevent important images from being erased accidentally, protect them.**

Erasing a Single Image

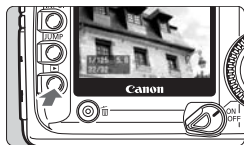

1 Display the image.

- Press the <▶> button.

2 Select the image to be erased.

- Turn the <◉> dial to select the image to be erased.

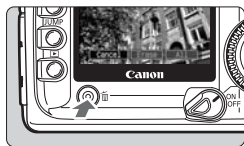

3 Display the erase menu.

- Press the <🗑> button.
- ▶ The Erase menu will appear at the bottom of the screen.



4 Erase the image.

- Turn the <◉> dial to select **[Erase]**, then press <SET>.
- ▶ The access lamp will blink and the image will be erased.
- If there are other images you want to erase, repeat steps 2 to 4.

Erasing All Images

1 Display the image.

- Press the <▶> button.

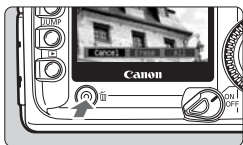

2 Display the erase menu.

- Press the <🗑️> button.
- ▶ The Erase menu will appear at the bottom of the screen.



3 Select [All].

- Turn the <🕒> dial to select [All], then press <SET>.
- ▶ The confirmation dialog will appear.

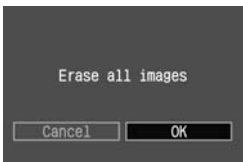

4 Erase the images.

- Turn the <🕒> dial to select [OK], then press <SET>.
- ▶ All unprotected images will be erased.
- While the images are being erased, you can cancel the erasure by pressing <SET>.



While data is being written to the CF card (access lamp blinking) after continuous shooting, press the <▶> button and then press the <🗑️> button to erase the displayed image or all images. If you select [All] and press the <SET> button, the images captured during continuous shooting (including those not yet processed) and all the images on the CF card will be erased.

MENU Formatting the CF Card

Format the CF card before using it in the camera.

- ⚠ **Formatting a CF card will erase everything in the card. Even protected images will be erased, so make sure there is nothing you need to keep. If necessary, transfer images to a personal computer before formatting the card.**

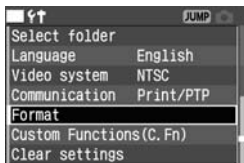

1 Select [Format].

- Turn the <⊙> dial to select [**Format**], then press <SET>.
- ▶ The confirmation dialog will appear.

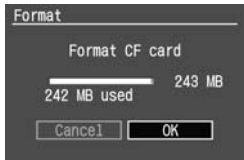

2 Format the CF card.

- Turn the <⊙> dial to select [**OK**], then press <SET>.
- ▶ The CF card will be formatted (initialized).
- ▶ When the formatting is completed, the menu will reappear.



- A non-Canon CF card or a CF card formatted with another camera or personal computer might not work with the camera. If this happens, format the card with the camera first. Then it might work with the camera.
- The CF card's capacity displayed on the formatting screen may be lower than the capacity indicated on the card.



Handling "Err CF"

If "Err CF" (CF error) is displayed on the LCD panel, it indicates that a problem with the CF card is preventing the image data from being recorded or read. Use another CF card instead.

Or, if you have a commercially-available CF card reader that can read the CF card, use it to transfer all the images in the card to a personal computer. After transferring all the images to a personal computer, format the CF card. It may then return to normal.

7

Direct Printing from the Camera

You can connect the camera directly to a printer and print out the images in the CF card.

The camera enables direct printing with printers compatible with “ PictBridge”, Canon “ CP Direct”, and Canon “ Bubble Jet Direct.”

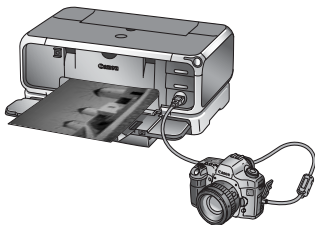

Conventions Used in this Chapter

This chapter includes procedures for various types of printers. After “Preparing to Print” on the next page, follow the instructions applicable to your printer on the pages indicated.

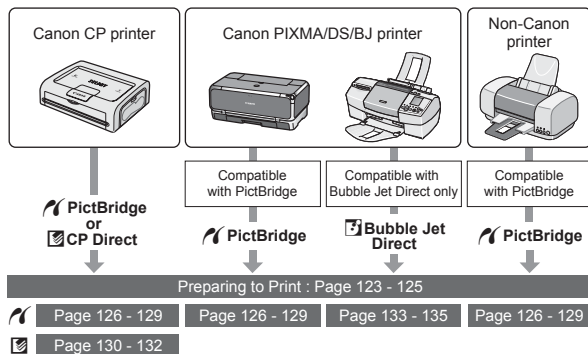

Canon's PictBridge Web Site

The Web site below gives more information about using your Canon camera with various printers such as which paper types to use.

<http://canon.com/pictbridge/>

Preparing to Print

You do the direct printing procedure entirely through your camera's LCD monitor.

Setting the Camera

- 1 **Select [Communication].**
 - Turn the <⦿> dial to select [**↑↓** **Communication**], then press <SET>.
- 2 **Select [Print/PTP].**
 - Turn the <⦿> dial to select [**Print/PTP**], then press <SET>.

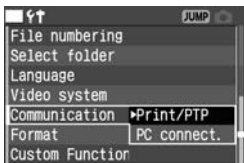

- When connecting the camera to the personal computer, set [**Communication**] to [**PC connect.**]. Transmissions between the camera and personal computer will not work with the [**Print/PTP**] setting.
- For direct printing, using AC Adapter Kit ACK-E2 (optional) to power the camera is recommended.

Connect the camera to the printer

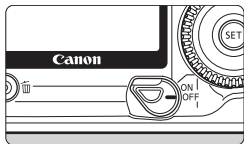





- 1 **Turn the camera's <⦿> switch to <OFF>.**
- 2 **Set up the printer.**
 - For details, refer to the printer's manual.

3 Connect the camera to the printer.

- Refer to the table (Printers and Cables) below to select the proper cable to connect the camera to printer.

Printers and Cables

Printer Compatibility	Suitable Cable
 PictBridge only	Interface cable provided with camera The plug at both ends have the <↔> icon.
 PictBridge and CP Direct	
 PictBridge and Bubble Jet Direct	
 CP Direct only	Cable provided with printer Only one plug has the <↔> icon.
 Bubble Jet Direct only	

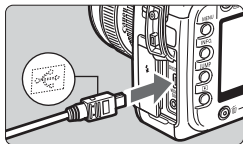

- When connecting the cable plug to the camera's <DIGITAL> terminal, the cable plug's <↔> icon must face the front side of the camera.
- To connect to the printer, refer to the printer's instruction manual.

4 Turn on the printer.

5 Turn the camera's <☺> switch to <ON> or <↗>.

- ▶ Some printers may have a beeping sound.

PictBridge



CP Direct





Bubble Jet Direct



6 Playback the image.

- Press the <▶> button.
- ▶ The image and the printer icon <🖨️>, <📄>, or <📷> indicating a printer connection will be displayed.
- ▶ The <🖨️> button lamp will light in blue.
- The procedure will be different depending on the icon displayed. See the applicable pages below.

Icon	Reference pages
	126 - 129, 138
	130 - 132, 138
	133 - 135, 138



- RAW images are not compatible with direct printing.
- If you use a battery to power the camera, make sure it is fully charged. During direct printing, keep checking the battery level.
- If there is a long beeping sound in step 5, it indicates a problem with the PictBridge printer. To find out what's wrong, do the following: Press the <▶> button to playback the image and follow the steps below.
 1. Press <SET>.
 2. On the print setting screen, select **[Print]**.
 The error message will be displayed on the LCD monitor. See "**Error Messages**" on page 129.
- Before disconnecting the cable, turn off the camera and printer. Pull out the cable while holding the plug, not the cord.
- When connecting the camera to the printer, do not use any cable other than the dedicated interface cable.
- Do not disconnect the cable during direct printing.

Printing with PictBridge

The setting options will differ depending on the printer. Some settings might be disabled. For details, refer to your printer's instruction manual.



1 Select the image to be printed.

- Check that the <PictBridge icon> is displayed on the upper left of the LCD monitor.
- Turn the <Dial> to select the image to be printed.

2 Press <SET>.

- ▶ The print setting screen will appear.

Print setting screen



Set the date or file number imprinting to on or off.

Set the printing effects.

Sets the quantity to be printed.

Sets the trimming area.

Sets the paper size, type, and layout.

Returns to the screen in step 1.

Starts the printing.

The paper size, type, and layout you have set will be displayed.

* Depending on the type of printer, the date and file number imprinting, trimming, and other settings might not be available.



3 Select [Paper settings].

- Turn the <Dial> to select [Paper settings], then press <SET>.
- ▶ The Paper settings screen will appear.

Setting the Paper Size

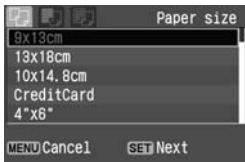

- Turn the <⊙> dial to select the size of the paper loaded in the printer, then press <SET>.
- ▶ The Paper Type screen will appear.

Setting the Paper Type

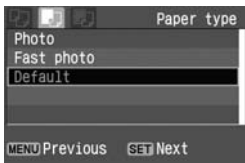

- Turn the <⊙> dial to select the type of paper loaded in the printer, then press <SET>.
- ▶ The Layout screen will appear.

About the Paper Types

If you are using a Canon PIXMA/DS/BJ printer with Canon paper, set the respective paper type as follows:

Photo Paper Plus Glossy	Photo
Photo Paper Pro	Fast Photo
Photo Paper Plus Glossy	Default

If you are using a non-Canon printer, refer to the printer's instruction manual.

Setting the Layout

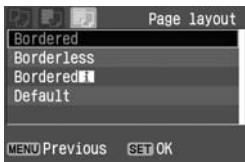

- Turn the <⊙> dial to select the desired layout, then press <SET>.
- ▶ The Print setting screen will reappear.

About Layout

Borderless	The print will have no white borders. If your printer cannot print borderless prints, the print will have borders.
Bordered	The print will have a white border along the edges.
Bordered	The shooting data will be imprinted on the border on 9x13cm and larger prints.
**-up	Option to print 2, 4, 8, 9, 16, or 20 copies of same image on one sheet.
20-up 35-up	On A4 / Letter size paper, 20 or 35 thumbnails of the images ordered through DPOF will be printed. [20-up will have the shooting information* printed on the side of the thumbnail images.
Default	With a Canon printer, the print will be borderless.

* From the Exif data, the camera name, lens name, shooting mode, shutter speed, aperture, exposure compensation amount, ISO speed, etc., will be imprinted.

Date/File number imprinting **4** Set the other options.

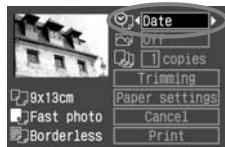

Printing effects



Number of copies



- If necessary, you can also set the date/file number imprinting, printing effects, and number of copies.

- Turn the dial to select the menu item, then press .

- Turn the dial to select the desired setting, then press .

- Depending on the BJ printer, the Printing effects setting may enable you to select the **[Vivid]** (for vivid greens and blue sky), **[NR]** (noise reduction), **[Vivid+NR]**, **[Face]** (compensate for a dark face caused by backlighting) or **[On]** setting.

- For details on trimming, see page 136.



5 Start printing.

- Turn the < [Dial] > dial to select **[Print]**, then press < [SET] >.
- ▶ The printing will start.
- When the printing ends, the screen will return to step 1.
- To stop the printing, press < [SET] > while **[Stop]** is displayed, then turn the < [Dial] > dial to select **[OK]** and press < [SET] >.



- Depending on the image's file size and recording quality, it may take some time for the printing to start after you select **[Print]**.
- The **[Default]** setting for printing effects and other options are the printer's own default settings as set by the printer's manufacturer. See the printer's instruction manual to find out what the **[Default]** settings are.

Handling Printer Errors

If you resolve a printer error (no ink, no paper, etc.) and select **[Continue]** to resume printing but it does not resume, operate the buttons on the printer to resume printing. For details, see the printer's instruction manual.

Error Messages

If a problem occurs during printing, an error message will appear on the camera's LCD monitor. Press < [SET] > to stop printing. After resolving the problem, resume printing. For details on how to resolve a printing problem, refer to the printer's instruction manual.

Paper Error

Check whether the paper is properly loaded in the printer.

Ink Error

The printer has run out of ink or the waste ink tank is full.

Hardware Error

Check for any printer problems other than paper and ink problems.

File Error

The selected image cannot be printed via PictBridge. Images taken with a different camera or images edited with a computer might not be printable.

☑ Printing with CP Direct

Printer connected icon



1 Select the image to be printed.

- Check that the <☑> icon is displayed on the upper left of the LCD monitor.
- Turn the <⦿> dial to select the image to be printed.

2 Press <SET>.

- ▶ The print setting screen will appear.

Print setting screen



Sets the quantity to be printed.

Sets the trimming area.

Sets the printing style.

Returns to step 1.

Starts the printing.

The printing style settings are displayed.

<⦿> is the date icon.

3 Select [Style].

- Turn the <⦿> dial to select [Style], then press <SET>.
- ▶ The Style screen will appear.



[Image]



[Borders]



[Date]

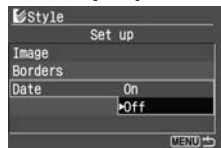

4 Set the options as desired.

- Set the [Image], [Borders], and [Date] as desired.
- Turn the <⊙> dial to select the menu item, then press <SET>.
- Turn the <⊙> dial to select the desired setting, then press <SET>.
- [Image] is selectable when card-size paper is used. If you select [Multiple], 8 small images of the same picture will be printed on the paper.
- Check the [Borders] and [Date] settings and set them if necessary.
- When you are done, press the <MENU> button to return to the print setting screen.

5 Set the number of copies.

- Set as necessary.
- Turn the <⊙> dial to select [copies], then press <SET>.
- Turn the <⊙> dial to set the number of copies, then press <SET>.
- Set a number from 1 to 99.



6 Set the trimming.

- Set as necessary.
- For details on trimming, see page 136.



7 Start printing.

- Turn the <⊙> dial to select **[Print]**, then press <SET>.
- ▶ The printing will start.
- When the printing ends, the screen will return to step 1.
- To stop the printing, press <SET> while **[Stop]** is displayed, then turn the <⊙> dial to select **[OK]** and press <SET>.

- The date may look light if it is imprinted on a bright background or border.
- If **[Multiple]** is selected, **[Borders]** and **[Date]** cannot be selected. **[Borderless]** will be set and **[Date]** will be set to **[Off]**. The image will also be cut off along all four edges.



- If **[Date]** is **[On]**, the date recorded for the image will appear on the print. The date will appear on the lower right of the image.
- If you select **[Stop]** while printing only one picture, the printing will not stop until it finishes printing the picture. If you are printing multiple pictures, the printing will stop after the current picture is finished printing.
- If a problem occurs during printing, an error message will appear on the camera's LCD monitor. Select **[Stop]** or **[Continue]** (after resolving the problem). If **[Continue]** is not displayed, select **[Stop]**.

Printing with Bubble Jet Direct

Printer connected icon



1 Select the image to be printed.

- Check that the  icon is displayed on the upper left of the LCD monitor.
- Turn the  dial to select the image to be printed.

2 Press .

- ▶ The print setting screen will appear.

Print setting screen



Sets the quantity to be printed.

Trimming — Sets the trimming area.

Style — Sets the printing style.



Cancel — Returns to step 1.

Print — Starts the printing.

The printing style settings are displayed.

 is the date icon.

3 Select [Style].

- Turn the  dial to select [Style], then press .
- ▶ The Style screen will appear.



[Paper]

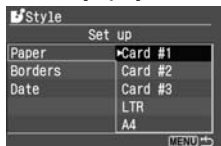

[Borders]



[Date]

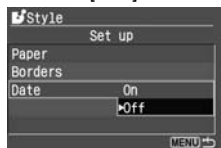

4 Set the options as desired.

- Turn the <⊙> dial to select the menu item, then press <SET>.
- Turn the <⊙> dial to select the desired setting, then press <SET>.
- [Paper] is the size of the paper loaded in the printer.
- Check the [Borders] and [Date] settings and set them if necessary.
- When you are done, press the <MENU> button to return to the print setting screen.

5 Set the number of copies.

- Set as necessary.
- Turn the <⊙> dial to select [copies], then press <SET>.
- Turn the <⊙> dial to set the number of copies, then press <SET>.
- Set a number from 1 to 99.

6 Set the trimming.

- Set as necessary.
- For details on trimming, see page 136.





7 Start printing.

- Turn the <⊙> dial to select [**Print**], then press <⊙(SET)>.
- ▶ The printing will start.
- When the printing ends, the screen will return to step 1.
- To stop the printing, press <⊙(SET)> while [**Stop**] is displayed, then turn the <⊙> dial to select [**OK**] and press <⊙(SET)>.

● If [**Bordered**] is set, the date might be imprinted on the border, depending on the printer.

- If [**Date**] is [**On**], the date recorded for the image will appear on the print. The date will appear on the lower right of the image.
- If you select [**Stop**] during the printing, the picture being printed will stop printing and the paper will be discharged.
- If a problem occurs during printing, an error message will appear on the camera's LCD monitor. Select [**Stop**] or [**Continue**]. If you select [**Continue**] and the printer does not resume printing, it will resume automatically after you resolve the problem.
- If you are using a BJ printer equipped with an operation display panel, the error No. will be displayed if an error occurs. To resolve the respective error, refer to the BJ printer's instruction manual.

Setting the Trimming

You can trim the image and print only the trimmed portion as if the image was recomposed.

Do the trimming right before printing. If you set the trimming and then set the print settings, you may have to set the trimming again.

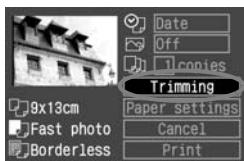

1 Select [Trimming].

- Turn the <⊙> dial to select [Trimming], then press <SET>.
- ▶ The trimming screen will appear.



2 Trim the image.

- The image area within the trimming frame will be printed.
- The operation guide disappears while you trim the image. It will reappear after 5 sec. of idle time.



Changing the trimming frame size

- When you press the <Q> or <Q·Q> button, the size of the trimming frame will change. The smaller the trimming frame, the larger the image magnification will be.

Moving the trimming frame

- Use <⊙> to scroll around the image in any direction. Move the trimming frame until it shows the desired image area or composition.

Rotating the frame

- The <INFO.> button toggles between the vertical and horizontal orientation of the trimming frame. For example, a horizontal shot can be printed as a vertical shot.



Image area to be printed

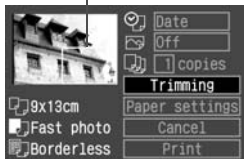

3 Exit the menu.

- Press < (SET) >.
- ▶ The Print setting screen will reappear.
- ▶ On the upper left, you can see the trimmed image area that will be printed.



- Depending on the printer, the trimmed image area might not be printed as you specified.
- The smaller you make the trimming frame, the grainier the picture will look. If the picture will be too grainy, the trimming frame will turn red.
- While trimming the image, look at the camera's LCD monitor. If you look at the image on a TV screen, the trimming frame might not be displayed accurately.



The trimming frame shape will be different depending on the **[Paper settings]**, **[Image]** / **[Paper]**, **[Page layout]** / **[Borders]** settings.

Easy Printing

When you print directly from your camera to your printer, the printing settings will be saved in your camera. To use the same settings again, follow the steps below.

1 Connect the camera to a printer and prepare for printing.

2 Playback the images and select the ones to be printed.

3 Press the <  > button that lights in blue.

▶ The blue lamp will blink and printing will start.

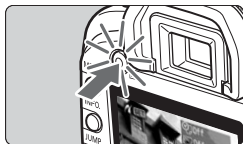

- With Easy Printing, only one print can be printed each time.
- With Easy Printing, any cropping (trimming) will not be applied.
- With C.Fn-18-1, printing will not be possible with the <  > button.

8

DPOF: Digital Print Order Format

With DPOF (Digital Print Order Format), you can use the camera to specify which images in the CF card are to be printed and the quantity. This feature is very convenient when you make prints with a DPOF-compatible printer or photo lab.

About DPOF

DPOF (Digital Print Order Format) is a standard for recording print ordering instructions to the CF card. It is for images taken with a digital camera, and you can specify which photos and the quantity to print. With a DPOF-compatible digital camera, you can do the following:

- By inserting a CF card into a DPOF-compatible printer, you can make prints as specified.
- Printers capable of direct printing from the camera can print the images as specified by DPOF.
- When ordering prints from a photo lab, you do not need to fill in any order form to specify the image selections, quantity, etc.

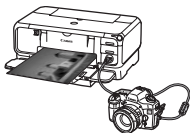

MENU Print Ordering

Print Settings

Set the print type, date imprinting, and file No. imprinting. The print settings will be applied to all print-ordered images. (They cannot be set individually for each image.)

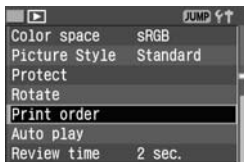

1 Select [Print order].

- Turn the <⊙> dial to select [], then press <SET>.
- ▶ The Print Order screen will appear.

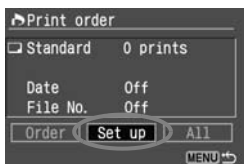

2 Select [Set up].

- Turn the <⊙> dial to select [**Set up**], then press <SET>.
- ▶ The print setting screen will appear.



3 Set the options as desired.

- Set the [**Print type**], [**Date**], and [**File No.**].
- Turn the <⊙> dial to select the menu item, then press <SET>.
- Turn the <⊙> dial to select the desired setting, then press <SET>.

[Print type]

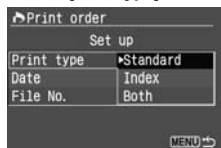



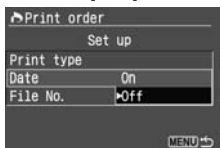

[Date]

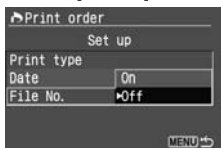

[File No.]



Print type		Standard	Prints one image on one sheet.
		Index	Multiple, thumbnail images are printed on one sheet.
	 	Both	Prints both the standard and index prints.
Date	On	[On] imprints the recorded date on the print.	
	Off		
File No.	On	[On] imprints the file No. on the print.	
	Off		

4 Exit the menu.

- Press the <MENU> button.
- ▶ The Print Order screen will reappear.
- Next, select [**Order**] or [**All**] to select the images to be printed.

- RAW images cannot be selected for printing.
- Even if [**Date**] and [**File No.**] are set to [**On**], the date or file No. might not be imprinted depending on the print type setting and printer type.
- With [**Index**] prints, both the [**Date**] and [**File No.**] cannot be set to [**On**] at the same time.
- When printing with DPOF, you must use the CF card whose Print Order specifications have been set. It will not work if you just extract images from the CF card and try to print them.
- Certain DPOF-compatible printers and photo labs might not be able to print the photos as you specified. If this happens with your printer, refer to the printer's instruction manual. Or check with your photo lab about compatibility when ordering prints.
- Do not insert into the camera a CF card containing images captured by a different camera and then try to order prints. The images specified for the print order might be inadvertently overwritten. Also, depending on the image type, the print order may not be possible.

Selecting Individual Images for Printing

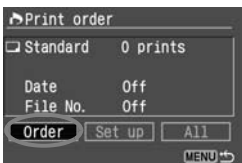

1 Select [Order].

- Turn the <⊙> dial to select [Order], then press <SET>.
- ▶ The order screen will appear.



2 Select the image to be printed.

- Turn the <⊙> dial to select the image to be printed.
- Press the <⊞-Q> button to see a three-image view. To return to the single-image view, press the <Q> button.

Three-image view



3 Order the print.

- The print order will vary depending on the [Print type] (p.140) setting.



For [Standard] and [Both]

- For standard-type prints, you can set the quantity (up to 99) for each image.
- Press <SET>, then turn the <⊙> dial to select the print quantity. Then press <SET>.



For [Index]

- If you want to include the image in the index print, checkmark <✓> the box. Otherwise, leave the box unchecked.
- Press <SET> to checkmark the box <✓>, or press <SET> again to remove the checkmark.
- If there are other images you want to select, repeat steps 2 and 3.
- You can select up to 998 images.

4 Exit the menu.

- Press the <MENU> button.
- ▶ The Print Order screen will reappear.
- Press the <MENU> button again to save the print order to the CF card. The menu will then reappear.

Selecting All images

The print order can also be set or canceled for all the images in the CF card. For standard-type prints, a quantity of one will be ordered for all the images.

Note that after following the “Selecting Individual Images” procedure, if you do the “Selecting All Images” procedure, the print order will change to “All images.”

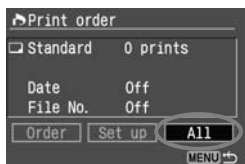

1 Select [All].

- Turn the <⊙> dial to select **[All]**, then press <SET>.
- ▶ The All screen will appear.

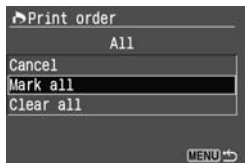

2 Select [Mark all].

- Turn the <⊙> dial to select **[Mark all]**, then press <SET>.
- ▶ One print each will be specified for all the images, then the print order screen will reappear.
- If you select **[Clear all]**, all the images selected for printing will be deselected.
- If you select **[Cancel]**, the print order screen will reappear.

3 Exit the menu.

- On the Print Order screen, press the <MENU> button.
- ▶ The settings will be saved to the CF card, and the menu will reappear.

- ⚠ Note that RAW images cannot be selected for printing even when you set “Mark all.”
- When using a PictBridge printer, print no more than 500 images for one print order. If you specify more than this, all the selected images might not be printed.

MENU Direct Printing with DPOF

With a printer compatible with direct printing, you can easily print images specified with DPOF.

1 Prepare to print.

- See “Setting the Camera” (steps 1 and 2) and “Connect the camera to the printer” (steps 1 to 5) on pages 123 to 124.



2 Select [Print order].

- Turn the <⦿> dial to select [> **Print order**], then press <SET>.
- ▶ The Print Order screen will appear.

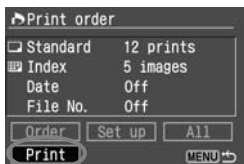

3 Select [Print].

- Turn the <⦿> dial to select [**Print**], then press <SET>.
- [**Print**] will be displayed only if the camera is connected to the printer and printing is possible.
- ▶ The print setting screen will appear.

4 Set the printing options.

 PictBridge

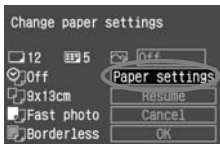

 CP Direct



 Bubble Jet Direct

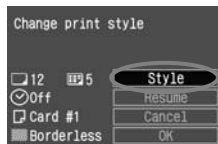





 **PictBridge**

- Set the [**Paper settings**] and <> printing effects. (p.126)

CP Direct / Bubble Jet Direct

- Set the [Style]. (p.130/133)

5 Start printing.

- Turn the <  > dial to select [OK], then press <  >.
- ▶ The printing will start.
- To stop the printing, press <  > while [Stop] is displayed, then turn the <  > dial to select [OK] and press <  >.

- When printing with a PictBridge or Bubble Jet Direct printer, be sure to set the paper size.
- With PictBridge, the file No. cannot be imprinted depending on the printer.
- If [Bordered] is set, the date might be imprinted on the border, depending on the printer.
- The date might look light if it is imprinted on a bright background or border.

- With CP Direct, if [Print type] is set to [Index], the number of images printed on one index sheet will be as follows:
 - Credit card size: 20 images • 9 x 13 cm size: 42 images
 - 10 x 14.8 cm size: 63 images
 As for the number of index images with Bubble Jet Direct, see the BJ printer's instruction manual.
- If you stopped the printing and want to resume printing the remaining images, select [Resume]. Note that printing will not resume if you stop the printing and any of the following occurs:
 - Before resuming the printing, you changed the print order settings.
 - Before resuming the printing, you erased an image that was to be printed.
 - In the case of index printing with CP Direct, you changed the paper cassette before resuming the printing.
 - In the case of index printing with PictBridge, you changed the paper settings before resuming the printing.
 - When you stopped the printing, the CF card's remaining capacity was low.
- If there is a printing problem, see page 129 for PictBridge, page 132 for CP Direct, or page 135 for Bubble Jet Direct.

9

Customizing the Camera

The current camera settings can be saved under the Mode Dial's **<C>** setting.

Also, Custom Functions enable you to fine-tune your camera to suit your shooting preferences.

- Custom Functions work in all modes except **<A>** (Full Auto).

MENU Register Camera Settings ★

Most of the current camera settings can be set under the Mode Dial's <C> setting. **Set the shooting mode to any mode except <A> (Full Auto). The camera settings cannot be registered in the <A> (Full Auto) mode.**

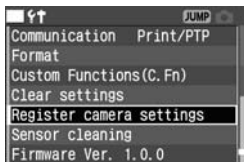

1 Select [Register camera settings].

- Turn the <DIAL> dial to select [**↑↑** Register camera settings], then press <SET>.

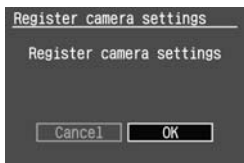

2 Select [OK].

- Turn the <DIAL> dial to select [OK], then press <SET>.
- ▶ The following camera settings will be registered under the Mode Dial's <C> setting:

Shooting settings

Shooting mode and settings, AF mode, AF point selection, Metering mode, ISO speed, Drive mode, Exposure compensation, Flash exposure compensation, White balance

Menu settings

Quality, Beep, Shoot w/o card, AEB, WB SHIFT/BKT, Custom WB, Color temp., Color space, Picture Style, Review time, AF points, Histogram, Auto power off, Auto rotate, LCD brightness, File numbering (method), Custom Functions (C.Fn)

ⓘ Even when the Mode Dial is set to the <C> setting, you can still change the drive mode and menu settings. If you want to include those changes under the <C> setting, just follow the above procedure.

- To view the settings registered under the <C> setting, set the Mode Dial to the <C> setting and press the <INFO.> button. The registered settings will be displayed on the LCD monitor.
- To revert the <C> setting to the default, select [**Clear registered camera set.**] with step 2 explained on page 150. The settings will be reset to the settings shown on page 37.

MENU Setting a Custom Function★

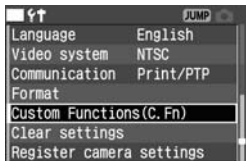

1 Select [Custom Functions (C.Fn)].

- Turn the <◉> dial to select [**↑** Custom Functions (C.Fn)], then press <SET>.
- ▶ The Custom Function screen will appear.

Custom Function No.

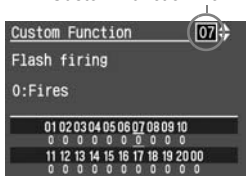

2 Select Custom Function No.

- Turn the <◉> dial to select the desired setting, then press <SET>.

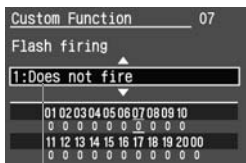

Description

3 Change the setting.

- Turn the <◉> dial to select the desired setting, then press <SET>.
- Repeat steps 2 and 3 if you want to set other Custom Functions.
- On the bottom of the screen, you can see the current Custom Function settings.

4 Exit the menu.

- Press the <MENU> button to return to the menu.
- When you exit the menu, <C.Fn> will be displayed on the LCD panel.



Even if the C.Fn-00 focusing screen setting is changed from C.Fn-00-0 to something else, <C.Fn> will not be displayed on the LCD panel.

Resetting All Custom Functions *

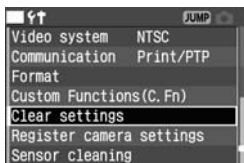

1 Select [Clear settings].

- Turn the <⊙> dial to select [**↑↑** **Clear settings**], then press <SET>.
- ▶ The Clear settings screen will appear.

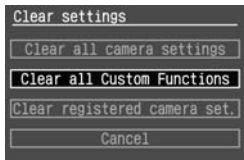

2 Select [Clear all Custom Functions].

- Turn the <⊙> dial to select [**Clear all Custom Functions**], then press <SET>.

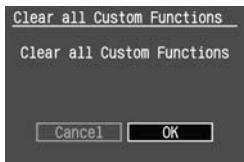

3 Select [OK].

- Turn the <⊙> dial to select [**OK**], then press <SET>. All the Custom Functions will be reset to the default settings.

- The C.Fn-00 focusing screen setting will not be canceled.
- When the shooting mode is <□>, the camera settings and Custom Function settings cannot be reset or cleared to the default settings.

MENU Custom Function Settings ★

C.Fn-01 SET function when shooting

You can change the function assigned to <SET>.

0: Default (no function)

1: Change quality

After pressing <SET>, look at the LCD panel and turn the <DIAL> dial to set the recording quality directly.

2: Change Picture Style

Press the <SET> button to display the Picture Style selection screen on the LCD monitor. Turn the <DIAL> dial to select the desired Picture Style, then press <SET>.

3: Menu display

Gives the same function as the <MENU> button.

4: Image replay

Gives the same function as the <REPLAY> button.

C.Fn-02 Long exp. noise reduction

0: Off

1: Auto noise reduction

For 1 sec. or longer exposures, noise reduction is performed automatically if long exposure noise is detected. Setting this to [Auto noise reduction] is very effective.

2: On

Noise reduction is performed for all exposures 1 sec. or longer. Setting this may reduce the noise even for exposures which would not have been noise detected/reduced at the [Auto noise reduction] setting.



After the exposure, noise reduction may take the same amount of time as the exposure time. While the noise reduction is in progress, image playback and menu operation are not possible. However, you can still shoot as long as the maximum burst indicator in the viewfinder shows "1" or higher.

C.Fn-03 Flash sync. speed in Av mode

0: Auto

1: 1/200sec. (fixed)

Sets the flash sync speed to 1/200 sec. in the aperture-priority AE (Av) mode. (Against dark backgrounds such as the night sky, the subject's background will look dark.)

C.Fn-07 Flash firing

Enables or disables the firing of an external flash or non-Canon flash connected to the PC terminal.

- 0: Fires**
1: Does not fire

C.Fn-08 ISO expansion

- 0: Off**
1: On

Enables or disables the selection of the "L" setting for ISO 50 and "H" setting for ISO 3200.

C.Fn-09 Bracket sequence / Auto cancel

You can change the AEB sequence when the pictures are bracketed with the shutter speed or aperture and the file-saving sequence for white balance bracketing (WB-BKT).

When "Auto cancellation" is set, bracketing will be canceled in the following cases:

AEB: You turn the <☺> switch to <OFF>, change lenses, have flash-ready, replace the battery, or replace the CF card.

WB-BKT: You turn the <☺> switch to <OFF>, replace the battery, or replace the CF card.

- 0: 0, -, +/Enable**
1: 0, -, +/Disable (Auto cancel works only if the flash is ready.)
 The first bracketed shot is the standard exposure (or exposed with the standard white balance). This bracketing sequence can be repeated.
2: -, 0, +/Enable
 Starts the bracketing sequence with the minus (or bluish or magenta bias) setting.
3: -, 0, +/Disable (Auto cancel works only if the flash is ready.)
 Repeats the bracketing sequence starting with the minus (or bluish or magenta bias) setting. This bracketing sequence can be repeated.

AEB	WB bracketing	
	B/A Bias	M/G Bias
0 : Standard exposure	0 : Standard white balance	0 : Standard white balance
- : Decreased exposure	- : More blue	- : More magenta
+ : Increased exposure	+ : More amber	+ : More green

C.Fn-10 Superimposed display**0: On****1: Off**

The AF point in the viewfinder will not flash in red. Recommended when it is bothersome to see it light up.

The AF point will still light when you select it.

C.Fn-11 Menu button display position

When you press the <MENU> button, you can set the menu screen setting.

0: Previous (top if power off)

Displays the preceding menu screen that was used. Note that the top menu screen [**Quality**] will be displayed instead when the <☺> switch is turned <OFF>.

1: Previous

Displays the preceding menu screen that was used.

2: Top

Always displays the top menu screen [**Quality**].

C.Fn-12 Mirror lockup**0: Disable****1: Enable**

Effective for close-up and telephoto shots to prevent camera shake caused by the mirror's reflex action. See page 97 for the mirror lockup procedure.

C.Fn-13 AF point selection method**0: Normal**

Press the <☺> button and use <☼> to select the AF point.

1: Multi-controller direct

Without pressing the <☺> button first, you can just use the <☼> to select the desired AF point. Pressing the <☺> button will set it to automatic AF point selection.

2: Quick Control Dial direct

Without pressing the <☺> button first, you can just use the <☼> dial to select an AF point directly. By holding down the <☺> button and turning the <☼> dial, you can set the exposure compensation.

C.Fn-14 E-TTL II**0: Evaluative**

Fully automatic flash photography for all conditions, from low light to daylight fill-flash.

1: Average

The flash is averaged for the entire area covered by the flash. Since automatic flash exposure compensation will not be executed, you may have to set it yourself depending on the scene. This also applies if you use FE lock.

C.Fn-15 Shutter curtain sync.**0: 1st-curtain sync.****1: 2nd-curtain sync.**

When a slow shutter speed is set, you can capture a light trail following the subject. The flash fires right before the shutter closes. This Custom Function can be used to obtain 2nd-curtain sync effects even with EX-series Speedlites which do not have this feature. If the EX-series Speedlite has this feature, it will override this Custom Function.



When 2nd-curtain sync is used, a preflash will be fired for flash metering control right after you press the shutter button completely. Remember that the main flash will fire right before the shutter closes.







C.Fn-16 Safety shift in AV or TV**0: Disable****1: Enable**



This works in the shutter-priority AE (Tv) and aperture-priority AE (Av) modes. If the subject's brightness changes suddenly and the current shutter speed or aperture becomes unsuitable, the shutter speed or aperture is shifted automatically to obtain a suitable exposure.





C.Fn-17 AF point activation area**0: Standard****1: Expanded**

In the AI SERVO AF mode when the center AF point is selected, six invisible Assist AF points within the spot metering circle also become active. Therefore, seven AF points will track the subject (p.76). This is effective for subjects that move erratically, making it difficult for only the center AF point to track it.

C.Fn-18 LCD displ -> Return to shoot.**0: With Shutter Button only****1: Also with  etc.**

During image playback or the menu display, pressing the , , , , , , or depth-of-field preview button will exit the image playback or menu display and make the pressed button active.

Also, during the image review right after image capture, you can hold down the  button and press the  or  button to magnify or reduce the image.

-  ● Even during image playback with the  button, you can hold down the  button and press the  or  button to magnify or reduce the image.
- “Easy Printing” (p.138) will not work.

C.Fn-19 Lens AF stop button function

0: AF stop

1: AF start

AF operates only while the AF stop button is pressed. While the button is pressed, AF operation with the camera is disabled.

2: AE lock while metering

When the button is pressed while metering is still active, AE lock is applied. Convenient when you want to focus and meter separately.

3: AF point: M -> Auto / Auto -> ctr

In the manual AF point selection mode, the button instantly switches to automatic AF point selection from manual AF point selection only while you hold it down. Convenient when you are no longer able to focus track a moving subject with a manually-selected AF point in the AI Servo AF mode. In the automatic AF point selection mode, the button selects the center AF point only while you hold it down.

4: ONE SHOT <-> AI SERVO

In the One-Shot AF mode, the button switches to the AI Servo AF mode only while you hold it down. In the AI Servo AF mode, the button switches to the One-Shot AF mode only while you hold it down. Convenient when you need to keep switching between One-Shot AF and AI Servo AF for a subject which keeps moving and stopping.

5: IS start

With the lens' IS switch already ON, the Image Stabilizer operates only while you press the button.



The AF stop button is provided only on super telephoto lenses.

C.Fn-20 Add original decision data

0: Off

1: On

Data for verifying whether the image is original or not is appended to the image. When an image appended with the verification data is played back, the icon will be displayed. (p.108) To verify whether the image is original, the Data Verification Kit DVK-E2 (optional) is required.

C.Fn-00 Focusing Screen

The camera provides interchangeable focusing screens. This Custom Function must be set so that the exposure correction matches the respective focusing screen.

0: Ee-A

1: Ee-D

2: Ee-S

About focusing screen characteristics

Ee-A: Standard Precision Matte

Standard focusing screen that comes with the camera. Provides good viewfinder brightness and enables easy manual focusing.

Ee-D: Precision Matte with grid

This is the Ee-A with a grid. It makes it easier to align horizontal or vertical lines.

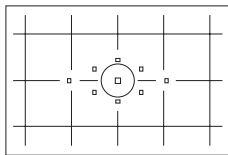

Ee-S: Super Precision Matte

Focusing screen which makes manual focusing easier than with the Ee-A. Effective for users who mainly focus manually.

Super Precision Matte Ee-S and lens's maximum aperture

- Optimum for the lenses whose maximum aperture is $f/2.8$ or larger.
- With the lenses whose maximum aperture is smaller than $f/2.8$, the viewfinder looks darker than attaching the standard focusing screen Ee-A.

-  Since the Ee-A focusing screen comes with the EOS 5D, C.Fn-00-0 is already set.
- To change the focusing screen, follow the instructions that comes with the focusing screen.
- The C.Fn-00 setting is not included in the registered camera settings (p.148).

10

Reference

This section will help you understand your camera better. It covers information on camera features, system accessories, and other reference information.

Shooting Combinations

AF Modes and Drive Modes

Drive mode	AF mode		
	One-Shot AF	AI Focus AF	AI Servo AF
<input type="checkbox"/> Single shooting	An image cannot be taken unless focus is achieved. When focus is achieved, it is locked. With evaluative metering, the exposure setting is also locked. (The exposure setting is stored in memory before the shot is taken.)	Automatically switches between ONE SHOT AF and AI Servo AF according to the subject status.	The focus tracks the subject movement. The exposure is set at the moment the picture is taken.
<input type="checkbox"/> Continuous shooting	The above conditions apply during continuous shooting. During continuous shooting (max. 3 shots/sec.), focusing is not executed.		The above conditions apply during continuous shooting. During continuous shooting (max. 3 shots/sec.), focusing is executed.

AE lock

(Other than the < > (Full Auto) mode.)

Metering mode	AF point selection	
	Automatic AF point selection	Manual AF point selection
<input checked="" type="checkbox"/> Evaluative Metering*	AE lock is applied at the AF point that achieved focus.	AE lock is applied at the selected AF point.
<input checked="" type="checkbox"/> Partial Metering	AE lock is applied at the center AF point.	
<input checked="" type="checkbox"/> Spot Metering		
<input type="checkbox"/> Center-weighted Average Metering		

* When the lens' focus mode switch is set to <MF>, AE lock is applied at the center AF point.

Program Line

The following program line applies when the camera is in Program AE <P> mode.

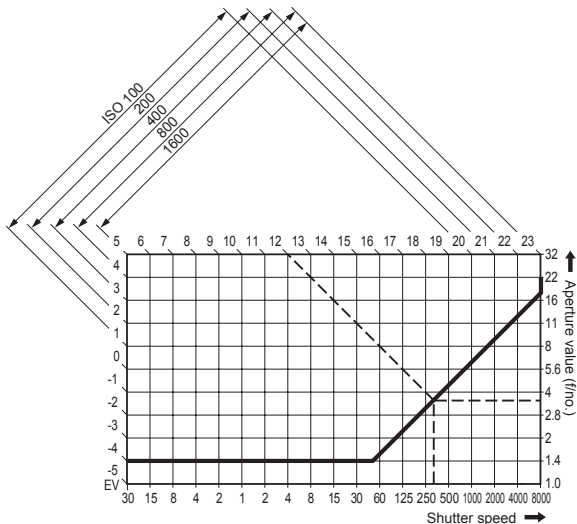

Program Line Description

The lower horizontal axis represents the shutter speed, and the right-hand vertical axis represents the aperture value. The combinations of shutter speed and aperture value automatically determined by Program AE are shown as lines with respect to the subject brightness (Exposure Value) gradations on the left and top edges of the graph.

Example: Using an EF50mm f/1.4 USM lens with a subject brightness of EV12, the point where the diagonal line from EV12 (on the top edge) intersects the Program AE line represents the corresponding shutter speed (1/320 second) and aperture value (f/3.5) that the program sets automatically. The diagonal arrowed lines at the upper left indicate the metering range for each ISO speeds.

Troubleshooting Guide

If there is a problem, first refer to this Troubleshooting Guide. If this Troubleshooting Guide does not resolve the problem, contact your dealer or nearest Canon Service Center.

Power Source

The battery cannot be recharged.

- **You are using the wrong battery.**
 - ▶ Do not recharge any battery pack other than Battery Pack BP-511A, BP-514, BP-511, or BP-512.
- **The battery is not properly attached to the battery charger.**
 - ▶ Attach the battery properly to the charger. (p.22)

The camera does not operate even when the  switch is set to <ON> or .

- **The battery is exhausted.**
 - ▶ Recharge the battery. (p.22)
- **The battery is not installed properly.**
 - ▶ Install the battery properly. (p.24)
- **Battery compartment cover is not closed.**
 - ▶ Close the battery compartment cover securely. (p.24)
- **CF card slot cover is not closed.**
 - ▶ Close the CF card slot cover securely. (p.28)

The access lamp blinks even when the  switch is set to <OFF>.

- **If you set the  switch to <OFF> right after shooting, the access lamp will still light/blink for a few seconds while the image is recorded onto the CF card.**
 - ▶ When the camera finishes recording the image to the CF card, the access lamp will stop blinking and the power will turn off automatically.

The battery becomes exhausted quickly.

- **The battery is not fully charged.**
 - ▶ Recharge the battery fully. (p.22)
- **The battery's service life has expired.**
 - ▶ Replace the battery with a new one.

The camera turns off by itself.

- **Auto power off is in effect.**
 - ▶ Press the shutter button halfway. If you do not want auto power off to take effect, set [**↑** **Auto power off**] on the menu to [**Off**].

Only the <[]> icon blinks on the top LCD panel.

- **The battery is almost exhausted.**
 - ▶ Recharge the battery. (p.22)

Shooting**No images can be shot or recorded.**

- **The CF card is not properly inserted.**
 - ▶ Insert the CF card properly. (p.28)
- **The CF card is full.**
 - ▶ Use a new CF card or erase unnecessary images. (p.28, 118)
- **The battery is exhausted.**
 - ▶ Recharge the battery. (p.22)
- **You did not focus well. (The focus confirmation light <●> in the viewfinder blinks.)**
 - ▶ Press the shutter button halfway again and focus the subject. If you still cannot focus properly, focus manually. (p.30, 80)

The LCD monitor does not display a clear image.

- **The LCD monitor screen is dirty.**
 - ▶ Use a soft, lens cloth to clean the screen.
- **The LCD's service life has expired.**
 - ▶ Consult your nearest customer service center or dealer.

The image is out of focus.

- **The lens focus mode switch is set to <MF>.**
 - ▶ Set the lens focus mode switch to <AF>. (p.27)
- **Camera shake occurred when you pressed the shutter button.**
 - ▶ To prevent camera shake, hold the camera still and press the shutter button gently. (p.30, 44)

The CF card cannot be used.

- **[Err **] is displayed on the LCD panel.**
 - ▶ If it is [Err CF], see page 120.
 - ▶ If it is [Err 02], see page 165.
- **You are using a non-Canon CF card.**
 - ▶ Using Canon CF cards is recommended. (p.167)

Image Review & Operation

The image cannot be erased.

- **The image is erase-protected.**
 - ▶ Cancel the protection. (p.117)

The wrong shooting date and time is displayed.

- **The correct date and time has not been set.**
 - ▶ Set the correct date and time. (p.40)

No image appears on the TV screen.

- **Video cable plugs are not inserted all the way.**
 - ▶ Insert the video cable plugs firmly all the way. (p.116)
- **The correct video format (NTSC or PAL) has not been set.**
 - ▶ Set the camera to the correct video format to match the TV set. (p.36)
- **You are not using the video cable that came with the camera.**
 - ▶ Use the video cable that came with the camera. (p.116)

Error Codes

If a camera error occurs, “**Err xx**” will be displayed on the LCD panel. Follow the instruction below to resolve the problem for respective error code.

If the same error occurs often, something is probably wrong with the camera. Jot down the “**xx**” error code and take your camera to the nearest Canon Service Center.

If an error occurs after you take a picture, the camera might have missed the shot. Press the <▶> button to see if the image appears on the LCD monitor.

Error Code	Countermeasures
Err 01	Communications between the camera and lens is faulty. Clean the lens contacts. (p.11)
Err 02	There is a problem with the CF card. Try any of the following: Remove and re-insert the memory card. Formatting the CF Card. Use another CF card instead.
Err 04	The memory card is full. Erase unnecessary images in the card or replace the CF card.
Err 99	An error other than the above has occurred. Press the shutter button halfway or remove and reinstall the battery. This error may occur if you use a non-Canon lens and the camera or lens does not operate properly.

Major Accessories (Optional)



Battery Pack BP-511A

High-capacity, lithium-ion, secondary power pack.



AC Adapter Kit ACK-E2

Power source kit (AC adapter, DC coupler, power cord) for supplying power to the camera with a household power outlet. Compatible with 100 - 240 V AC.



Compact Power Adapter CA-PS400

Quick charger for BP-511A. It takes about 110 minutes to recharge one pack. Two packs can be attached to it at one time. DC Coupler DR-400 (optional) can also be connected to the CA-PS400. Compatible with 100 - 240 V AC.



Battery Grip BG-E4

This accommodates two BP-511A packs or six size-AA batteries. It has a vertical-grip shutter button, electronic dial, AE lock/FE lock button, and AF point selection button.



Shoe-mount Speedlites

An EX-series Speedlite can be attached to the camera's hot shoe. In the same way as normal exposures, you can use E-TTL II autoflash for flash exposures.



Macro Lites

The EX-series Macro Lites (two models) are ideal for close-up flash photography. You can fire only one or both flash tubes and control the flash ratio to easily obtain sophisticated lighting effects with E-TTL II autoflash.



Remote Switch RS-80N3

This is a remote switch to prevent camera shake for super-telephoto shots, macroshooting, and bulb exposures. The cord is 80 cm/2.6 ft. The switch provides the same effect as pressing the shutter button halfway or completely. A shutter-release lock is also provided. The connection plug for the camera has a quick-lock feature.



Timer Remote Controller TC-80N3

Attached with an 80 cm/2.6 ft cord, this remote switch has four built-in functions: 1. Self-timer, 2. Interval timer, 3. Bulb-exposure timer, and 4. Shutter-release count setting. The timer can be set anywhere from 1 sec. to 99 hours, 59 min., 59 sec. in 1-sec. increments. The connection plug for the camera has a quick-lock feature.



Wireless Controller LC-5

Wireless controller effective up to 100 meters/330 ft. It consists of a transmitter and receiver. The receiver's camera connection plug connects to the camera's remote control terminal.



E-series Dioptric Adjustment Lenses

One of ten E-series dioptric adjustment lenses (-4 to +3 diopters) can be attached to the camera's eyepiece to further expand the dioptric adjustment range.

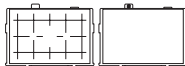

Focusing Screens Ee-D and Ee-S

The Ee-D has a grid for easier alignment with horizontal or vertical lines, and the Ee-S makes manual focusing easier.



CF card

Data storage media where the captured images are recorded. CF cards made by Canon are recommended.

System Map

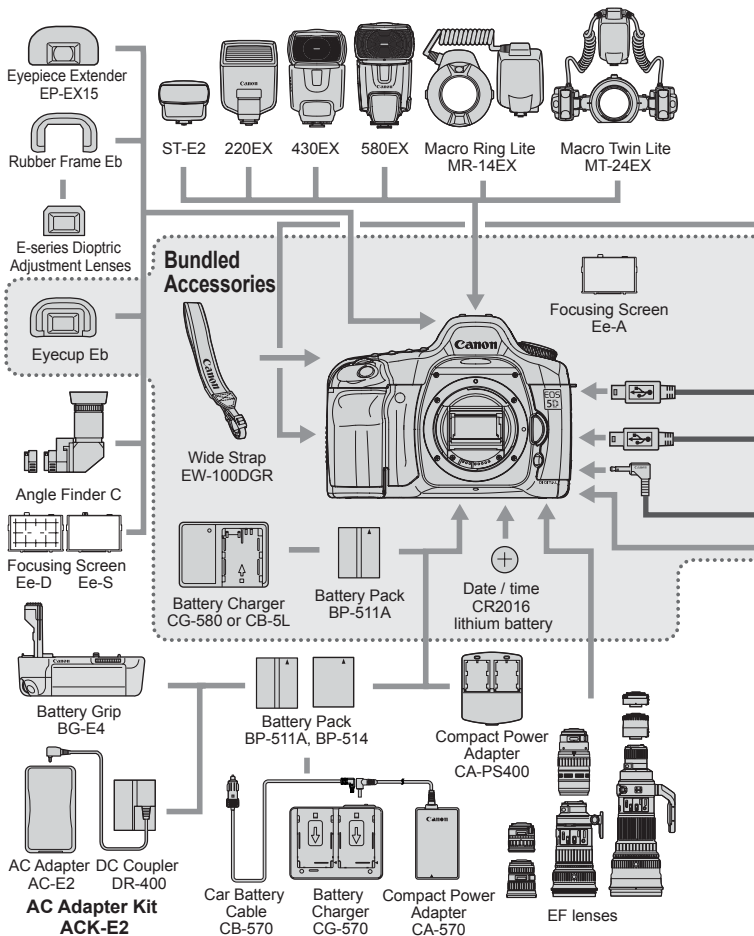

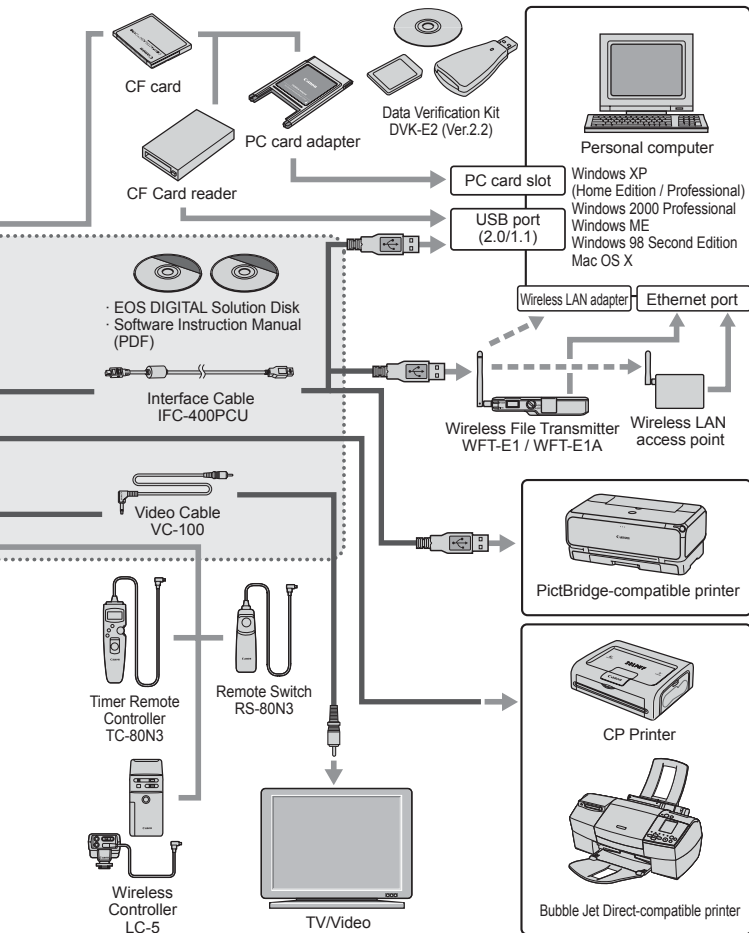

Specifications

• Type

Type:	Digital, single-lens reflex, AF/AE camera
Recording media:	Type I or II CF card * Compatible with Microdrive and 2GB or larger CF cards
Image sensor size:	35.8 x 23.9mm
Compatible lenses:	Canon EF lenses (except EF-S lenses)
Lens mount:	Canon EF mount

• Imaging Element

Type:	High-sensitivity, high-resolution, large single-plate CMOS sensor
Pixels:	Effective pixels: Approx. 12.80 megapixels Total pixels: Approx. 13.30 megapixels
Aspect ratio:	3:2
Color filter system:	RGB primary color filter
Low-pass filter:	Located in front of the image sensor, non-removable

• Recording System

Recording format:	Design rule for Camera File System 2.0
Image type:	JPEG, RAW (12bit)
RAW+JPEG	
simultaneous recording:	Possible
File size:	(1) Large/Fine: Approx. 4.6MB (4368 x 2912 pixels) (2) Large/Normal: Approx. 2.3MB (4368 x 2912 pixels) (3) Medium/Fine: Approx. 2.7MB (3168 x 2112 pixels) (4) Medium/Normal: Approx. 1.4MB (3168 x 2112 pixels) (5) Small/Fine: Approx. 2.0MB (2496 x 1664 pixels) (6) Small/Normal: Approx. 1.0MB (2496 x 1664 pixels) (7) RAW: Approx. 12.9MB (4368 x 2912 pixels) * Exact file sizes depend on the subject, ISO speed, Picture Style, etc.
Folder setting:	Folder creation/selection enabled
File numbering:	Consecutive numbering, auto reset, manual reset
Color space:	sRGB, Adobe RGB
Picture Style:	Standard, Portrait, Landscape, Neutral, Faithful, Monochrome, User Defined 1, 2, 3
Interface:	USB 2.0 Hi-Speed (Print/PTP / PC connect. selectable) Video output (NTSC/PAL)

• White Balance

Type:	Auto, daylight, shade, cloudy, tungsten light, white fluorescent light, flash, custom, color temperature setting
Auto white balance:	Auto white balance with the image sensor
Color temperature compensation:	White balance correction: ±9 stops in full-stop increments White balance bracketing: ±3 stops in full-stop increments * Blue/amber bias or magenta/green bias possible
Color temperature information transmission:	Provided

• Viewfinder

Type:	Eye-level pentaprism
Coverage:	Vertical/Horizontal approx. 96%
Magnification:	Approx. 0.71x (-1 diopter with 50mm lens at infinity)
Eyepoint:	20 mm
Built-in dioptic adjustment:	-3.0 - +1.0 diopter
Focusing screen:	Interchangeable (two types optional), Ee-A (Precision Matte) focusing screen provided
Mirror:	Quick-return half mirror (Transmission:reflection ratio of 40:60, no mirror cut-off with EF600mm f/4 or shorter lens)
Viewfinder information:	AF information (AF points, focus confirmation light), exposure information (shutter speed, aperture value, AE lock, exposure level, spot metering circle, exposure warning), flash information (flash ready, high-speed sync, FE lock, flash exposure compensation), white balance correction, maximum burst, CF card information
Depth-of-field preview:	Enabled with depth-of-field preview button

• Autofocus

Type:	TTL-CT-SIR with a CMOS sensor (TTL secondary image-registration, phase detection)
AF points:	9 plus 6 Assist AF points
Metering range:	EV -0.5 - 18 (at 20°C/68°F, ISO 100)
Focus modes:	One-Shot AF, AI Servo AF, AI Focus AF, Manual focusing (MF)
AF point selection:	Auto, manual
Selected AF point display:	Superimposed in viewfinder and indicated on LCD panel

AF-assist beam: Emitted by the dedicated Speedlite

• Exposure Control

Metering modes: 35-zone TTL full aperture metering

- Evaluative metering (linkable to any AF point)
- Partial metering (approx. 8% of viewfinder at center)
- Spot metering (approx. 3.5% of viewfinder at center)
- Center-weighted Average Metering

Metering range: EV 1-20 (at 20°C/68°F with EF50mm f/1.4 lens, ISO 100)

Exposure control: Full auto, program AE (shiftable), shutter-priority AE, aperture-priority AE, manual exposure, E-TTL II autoflash

ISO speed: Equivalent to ISO 100-1600 (in 1/3-stop increments), ISO speed can be expanded to ISO 50 and 3200.
Full auto: ISO 100-400 set automatically

Exposure compensation: Manual: ± 2 stops in 1/3- or 1/2-stop increments (can be combined with AEB)
AEB: ± 2 stops in 1/3- or 1/2-stop increments

AE lock: Auto: Applied in One-Shot AF mode with evaluative metering when focus is achieved.
Manual: By AE lock button in all metering modes.

• Shutter

Type: Electronically-controlled, focal-plane shutter

Shutter speeds: 1/8000 to 30 sec. (1/3- and 1/2-stop increments), bulb X-sync at 1/200 sec.

Shutter release: Soft-touch electromagnetic release

Self-timer: 10-sec. delay

Remote control: Remote control with N3 type terminal

• External Speedlite

EOS-dedicated Speedlite: E-TTL II autoflash with EX-series Speedlite

Flash exposure compensation: ± 2 stops in 1/3- or 1/2-stop increments.

FE lock: Provided

PC terminal: Provided

Zooming to match lens focal length: Provided

• Drive System

Drive modes:	Single, continuous, and Self-timer (10 sec.)
Continuous:	Max. 3 shots per sec.
Max. burst:	JPEG (Large/Fine): Approx. 60, RAW: Approx. 17 * With a Canon 512MB CF card. * Varies depending on the subject, ISO speed, Picture Style, CF card, etc.

• LCD Monitor

Type:	TFT color liquid-crystal monitor
Monitor size:	2.5 in.
Pixels:	Approx. 230,000
Coverage:	100% with respect to the effective pixels
Brightness adjustment:	Five levels provided
Interface languages:	15

• Image Playback

Display format:	Single image, shooting information, 9-image index, magnified view (Approx. 1.5x - 10x), autoplay, image rotation, and Jump (by 10 or 100 images, by date, by folder)
Highlight warning:	In the shooting information mode, any overexposed highlight areas with no image information will blink.
Histogram:	Brightness, RGB
AF point display:	Enabled

• Image Protection and Erase

Protect:	Single images can be erase-protected or not.
Erase:	One image or all images in the CF card can be erased (except protected images).

• Direct Printing

Compatible printers:	CP Direct, Bubble Jet Direct, and PictBridge-compatible printers
Printable images:	JPEG images (DPOF printing possible)
Easy Print feature:	Provided

• DPOF: Digital Print Order Format

DPOF:	Version 1.1 compatible
-------	------------------------

• Customization

Camera setting registration: Under Mode Dial's <C> setting
Custom Functions: 21 Custom Functions with 57 settings

• Power Source

Battery: One Battery Pack BP-511A, BP-514, BP-511, or BP-512.
* AC power can also be supplied with the DC Coupler.
* With Battery Grip BG-E4, size-AA batteries can be used.

Battery life: At 20°C / 68°F: Approx. 800 shots
At 0°C / 32°F: Approx. 400 shots
* The above figures apply when a fully-charged Battery Pack BP-511A is used.

Battery check: Automatic
Power saving: Provided. Power turns off after 1, 2, 4, 8, 15, or 30 min.
Date/Time battery: One CR2016 lithium battery

• Dimensions and Weight

Dimensions (W x H x D): 152 x 113 x 75 mm / 6.0 x 4.4 x 3.0 in.
Weight: Approx. 810g / 28.6 oz. (body only)

• Operation Environment

Working temperature range: 0°C- 40°C / 32°F - 104°F
Working humidity: 85% or less

• Battery Pack BP-511A

Type: Rechargeable lithium ion battery
Rated voltage: 7.4 V DC
Battery capacity: 1390 mAh
Dimensions (W x H x D): 38 x 21 x 55 mm / 1.5 x 0.8 x 2.2 in.
Weight: Approx. 82 g / 2.9 oz

• Battery Charger CG-580

Compatible battery: Battery Pack BP-511A, BP-514, BP-511, or BP-512
Recharging time: BP-511A, BP-514: Approx. 100 min.
BP-511, BP-512: Approx. 90 min.

Rated input: 100 - 240 V AC
Rated output: 8.4 V DC
Working temperature range: 0°C - 40°C / 32°F - 104°F
Working humidity: 85% or less
Dimensions (W x H x D): 91 x 67 x 31 mm / 3.6 x 2.6 x 1.2 in.
Weight: Approx. 115 g / 4.0 oz

• Battery Charger CB-5L

Compatible battery:	Battery Pack BP-511A, BP-514, BP-511, or BP-512
Power cord length:	Approx. 1.8 m / 5.9 ft.
Recharging time:	BP-511A, BP-514: Approx. 100 min. BP-511, BP-512: Approx. 90 min.
Rated input:	100 - 240 V AC
Rated output:	8.4 V DC
Working temperature range:	0°C - 40°C / 32°F - 104°F
Working humidity:	85% or lower
Dimensions (W x H x D):	91 x 67 x 32.3 mm / 3.6 x 2.6 x 1.3 in.
Weight:	Approx. 105 g / 3.7 oz (excluding power cord)

- All the specifications above are based on Canon's testing standards.
- The camera's specifications and physical appearance are subject to change without notice.

Digital Camera Model DS126091 Systems

This device complies with Part 15 of the FCC Rules. Operation is subject to the following two conditions: (1) This device may not cause harmful interference, and (2) this device must accept any interference received, including interference that may cause undesired operation.

Note: This equipment has been tested and found to comply with the limits for class B digital devices, pursuant to Part 15 of the FCC Rules.

These limits are designed to provide reasonable protection against harmful interference in a residential installation. This equipment generates, uses and can radiate radio frequency energy and, if not installed and used in accordance with the instructions, may cause harmful interference to radio communications. However, there is no guarantee that interference will not occur in a particular installation. If this equipment does cause harmful interference to radio or television reception, which can be determined by turning the equipment off and on, the user is encouraged to try to correct the interference by one or more of the following measures:

- Reorient or relocate the receiving antenna.
- Increase the separation between the equipment and receiver.
- Connect the equipment into an outlet on a circuit different from that to which the receiver is connected.
- Consult the dealer or an experienced radio/TV technician for help.

The cable with the ferrite core provided with the digital camera must be used with this equipment in order to comply with Class B limits in Subpart B of Part 15 of the FCC rules.

Do not make any changes or modifications to the equipment unless otherwise specified in the manual. If such changes or modifications should be made, you could be required to stop operation of the equipment.

Canon U.S.A. Inc.
One Canon Plaza, Lake Success, NY 11042, U.S.A.
Tel No. (516)328-5600

Index

A

AC Adapter Kit	26, 166
Access lamp.....	29
Accessories.....	166
Add original decision data	157
Adobe RGB.....	67
AE	84
AE lock.....	95, 160
AEB.....	93
AF mode	74
AF point.....	77
AF-assist beam	152
AI Focus AF	76
AI Servo AF.....	75
Aperture value.....	88
Attaching the Strap.....	21
Auto play	112
Auto playback	112
Auto power off.....	30, 39
Auto reset.....	71
Auto rotate	105
Automatic AF point selection	77
Av.....	88

B

Battery.....	22, 24, 166
Battery Charger.....	18
Battery check	24
Beeper	99
Bracket sequence	153
Bubble Jet Direct.....	133
Bulb exposures	96
Bundled Items	3

C

C.Fn	151
Camera setting display	72
Center-weighted Average Metering.....	81
CF card	11, 28, 120, 167
Clear all camera settings	37

Clear all Custom Functions	150
Clear settings	36
Color saturation	55
Color space	67
Color temperature	63
Color tone.....	55
Communication	123
Compression rate	50
Continuous	70
Continuous shooting.....	82
Contrast.....	55
CP Direct	130
Custom Functions	151
Custom WB	62

D

DC coupler	26
Depth-of-field preview	89
Dioptric Adjustment	44
Direct printing	121, 145
DPOF	139
Drive modes	82

E

Easy Printing	138
Erase	118
Erasing a single image	118
Erasing all images	119
Error Codes	165
E-TTL II autofocus.....	155
Evaluative metering.....	81
Exposure compensation.....	92
Exposure level increments	152
EX-series Speedlite	100
Extension.....	50, 71
Eyepiece cover.....	21, 98

F

Faithful.....	53
FE lock	100

FEB.....	100
File No.	70
Filter effects	57
Firmware.....	36
Flash.....	100, 102
Flash exposure compensation.....	100
Flash sync speed.....	151
Focus confirmation light.....	17
Focus lock.....	79
Focus mode switch	74, 80
Folder.....	68
Format	120
FP flash.....	100
Full Auto.....	46

H

Highlight alert.....	108
High-speed sync	100
Histogram	109
Holding the Camera.....	44

I

Image processing	51
Image review time.....	104
Image-recording Quality	50
Index.....	141
Index display.....	110
INFO.	72, 107
Interface cable	3
ISO expansion	153
ISO speed.....	60

J

JPEG	50
Jump by 10 images/100 images ...	115
Jump by date	115
Jump by folder	115
Jump display.....	114

L

Landscape	53
-----------------	----

Language	38
LCD brightness	106
LCD monitor	11, 36
LCD panel	11, 16
LCD panel illumination	98
Lens	11, 27

M

M (Manual).....	90
Magnified view	111
Main Dial	20, 31
Manual AF point selection.....	77
Manual Focusing	80
Manual reset	71
Menus	33, 35, 36
Metering mode	81
MF.....	80
Mirror Lockup	97
Mode Dial	18
Monochrome	54
Multi-controller.....	20, 32

N

Neutral.....	53
Noise reduction	151
Nomenclature.....	14
Non-Canon flash units.....	102
NTSC	36, 116
Number of copies ...	128, 131, 134, 142

O

One-Shot AF	75
-------------------	----

P

P (Program).....	84
PAL.....	36, 116
Paper settings	126
Partial metering	81
PC terminal	102
PictBridge.....	126
Picture Style	53, 55, 58

- Playback 107
 Playback menu 33, 35
 Portrait 53
 Possible shots 25, 51
 Power outlet 26
 Power Switch 20, 30
 Pressing completely 30
 Pressing halfway 30
 Print ordering 139
 Print/PTP 123
 Program AE 84
 Program shift 85
 Protect 117
 Protection 117
- Q**
- Quick Control Dial 20, 32
- R**
- RAW 51
 RAW+JPEG 50
 Recharge 22
 Replacing the date/time battery 41
 Rotate 113
- S**
- Safety shift 155
 Selecting all images 144
 Selecting Individual Images 142
 Self-timer 48, 82
 Sensor cleaning 42
 Setting the date/time 40
 Set-up menu 33, 36
 Sharpness 55
 Shoot w/o card 99
 Shooting combinations 160
 Shooting Information 108
 Shooting menu 33, 35
 Shooting mode 18
 Shots remaining 25
- Shutter button 30
 Shutter curtain synchronization 155
 Shutter speed 86
 Single image display 107
 Single shooting 82
 Specifications 170
 Spot metering 81
 sRGB 67
 Standard 141
 Style 130, 133
 Superimposed display 154
 System Map 168
- T**
- Timer 20
 Toning effect 57
 Trimming 136
 Tv 86
- U**
- User Defined 54
- V**
- Video cable 116
 Video OUT 116
 Viewfinder 17
- W**
- WB-BKT 65
 White balance 61
 White balance bracketing 65
 White balance correction 64
 Wireless, multi-Speedlite system ... 101

Canon

CANON INC. 30-2, Shimomaruko 3-chome, Ohta-ku, Tokyo 146-8501, Japan

U.S.A. ————— **CANON U.S.A. INC.**

For all inquiries concerning this camera, call toll free in the U.S.
1-800-OK-CANON or write to: Customer Relations, Canon U.S.A., Inc.
One Canon Plaza, Lake Success, N.Y. 11042-1198

CANADA ————— **CANON CANADA INC. HEADQUARTERS**

6390 Dixie Road, Mississauga, Ontario L5T 1P7, Canada

CANON CANADA INC. MONTREAL BRANCH

5990, Côte-de-Liesse, Montréal Québec H4T 1V7, Canada 1010

CANON CANADA INC. CALGARY OFFICE

2828, 16th Street, N.E. Calgary, Alberta T2E 7K7, Canada

For all inquiries concerning this camera, call toll free in Canada
1-800-OK-CANON

EUROPE, ————— **CANON EUROPA N.V.**

AFRICA & Bovenkerkerweg 59-61, P.O. Box 2262, 1180 EG Amstelveen, The Netherlands

MIDDLE EAST

CANON COMMUNICATION & IMAGE FRANCE S.A.

102, Avenue du Général de Gaulle 92257 La Garenne-Colombes Cedex, France

CANON UK LTD.

Woodhatch Reigate Surrey RH2 8BF, United Kingdom

CANON DEUTSCHLAND GmbH

Europark Fichtenhain A10, 47807 Krefeld, Germany

CANON ITALIA S.p.A.

Via Milano 8 I-20097 San Donato Milanese, Milano, Italy

CANON Schweiz AG

Geschäftsbereich Wiederverkauf, Industriestrasse 12, CH-8305 Dietlikon, Switzerland

CANON G. m. b. H.

Oberlaaerstrasse 233, 4th floor, 1100 Wien, Austria

CANON España, S. A.

C/Joaquín Costa, 41, 28002 Madrid, Spain

SEQUE Soc. Nac. de Equip., Lda.,

Praça da Alegria, 58, 2º, 1269-149 Lisboa, Portugal

CENTRAL & ————— **CANON LATIN AMERICA, INC. DEPTO DE VENTAS**

SOUTH AMERICA

703 Waterford Way Suite 400 Miami, FL 33126 U.S.A.

CANON LATIN AMERICA, INC. CENTRO DE SERVICIO Y REPARACION

Apartado 2019, Zona Libre de Colón, República de Panamá

ASIA ————— **CANON HONGKONG CO., LTD.**

19/F., The Metropolis Tower, 10 Metropolis Drive, Hunghom, Kowloon, Hong Kong

CANON SINGAPORE PTE. LTD.

1 HarbourFront Avenue #04-01 Keppel Bay Tower Singapore 098632

OCEANIA ————— **CANON AUSTRALIA PTY. LTD.**

1 Thomas Holt Drive, North Ryde, N.S.W. 2113, Australia

CANON NEW ZEALAND LTD.

Akoranga Business Park, Akoranga Drive, Northcote, Auckland, New Zealand

JAPAN ————— **CANON SALES CO., INC.**

16-6, Kohnan 2-chome, Minato-ku, Tokyo 108-8011, Japan

This Instruction Manual booklet is current as of August 2005. For information on the camera's compatibility with any accessories and lenses introduced after this date, contact any Canon Service Center.

Free Manuals Download Website

<http://myh66.com>

<http://usermanuals.us>

<http://www.somanuals.com>

<http://www.4manuals.cc>

<http://www.manual-lib.com>

<http://www.404manual.com>

<http://www.luxmanual.com>

<http://aubethermostatmanual.com>

Golf course search by state

<http://golfingnear.com>

Email search by domain

<http://emailbydomain.com>

Auto manuals search

<http://auto.somanuals.com>

TV manuals search

<http://tv.somanuals.com>