

Canon

EOS 40D

DIGITAL



Exif Print

DPOF

PictBridge

HI-SPEED
CERTIFIED
USB

E

INSTRUCTION
MANUAL

Thank you for purchasing a Canon product.

The EOS 40D is a high-performance, digital SLR camera featuring a fine-detail CMOS sensor with 10.10 effective megapixels, DIGIC III, high-precision and high-speed 9-point AF (all cross-type points), and high-speed 6.5 fps continuous shooting.

The camera is highly responsive to any shooting situation at anytime, provides many features for demanding shoots, and expands shooting possibilities with system accessories.

It also incorporates a Self Cleaning Sensor Unit called the EOS Integrated Cleaning System to remove dust on the sensor.

Take a few test shots to familiarize yourself with the camera

With a digital camera, you can immediately view the image you have captured. While reading this manual, take a few test shots and see how they come out. You can then better understand the camera.

To avoid botched pictures and accidents, read the Safety Warnings (p.10,11) and Handling Precautions (p.12,13).

Test the Camera Before Using and Liability

After shooting, playback and check whether the image has been properly recorded.

If the camera or CF card is faulty and the images cannot be recorded or downloaded to the personal computer, Canon cannot be held liable for any loss or inconvenience caused.

Copyrights

Copyright laws in your country may prohibit the use of your recorded images of people and certain subjects for anything but private enjoyment. Also be aware that certain public performances, exhibitions, etc., may prohibit photography even for private enjoyment.

Item Check List

Before starting, check that all the following items have been included with your camera. If anything is missing, contact your dealer. The accessories included can also be checked on the System Map (p.178).

Camera: EOS 40D

(includes eyecup, body cap, and installed battery for the date/time clock)

Lens: EF-S18-55mm f/3.5-5.6 IS or EF-S17-85mm f/4-5.6 IS USM

* Lens kit only.

* The lens included in the lens kit may differ from the above. The respective lens instruction manual will be included.

Power source: Battery Pack BP-511A (with protective cover)

Charger: Battery Charger CG-580/CB-5L

* CG-580 or CB-5L is included.

Power cord * For CB-5L.

2 cables

Interface Cable IFC-200U

Video Cable VC-100

Strap: EW-100DGR (with eyepiece cover)

2 CD-ROMs

EOS DIGITAL Solution Disk (bundled software)

Software Instruction Manual (PDF)

Pocket Guide

Quick start guide to shooting.

EOS 40D Instruction Manual (this booklet)

CD-ROM Guide

Guide to the bundled software and Software Instruction Manual.

Camera Warranty Card







Lens Warranty Card *Lens kit only.

* Be careful not to lose any of the above items.

* **No CF card (for recording images) is included.** Please purchase it separately.

Conventions Used in this Manual

Icons in this Manual

-  indicates the Main Dial.
-  indicates the Quick Control Dial.
-  indicates the Multi-controller.
-  indicates the SET button.
- 4, 6 or 16 indicates that the respective function remains active for 4 sec., 6 sec., or 16 sec. respectively after you let go of the button.
- In this manual, the icons and markings indicating the camera's buttons, dials, and settings correspond to the icons and markings on the camera and on the LCD monitor.
- The **<MENU>** icon indicates a function which can be changed by pressing the **<MENU>** button and changing the setting.
- The ★ icon on the upper right of the page indicates that the function is available only in the Creative Zone modes (p.20).
- For more information, reference page numbers are provided in parentheses (p.**).
- In this manual, "camera is ready to shoot" (shooting-ready) refers to the condition where the camera is turned on and no menu or image is displayed on the LCD monitor. The camera can thereby shoot immediately.

About the ? Symbols

 : Tip or advice for better shooting.

 : Problem-solving advice.

 : Warning to prevent shooting problems.

 : Supplemental information.

Basic Assumptions

- All operations explained in this manual assume that the power switch is already set to **<ON>** or **<↗>**. (p.32)
- **<⊙>** operations explained in this manual assume that the power switch is already set to **<↗>**.
- It is assumed that all the menu settings and Custom Functions are set to the default.
- For explanatory purposes, the instructions show the camera attached with an EF-S17-85mm f/4-5.6 IS USM lens.

Contents

Introduction

Item Check List	3
Conventions Used in this Manual.....	4
Index to Features	8
Handling Precautions	12
Quick Start Guide.....	14
Nomenclature.....	16

1 Getting Started 23

Recharging the Battery	24
Installing and Removing the Battery	26
Installing and Removing the CF Card	28
Mounting and Detaching a Lens	30
Basic Operation.....	32
Menu Operations.....	36
Menu Settings	38
Before You Start.....	41
Setting the Interface Language	41
Setting the Date and Time	41
Set the power-off time/Auto power off	42
Formatting the CF Card	42
Resetting Camera Settings	44

2 Basic Shooting 45

Fully Automatic Shooting	46
Full Auto Techniques	48
Shooting Portraits.....	49
Shooting Landscapes.....	50
Shooting Close-ups	51
Shooting Moving Subjects.....	52
Shooting Portraits at Night	53
Disabling Flash.....	54

3 Image Settings 55

Setting the Image-recording Quality	56
Setting the ISO Speed	59
Selecting a Picture Style	61
Customizing the Picture Style	63
Registering the Picture Style.....	65
Setting the White Balance	67
Custom White Balance	68
Setting the Color Temperature	69
White Balance Correction	70
File Numbering Methods	72
Setting the Color Space	74

4	Setting the AF and Drive Modes	75
	Selecting the AF Mode	76
	Selecting the AF Point	78
	When Autofocus Fails	80
	Manual Focusing	80
	Selecting the Drive Mode	81
	Self-timer Operation	82
5	Advanced Operations	83
	Program AE	84
	Shutter-Priority AE	86
	Aperture-Priority AE	88
	Depth-of-Field Preview	89
	Manual Exposure	90
	Automatic Depth-of-Field AE	91
	Selecting the Metering Mode	92
	Setting Exposure Compensation	93
	Auto Exposure Bracketing (AEB)	94
	AE Lock	95
	Bulb Exposures	96
	Mirror Lockup	98
	Using the Built-in Flash	99
	Flash Control	103
	External Speedlites	105
6	Live View Shooting	107
	Live View Shooting	108
7	Image Playback	115
	Image Playback	116
	Shooting Information Display	117
	Index Display/Jump Display	119
	Magnified View	120
	Rotating an Image	120
	Auto Playback	121
	Viewing the Images on TV	122
	Protecting Images	123
	Erasing Images	124
	Changing Image Playback Settings	125
	Setting the LCD Monitor Brightness	125
	Setting the Image Review Time	125
	Auto Rotate of Vertical Images	126

8	Sensor Cleaning	127	
	Automatic Sensor Cleaning	128	
	Appending Dust Delete Data	129	1
	Manual Sensor Cleaning	131	
9	Direct Printing from the Camera/Digital Print Order Format	133	
	Preparing to Print	134	2
	Printing	136	
	Trimming the Image	141	
	Digital Print Order Format (DPOF)	143	3
	Direct Printing with DPOF	146	
10	Transferring Images to a Personal Computer	147	
	Transferring Images to a Personal Computer	148	4
11	Customizing the Camera	151	
	Setting Custom Functions	152	5
	Custom Functions	153	
	Custom Function Settings	154	
	C.Fn I: Exposure	154	
	C.Fn II: Image	156	6
	C.Fn III: Auto focus/Drive	157	
	C.Fn IV: Operation/Others	160	
	Registering My Menu	164	7
	Register Camera User Settings	165	
12	Reference	167	
	Checking Camera Settings	168	8
	Using a Household Power Outlet	170	
	Replacing the Date/Time Battery	171	
	Function Availability Table	172	9
	Troubleshooting Guide	174	
	Error Codes	177	
	System Map	178	
	Using the Battery Grip	180	10
	Specifications	181	
	Index	192	11
			12

Index to Features

Power

- **Battery**
 - Charging → p.24
 - Battery check → p.26
- **Power outlet** → p.170
- **Auto power off** → p.42

Menus & Basic Settings

- **Menus** → p.38
- **Camera setting display** → p.168
- **LCD brightness adjustment** → p.125
- **Language** → p.41
- **Date/Time** → p.41
- **Beeper** → p.38
- **Shoot w/o card** → p.38

Recording Images

- **CF card formatting** → p.42
- **File No.** → p.72

Image Quality

- **Image-recording quality** → p.56
- **ISO speed** → p.59
 - ISO speed increments → p.154
- **Picture Style** → p.61
- **Color space** → p.74
- **Custom Functions for image quality**
 - Noise reduction for long exposures → p.156
 - Noise reduction for high ISO → p.156
 - Highlight tone priority → p.157

White balance

- **White balance selection** → p.67
- **Custom WB** → p.68
- **Color temperature setting** → p.69
- **White balance correction** → p.70
- **WB bracketing** → p.71

AF

- **AF mode** → p.76
- **AF point selection** → p.78
- **Manual focusing** → p.80

Metering

- **Metering mode** → p.92

Drive

- **Drive modes** → p.81
- **Maximum burst** → p.57
- **Mirror lockup** → p.98
- **Self-timer** → p.82

Shooting

- **Program AE** → p.84
- **Shutter-priority AE** → p.86
 - Safety shift → p.155
- **Aperture-priority AE** → p.88
- **Manual exposure** → p.90
- **Bulb** → p.96

Exposure adjustment

- Exposure compensation → p.93
- AEB → p.94
- AE lock → p.95
- Exposure level increments → p.154

Flash

- Built-in flash → p.99
- External flash → p.105
- External flash control
 - Flash settings → p.103
 - Flash Custom Functions → p.104

Live View shooting

- Live View shooting → p.108
 - Grid → p.112
 - Silent shooting → p.113
 - AF → p.114
 - Exposure simulation → p.163

Image playback

- Image review time → p.125
- Single image playback → p.116
 - Shooting information display → p.117
 - Highlight alert → p.117
 - AF point display → p.117
- Index display → p.119
- Magnified view → p.120
- Image browsing (Jump display) → p.119
- Image Rotate → p.120

- Auto rotate of vertical images → p.126
- Image protect → p.123
- Image erase → p.124
- Video OUT → p.122

Camera Direct Printing/DPOF

- PictBridge → p.133
- Print Order (DPOF) → p.143
- Image transfer → p.148
 - Transfer order → p.150

Customization

- Custom Function (C.Fn) → p.151
- My Menu → p.164
- Camera user setting registration → p.165

**Sensor cleaning/
Dust reduction**

- Sensor cleaning
 - Clean now → p.128
 - Disable auto cleaning → p.128
 - Manual cleaning → p.131
- Add Dust Delete Data → p.129

Viewfinder

- Dioptic adjustment → p.35
- Changing the focusing screen → p.162

Safety Warnings

Follow these safeguards and use the equipment properly to prevent injury, death, and material damage.

Preventing Serious Injury or Death

- To prevent fire, excessive heat, chemical leakage, and explosions, follow the safeguards below:
 - Do not use any batteries, power sources, and accessories not specified in this booklet. Do not use any home-made or modified batteries.
 - Do not short-circuit, disassemble, or modify the battery pack or back-up battery. Do not apply heat or apply solder to the battery pack or back-up battery. Do not expose the battery pack or back-up battery to fire or water. And do not subject the battery pack or back-up battery to strong physical shock.
 - Do not install the battery pack or back-up battery in reversed polarity (+ -). Do not mix new and old or different types of batteries.
 - Do not recharge the battery pack outside the allowable ambient temperature range of 0°C - 40°C (32°F - 104°F). Also, do not exceed the recharging time.
 - Do not insert any foreign metallic objects into the electrical contacts of the camera, accessories, connecting cables, etc.
- Keep the back-up battery away from children. If a child swallows the battery, consult a physician immediately. (Battery chemicals may harm the stomach and intestines.)
- When disposing of a battery pack or back-up battery, insulate the electrical contacts with tape to prevent contact with other metallic objects or batteries. This is to prevent fire or an explosion.
- If excessive heat, smoke, or fumes are emitted during battery pack recharging, immediately unplug the battery charger from the power outlet to stop the recharging and prevent a fire.
- If the battery pack or back-up battery leaks, changes color, deforms, or emits smoke or fumes, remove it immediately. Be careful not to get burned in the process.
- Prevent any battery leakage from contacting your eyes, skin, and clothing. It can cause blindness or skin problems. If the battery leakage contacts your eyes, skin, or clothing, flush the affected area with lots of clean water without rubbing it. See a physician immediately.
- During the recharging, keep the equipment away from the reach of children. The cord can accidentally choke the child or give an electrical shock.
- Do not leave any cords near a heat source. It can deform the cord or melt the insulation and cause a fire or electrical shock.
- Do not fire the flash at someone driving a car. It may cause an accident.
- Do not fire the flash near a person's eyes. It may impair the person's vision. When using flash to photograph an infant, keep at least 1 meter away.
- Before storing the camera or accessory when not in use, remove the battery pack and disconnect the power plug. This is to prevent electrical shock, heat generation, and fire.
- Do not use the equipment where there is flammable gas. This is to prevent an explosion or fire.

-
- If you drop the equipment and the casing breaks open to expose the internal parts, do not touch the internal parts due to the possibility of electrical shock.
 - Do not disassemble or modify the equipment. High-voltage internal parts can cause electrical shock.
 - Do not look at the sun or an extremely bright light source through the camera or lens. Doing so may damage your vision.
 - Keep the camera from the reach of small children. The neck strap can accidentally choke the child.
 - Do not store the equipment in dusty or humid places. This is to prevent fire and electrical shock.
 - Before using the camera inside an airplane or hospital, check if it is allowed. Electromagnetic waves emitted by the camera may interfere with the plane's instruments or the hospital's medical equipment.
 - To prevent fire and electrical shock, follow the safeguards below:
 - Always insert the power plug all the way in.
 - Do not handle a power plug with wet hands.
 - When unplugging a power plug, grasp and pull the plug instead of the cord.
 - Do not scratch, cut, or excessively bend the cord or put a heavy object on the cord. Also do not twist or tie the cords.
 - Do not connect too many power plugs to the same power outlet.
 - Do not use a cord whose insulation has been damaged.
 - Occasionally unplug the power plug and use a dry cloth to clean off the dust around the power outlet. If the surrounding is dusty, humid, or oily, the dust on the power outlet may become moist and short-circuit the outlet to cause a fire.
-

Preventing Injury or Equipment Damage

- Do not leave equipment inside a car under the hot sun or near a heat source. The equipment may become hot and cause skin burns.
 - Do not carry the camera around while it is attached to a tripod. Doing so may cause injury. Also make sure the tripod is sturdy enough to support the camera and lens.
 - Do not leave a lens or lens-attached camera under the sun without the lens cap attached. Otherwise, the lens may concentrate the sun's rays and cause a fire.
 - Do not cover or wrap the battery-recharging apparatus with a cloth. Doing so may trap heat within and cause the casing to deform or catch fire.
 - If you drop the camera in water or if water or metal fragments enter inside the camera, promptly remove the battery pack and back-up battery. This is to prevent fire and electrical shock.
 - Do not use or leave the battery pack or back-up battery in a hot environment. Doing so may cause battery leakage or a shorter battery life. The battery pack or back-up battery can also become hot and cause skin burns.
 - Do not use paint thinner, benzene, or other organic solvents to clean the equipment. Doing so may cause fire or a health hazard.
-

If the product does not work properly or requires repair, contact your dealer or your nearest Canon Service Center.

Handling Precautions

Camera Care

- This camera is a precision instrument. Do not drop it or subject it to physical shock.
- The camera is not waterproof and cannot be used underwater. If you accidentally drop the camera into water, promptly consult your nearest Canon Service Center. Wipe off any water droplets with a dry cloth. If the camera has been exposed to salty air, wipe with a well-wrung wet cloth.
- Never leave the camera near anything having a strong magnetic field such as a magnet or electric motor. Also avoid using or leaving the camera near anything emitting strong radio waves such as a large antenna. Strong magnetic fields can cause camera misoperation or destroy image data.
- Do not leave the camera in excessive heat such as in a car in direct sunlight. High temperatures can cause the camera to malfunction.
- The camera contains precision electronic circuitry. Never attempt to disassemble the camera yourself.
- Use a blower to blow away dust on the lens, viewfinder, reflex mirror, and focusing screen. Do not use cleaners that contain organic solvents to clean the camera body or lens. For stubborn dirt, take the camera to the nearest Canon Service Center.
- Do not touch the camera's electrical contacts with your fingers. This is to prevent the contacts from corroding. Corroded contacts can cause camera misoperation.
- If the camera is suddenly brought in from the cold into a warm room, condensation may form on the camera and internal parts. To prevent condensation, first put the camera in a sealed plastic bag and let it adjust to the warmer temperature before taking it out of the bag.
- If condensation forms on the camera, do not use the camera. This is to avoid damaging the camera. If there is condensation, remove the lens, CF card and battery from the camera, and wait until the condensation has evaporated before using the camera.
- If the camera will not be used for an extended period, remove the battery and store the camera in a cool, dry, well-ventilated location. Even while the camera is in storage, press the shutter button a few times once in a while to check that the camera is still working.
- Avoid storing the camera where there are corrosive chemicals such as a darkroom or chemical lab.
- If the camera has not been used for an extended period, test all its functions before using the camera. If you have not used the camera for some time or if there is an important shoot coming up, have the camera checked by your Canon dealer or check the camera yourself and make sure it is working properly.

LCD Panel and LCD Monitor

- Although the LCD monitor is manufactured with very high precision technology with over 99.99% effective pixels, there might be a few dead pixels among the remaining 0.01% or less pixels. Dead pixels displaying only black or red, etc., are not a malfunction. They do not affect the images recorded.
- If the LCD monitor is left on for a prolonged period, screen burn-in may occur where you see remnants of what was displayed. However, this is only temporarily and will disappear when the camera is left unused for a few days.

CF Card

- The CF card is a precision device. Do not drop the CF card or subject it to vibration. Doing so could damage the images recorded on them.
- Do not store or use the CF card near anything having a strong magnetic field such as a TV set, speakers, or magnet. Also avoid places prone to having static electricity. Otherwise, the images recorded on the CF card might be lost.
- Do not leave the CF card in direct sunlight or near a heat source. Doing so can warp the cards and make them unusable.
- Do not spill any liquid onto the CF card.
- Always store your CF cards in a case to protect the data stored on them.
- Do not bend the card or subject it to any excessive force or physical shock.
- Do not store the CF card in hot, dusty, or humid locations.

Lens Electrical Contacts

After detaching the lens from the camera, attach the lens caps or put down the lens with the rear end up to avoid scratching the lens surface and electrical contacts.

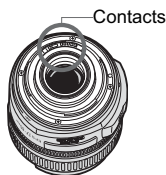

Cautions for Prolonged Use

When you shoot continuously for a prolonged period or use Live View shooting for a long period, the camera may become hot. Although this is not a malfunction, holding the hot camera for a long period can cause slight skin burns.

Quick Start Guide

1

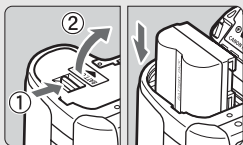

Insert the battery. (p.26)

To recharge the battery, see page 24.

2

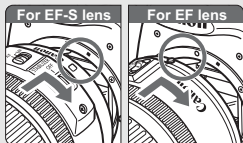

Attach the lens. (p.30)

When attaching an EF-S lens, align it with the white index on the camera.

For other lenses, align it with the red index.

3

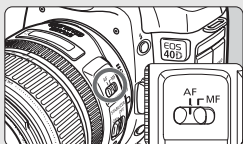

Set the lens focus mode switch to <AF>. (p.30)

4

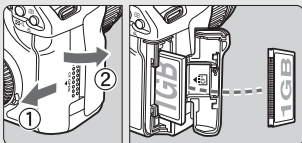

Open the CF card slot cover and insert a CF card. (p.28)

Face the label side toward you and insert the end with the small holes into the camera.

5

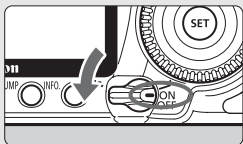

Set the power switch to <ON>. (p.32)

6



Set the Mode Dial to <□> (Full Auto). (p.46)

All the necessary camera settings will be set automatically.

7



Focus the subject. (p.32)

Look through the viewfinder and aim the viewfinder center over the subject. Press the shutter button halfway, and the camera will focus the subject.

8

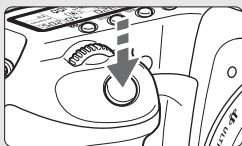

Take the picture. (p.32)

Press the shutter button completely to take the picture.

9



Review the picture on the LCD monitor. (p.125)

The captured image will be displayed for about 2 sec. on the LCD monitor.

- To view the images captured so far, see “Image Playback” (p.116).
- To delete an image, see “Erasing Images” (p.124).

Nomenclature

For detailed information, reference page numbers are provided in parentheses (p. **).

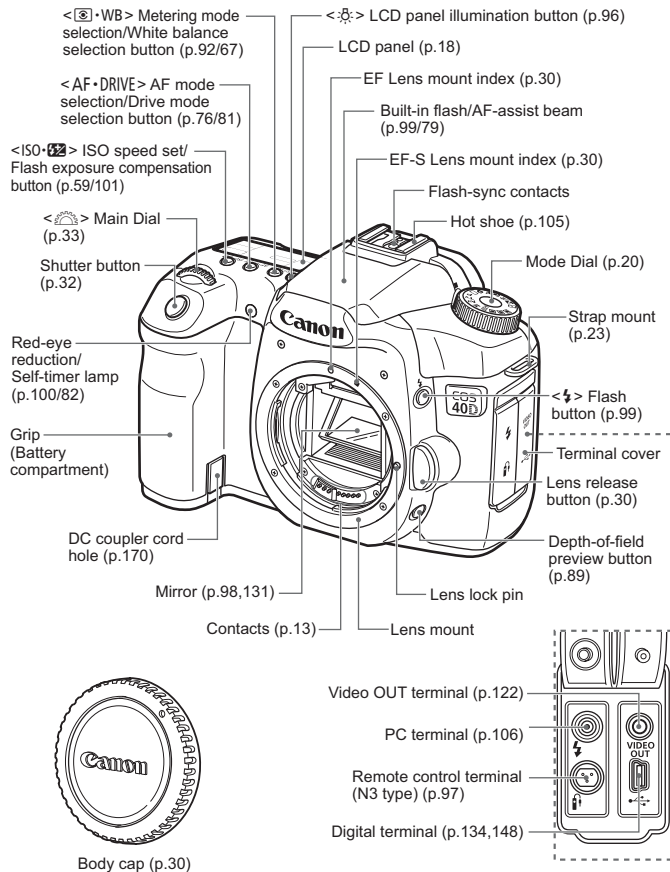

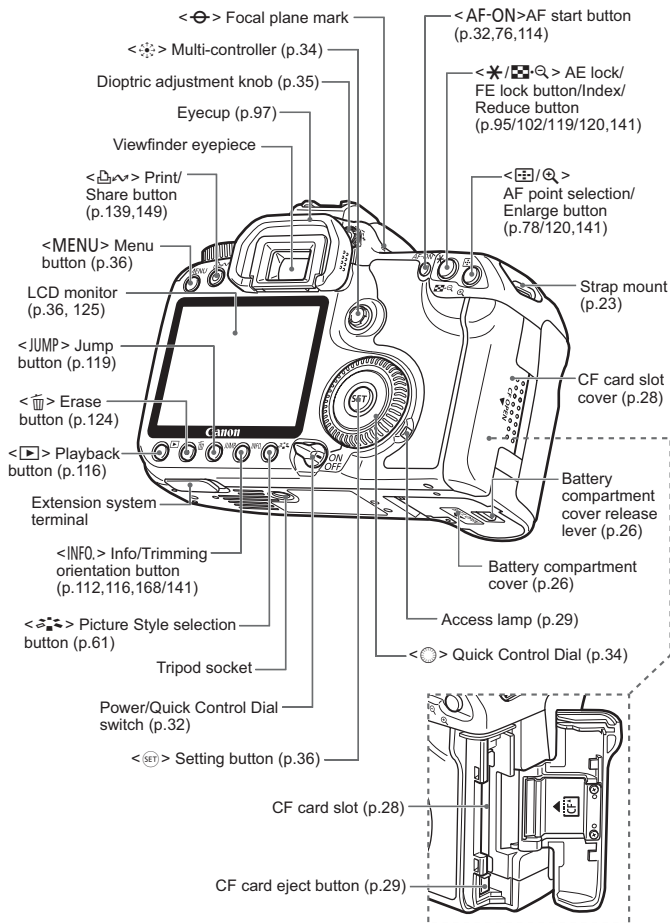

LCD Panel

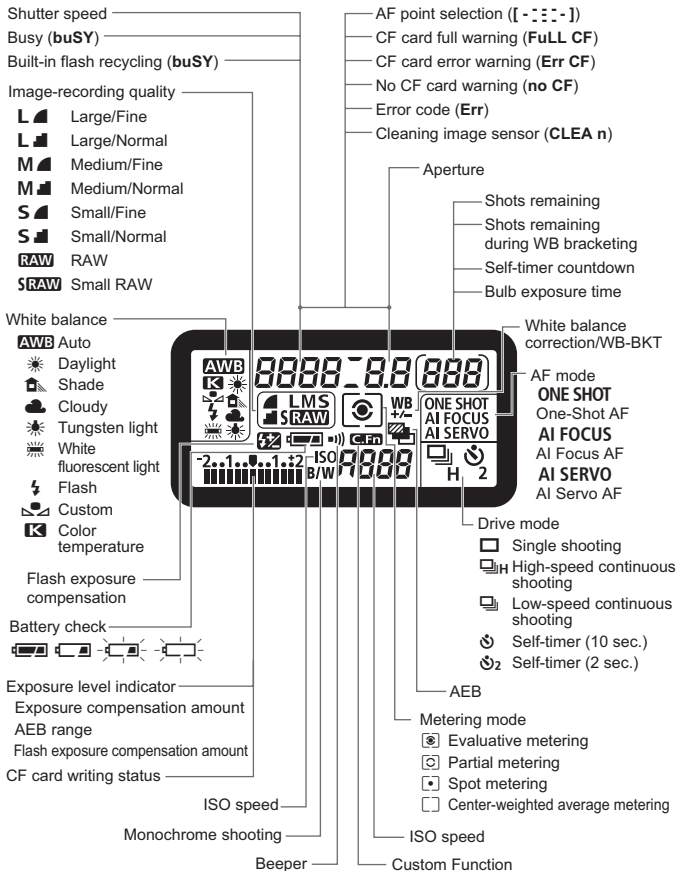

The display will show only the settings currently applicable.

Viewfinder Information

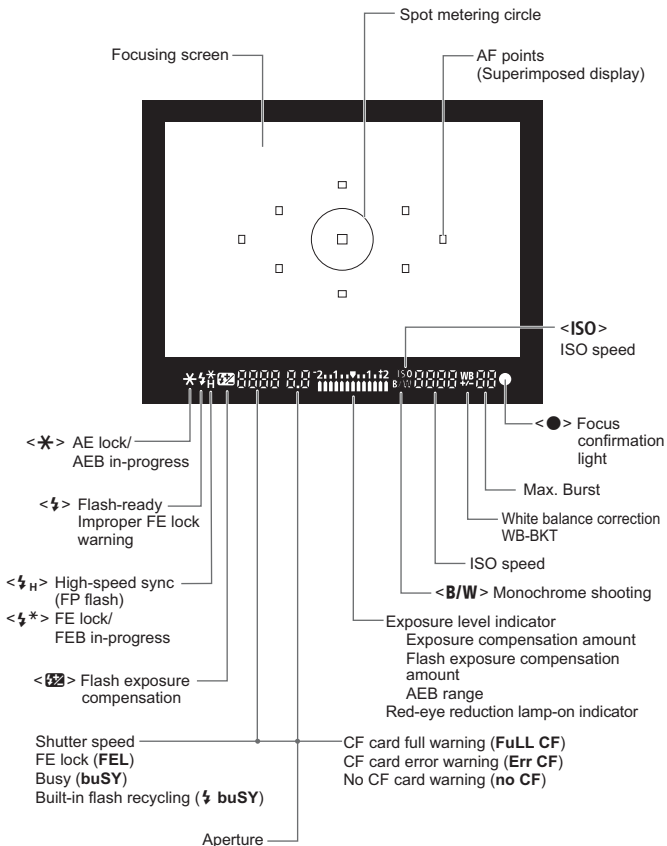



The display will show only the settings currently applicable.

Mode Dial

The Mode Dial has the Basic Zone modes and Creative Zone modes.

Camera User Settings

Most camera settings can be registered under , , or . (p.165)

Creative Zone

These modes give you more control over the result.

- P** : Program AE (p.84)
- Tv** : Shutter-priority AE (p.86)
- Av** : Aperture-priority AE (p.88)
- M** : Manual exposure (p.90)
- A-DEP** : Automatic depth-of-field AE (p.91)







Full Auto

Basic Zone

All you do is press the shutter button. Fully automatic shooting for specific kinds of subjects.

 : Full Auto (p.46)

Image Zone

-  : Portrait (p.49)
-  : Landscape (p.50)
-  : Close-up (p.51)
-  : Sports (p.52)
-  : Night Portrait (p.53)
-  : Flash Off (p.54)

EF-S18-55mm f/3.5-5.6 IS lens

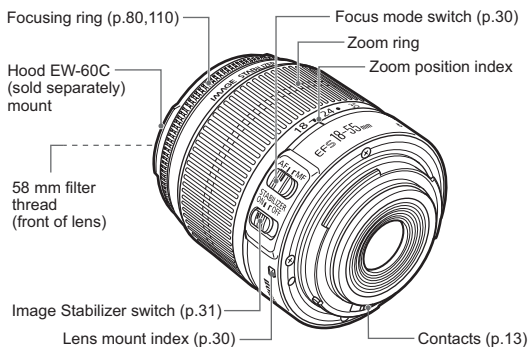

EF-S17-85mm f/4-5.6 IS USM lens

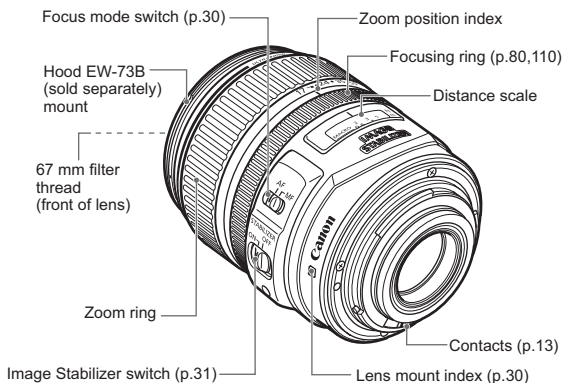

Battery Charger CG-580

This is a battery pack charger. (p.24)

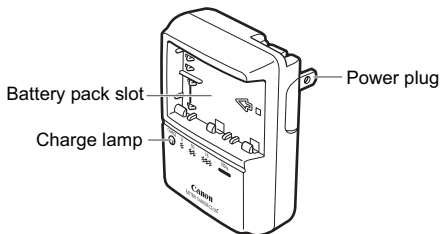

This power unit is intended to be correctly orientated in a vertical or floor mount position.

**IMPORTANT SAFETY INSTRUCTIONS-SAVE THESE INSTRUCTIONS.
DANGER-TO REDUCE THE RISK OF FIRE OR ELECTRIC SHOCK,
CAREFULLY FOLLOW THESE INSTRUCTIONS.**

For connection to a supply not in the U.S.A., use an attachment plug adapter of the proper configuration for the power outlet.

Battery Charger CB-5L

This is a battery pack charger. (p.24)

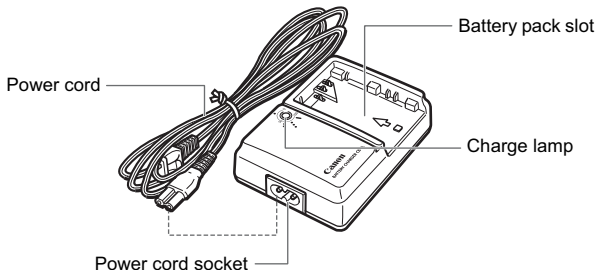

1

Getting Started

This chapter explains preliminary steps and basic camera operations.

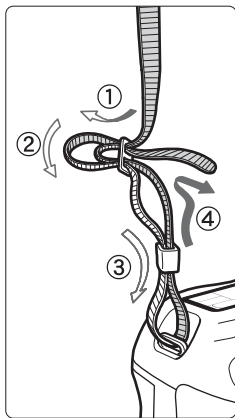

Attaching the Strap

Pass the end of the strap through the camera's strap mount eyelet from the bottom. Then pass it through the strap's buckle as shown in the illustration. Pull the strap to take up any slack and make sure the strap will not loosen from the buckle.

- The eyepiece cover is also attached to the strap. (p.97)

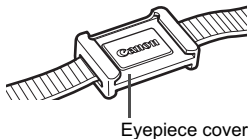

Recharging the Battery

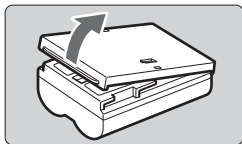

1 Remove the cover.

- When you remove the battery from the camera, be sure to reattach the cover to protect against short circuiting.

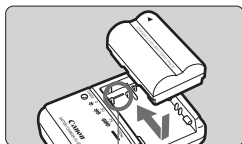

2 Attach the battery.

- Align the battery's front edge with the battery charger's index line. While pressing down the battery, slide it in the direction of the arrow.
- To detach the battery, follow the above procedure in reverse.

Battery pack slot index

CG-580

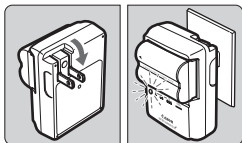

3 Recharge the battery.

For CG-580

- As shown by the arrow, flip out the battery charger's prongs and insert the prongs into a power outlet.

For CB-5L

CB-5L

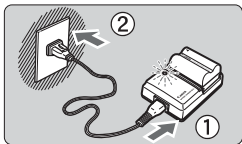

- Connect the power cord to the charger and insert the plug into the power outlet.
- ▶ Recharging starts automatically and the charge lamp starts blinking in red.
- ▶ **The recharging time for a completely exhausted battery is as follows:**
BP-511A and BP-514: Approx. 100 min.
BP-511 and BP-512: Approx. 90 min.
The time required to recharge the battery depends on the ambient temperature and battery's charge level.

- The numbers and markings on the battery charger correspond to the table on the left.

Recharge Level	Charge Lamp
0 - 50%	Blinks once per second
50 - 75%	Blinks twice per second
75 - 90%	Blinks three times per second
90% or higher	Lights on



Tips for Using the Battery and Charger

- **Recharge the battery on the day before or on the day it is to be used.**
A charged battery unused will still gradually lose its power over time.
- **After recharging the battery, detach it and unplug the charger from the power outlet.**

- **You can attach the cover in a different orientation to indicate whether the battery has been recharged or not.**

If the battery has been recharged, attach the cover so that the battery-shaped hole <  > is aligned over the blue seal on the battery. If the battery is exhausted, attach the cover in the opposite orientation.

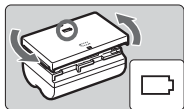

- **Use the battery in an ambient temperature range of 0°C - 40°C / 32°F - 104°F.**

To attain best battery performance, an ambient temperature of 10°C - 30°C / 50°F - 86°F is recommended. In cold locations such as snowy areas, battery performance and operation time may temporarily decrease.

- **When not using the camera, remove the battery.**

If the battery is left in the camera for a prolonged period, a small amount of power current is released, resulting in excess discharge and shorter battery life. Take out the battery from the camera and attach the protective cover before storing. Storing the battery after it is fully charged can lower the battery's performance.

- **The battery charger can also be used in foreign countries.**

The battery charger is compatible with a 100 V AC to 240 V AC 50/60 Hz power source. Use a commercially-available plug adapter for that country. Do not attach any portable voltage transformer to the battery charger. Doing so can damage the battery charger.

- **If the battery becomes exhausted quickly even after being fully charged, replace the battery.**

Replace the battery with a new one.



- Do not recharge any battery pack other than Battery Pack BP-511A, BP-514, BP-511, or BP-512.
- Battery Packs BP-511A, BP-514, BP-511, and BP-512 are dedicated to Canon products. Using it with a non-Canon battery charger or product may result in malfunction or accidents for which Canon cannot be held liable.

Installing and Removing the Battery

Installing the Battery

Load a fully charged BP-511A battery pack into the camera.

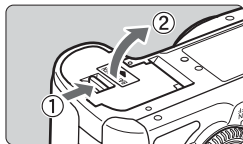

1 Open the battery compartment cover.

- Slide the lever as shown by the arrow and open the cover.

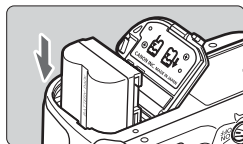

2 Insert the battery.

- Point the battery contacts downward.
- Insert the battery until it locks in place.

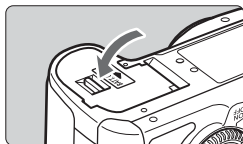

3 Close the cover.

- Press the cover until it snaps shut.

 Battery Pack BP-514, BP-511, or BP-512 can also be used.

Checking the Battery Level

When the power switch is set to **<ON>** or **<L>** (p.32), the battery level will be indicated in one of four levels:



 : Battery level OK.

 : Battery level is low.

 : Battery will be exhausted soon.

 : Battery must be recharged.

Battery Life

[Number of shots • approx.]

Temperature	Shooting Conditions	
	No Flash	50% Flash Use
At 23°C / 73°F	1100	800
At 0°C / 32°F	950	700

- The figures above are based on a fully-charged BP-511A, no Live View shooting, and CIPA (Camera & Imaging Products Association) testing standards.

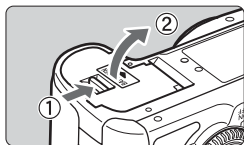

- The actual number of shots may be fewer than indicated above depending on the shooting conditions.
- The number of possible shots will decrease with more frequent use of the LCD monitor.
- Pressing the shutter button halfway for long periods or operating only the autofocus can also reduce the number of possible shots.
- The number of possible shots with the BP-514 is the same as indicated in the table.
- The number of possible shots with the BP-511 or BP-512 will be about 75% of the figures in the table for 23°C / 73°F. At 0°C / 32°F, the figures will be about the same as in the table.
- The lens operation is powered by the camera's battery. Using certain lenses can reduce the number of possible shots.
- For battery life with Live View shooting, see page 112.

Removing the Battery**1 Open the battery compartment cover.**

- Slide the lever as shown by the arrow and open the cover.

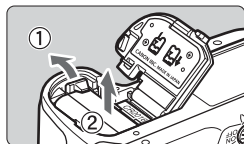
**2 Remove the battery.**

- Press the battery lock lever as shown by the arrow and remove the battery.
- To prevent shorting, be sure to attach the protective cover to the battery.

Installing and Removing the CF Card

The captured image is recorded onto the CF card (sold separately). Although the thickness is different between the Type I and Type II CF cards, either one can be inserted into the camera. The camera is also compatible with Microdrive (hard disk-type) and CF cards with 2 GB or higher capacity.

Installing a Card

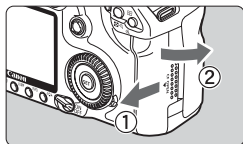

1 Open the cover.

- Slide the cover as shown by the arrow to open it.

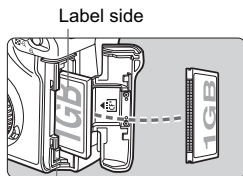

Label side

2 Insert the CF card.

- As shown in the illustration, face the label side toward you and insert the end with the small holes into the camera.

Inserting the CF card in the wrong way may damage the camera.

- ▶ The CF card eject button will stick out.

CF card eject button

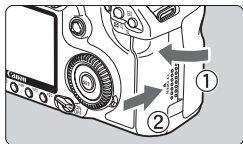

3 Close the cover.

- Close the cover and slide it in the direction shown by the arrow until it snaps shut.
- ▶ When you set the power switch to <ON> or <↗>, the number of remaining shots will be displayed on the LCD panel.

Shots remaining



The shots remaining depends on the remaining capacity of the CF card, image-recording quality, ISO speed, etc.

Removing the Card

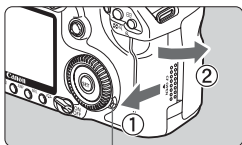

Access lamp

1 Open the cover.

- Set the power switch to <OFF>.
- **Make sure the access lamp is off, then open the cover.**

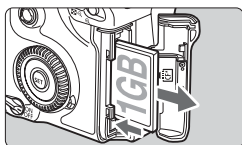

2 Remove the CF card.

- Press the CF card eject button.
- ▶ The CF card will come out.
- Close the cover.



- **When the access lamp is lit or blinking, it indicates that the images are being written to or read by the CF card, being erased, or data is being transferred. While the access lamp is lit or blinking, never do any of the following. Doing so may damage the image data. It may also damage the CF card or camera.**
 - **Shaking or banging the camera around.**
 - **Opening the CF card slot cover.**
 - **Removing the battery.**
- If the CF card already contains recorded images, the file number might not start from 0001. (p.72)
- If "Err CF" (Error CF) is displayed on the LCD panel, see page 43.
- When holding a hard disk-type card, always hold its sides. You may damage the card by holding its flat surfaces.
- Compared to CF cards, hard disk-type CF cards are more vulnerable to vibration and physical shock. If you use a such a card, be careful not to subject the camera to vibration or physical shock especially while recording or displaying images.



On the menu, if you set [**Shoot w/o card**] to [**Off**], it will prevent shooting without a CF card.

Mounting and Detaching a Lens

Mounting a Lens

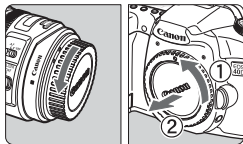

1 Remove the caps.

- Remove the rear lens cap and the body cap by turning them as shown by the arrow.

EF-S lens mount index

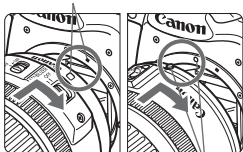

EF lens mount index

2 Attach the lens.

- Align the EF-S lens with the camera's white EF-S lens mount index and turn the lens as shown by the arrow until it clicks in place.
- When attaching a lens other than an EF-S lens, align the lens with the red EF lens mount index.

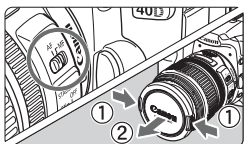

3 On the lens, set the focus mode switch to <AF>.

- If it is set to <MF>, autofocus will not be possible.

4 Remove the front lens cap.

Detaching the Lens

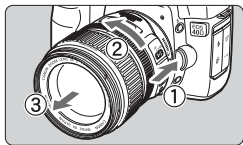

While pressing the lens release button, turn the lens as shown by the arrow.

- Turn the lens until it stops, then detach it.

! When attaching or detaching the lens, take care to prevent dust from entering the camera through the lens mount.

About the Image Stabilizer Lenses

If an Image Stabilizer (IS) lens is attached and the lens IS switch is set to <ON>, the Image Stabilizer will operate when you press the shutter button halfway. When the image in the viewfinder looks steady, take the picture.

- For bulb exposures, set the IS switch to <OFF>. If it is set to <ON>, the Image Stabilizer may malfunction.
- The Image Stabilizer continues to operate for about 2 sec. after you let go of the shutter button. Do not detach the lens during this time. Doing so may cause a malfunction.
- Using the Image Stabilizer will decrease the number of possible shots (shorter battery life).

Manual Focusing Subjects at Infinity

To manual focus a subject at infinity, look through the viewfinder. If you just turn the focusing ring all the way to infinity, it might not attain proper focus.

- Do not look at the sun through any lens. Doing so may cause loss of vision.



Image Conversion Factor

Since the image size is smaller than the 35mm film format, it will look like the lens focal length is increased by 1.6x.

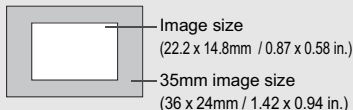

Basic Operation

Power/Quick Control Dial Switch



<OFF> : The camera is turned off and does not operate. Position for when you do not use the camera.

<ON> : The camera operates.

<↵> : The camera and <☉> operate. (p.34)



- Whenever you set the power switch to <ON/↵> or <OFF>, the sensor cleaning will be executed automatically. During the sensor cleaning, the LCD monitor will display a logo.
- To save battery power, the camera turns off automatically after about 1 minute of non-operation. To turn on the camera again, just press the shutter button.
- You can change the auto power-off time with the menu's [**If** Auto power off] setting. (p.42)
- If you set the power switch to <OFF> while the image is being recorded to the CF card, [**Recording ...**] will be displayed and the power will turn off after the CF card finishes recording the image.

Shutter Button

The shutter button has two steps. You can press the shutter button halfway. Then you can further press the shutter button completely.



Pressing halfway (☉)

This activates autofocus and automatic exposure that sets the shutter speed and aperture.

The exposure setting will be displayed on the LCD panel and in the viewfinder.

In the Creative Zone modes, pressing the <AF-ON> button will be the same as pressing the shutter button halfway.

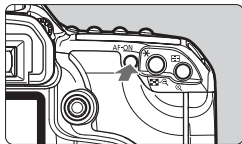

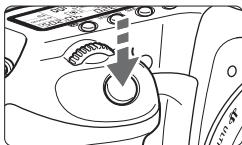

Pressing completely

This releases the shutter and takes the picture.



- If you press the shutter button completely without pressing it halfway first or if you press the shutter button halfway and then press it completely immediately, the camera will take a moment before it takes the picture.
- Even during the menu display, image playback, and image recording, you can instantly go back to shooting-ready by pressing the shutter button halfway.

< > Using the Main Dial for Selecting

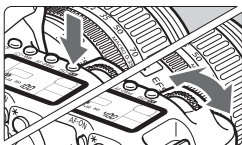

- (1) **After pressing a button, turn the <  > dial.**

When you press a button, its function remains selected for 6 seconds (⌚6).

During this time, you can turn the <  > dial to set the desired setting.

When the function turns off or if you press the shutter button halfway, the camera will be ready to shoot.

- In this way, you can set the metering mode, AF mode, ISO speed, and select the AF point.



- (2) **Turn the <  > dial only.**

While looking at the viewfinder or LCD panel, turn the <  > dial to set the desired setting.

- In this way, you can set the shutter speed, aperture, etc.

<☉> Using the Quick Control Dial for Selecting

Before using the <☉> dial, set the power switch to <↙>.

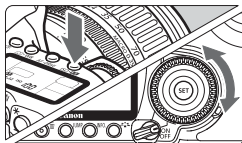

(1) After pressing a button, turn the <☉> dial.

When you press a button, its function remains selected for 6 seconds (⌚6).

During this time, you can turn the <☉> dial to set the desired setting.

When the function turns off or if you press the shutter button halfway, the camera will be ready to shoot.

- Use this dial to select or set the white balance, drive mode, flash exposure compensation, and AF point.

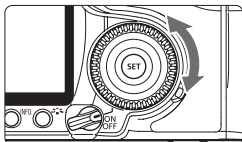

(2) Turn the <☉> dial only.

While looking at the viewfinder or LCD panel, turn the <☉> dial to set the desired setting.

- Use this dial to set the exposure compensation amount, the aperture setting for manual exposures, and other settings.

 You can also operate (1) when the power switch is set to <ON>.

<☼> Operating the Multi-controller

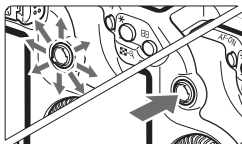

The <☼> consists of eight direction keys and a button at the center.

- Use it to select the AF point, correct the white balance, select the focusing frame during Live View shooting, or scroll the image during magnified view. You can also use it to select menus. (Except [Erase images] and [Format].)

Adjusting the Viewfinder Clarity

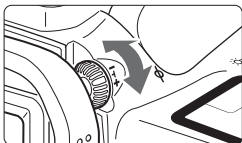

Turn the dioptic adjustment knob.

- Turn the knob left or right so that the AF points in the viewfinder look sharp.



If the camera's dioptic adjustment still cannot provide a sharp viewfinder image, using Dioptic Adjustment Lens E (10 types, sold separately) is recommended.

Holding the Camera

To obtain sharp images, hold the camera still to minimize camera shake.





Horizontal shooting



Vertical shooting



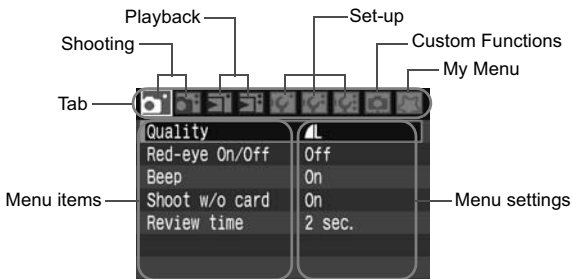
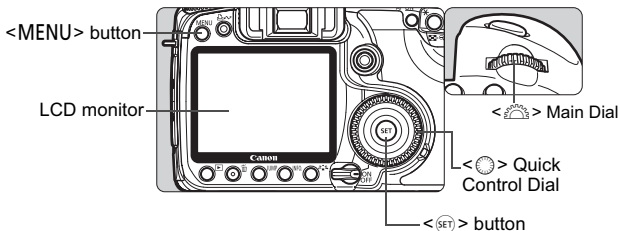

1. Wrap your right hand around the camera grip firmly.
2. Hold the lens bottom with your left hand.
3. Press the shutter button lightly with your right hand's index finger.
4. Press your arms and elbows lightly against the front of your body.
5. Press the camera against your face and look through the viewfinder.
6. To maintain a stable stance, place one foot in front of the other.

Menu Operations

By setting various optional settings with the menus, you can set the image-recording quality, Picture Style, the date/time, Custom Functions, etc. While looking at the LCD monitor, you use the <MENU> button on the camera back and the <  > <  > dials.



* The , , , and  tabs are not displayed in Basic Zone modes such as Full Auto.

Icon	Color	Category	Description
	Red	Shooting menu	Shooting-related items
	Blue	Playback menu	Image playback-related items
	Yellow	Set-up menu	Camera's function settings
	Orange	Camera's Custom Functions	
	Green	Register frequently-used menu items and Custom Functions	

Menu Setting Procedure

1 Display the menu.

- Press the <MENU> button to display the menu.

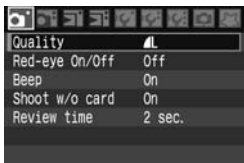

2 Select a tab.

- Turn the <☀> dial to select a tab.

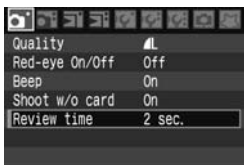

3 Select a menu item.

- Turn the <☀> dial to select the menu item, then press <SET>.

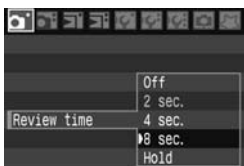

4 Select the setting.

- Turn the <☀> dial to select the desired setting.

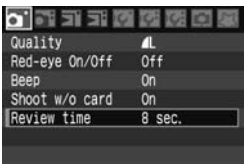

5 Set the desired setting.

- Press <SET> to set it.

6 Exit the menu.

- Press the <MENU> button to exit the menu and return to camera shooting.

Menu Settings

Shooting 1 (Red)

Page

Quality	/ / / / / / / RAW / RAW + (/ / / / / RAW + (/ / / / /	56
Red-eye On/Off	Off / On	100
Beep	On / Off	–
Shoot w/o card	On / Off	29
Review time	Off / 2 sec. / 4 sec. / 8 sec. / Hold	125

Shooting 2 (Red)

AEB	1/3-stop increments, ± 2 stops	94
White balance	/ / / / / / / / / (2500 - 10000)	67
Custom WB	Manual setting of white balance	68
WB SHIFT/BKT	WB correction: White balance correction WB-BKT: White balance bracketing	70 71
Color space	sRGB / Adobe RGB	74
Picture Style	Standard / Portrait / Landscape / Neutral / Faithful / Monochrome / User Def. 1, 2, 3	61-66
Dust Delete Data	Obtains data to be used to erase dust spots	129

Playback 1 (Blue)



Protect images	Erase-protect image	123
Rotate	Rotate vertical image	120
Erase images	Erase image	124
Print order	Specifies images to be printed (DPOF)	143
Transfer order	Select images to be transferred to a personal computer	150
External media backup	Displayed when external media is used via WFT-E3/E3A (sold separately)	–

Playback 2 (Blue)

Page

Highlight alert	Disabled / Enable	117
AF point disp.	Disabled / Enable	117
Histogram	Brightness / RGB	118
Auto play	Auto playback of images	121

Set-up 1 (Yellow)

Auto power off	1min. / 2 min. / 4 min. / 8 min. / 15 min. / 30 min. / Off	42
File numbering	Continuous / Auto reset / Manual reset	72
Auto rotate	On  / On  / Off	126
INFO button	Normal disp. / Camera set. / Shoot. func.	168
Format	Initialize and erase data in the card	42
WFT settings	Displayed when WFT-E3/E3A (sold separately) is attached	–
Recording func.+media select	Displayed when external media is used via WFT-E3/E3A (sold separately)	–

Set-up 2 (Yellow)

LCD brightness	Seven brightness levels provided	125
Date/Time	Set the date (year, month, day) and time (hour, min., sec.)	41
Language	18 languages	41
Video system	NTSC / PAL	122
Sensor cleaning	Auto cleaning / Clean now / Clean manually	127
Live View function settings	[Live View shoot.] Disable / Enable	108
	[Grid display] Off / On	112
	[Silent shoot.] Mode 1 / Mode 2 / Disable	113
	[Metering timer] 4 sec. / 16 sec. / 30 sec. / 1 min. / 10 min. / 30 min.	109
Flash control	Flash firing / Built-in flash func. setting / External flash func. setting / External flash C.Fn setting / Clear ext. flash C.Fn set.	103

[F:] Set-up 3 (Yellow)

Page

Camera user setting	Register current camera settings to the Mode Dial's <[1]>, <[2]>, or <[3]> position	165
Clear all camera settings	Resets the camera to the default settings	44
Firmware Ver.	For updating the firmware	–

[C.] Custom Functions (Orange)

C.Fn I: Exposure	Customize the camera as desired	154
C.Fn II: Image		156
C.Fn III: Auto focus/Drive		157
C.Fn IV: Operation/Others		160
Clear all Custom Func. (C.Fn)	Clears all Custom Function settings	152

[M:] My Menu (Green)

My Menu settings	Register frequently-used menu items and Custom Functions	164
-------------------------	--	-----



- The [Shooting 2], [F:] Set-up 3, [C.] Custom Functions, and [M:] My Menu screens (tabs) are not displayed in Basic Zone modes.
- Shaded menu items are not displayed in Basic Zone modes.
- In Basic Zone modes, the RAW, sRAW, RAW/sRAW+JPEG recording quality modes are not displayed.
- Pressing the <JUMP> button will select another tab. The first item under the tab will be selected.
- Even while the menu is displayed, you can instantly go back to shooting by pressing the shutter button halfway.
- The explanation of menu functions hereinafter assumes that you have pressed the <MENU> button to display the menu screen.
- You can register frequently-used menu items under My Menu [M:]. (p.164)

Before You Start

MENU Setting the Interface Language



1 Select [Language].

- Under the [**IF**] tab, select [**Language**] (the third item from the top), then press <SET>.



2 Set the desired language.

- Turn the <⊙> dial to select the language, then press <SET>.
- ▶ The language will change.

MENU Setting the Date and Time

Check if the camera's date and time are set correctly. If necessary, set the correct date and time.





1 Select [Date/Time].

- Under the [**IF**] tab, select [**Date/Time**], then press <SET>.



2 Set the date, time, and date display format.

- Turn the <⊙> dial to select the number.
- Press <SET> so  is displayed.
- Turn the <⊙> dial to select the desired setting, then press <SET>. (Returns to .)

3 Exit the menu.

- Turn the <⊙> dial to select [**OK**], then press <SET>.
- ▶ The date/time will be set and the menu will reappear.



It is important to set the correct date/time because it will be recorded together with each captured image.

MENU Set the power-off time/Auto power off

You can change this auto power-off time for the camera to turn off automatically after a certain period of non-operation. If you do not want the camera to turn off automatically, set this to [Off]. After the power turns off, you can turn on the camera again by pressing the shutter button or other button.



- 1 **Select [Auto power off].**
 - Under the [P] tab, select [Auto power off], then press <SET>.
- 2 **Set the desired time.**
 - Turn the <DIAL> dial to select the item, then press <SET>.

 Even if [Off] has been set, the LCD monitor will turn off automatically after 30 min. to save power. (The camera's power does not turn off.)

MENU Formatting the CF Card

If the CF card is new or was previously formatted by another camera or personal computer, format the card with the camera.

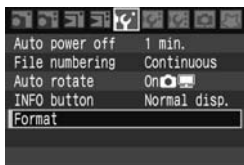

-  **When the CF card is formatted, all images and data in the card will be erased. Even protected images will be erased, so make sure there is nothing you need to keep. If necessary, transfer the images to a personal computer, etc., before formatting the card.**

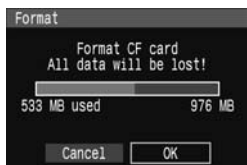

- 1 **Select [Format].**
 - Under the [P] tab, select [Format], then press <SET>.



2 Select [OK].

- Turn the <  > dial to select [OK], then press <  >.
- ▶ The CF card will be formatted (initialized).
- ▶ When the formatting is completed, the menu will reappear.



- When the CF card is formatted or erased, only the file management information is changed. The actual data is not completely erased. Be aware of this when selling or discarding the card.
- When discarding the CF card, destroy the card physically to prevent personal data from being leaked.
- If a CF card-related error message is displayed on the LCD monitor, remove and reinstall the card.

If the error persists, use a different card. Or, if you can transfer all the images in the card to a personal computer, transfer all the images and then format the card. The card may then return to normal.



The CF card capacity displayed on the card format screen might be smaller than the capacity indicated on the card.

MENU Resetting Camera Settings ★

The camera's shooting settings and menu settings can be reset to the default settings.

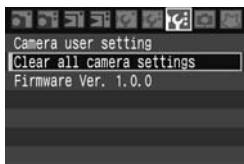

1 Select [Clear all camera settings].

- Under the [Fn:] tab, select [Clear all camera settings], then press <SET>.



2 Select [OK].

- Turn the <DISP> dial to select [OK], then press <SET>.
- ▶ When [Clear all camera settings] is set, the camera will be reset to the following settings.

Shooting Settings

AF mode	One-Shot AF
AF point selection	Automatic selection
Metering mode	(Evaluative metering)
Drive mode	(Single shooting)
Exposure compensation	0 (Zero)
AEB	Canceled
Flash exposure compensation	0 (Zero)

Image-Recording Settings

Quality	
ISO speed	Auto
Color space	sRGB
White balance	(Auto WB)
WB correction	Canceled
WB bracketing	Canceled
Picture Style	Standard



- The [Custom Functions] and [Camera user setting] will not be cleared.
- The white balance data (p.68) obtained from the custom white balance and the Dust Delete Data (p.129) will be erased.

2

Basic Shooting

This chapter explains how to use the Basic Zone modes on the Mode Dial for best results.

With the Basic Zone modes, all you do is point and shoot and the camera sets everything automatically. (p.172) Also, to prevent botched pictures due to mistaken operations, camera settings cannot be changed in the Basic Zone modes.

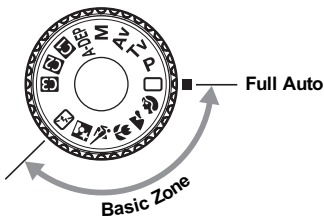

Automatic image correction in Basic Zone modes

In Basic Zone modes, the image is adjusted automatically to obtain the best brightness.

☐ Fully Automatic Shooting

1 Set the Mode Dial to <☐>.

AF point

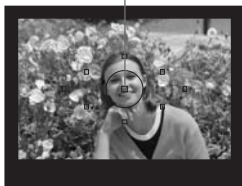

2 Aim any AF point over the subject.

- All the AF points will operate, and focus will generally be achieved at the AF point covering the closest object.
- Aiming the center AF point over the subject will make focusing easier.



3 Focus the subject.

- Press the shutter button halfway, and the lens will move to focus.
- ▶ The AF point which achieves focus will briefly flash in red. At the same time, the beeper will sound and the focus confirmation light <●> in the viewfinder will light.
- ▶ If necessary, the built-in flash will pop-up automatically.



Focus confirmation light

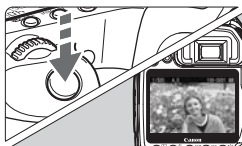

4 Take the picture.

- Press the shutter button completely to take the picture.
- ▶ The captured image will be displayed for about 2 sec. on the LCD monitor.
- If the built-in flash has popped up, push it back down with your fingers.

FAQ

- **The focus confirmation light <●> blinks and focus is not achieved.**
Aim the AF point over an area having good contrast between light and dark, then press the shutter button halfway. (p.80) If you are too close to the subject, move away and try again.
- **Sometimes multiple AF points flash simultaneously.**
This indicates that focus has been achieved at all those AF points. As long as the AF point covering the desired subject flashes, you can take the picture.
- **The beeper continues to beep softly. (The focus confirmation light <●> also does not light.)**
It indicates that the camera is focusing continuously on a moving subject. (The focus confirmation light <●> does not light.) While the beeper is beeping, you can press the shutter button completely to shoot a moving subject in focus.
- **Pressing the shutter button halfway will not focus the subject.**
When the focus mode switch on the lens is set to <MF> (Manual Focus), the camera does not focus. Set the focus mode switch to <AF>.
- **When I focus the subject and then zoom up and take the picture, the focus looks soft.**
If you want to zoom, do it before focusing. Turning the zoom ring after achieving focus may throw off the focus slightly.
- **Although it is daylight, the flash popped up.**
For a backlit subject, the flash may pop up to help reduce harsh shadows on the subject.
- **In low light, the built-in flash fired a series of flashes.**
To assist the autofocusing, pressing the shutter button halfway may trigger the built-in flash to fire a series of flashes. This is called AF-assist beam. It is effective up to approx. 4 meters/13.1 feet away.
- **Although flash was used, the picture came out dark.**
The subject was too far away. The subject should be within 5 meters/16.4 feet from the camera.
- **When flash was used, the bottom part of the picture came out unnaturally dark.**
The subject was too close to the camera, and a shadow was created by the lens. The subject should be at least 1 meter/3.3 feet away from the camera. If a hood (sold separately) has been attached to the lens, remove it before taking the flash picture.

☐ Full Auto Techniques

Recomposing the Shot



Depending on the scene, position the subject toward the left or right to create a balanced background and good perspective.



In the <☐> (Full Auto) mode, while you press the shutter button halfway to focus a still subject, the focus will be locked. You can then recompose the shot and press the shutter button completely to take the picture. This is called focus lock. Focus lock is also possible in other Basic Zone modes (except <🔍>).

Shooting a Moving Subject



In the <☐> (Full Auto) mode, if the subject moves (distance to camera changes) during or after you focus, AI Servo AF will take effect to focus the subject continuously. As long as you keep aiming the AF point on the subject while pressing the shutter button halfway, the focusing will be continuous. When you want to take the picture, press the shutter button completely.

Shooting Portraits

The <> (Portrait) mode blurs the background to make the human subject stand out. It also makes flesh tones and the hair look softer than with the <> (Full Auto) mode.



Shooting Tips

- **The further the distance between the subject and background, the better.**



The further the distance between the subject and background, the more blurred the background will look. The subject will also stand out better in front of a plain, dark background.

- **Use a telephoto lens.**
If you have a zoom lens, use the telephoto end to fill the frame with the subject from the waist up. Move in closer if necessary.
- **Focus the face.**
Check that the AF point covering the face flashes in red.



- If you hold down the shutter button, you can shoot continuously to obtain different poses and facial expressions. (Approx. 3 shots/sec.)
- If necessary, the built-in flash will pop-up automatically.

Shooting Landscapes

Use the <  > (Landscape) mode for wide scenery, night scenes, and to have everything in focus from near to far. The greens and blues also become more vivid and sharp than with <  > (Full Auto).



Shooting Tips

- **With a zoom lens, use the wide-angle end.**

When using a zoom lens, use the wide-angle end. This will have objects near and far in focus, better than at the telephoto end. It also adds breadth to landscapes.

- **Shooting night scenes.**

Since the built-in flash will be disabled, this mode is also good for night scenes. For night scenes, use a tripod to prevent camera shake. If you want to photograph a person against a night scene, set the Mode Dial to <  > and use a tripod. (p.53)





Shooting Close-ups

When you want to photograph flowers or small things up close, use the <  > (Close-up) mode. To make small things appear much larger, use a macro lens (sold separately).



Shooting Tips

- **Use a simple background.**
A simple background makes the flower, etc., stand out better.
- **Move to the subject as close as possible.**
Check the lens for its minimum focusing distance. Some lenses have indications such as <  **0.28m/0.9ft** >. The lens minimum focusing distance is measured from the <  > (focal plane) mark on the camera to the subject. If you are too close to the subject, the focus confirmation light <  > will blink.
Under low light, the built-in flash will fire. If you are too close to the subject and the bottom of the picture looks dark, move away from the subject.
- **With a zoom lens, use the telephoto end.**
If you have a zoom lens, using the telephoto end will make the subject look larger.

Shooting Moving Subjects

To photograph a moving subject whether it be a child running or an auto race, use the (Sports) mode.



Shooting Tips

- **Use a telephoto lens.**

Using a telephoto lens is recommended so you can shoot from afar.

- **Use the center AF point to focus.**

Aim the center AF point over the subject, then press the shutter button halfway to auto focus. During autofocusing, the beeper will continue beeping softly. If focus cannot be achieved, the focus confirmation light will blink.

When you want to take the picture, press the shutter button completely. While holding down the shutter button, continuous shooting (max. approx. 6.5 shots per sec.) and autofocusing will take effect.



 Under low light when camera shake is prone to occur, the viewfinder's shutter speed display on the bottom left will blink. Hold the camera steady and shoot.

Shooting Portraits at Night

To shoot someone at night and obtain a natural-looking exposure in the background, use the  (Night Portrait) mode.



Shooting Tips

- **Use a wide-angle lens and a tripod.**
If you use a zoom lens, set it to the wide-angle end to obtain a wide night view. Use a tripod to prevent camera shake.
- **Keep the person within 5 meters/16.4 feet from the camera.**
Under low light, the built-in flash will fire automatically to obtain a good exposure of the person. The effective distance of the built-in flash is 5 meters/16.4 feet from the camera.
- **Shoot also with  (Full Auto).**
Since camera shake is prone to occur with night shots, shooting also with  (Full Auto) is recommended.



If the self-timer is also used, the self-timer lamp will flash after the picture is taken.

Disabling Flash

In places where flash photography is prohibited, use the <> (Flash Off) mode. This mode is also effective for candlelight scenes when you want to obtain the candlelight effect.



Shooting Tips

- **If the numeric display in the viewfinder blinks, take care to prevent camera shake.**

Under low light when camera shake is prone to occur, the viewfinder's shutter speed display will blink. Hold the camera steady or use a tripod. If you have a zoom lens, use the wide-angle end to reduce blur due to camera shake.

- **Taking portraits without flash.**

Under low light, the person must not move until the picture is taken. If the person moves during the exposure, he or she might look blurred in the picture.

3

Image Settings

This chapter explains the digital image settings for the image-recording quality, ISO speed, Picture Style, white balance, and color space.

- In the Basic Zone modes, only the image-recording quality (except RAW/sRAW, RAW/sRAW+JPEG) and the file numbering method can be set as explained in this chapter.
- The asterisk ★ on the right of the page title indicates that the respective feature is available only in Creative Zone modes (**P**, **Tv**, **Av**, **M**, **A-DEP**).



When the camera is ready to shoot, you can press the <INFO.> button to see the image settings. (p.168)

MENU Setting the Image-recording Quality

Set the image-recording quality to suit the intended image size for printing, etc. In the Basic Zone modes, only the following image-recording quality settings can be set: **L**, **L**, **M**, **M**, **S**, **S**. They are all JPEG images. In the **RAW/SRAW** modes, the image will require processing with the software provided. (p.58)

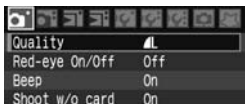

1 Select [Quality].

- Under the [Q] tab, select [Quality], then press <SET>.
- ▶ The image-recording quality screen will appear.

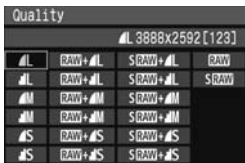

2 Select the image-recording quality.

- Turn the <DIAL> dial to select the image-recording quality, then press <SET>.
- On the upper right, the **** x **** number indicates the recorded pixel count, and [***] is the shots remaining (displayed up to 999).
- Set the image-recording quality in both the Basic Zone and Creative Zone modes respectively.

Guide to Image-recording Quality Settings

Quality		Pixels	Print Size
L (Large/Fine)	JPEG	Approx. 10.1 megapixels	A3 or larger
L (Large/Normal)			
M (Medium/Fine)			
M (Medium/Normal)		Approx. 5.3 megapixels	A4 - A5
S (Small/Fine)		Approx. 2.5 megapixels	A5 or smaller
S (Small/Normal)			
RAW (RAW)	Approx. 10.1 megapixels	A3 or larger	
SRAW (Small RAW)	Approx. 2.5 megapixels	A5 or smaller	

With **RAW + L**, **SRAW + L**, and other RAW+JPEG simultaneous recordings, both the RAW and JPEG images will be saved in the same folder under the same file No.

Image File Size and CF Card Capacity According to Image-Recording Quality

Quality	File Size (Approx. MB)	Possible Shots (Approx.)	Maximum Burst (Approx.)	
			High-speed	Low-speed
L	3.5	274	75	205
L	1.8	523	171	523
M	2.1	454	140	454
M	1.1	854	303	854
S	1.2	779	271	779
S	0.7	1451	625	1451
RAW	12.4	76	17	20
RAW + L	12.4 + 3.5	59	14	16
RAW + L	12.4 + 1.8	66	14	16
RAW + M	12.4 + 2.1	65	14	16
RAW + M	12.4 + 1.1	70	14	16
RAW + S	12.4 + 1.2	69	14	16
RAW + S	12.4 + 0.7	72	14	16
SRAW	7.1	135	20	34
SRAW + L	7.1 + 3.5	90	17	21
SRAW + L	7.1 + 1.8	107	17	22
SRAW + M	7.1 + 2.1	103	17	22
SRAW + M	7.1 + 1.1	116	17	23
SRAW + S	7.1 + 1.2	115	17	24
SRAW + S	7.1 + 0.7	124	18	25

- The number of possible shots and maximum burst apply to a 1GB CF card based on Canon's testing standards.
- The single image size, number of possible shots, and maximum burst during continuous shooting are based on Canon's testing standards (ISO 100, Picture Style: Standard).
- On the LCD panel, you can check the remaining number of images the CF card can record.
- **The single-image size, number of possible shots, and maximum burst during continuous shooting will vary depending on the subject, CF card brand, ISO speed, Picture Style, etc.**
- In the case of monochrome images, the file size will be smaller so the number of possible shots will be higher.

About RAW

The RAW image is the data output by the image sensor and converted to digital data which is recorded on the CF card as is. The RAW image is transferred to a personal computer where software (provided) is used to adjust the image as needed. From the RAW image, the software can develop and generate the adjusted image in the desired type such as JPEG or TIFF.

About sRAW

This is a small RAW image which is one-fourth (approx. 2.5 megapixels) the size of a normal RAW image. As with RAW images, sRAW images can be developed and adjusted with the provided software. This image type is handy when you do not need a very high resolution as a normal RAW image.

Maximum Burst During Continuous Shooting

The maximum burst during continuous shooting indicated on the preceding page is the number of continuous shots that can be taken at one time based with a 1 GB CF card. The maximum burst depends on the image-recording quality, drive mode, subject, CF card brand, and other variables.



It is displayed in the viewfinder on the bottom right. If the maximum burst is 99 or higher, "99" will be displayed.

- The maximum burst is displayed even when a CF card is not in the camera. Make sure that a CF card is loaded before taking a picture.
- The maximum burst for is displayed regardless of the drive mode setting.

 If the viewfinder displays "99" for the maximum burst, it means the maximum burst is 99 or higher. If 98 or lower is displayed, the maximum burst is 98 or lower. If you stop the continuous shooting, the maximum burst will increase. After all the captured images are written to the CF card, the maximum burst will be as listed on the preceding page.

ISO: Setting the ISO Speed★

Set the ISO speed (image sensor's sensitivity to light) to suit the ambient light level. For example, when you increase the ISO speed (higher number) for low light, a faster shutter speed can be used and camera shake will be less prone to occur. The effective range of the flash will also increase.

ISO Speed in the Basic Zone Modes

The ISO speed is set automatically within ISO 100 - 800.

ISO Speed in the Creative Zone Modes

ISO 100 - 1600 can be set in 1/3-stop increments. Also, the "Auto" setting will change the ISO speed automatically to suit the ambient light level.

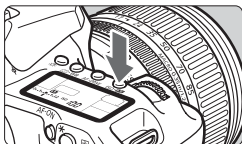

1 Press the <ISO> button. (ⓘ6)

- ▶ The current ISO speed will be displayed on the LCD panel.
- In the Basic Zone modes, "Auto" will be displayed on the LCD panel.



2 Set the ISO speed.





- While looking at the LCD panel or viewfinder, turn the <ISO> dial.
- With "Auto", the ISO speed will be set automatically.

- Using a high ISO speed or shooting in high-temperature conditions may result in more grainy images.
- High temperatures, high ISO speeds, or long exposures may cause irregular colors in the image.

With [**C.Fn I -3**] (ISO expansion) set to [1: On] (p.154), "H" (ISO 3200) can also be set.

About “Auto” ISO Speed

If the ISO speed is set to “Auto”, the actual ISO speed to be set will be displayed when you press the shutter button halfway. As indicated below, the ISO speed will be set automatically to suit the shooting mode.

Shooting Mode	ISO Speed Setting
	The ISO speed is set automatically within ISO 100 - 800. The ISO speed set automatically will vary depending on the shooting mode. The picture will be taken at the standard exposure.
	The ISO speed is set automatically within ISO 400 - 800.
	Fixed at ISO 100.
P Av A-DEP	The ISO speed will be set automatically within ISO 400 - 800 so that a shutter speed preventing camera shake will be set. If overexposure would result at ISO 400, a lower ISO speed, as low as ISO 100, will be set.
Tv	Normally, ISO 400 is set. Even for very bright or dark subjects, the ISO speed will be set automatically within ISO 100 - 800 to obtain a standard exposure.
M	Fixed at ISO 400.
With flash	Set to ISO 400 in all shooting modes including  . If overexposure would result in bright light outdoors, a lower ISO speed, as low as ISO 100, will be set.

Selecting a Picture Style ★

By selecting a Picture Style, you can obtain the desired image effects matching your photographic expression or the subject.

In the Basic Zone modes, the Picture Style is set automatically, so the operation explained on this page to page 66 cannot be done.

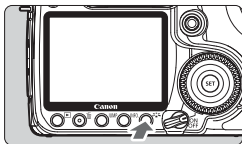



1 Press the button.

- When the camera is ready to shoot, press the  button.
- ▶ The Picture Style screen will appear.



2 Select a Picture Style.

- Turn the  dial to select a Picture Style, then press .
- ▶ The Picture Style will take effect and the camera will be ready to shoot.



You can also use the [ Picture Style] menu to select the Picture Style.

Picture Style Effects

- **Standard**
The image looks vivid and sharp.
- **Portrait**
For nice skin tones. The image looks slightly sharp.
- **Landscape**
For vivid blues and greens, and very sharp images.
- **Neutral**
For natural colors and subdued images. This Picture Style assumes that you will do post-processing with a personal computer.

Faithful

The image is dull and subdued. When the subject is captured under a color temperature of 5200K, the color is adjusted colorimetrically to match the subject's color. This Picture Style assumes that you will do post-processing with a personal computer.

Monochrome

For black-and-white images.



- To obtain natural-looking, black-and-white images, set a suitable white balance.
- The image cannot be reverted back to color except for **RAW** and **SRAW** images. Do not use this Picture Style if you want color JPEG images. When **[Monochrome]** is selected, **<B/W>** will appear in the viewfinder and on the LCD panel.

User Def. 1-3

Refer to "Registering the Picture Style" on page 65.

About the Symbols

The symbols on the upper right of the Picture Style selection screen refer to parameters such as **[Sharpness]** and **[Contrast]**. The numerals indicate the parameter settings, such as **[Sharpness]** and **[Contrast]**, for each Picture Style.



Symbols

	Sharpness
	Contrast
	Saturation
	Color tone
	Filter effect (Monochrome)
	Toning effect (Monochrome)

Customizing the Picture Style ★

You can customize the Picture Style by adjusting the individual parameters like [Sharpness] and [Contrast]. To customize [Monochrome], see the next page.



1 Press the < > button.

2 Select a Picture Style.

- Turn the < > dial to select a Picture Style, then press the <INFO.> button.

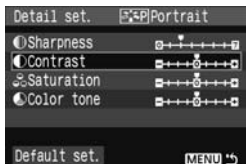

3 Select a parameter.

- Turn the < > dial to select a parameter, then press <SET >.







4 Set the parameter.

- Turn the < > dial to set the parameter as desired, then press <SET >.
- Press the <MENU> button to save the adjusted parameter. The Picture Style selection screen will reappear.
- ▶ Any settings different from the default will be displayed in blue.



Parameter Settings and Effects

 Sharpness	[0] : Less sharp outline	[+7] : Sharp outline
 Contrast	[-4] : Low contrast	[+4] : High contrast
 Saturation	[-4] : Low saturation	[+4] : High saturation
 Color tone	[-4] : Reddish skin tone	[+4] : Yellowish skin tone

- By selecting [**Default set.**] in step 3, you can revert the respective Picture Style to its default parameters.
- To shoot with the Picture Style you modified, follow step 2 on the preceding page to select the Picture Style and then shoot.

Monochrome Adjustment

For Monochrome, you can also set [**Filter effect**] and [**Toning effect**] in addition to [**Sharpness**] and [**Contrast**].

[Filter effect]

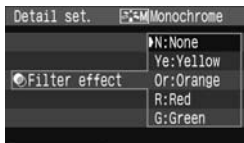

With a filter effect applied to a monochrome image, you can make white clouds or green trees stand out more.

Filter	Sample Effects
N: None	Normal black-and-white image with no filter effects.
Ye: Yellow	The blue sky will look more natural, and the white clouds will look crisper.
Or: Orange	The blue sky will look slightly darker. The sunset will look more brilliant.
R: Red	The blue sky will look quite dark. Fall leaves will look crisper and brighter.
G: Green	Skin tones and lips will look fine. Tree leaves will look crisper and brighter.

- Setting the [**Contrast**] to the plus side will make the filter effect more pronounced.

[Toning effect]

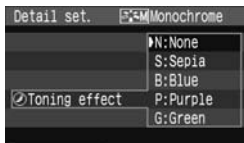

By applying a toning effect, you can create a monochrome image in that color. It can make the image look more impressive.

The following can be selected: [**N:None**] [**S:Sepia**] [**B:Blue**] [**P:Purple**] [**G:Green**].

Registering the Picture Style ★

You can select a base Picture Style such as [Portrait] or [Landscape], adjust its parameters as desired and register it under [User Def. 1], [User Def. 2], or [User Def. 3]. You can create Picture Styles whose parameters such as sharpness and contrast are different. You can also select a Picture Style already set with the provided software.

1 Press the button.



2 Select [User Def.].

- Turn the  dial to select [User Def. *], then press the <INFO.> button.



3 Press <SET>.

- With [Picture Style] selected, press <SET>.

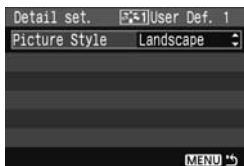

4 Select the base Picture Style.

- Turn the  dial to select the base Picture Style, then press <SET>.
- If you already have a Picture Style set with the provided software, select it here.



5 Select a parameter.

- Turn the  dial to select a parameter, then press <SET>.

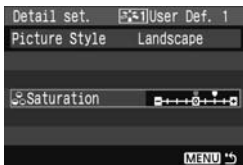

6 Set the parameter.

- Turn the <⊙> dial to set the parameter as desired, then press <SET>.
- Press the <MENU> button to register the new Picture Style. The Picture Style selection screen will then reappear.
 - ▶ The base Picture Style will be displayed on the right of [**User Def. ***].
 - ▶ The name of the Picture Style having any modified settings (different from the default) registered under [**User Def. ***] will be displayed in blue.

ⓘ If a Picture Style has already been registered under [**User Def. ***], changing the base Picture Style in step 4 will nullify the parameters of the registered contents of the Picture Style.

📄 To shoot with the registered Picture Style, follow step 2 on the preceding page to select [**User Def. ***] and then shoot.

WB: Setting the White Balance ★

White balance (WB) is for making the white areas look white. Normally, the <AWB> (Auto) setting will obtain the correct white balance. If natural-looking colors cannot be obtained with <AWB>, you can set the white balance manually to suit the respective light source. In the Basic Zone modes, <AWB> will be set automatically.

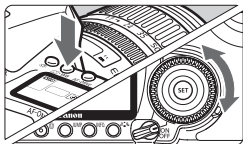

1 Press the <WB> button. (⊙)

2 Select the white balance.

- While looking at the LCD panel, turn the <⊙> dial.

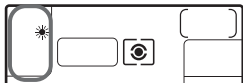

Icon	Mode	Color Temperature (Approx. K: Kelvin)
AWB	Auto	3000 - 7000
☀	Daylight	5200
🏠	Shade	7000
☁	Cloudy, twilight, sunset	6000
💡	Tungsten light	3200
💡	White fluorescent light	4000
⚡	Flash	6000
📷	Custom (p.68)	2000 - 10000
📷	Color temperature (p.69)	2500 - 10000

About White Balance

To the human eye, a white object looks white regardless of the type of lighting. With a digital camera, the color temperature is adjusted with software to make the white areas look white. This adjustment serves as the basis for the color correction. The result is natural-looking colors in the pictures.



You can also use the [☰ White balance] menu to set the white balance.

Custom White Balance

Custom white balance enables you to manually set the white balance for a specific light source for better accuracy.

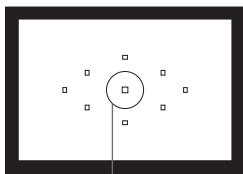



Spot metering circle

1 Photograph a white object.

- The plain, white object should fill the spot metering circle.
- Focus manually and set the standard exposure for the white object.
- You can set any white balance.





2 Select [Custom WB].

- Under the  tab, select [Custom WB], then press .
- ▶ The SET screen will appear.



3 Import the white balance data.

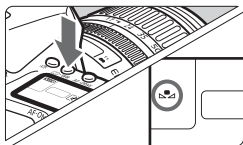

- Turn the  or  dial to select the image captured in step 1, then press .
- ▶ On the dialog screen which appears, select [OK] and the data will be imported.



4 Press the • WB > button. (06)

- After exiting the menu, press the  • WB > button.

5 Select the custom white balance.

- Look at the LCD panel and turn the  dial to select .



- If the exposure obtained in step 1 is way off, a correct white balance might not be obtained.
- If the image was captured while the Picture Style was set to **[Monochrome]** (p.62), it cannot be selected in step 3.



- Instead of a white object, an 18% gray card (commercially available) can produce a more accurate white balance.
- The personal white balance registered with the provided software will be registered under <[WB] >. If you do step 3, the data for the registered personal white balance will be erased.

[K] Setting the Color Temperature

You can numerically set the white balance's color temperature.

1 Select **[White balance]**.

- Under the **[WB]** tab, select **[White balance]**, then press <[SET]>.



2 Set the color temperature.

- Turn the <[DIAL]> dial to select **[K]**.
- Turn the <[DIAL]> dial to set the color temperature, then press <[SET]>.
- The color temperature can be set from 2500K to 10000K in 100K increments.



- When setting the color temperature for an artificial light source, set white balance correction (magenta or green) as necessary.
- If you want to set <[K]> to the reading taken with a commercially-available color temperature meter, take test shots and adjust the setting to compensate for the difference between the color temperature meter's reading and the camera's color temperature reading.

MENU White Balance Correction ★

You can correct the white balance that has been set. This adjustment will have the same effect as using a commercially-available color temperature conversion filter or color compensating filter. Each color can be corrected to one of nine levels.

Users familiar with using color temperature conversion or color compensating filters will find this feature handy.

White Balance Correction



1 Select [WB SHIFT/BKT].

- Under the [WB] tab, select [WB SHIFT/BKT], then press <SET>.

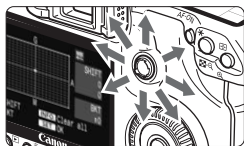

2 Set the white balance correction.

- Use <DIAL> to move the "■" mark to the desired position.
- B is for blue, A is amber, M is magenta, and G is green. The color in the respective direction will be corrected.
- On the upper right, "SHIFT" indicates the direction and correction amount.
- Pressing the <INFO> button will cancel all the [WB SHIFT/BKT] settings.
- Press <SET> to exit and return to the menu.

Sample setting : A2, G1

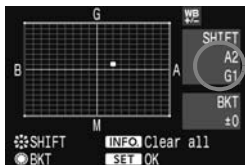

- During the white balance correction, <WB> will be displayed in the viewfinder and on the LCD panel.
- One level of the blue/amber correction is equivalent to 5 mireds of a color temperature conversion filter. (Mired: A measurement unit indicating the density of a color temperature conversion filter.)

White Balance Auto Bracketing

With just one shot, three images having a different color tone can be recorded simultaneously. Based on the color temperature of the current white balance setting, the image will be bracketed with a blue/amber bias or magenta/green bias. This is called white balance bracketing (WB-BKT). White balance bracketing is possible up to ± 3 levels in single-level increments.

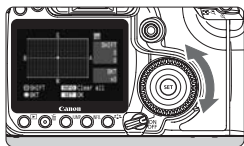

B/A bias ± 3 levels



Set the white balance bracketing amount.

- In step 2 for white balance correction, when you turn the $\langle \odot \rangle$ dial, the “■” mark on the screen will change to “■■■” (3 points). Turning the dial to the right sets the B/A bracketing, and turning it to the left sets the M/G bracketing.
- ▶ On the right side of the screen, “BKT” indicates the bracketing direction and the bracketing amount is also displayed.
- Pressing the $\langle \text{INFO} \rangle$ button will cancel all the [WB SHIFT/BKT] settings.
- Press $\langle \text{SET} \rangle$ to exit and return to the menu.

Bracketing Sequence

The images will be bracketed in the following sequence: 1. Standard white balance, 2. Blue (B) bias, and 3. Amber (A) bias, or 1. Standard white balance, 2. Magenta (M) bias, 3. Green (G) bias.



- During WB bracketing, the maximum burst for continuous shooting will be lower and the number of possible shots will also decrease to one-third the normal number. Also, the white balance icon will blink on the LCD panel.
- You can also set white balance correction and AEB together with white balance bracketing. If you set AEB in combination with white balance bracketing, a total of nine images will be recorded for a single shot.
- Since three images are recorded for one shot, the CF card will take longer to record the shot.
- “BKT” stands for Bracketing.

MENU File Numbering Methods

The file number is like the frame number on a roll of film. The captured images are assigned a sequential file number from 0001 to 9999 and saved in one folder. You can also change how the file number is assigned.

The file number will appear on the personal computer in this format:

IMG_0001.JPG.

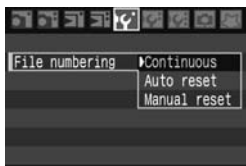

1 Select [File numbering].

- Under the [FV] tab, select [File numbering], then press <SET>.

2 Select the file numbering method.

- Turn the <DISP> dial to select the desired method, then press <SET>.

Continuous

File numbering continues even after CF card replacement

Even after you replace the CF card, the file numbering continues in sequence up to 9999. This is convenient when you want to save the images numbered anywhere between 0001 to 9999 in one folder in your personal computer.

If the replacement CF card contains images recorded previously, the file numbering of the new images might continue from the file numbering of the existing images in the card. If you want to use continuous file numbering, you should use a newly-formatted CF card each time.

File numbering after replacing the CF card

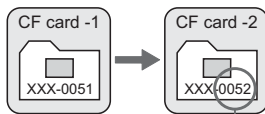

Next sequential file number

Auto Reset

Resets the file numbering to 0001 whenever the CF card is replaced

Each time the CF card is replaced, the file numbering starts from 0001. This is convenient if you want to organize images according to CF cards. If the replacement CF card contains images recorded previously, the file numbering of the new images might continue from the file numbering of the existing images in the card. To start the file numbering from 0001, the CF card must be formatted before use.

File numbering after replacing the CF card

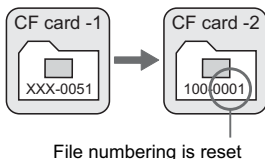

Manual Reset

The file numbering starts from 0001 in the new folder

When you reset the file numbering manually, a new folder is created automatically and the file numbering of images saved to that folder starts from 0001. This is convenient when you want to use different folders for the images taken yesterday and the ones taken today, for example. After the manual reset, the file numbering returns to continuous or auto reset.

! If folder No. 999 is created, [**Folder number full**] will appear on the LCD monitor. If that folder contains images reaching file number 9999, shooting will not be possible even if the CF card still has storage capacity. The LCD monitor will display a message to replace the CF card. Be sure to replace the CF card.

📄 For both JPEG and RAW/sRAW images, the file name will start with "IMG_". The extension will be ".JPG" for JPEG images and ".CR2" for RAW and sRAW images.

MENU Setting the Color Space ★

The color space refers to the range of reproducible colors. With this camera, you can set the color space for captured images to sRGB or Adobe RGB. For normal images, sRGB is recommended.

1 Select [Color space].

- Under the [Q] tab, select [Color space], then press <SET>.



2 Set the desired color space.

- Select [sRGB] or [Adobe RGB], then press <SET>.

About Adobe RGB

This is mainly used for commercial printing and other industrial uses. This setting is not recommended if you do not know about image processing, Adobe RGB, and Design rule for Camera File System 2.0 (Exif 2.21). Since the image will look very subdued with sRGB personal computer environment and printers not compatible with Design rule for Camera File System 2.0 (Exif 2.21), post-processing of the image with software will be required.



- If the captured image was shot in the Adobe RGB color space, the first character in the file name will be an underscore “_”.
- The ICC profile is not appended. The ICC profile is explained in the Software Instruction Manual (CD-ROM).

4

Setting the AF and Drive Modes

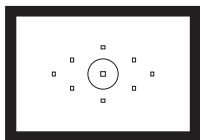

The viewfinder has 9 AF points. By selecting a suitable AF point, you can shoot with autofocus while framing the subject as desired.

You can also select the AF mode and drive mode best matching the shooting conditions and subject.

- The asterisk ★ on the right of the page title indicates that the respective feature is available only in Creative Zone modes (**P**, **Tv**, **Av**, **M**, **A-DEP**).
- In the Basic Zone modes, the AF mode, AF point selection, and drive mode are set automatically.



<AF> stands for auto focus. <MF> stands for manual focus.

AF: Selecting the AF Mode★

Select the AF mode suiting the shooting conditions or subject. In the Basic Zone modes, the optimum AF mode is set automatically.

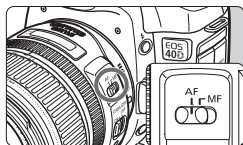

1 On the lens, set the focus mode switch to <AF>.

2 Set the Mode Dial to a Creative Zone mode.

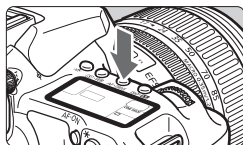

3 Press the <AF•DRIVE> button. (ⓘ6)

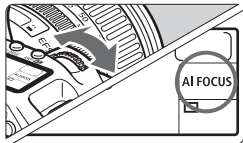

4 Select the AF mode.

- While looking at the LCD panel, turn the <☀> dial.

ONE SHOT: One-Shot AF

AI FOCUS: AI Focus AF

AI SERVO: AI Servo AF

One-Shot AF for Still Subjects

Suited for still subjects. When you press the shutter button halfway, the camera will focus only once.

- When focus is achieved, the AF point which achieved focus will flash in red, and the focus confirmation light <●> in the viewfinder will also light.
- With evaluative metering, the exposure setting will be set at the same time focus is achieved.
- While you hold down the shutter button halfway, the focus will be locked. You can then recompose the shot if desired.
- In the Creative Zone modes, AF is also possible by pressing the <AF-ON> button.



- If focus cannot be achieved, the focus confirmation light <●> in the viewfinder will blink. If this occurs, a picture cannot be taken even if the shutter button is pressed completely. Recompose the picture and try and focus again. Or see “When Autofocus Fails” (p.80).
- If the [AF Beep] menu is set to [Off], the beeper will not sound when focus is achieved.

AI Servo AF for Moving Subjects

This AF mode is for moving subjects when the focusing distance keeps changing. While you hold down the shutter button halfway, the subject will be focused continuously.

- The exposure is set at the moment the picture is taken.
- In the Creative Zone modes, AF is also possible by pressing the <AF-ON> button.
- When the AF point selection is automatic (p.78), the camera first uses the center AF point to focus. During autofocusing, if the subject moves away from the center AF point, focus tracking continues as long as the subject is covered by another AF point.



With AI Servo AF, the beeper will not sound even when focus is achieved. Also, the focus confirmation light <●> in the viewfinder will not light.

AI Focus AF for Automatic Switching of AF Mode

AI Focus AF switches the AF mode from One-Shot AF to AI Servo AF automatically if the still subject starts moving.

- After the subject is focused in the One-Shot AF mode, if the subject starts moving, the camera will detect the movement and change the AF mode automatically to AI Servo AF.



When focus is achieved in the AI Focus AF mode with the Servo mode active, the beeper will sound softly. The focus confirmation light <●> in the viewfinder will not light.

Selecting the AF Point ★

Select one of the nine AF points to autofocus. In the Basic Zone and <A-DEP> modes, automatic AF point selection will take effect automatically. You cannot select the AF point.

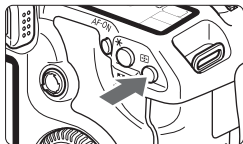

1 Press the <AF-ON> button. (⦿6)

- ▶ The selected AF point will be displayed in the viewfinder and on the LCD panel.
- If all the AF points light in the viewfinder, it means automatic AF point selection is in effect.

2 Select the AF point.

- To select an AF point, you can either turn the <MODE> or <DISP> dial or use <MULTI-CONTROLLER>.

Selecting with the Dial

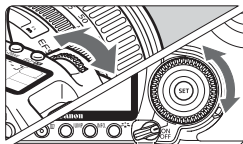

- When you turn the <MODE> or <DISP> dial, the AF point selection will change in the respective direction.
- When all AF points light up, automatic AF point selection will be set.

Selecting with the Multi-controller

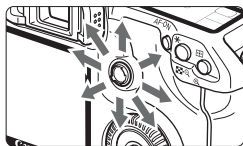

- The AF point selection will change in the direction you tilt the <MULTI-CONTROLLER>. If you keep tilting it in the same direction, it will toggle between manual and automatic AF point selection.







- When looking at the LCD panel to select the AF point, note the following:
Automatic selection [- - - -], center [-],
right [-], top [-]
- If focus cannot be achieved with the external, EOS-dedicated Speedlite's AF-assist beam, select the center AF point.

AF-Assist Beam with the Built-in Flash

Under low-light conditions, when you press the shutter button halfway, the built-in flash fires a brief burst of flashes. It illuminates the subject to enable easier autofocusing.



- In the <  > <  > <  > modes, the AF-assist beam does not fire.
- The built-in flash's AF-assist beam is effective up to about 4 meters/13.2 feet.
- In the Creative Zone modes when you pop-up the built-in flash with the <  > button, the AF-assist beam will be fired when necessary.

Lens' Maximum Aperture and AF Sensitivity

With lenses whose maximum aperture is larger than f/5.6

With all AF points, cross-type AF sensitive to both vertical and horizontal lines is possible.

With lenses whose maximum aperture is larger than f/2.8*

With the center AF point, high-precision, cross-type AF sensitive to both vertical and horizontal lines is possible. The center AF point's sensitivity to vertical and horizontal lines is about twice as sensitive as the other AF points.

The remaining eight AF points will work as cross-type points with lenses brighter than f/5.6.

* Except with the EF28-80mm f/2.8-4L USM and EF50mm f/2.5 Compact Macro lenses.

When Autofocus Fails

Autofocus can fail to achieve focus (the focus confirmation light <●> blinks) with certain subjects such as the following:

Subjects difficult to focus

- Low-contrast subjects
Example: Blue sky, solid-color walls, etc.
- Subjects in low light
- Extremely backlit and reflective subjects
Example: Car with a reflective body, etc.
- Overlapping near and far objects
Example: Animal in a cage, etc.
- Repetitive patterns
Example: Skyscraper windows, computer keyboards, etc.

In such cases, do one of the following:

- (1) Focus an object at the same distance as the subject and lock the focus before recomposing. (p.48)
- (2) Set the lens focus mode switch to <MF> and focus manually.

Manual Focusing

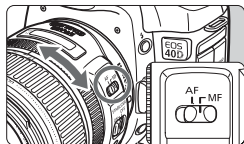

- 1 Set the lens focus mode switch to <MF>.
- 2 Focus the subject.
 - Focus by turning the lens focusing ring until the subject looks sharp in the viewfinder.

 If you press the shutter button halfway during manual focusing, the active AF point and the focus confirmation light <●> in the viewfinder will light when focus is achieved.

Selecting the Drive Mode ★

Single and continuous drive modes are provided. In the Basic Zone modes, the optimum drive mode is set automatically.

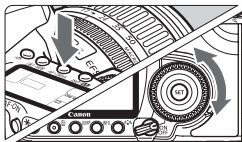

1 Press the **<AF·DRIVE>** button. (ⓘ6)



2 Select the drive mode.

- While looking at the LCD panel, turn the  dial.

 : **Single shooting**

When you press the shutter button completely, one shot will be taken.

 **H** : **High-speed continuous shooting** (Max. 6.5 shots per sec.)

 : **Low-speed continuous shooting** (Max. 3 shots per sec.)
In the  **H** and  modes, the camera will shoot continuously while you hold down the shutter button completely.

 : **Self-timer** (10-sec. delay)

 **2** : **Self-timer** (2-sec. delay)
See the next page for the self-timer operation procedure.

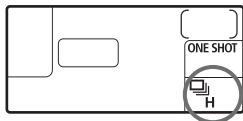

- When the internal buffer memory becomes full during continuous shooting, “**buSY**” will be displayed on the LCD panel and in the viewfinder and shooting will be disabled temporarily. As the captured images are recorded to the CF card, you will be able to shoot more images. Press the shutter button halfway to check in the viewfinder’s bottom right for the current maximum burst. This is the maximum number of shots that can be taken continuously.
- If “**FuLL CF**” is displayed in the viewfinder and on the LCD panel, wait until the access lamp stops blinking, then replace the CF card.
- When the battery level is low, the continuous shooting speed will be slightly slower.

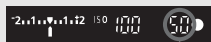

Maximum burst

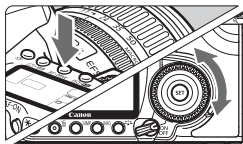

Self-timer Operation

Use the self-timer when you want to be in the picture. The  (10 sec. timer) can be used in all shooting modes.



1 Press the <AF•DRIVE> button. ()

2 Select either  or .

- Look at the LCD panel and turn the  dial to select  or .

 : 10-sec. self-timer

 : 2-sec. self-timer *



3 Take the picture.

- Focus the subject and press the shutter button completely.
- ▶ The picture will be taken after the self-timer delay elapses.
- ▶ You can check the self-timer operation with the self-timer lamp, beeper, and countdown display (in seconds) on the LCD panel.
- ▶ Two seconds before the picture is taken, the self-timer lamp will stay on and the beeper will sound faster.

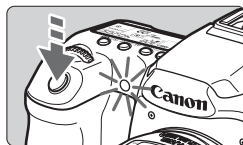

 Do not stand in front of the camera when you press the shutter button to start the self-timer. Doing so will throw off the focus.

- Use a tripod when using the self-timer.
- When starting the self-timer, look through the viewfinder or attach the eyepiece cover. (p.97)
- To cancel the self-timer after it starts, set the power switch to <OFF>.
- When using the self-timer to shoot only yourself, use focus lock (p.48) for an object at about the same distance as where you will be.
- The 2-second self-timer is effective for close-ups or photo duplicating work to prevent camera shake (camera movement while the shutter button is pressed).

5

Advanced Operations

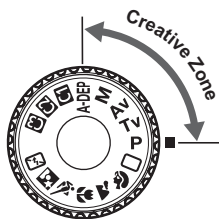

With Creative Zone modes, you can set the desired shutter speed or aperture to obtain the result you want. You take control of the camera.

- The asterisk ★ on the right of the page title indicates that the respective feature is available only in Creative Zone modes (**P**, **Tv**, **Av**, **M**, **A-DEP**).
- After you press the shutter button halfway and let go, the LCD panel and viewfinder information will remain displayed for about 4 sec. (4).
- To see what can be set in the Creative Zone modes, see "Function Availability Table" (p.172).



First set the power switch to < >.

P: Program AE

The camera automatically sets the shutter speed and aperture to suit the subject's brightness. This is called Program AE.

* <P> stands for Program.

* AE stands for Auto Exposure.



1 Set the Mode Dial to <P>.



2 Focus the subject.

- Look through the viewfinder and aim the selected AF point over the subject. Then press the shutter button halfway.
- ▶ The AF point which achieves focus flashes in red, and the focus confirmation light <●> in the viewfinder's bottom right lights. (In the One-Shot AF + automatic AF point selection mode)
- ▶ The shutter speed and aperture will be set automatically and displayed in the viewfinder and on the LCD panel.



3 Check the shutter speed and aperture display.

- A correct exposure will be obtained as long as the shutter speed and aperture display do not blink.



4 Take the picture.

- Compose the shot and press the shutter button completely.

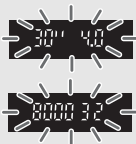

- If “30” shutter speed and the maximum aperture blink, it indicates underexposure. Increase the ISO speed or use flash.
- If “8000” shutter speed and the minimum aperture blink, it indicates overexposure. Lower the ISO speed or use an ND filter (sold separately) to reduce the amount of light entering the lens.



Differences Between <P> and <□> (Full Auto)

With <□>, many functions such as the AF mode, drive mode, and built-in flash are set automatically to prevent spoiled shots. The functions you can set are limited. With <P>, only the shutter speed and aperture are set automatically. You can freely set the AF mode, drive mode, built-in flash, and other functions.

About Program Shift

- In the Program AE mode, you can freely change the shutter speed and aperture combination (Program) set by the camera while maintaining the same exposure. This is called Program Shift.
- To do this, press the shutter button down halfway, then turn the <☀> dial until the desired shutter speed or aperture value is displayed.
- Program Shift is canceled automatically after the picture is taken.
- Program Shift cannot be used with flash.

Tv: Shutter-Priority AE

In this mode, you set the shutter speed and the camera automatically sets the aperture to obtain the correct exposure matching the brightness of the subject. This is called shutter-priority AE. A faster shutter speed can freeze the action or moving subject. Or a slower shutter speed can create a blurred effect, giving the impression of motion.

* <Tv> stands for Time value.



Fast shutter speed



Slow shutter speed



1 Set the Mode Dial to <Tv>.



2 Set the desired shutter speed.

- While looking at the LCD panel, turn the  dial.

3 Focus the subject.

- Press the shutter button halfway.
- ▶ The aperture is set automatically.



4 Check the viewfinder display and shoot.

- As long as the aperture is not blinking, the exposure will be correct.



- If the maximum aperture blinks, it indicates underexposure.

Turn the <  > dial to set a slower shutter speed until the aperture stops blinking or set a higher ISO speed.



- If the minimum aperture blinks, it indicates overexposure.

Turn the <  > dial to set a faster shutter speed until the aperture stops blinking or set a lower ISO speed.



Shutter Speed Display

The shutter speeds from “8000” to “4” indicate the denominator of the fractional shutter speed. For example, “125” indicates 1/125 sec. Also, “0”5” indicates 0.5 sec. and “15”” is 15 sec.

Av : Aperture-Priority AE

In this mode, you set the desired aperture and the camera sets the shutter speed automatically to obtain the correct exposure suiting the subject brightness. This is called aperture-priority AE. A higher $f/$ number (smaller aperture hole) will make more of the foreground and background fall within acceptable focus. On the other hand, a lower $f/$ number (larger aperture hole) will make less of the foreground and background fall within acceptable focus.

* <Av> stands for Aperture value (aperture opening).



With a large aperture opening



With a small aperture opening



1 Set the Mode Dial to <Av>.



2 Set the desired aperture.

- While looking at the LCD panel, turn the <⚙> dial.

3 Focus the subject.

- Press the shutter button halfway.
- ▶ The shutter speed is set automatically.



4 Check the viewfinder display and shoot.

- As long as the shutter speed is not blinking, the exposure will be correct.



- If the “30” shutter speed blinks, it indicates underexposure. Turn the dial to set a larger aperture (smaller f/ number) until the blinking stops or set a higher ISO speed.



- If the “8000” shutter speed blinks, it indicates overexposure. Turn the dial to set a smaller aperture (larger f/ number) until the blinking stops or set a lower ISO speed.



Aperture Display

The larger the f/number, the smaller the aperture opening will be. The apertures displayed will differ depending on the lens. If no lens is attached to the camera, “00” will be displayed for the aperture value.

Depth-of-Field Preview [★]

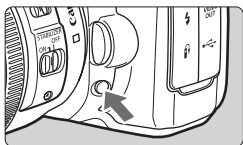

Press the depth-of-field preview button to stop down to the current aperture setting. You can check the depth of field (range of acceptable focus) through the viewfinder.



- A higher f/number will make more of the foreground and background fall within acceptable focus. However, the viewfinder will look darker.
- If the depth of field is difficult to discern, hold down the depth-of-field preview button while turning the dial.
- The exposure will be locked (AE lock) while the depth-of-field preview button is pressed.

M: Manual Exposure

In this mode, you set both the shutter speed and aperture as desired. To determine the exposure, refer to the exposure level indicator in the viewfinder or use a commercially-available handheld exposure meter. This method is called manual exposure.

* <M> stands for Manual.



1 Set the Mode Dial to <M>.

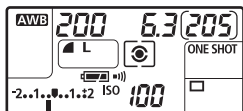

2 Set the shutter speed and aperture.

- To set the shutter speed, turn the <☀> dial.
- To set the aperture, set the power switch to <⏏>, and turn the <⦿> dial.

Standard exposure index



Exposure level mark

3 Focus the subject.

- Press the shutter button halfway.
- ▶ The exposure setting will be displayed in the viewfinder and on the LCD panel.
- The exposure level mark <⏏> lets you see how far you are from the standard exposure level.

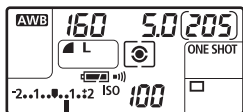

4 Set the exposure.

- Check the exposure level and set the desired shutter speed and aperture.

5 Take the picture.

A-DEP: Automatic Depth-of-Field AE

Objects in the foreground and background will be in focus automatically. All the AF points will function to detect the subject, and the aperture required to attain the necessary depth of field will be set automatically.

* <A-DEP> stands for Auto-Depth of field. This mode sets the depth of field automatically.



1 Set the Mode Dial to <A-DEP>.



2 Focus the subject.

- Aim the AF points over the subjects and press the shutter button halfway. (📷4)
- All the subjects covered by the AF points flashing in red will be in focus.

3 Take the picture.



- If the “30” shutter speed blinks, it indicates that the subject is too dark. Increase the ISO speed.
- If the “8000” shutter speed blinks, it indicates that the subject is too bright. Decrease the ISO speed.



- If the aperture blinks, it indicates that the exposure level is correct but the desired depth of field cannot be obtained. Either use a wide-angle lens or move further away from the subjects.
- If the camera sets a slow shutter speed, hold the camera steady or use a tripod.
- If you use flash, the result will be the same as using <P> with flash.

Selecting the Metering Mode ★

Four metering modes are provided: Evaluative, partial, spot, and center-weighted average metering. In the Basic Zone modes, evaluative metering is set automatically.

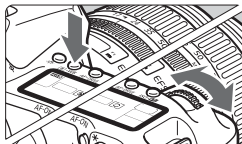

1 Press the  ·WB> button. (06)

2 Select the metering mode.

- While looking at the LCD panel, turn the  dial.

: **Evaluative metering**

: **Partial metering**

: **Spot metering**

: **Center-weighted average metering**

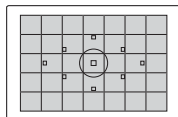

 **Evaluative metering**

This is an all-around metering mode suited for portraits and even backlit subjects. The camera sets the exposure automatically to suit the scene.

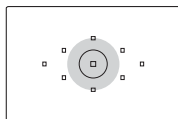

 **Partial metering**

Effective when the background is much brighter than the subject due to backlighting, etc. Partial metering covers about 9% of the viewfinder area at the center.

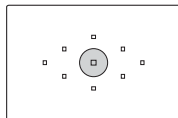

 **Spot metering**

This is for metering a specific part of the subject or scene. The metering is weighted at the center covering about 3.8% of the viewfinder area.

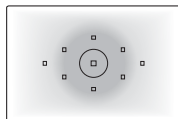

 **Center-weighted average metering**

The metering is weighted at the center and then averaged for the entire scene.

Setting Exposure Compensation [★]

Exposure compensation is used to alter the standard exposure set by the camera. You can make the image look brighter (increased exposure) or darker (decreased exposure). You can set the exposure compensation up to ± 2 stops in 1/3-stop increments.

1 Turn the Mode Dial to any Creative Zone mode except <M>.



2 Check the exposure level indicator.

- Press the shutter button halfway and check the exposure level indicator.

Increased exposure



Decreased exposure



3 Set the exposure compensation amount.

- Set the power switch to <L>, and while looking at the viewfinder or LCD panel, turn the <Q> dial.
- Turn the <Q> dial while pressing the shutter button halfway or within (4) after pressing the shutter button halfway.
- To cancel the exposure compensation, set the exposure compensation amount back to <0>.

4 Take the picture.



- The exposure compensation amount will remain in effect even after you set the power switch to <OFF>.
- Take care not to turn the <Q> dial and change the exposure compensation inadvertently. To prevent this, set the power switch to <ON>.

MENU Auto Exposure Bracketing (AEB)★

By changing the shutter speed or aperture automatically, the camera brackets the exposure up to ± 2 stops in 1/3-stop increments for three successive shots. This is called AEB.

* AEB stands for Auto Exposure Bracketing.

1 Select [AEB].

- Under the [AEB] tab, select [AEB], then press $\langle \text{SET} \rangle$.



AEB amount

2 Set the AEB amount.

- Turn the $\langle \text{DIAL} \rangle$ dial to set the AEB amount, then press $\langle \text{SET} \rangle$.
- ▶ When you exit the menu, $\langle \text{MENU} \rangle$ and the AEB level will be displayed on the LCD panel.

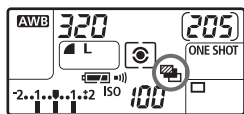

3 Take the picture.

- Focus and press the shutter button completely. The three bracketed shots will be taken in this sequence: Standard, decreased, and increased exposure.

Canceling AEB

- Follow steps 1 and 2 to set the AEB amount to $\langle -2..1..0..1..:2 \rangle$.
- AEB will be canceled automatically when you set the power switch to $\langle \text{OFF} \rangle$ or the flash is ready to fire.

- If the drive mode is set to $\langle \text{L} \rangle$, you must press the shutter button three times. When $\langle \text{H} \rangle$ or $\langle \text{H} \rangle$ is set and you hold down the shutter button completely, the three bracketed shots will be taken continuously. Then the camera will stop shooting. When $\langle \text{2} \rangle$ or $\langle \text{2} \rangle$ is set, the three bracketed shots will be taken after a 10-sec. or 2-sec. delay.
- AEB can be combined with exposure compensation.
- Neither flash nor bulb exposures can be used with AEB.

✳ AE Lock ✳

Use AE lock when the area of focus is to be different from the exposure metering area or when you want to take multiple shots at the same exposure setting. Press the <✳> button to lock the exposure, then recompose and take the shot. This is called AE lock. It is effective for backlit subjects.

1 Focus the subject.

- Press the shutter button halfway.
- ▶ The exposure setting will be displayed.

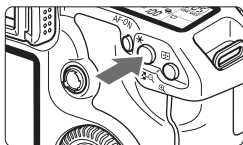

2 Press the <✳> button. (☉4)

- ▶ The <✳> icon lights in the viewfinder to indicate that the exposure setting is locked (AE lock).
- Each time you press the <✳> button, it locks the current exposure setting.



3 Recompose and take the picture.

- If you want to maintain the AE lock while taking more shots, hold down the <✳> button and press the shutter button to take another shot.

AE Lock Effects

Metering Mode	AF Point Selection Method	
	Automatic Selection	Manual Selection
<input checked="" type="checkbox"/> Evaluative metering*	AE lock is applied at the AF point that achieved focus.	AE lock is applied at the selected AF point.
<input type="checkbox"/> Partial metering	AE lock is applied at the center AF point.	
<input type="checkbox"/> Spot metering		
<input type="checkbox"/> Center-weighted average metering		

* When the lens' focus mode switch is set to <MF>, AE lock is applied at the center AF point.

Bulb Exposures

When bulb is set, the shutter stays open while you hold down the shutter button completely, and closes when you let go of the shutter button. This is called bulb exposure. Use bulb exposures for night scenes, fireworks, the heavens, and other subjects requiring long exposures.

1 Set the Mode Dial to <M>.

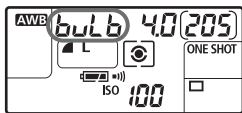

2 Set the shutter speed to "buLb."

- While looking at the LCD panel, turn the <☀> dial to select "buLb."
- The next setting after "30" is "buLb."

3 Set the desired aperture and shoot.

- To set the aperture, set the power switch to <↘>, and turn the <☉> dial.
- While you hold down the shutter button, the exposure will continue.
- ▶ The elapsed exposure time (sec.) will be indicated on the LCD panel by the same indicator used for the shots remaining.

- Since bulb exposures have more noise than usual, the image may look rough or grainy.
- When [C.Fn II -1] (Long exp. noise reduction) is set to [1:Auto] or [2:On], noise generated by the bulb exposure can be reduced. (p.156)
- For bulb exposures, using Remote Switch RS-80N3 or Timer Remote Controller TC-80N3 (both sold separately) is recommended.

☀ LCD Panel Illumination



Each time you press the <☀> button, the LCD panel illumination will turn on or off (☀6). During a bulb exposure, pressing the shutter button completely will turn off the LCD panel illumination.

Using the Eyepiece Cover

If you take a picture without looking at the viewfinder, light entering the eyepiece can throw off the exposure. To prevent this, use the eyepiece cover attached to the camera strap.

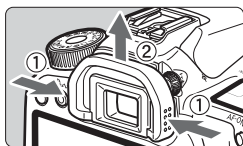

1 Remove the eyecup.

- From the bottom of the eyecup, push it upward.

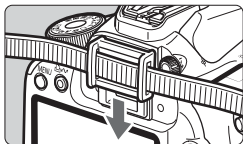

2 Attaching the Eyepiece Cover.

- Slide the eyepiece cover down into the eyepiece groove to attach it.

Connecting the Remote Switch

You can connect Remote Switch RS-80N3 or Timer Remote Controller TC-80N3 (both sold separately) or any EOS accessory equipped with an N3-type terminal to the camera and shoot with it.

To operate the accessory, refer to its instruction manual.

1 Open the terminal cover.

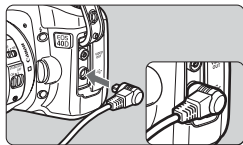

2 Connect the plug to the remote control terminal.

- Connect the plug as shown in the illustration.
- To disconnect the plug, grasp the plug's silver part and pull out.

Mirror Lockup

Although using the self-timer or Remote Switch can prevent camera shake, using mirror lockup to prevent camera vibrations can also help when you use a super telephoto lens or shoot close ups.

When [C.Fn III -7] (Mirror lockup) is set to [1:Enable] (p.160), shooting with mirror lockup will be possible.

1 Focus the subject, press the shutter button completely and release it.

- ▶ The mirror will swing up.

2 Press the shutter button completely again.

- ▶ The picture is taken and the mirror goes back down.



- In very bright light such as at the beach or ski slope on a sunny day, take the picture promptly after mirror lockup.
- During mirror lockup, do not point the camera lens at the sun. The sun's heat can scorch and damage the shutter curtains.
- If you use bulb exposures, the self-timer, and mirror lockup in combination, keep pressing the shutter button completely (self-timer delay time + bulb exposure time). If you let go of the shutter button during the 2-sec./10-sec. self-timer countdown, there will be a shutter-release sound. This is not the actual shutter release (no picture is taken).



- When [1:Enable] is set, single shooting will take effect even if the drive mode is continuous.
- When the self-timer is set to or , the picture will be taken after 10 sec. or 2 sec. respectively.
- The mirror locks up, and after 30 seconds, it will go back down automatically.
- For mirror lockup shots, using Remote Switch RS-80N3 or Timer Remote Controller TC-80N3 (both sold separately) is recommended.

Using the Built-in Flash

E-TTL II autoflash obtains high-precision and consistent flash shots.

Using the Built-in Flash in the Basic Zone

If necessary, the built-in flash will pop-up automatically in low-light or backlit conditions. (except in modes)

Using the Built-in Flash in the Creative Zone

Regardless of the light level, you can press the button to pop-up and fire the built-in flash whenever desired. If the built-in flash has popped up, you can push it back down with your fingers.

- P** : For fully automatic flash photography. The shutter speed (1/60 sec. - 1/250 sec.) and aperture are set automatically.
- Tv** : Enables you to set the desired shutter speed (30 sec. - 1/250 sec.). The flash exposure will be set automatically to match the aperture that was set automatically.
- Av** : Enables you to set the desired aperture. The flash exposure will be set automatically to match the aperture that was set. The shutter speed will set automatically between 30 sec. - 1/250 sec. to suit the scene's brightness.
- In low light, the main subject is exposed with the automatic flash, and the background is exposed with a slow shutter speed set automatically. Both the subject and background look properly exposed (automatic slow-speed flash sync).
- With slow shutter speeds, using a tripod is recommended.
 - If you do not want to use a slow shutter speed, set [ C.Fn I -7] (Flash sync. speed in Av mode) to [1:1/250sec. (fixed)]. (p.155)
- M** : You can set both the shutter speed (bulb or 30 sec. - 1/250 sec.) and aperture. The flash exposure will be set automatically to match the aperture that was set. The background exposure will vary depending on the shutter speed and aperture.
- A-DEP** : The flash result will be the same as the mode.



Effective Range of Built-in Flash

[Approx. meters/feet]

ISO Speed	EF-S18-55mm f/3.5-5.6 IS		EF-S17-85mm f/4-5.6 IS USM	
	Wide Angle: 18mm	Telephoto: 55mm	Wide Angle: 17mm	Telephoto: 85mm
100	1 - 3.7 / 3.3 - 12.1	1 - 2.3 / 3.3 - 7.5	1 - 3.3 / 3.3 - 10.8	1 - 2.3 / 3.3 - 7.5
200	1 - 5.3 / 3.3 - 17.4	1 - 3.3 / 3.3 - 10.8	1 - 4.6 / 3.3 - 15.1	1 - 3.3 / 3.3 - 10.8
400	1 - 7.4 / 3.3 - 24.3	1 - 4.6 / 3.3 - 15.1	1 - 6.5 / 3.3 - 21.3	1 - 4.6 / 3.3 - 15.1
800	1 - 10.5 / 3.3 - 34.4	1 - 6.6 / 3.3 - 21.7	1 - 9.2 / 3.3 - 30.2	1 - 6.6 / 3.3 - 21.7
1600	1 - 14.9 / 3.3 - 48.9	1 - 9.3 / 3.3 - 30.5	1 - 13.0 / 3.3 - 42.7	1 - 9.3 / 3.3 - 30.5
H: 3200	1 - 21.0 / 3.3 - 68.9	1 - 13.1 / 3.3 - 43.0	1 - 18.4 / 3.3 - 60.4	1 - 13.1 / 3.3 - 43.0

 Detach the lens hood and keep at least 1 meter/3.3 feet away from the subject. If the lens has a hood attached or you are too close to the subject, the bottom of the picture might look dark due to the obstructed flash. If you use a telephoto lens or a fast lens and the flash is still partially obstructed, use an EX-series Speedlite (sold separately).

MENU Using Red-eye Reduction

Using the red-eye reduction lamp before taking a flash picture can reduce red eye. Red-eye reduction will work in any shooting mode except < > < > < >.

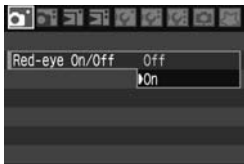



- Under the [] tab, select [**Red-eye On/Off**] and press <SET>. Set it to [**On**], then press <SET>.
- In flash photography, when you press the shutter button halfway, the red-eye reduction lamp will light. Then when you press the shutter button completely, the picture will be taken.

- 
- The red-eye reduction feature is most effective when the subject looks at the red-eye reduction lamp, when the room is well lit, or when you go closer to the subject.
 - When you press the shutter button halfway, the viewfinder display on the bottom will gradually turn off. For best results, take the picture after this display turns off.
 - The effectiveness of red-eye reduction varies from subject to subject.

Flash Exposure Compensation *

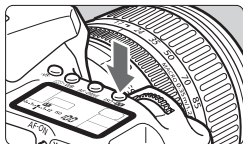
In the same way as normal exposure compensation, you can set exposure compensation for flash. You can set flash exposure compensation up to ± 2 stops in 1/3-stop increments.



1 Press the <ISO-> button. (ⓘ6)



Increased exposure



Decreased exposure



2 Set the flash exposure compensation amount.

- While looking at the LCD panel or viewfinder, turn the <> dial.
- To cancel the flash exposure compensation, set the flash exposure compensation amount back to <>.
- When you press the shutter button halfway, the <> icon will be displayed in the viewfinder and on the LCD panel.

3 Take the picture.



If you set flash exposure compensation with both the EX-series Speedlite and camera, the Speedlite's flash exposure compensation setting will override the camera's. If you set EX-series Speedlite's flash exposure compensation with the flash, any flash exposure compensation set with the camera will be overridden.



- The exposure compensation amount will remain in effect even after you set the power switch to <OFF>.
- The procedure is the same when using an EX-series Speedlite. The Speedlite's flash exposure compensation can be set with the camera.
- It can also be set with a menu. (p.103)

✳ FE Lock ✳

FE (flash exposure) lock obtains and locks the correct flash exposure reading for any part of a subject.

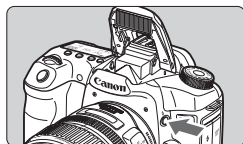

1 Press the <⚡> button to pop-up the built-in flash.

- Press the shutter button halfway and look in the viewfinder to check that the <⚡> icon is lit.

2 Focus the subject.

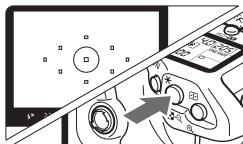

3 Press the <✳> button. (ⓘ16)

- Aim the viewfinder center over the subject where you want to lock the flash exposure, then press the <✳> button.
- ▶ The flash will fire a preflash and the required flash output is calculated and retained in memory.
- ▶ In the viewfinder, “FEL” is displayed for a moment and <⚡✳> will light.
- Each time you press the <✳> button, a preflash is fired and the required flash output is calculated and retained in memory.

4 Take the picture.

- Compose the shot and press the shutter button completely.
- ▶ The flash is fired to take the picture.



⚠ If the subject is too far away and beyond the effective range of the flash, the <⚡> icon will blink. Get closer to the subject and repeat steps 2 to 4.

MENU Flash Control★

The built-in flash and external Speedlite can also be set with the menu. The menu for the external Speedlite will be applicable only to **EX-series Speedlites whose functions can be set with the camera.**

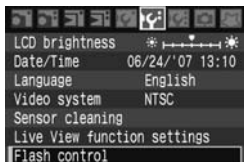

Select [Flash control].

- Under the [**F**] tab, select [**Flash control**], then press < **SET** >.
- ▶ The flash control screen will appear.

[Flash firing]

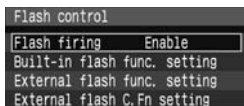

- Normally, set this to [**Enable**].
- If [**Disable**] is set, both the built-in flash and external Speedlite will not fire. This is good when you only want to use the AF-assist beam.

[Built-in flash func. setting]

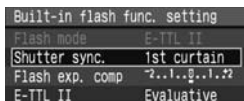

● Shutter sync.

Normally, set this to [**1st curtain**] so that the flash fires immediately after the exposure starts.

If [**2nd curtain**] is set, the flash will fire right before the exposure ends. When this is combined with a slow sync speed, you can create a trail of light such as from car headlights at night. With 2nd curtain sync, two flashes will be fired. Once when you press the shutter button completely, and once immediately before the exposure ends.

● E-TTL II

For normal flash exposures, set it to **[Evaluative]**.



If **[Average]** is set, the flash exposure will be averaged for the entire metered scene as with an external metering flash. Flash exposure compensation may be necessary depending on the scene, so this is for advanced users.

Setting the External Speedlites

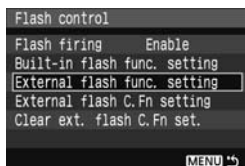
Select either **[External flash func. setting]** or **[External flash C.Fn setting]**. For details on which external Speedlite settings the camera can set, see the EX-series (such as the 580EX II) Speedlite's instruction manual. Attach the Speedlite to the camera and turn on the Speedlite.



1 Select either **[External flash func. setting]** or **[External flash C.Fn setting]**.

- Turn the  dial to select a setting, then press .
- Settings which cannot be set will be dimmed.

External flash func. setting

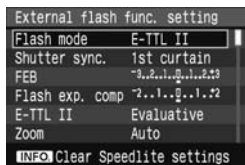

2 Set the external flash function settings.

- Select a flash function and set it as desired. The procedure is the same as setting a menu function.
- On the flash function settings screen, the settable items, current settings, flash mode setting, and flash Custom Function settings might look different on your camera.
- If you press the  button to clear the Speedlite settings, both the external Speedlite and built-in flash settings will be cleared.

External flash C.Fn setting

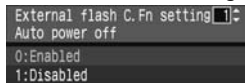

External Speedlites

EOS-dedicated, EX-series Speedlites

Basically operates like a built-in flash for easy operation.

When an EX-series Speedlite is attached to the camera, almost all the autoflash control is done by the camera. In other words, it is like a high-output flash attached externally in place of the built-in flash. For detailed instructions, see the EX-series Speedlite's instruction manual. This camera is a Type-A camera that can use all the features of EX-series Speedlites.

Shoe-mount Speedlites



Macro Lites



Canon Speedlites other than the EX-series

- **With an EZ/E/EG/ML/TL-series Speedlite set in the TTL or A-TTL autoflash mode, the flash can be fired at full output only.** Set the camera's shooting mode to manual or aperture-priority AE and shoot.
- When using a Speedlite which has manual flash mode, shoot with the manual flash mode.
- With an EX-series Speedlite set to TTL autoflash with the flash's Custom Function, the flash will fire at full output only.

Using Non-Canon Flash Units

Sync Speed

The camera can synchronize with compact, non-Canon flash units at 1/250 sec. or slower shutter speeds. With large studio flash, the sync speed is 1/60 sec. or slower. Be sure to test the flash unit beforehand to make sure it synchronizes properly with the camera.

PC Terminal

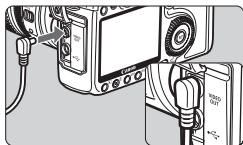

- The camera's PC terminal is provided for flash units having a sync cord. The PC terminal is threaded to prevent inadvertent disconnection.
- The camera's PC terminal has no polarity. You can connect any sync cord regardless of its polarity.

Cautions for Live View shooting

When using a non-Canon flash unit for Live View shooting, set the **[Live View function settings]** menu's **[Silent shoot.]** to **[Disable]** (p.113). The flash will not fire if it is set to **[Mode 1]** or **[Mode 2]**.



- ⚠ If the camera is used with a flash unit or flash accessory dedicated to another camera brand, the camera may not operate properly and malfunction may result.
 - Do not connect to the camera's PC terminal any flash unit requiring 250 V or more.
 - Do not attach a high-voltage flash unit on the camera's hot shoe. It might not work.

 A flash unit attached to the camera's hot shoe and a flash unit connected to the PC terminal can both be used at the same time.

6

Live View Shooting

You can shoot while viewing a real-time image on the camera's LCD monitor or on a personal computer screen. This is called "Live View shooting."

- When using Live View shooting, **using a hard disk-type CF card** (such as MicroDrive) **is not recommended**.
- If Live View shooting is done under direct sunlight or other high-temperature environments, the <  > icon (warning for high temperature in the camera) may appear on the screen. If Live View shooting continues with a high internal temperature, it may degrade image quality. You should therefore stop Live View shooting if the warning icon appears.
- If Live View shooting continues while the <  > warning icon is displayed and the camera's internal temperature increases, the Live View shooting will stop automatically. Shooting will be disabled until the camera's internal temperature decreases.

About Remote Live View Shooting

With the provided software installed in the personal computer, you can connect the camera to the personal computer and shoot remotely while viewing the computer screen instead of the camera's viewfinder. For details, see the Software Instruction Manual in the CD-ROM.

Live View Shooting★

Instead of looking through the viewfinder, you can look at a real-time image on the camera's LCD monitor while shooting. Live View shooting does not work in Basic Zone modes.

Preparing for Live View Shooting

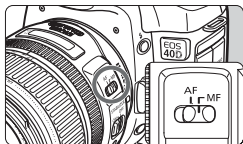

1 Set the lens focus mode switch to <MF>.

2 Set the shooting mode.

- Set the shooting mode to a Creative Zone mode.

3 Select [Live View function settings].

- Under the [**Lf**] tab, select [**Live View function settings**], then press <SET>.

4 Select [Live View shoot.].

- Turn the <Q> dial to select [**Live View shoot.**], then press <SET>.

5 Select [Enable].

- Turn the <Q> dial to select [**Enable**], then press <SET>.

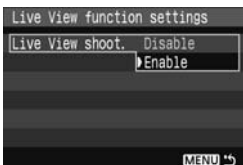
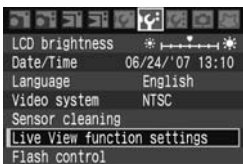

! During Live View shooting, do not point the camera toward the sun. The sun's heat can damage the camera's internal components.

- If you handhold the camera like a compact digital camera and shoot while viewing the LCD monitor, camera shake can cause blurred images. For Live View shooting, **mounting the camera on a tripod is recommended.**
- <A-DEP> will be the same as using <P>.

Displaying Live View Image on the LCD Monitor

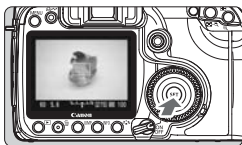

With the camera ready to shoot, press <SET>.

- ▶ The Live View image will appear on the LCD monitor in real-time with approx. 100% field of view.
- With the video cable (provided) connecting the camera to a TV set, you can view images on the TV. (p.122)

During Live View image display, if you point the camera in a different direction, it might throw off the correct brightness momentarily and the image might not look right. Wait until the image stabilizes at the correct brightness before shooting. If you shoot while the image brightness is not yet stable, the resulting image might be overexposed or underexposed.

If the light source within the image changes, the screen might flicker. If this happens, press <SET> to end the shooting, then with the new light source in place, press <SET> again to resume shooting.

Setting the Shooting Functions

In the same way as during normal shooting through the viewfinder, you can set the shooting functions (drive mode, ISO speed, Picture Style, white balance, exposure compensation, AE lock, flash exposure compensation, etc.). If you change the shooting mode during Live View image display, the Live View image display will quit.

- Only the metering mode cannot be changed. Focusing frame-linked evaluative metering with the image sensor will take effect.
- Continuous shooting is possible.
- With the [**Lf**: Live View function settings] menu's [**Metering timer**], you can change how long the metered exposure setting is to be retained.
- The focus preset feature on super telephoto lenses cannot be used.

Magnifying the Image for Manual Focusing



1 Move the focusing frame to the position where you want to focus.

- Use <⊕> to move the focusing frame in full view. If you press <⊕> straight down, the focusing frame will return to the center.

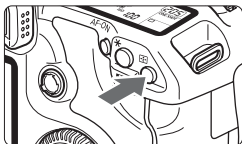

2 Press the <⊕> button.

- ▶ The focusing frame will be magnified.
- ▶ AE lock will be applied to the full-view exposure, and the shutter speed and aperture settings will be displayed in orange.
- Each time you press the <⊕> button, the display format will change as follows:

Full view → Approx. 5x → Approx. 10x

Magnification: Approx. 10x

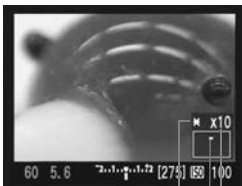

AE lock
Magnified area
Magnification

3 Focus manually.

- While looking at the Live View image on the LCD monitor, turn the lens's focusing ring to **focus manually**.

- High temperatures, high ISO speeds, or long exposures may cause noise or irregular colors in the captured image shot with Live View shooting.
- During continuous shooting, the exposure set for the first shot will also be applied to subsequent shots. If you recompose during continuous shooting, the exposure might not match the latter shots.
- If the camera is not operated for a prolonged period, the power will turn off automatically as set with [P] **Auto power off**. (p.42)

- While the image is magnified, pressing the <⊕> button will not renew the exposure setting.
- During the 5x or 10x magnified view, the image sharpness may be applied to a higher degree than what was set. This is to make it easier to focus manually.

Taking the picture



1 Check the composition.

- Press the <Q> button to check the image composition in full view.

2 Check the shutter speed and aperture display.

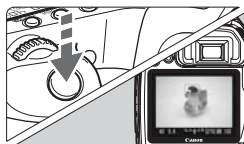

3 Take the picture.

- Press the shutter button completely.
 - ▶ The picture will be taken and the captured image is displayed on the LCD monitor.
 - ▶ After the image review ends, the camera will return to Live View shooting automatically.
- To terminate shooting, press <SET> while Live View image is displayed.



- You can check the exposure and depth of field by pressing the depth-of-field preview button.
- Flash photography is also possible. However, FE lock, modeling flash, and test firing are not possible. The Speedlite's Custom Functions also cannot be set with the Speedlite.
- With the 580EX II, the wireless setting cannot be changed.
- Under low light or bright light conditions, the Live View image might not display the proper brightness. However, the captured image will reflect the exposure setting.
- If there is a very bright light source in the picture, such as the sun, the bright area might be blackened on the LCD monitor. However, the actual captured image will correctly show the bright area.
- When flash is used, there will be two shutter sounds, but only one shot will be taken.

About the Information Display

- Each time you press the <INFO.> button, the information display will change.

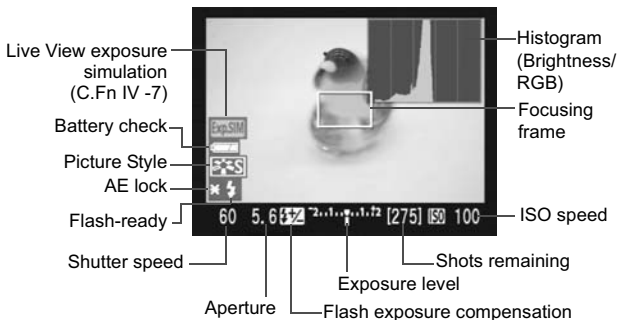

- When the [**IV**: Live View function settings] menu's [**Grid display**] is set to [**On**], a grid will appear to make it easier to align the horizontal or vertical shot.
- When [**C.Fn IV -7**] (**Live View exposure simulation**) is set to [**1:Enable(simulates exposure)**], the Live View image will be displayed with the brightness level simulating the exposure setting. This enables you to see how the exposure looks before taking the picture. (p.163)
- The histogram (p.118) will be displayed only when C.Fn IV -7-1 has been set. If flash is used or bulb is set, the histogram will be grayed out. The histogram may not be properly displayed in low light or bright light conditions.
- During Live View shooting, if the <INFO.> warning icon (temperature increase warning) is displayed, see page 107.

Possible Shots During Live View Shooting

Temperature	At 23°C / 73°F	At 0°C / 32°F
Possible Shots	Approx. 170	Approx. 130

* The figures above are based on a fully-charged BP-511A and CIPA (Camera & Imaging Products Association) testing standards.

About Silent Shooting

Instructions for setting the [**Lf**: **Live View function settings**] menu's [**Silent shoot.**] are explained below.

- **Mode 1**

The shooting sound will be quieter than when Live View shooting is not used. Continuous shooting is also possible. For high-speed continuous shooting, it will be approx. 6 fps.

- **Mode 2**

When you press the shutter button completely, only one shot will be taken. While you keep holding down the shutter button, further camera operation will be suspended. Then when you return to the shutter button's halfway position, the camera operation will resume and the shooting sound will occur only then. By delaying the shooting sound, the disturbance can be minimized. Even if continuous shooting is set, only a single shot can be taken in this mode.

- **Disable**

If you use a TS-E lens to make **vertical shift movements** or use an Extension Tube, be sure to set it to [**Disable**]. Setting it to [**Mode 1**] or [**Mode 2**] will result in incorrect or irregular exposures.

When you press the shutter button completely, the shutter will sound like it took two shots. However, only one shot will be taken.



- If flash is used and [**Mode 1**] or [**Mode 2**] has been set, the operation will be the same as the [**Disable**] setting.
- When using a non-Canon flash unit, set it to [**Disable**] (p.106). The flash will not fire if it is set to [**Mode 1**] or [**Mode 2**].

Using AF to Focus

If the [**C.Fn III -6**] (**AF during Live View shooting**) setting is set to [**Enable**], you can focus with the <AF-ON> button.

Be sure to set the lens focus mode switch to <AF>, set the AF mode to <ONE SHOT>, and select the center AF point.

1 Press <SET> to the display Live View image.



2 Focus the subject.

- Cover the subject with the focusing frame and press the <AF-ON> button.
- ▶ The Live View image will turn off, the reflex mirror will go back down, and AF will be executed.
- ▶ When focus is achieved, the beeper will sound.

3 Return to the Live View image display and shoot.

- When you let go of the <AF-ON> button, the Live View image will return.
- Check the focus and press the shutter button to take the picture.

- For very precise focusing, mount the camera on a tripod and magnify the picture. Then focus manually. (p.110)
- You can also use AI Servo AF or automatic/manual AF point selection. However, if the AF point doesn't cover the subject, you might not obtain the desired focusing result.

- You cannot take a picture during autofocus. Take the picture only while the Live View image is displayed.
- The exposure will be set with focusing frame-linked evaluative metering. (The metering cannot be linked with an AF point.)

7

Image Playback

This chapter explains how to playback images, including how to erase images and how to display images on a TV screen.

For images taken with another camera:

The camera might not be able to properly display images captured with a different camera or edited with a personal computer or whose file name was changed.

▶ Image Playback

Single Image Display



1 Playback the image.

- Press the <▶> button.
- ▶ The last captured image or last image viewed will appear.

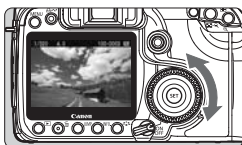

2 Select the image.

- To playback images starting with the last image, turn the <◀> dial counterclockwise. To playback images starting with the first captured image, turn the dial clockwise.
- Press the <INFO.> button to change the display format.



Single image display



Single image display + Image-recording quality

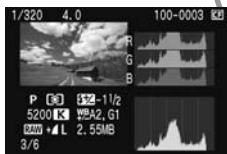

Histogram display



Shooting information display

3 Exit the image playback.

- Press the <▶> button to exit the image playback and return the camera to shooting ready.

Shooting Information Display

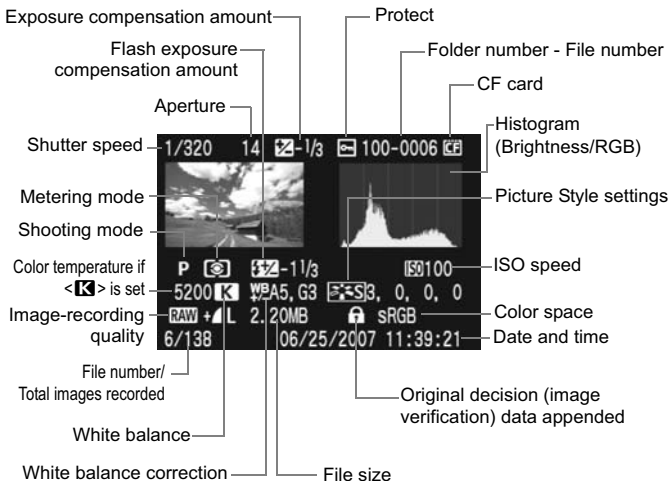

● About the Highlight Alert

When the [] **Highlight alert**] menu is set to **[Enable]**, overexposed highlight areas will blink. To obtain more image detail in the overexposed areas, set the exposure compensation to a negative amount and shoot again.

● About the AF Point Display

When the [] **AF point disp.**] menu is set to **[Enable]**, the AF point which achieved focus will be displayed in red. If automatic AF point selection was used, multiple AF points might be displayed in red.

● About the Histogram

The brightness histogram display shows the exposure level distribution, overall brightness, and gradation. And the RGB histogram display is for checking the color saturation and gradation. The display can be switched with the [ Histogram] menu.

[Brightness] Display

This histogram is a graph showing the distribution of the image's brightness level. The horizontal axis indicates the brightness level (darker on the left and brighter on the right), while the vertical axis indicates how many pixels exist for each brightness level. The more pixels there are toward the left, the darker the image. And the more pixels there are toward the right, the brighter the image. If there are too many pixels on the left, the shadow detail will be lost. And if there are too many pixels on the right, the highlight detail will be lost. The gradation in-between will be reproduced. By checking the image and its brightness histogram, you can see the exposure level inclination and the overall tone reproduction condition.

Sample Histograms



Dark image



Normal image



Bright image

[RGB] Display

This histogram is a graph showing the distribution of the image's brightness level of each primary color (RGB or red, blue, and green). The horizontal axis indicates the color's brightness level (darker on the left and brighter on the right), while the vertical axis indicates how many pixels exist for each color brightness level. The more pixels there are toward the left, the darker and less prominent the color. And the more pixels there are toward the right, the brighter and denser the color. If there are too many pixels on the left, the respective color information will be lacking. And if there are too many pixels on the right, the color will be too saturated with no detail. By checking the image's RGB histogram, you can see the color's saturation and gradation condition and white balance inclination.

Index Display

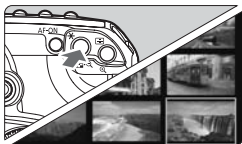

1 Turn on the index display.

- During image playback, press the < [Index] > button.
- ▶ The 4-image index display will appear. The currently-selected image will be highlighted in a blue frame.
- Press the < [Index] > button again to switch to the 9-image index display.



2 Select the image.

- Turn the < [Dial] > dial to move the blue frame.
- To display an image, press the < [OK] > button.

Jump Display

You can skip over images during playback to find the image you want faster.

Browsing Through Images

During image playback, press the < JUMP > button and turn the < [Dial] > dial to select the jump method [**1 image/10 images/100 images/Screen/Date**]. With the index display, you can jump by a single screen by selecting [**Screen**]. To jump by shooting date, select [**Date**].



Jump method
Image location





- During image playback, turn the < [Dial] > dial.
- ▶ The jump display will proceed according to the selected jump method.
- ▶ On the bottom right, the jump method and current image location are indicated.



Magnified View



Magnified area

Magnify the image.



- During image playback, press the  button to magnify the image.
- If you keep pressing the  button, you can magnify the image up to 10x.
- Press the  button to reduce the magnification.
- Use  to scroll around the magnified image.

- You can turn the  or  dial to view another image.
- Magnified view is not possible during the image review immediately after the image is taken.

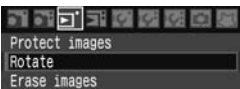
Rotating an Image









1 Select [Rotate].

- Under the  tab, select **[Rotate]**, then press .



2 Select the image to rotate.

- Turn the  or  dial to select the image, then press .
- Each time you press , the image will rotate.
- To rotate another image, repeat the above procedure.
- Press the **<MENU>** button to return to the menu.

- If the rotated image is not displayed in the rotated orientation during image playback, set the **[FY Auto rotate]** menu to **[On  ]**.

MENU Auto Playback

You can playback the CF card's images in an automatic slide show. Each image will be displayed for about 4 sec.

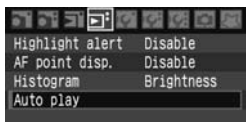

1 Select [Auto play].

- Under the [] tab, select [Auto play], then press <SET>.
- ▶ The auto play screen will appear.

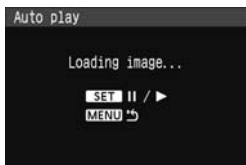

2 Start the auto play.

- ▶ After [Loading image...] is displayed for a few seconds, auto play will start.
- To pause the auto play, press <SET>.
- During pause, [II] will be displayed on the upper left of the image. Press <SET> again to resume the auto play.



3 Stop the auto play.

- To stop the auto play and return to the menu, press the <MENU> button.



- During pause, you can turn the < > dial to view another image.
- During auto play, auto power off will not work.
- The display time may vary depending on the image.

Viewing the Images on TV

By connecting the camera to a TV set with the video cable (provided), you can view the captured images on a TV set. Turn off the camera and the television before connecting them.

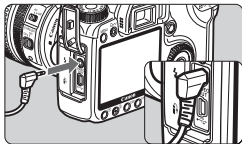

1 Connect the camera to the TV.

- Open the camera's terminal cover.
- Use the video cable (provided) to connect the camera's <VIDEO OUT> video terminal to the TV monitor's VIDEO IN terminal.
- Insert the video cable plugs firmly all the way.

2 Turn on the TV and switch the TV's line input to VIDEO IN.

3 Set the camera's power switch to <ON>.

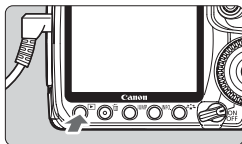

4 Press the <▶> button.

- ▶ The image will appear on the TV screen. (Nothing will be displayed on the camera's LCD monitor.)
- After you finish, set the camera's power switch to <OFF>, turn off the TV, then disconnect the video cable.

- ⚠ ● If the video system format does not match the TV's, the image will not be displayed properly. Set the proper video system format with [F: Video system].
- Do not use any video cable other than the one provided. Images might not be displayed if you use a different video cable.

ⓘ Depending on the TV monitor, part of the image might be cut off.

MENU Protecting Images

This prevents the image from being erased accidentally.



1 Select [Protect images].

- Under the [MENU] tab, select [Protect images], then press <SET>.
- ▶ The protect setting screen will appear.

Image protect



2 Protect the image.

- Turn the <DISP> dial to select the image to be protected, then press <SET>.
- ▶ When an image is protected, the <ON> icon will appear on the screen.
- To cancel the image protection, press <SET> again. The <ON> icon will disappear.
- To protect another image, repeat step 2.
- To exit the image protection, press the <MENU> button. The menu will reappear.



- Once an image is protected, it cannot be erased by the camera's erase function. To erase a protected image, you must first cancel the protection.
- If you erase all the images (p.124), only the protected images will remain. This is convenient when you want to erase unnecessary images all at once.

Erasing Images

You can either select and erase images one by one or erase them in one batch. Protected images (p.123) will not be erased.

- !** Once an image is erased, it cannot be recovered. Make sure you no longer need the image before erasing it. To prevent important images from being erased accidentally, protect them.

Erasing a Single Image

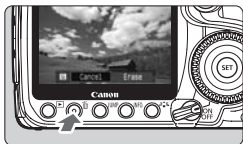

1 Playback the image to be erased.

2 Press the  button.





- The erase menu will appear at the bottom of the screen.



3 Erase the image.

- ▶ Select [Erase], then press . The image displayed will be erased.

MENU Checkmarking Images to be Erased in a Batch

By checkmarking the images to be erased, you can erase multiple images at one time. On the [ Erase images] menu, select [Select and erase images]. With , checkmark  the images to be erased. Then press the  button.

MENU Erasing All Images in the Card

When the [ Erase images] menu is set to [All images on card], all the images in the CF card will be erased.

Changing Image Playback Settings

MENU Setting the LCD Monitor Brightness

You can adjust the brightness of the LCD monitor to make it easier to read.





1 Select [LCD brightness].

- Under the [**Y**] tab, select [**LCD brightness**], then press < **SET** >.



2 Adjust the brightness.

- While referring to the gray chart, turn the <  > dial, then press < **SET** >.

 To check the image's exposure, you should look at the histogram (p.118).

MENU Setting the Image Review Time

How long the image is displayed on the LCD monitor immediately after capture can be set. To keep the image displayed, set [**Hold**]. To not have the image displayed, set [**Off**].

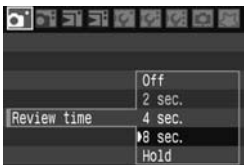

1 Select [Review time].

- Under the [**A**] tab, select [**Review time**], then press < **SET** >.

2 Set the desired review time.

- Turn the <  > dial to select the time, then press < **SET** >.

 If [**Hold**] is set, the image will be displayed until the auto power off time elapses.

MENU Auto Rotate of Vertical Images



Vertical images are rotated automatically so they are displayed vertically on the camera's LCD monitor and personal computer instead of horizontally. The setting of this feature can be changed.

1 Select [Auto rotate].

- Under the [IF] tab, select [Auto rotate], then press <SET>.

2 Set the auto rotate display.

- Turn the <DISP> dial to select the setting, then press <SET>.

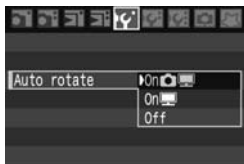

[On

The vertical image is automatically rotated on both the camera's LCD monitor and on the personal computer.

[On

The vertical image is automatically rotated only on the personal computer.

[Off]

The vertical image is not rotated.

! Auto rotate will not work with vertical images captured while Auto rotate was [Off]. They will not rotate even if you later switch it to [On] for playback.

- Immediately after image capture, the vertical image will not be automatically rotated for the image review.
- If the vertical image is taken while the camera is pointed up or down, the image might not rotate automatically for playback.
- If the vertical image is not automatically rotated on the personal computer screen, it means the software you are using is unable to rotate the image. Using the provided software is recommended.

8

Sensor Cleaning

The camera has a Self Cleaning Sensor Unit attached to the sensor's front layer (low-pass filter) to shake off dust automatically.

The Dust Delete Data can also be appended to the image so that the remaining dust spots can be removed automatically by Digital Photo Professional (provided software).

Minimizing Dust

- When changing lenses, do it in a place with minimal dust.
- When storing the camera without a lens attached, be sure to attach the body cap to the camera.
- Remove dust on the body cap before attaching it.



Even while the Self Cleaning Sensor Unit is operating, you can press the shutter button halfway to interrupt the cleaning and start shooting immediately.

MENU Automatic Sensor Cleaning

Whenever you set the power switch to <ON/↗> or <OFF>, the Self Cleaning Sensor Unit operates (approx. 1 sec.) to automatically shake off the dust on the front of the sensor. Normally, you need not be aware of this operation. However, you can execute the sensor cleaning at anytime as well as disable it.

Cleaning the Sensor Now



1 Select [Sensor cleaning].

- Under the [**W**] tab, select [**Sensor cleaning**], then press <SET>.

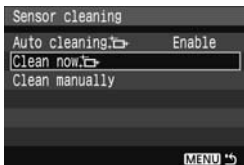

2 Select [Clean now ↗].

- Turn the <◉> dial to select [**Clean now ↗**], then press <SET>.
- Select [**OK**], then press <SET>.
- ▶ The screen will indicate that the sensor is being cleaned. Although there will be a shutter sound, a picture is not taken.

- 
- The user-executed cleaning takes about 2.5 sec. to complete.
 - For best results, do the sensor cleaning while the camera bottom is placed on a table or other surface at a perpendicular angle.
 - Even if you repeat the sensor cleaning multiple times, the result will not improve that much. Right after the sensor cleaning is finished, the [**Clean now ↗**] option will remain disabled temporarily.

Disabling Automatic Sensor Cleaning

- In step 2, select [**Auto cleaning ↗**] and set it to [**Disable**].
- ▶ The sensor cleaning will no longer be executed when you set the power switch to <ON/↗> or <OFF>.

MENU Appending Dust Delete Data★

Normally, the Self Cleaning Sensor Unit will eliminate most of the dust visible on captured images. However, in case visible dust still remains, you can append the Dust Delete Data to the image to later erase the dust spots. The Dust Delete Data is used by Digital Photo Professional (provided software) to erase the dust spots automatically.

Preparation

- Get a solid-white object (paper, etc.).
- Set the lens focal length to 50mm or longer.
- Set the lens focus mode switch to <MF> and set the focus to infinity (∞). If the lens has no distance scale, look at the front of the lens and turn the focusing ring clockwise all the way.

Obtain the Dust Delete Data



1 Select [Dust Delete Data].

- Under the [D] tab, select [Dust Delete Data], then press <SET>.

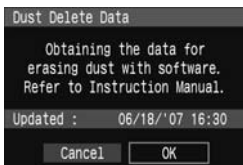

2 Select [OK].

- Turn the <DISP> dial to select [OK], then press <SET>. After the automatic sensor cleaning ends, a message will appear.

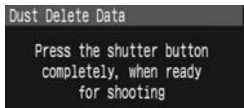
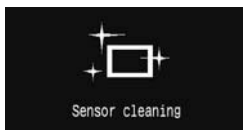

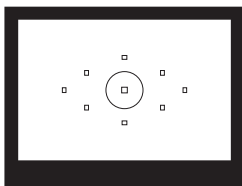

3 Photograph a solid-white object.

- At a distance of 20 - 30 cm / 0.7 - 1.0 feet, fill the viewfinder with a patternless, solid-white object and take a picture.
- ▶ The picture will be taken in the aperture-priority AE mode with an aperture of f/22.
- Since the image will not be saved, the data can still be obtained even if there is no CF card in the camera.
- ▶ When the picture is taken, the data will be obtained. When the data is obtained, a message will appear. Select [OK], and the menu will reappear.
- If the data was not obtained successfully, a message to that effect will appear. Follow the "Preparation" procedure on the preceding page, then select [OK]. Take the picture again.

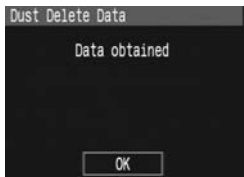

About the Dust Delete Data

After the Dust Delete Data is obtained, it is appended to all the JPEG, RAW, and sRAW images captured thereafter. Before an important shoot, you should update the Dust Delete Data by obtaining it again. For erasing dust spots automatically with the bundled software, see the Software Instruction Manual in the CD-ROM.

The Dust Delete Data appended to the image is so small that it hardly affects the image file size.

! Be sure to use a solid-white object such as a white piece of paper. If the paper has any pattern or design, it may be recognized as dust data and affect the accuracy of the dust deletion with the software.

MENU Manual Sensor Cleaning [★]

Dust which could not be removed by the automatic sensor cleaning can be removed manually with a blower, etc.

The surface of the image sensor is extremely delicate. If the sensor needs to be cleaned directly, having it done by a Canon Service Center is recommended.

Before cleaning the sensor, detach the lens from the camera.

1 Select [Sensor cleaning].

- Under the [I/F] tab, select [Sensor cleaning], then press <SET>.

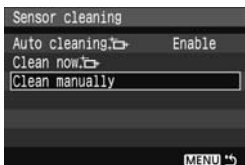

2 Select [Clean manually].

- Turn the <DIAL> to select [Clean manually], then press <SET>.

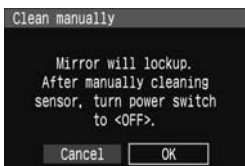

3 Select [OK].

- Turn the <DIAL> to select [OK], then press <SET>.
- ▶ In a moment, the mirror will lockup and the shutter will open.
- "CLEAN" will blink on the LCD panel.

4 End the cleaning.

- Set the power switch to <OFF>.



- For the power source, using the AC Adapter Kit ACK-E2 (sold separately) is recommended.
- If you use a battery, make sure it is fully recharged. If a battery grip with size-AA batteries is attached, manual sensor cleaning will not be possible.



- **While cleaning the sensor, never do any of the following. If the power is cut off, the shutter will close and the shutter curtains and image sensor might get damaged.**
 - **Setting the power switch to <OFF>.**
 - **Opening the battery compartment cover.**
 - **Opening the CF card slot cover.**
- The surface of the image sensor is extremely delicate. Clean the sensor with care.
- Use a plain blower without any brush attached. A brush can scratch the sensor.
- Do not insert the blower tip inside the camera beyond the lens mount. If the power is turned off, the shutter will close and the shutter curtains or reflex mirror might get damaged.
- Never use canned air or gas to clean the sensor. The blowing force can damage the sensor or the spray gas can freeze on the sensor.

9

Direct Printing from the Camera/ Digital Print Order Format

You can connect the camera directly to a printer and print out the images in the CF card.

The camera is compatible with “PictBridge” which is the standard for direct printing.

You can also preselect images in the CF card for printing. (p.143)

About DPOF

DPOF (Digital Print Order Format) is a standard for recording printing instructions (image selections, quantity to print, etc.) in the CF card. In this way, you can print multiple pictures in one batch or give the print order to a photofinisher.

Canon's PictBridge Web Site

The Web site below gives more information on using your Canon camera with various printers, such as which paper types to use.

<http://canon.com/pictbridge/>

Preparing to Print

You do the direct printing procedure entirely with your camera while you look at the LCD monitor.

Connecting the Camera to a Printer

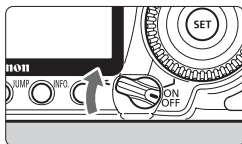

1 Set the camera's power switch to <OFF>.

2 Set up the printer.

- For details, see the printer's instruction manual.

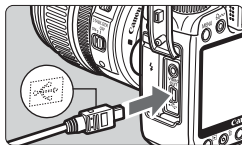

3 Connect the camera to the printer.

- Use the interface cable that came with the camera.
- When connecting the cable plug to the camera's <↔> terminal, the cable plug's <↔> icon must face the front side of the camera.
- To connect to the printer, refer to the printer's instruction manual.

4 Turn on the printer.

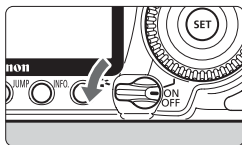

5 Set the camera's power switch to <ON>.

- ▶ Some printers may make a beeping sound.

PictBridge



6 Playback the image.

- Press the <▶> button.
- ▶ The image will appear, and the <📷> icon will appear on the upper left to indicate that the camera is connected to a printer.
- ▶ The <📷> button lamp will light in blue.



- The camera cannot be used with printers compatible only with CP Direct or Bubble Jet Direct.
- When connecting the camera to the printer, do not use any cable other than the interface cable provided.
- If there is a long beeping sound in step 5, it indicates a problem with the printer. To find out what's wrong, do the following:
Press the <▶> button to playback the image and follow the steps below.
 1. Press <SET>.
 2. On the print setting screen, select **[Print]**.
 The error message will be displayed on the LCD monitor. (p.142)



- You can also print RAW and sRAW images taken by this camera.
- If you use a battery to power the camera, make sure it is fully charged. With a fully charged battery, printing up to about 7 hours is possible.
- Before disconnecting the cable, turn off the camera and printer first. Pull out the cable while holding the plug, not the cord.
- For direct printing, using AC Adapter Kit ACK-E2 (sold separately) to power the camera is recommended.



Printing

The screen display and setting options will differ depending on the printer. Some settings might not be available. For details, see the printer's instruction manual.

Printer-connected icon



1 Select the image to be printed.

- Check that the <  > icon is displayed on the upper left of the LCD monitor.
- Turn the <  > dial to select the image to be printed.

2 Press < SET >.

- ▶ The print setting screen will appear.

Print setting screen

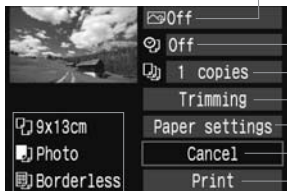

— Sets the printing effects. (p.138)

— Sets the date or file number imprinting to on or off.

— Sets the quantity to be printed.

— Sets the trimming. (p.141)

— Sets the paper size, type, and layout.

— Returns to step 1.

— Starts the printing.

The paper size, type, and layout you have set will be displayed.

* Depending on the type of printer, settings such as the date and file number imprinting and trimming might not be available.

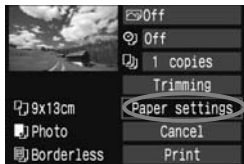

3 Select [Paper settings].

- Turn the <  > dial to select [Paper settings], then press < SET >.
- ▶ The paper settings screen will appear.

Setting the Paper Size



- Turn the <⊙> dial to select the size of the paper loaded in the printer, then press <SET>.
- ▶ The paper type screen will appear.

Setting the Paper Type

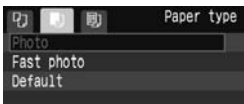

- Turn the <⊙> dial to select the type of the paper loaded in the printer, then press <SET>.
- When using a Canon printer and Canon paper, read the printer's instruction manual to check what paper types can be used.
- ▶ The page layout screen will appear.

Setting the Page Layout



- Turn the <⊙> dial to select the page layout, then press <SET>.
- ▶ The print setting screen will reappear.

Bordered	The print will have a white border along the edges.
Borderless	The print will have no white borders. If your printer cannot print borderless prints, the print will have borders.
Bordered 	The shooting information* will be imprinted on the border on 9x13cm and larger prints.
xx-up	Option to print 2, 4, 8, 9, 16, or 20 images on one sheet.
20-up 35-up 	On A4 or Letter size paper, 20 or 35 thumbnails of the images ordered through DPOF will be printed. <ul style="list-style-type: none"> • [20-up] will have the shooting information* printed on the side of each thumbnail and the file number and date** printed on the bottom of each thumbnail image. • [35-up] will have the file number and date** printed on the bottom of the thumbnail images.
Default	With a Canon printer, the print will be borderless.

* From the Exif data, the camera name, lens name, shooting mode, shutter speed, aperture, exposure compensation amount, ISO speed, white balance, etc., will be imprinted.

** This depends on the <Q> date/file number imprinting option set in step 5 (p.139).



4 Set the printing effects.

- Set as necessary.
- Turn the < [On/Off] > dial to select the item on the upper right, then press < [SET] >.
- If the < [INFO] > icon is displayed next to < [INFO] >, the printing effects can also be adjusted. (p.140)
- Next, turn the < [On/Off] > dial to select the desired printing effect, then press < [SET] >.

Item	Description
Off	Same as the printing characteristics turned "On". No automatic correction will be performed.
On	The image will be printed according to the printer's standard colors. The image's Exif data is used to make automatic corrections.
Vivid	The image will be printed with higher saturation to produce more vivid blues and greens.
NR	The image noise is reduced before printing.
B/W B/W	Prints in black-and-white with true blacks.
B/W Cool tone	Prints in black-and-white with cool, bluish blacks.
B/W Warm tone	Prints in black-and-white with warm, yellowish blacks.
Natural	Prints the image in the actual colors and contrast. No automatic color adjustments will be applied.
Natural M	The printing characteristics are the same as the "Natural" setting. However, this setting enables finer printing adjustments than with "Natural."
Default	The printing will differ depending on the printer. For details, see the printer's instruction manual.

* The screen display may differ depending on the printer.

* When the printing effects are changed, the changes will be reflected on the screen. However, the actual result of the printing effects might look different from what you see on screen. The screen only shows an approximate rendition. This also applies to [Brightness] and [Adjust levels] on page 140.



5 Set the date and file number imprinting.

- Set as necessary.
- Turn the <⊙> dial to select <Ⓞ>, then press <Ⓢ>.
- Turn the <⊙> dial to select the desired setting, then press <Ⓢ>.

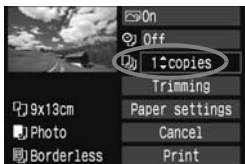

6 Set the number of copies.

- Set as necessary.
- Turn the <⊙> dial to select <Ⓞ>, then press <Ⓢ>.
- Turn the <⊙> dial to select the number of copies, then press <Ⓢ>.



7 Start printing.

- Turn the <⊙> dial to select [**Print**], then press <Ⓢ>.
- ▶ The <Ⓢ> button's blue lamp will blink and the printing will start.



- To print another image with the same settings, select the image and just press the <Ⓢ> button lit in blue. Trimming will not be applied to 1-copy printing.
- The [**Default**] setting for printing effects and other options are the printer's own default settings as set by the printer's manufacturer. See the printer's instruction manual to find out what the [**Default**] settings are.
- Depending on the image's file size and image-recording quality, it may take some time for the printing to start after you select [**Print**].
- If you did "Adjusting the rotation angle" (p.141), the printing time may take longer.
- To stop the printing, press <Ⓢ> while [**Stop**] is displayed, then select [**OK**].

Adjustment of Printing Effects

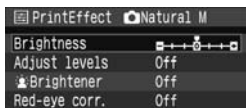
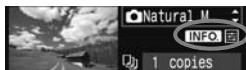



In step 4 on page 138, select the printing effect. When the  icon is displayed next to **<INFO.>**, press the **<INFO.>** button. You can then adjust the printing effect. What can be adjusted or what is displayed will depend on the selection made in step 4.

● Brightness

The image brightness can be adjusted.

● Adjust levels

When you select **[Manual]**, you can change the histogram's distribution and adjust the image's brightness and contrast.

With the adjust levels screen displayed, press the **<INFO.>** button to change the position of the . Turn the  dial to freely adjust the shadow level (0 - 127) or highlight level (128 - 255).

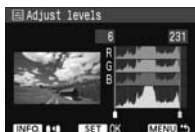

● Brightener

Effective in backlit conditions which can make the subject's face look dark. When **[On]** is set, the face will be brightened for printing.

● Red-eye corr.

Effective in flash images where the subject has red eye. When **[On]** is set, the red eye will be corrected for printing.

- The  **Brightener** and **[Red-eye corr.]** effects will not show up on the screen.
- When you select **[Detail set.]**, you can adjust the **[Contrast]**, **[Saturation]**, **[Color tone]**, and **[Color balance]**. To adjust the **[Color balance]**, use **<◀▶>**. B is for blue, A is amber, M is magenta, and G is green. The color in the respective direction will be corrected.
- When you select **[Clear all]**, all the printing effect settings will be reverted to the default.

Trimming the Image



You can crop the image and print only the trimmed portion as if the image was recomposed. **Do the trimming right before printing.** If you set the trimming and then set the print settings, you may have to set the trimming again.

1 On the print setting screen, select [Trimming].

2 Set the trimming frame size, position, and proportion.

- The image area within the trimming frame will be printed. The shape of the trimming frame can be changed with **[Paper settings]**.

Changing the trimming frame size

When you press the $\langle \text{Q} \rangle$ or $\langle \text{Q} \rangle$ button, the size of the trimming frame will change. The smaller the trimming frame, the larger the image magnification will be for the printing.

Moving the trimming frame

Use $\langle \text{Q} \rangle$ to move the frame over the image vertically or horizontally. Move the trimming frame until it shows the desired image area or composition.

Rotating the frame

Each time you press the $\langle \text{INFO} \rangle$ button, the trimming frame will toggle between the vertical and horizontal orientations. This enables you to create a vertical-oriented print from a horizontal image.

Adjusting the rotation angle

By turning the $\langle \text{Q} \rangle$ dial, you can adjust the angle of the image rotation by ± 10 degrees in 0.5-degree increments. After rotation, $\langle \text{Q} \rangle$ will change to blue.

3 Press $\langle \text{SET} \rangle$ to exit the trimming.

- ▶ The print setting screen will reappear.
- You can check the trimmed image area on the upper left of the print setting screen.

- Depending on the printer, the trimmed image area might not be printed as you specified.
- The smaller you make the trimming frame, the grainier the picture will look on the print. If the picture will be too grainy, the trimming frame will turn red.
- While trimming the image, look at the camera's LCD monitor. If you look at the image on a TV screen, the trimming frame might not be displayed accurately.



Handling Printer Errors

If you resolve a printer error (no ink, no paper, etc.) and select **[Continue]** to resume printing but it does not resume, operate the buttons on the printer to resume printing. For details, see the printer's instruction manual.

Error Messages

If a problem occurs during printing, an error message will appear on the camera's LCD monitor. Press **<SET>** to stop printing. After resolving the problem, resume printing. For details on how to resolve a printing problem, refer to the printer's instruction manual.

Paper error:

Check whether the paper is properly loaded in the printer.

Ink error:

Check the printer's ink level, and check the waste ink tank.

Hardware error:

Check for any printer problems other than paper and ink problems.

File error:

The selected image cannot be printed via PictBridge. Images taken with a different camera or images edited with a computer might not be printable.

Digital Print Order Format (DPOF)

Set the print type, date imprinting, and file No. imprinting. The print settings will be applied to all print-ordered images. (They cannot be set individually for each image.)

Setting the Printing Options



1 Select [Print order].

- ▶ Under the [] tab, select [Print order], then press <SET>.

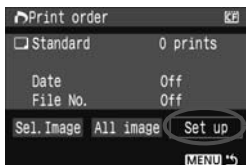

2 Select [Set up].

- Turn the <DIAL> to select [Set up], then press <SET>.

3 Set the options as desired.

- Set the [Print type], [Date], and [File No.].
- Turn the <DIAL> to select the option, then press <SET>.
- Turn the <DIAL> to select the desired setting, then press <SET>.

[Print type]

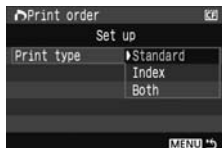



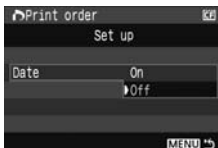

[Date]

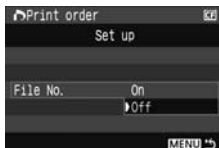

[File No.]



Print type		Standard	Prints one image on one sheet.
		Index	Multiple, thumbnail images are printed on one sheet.
	 	Both	Prints both the standard and index prints.
Date	On	[On] imprints the recorded date on the print.	
	Off		
File No.	On	[On] imprints the file No. on the print.	
	Off		

4 Exit the setting.

- Press the <MENU> button.
- ▶ The print order screen will reappear.
- Next, select [**Sel.Image**] or [**All image**] to order the images to be printed.

- 
- Even if [**Date**] and [**File No.**] are set to [**On**], the date or file No. might not be imprinted depending on the print type setting and printer model.
 - When printing with DPOF, you must use the CF card whose print order specifications have been set. It will not work if you just extract images from the CF card and try to print them.
 - Certain DPOF-compatible printers and photofinishers might not be able to print the images as you specified. If this happens with your printer, refer to the printer's instruction manual. Or check with your photofinisher about compatibility when ordering prints.
 - Do not insert into the camera a CF card whose print order was set by a different camera and then try to specify a print order. The print order may not work or may be overwritten. Also, depending on the image type, the print order may not be possible.

- 
- RAW and sRAW images cannot be selected for print orders.
 - With [**Index**] prints, both the [**Date**] and [**File No.**] cannot be set to [**On**] at the same time.

Print Ordering

Sel. Image

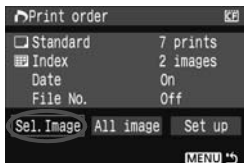

Select and order images one by one. Press the $\langle \text{Sel. Image} \rangle$ button to display the three-image view. To return to the single-image display, press the $\langle \text{Sel. Image} \rangle$ button. After completing the print order, press the $\langle \text{MENU} \rangle$ button to save the print order to the CF card.



[Standard] [Both]

Press $\langle \text{SET} \rangle$ and a print order for 1 copy of the displayed image will be placed. Then turn the $\langle \text{Dial} \rangle$ dial to set the number of copies (up to 99) to be printed for that image.



[Index]

Press $\langle \text{SET} \rangle$, and the displayed image will be included in the index print. The $\langle \checkmark \rangle$ icon will also appear on the upper left.

All image

The print order for 1 copy of all the images in the CF card will be placed. If you select Clear all, the print order for all the images in the card will be canceled.



- Note that RAW and sRAW images will not be included in the print order even when you set "All image."
- When using a PictBridge printer, print no more than 400 images for one print order. If you specify more than this, all the images might not be printed.

Direct Printing with DPOF

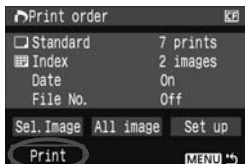

With a PictBridge printer, you can easily print images with DPOF.

1 Prepare to print.

- See page 134.
Follow the “Connecting the Camera to a Printer” procedure up to step 5.

2 Under the [] tab, select [Print order].

3 Select [Print].

- [Print] will be displayed only if the camera is connected to the printer and printing is possible.

4 Set the [Paper settings]. (p.136)

- Set the printing effects (p.138) as necessary.

5 Select [OK].

- Before printing, be sure to set the paper size.
- Certain printers cannot imprint the file No.
- If [Bordered] is set, the date might be imprinted on the border, depending on the printer.
- Depending on the printer, the date might look light if it is imprinted on a bright background or on the border.

- Under [Adjust levels], [Manual] cannot be selected.
- If you stopped the printing and want to resume printing the remaining images, select [Resume]. Note that printing will not resume if you stop the printing and any of the following occurs:
 - Before resuming, you changed the print order or erased any images selected for the print order. For index printing, you changed the paper settings before resuming the printing. Or the CF card's remaining space was small when the printing was stopped.
- If a problem occurs during printing, see page 142.

10

Transferring Images to a Personal Computer

You can use the camera to select images in the CF card and transfer them directly to a personal computer.

If the computer software (EOS DIGITAL Solution Disk CD-ROM) provided with the camera has been installed in your personal computer, you can easily transfer the images without operating the personal computer.

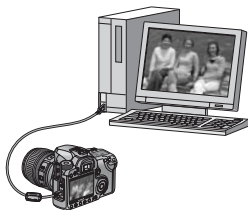

- For instructions to install the provided software, see the separate sheet, "CD-ROM Guide."
- If you want to operate the personal computer to transfer the images from the camera, see the "Software Instruction Manual" in the CD-ROM.

Transferring Images to a Personal Computer ■

-  Before connecting the camera to the personal computer, be sure to first install the EOS DIGITAL Solution Disk software (in the CD-ROM provided with the camera) in the personal computer.

Preparation for Image Transfer

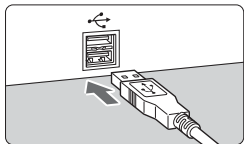
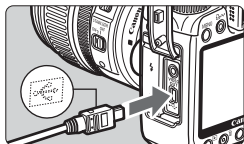



1 Connect the camera to the personal computer.

- Turn off the camera and use the interface cable that came with the camera.
- When connecting the cable plug to the camera's <↔> terminal, the cable plug's <↔> icon must face the front side of the camera.
- To the personal computer's USB port, connect the plug on other end of the cable.

2 Set the camera's power switch to <ON>.

- When the program selection screen appears on the personal computer, select **[EOS Utility]**.
When the camera model selection screen appears, select your camera's model.
- ▶ The **[EOS Utility]** screen will appear on the computer, and the direct transfer screen will appear on the camera's LCD monitor.

-  Shooting will be disabled while the direct transfer screen is displayed.

-  ● If the **[EOS Utility]** screen does not appear, see "Software Instruction Manual" in the CD-ROM.
- Before disconnecting the cable, turn off the camera first and pull out the cable by grasping the plug (instead of the cord).

Transferring Images to a Personal Computer

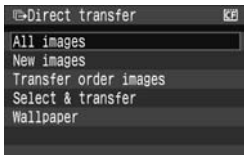

The images transferred to the personal computer will be organized according to the shooting date and saved in the **[My Pictures]** folder for Windows or the **[Pictures]** folder in the Macintosh.

Select the desired option, then press the **< [] >** button. The button's blue lamp will blink and the image transfer will begin.

When the image transfer is completed, the blue lamp will stay lit. You can also press **< (SET) >** instead of the **< [] >** button to start the image transfer.

- **All images**

All the images in the CF card will be transferred.

- **New images**

Images which have not yet been transferred to the personal computer will be selected by the camera automatically and transferred.

- **Transfer order images**

You select the images and they are transferred to the personal computer in a batch. (p.150)

- **Select & transfer**



You select the images individually to be transferred. To exit, press the **< MENU >** button.

- **Wallpaper**

The image you select and transfer will appear as the personal computer's wallpaper. To exit, press the **< MENU >** button.



- During the image transfer, do not disconnect the interface cable.
- RAW and sRAW images cannot be transferred as wallpaper.

MENU Selecting the Images to be Transferred

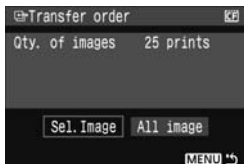

Under the [] tab, you can use [Transfer order] to select the images to be transferred to a personal computer. When you select [Transfer order images] on the preceding page, you can transfer the images set by the transfer order.

● Sel. Image



Select and order images one by one. Press <SET> to include the displayed image in the transfer order. The <✓> icon will also appear on the upper left. After completing the transfer order, press the <MENU> button to save the transfer order to the CF card.

● All image

When you select Mark all, all the images in the CF card will be included in the transfer order. If you select Clear all, the transfer order for all the images in the card will be canceled.

⚠ Do not put into the camera any images whose transfer order was set by a different camera and then try to specify another transfer order. The images in the transfer order might all be overwritten. Also, depending on the image type, the transfer order may not be possible.

- For the transfer order, if you select an image captured as RAW+JPEG or sRAW+JPEG, it will be counted as one image. During the direct image transfer, both the RAW/sRAW and JPEG images will be transferred to the personal computer.
- If you want to transfer more than 999 images in one batch, select [All image] on the direct transfer screen.

11

Customizing the Camera

With Custom Functions, you can change the camera functions according to your preference. Also, the current camera settings can be saved under the Mode Dial's <C1>, <C2>, and <C3> positions. The functions explained in this chapter apply to Creative Zone modes.

MENU Setting Custom Functions ★

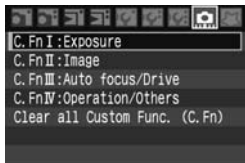

1 Select [Fn].

- Turn the <Fn> dial to select the [Fn] tab.

2 Select the group.

- Turn the <Fn> dial to select C.Fn I - IV, then press <SET>.

Custom Function No.

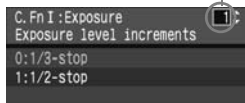

3 Select the Custom Function No.

- Turn the <Fn> dial to select the Custom Function No., then press <SET>.

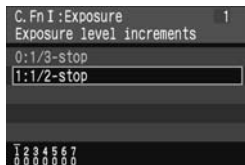

4 Change the setting as desired.

- Turn the <Fn> dial to select the setting (number), then press <SET>.
- Repeat steps 2 to 4 if you want to set other Custom Functions.
- At the bottom of the screen, the current Custom Function settings are indicated below the respective numbers.

5 Exit the setting.

- Press the <MENU> button.
- ▶ The screen for step 2 will reappear.

Clearing All Custom Functions

In step 2, select [Clear all Custom Func. (C.Fn)] to clear all the Custom Function settings.

Even after all the Custom Functions are cleared, the setting for C.Fn IV -5 [Focusing Screen] will remain intact.

Custom Functions

C.Fn I: Exposure

1	Exposure level increments
2	ISO speed setting increments
3	ISO expansion
4	Bracketing auto cancel
5	Bracketing sequence
6	Safety shift
7	Flash sync. speed in Av mode

C.Fn II: Image

1	Long exposure noise reduction
2	High ISO speed noise reduction
3	Highlight tone priority

C.Fn III: Auto focus/Drive

1	Lens drive when AF impossible
2	Lens AF stop button function
3	AF point selection method
4	Superimposed display
5	AF-assist beam firing
6	AF during Live View shooting
7	Mirror lockup

C.Fn IV: Operation/Others

1	Shutter button/AF-ON button
2	AF-ON/AE lock button switch
3	SET button when shooting
4	Dial direction during Tv/Av
5	Focusing Screen
6	Add original decision data
7	Live View exposure simulation



The Custom Functions whose numbers are shaded do not function during Live View shooting. (Settings are disabled.) With C.Fn III -2, only 2 and 5 will be effective.

MENU Custom Function Settings [★]

Custom Functions are organized into four groups based on the function type: C.Fn I: Exposure, C.Fn II: Image, C.Fn III: Auto focus/Drive, C.Fn IV: Operation/Others.

C.Fn I: Exposure

C.Fn I -1 Exposure level increments

0: 1/3-stop

1: 1/2-stop

Sets 1/2-stop increments for the shutter speed, aperture, exposure compensation, AEB, etc. Effective when you prefer to control the exposure in less fine increments than 1/3-stop increments.

 The exposure level will be displayed in the viewfinder and on the LCD panel as shown below.



C.Fn I -2 ISO speed setting increments

0: 1/3-stop

1: 1-stop

C.Fn I -3 ISO expansion

0: Off

1: On

For the ISO speed, "H" (equivalent to ISO 3200) will be selectable.

C.Fn I -4 Bracketing auto cancel**0: On**

The AEB and WB-BKT settings will be canceled if you set the power switch to <OFF> or clear the camera settings. AEB will also be canceled when the flash is ready to fire.

1: Off

The AEB and WB-BKT settings will be retained even when the power switch is set to <OFF>. (When the flash is ready, AEB will be canceled. However, the AEB amount will be retained in memory.)

C.Fn I -5 Bracketing sequence

The AEB shooting sequence and white balance bracketing sequence can be changed.

0: 0, -, +**1: -, 0, +**

AEB	WB Bracketing	
	B/A Direction	M/G Direction
0 : Standard exposure	0 : Standard white balance	0 : Standard white balance
- : Decreased exposure	- : More blue	- : More magenta
+ : Increased exposure	+ : More amber	+ : More green

C.Fn I -6 Safety shift**0: Disable****1: Enable (Tv/Av)**

This works in the shutter-priority AE (Tv) and aperture-priority AE (Av) modes. If the subject's brightness changes suddenly and the current shutter speed or aperture becomes unsuitable, the shutter speed or aperture is shifted automatically to obtain a suitable exposure.

C.Fn I -7 Flash sync. speed in Av mode**0: Auto****1: 1/250 sec. (fixed)**

Locks the flash sync speed to 1/250 sec. in the aperture-priority AE mode. (Against dark backgrounds such as the night sky, the subject's background will look dark.)

C.Fn II: Image

C.Fn II -1 Long exposure noise reduction

0: Off

1: Auto

For 1 sec. or longer exposures, noise reduction is performed automatically if noise typical of long exposures is detected. This **[Auto]** setting is effective in most cases.

2: On

Noise reduction is performed for all exposures 1 sec. or longer. The **[On]** setting may be effective for noise that cannot be detected or reduced with the **[Auto]** setting.

 With setting 2, if a long exposure is made during Live View shooting, the LCD monitor will not display anything (no Live View image display) while noise reduction is applied. During the noise reduction process, shooting is possible. However, you will not be able to see anything on the LCD monitor and in the viewfinder. Since you cannot check the focus and picture composition, shooting is not recommended during the noise reduction process.

 With setting 1 and 2, after the picture is taken, the noise reduction process may take the same amount of time as the exposure. During the noise reduction, shooting is still possible as long as the maximum burst indicator in the viewfinder shows "1" or higher.

C.Fn II -2 High ISO speed noise reduction

0: Off

1: On

Reduces the noise generated in the image. Although noise reduction is applied at all ISO speeds, it is particularly effective at high ISO speeds. At low ISO speeds, the noise in the shadow areas is further reduced.

 With setting 1, the maximum burst for continuous shooting will greatly decrease.

C.Fn II -3 Highlight tone priority

0: Disable

1: Enable

Improves the highlight detail. The dynamic range is expanded from the standard 18% gray to bright highlights. The gradation between the grays and highlights becomes smoother.



With setting 1, noise in the shadow areas may be slightly more than usual.



With setting 1, the settable ISO speed range will be 200 - 1600.

Also, the ISO speed displayed on the LCD panel and in the viewfinder, will have the "0" displayed as a smaller character such as "200". When the image's shooting information (p.117) is displayed, the ISO speed's "0" will also be displayed as a smaller character.

C.Fn III: Auto focus/Drive

C.Fn III -1 Lens drive when AF impossible

If autofocus is executed, but focus cannot be achieved, the camera can either keep trying to focus or stop.

0: Focus search on

1: Focus search off

Prevents the camera from becoming grossly out of focus as it attempts to focus again. Especially convenient with super telephoto lenses which can become extremely out of focus.

C.Fn III -2 Lens AF stop button function**0: AF stop****1: AF start**

AF operates only while the button is pressed. While the button is pressed, AF operation with the camera is disabled.

2: AE lock

When the button is pressed, AE lock is applied. Convenient when you want to focus and meter at different parts of the picture.

3: AF point: M → Auto/Auto → center

In the manual AF point selection mode, the button instantly switches to automatic AF point selection only while you hold it down. Convenient when you are no longer able to focus track a moving subject with a manually-selected AF point in the AI Servo AF mode.

In the automatic AF point selection mode, the button selects the center AF point only while you hold it down.

4: ONE SHOT ↔ AI SERVO

In the One-Shot AF mode, the camera switches to AI Servo AF mode only while you hold down the button. And in the AI Servo AF mode, the camera switches to One-Shot AF mode only while you hold down the button.

Convenient when you need to keep switching between One-Shot AF and AI Servo AF for a subject which keeps moving and stopping.

5: IS start



With the lens' IS switch already <ON>, the Image Stabilizer operates when you press the button.





- The AF stop button is provided only on super telephoto IS lenses.
- With setting 5, the Image Stabilizer will not operate when you press the shutter button halfway.

C.Fn III -3 AF point selection method





0: Normal

Press the  button and use  to select the AF point.

1: Multi-controller direct

Without pressing the  button first, you can just use the  to select the desired AF point. Pressing the  button will set it to automatic AF point selection.

2: Quick Control Dial direct

Without pressing the  button first, you can just use the  to select the desired AF point. By holding down the  button and turning the  dial, you can set the exposure compensation.

C.Fn III -4 Superimposed display

0: On

1: Off

The AF point in the viewfinder will not flash in red. Recommended when it is bothersome to see it light up.

The AF point will still light when you select it.

C.Fn III -5 AF-assist beam firing

The AF-assist beam can be emitted by the camera's built-in flash or by the external, EOS-dedicated Speedlite.

0: Enable

1: Disable

AF-assist beam not emitted.

2: Only external flash emits

If an external, EOS-dedicated Speedlite is attached, it will emit the AF-assist beam when necessary. The camera's built-in flash will not emit the AF-assist beam.



If the external, EOS-dedicated Speedlite's **[AF-assist beam firing]** Custom Function is set to **[Disabled]**, the Speedlite will not emit the AF-assist beam even if the camera's C.Fn III -5-0/2 is set.

C.Fn III -6 AF during Live View shooting

0: Disable

1: Enable

During Live View shooting, you can interrupt the Live View image display and focus for as long as you hold down the <AF-ON> button.

C.Fn III -7 Mirror lockup

Prevents camera vibrations caused by the reflex mirror action which can disturb shooting with super telephoto lenses or close-up shooting. See page 98 for the mirror lockup procedure.

0: Disable

1: Enable

C.Fn IV: Operation/Others

C.Fn IV -1 Shutter button/AF-ON button

0: Metering + AF start

1: Metering + AF start/AF stop

During autofocusing, you can press the <AF-ON> button to stop the autofocusing.

2: Metering start/Metering + AF start

This is useful for subjects which keep moving and stopping repeatedly. In the AI Servo AF mode, you can press the <AF-ON> button to repeatedly start or stop the AI Servo AF operation. The exposure is set at the moment the picture is taken. Thus, the optimum focusing and exposure will always be achieved as you wait for the decisive moment.

3: AE lock/Metering + AF start

Convenient when you want to focus and meter at different parts of the picture. Press the <AF-ON> button to meter and autofocus, and press the shutter button halfway to attain AE lock.

4: Metering + AF start / disable

The <AF-ON> button will not function.

C.Fn IV -2 AF-ON/AE lock button switch

0: Disable

1: Enable

The functions of the <AF-ON> and <*/Q> buttons will be switched with each other's function.



When set to 1, press the <AF-ON> button to display the image index or to reduce the image display.

C.Fn IV -3 SET button when shooting

You can assign a frequently-used function to <SET>. When the camera is ready to shoot, you can press <SET>.

0: Normal (disabled)

1: Change quality

After pressing <SET>, look at the LCD panel and turn the <DISP> dial to set the image-recording quality directly.

2: Change Picture Style

Press <SET> to display the Picture Style selection screen on the LCD monitor. Turn the <DISP> dial to select a style, then press <SET>.

3: Menu display

Gives the same function as the <MENU> button.

4: Image replay

Gives the same function as the <▶> button.



If the [Live View shoot.] menu has been set to [Enable], the Live View shooting will override any setting from 1 to 4 above. Pressing <SET> will show the Live View image instead.

C.Fn IV -4 Dial direction during Tv/Av

0: Normal

1: Reverse direction

The dial's turning direction for setting the shutter speed and aperture can be reversed.

In the manual exposure mode, the direction of the <DISP> and <DISP> dials will be reversed. In other shooting modes, the <DISP> dial will be reversed. The direction of the <DISP> dial will be the same in the manual exposure mode and for setting exposure compensation.

C.Fn IV -5 Focusing Screen

The camera provides interchangeable focusing screens. This Custom Function must be set so that the exposure correction matches the respective focusing screen.

0: Ef-A

1: Ef-D

2: Ef-S

About focusing screen characteristics

Ef-A: Standard Precision Matte

Standard focusing screen that comes with the camera. Provides good viewfinder brightness and enables easy manual focusing.

Ef-D: Precision Matte with grid

This is the Ef-A with a grid. It makes it easier to align horizontal or vertical lines.

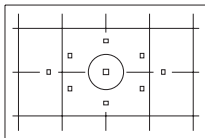

Ef-S: Super Precision Matte

Focusing screen which makes manual focusing easier than with the Ef-A. Effective for users who mainly focus manually.

About Super Precision Matte Ef-S and Maximum Lens Aperture

- This is optimized for $f/2.8$ and faster lenses.
- If the lens is slower than $f/2.8$, the viewfinder will look darker than with Ef-A.

- Since the standard Ef-A focusing screen comes with the EOS 40D, C.Fn IV -5-0 is already set.
- To change the focusing screen, refer to the instructions that came with the focusing screen.
- The C.Fn IV -5 setting is not included in the registered camera user settings (p.165).

C.Fn IV -6 Add original decision data

0: Off

1: On

Data for verifying whether the image is original or not is appended to the image automatically. When the shooting information of an image appended with the verification data is displayed (p.117), the <  > icon will appear.

To verify whether the image is original, the Original Data Security Kit OSK-E3 (sold separately) is required.

C.Fn IV -7 Live View exposure simulation

0: Disable (LCD auto adjust)

1: Enable (simulates exposure)

During Live View shooting, the real-time image shows the brightness corresponding to the exposure setting. This enables you to check the image's exposure right before you take the picture.



- When you press the depth-of-field preview button, the simulated exposure is displayed regardless of the C.Fn IV -7 setting. Note that in low light or bright light, the picture's exposure simulation might not be displayed according to the exposure setting.
- Even if 1 is set, the exposure simulation will not be displayed when flash is used nor during bulb exposures.

MENU Registering My Menu ★

For faster access, you can register up to six menus and Custom Functions which you change frequently.

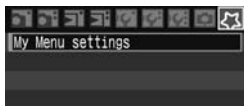

- 1 **Select [My Menu settings].**
 - Under the [] tab, select **[My Menu settings]**, then press <SET>.

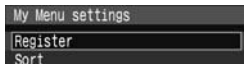

- 2 **Select [Register].**
 - Turn the < > dial to select **[Register]**, then press <SET>.

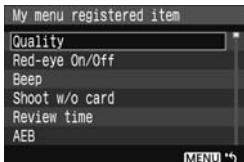

- 3 **Register the desired items.**
 - Turn the < > dial to select an item, then press <SET>.
 - When the confirmation dialog appears and you select **[OK]** and press <SET>, the item will be registered.
 - Repeat this procedure to register up to six items.
 - To return to the screen in step 2, press the <MENU> button.

My Menu settings

[Sort] and other settings displayed in step 2 are as follows:

- **Sort**

You can change the order of the registered items in My Menu. Select **[Sort]** and select the menu whose order you want to change. Then press <SET>. With [] displayed, turn < > to change the order, then press <SET>.

- **Display from My Menu**

When **[Enable]** is set, the [] tab will be displayed first when you display the menu.

- **Delete and Delete all items**

Deletes the registered menu items. **[Delete]** deletes one menu item, and **[Delete all items]** deletes all menu items.

MENU Register Camera User Settings [★]

Under the Mode Dial's <C1>, <C2>, and <C3> positions, you can register most of the current camera settings containing your preferred shooting mode, menus, Custom Function settings, etc.



1 Select [Camera user setting].

- Under the [My:] tab, select [Camera user setting], then press <SET>.

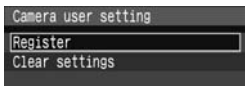

2 Select [Register].

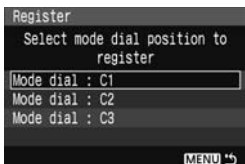

3 Register the camera user setting.

- Turn the <DIAL> dial to select the Mode Dial position where the camera settings will be registered, then press <SET>.
- When the confirmation dialog appears, select [OK] and press <SET>.
- ▶ The current camera settings will be registered under the Mode Dial's C* position.

About [Clear settings]

In step 2, if you select [Clear settings], the respective Mode Dial position will revert to default setting effective before you registered the camera settings. The procedure is the same as step 3.



- The My Menu settings will not be registered.
- When the Mode Dial is set to <C1>, <C2>, or <C3> position, the [My: Clear all camera settings] and [Clear all Custom Func. (C.Fn)] menus will not work.



- Even when the Mode Dial is set to <C1>, <C2>, or <C3> position, you can still change the drive mode and menu settings. If you want to register those changes, follow the procedure above.
- When you press the <INFO.> button, the registered settings will appear on the LCD monitor. (p.168)



12

Reference

This chapter provides reference information for camera features, system accessories, etc. The back of this chapter also has an index to make it easier to look up things.

INFO. Checking Camera Settings

When the camera is ready to shoot, press the <INFO.> button and “Camera set.” and “Shoot. func.” will appear.

When “Shoot. func.” is displayed, you can set the ISO speed and other shooting functions while looking at the LCD monitor.



Display “Camera set.” and “Shoot. func.”

- Press the <INFO.> button.
- ▶ The button toggles between the two screens.

Display one of them.

- On the [**Y** INFO button] menu, you can either display [**Camera set.**] or [**Shoot. func.**].

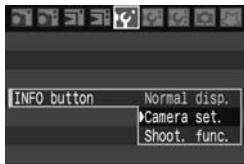

Camera Settings

Picture Style Standard (p.61, 62)

Detail 03, 0, 0, 0 (p.74)

Color space sRGB (p.70, 71)

WB SHIFT/BKT 0, 0/±0

1 min. 5200 Color temperature (p.69)

C1:P C2:P C3:P Shooting mode registered under the Mode Dial's **C1**, **C2**, and **C3** positions (p.57, 28)

[Possible shots] Freespace

[167]630MB

06/24/'07 13:10 Date/Time (p.41)

Red-eye reduction (p.100)

Auto rotate display (p.126)

Auto power off (p.42)

Shooting Functions

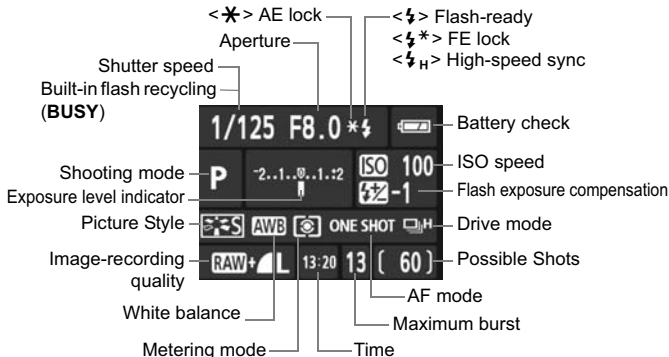

If you press the **< ISO • ⚡ >**, **< AF • DRIVE >**, **< Ⓜ • WB >**, or **< Ⓜ >** button, the setting screen will appear and you can turn the **< ⚙ >** or **< ⚙ >** dial to set it. You can also select the AF point with **< Ⓜ >**.

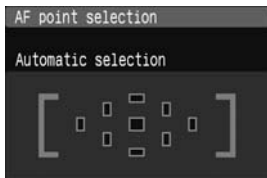
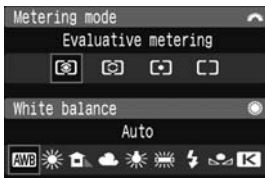
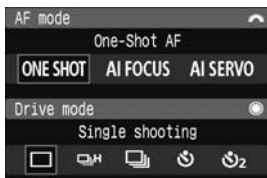
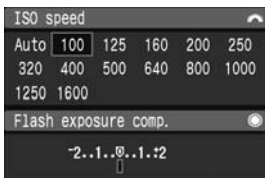

Using a Household Power Outlet

With AC Adapter Kit ACK-E2 (sold separately), you can connect the camera to a household power outlet and not worry about the battery level.

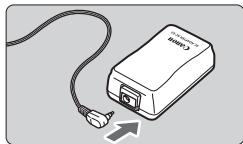

1 Connect the DC plug.

- Connect the DC Coupler's plug to the AC adapter's socket.

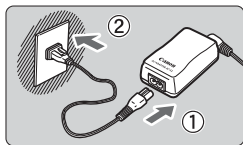

2 Connect the power cord.

- Connect the power cord to the AC adapter.
- Insert the prongs into a power outlet.
- When you are finished, disconnect the plug from the power outlet.

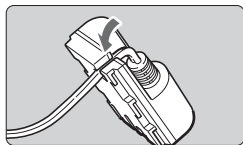

3 Place the cord in the groove.

- Insert the cord carefully without damaging the cord.

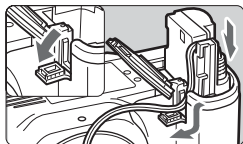

4 Insert the DC Coupler.

- Open the battery compartment cover and open the DC Coupler cord notch cover.
- Insert the DC Coupler until the lock position and put the cord through the notch.
- Close the cover.

! Do not connect or disconnect the power cord while the camera's power switch is set to <ON> or <↘>.

Replacing the Date/Time Battery

The date/time (back-up) battery maintains the camera's date and time. Its service life is about 5 years. If the date/time is reset when the battery is replaced, replace the back-up battery with a new CR2016 lithium battery as described below.

The date/time setting will also be reset, so be sure to set the correct date/time.

1 Set the power switch to <OFF>.

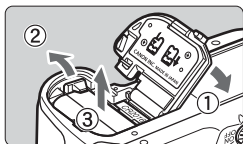

2 Remove the battery.

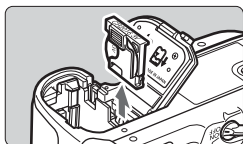

3 Take off the battery holder.

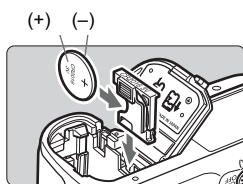

4 Replace the battery.

- Make sure the battery is in the proper + - orientation.

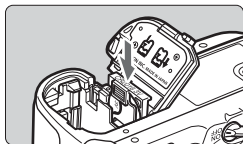

5 Insert the battery holder.

- Then load the battery and close the cover.

 For the date/time battery, be sure to use a CR2016 lithium battery.

Function Availability Table

● : Set automatically ○ : User selectable □ : Not selectable

Mode Dial		Basic Zone						Creative Zone					
									P	Tv	Av	M	A-DEP
Quality	JPEG	○	○	○	○	○	○	○	○	○	○	○	○
	RAW	□	□	□	□	□	□	○	○	○	○	○	
	RAW + JPEG	□	□	□	□	□	□	○	○	○	○	○	
ISO speed	Auto	●	●	●	●	●	●	○	○	○	○	○	
	Manual	□	□	□	□	□	□	○	○	○	○	○	
Picture Style	Standard	●	□	□	●	●	●	●	○	○	○	○	○
	Portrait	□	●	□	□	□	□	□	○	○	○	○	○
	Landscape	□	□	●	□	□	□	□	○	○	○	○	○
	Neutral	□	□	□	□	□	□	□	○	○	○	○	○
	Faithful	□	□	□	□	□	□	□	○	○	○	○	○
	Monochrome	□	□	□	□	□	□	□	○	○	○	○	○
	User Defined	□	□	□	□	□	□	□	○	○	○	○	○
Color space	sRGB	●	●	●	●	●	●	○	○	○	○	○	
	Adobe RGB	□	□	□	□	□	□	○	○	○	○	○	
White balance	Auto WB	●	●	●	●	●	●	○	○	○	○	○	
	Preset WB	□	□	□	□	□	□	○	○	○	○	○	
	Custom WB	□	□	□	□	□	□	○	○	○	○	○	
	Color temperature setting	□	□	□	□	□	□	○	○	○	○	○	
	WB correction	□	□	□	□	□	□	○	○	○	○	○	
	WB bracketing	□	□	□	□	□	□	○	○	○	○	○	
AF	One-Shot	□	●	●	●	□	●	○	○	○	○	●	
	AI Servo	□	□	□	□	●	□	○	○	○	○	□	
	AI Focus	●	□	□	□	□	□	●	○	○	○	□	
	AF point selection	Auto	●	●	●	●	●	●	○	○	○	○	●
		Manual	□	□	□	□	□	□	○	○	○	○	□
AF-assist beam	●	●	□	●	□	●	□	○	○	○	○	○	

●: Set automatically ○: User selectable □: Not selectable

Mode Dial		Basic Zone						Creative Zone					
									P	Tv	Av	M	A-DEP
Metering mode	Evaluative	●	●	●	●	●	●	●	○	○	○	○	○
	Partial								○	○	○	○	○
	Spot								○	○	○	○	○
	Center-weighted average								○	○	○	○	○
Exposure	Program shift								○				
	Exposure compensation								○	○	○		○
	AEB								○	○	○	○	○
	AE lock								○	○	○		○
	Depth-of-field preview								○	○	○	○	○
Drive	Single	●		●	●		●	●	○	○	○	○	○
	High-speed continuous					●			○	○	○	○	○
	Low-speed continuous		●						○	○	○	○	○
	Self-timer 10 sec.	○	○	○	○	○	○	○	○	○	○	○	○
	Self-timer 2 sec.								○	○	○	○	○
Built-in flash	Auto	●	●		●		●						
	Manual								○	○	○	○	○
	Flash off			●		●		●					
	Red-eye reduction	○	○		○		○		○	○	○	○	○
	FE lock								○	○	○	○	○
	Flash exposure compensation								○	○	○	○	○
Live View shooting									○	○	○	○	○

Troubleshooting Guide

If there is a problem, first refer to this Troubleshooting Guide. If this Troubleshooting Guide does not resolve the problem, contact your dealer or nearest Canon Service Center.

Power

The battery cannot be recharged with the battery charger provided.

- Do not recharge any battery pack other than Battery Pack BP-511A, BP-514, BP-511, or BP-512.

The camera does not operate even when the power switch is set to <ON>.

- The battery is not properly installed in the camera. (p.26)
- Make sure the battery compartment cover is closed. (p.26)
- Make sure the CF card slot cover is closed. (p.28)

The battery becomes exhausted quickly.

- Use a fully-charged battery. (p.24)
- The rechargeable battery will degrade after repeated use. Purchase a new one.

The camera turns off by itself.

- Auto power off is in effect. If you do not want auto power off to take effect, set the [**ⓘ** Auto power off] menu to [**Off**].

Only the <☐> icon blinks on the LCD panel.

- Recharge the battery. (p.24)

Shooting

No images can be shot or recorded.

- The CF card is not properly inserted. (p.28)
- If the CF card is full, replace the card or delete unnecessary images to make room. (p.28, 124)
- If you try to focus in the One-Shot AF mode while the focus confirmation light <●> in the viewfinder blinks, a picture cannot be taken. Press the shutter button halfway again to focus, or focus manually. (p.32, 80)

The LCD monitor does not display a clear image.

- If dust is adhering to the LCD monitor, wipe with a lens cloth or soft cloth.
- In low or high temperatures, the LCD monitor display may seem slow or it might look black. It will return to normal at room temperature.

The image is out of focus.

- Set the lens focus mode switch to <AF>. (p.30)
- To prevent camera shake, hold the camera still and press the shutter button gently. (p.32, 35)

The CF card cannot be used.

- If a CF card-related error message is displayed, see page 43 or 177.

The camera makes a noise when it is shaken.

- The built-in flash's pop-up mechanism shakes slightly. This is normal.

Live View shooting is not possible.

- When using Live View shooting, use a CF card (a hard disk-type CF card such as MicroDrive is not recommended). A hard disk-type CF card requires a lower temperature range for operation than with normal CF cards. If the temperature gets too high, the Live View shooting may stop temporarily to prevent damage to the card's hard disk. When the camera's internal temperature decreases, the Live View shooting will be able to resume. (p.107)

The built-in flash does not fire.

- If you shoot continuously with the built-in flash at short intervals, the flash might stop operating to protect the flash unit.

Image Review & Operation

The image cannot be erased.

- If the image has been erase-protected, it cannot be erased. (p.123)

The shooting date and time displayed is incorrect.

- The correct date and time has not been set. (p.41)

No image appears on the TV screen.

- Make sure the video cable plug is connected all the way in. (p.122)
- Set the video OUT format (NTSC/PAL) to the same video format as the TV. (p.39)
- Use the video cable that came with the camera. (p.122)

Error Codes

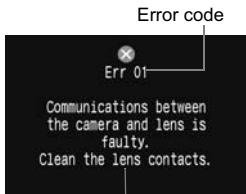

Error code

Err 01

Communications between
the camera and lens is
faulty.
Clean the lens contacts.

Countermeasures

If there is a problem with the camera, an error message appears. Follow the on-screen instructions.

To recover from the error screen, turn the power switch off and on, or remove and reinstall the battery.

If error 02 (CF card problem) is displayed, remove and reinstall the CF card or format the card. This may resolve the problem.

If the same error keeps appearing, there may be a problem. Write down the error code and consult your nearest Canon Service Center.

System Map

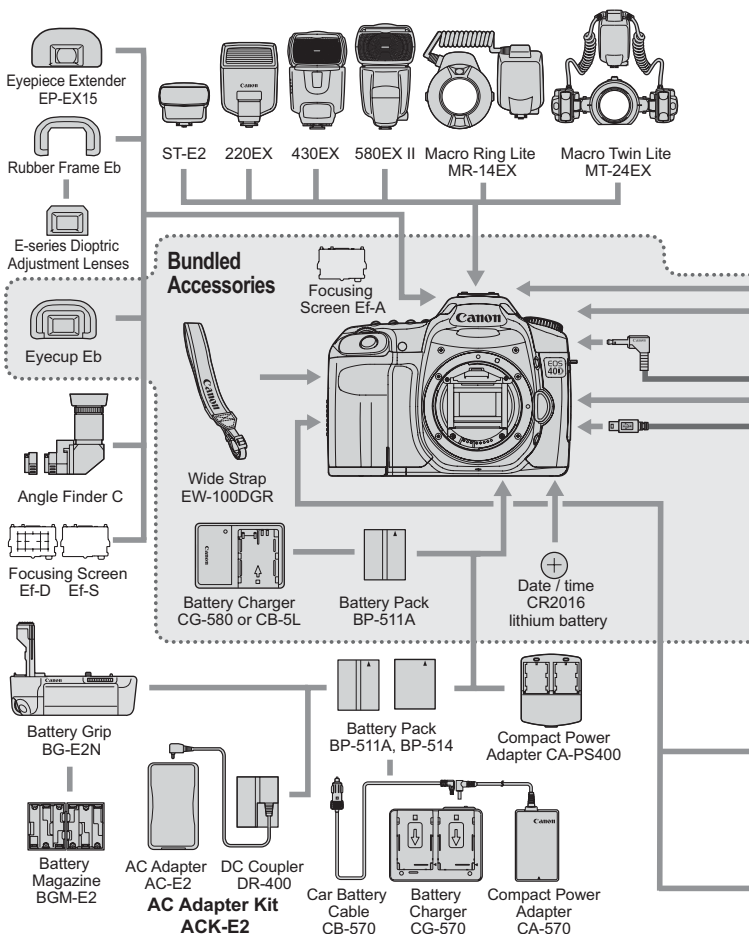

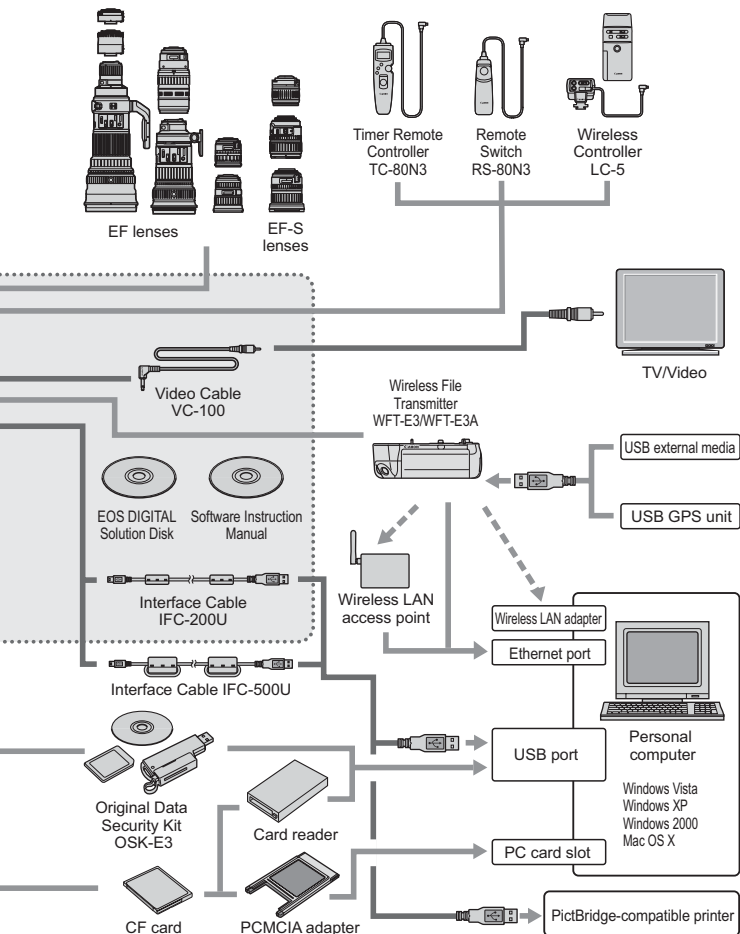

Using the Battery Grip

If you plan to use the camera with Battery Grip BG-E2, originally dedicated to the EOS 20D and EOS 30D, read the following. For instructions other than “Detaching the Battery Compartment Cover” and “Battery Life” explained below, refer to the Battery Grip BG-E2 Instruction Manual.

If you have Battery Grip BG-E2N, read the BG-E2N’s Instruction Manual.

Detaching the Battery Compartment Cover

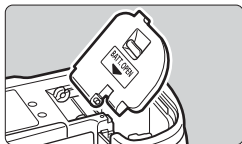
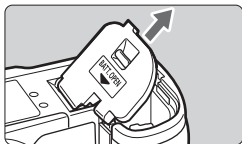

- Put the camera on a flat surface and hold it firmly so it does not fall.
- Open the battery compartment cover and pull it out at a slanted angle to remove.
- Store the detached battery compartment cover in the battery grip.
- To reattach the battery compartment cover, slant it at the same angle when it was removed and insert the cover’s hinge into the camera.

Battery Life

At 23°C / 0°C (73°F / 32°F)

[Approx. shots]

Power	No Flash	50% Flash Use
BP-511A x 2	2200 / 1900	1600 / 1400
Size-AA alkaline batteries	400 / 200	300 / 100

Specifications

• Type

Type:	Digital, single-lens reflex, AF/AE camera with built-in flash
Recording media:	Type I or II CF card * Compatible with Microdrive and 2GB and larger CF cards * Recording to USB external media enabled with Wireless File Transmitter WFT-E3/E3A attached
Image sensor size:	22.2 x 14.8mm
Compatible lenses:	Canon EF lenses (including EF-S lenses) (35mm-equivalent focal length is approx. 1.6 times the lens focal length)
Lens mount:	Canon EF mount

• Image Sensor

Type:	High-sensitivity, high-resolution, large single-plate CMOS sensor
Pixels:	Effective pixels: Approx. 10.10 megapixels Total pixels: Approx. 10.50 megapixels
Aspect ratio:	3:2
Color filter system:	RGB primary color filter
Low-pass filter:	Located in front of the image sensor, non-removable
Dust deletion feature:	(1) Automatic sensor cleaning (2) Manual cleaning of sensor (3) Dust Delete Data appended to the captured image

• Recording System

Recording format:	Design rule for Camera File System 2.0
Image type:	JPEG, RAW (14-bit)
RAW+JPEG	
simultaneous recording:	Provided (sRAW+JPEG also possible)
File size:	(1) Large/Fine : Approx. 3.5 MB (3888 x 2592 pixels) (2) Large/Normal : Approx. 1.8 MB (3888 x 2592 pixels) (3) Medium/Fine : Approx. 2.1 MB (2816 x 1880 pixels) (4) Medium/Normal: Approx. 1.1 MB (2816 x 1880 pixels) (5) Small/Fine : Approx. 1.2 MB (1936 x 1288 pixels) (6) Small/Normal : Approx. 0.7 MB (1936 x 1288 pixels) (7) RAW : Approx. 12.4 MB (3888 x 2592 pixels) (8) sRAW (Small RAW): Approx. 7.1 MB (1936 x 1288 pixels) * Exact file sizes depend on the subject, ISO speed, Picture Style, etc.
File numbering:	Consecutive numbering, auto reset, manual reset
Color space:	sRGB, Adobe RGB
Picture Style:	Standard, Portrait, Landscape, Neutral, Faithful, Monochrome, User Def. 1 - 3

Recording functions:	With the WFT-E3/E3A attached, image recording to the CF card and to USB external media connected to the WFT-E3/E3A will be possible as follows: (1) Standard (2) Automatic switching of recording media (3) Separate recordings according to image-recording quality (4) Recording images having the same size
Backup recording:	Enabled with WFT-E3/E3A attached
• White Balance	
Type:	Auto, daylight, shade, cloudy, tungsten light, white fluorescent light, flash, custom, color temperature setting
Auto white balance:	Auto white balance with the image sensor
Color temperature compensation:	White balance correction: ± 9 stops in full-stop increments White balance bracketing: ± 3 stops in full-stop increments * Blue/amber direction or magenta/green direction possible
Color temperature information transmission:	Provided
• Viewfinder	
Type:	Eye-level pentaprism
Coverage:	Vertical/Horizontal approx. 95%
Magnification:	Approx. 0.95x (-1 diopter with 50mm lens at infinity)
Eyepoint:	Approx. 22 mm
Built-in dioptic adjustment:	-3.0 - +1.0 diopter
Focusing screen:	Interchangeable (2 types sold separately), Ef-A standard focusing screen provided
Mirror:	Quick-return half mirror (Transmission:reflection ratio of 40:60, no mirror cut-off with EF600mm f/4L IS USM or shorter lenses)
Viewfinder information:	AF information (AF points, focus confirmation light), exposure information (shutter speed, aperture, AE lock, exposure level, ISO speed, exposure warning), flash information (flash ready, high-speed sync, FE lock, flash exposure compensation), monochrome shooting, white balance correction, maximum burst, CF card information
Depth-of-field preview:	Enabled with depth-of-field preview button
• Autofocus	
Type:	TTL secondary image-registration, phase detection
AF points:	9 (Cross-type)
Metering range:	EV -0.5 - 18 (at 23°C/73°F, ISO 100)
Focus modes:	One-Shot AF, AI Servo AF, AI Focus AF, Manual focusing (MF)

AF point selection:	Automatic selection, manual selection
Selected AF point display:	Superimposed in viewfinder and indicated on LCD panel
AF-assist beam:	Small series of flashes fired by built-in flash Effective range: Approx. 4.0 m/13.1 ft. at center, approx. 3.5 m/11.5 ft. at periphery

• Exposure Control

Metering modes:	35-zone TTL full-aperture metering <ul style="list-style-type: none"> • Evaluative metering (linkable to any AF point) • Partial metering (approx. 9% of viewfinder at center) • Spot metering (approx. 3.8% of viewfinder at center) • Center-weighted average metering
Metering range:	EV 1 - 20 (at 23°C/73°F with EF50mm f/1.4 USM lens, ISO 100)
Exposure control:	Program AE (Full Auto, Portrait, Landscape, Close-up, Sports, Night Portrait, Flash Off, Program), shutter-priority AE, aperture-priority AE, depth-of-field AE, manual exposure, E-TTL II autoflash
ISO speed (Recommended Exposure Index):	Basic Zone modes: ISO 100 - 800 set automatically Creative Zone modes: ISO 100 - 1600 (in 1/3-stop increments), Auto, or ISO speed can be expanded to ISO 3200
Exposure compensation:	Manual: ±2 stops in 1/3- or 1/2-stop increments (can be combined with AEB) AEB: ±2 stops in 1/3- or 1/2-stop increments
AE lock:	Auto: Applied in One-Shot AF mode with evaluative metering when focus is achieved Manual: By AE lock button

• Shutter

Type:	Electronically-controlled, focal-plane shutter
Shutter speeds:	1/8000 to 30 sec. (1/3- and 1/2-stop increments), bulb, X-sync at 1/250 sec.
Shutter release:	Soft-touch electromagnetic release
Self-timer:	10-sec. or 2-sec. delay
Remote control:	Remote control with N3 type terminal

• Built-in Flash

Type:	Retractable, auto pop-up flash
Flash metering:	E-TTL II autoflash
Guide No.:	13/43 (ISO 100, in meters/feet)
Recycle time:	Approx. 3 sec.
Flash-ready indicator:	Flash-ready icon lights in viewfinder

Flash coverage:	17mm lens angle of view
Flash exposure compensation:	±2 stops in 1/3- or 1/2-stop increments
FE lock:	Provided

• External Speedlite

Compatible flash:	EX-series Speedlites
Flash metering:	E-TTL II autoflash
Flash exposure compensation:	±2 stops in 1/3- or 1/2-stop increments
FE lock:	Provided
External flash settings:	Flash function settings, Flash C.Fn settings
PC terminal:	Provided
Zooming to match lens focal length:	Provided

• Drive System

Drive modes:	Single, High-speed continuous, Low-speed continuous, and Self-timer (10 sec. or 2 sec. delay)
--------------	---

Continuous shooting speed (Approx.):	High-speed: Max. 6.5 shots/sec., Low-speed: Max. 3 shots/sec.
--------------------------------------	--

Maximum burst:	JPEG (Large/Fine): Approx. 75, RAW: Approx. 17 RAW+JPEG (Large/Fine): Approx. 14 * Based on Canon's testing standards with 1GB CF card, high-speed continuous shooting, ISO 100, and Standard Picture Style * Varies depending on the subject, CF card brand, image-recording quality, ISO speed, drive mode, Picture Style, etc.
----------------	--

• Live View Functions

Shooting modes:	(1) Live View shooting (2) Remote Live View shooting (with a personal computer installed with EOS Utility)
Focusing:	Manual focus Autofocus (Live View image interrupted for AF)
Metering modes:	Evaluative metering with the image sensor
Metering range:	EV 0 - 20 (at 23°C/73°F with EF50mm f/1.4 USM lens, ISO 100)
Magnified view:	Magnifiable by 5x or 10x at AF point
Grid display:	Provided
Exposure simulation:	Provided
Silent shooting:	Provided (Mode 1 and 2)

• LCD Monitor

Type:	TFT color liquid-crystal monitor
Monitor size:	3.0 in.
Pixels:	Approx. 230,000
Coverage:	Approx. 100%
Brightness adjustment:	7 levels provided
Interface languages:	18

• Image Playback

Display format:	Single image, Single image + Image-recording quality, shooting information, histogram, 4- or 9-image index, magnified view (approx. 1.5x - 10x), rotated image, image jump (by 1/10/100 images, 1 screen, or shooting date)
Highlight alert:	Provided (Overexposed highlights blink)

• Image Protection and Erase

Protect:	Single images can be erase-protected or not
Erase:	Single image, checkmarked images, or all images in the CF card can be erased (except protected images) at one time

• Direct Printing

Compatible printers:	PictBridge-compatible printers
Printable images:	JPEG images compliant to Design rule for Camera File System (DPOF printing possible) and RAW/sRAW images captured with the EOS 40D
Easy Print feature:	Provided

• Digital Print Order Format

DPOF:	Version 1.1 compatible
-------	------------------------

• Direct Image Transfer

Compatible images:	JPEG and RAW/sRAW images * Only JPEG images can be transferred as wallpaper on the personal computer screen
--------------------	--

• Customization

Custom Functions:	Total 24
Camera user settings:	Register under Mode Dial's C1, C2, and C3 positions
My Menu registration:	Provided

• Interface

USB terminal:	For personal computer communication and direct printing (USB 2.0 Hi-Speed)
Video OUT terminal:	NTSC/PAL selectable
Extension system terminal:	For connection to WFT-E3/E3A

• Power Source

Battery: Single Battery Pack BP-511A, BP-514, BP-511, or BP-512
 * AC power can be supplied via AC Adapter Kit ACK-E2
 * With Battery Grip BG-E2N or BG-E2 attached, size-AA batteries can be used

Battery life: [Number of shots • approx.]

Temperature	Shooting Conditions	
	No Flash	50% Flash Use
At 23°C / 73°F	1100	800
At 0°C / 32°F	950	700

* The above figures apply with a fully-charged Battery Pack BP-511A

* The figures above are based on CIPA (Camera & Imaging Products Association) testing standards

Battery check: Auto
 Power saving: Provided. Power turns off after 1, 2, 4, 8, 15, or 30 min.
 Date/Time battery: One CR2016 lithium battery
 Startup time: Approx. 0.15 sec.

• Dimensions and Weight

Dimensions (W x H x D): 145.5 x 107.8 x 73.5 mm / 5.7 x 4.2 x 2.9 in.

Weight: Approx. 740 g / 26.1 oz. (body only)

• Operation Environment

Working temperature range: 0°C - 40°C / 32°F - 104°F

Working humidity: 85% or less

• Battery Pack BP-511A

Type: Rechargeable lithium ion battery
 Rated voltage: 7.4 V DC
 Battery capacity: 1390 mAh
 Dimensions (W x H x D): 38 x 21 x 55 mm / 1.5 x 0.8 x 2.2 in.
 Weight: Approx. 82 g / 2.9 oz.

• Battery Charger CG-580

Compatible battery: Battery Pack BP-511A, BP-514, BP-511, or BP-512
 Recharging time: BP-511A, BP-514: Approx. 100 min.
 BP-511, BP-512: Approx. 90 min.
 Rated input: 100 - 240 V AC (50/60 Hz)
 Rated output: 8.4 V DC
 Working temperature range: 0°C - 40°C / 32°F - 104°F

Working humidity: 85% or less
 Dimensions (W x H x D): 91 x 67 x 31 mm / 3.6 x 2.6 x 1.2 in.
 Weight: Approx. 115 g / 4.1 oz.

• Battery Charger CB-5L

Compatible battery: Battery Pack BP-511A, BP-514, BP-511, or BP-512
 Power cord length: Approx. 1.8 m / 5.9 ft.
 Recharging time: BP-511A, BP-514: Approx. 100 min.
 BP-511, BP-512: Approx. 90 min.
 Rated input: 100 - 240 V AC
 Rated output: 8.4 V DC
 Working temperature range: 0°C - 40°C / 32°F - 104°F
 Working humidity: 85% or lower
 Dimensions (W x H x D): 91 x 67 x 32.3 mm / 3.6 x 2.6 x 1.3 in.
 Weight: Approx. 105 g / 3.7 oz. (excluding power cord)

• EF-S18-55mm f/3.5-5.6 IS

Angle of view: Diagonal extent: 74°20' - 27°50'
 Horizontal extent: 64°30' - 23°20'
 Vertical extent: 45°30' - 15°40'
 Lens construction: 11 elements in 9 groups
 Minimum aperture: f/22 - 36
 Closest focusing distance: 0.25 m / 0.82 ft.
 Max. magnification: 0.34x (at 55 mm)
 Field of view: 207 x 134 - 67 x 45 mm / 8.1 x 5.3 - 2.6 x 1.8 in. (at 0.25 m)
 Filter size: 58 mm
 Max. diameter x length: Approx. 68.5 x 70 mm / 2.7 x 2.8 in.
 Weight: Approx. 200 g / 7.1 oz.
 Hood: EW-60C
 Case: LP814

• EF-S17-85mm f/4-5.6 IS USM

Angle of view: Diagonal extent: 78°30' - 18°25'
 Horizontal extent: 68°40' - 15°25'
 Vertical extent: 48°00' - 10°25'
 Lens construction: 17 elements in 12 groups
 Minimum aperture: f/22 - 32
 Closest focusing distance: 0.35 m / 1.15 ft.
 Max. magnification: 0.2x (at 85mm)
 Field of view: 328 x 219 - 112 x 75 mm / 12.9 x 8.6 - 4.4 x 3.0 in. (at 0.35 m)
 Filter size: 67 mm

Max. diameter x length: 78.5 x 92 mm / 3.1 x 3.6 in.

Weight: Approx. 475 g / 16.8 oz.

Hood: EW-73B

Case: LP1116

- All specifications above are based on Canon's testing standards.
- The camera's specifications and exterior are subject to change without notice.
- If a problem occurs with a non-Canon lens attached to the camera, consult the respective lens maker.

Trademarks

- Adobe is a trademark of Adobe Systems Incorporated.
- CompactFlash is a trademark of SanDisk Corporation.
- Windows is a trademark or registered trademark of Microsoft Corporation in the United States and other countries.
- Mac OS X is a registered trademark of Apple Corporation in the United States and other countries.
- All other corporate and product names and trademarks mentioned in this manual are the property of their respective owners.

* This digital camera supports Design rule for Camera File System 2.0 and Exif 2.21 (also called "Exif Print"). Exif Print is a standard that enhances compatibility between digital cameras and printers. By connecting to an Exif Print-compliant printer, the shooting information is incorporated to optimize the print output.

Digital Camera Model DS126171 Systems

This device complies with Part 15 of the FCC Rules. Operation is subject to the following two conditions: (1) This device may not cause harmful interference, and (2) this device must accept any interference received, including interference that may cause undesired operation.

Note: This equipment has been tested and found to comply with the limits for class B digital devices, pursuant to Part 15 of the FCC Rules. These limits are designed to provide reasonable protection against harmful interference in a residential installation. This equipment generates, uses and can radiate radio frequency energy and, if not installed and used in accordance with the instructions, may cause harmful interference to radio communications. However, there is no guarantee that interference will not occur in a particular installation. If this equipment does cause harmful interference to radio or television reception, which can be determined by turning the equipment off and on, the user is encouraged to try to correct the interference by one or more of the following measures:

- Reorient or relocate the receiving antenna.
- Increase the separation between the equipment and receiver.
- Connect the equipment into an outlet on a circuit different from that to which the receiver is connected.
- Consult the dealer or an experienced radio/TV technician for help.

The cable with the ferrite core provided with the digital camera must be used with this equipment in order to comply with Class B limits in Subpart B of Part 15 of the FCC rules.

Do not make any changes or modifications to the equipment unless otherwise specified in the manual. If such changes or modifications should be made, you could be required to stop operation of the equipment.

Canon U.S.A. Inc.
One Canon Plaza, Lake Success, NY 11042, U.S.A.
Tel No. (516)328-5600

This digital apparatus does not exceed the Class B limits for radio noise emissions from digital apparatus as set out in the interference-causing equipment standard entitled "Digital Apparatus", ICES-003 of the Industry Canada.



When connecting to and using a household power outlet, use only AC Adapter Kit ACK-E2 (rated input: 100-240 V AC 50/60 Hz, rated output: 7.8 V DC). Using anything else can cause fire, overheating, or electrical shock.

IMPORTANT SAFETY INSTRUCTIONS

1. **SAVE THESE INSTRUCTIONS** — This manual contains important safety and operating instructions for Battery Charger CG-580 & CB-5L.
2. Before using the charger, read all instructions and cautionary remarks on (1) the charger, (2) the battery pack, and (3) the product using the battery pack.
3. **CAUTION** — To reduce risk of injury, charge only the Battery Pack BP-511A, BP-514, BP-511, or BP-512. Other types of batteries may burst, causing personal injury and other damage.
4. Do not expose the charger to rain or snow.
5. Use of an attachment not recommended or sold by Canon may result in fire, electric shock, or personal injury.
6. To reduce risk of damage to electric plug and cord, pull by plug rather than by cord when disconnecting charger.
7. Make sure cord is located so that it will not be stepped on, tripped over, or otherwise subjected to damage or stress.
8. Do not operate the charger with damaged cord or plug - replace them immediately.
9. Do not operate the charger if it has received a sharp blow, been dropped, or otherwise damaged in any way; take it to a qualified serviceman.
10. Do not disassemble the charger; take it to a qualified serviceman when service or repair is required. Incorrect reassembly may result in a risk of electric shock or fire.
11. To reduce risk of electric shock, unplug charger from outlet before attempting any maintenance or cleaning.

MAINTENANCE INSTRUCTION

Unless otherwise stated in this manual, there are no user serviceable parts inside. Refer servicing to qualified serviceman.



U.S.A. and Canada only:

The Lithium ion/polymer battery that powers the product is recyclable. Please call 1-800-8-BATTERY for information on how to recycle this battery.

For CA, USA only

Included lithium battery contains Perchlorate Material – special handling may apply.

See www.dtsc.ca.gov/hazardouswaste/perchlorate/ for details.

Index



A

- AC Adapter Kit 170
- Access lamp 29
- A-DEP
(Automatic depth-of-field AE)..... 91
- Adobe RGB..... 74
- AE lock..... 95
- AEB (Auto Exposure Bracketing).... 94
- AF → Focusing
- AF start <AF-ON> button 32, 160
- AF stop button 158
- AI Focus AF 77
- Aperture-priority AE 88
- Auto play (auto playback) 121
- Auto power off..... 42
- Auto rotate of vertical image 126
- Autofocus → Focusing
- Av (Aperture-priority AE)..... 88

B

- Basic Zone 20
- Battery → Power
- Battery check 26
- Battery Grip BG-E2..... 180
- Beeper 38
- Black-and-white image 62, 64
- Bracketing 71, 94, 155
- Bulb..... 96
 - Noise reduction 156

C

-    20, 165
- Camera
 - Camera shake 82, 98
 - Holding the camera 35
 - Reset to default settings..... 44
 - Setting description display..... 168
- Camera shake 31, 35

- Camera user settings 20, 165
- CF card 13, 28, 42
 - CF card reminder 38
 - Format 42
 - Problem 43
- Clock → Date/Time
- Close-up..... 51
- Color saturation 63, 140
- Color space 74
 - sRGB / Adobe RGB
- Color temperature 69
- Color tone..... 63, 140
- Continuous shooting 81, 169
- Contrast..... 63, 140
- Creative Zone..... 20
- ★ icon 4
- Cross-type focusing 79
- Custom Functions 152
 - Clear all..... 152

D

- Date → Date/Time
- Date/Time 41
 - Date/time battery replacement. 171
- Depth-of-field preview 89
- Dioptic adjustment 35
- Direct printing → Printing
- Drive mode 81, 169
 - Single / Continuous shooting
 - Self-timer 82
- Dust Delete Data 129

E

- Easy Printing 139
- Erase (image)..... 124
- Error codes..... 177
- Evaluative metering..... 92
- Exposure compensation..... 93
 - 1/2-stop increments 154

External Speedlite 105
 Eyepiece cover 23, 97

F

Faithful 62
 FE lock 102
 File number 72
 Continuous / Auto reset /
 Manual reset
 File size 57, 117, 181
 Filter effect (Monochrome) 64
 Yellow / Orange / Red / Green
 Flash
 2nd-curtain sync 103
 Custom Functions 104
 Effective range 100
 External Speedlite 104, 105
 FE lock 102
 Flash exposure compensation ... 101
 Flash off 54
 Menu setting 103, 104
 Red-eye reduction 100
 Shutter speed fixed
 at 1/250 sec 155
 Flash exposure
 compensation 101, 169
 1/2-stop increments 154
 Focal plane mark 17
 Focus lock 48
 Focus mode switch 30, 80
 Focusing
 AF mode 76, 169
 AF point display 117, 159
 AF point selection 78, 159, 169
 AF-assist beam 79, 159
 Beeper 77
 Difficult-to-focus subjects 80
 Focus search 157
 Live View shooting 114, 160
 Manual focusing 80

Out of focus 47, 80
 Recompose 48
 Focusing screen 162
 Folder 72
 Format (CF card initialization) 42
 Full Auto 46
 Function Availability Table 172

H

Highlight alert 117
 Highlight detail loss 117
 Highlight tone priority 157
 Histogram 118
 Brightness / RGB
 Household power 170

I

Image
 AF point display 117
 Auto image rotation 126
 Auto playback 121
 Erase 124
 Highlight alert 117
 Histogram 118
 Index display 119
 Jump display 119
 Magnified view 120
 Manual image rotation 120
 Playback 115
 Protect 123
 Shooting information 117
 Transfer to personal computer ... 147
 View on TV 122
 Image area 31
 Image dust prevention 127
 Image review time 125
 Image Stabilizer (lens) 31
 Image transfer 147
 Image-recording quality selection... 56
 Index display 119

ISO speed.....	59, 169
Automatic setting.....	60
ISO expansion.....	154

J

Jump display.....	119
-------------------	-----

L

Landscape.....	50, 61
Language selection.....	41
LCD monitor.....	13
Brightness adjustment.....	125
Image playback.....	115
Menus.....	36
Shooting functions.....	169
LCD panel.....	18
Illumination.....	96
LCD panel illumination.....	96
Lens.....	21, 30
Live View shooting.....	107, 160, 163
Long exposures → Bulb	

M

M (Manual exposure).....	90
Magnified view.....	120
Malfunction.....	174
Manual exposure.....	90
Manual focusing.....	80, 110
Maximum burst.....	57, 58
Memory card → CF card	
Menu	
Menu settings.....	38
My Menu.....	164
Setting operation.....	36

MENU icon.....	4
Metering mode.....	92, 169
Evaluative / Partial / Spot /	
Center-weighted average	
MF (Manual focusing).....	80
Mirror lockup.....	98, 160

Mode Dial → Shooting mode	
Monochrome image.....	62, 64
Multi-controller.....	34, 78
My Menu.....	164

N

Neutral.....	61
Night Portrait.....	53
Noise reduction.....	156
Nomenclature.....	16
Number → File number	

O

One-Shot AF.....	76
Original decision	
(image verification) data.....	163

P

P (Program AE).....	84
Paper settings (printing).....	136
Partial metering.....	92
PC terminal.....	16, 106
Personal computer	
Image transfer.....	147
Wallpaper.....	149
Personal white balance.....	69
PictBridge.....	133
Picture Style	
Adjustment.....	63
Selection.....	61
User defined.....	65
Pixel count selection.....	56
Playback → Image	
Portrait.....	49, 53, 61
Power	
Auto power off.....	42
Battery check.....	26
Household power.....	170
Possible shots.....	27
Recharge.....	24

Switch	32
Printing.....	133
Layout.....	137
Paper settings.....	136
PictBridge	133
Print Order (DPOF).....	143
Printing effects	138
Tilt correction	141
Trimming.....	141
<  > button	139, 149
Program AE	84
Program shift	85
Protect (image erase-protection) ..	123

R

RAW.....	56, 58
RAW+JPEG	57
Recharge	24
Red-eye reduction.....	100
Remote control shooting	97
Reset to default settings	44
Rotate (image)	120, 126, 141

S

Safety shift	155
Self-timer.....	82
Sensor cleaning	127
Sepia (Monochrome)	64
Servo AF	48, 77
Sharpness.....	63
Shoot w/o card	38
Shooting functions	169
Shooting information display.....	117
Shooting mode.....	20
A-DEP.....	91
Aperture-priority AE	88
Close-up	51
Flash off.....	54
Full Auto	46
Landscape.....	50

Manual exposure	90
Night Portrait	53
Portrait	49
Program AE	84
Shutter-priority AE.....	86
Sports.....	52
Shots remaining	27, 57
Shutter button.....	32
Shutter-priority AE	86
Silent shooting.....	113
Sports	52
Spot metering	92
sRAW	56, 58
Strap.....	23
System Map	178

T

Toning effect (Monochrome).....	64
Sepia / Blue / Purple / Green	
Transfer order (image)	150
Trimming (printing)	141
Tv (Shutter-priority AE).....	86

V

View on TV	122
Video system (NTSC/PAL)...	39, 122
Viewfinder.....	19
Dioptric adjustment	35

W

WB → White balance	
White balance.....	67, 169
Bracketing	71
Correction	70
Custom.....	68
Personal.....	69

Canon

CANON INC. 30-2, Shimomaruko 3-chome, Ohta-ku, Tokyo 146-8501, Japan

U.S.A. ————— **CANON U.S.A. INC.**

One Canon Plaza, Lake Success, NY 11042-1198, U.S.A.
For all inquiries concerning this product, call toll free in the U.S.
1-800-OK-CANON

CANADA ————— **CANON CANADA INC. HEADQUARTERS**

6390 Dixie Road, Mississauga, Ontario L5T 1P7, Canada

CANON CANADA INC. MONTREAL BRANCH

5990, Côte-de-Liesse, Montréal Québec H4T 1V7, Canada

CANON CANADA INC. CALGARY OFFICE

2828, 16th Street, N.E. Calgary, Alberta T2E 7K7, Canada

For all inquiries concerning this product, call toll free in Canada
1-800-OK-CANON

EUROPE, ————— **CANON EUROPA N.V.**

AFRICA & Bovenkerkerweg 59-61, P.O. Box 2262, 1180 EG Amstelveen, The Netherlands

MIDDLE EAST

CANON COMMUNICATION & IMAGE FRANCE S.A.S.

12 Rue de l'Industrie 92414 Courbevoie Cedex, France

CANON UK LTD.

Woodhatch Reigate Surrey RH2 8BF, United Kingdom

CANON DEUTSCHLAND GmbH

Europark Fichtenhain A10, 47807 Krefeld, Germany

CANON ITALIA S.p.A.

Via Milano 8 I-20097 San Donato Milanese, Milano, Italy

CANON Schweiz AG

Geschäftsbereich Wiederverkauf, Industriestrasse 12, CH-8305 Dietlikon, Switzerland

CANON GMBH

Zetschegasse 11, A-1230 Wien, Austria

CANON España, S. A.

C/Joaquín Costa, 41, 28002 Madrid, Spain

SEQUE Soc. Nac. de Equip., Lda.,

Praça da Alegria, 58, 2º, 1269-149 Lisboa, Portugal

CENTRAL & ————— **CANON LATIN AMERICA, INC.**

SOUTH AMERICA

703 Waterford Way, Ste. 400 Miami, FL 33126, U.S.A.

ASIA ————— **CANON (China) Co., Ltd.**

15F Jinbao Building No.89 Jinbao Street, Dongcheng District, Beijing 100005, China

CANON HONGKONG CO., LTD.

19/F., The Metropolis Tower, 10 Metropolis Drive, Hunghom, Kowloon, Hong Kong

CANON SINGAPORE PTE. LTD.

1 HarbourFront Avenue, #04-01 Keppel Bay Tower, Singapore 098632

CANON KOREA CONSUMER IMAGING INC.

Startower Bldg.17F,737, Yeoksam-Dong, Kangnam-Ku, Seoul, 135-984, Korea

OCEANIA ————— **CANON AUSTRALIA PTY. LTD.**

1 Thomas Holt Drive, North Ryde, N.S.W. 2113, Australia

CANON NEW ZEALAND LTD.

Akoranga Business Park, Akoranga Drive, Northcote, Auckland, New Zealand

JAPAN ————— **CANON MARKETING JAPAN INC.**

16-6, Kohnan 2-chome, Minato-ku, Tokyo 108-8011, Japan

This Instruction Manual booklet is current as of August 2007. For information on the camera's compatibility with any accessories and lenses introduced after this date, contact any Canon Service Center.

Free Manuals Download Website

<http://myh66.com>

<http://usermanuals.us>

<http://www.somanuals.com>

<http://www.4manuals.cc>

<http://www.manual-lib.com>

<http://www.404manual.com>

<http://www.luxmanual.com>

<http://aubethermostatmanual.com>

Golf course search by state

<http://golfingnear.com>

Email search by domain

<http://emailbydomain.com>

Auto manuals search

<http://auto.somanuals.com>

TV manuals search

<http://tv.somanuals.com>