

# Canon

# EOS

## 3000 / 3000 QD

88 / 88 QD



**E**

English Edition  
**Instructions**



# Thank you for purchasing a Canon product.

The EOS 3000 / 3000QD / 88 / 88QD is a very compact autofocus, single-lens reflex camera. It can be used for a wide variety of subjects and situations with fully automatic and user-controlled picture-taking modes. Read this Instructions booklet and familiarize yourself with your new camera before taking pictures.

## ■ Symbols



The Caution symbol alerts you to actions to prevent picture-taking problems.



The Note symbol gives additional information for basic camera operation.



The Lightbulb symbol offers helpful tips for operating your camera and taking pictures.

Page numbers in parentheses indicate where you can find more relevant information.

Also read "Handling Precautions" on page 6 to prevent camera malfunction and damage.

In this Instructions booklet, the EF 35-80mm f/4-5.6 lens is shown in illustrations for explanatory purposes.

**Keep this Instructions booklet handy for easy reference.**

## ■ Precautions

- Before using the camera for an important event, be sure to take test shots to make sure the camera operates properly.
- EOS cameras have a lens mount for dedicated operation (autofocusing, exposure control, etc.) with EF lenses. Using a non-EF lens with an EOS camera may not result in proper camera or lens operation.

Note that the warranty does not cover any camera malfunction or damage occurring with the use of non-Canon accessories.







# Contents

Handling Precautions.....	6
Quick Start Guide .....	8
Nomenclature .....	10

## 1 Before You Start ..... 15

Installing the Batteries and Checking the Battery Level .....	16
Mounting and Detaching a Lens .....	18
How the Shutter Button Works .....	19
Loading and Unloading Film .....	20
 Midroll Film Rewind.....	21
Holding the Camera.....	22

## 2 Camera-Controlled Automatic Shooting ..... 23

 Full Auto Mode .....	24
AF-Assist Lamp .....	25
 Portrait Mode .....	26
 Landscape Mode .....	27
 Close-up Mode .....	28
 Sports Mode .....	29
 Self-timer .....	30
Using the Eyepiece Cover.....	31
Imprinting the Date or Time .....	32
Setting the Date and Time.....	33
Replacing the Quartz Date Back's Battery .....	33
Feature Availability Table .....	34

## 3 User-Controlled Shooting ..... 35

<b>P</b> Program AE.....	36
The Difference Between <b>P</b> and <b>O</b> .....	37
About Program Shift .....	37
6-sec. Camera Activation .....	37
<b>Tv</b> Shutter-Speed Priority AE .....	38
<b>Av</b> Aperture-Priority AE .....	40
Taking a Portrait at Night.....	41
<b>M</b> Manual Exposure .....	42
<b>A-DEP</b> Automatic Depth-of-Field AE .....	44
<b>*</b> Partial Metering Using AE Lock.....	45

Exposure Compensation .....	46
Focusing Off-Center Subjects.....	47
When Autofocus Fails (Switching to Manual Focus) .....	48
•) Silencing the In-Focus Beeper .....	49
Bulb Exposures.....	50
📷 Multiple Exposures .....	51
Setting the ISO Film Speed .....	52
<b>4 Using the Built-in Flash.....</b>	<b>53</b>
Using the Built-in Flash.....	54
👁️ Red-Eye Reduction .....	55
<b>Reference Section .....</b>	<b>56</b>
Exposure Warnings (Blinking Displays).....	56
Flash Sync Speeds and Flash Apertures .....	57
AF Modes and Film Advance Modes .....	57
Basic Photography Terms .....	58
Troubleshooting Guide .....	60
Major Accessories (Sold separately) .....	61
Specifications.....	63
Optional BP-8 AA Battery Pack .....	66
Index .....	70

1

2

3

4

Reference

# Handling Precautions

## Camera Care

- (1) This camera is not waterproof and cannot be used in rain or under water. If the camera gets really wet, promptly consult your nearest Canon Service Center. If there are any water droplets on the camera, wipe off with a dry cloth. If the camera has been exposed to salt air, wipe with a clean, well-wrung, damp cloth.
- (2) Do not leave the camera in places prone to excessive heat such as in a car on a sunny day. Excessive heat can cause the camera to malfunction.
- (3) Use only a blower brush to remove any dust on the lens or in the film compartment. Do not use a cleaner containing organic solvent to clean the camera body or lens. For stubborn dirt, consult your nearest Canon Service Center.
- (4) When you will not be using the camera for an extended period, remove the batteries. Store the camera in a well-ventilated, cool, dry place. Release the shutter a few times occasionally to make sure the camera still works.
- (5) Avoid storing the camera in a laboratory, cabinet, etc., where corrosive chemicals are present.
- (6) Before using the camera after an extended period of disuse, check that all the camera controls function properly or take it to the nearest Canon Service Center for inspection. Do this especially before shooting an important event or going on a trip.

## LCD Panel

In time, the camera's LCD panel display may fade and become difficult to read. If this happens, have it replaced (at cost) by a Canon Service Center. At low temperatures, the LCD panel's display response may become slower. And at 60°C or higher temperatures, the display may blacken. In either case, the display will return to normal at room temperature.

## Lithium Batteries

- (1) The camera operates on two CR123A (or DL123A) lithium batteries. Check the battery level in the following cases:
  - After replacing the batteries.
  - After not using the camera for an extended period.
  - The shutter stops working.
  - The camera is being used in a low-temperature environment.
  - You will be shooting an important event.
- (2) Before installing the batteries, wipe the battery contacts to remove any fingerprints and smudges. This is to prevent faulty connections and corrosion.
- (3) Although the batteries work well even at low temperatures, battery performance may decline slightly at freezing temperatures. In such a case, keep spare batteries warm in a pocket, etc., and use and warm the batteries alternately.

## Low Battery Power

When the **bc** icon blinks on the LCD panel, a picture can still be taken at the proper exposure. However, there may not be enough battery power to advance and rewind the film automatically. Replace with new batteries.

## Lens

After detaching the lens from the camera, put on the lens caps or put down the lens with the rear end up to avoid scratching the lens surface and electrical contacts.

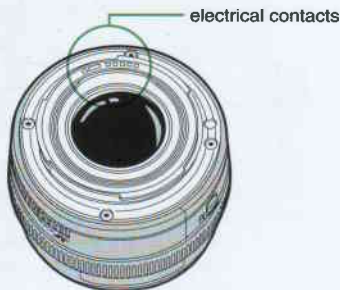

# Quick Start Guide

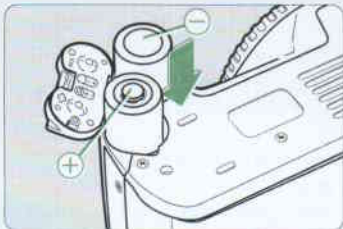

## 1 Install the batteries.

Insert two CR123A (or DL123A) lithium batteries as shown by the battery orientation diagram on the battery chamber cover. See page 16.

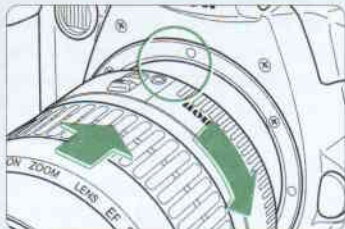

## 2 Attach a lens.

Align the red dots on the lens and camera and turn the lens clockwise until it snaps in place. See page 18.

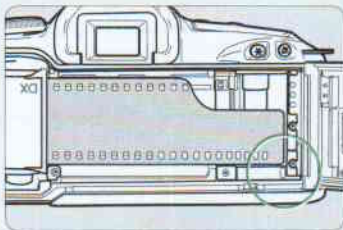

## 5 Load the film.

Align the edge of the film leader with the orange mark on the camera and close the camera back until it snaps shut. See page 20.

- The film will then advance to the first frame automatically.



## 6 Focus the subject.

Aim the AF frame on the subject and press the shutter button halfway to autofocus. See page 24.

- If the  $\langle \text{L} \rangle$  icon blinks, pop up the built-in flash. See page 54.



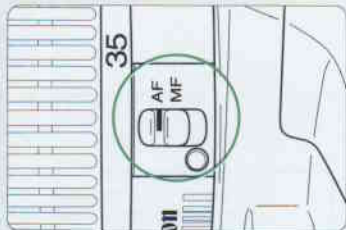

### 3 On the lens, set the focus mode switch to AF.

See page 18.



### 4 Turn the Command Dial to <□> (Full Auto).

See page 24.

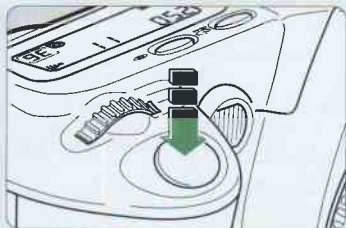

### 7 Take the picture.

Press the shutter button completely to take the picture.  
See page 19.

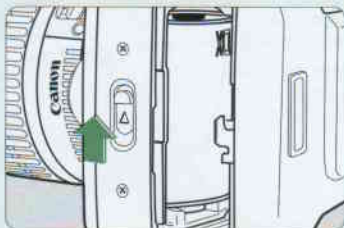

### 8 Unloading the film.

At the end of the roll, the film rewinds automatically. Open the camera back and remove the film cartridge. See page 21.

# Nomenclature

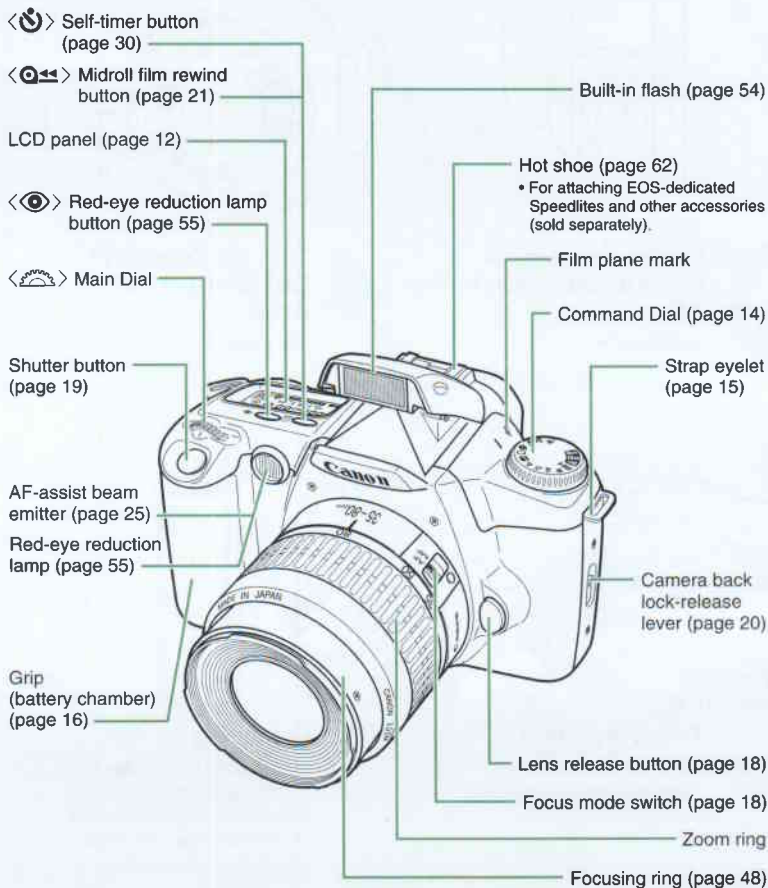

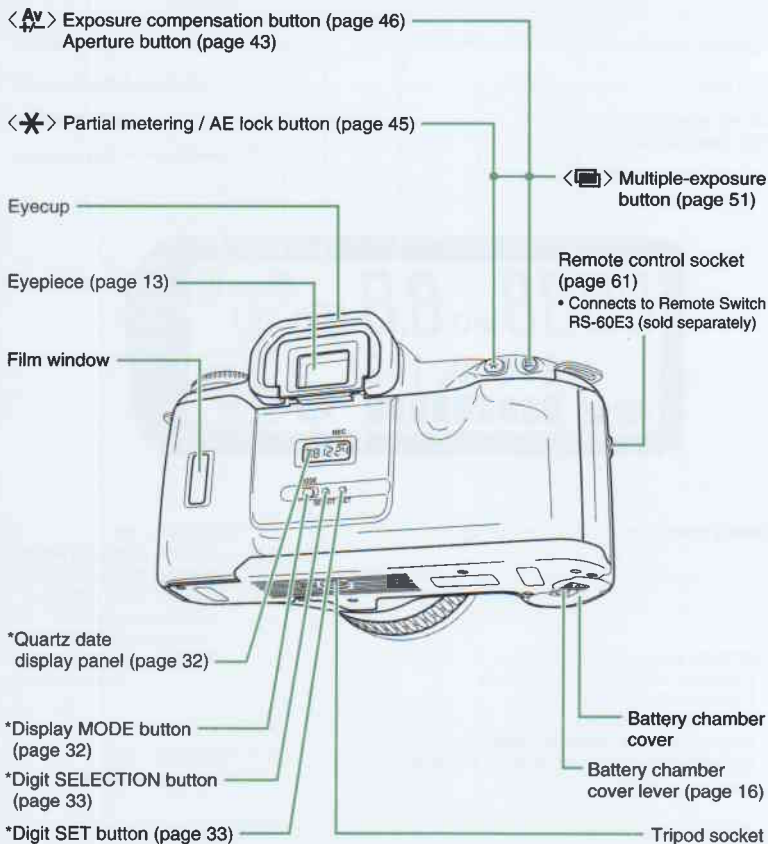

\*QD model only.

## LCD Panel

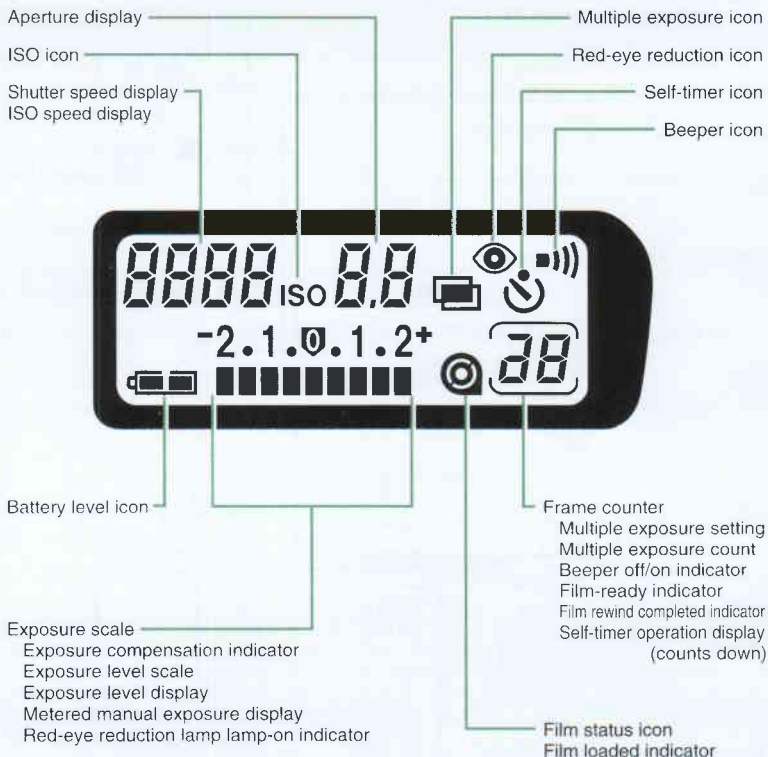

The LCD panel is shown with all the information displayed. The actual information displayed will vary depending on the camera settings and shooting conditions.

## Viewfinder Information

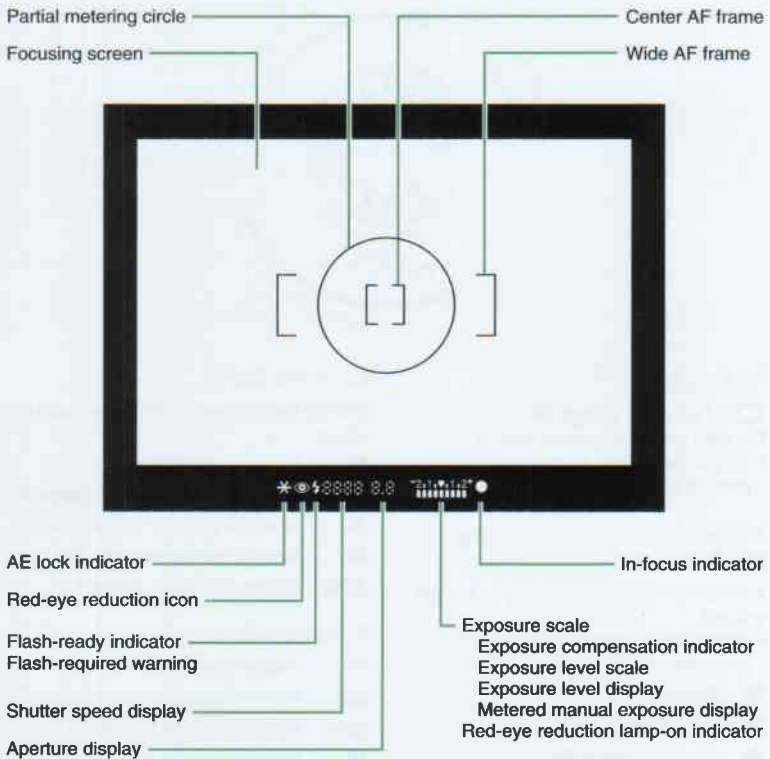

The viewfinder is shown with all the information displayed. The actual information displayed will vary depending on the camera settings and shooting conditions.

## Command Dial

The Command Dial's settings are divided into four zones.

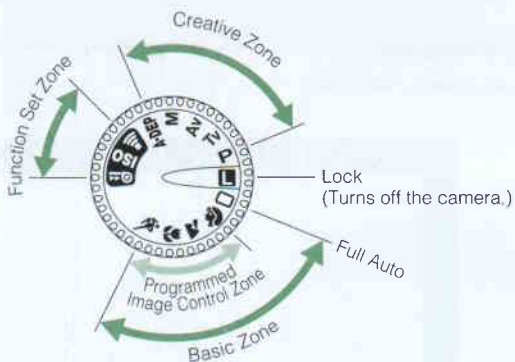

### Basic Zone

**A** : Full Auto (page 24)

For fully automatic picture-taking.

- All you do is point the camera and press the shutter button.

### Programmed Image Control Zone

Fully automatic picture-taking to suit the subject.

- All you do is point the camera and press the shutter button.

**P** : Portrait (page 26)

**L** : Landscape (page 27)

**C** : Close-up (page 28)

**S** : Sports (page 29)

### Creative Zone

Control the camera to obtain the desired effect.

**P** : Program AE (page 36)

**Tv** : Shutter speed-priority AE (page 38)

**Av** : Aperture-priority AE (page 40)

**M** : Manual exposure (page 42)

**A-DEP** : Depth-of-field AE (page 44)

### Function Zone

**Beep** : Beeper (page 49)

**ISO** : Manual ISO speed setting (page 52)

**Reel** : Midroll film rewind (page 21)

**L** : Lock



When not using the camera, turn the Command Dial to **<L>** (Lock) to prevent accidental operation.

This chapter describes the things you need to know and do before you start using your camera.

# 1

## Before You Start



### Attaching the Strap

Pass the end of the strap through the camera's strap eyelet from the bottom. Then pass it through the strap's clasps. Pull the strap to make sure it does not slip out of the clasp.

- The eyepiece cover is also attached to the strap. See page 31.

# Installing the Batteries and Checking the Battery Level

## Installing the Batteries

Use two CR123A (or DL123A) lithium batteries.

---

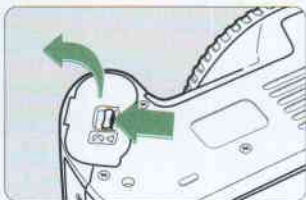

**1** Slide the battery chamber cover lever as shown by the arrow and open the battery chamber cover.

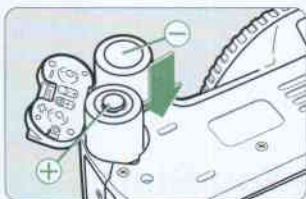

**2** Insert the batteries with the contacts (+ and -) oriented as shown on the battery chamber cover.

- Do not mix old and new batteries.

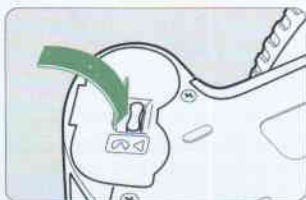

**3** Close the battery chamber cover. Press the cover until it snaps shut.



## Checking the Battery Level

Check the battery level after replacing the batteries and before using the camera.

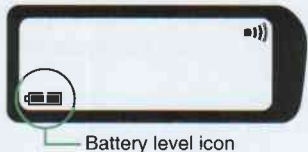

### Turn the Command Dial to any setting except **<B>**.

- The camera will then turn on and the LCD panel will display one of the following battery level icons:

 : Battery level OK.

 : The battery level is low. Keep spare batteries handy.

 : Battery exhaustion is imminent.

**bc** : Replace the batteries. (See page 7.) In this case, the shutter button will not function.

### Battery Service Life (With 24-ex. rolls)

Ambient Temperature	0% Flash Use	50% Flash Use	100% Flash Use
At 20 °C	60 rolls	25 rolls	12 rolls
At -10 °C	35 rolls	15 rolls	7 rolls

- The Battery Service Life table above is based on Canon's testing conditions using an EF 35-80mm f/4-5.6 lens and new batteries.
- Operating the camera without film will still consume battery power. It will reduce the number of rolls that can be taken with the batteries.



If nothing is displayed on the LCD panel, the batteries may have been installed incorrectly. Take out the batteries and install correctly (See page 16).



For places where CR123A (or DL123A) batteries may not be easily available, take spare batteries with you. Also carry spare batteries for extended shooting sessions.

# Mounting and Detaching a Lens

## Mounting a Lens

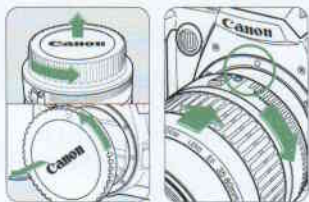

**1** Remove the rear lens cap and the camera body cap.

**2** Align the red dots on the lens and camera and turn the lens as shown by the arrow until it snaps in place.



**3** On the lens, set the focus mode switch to **AF**.

- If the focus mode switch is set to **MF** (or **M** on older lenses), autofocus will not operate.
- While the lens autofocuses, do not touch the lens where it rotates.

**4** Remove the front lens cap.

- Be careful not to lose the front and rear lens caps.

## Detaching the Lens



While pressing the lens release button, turn the lens as shown by the arrow until it stops. Then remove the lens.

# How the Shutter Button Works

The EOS camera's shutter button can be depressed halfway or all the way. There is a click stop at the halfway point.

## Pressing the Shutter Button Halfway or Completely

The shutter button works as described below.

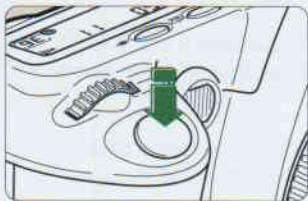

### When it is pressed halfway:

- Autofocusing is activated, and when focus is achieved, the beeper sounds and the viewfinder's in-focus indicator lights in green.
- The shutter speed and aperture are also set and displayed on the LCD panel and in the viewfinder.

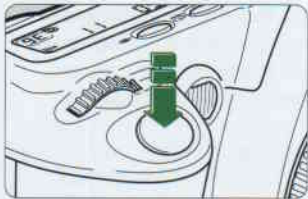

### When it is pressed completely:

- The shutter is released to take the picture and the film advances by one frame.



Camera movement during the moment of exposure is called camera shake. Camera shake can cause blurred pictures.

To prevent blurred pictures due to camera shake:

- Hold the camera steady (see page 22).
- Use the center of your finger to touch the shutter button, grasp the camera with your entire right hand, then press the shutter button gently.

# Loading and Unloading Film

## Loading Film

After you load the film, the camera first winds the entire roll onto the camera's take-up spool. Then each time a picture is taken, one frame of film is rewound back into the film cartridge.

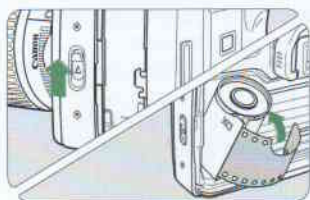

**1** Turn the Command Dial to any setting except <[M]>.

**2** Slide up the camera back lock-release lever to open the camera back.

**3** Insert the film cartridge at an angle as shown in the figure.

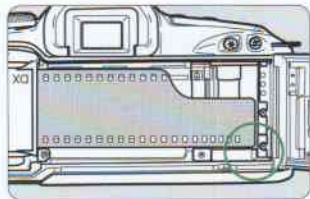

**4** Hold down the film cartridge and pull the edge of the film leader to the orange mark on the camera. Then close the camera back.

- If the edge of the film leader goes beyond the orange mark, push some of the film back into the cartridge.
- After you close the camera back, the film will start winding on the take-up spool and the frame counter will count up. The camera will then make a shutter-release sound and the <[M]> icon and total frame count will be displayed.
- If the frame counter is not displayed, it means that the film was not properly loaded. Take out the film cartridge and load it in the camera again.



- With DX-coded film, the camera automatically sets the film's ISO speed.
- If the film is not DX-coded, set the ISO speed manually. See page 52.



- Infrared film cannot be used with this camera.
- The shutter curtains are manufactured with very high precision. To prevent damage, never touch the shutter curtains. When loading or unloading film, be careful not to touch the shutter curtain with your fingers or the film.

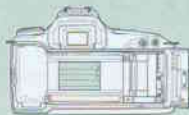

## Unloading Film

After the film's last frame is exposed, the camera rewinds the film automatically.

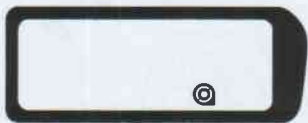

When the film rewind ends, only the <@> icon will be displayed on the LCD panel. Check that this icon is displayed, then open the camera back and unload the film.

## Midroll Film Rewind

To rewind the film before reaching the last frame, follow the steps below.



**1** Turn the Command Dial to <@>.

**2** Press and hold down the <@> button for at least 1 second.

- The film will start rewinding. When the film rewind ends, there will be a shutter-release sound.

**3** Open the camera back and remove the film.



If you remove the film from the camera in midroll without rewinding and then load a new roll of film, the new roll's film leader will only be rewound into the film cartridge. To prevent this, close the camera back and press the shutter button completely before loading a new roll of film.

## Holding the Camera

To avoid taking a blurred shot, hold the camera properly as described below.

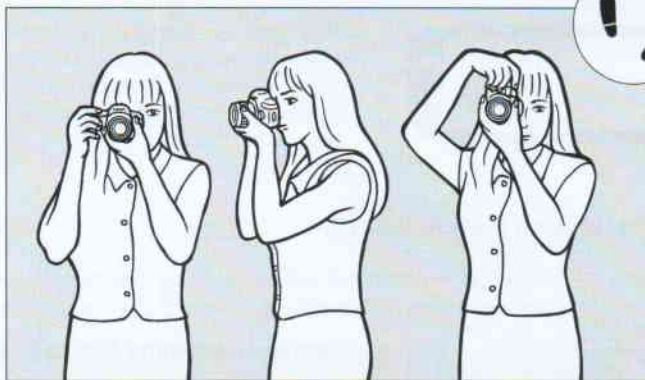

For horizontal shooting.

For vertical shooting.

- Wrap your right hand around the camera grip and grasp firmly. Set your elbow lightly against your body.
- Use your left hand to hold the lens from underneath.
- Press the camera against your forehead and look through the viewfinder.
- Keep one foot slightly ahead of the other for better stability.



This section describes the Command Dial's Basic Zone picture-taking modes: <P>, <Tv>, <Av>, <M>, <A-DEP>, and <OFF>. These modes set all the camera settings automatically. All you do is point the camera and press the shutter button. These modes override the camera's Main Dial <A-DEP> and buttons (except for <EYE>, <ON>, <Q/SL>, and the shutter button). This is to prevent spoiled shots caused by accidental operation of camera controls.

## Camera-Controlled Automatic Shooting

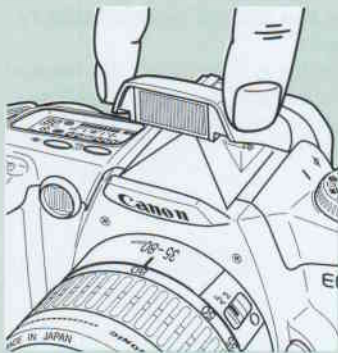

- If the <F> flash icon blinks in the viewfinder while you use a Basic Zone mode, pop up the built-in flash with your fingers. If you pop up the built-in flash beforehand, it will fire automatically under low-light or backlit conditions.
- The settings set automatically by the Basic Zone modes are shown by the "Feature Availability Table" on page 34.

## □ Full Auto Mode

In the Full Auto mode, all you do is point the camera and press the shutter button. Photograph any type of subject automatically. The wide AF frame focuses the subject and anyone can easily take a good shot.

---



**1** Turn the Command Dial to <□>.



Wide AF frame

**2** Look through the viewfinder and aim the wide AF frame on the subject.

- To focus a subject outside the wide AF frame, see page 47.

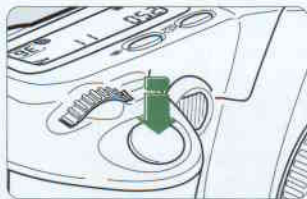

**3** Press the shutter button halfway to focus.

- When focus is achieved, the beeper will sound and the in-focus indicator (●) at the lower right will light.



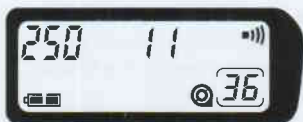

## 4 Check the LCD panel display.

- The shutter speed and aperture will be set automatically and displayed on the LCD panel and in the viewfinder.
- If the <math>\lt; \text{lightning bolt} \gt;></math> icon blinks in the viewfinder in low-light or backlit conditions, pop up the built-in flash. See page 54.

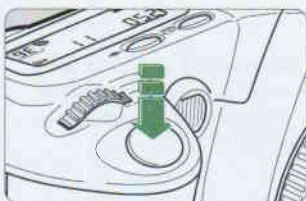

## 5 Compose the shot and press the shutter button completely to take the picture.



If the in-focus indicator blinks, the shutter cannot be released. See pages 48 and 60.



- If you pop up the built-in flash beforehand, it will fire automatically under low-light or backlit conditions.
- See page 54 for notes on using the built-in flash.

## AF-Assist Lamp

In the Basic Zone modes and Creative Zone modes, the AF-assist lamp lights automatically when necessary.

**Under difficult autofocusing conditions, the AF-assist lamp lights automatically to illuminate the subject for autofocusing.**



- The AF-assist lamp is effective up to about 4 meters (13.2 ft).
- Even while an external EOS-dedicated Speedlite is attached to the camera, the camera's AF-assist lamp will be enabled.

## Portrait Mode



This mode blurs the background to make the human subject stand out.

- When focus is achieved, the beeper will sound.
- Holding down the shutter button executes continuous shooting.



**Turn the Command Dial to .**

- The picture-taking procedure is the same as with the Full Auto mode  (page 24).



- Background blur is most effective when the subject is captured from the waist up. Also, the further away the subject is from the background, the more blurred the background will become.
- Using a telephoto lens also blurs the background better. If you have a zoom lens, use the longest focal length. (For example, a 35-80mm zoom lens set to 80 mm.)
- If you pop up the built-in flash beforehand, it will fire automatically under low-light or backlit conditions.
- See page 54 for notes on using the built-in flash.

## Landscape Mode



**This is for sweeping scenery, night scenes, etc.**

- When focus is achieved, the beeper will sound.



**Turn the Command Dial to <  >.**

- The picture-taking procedure is the same as with the Full Auto mode <  > (page 24).



If the shutter speed display blinks, the shutter speed may be too slow to prevent a blurred picture due to camera shake. Using a tripod is recommended. (The shutter speed will still blink even while a tripod is used.)



Using a wide-angle lens will further enhance the depth and breadth of the picture. If you have a zoom lens, use the shortest focal length. (For example, a 35-80mm zoom lens set to 35 mm.)



If the Command Dial is set to <  >, make sure the built-in flash is not popped up. If the built-in flash is popped up in the Landscape mode, the picture may not come out properly.

## Close-up Mode



Use this mode to take close-up shots of flowers, insects, etc.

- When focus is achieved, the beeper will sound.

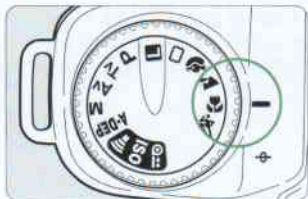

Turn the **Command Dial** to **<🌷>**.

- The picture-taking procedure is the same as with the Full Auto mode **<□>** (page 24).



- Focus the subject at the lens' closest focusing distance.
- If you have a zoom lens, use the longest focal length to obtain a larger magnification.
- For better close-ups, an EF macro lens and Macro Ring Lite ML-3 (both sold separately) are recommended.
- If you pop up the built-in flash beforehand, it will fire automatically under low-light or backlit conditions.
- See page 54 for notes on using the built-in flash.



## Sports Mode



This mode is ideal for sports and fast-moving subjects.

- Holding down the shutter button executes continuous focusing and shooting.



Turn the Command Dial to <🏃>.

- The picture-taking procedure is the same as with the Full Auto mode <📷> (page 24).



- Using ISO 400 or faster film is recommended.
- For sports photography, a telephoto lens with a focal length of 200 mm or 300 mm is recommended.





If the Command Dial is set to <🏃>, make sure the built-in flash is not popped up. If the built-in flash is popped up in the Sports mode, the picture may not come out properly.

## Self-timer

The self-timer can be used in any picture-taking mode. Use a tripod for self-timer shots.



### 1 Press the self-timer button .

- The  icon will be displayed on the LCD panel.
- To cancel the self-timer, press the self-timer button  again or turn the Command Dial to .

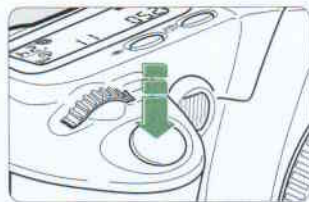
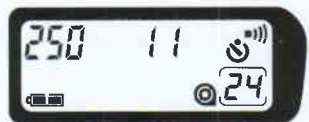

### 2 Look through the viewfinder and press the shutter button completely to start the self-timer.

- The picture-taking procedure is the same as with the Full Auto mode  (page 24).
- The beeper will sound and the shutter will be released 10 sec. later. The beeper beeps slowly during the first 8 seconds and faster during the final two seconds.
- Also, the self-timer display on the LCD panel counts down in seconds.
- If flash is used with the self-timer and red-eye reduction (page 55) has been enabled, the red-eye reduction lamp will light 2 seconds before the picture is taken.



- To cancel the self-timer after it starts, press the self-timer button again.
- When using the self-timer to take a picture of only yourself, first lock the focus (see page 47) on an object at the same distance where you will be in the picture.



Do not stand in front of the camera when you start the self-timer. Doing so will throw off the focus.

## Using the Eyepiece Cover

If you use the self-timer or Remote Switch (sold separately) and take a picture without looking through the viewfinder, stray light may enter the eyepiece and affect the exposure. To prevent this, attach the eyepiece cover on the eyepiece before taking the picture.

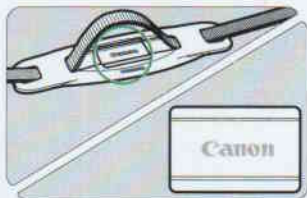

- 1 Remove the eyepiece cover from the camera strap's shoulder pad.**
  - On the wide strap, the eyepiece cover is attached to the strap portion.

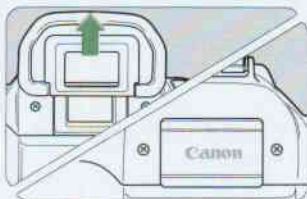

- 2 Remove the eyecup from the eyepiece.**
- 3 Slip on the eyepiece cover over the eyepiece.**

## Imprinting the Date or Time (QD Model only)



The date or time is imprinted on the lower right corner of the picture as shown above.

The QD version of the camera has a quartz date feature which maintains an automatic calendar up to the year 2019. It can imprint the date or time on the photograph as shown in the left photo. The imprinting can also be disabled so nothing is imprinted. The date or time can be imprinted in any picture-taking mode.

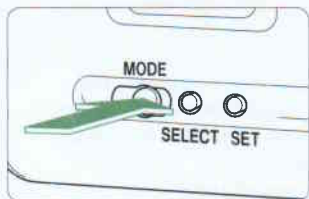

**To change the date/time imprinting format, press the MODE button.**

- Each time the button is pressed, the imprinting format changes in the following sequence as shown on the quartz date display panel:

Year, month, day	'98 <sup>M</sup> 12 24	(1998 Dec. 24)
↓		
Day, hour, minute	24 16:45	(24th 16:45)
↓		
Hyphens	-- -- --	(Blank)
↓		
Month, day, year	<sup>M</sup> 12 24 '98	(Dec. 24, 1998)
↓		
Day, month, year	24 <sup>M</sup> 12 '98	(24 Dec. 1998)

- "M" is displayed above the month.
- The bar above the last two digits is an imprint indicator. It blinks when a picture is taken and the date or time has been imprinted.



## Setting the Date and Time

To set or change the date and time, follow the procedure below.

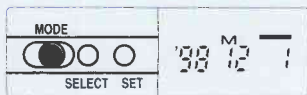

- 1** Press the <MODE> button to display the date or time to be set.



- 2** Press the <SELECT> button so that the digit to be changed blinks.



- 3** Keep pressing the <SET> button until the correct number appears.

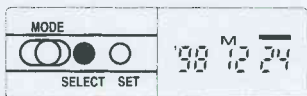

- 4** Press the <SELECT> button until none of the digits blink.

## Replacing the Quartz Date Back's Battery

When the date/time on the quartz date display panel or imprinted photograph looks faded, replace the CR2025 lithium battery as follows. Battery life is about 3 years.

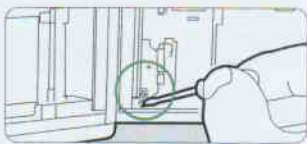

- 1** Open the camera back and loosen the screw to remove the battery chamber cover as shown in the figure.

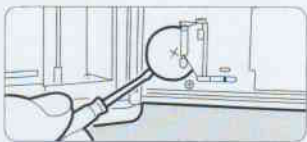

- 2** Take out the battery.
- 3** Insert a new battery with the positive contact (+) facing you. Then reattach the battery chamber cover.
- 4** Close the camera back and set the correct date and time.

# Feature Availability Table

Command Dial Mode	Autofocus		Film Advance		Metering Mode		
	One-Shot AF	AI Focus	Single	Continuous	Evaluative	Center-weighted averaged	Partial
		●	●		●		
	●			●	●		
	●		●		●		
	●		●		●		
		●		●	●		
<b>P</b>		●		●	●		●*
<b>Tv</b>		●		●	●		●*
<b>Av</b>		●		●	●		●*
<b>M</b>		●		●		●	●*
<b>A-DEP</b>	●		●		●		●*

\* Available only while the partial metering button is pressed.

\* In the <M> mode, centerweighted averaging metering is used.

- One-Shot AF** : The exposure setting (shutter speed and aperture) is set when focus is achieved. The picture cannot be taken unless the subject is focused.
- AI Focus AF** : The AF mode is set automatically to suit the subject's movement when the shutter button is pressed.  
If the subject is still, the focus is locked when focus is achieved (One-Shot AF). If the subject is moving, focusing is continuous and predictive AF is used so that the subject is in focus at the moment of exposure.
- Continuous advance** : While the shutter button is held down, the camera can shoot continuously as fast as 1 frame per second.
- Evaluative metering** : This is suited for most picture-taking situations including backlit conditions. The subject's position and brightness, the background, the existing light, backlight conditions, etc., are taken into account to set a suitable exposure setting.
- Partial metering** : The exposure setting is based on the brightness of the area covered by the partial metering circle on the viewfinder screen. It is effective for backlit subjects.
- Centerweighted averaging metering** : The metering is weighted at the center and then averaged for the entire scene.

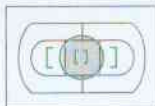
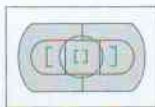



The Creative Zone modes enable you to control the camera to obtain the effect you want. Shutter speed-priority, aperture-priority, and other user-controllable modes are provided. The Creative Zone modes (**P**, **Tv**, **Av**, **M**, and **A-DEP**) are described here along with other advanced operations.

## User-Controlled Shooting

- The  icon indicates the Main Dial.
- If the built-in flash is popped up, it will fire at all times in a Creative Zone mode.

## P Program AE



Like the <□> mode, this is a general-purpose, picture-taking mode. The camera automatically sets the shutter speed and aperture to suit the subject's brightness.



1 Turn the Command Dial to <P>.

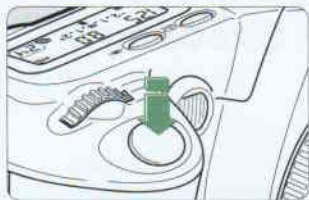

2 Press the shutter button halfway to focus.

- When focus is achieved, the beeper will sound and the in-focus indicator (●) at the lower right will light.



3 Check the LCD panel display.

- The shutter speed and aperture will be set automatically and displayed on the LCD panel and in the viewfinder.
- If the shutter speed and aperture do not blink, a correct exposure will be obtained.
- If the shutter speed and aperture blink, see "Exposure Warnings" on page 56.

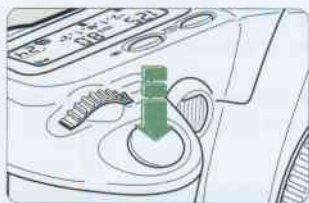

**4** Compose the shot and press the shutter button completely to take the picture.

### The Difference Between **P** and **□**

The **<P>** and **<□>** modes set the same shutter speed and aperture settings for picture-taking. However, the available features are different as shown below.

○: Settable by the user. ×: Not settable by the user.

Feature		<b>P</b>	<b>□</b>
Continuous shooting		○	×
Program shift		○	×
Exposure compensation		○	×
Partial metering/AE lock		○	×
Firing of built-in flash	Fired automatically	×	○
	Fired every time	○	×

### About Program Shift

In the Program AE mode, you can freely change the shutter speed and aperture combination (program) set by the camera while the same exposure value is maintained. This is called program shift.

To shift the program, press the shutter button halfway and turn the **<☀>** until the desired shutter speed or aperture is displayed.

- After the picture is taken with the shifted program, the shifted program is canceled automatically and the original program is restored.
- If the built-in flash is used, the program cannot be shifted.

### 6-sec. Camera Activation

If the shutter button is pressed halfway and then released without taking a picture, the shutter speed and aperture will remain displayed on the LCD panel and in the viewfinder for about 6 seconds.

## Tv Shutter-Speed Priority AE

In this mode, you set the shutter speed and the camera sets the aperture automatically to suit the brightness of the scene. (Tv stands for Time value.)

A fast shutter speed can freeze the motion of a fast-moving subject. Or, a slow shutter speed can blur the subject to give the impression of motion. Set the desired shutter speed with the <  >.



Taken with a fast shutter speed.



Taken with a slow shutter speed.



**1** Turn the Command Dial to <Tv>.



**2** Select the desired shutter speed with the <  >.

- Turn the <  > until the desired shutter speed is displayed.

**3** Press the shutter button halfway to focus the subject.



**4** Check the viewfinder display.

**5** Press the shutter button completely to take the picture.



- If the maximum aperture (the smallest f-number) blinks, the scene is too dark. In such a case, turn the  to set a slower shutter speed until the aperture display stops blinking.



- If the minimum aperture (the largest f-number) blinks, the scene is too bright. In such a case, turn the  to set a faster shutter speed until the aperture display stops blinking.



To photograph a scene on a TV screen, use a shutter speed of 1/15 sec. for best results. Use a tripod to prevent blur.



### Shutter Speed Display

The shutter speed can be set and displayed in full and half stops. Shutter speeds from 2 to 2000 indicate the denominator of the fractional shutter speed. For example, 125 is 1/125 second. For slower shutter speeds, the numeral is appended with the seconds mark (""). For example, 0'7 is 0.7 second and 15" is 15 seconds.

2000 1500 1000 750 500 350 250 180 125 90 60 45 30 20  
15 10 8 6 4 3 2 0'7 1" 1'5 2" 3" 4" 6" 8" 10" 15" 20" 30"

## Av Aperture-Priority AE

In this mode, you set the aperture and the camera sets the shutter speed automatically to suit the brightness of the scene. (Av stands for aperture value.)

A large aperture (small f-number) can blur the background and make the subject stand out.

Or, a small aperture (large f-number) can increase the depth of field to make both the foreground and background look sharp.

Set the desired aperture with the <  >.



Taken with a large aperture.



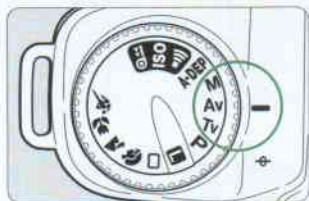

Taken with a small aperture.

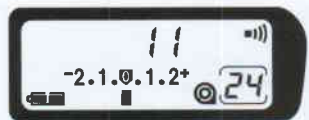

**1** Turn the Command Dial to <Av>.



**2** Select the desired aperture with the <  >.

- Turn the <  > until the desired aperture is displayed.



**3** Press the shutter button halfway to focus the subject.



**4** Check the viewfinder display.

**5** Press the shutter button completely to take the picture.



- If the 30" shutter speed blinks, the scene is too dark. In such a case, turn the <  > to set a larger aperture (smaller f-number) until the shutter speed display stops blinking.



- If the 2000 shutter speed blinks, the scene is too bright. In such a case, turn the <  > to set a smaller aperture (a larger f-number) until the shutter speed display stops blinking.



### Aperture Display

The aperture can be set and displayed in full and half stops as shown below. The larger the number, the smaller the aperture opening will be. The displayable range of apertures depends on the lens mounted on the camera.

1.0 1.2 1.4 1.8 2.0 2.5 2.8 3.5 4.0 4.5 5.6 6.7 8.0 9.5 11 13  
16 19 22 27 32 38 45 54 64

If no lens is mounted on the camera, "00" will be displayed for the aperture setting.

### Taking a Portrait at Night with Flash

When you want to take a picture of someone outdoors at sunset or at night, turn the Command Dial to < **Av** > and set a large aperture (smaller f-number). The flash will illuminate the subject and the background will be exposed with a slow shutter speed. A natural-looking, balanced exposure will result. This is called slow-speed flash sync. See page 54.

In this case, be sure to use a tripod. After the flash fires, the subject should not move until the exposure is completed.

# M Manual Exposure



In this mode, you set the shutter speed and the aperture for total exposure control. The exposure level of the shutter speed and aperture you set is indicated on the exposure level scale. You can check whether the exposure will be suitable or not.

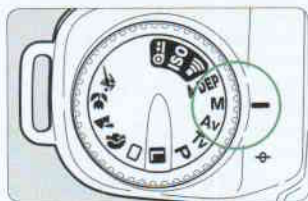

**1 Turn the Command Dial to <M>.**



**2 Select the desired shutter speed with the <  >.**

- Turn the <  > until the desired shutter speed is displayed.



**3** Select the desired aperture by holding down the **<Av>** button and turning the **<Aperture>**.

- Turn the **<Aperture>** until the desired aperture is displayed.



**4** Press the shutter button halfway to focus the subject.



**5** Check the viewfinder display.

**6** Look at the exposure level indicator and adjust the exposure level with the **<Aperture>** if necessary.

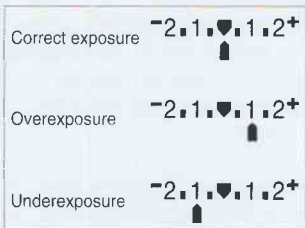

**Correct exposure:** This is the standard reference point for a correct exposure.

**Overexposure:** To achieve the correct exposure, increase the shutter speed or set a smaller aperture.

**Underexposure:** To achieve the correct exposure, decrease the shutter speed or set a larger aperture.

**7** Press the shutter button completely to take the picture.

## A-DEP Automatic Depth-of-Field AE

This mode is for obtaining a wide depth of field automatically between a near subject and far subject. It is effective for group photos and landscapes. The camera uses the wide AF frame to detect the nearest and farthest subjects to be in focus.

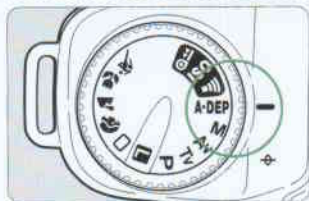

1 Turn the Command Dial to <A-DEP>.



2 Aim the wide AF frame over the subjects and press the shutter button halfway to focus.



3 Check the viewfinder display and take the picture.

- In the sample photo, the focus will be sharp from the left boy in the distance to the right boy in the foreground since both boys are covered by the wide AF frame.



- If the aperture blinks, it indicates that the exposure level is correct but the desired depth of field cannot be achieved. Either use a wide-angle lens or move further away from the subjects.
- In this picture-taking mode, you cannot freely change the shutter speed and aperture. If the camera sets a slow shutter speed, hold the camera steady or use a tripod.
- If flash is used, the result will be the same as using flash in the <P> mode.
- The <A-DEP> mode cannot be used if the lens' focus mode switch is set to **MF** (or **M** on older lenses).

## \* Partial Metering Using AE Lock

In high-contrast situations such as a person spotlighted against a dark background, the exposure may turn out too bright or too dark in certain areas of the photograph. To obtain a more accurate exposure in such cases, use AE lock to lock the subject's exposure level.

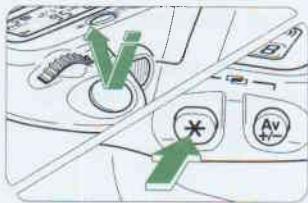

### 1 Press the shutter button halfway and take your finger off shutter button.

- The exposure will be displayed in the viewfinder.

### 2 Aim the partial metering circle over the area where you want to lock the exposure. Press the < \* > button.

- The < \* > indicator lights in the viewfinder and the exposure level locks.
- Let go of the shutter button before pressing the < \* > button. If the < \* > button is pressed while the shutter button is pressed, the < \* > indicator will not light in the viewfinder.
- Keep pressing the < \* > button until the picture is taken.



Partial metering circle.

### 3 While pressing the < \* > button, aim the center AF frame [ ] to focus.

- Compose the shot and keep pressing the < \* > button and the shutter button halfway until you take the picture.



Center AF frame.

### 4 Press the shutter button completely to take the picture.



After step 1, execute steps 2 to 4 within 6 seconds. If you take longer than 6 seconds, you must start over from step 1 again.

# Exposure Compensation

Changing the exposure level set by the camera is called exposure compensation. Exposure compensation can be used to make the picture darker or brighter intentionally. Exposure compensation can be set up to  $\pm 2$  stops in half-stop increments.

**1 Turn the Command Dial to a Creative Zone mode except  $\langle M \rangle$ .**



**2 Press the shutter button halfway and check the exposure display.**



**3 Press and hold down the  $\langle \text{Av} \rangle$  button and turn the  $\langle \text{Exposure Compensation} \rangle$  until the desired exposure compensation amount is set.**

- The plus side of the scale indicates overexposure and the minus side of the scale indicates underexposure.

**-2.1.0.1.2+**

Underexposure  $\leftarrow$  .....  $\blacksquare$  .....  $\rightarrow$  Overexposure

- To cancel the exposure compensation setting, set the exposure level indicator to 0. The exposure compensation setting will not be canceled automatically when the Command Dial is set to  $\langle L \rangle$ .

**4 Take the picture.**



- The exposure compensation setting will be canceled if the Command Dial is set to a Basic Zone mode.
- Assuming that a shutter speed of 1/125 sec. and an aperture of f/5.6 will give a correct exposure, setting the exposure compensation amount to plus or minus 1 stop on the exposure level scale will be equivalent to the following settings:

	-1 stop	$\leftarrow$	0	$\rightarrow$	+1 stop
Shutter Speed	250	$\leftarrow$	125	$\rightarrow$	60
Aperture	8.0	$\leftarrow$	5.6	$\rightarrow$	4.0

## Focusing Off-Center Subjects

If you want to focus an off-center subject not covered by the wide AF frame [  ], follow the AF-lock procedure below.



Wide AF frame

**1** Aim the wide AF frame on the subject, then press the shutter button halfway to focus.

- The in-focus indicator (●) will light in the viewfinder.



**2** Keep pressing the shutter button halfway and recompose the picture as desired.

**3** Press the shutter button completely to take the picture.



### Using the center AF frame for focusing

After pressing the shutter button halfway, you can press the < \* > button to achieve focus and the correct exposure with the center AF frame. This is effective for pinpoint focusing. See page 45.

## When Autofocus Fails (Switching to Manual Focus)

The camera has a high-precision AF system which can focus almost all subjects. However, it can fail to achieve focus (the in-focus indicator blinks) with the subjects listed below.

### Difficult Subjects for Autofocusing

- (a) Low-contrast subjects.  
Example: Blue sky, solid colors on a flat surface, etc.
- (b) Extremely backlit or reflective subjects.  
Example: Automobile with a highly reflective finish.
- (c) Overlapping near and far objects.  
Example: Animal behind bars in a cage.

In such cases, focus an object at the same distance as the subject and lock the focus before recomposing. (See page 47.) Or focus manually by following the procedure below.

### Manual Focusing

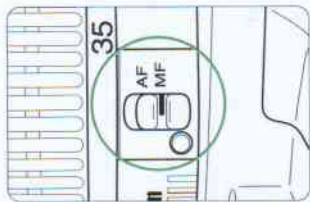

- 1 Set the lens focus mode switch to **MF** (or **M** on older lenses).



- 2 Turn the lens focusing ring until the subject is in focus in the viewfinder.



## ■)) Silencing the In-Focus Beeper

If it is disturbing, the in-focus beeper can be silenced in the Creative Zone modes.



**1** Turn the Command Dial to <■))>.

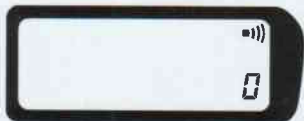

**2** Turn the <☀> until the LCD panel displays "0".

- To enable the in-focus beeper again, set it to "1" again.

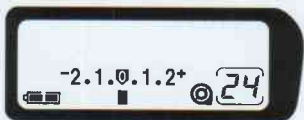

**3** Turn the Command Dial to the previous mode.

- The <■))> icon on the LCD panel will disappear.

# Bulb Exposures

When bulb is set, you can expose the film for as long as you press the shutter button completely. Bulb exposures are useful when long exposures are required for night scenes, fireworks, etc. In this case, Remote Switch RS-60E3 (sold separately) is convenient since it frees you from holding down the shutter button during bulb exposures.

1 Turn the Command Dial to <M>.



2 Turn the <☀> until *bulb* is displayed for the shutter speed.  
• *bulb* follows 30".

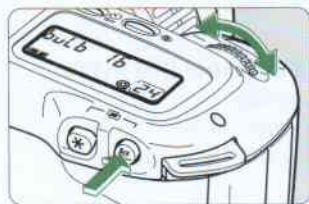

3 Press and hold down the <Av> button and turn the <☀> to set the desired aperture.





4 Frame the shot, then press and hold down the shutter button completely for the duration of the exposure.

- The shutter remains open while the shutter button is pressed completely.
- During bulb exposures, *bulb* blinks on the LCD panel.
- With a new set of batteries, a bulb exposure can be as long as about 6 hours at room temperature.
- A bulb exposure can be combined with multiple exposures (see page 51).

## Multiple Exposures

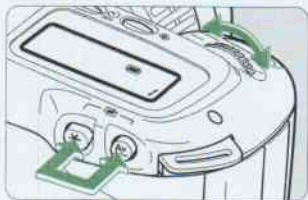
A single frame can be exposed multiple times to obtain a special effect. This is possible in the Creative Zone modes.



**1** Press the **< \* >** and **<  $\frac{A}{\Delta}$  >** buttons simultaneously to display the **<  >** icon on the LCD panel.





**2** Turn the **<  >** to set the desired number of multiple exposures.

- Hold down the **< \* >** and **<  $\frac{A}{\Delta}$  >** buttons while turning the **<  >**.
- The LCD panel will show the number of multiple exposures.
- Up to 9 multiple exposures can be set.
- To cancel the multiple-exposure setting, set the number of multiple exposures to 1.



**3** Compose the shot and press the shutter button completely to take the picture.

- After the first exposure, pressing the shutter button halfway will have the **<  >** icon blink on the LCD panel. This indicates that multiple exposures have been set.
- After the set number of multiple exposures are taken, the film advances to the next frame and the multiple-exposure setting is canceled.
- To cancel the multiple-exposure setting before completing all the multiple exposures, follow steps 1 and 2 to turn off the **<  >** icon.



Before capturing multiple exposures on the same frame of film, exposure compensation must be set. See "Exposure Compensation" on page 46. As a general guide, you should set the exposure compensation amount shown below for the respective number of multiple exposures.

No. of Multiple Exposures	2	3	4
Underexposure Amount	-1.0 stop	-1.5 stop	-2.0 stops

- These are only suggested exposure compensation amounts. The optimum amount depends on the scene. Experiment to find the optimum compensation amount.

## Setting the ISO Film Speed

If the film is not DX-coded or if you want to set a different ISO film speed, you can set the ISO film speed manually. The ISO film speed can be set from 6 to 6400.



- 1 Turn the Command Dial to **<ISO>**.
  - The ISO icon and the current ISO film speed will be displayed on the LCD panel.



- 2 Turn the **<DISP/OK>** until the desired ISO film speed appears on the LCD panel.
- 3 Turn the Command Dial to the desired mode.



The manually-set ISO film speed will be canceled if the film is taken out and DX-coded film is loaded.



When the built-in flash is popped up, flash photography is easy.

- When using a Basic Zone mode, pop up the flash if the  $\langle \text{lightning bolt} \rangle$  icon blinks. If the built-in flash is already popped up, it will fire automatically when necessary in low-light or backlit conditions.
- When using a Creative Zone mode, you can fire the flash at anytime by popping up the built-in flash. You can also set the flash aperture and sync speed (1/90 sec. or slower) and the flash will be controlled automatically to suit the flash aperture you have set.

## Using the Built-in Flash

### Using an External EOS-Dedicated Speedlite

When an external EOS-dedicated, EX-series Speedlite like the 220 EX or 380 EX is attached to the camera, flash photography is as easy as with the built-in flash. An external Speedlite is effective for large group photos, portrait lighting effects, etc., when a high flash output is required.

The features available with an EX-series Speedlite differ depending on the camera. Since the EOS 88 is a Type-B camera, see the section in the Speedlite's Instructions which applies to Type-B cameras.

# Using the Built-in Flash

## In a Basic Zone Mode

If the <⚡> icon blinks, pop up the built-in flash. The built-in flash will fire automatically in low-light or backlit conditions.

## In a Creative Zone Mode

When using a Creative Zone mode, pop up the built-in flash.

- P** : Use this mode for automatic flash photography. The flash sync speed and flash aperture will be set automatically as with the <□> (Full Auto) mode.
- Tv** : Use this mode if you want to use a flash sync speed slower than 1/90 sec. The camera will set the flash aperture automatically to obtain a correct flash exposure.
- Av** : Use this mode if you want to set the flash aperture. With this mode, you can obtain a balanced flash exposure between the subject and background. The camera will set a slow sync speed automatically. The flash illuminates the subject while the background is exposed with a long shutter speed.
- Be sure to use a tripod when a slow sync speed is set.
- M** : This mode enables you to set both the flash sync speed and flash aperture. The subject is properly exposed with the flash and the background is exposed with the flash sync speed and aperture you have set.
- A-DEP** : The result will be the same as using the <P> mode.



- If the flash sync speed is set faster than 1/90 sec. in the <Tv> or <M> mode, it will be reset automatically to 1/90 sec.
- An external, EOS-dedicated Speedlite and the built-in flash cannot be used together.
- Before attaching an EOS-dedicated Speedlite to the camera, push down the built-in flash if it is popped up.



- When using the built-in flash, stay at least 1 meter (3.3 ft) away from the subject. Otherwise, part of the photo will look dark.
- When using the built-in flash, detach any hood attached to the lens. A lens hood will partially obstruct the flash coverage.

**Built-in Flash Range** (With EF 35-80mm f/4-5.6 lens)

ISO	35 mm		80 mm	
	Negative Film	Reversal Film	Negative Film	Reversal Film
100	1 - 4.2 m / 3.3 - 13.8 ft	1 - 3 m / 3.3 - 9.9 ft	1 - 3 m / 3.3 - 9.9 ft	1 - 2.1 m / 3.3 - 6.9 ft
400	1 - 8.4 m / 3.3 - 27.7 ft	1.2 - 6 m / 3.9 - 19.8 ft	1 - 6 m / 3.3 - 19.8 ft	1 - 4.2 m / 3.3 - 13.8 ft

**Red-Eye Reduction**

When flash is used in a low-light environment, the subject's eyes may look red in the photograph. "Red eye" happens when the light from the flash reflects off the pupils of the eyes.

The camera's red-eye reduction feature uses red-eye reduction lamp to shine a gentle light into the subject's eyes to narrow the pupil diameter or iris. A smaller pupil reduces the chances of red eye from occurring. Red-eye reduction can be set in any picture-taking mode.

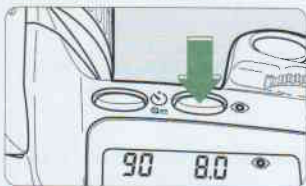
**1 Press the <eye> button.**

- Check that the <eye> icon appears on the LCD panel!
- To cancel red-eye reduction, press the <eye> button again.



Red-eye reduction lamp-on indicator

**2 Pop up the built-in flash.**

- When you press the shutter button completely, the red-eye reduction lamp will light and the picture will be taken about 1 sec. later.
- The picture cannot be taken while the red-eye reduction lamp is lit.











- The red-eye reduction lamp can also light while an external, EOS-dedicated Speedlite (EX series) is attached to the camera.
- Note that some subjects may be responsive to red-eye reduction while others may not be.

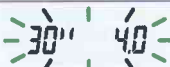

- Red-eye reduction can be effective only when the subject looks at the red-eye reduction lamp. Encourage the subject to look at the lamp.
- To increase the effectiveness of red-eye reduction, make the room brighter or move closer to the subject.

# Reference Section

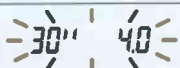
## Exposure Warnings (Blinking Displays)

Command Dial Mode	Warning (Blinking)	Description	Countermeasures
<b>P</b>	 30" shutter speed and lens' maximum aperture	The subject is too dark.	Use flash.
	 1/2000 shutter speed and lens' minimum aperture	The subject is too bright.	Attach a neutral density filter to the lens or use a slower film.
<b>Tv</b>	 Lens' maximum aperture	The picture will be underexposed.	Turn the Main Dial to set a slower shutter speed.
	 Lens' minimum aperture	The picture will be overexposed.	Turn the Main Dial to set a faster shutter speed.
<b>Av</b>	 30" shutter speed	The picture will be underexposed.	Turn the Main Dial to set a larger aperture.
	 1/2000 shutter speed	The picture will be overexposed.	Turn the Main Dial to set a smaller aperture.
<b>A-DEP</b>	 Lens' minimum aperture	The desired depth of field cannot be obtained.	1) Move away from the subject and try again. 2) With a zoom lens, use the shortest focal length.
	 30" shutter speed and lens' maximum aperture	The subject is too dark.	Use flash. The result will be the same as using the <P> mode.
	 1/2000 shutter speed and lens' minimum aperture	The subject is too bright.	Attach a neutral density filter to the lens or use a slower film.



## Flash Sync Speeds and Flash Apertures

Command Dial Mode	Sync Speed	Flash Aperture
<b>P</b>	The sync speed is set automatically to 1/90 sec.	The flash aperture is set automatically according to the TTL program.
<b>Tv</b>	Any sync speed 1/90 sec. or slower can be set manually.*	The flash aperture is set automatically to match the sync speed you set.
<b>Av</b>	The sync speed is set automatically within a range of 30" to 1/90 sec. to match the flash aperture you set.	You set the flash aperture manually.
<b>M</b>	Any sync speed 1/90 sec. or slower can be set manually.*	

\* If the sync speed is set faster than 1/90 sec., it will be reset automatically to 1/90 sec.

## AF Modes and Film Advance Modes

Film Advance Mode	One-Shot AF	AI Servo AF
<b>Single</b>	The picture cannot be taken until focus is achieved. When focus is achieved, it also locks at the same time. The evaluative metering's exposure reading is also locked. (The exposure setting is retained before the picture is taken.)	Autofocusing continues to match the subject's movement. The exposure setting is determined at the moment of exposure.
<b>Continuous</b>	The same conditions as above apply during continuous shooting (at about 1 frame per second).	The same conditions as above apply during continuous shooting. Autofocusing continues during continuous shooting (at about 1 frame per second).

# Reference Section

## Basic Photography Terms

### Exposure

Exposure occurs when the film is exposed to light. Correct exposure is attained when the film is exposed to a proper amount of light in accordance with the film's sensitivity to light. The correct exposure is adjusted with the camera's shutter speed and aperture.

### Shutter speed

The shutter speed is the length of time the camera's shutter opens to expose the film to the light coming through the lens. The shutter speed is displayed on the camera's LCD panel and in the viewfinder. It ranges from 30 to 1/2000 sec. and bulb.

### Aperture

The aperture setting (f-number) indicates the size of the aperture opening in the lens. It is used to adjust the amount of light striking the film. The aperture setting is displayed on the camera's LCD panel and in the viewfinder. It can range anywhere from 1.0 to 64, depending on the lens attached to the camera.



### ISO film speed

The ISO film speed indicates the film's sensitivity to light. The higher the film speed, the more sensitive the film is. Therefore, ISO 400 and higher-speed films are suited for low-light conditions. The ISO film speed is set in accordance with standards set by the International Standards Organization (ISO).

A film speed from 6 to 6400 can be set with the camera. The film speed is displayed on the LCD panel and in the viewfinder.

## Depth of field

This is the range where acceptable focus can be achieved in front of and behind the point of optimum focus. The smaller the aperture (the larger the f-number), the deeper the depth of field. And the larger the aperture (the smaller the f-number), the shallower the depth of field.

The depth of field is affected as described below:

- (1) A smaller aperture (a larger f-number) increases the depth of field.  
... For example,  $f/8$  obtains a greater depth of field than  $f/4.5$ .
- (2) A lens with a shorter focal length increases the depth of field.  
... A wide-angle lens obtains a deeper depth of field than a telephoto lens.
- (3) A longer distance between the camera and subject increases the depth of field.
- (4) The depth of field behind the point of optimum focus is longer than the depth of field in front of the point of optimum focus.

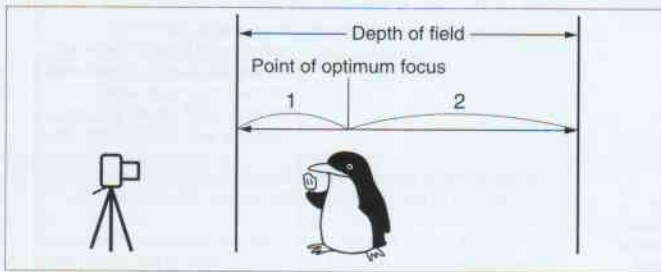

Aperture set to  $f/2$ .



Aperture set to  $f/22$ .

# Reference Section

## Troubleshooting Guide

If you have a problem with the camera, first refer to this Troubleshooting Guide.

Problem	Probable Cause	Solution	Page
1. Nothing is displayed on the LCD panel.	The batteries are exhausted.	Replace the batteries with new ones.	16
	The batteries have been installed incorrectly.	Install the batteries correctly.	16
2. The shutter does not release.	The film has not been loaded correctly. (The frame No. is not displayed on the LCD panel.)	Load the film correctly.	20
	Rewound film is still in the camera. (The frame counter on the LCD panel is blank.)	Take out the film cartridge and load a new roll of film.	20
	Focus has not been achieved. (The in-focus indicator in the viewfinder is blinking.)	Press the shutter button halfway until focus is achieved. If focus still cannot be achieved, set the focus mode switch on the lens to <b>MF</b> (or <b>M</b> ) and focus manually with the focusing ring.	19 48
3. The photograph is out of focus.	The focus mode switch on the lens was set to <b>MF</b> (or <b>M</b> ).	Set the focus mode switch on the lens to <b>AF</b> (Autofocus).	18
	The shutter speed was too slow to prevent blur caused by camera shake.	Press the shutter button gently without shaking the camera or use a faster shutter speed.	19
4. <i>bc</i> is displayed on the LCD panel.	The battery level is very low.	Replace the batteries with new ones and check that <i>bc</i> has turned off and that the battery level is displayed on the LCD panel.	17
	The camera is not operating properly.	Press the shutter button halfway. <i>bc</i> should turn off and the battery level icon should be displayed. * If <i>bc</i> is still displayed after you execute the above procedure, the camera needs repair. Take it to the nearest Canon Service Center.	17 Back cover

## Major Accessories (Sold separately)



### Grip GR-80TP

Grip GR-80TP enlarges the camera grip to enhance holding ease. It can also unfold as a mini-tripod for self-timer or low-angle shots.



### Eyepiece Extender EP-EX15

When attached to the camera, this eyepiece extender extends the EOS camera's eye relief by 15 mm. The viewfinder magnification also becomes 0.5x.



### Dioptric Correction Lens E

The camera's eyepiece lens is -1 diopter. Attaching a dioptric correction lens E on the eyepiece allows near- or far-sighted users to see the viewfinder clearly without eyeglasses. Ten dioptric correction lenses are available. When choosing a dioptric correction lens, attach it to the eyepiece and look through the viewfinder to see if it suits your vision.

- The number on the dioptric correction lenses indicates the diopter when it is attached to the camera's eyepiece. It is not the diopter of the dioptric correction lens itself.



### Remote Switch RS-60E3

Dedicated cable release for a tripod-mounted camera. Ideal for close-up shots and bulb exposures. Connects to the camera's remote control jack.

## Reference Section



### Battery Pack BP-8

An external battery pack housing widely-available, size-AA batteries which can power the camera in place of CR123 (or DL123A) lithium batteries. Handy when lithium batteries are not available.



### EOS-Dedicated EX-Series Speedlites

These include the high-output 380EX (Guide No. 38 at ISO 100 in meters) and the compact 220EX (Guide No. 22 at ISO 100 in meters). Either can be mounted on the camera's hot shoe.

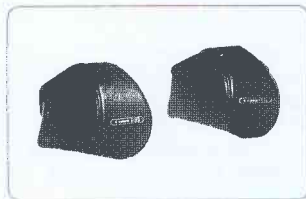

### Camera Case EH8-L and EH8-LL

Dedicated case which accommodates the camera with any of the following lenses attached:

EH8-L: EF 35–80mm f/4–5.6 III

EH8-LL: EF 28–80mm f/3.5–5.6

EF 80–200mm f/4.5–5.6 II



When using an external flash unit, an EOS-dedicated Speedlite is recommended. Using a flash unit (equipped with electrical contacts on the hot shoe foot), high-voltage flash unit, or flash accessories dedicated to a different brand may result in camera misoperation or malfunction.

## Specifications

### Type

Type .....	35mm AF/AE single-lens reflex camera with focal-plane shutter, built-in winder, and built-in flash. The QD model also has a quartz date back.
Picture size .....	24 mm × 36 mm
Compatible lenses .....	Canon EF lenses
Lens mount .....	Canon EF mount (Fully-electronic control)

### Viewfinder

Type .....	Eye-level pentaprism with roof mirror
Picture coverage .....	90% vertical & horizontal
Magnification .....	0.7× (with 50mm lens focused at infinity).
Standard diopter .....	-1 diopter (18.5mm eye relief)
Focusing screen .....	Fixed, New Laser-matte screen
Viewfinder information .....	① Within the viewfinder screen AF frames, partial metering circle. ② Below viewfinder screen Shutter speed, aperture, exposure compensation amount, AE lock, flash-ready indicator, flash-on icon, red-eye reduction icon, in-focus (AF or MF) indicator
Mirror .....	Quick-return half mirror (no vignetting with EF 600mm f/4L USM lens or a shorter lens).

### Exposure Control

Metering system .....	TTL metering at maximum aperture with a 6-zone SPC (silicon photocell). ① Evaluative metering (linked to 3 focusing points) ② Partial metering (Automatically set with AE lock, covering approx. 9.5% of viewfinder screen.) ③ Centerweighted averaging metering (Automatically set in manual exposure mode)
Picture-taking modes .....	① Program AE (shiftable), ② Shutter speed-priority AE, ③ Aperture-priority AE, ④ Depth-of-field AE, ⑤ Full Auto, ⑥ Four Programmed Image Control modes (Portrait, Landscape, Close-up, Sports), ⑦ Autoflash exposure: TTL program flash AE with EX-series Speedlites, TTL program flash AE with the built-in flash, A-TTL program flash AE with EZ-series Speedlites, ⑧ Manual
Camera-shake warning .....	In Basic Zone modes, the shutter speed display blinks (at 2 Hz) if it is slower than the reciprocal of the lens focal length
Metering range .....	EV 2-20 (at 20°C and normal humidity with a 50mm f/1.4 lens, ISO 100)
ISO Film Speed Range .....	ISO 6-6400 (set automatically for DX-coded film within ISO 25-5000 in one-third steps)
Exposure compensation .....	Manual exposure compensation: ±2 stops in half stops.
AE lock .....	① Auto AE lock Automatic AE lock when focus is achieved in the One-Shot AF and evaluative metering modes. ② With AE lock button (and shutter button) AE locks for the area covered by the partial metering circle.
Multiple exposures .....	Up to 9 multiple exposures (cancels automatically after all multiple exposures are taken)

# Reference Section

## ■Autofocus

- AF control .....TTL-CT-SIR with multiple BASIS
- Focusing points.....3 (1 + 1)
- AF working range.....EV 1.5-18 (at ISO 100)
- Focusing point selection ...Automatic
- Focusing modes .....① One-Shot AF: AF locks when focus is achieved. Shutter can be released only when focus is achieved.
- ② AI Focus AF: If the subject focused in the One-Shot AF mode starts moving forward or back, the mode switches to AI Servo AF automatically.
- ③ Manual focusing: Enabled by setting the lens' focus mode switch to MF (or M) and turning the focusing ring.
- AF-assist beam .....When necessary, the built-in AF-assist lamp lights automatically.

## ■Shutter

- Type.....Vertical-travel, focal-plane shutter with all speeds electronically-controlled.
- Shutter speeds.....30 to 1/2000 sec. (in half-stop increments) and bulb
- Maximum flash sync .....1/90 sec. (X-sync)
- Shutter release .....Soft-touch, electro-magnetic release.
- Self-timer .....Electronically-controlled for 10-sec. delay.

## ■Film Transport

- Film loading .....Automatic with prewind system
- Film advance .....Automatic. ① Single-frame ② Continuous (Approx. 1 frame per sec. max.)
- Film rewind .....① Automatic at the end of the roll.
- ② Midroll rewind enabled with Command Dial and midroll film rewind button.
- Film rewind noise level .....Approx. 60 dB

## ■Built-in flash

- Type .....Retractable TTL auto flash (serially controlled)
- ① Guide No. 12 / 39 (ISO 100 in m/ft)
- ② Recycling time Approx. 2 sec.
- ③ Flash coverage 28mm lens covered.
- Flash aperture.....① In Full Auto and P modes: Automatically set by the TTL program.
- ② In the Av and manual modes: Manually set.
- ③ In Tv mode: Automatically set to match the shutter speed.
- Flash sync speed.....① In Full Auto and P modes: Automatically set to 1/90 sec.
- ② In Av mode: Automatically set within 30° to 1/90 sec. to match the aperture.
- ③ In Tv and manual modes: Manually set to 1/90 sec. or slower in half-stop increments.
- Flash metering .....Off-the-film TTL autoflash metering (linked to the 3 focusing points).
- Flash range .....With color negative film and f/1.4 lens:  
ISO 100: 1 - 12 m / 3.3 - 40 ft ISO 400: 1 - 24 m / 3.3 - 80 ft
- Red-eye reduction .....Built-in red-eye reduction lamp can be enabled or disabled in all picture-taking modes. The shutter release is locked for approx. 1.25 sec.



**Other Specifications**

Flash contacts.....	X-sync for direct connection on hot shoe.
External Speedlite compatibility...	Compatible with A-TTL and TTL autoflash systems.
Remote control .....	2.5mm dia. terminal provided for optional Remote Switch RS-60E3.
Power source.....	Two CR123A (or DL123A) lithium batteries.
Battery service life .....	Number of 24-exposure rolls with 50% flash use: Approx. 25 rolls at 20 C    Approx. 15 rolls at -10 C
Battery check .....	One of three battery levels is displayed automatically when the Command Dial is released from L.
Dimensions (mm).....	145 (W) × 92 (H) × 61.9 (D)
Weight (body only).....	345-g (QD: +15 g)

# Reference Section

## OPTIONAL BP-8 AA BATTERY PACK

Use the BP-8 AA Battery Pack if you want to use AA-size batteries. Either AA-size alkaline (LR6) or AA-size Ni-Cd (KR15/51) batteries can be used.



Alkaline-manganese or Ni-Cd batteries are recommended. AA-size lithium batteries should not be used as they have a high voltage level which can damage the camera's electronic circuits.

### Nomenclature

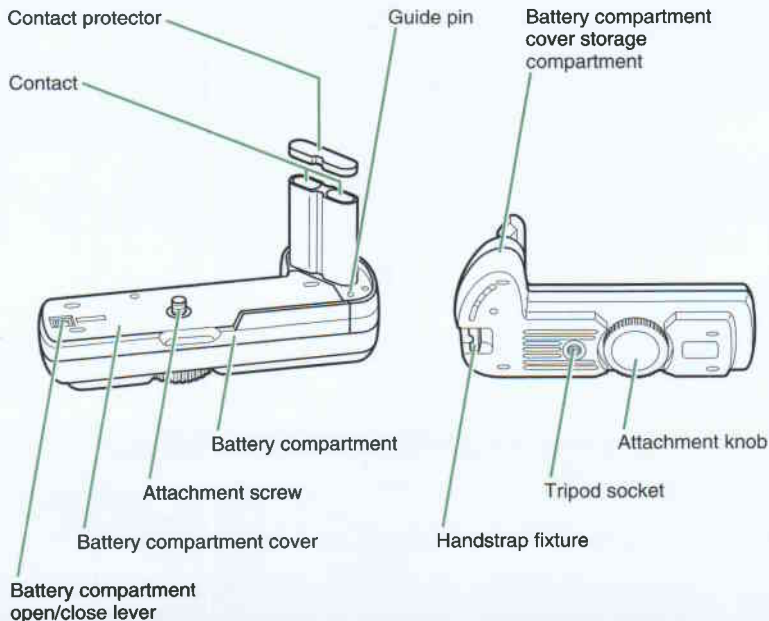

## Battery installation

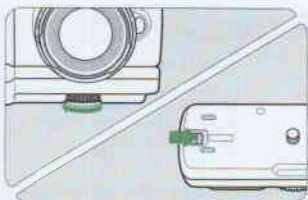

**1** Turn the attachment knob in the direction of the arrow and remove the AA Battery Pack from the camera.



**2** Slide the battery magazine lever to open and remove the battery compartment cover.

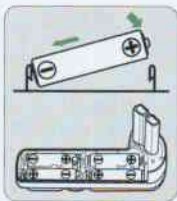

**3** Insert the batteries as indicated on the battery compartment, ensuring that the positive and negative terminals of each battery are oriented correctly. Insert the battery's negative terminal first and slightly press the battery pack's negative contact while fitting in the battery's positive terminal.

**4**

Put on the battery compartment cover and slide the battery compartment as shown by the arrow to lock the cover.

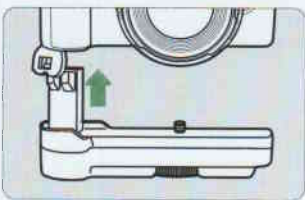

**5**

The AA Battery Pack's contact unit is now housed in the camera's battery compartment. Put the camera's battery compartment cover in the storage compartment in the AA Battery Pack's battery compartment.

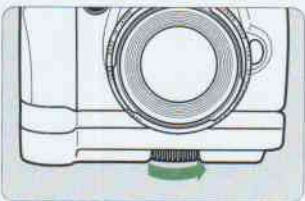

**6**

Turn the attachment knob in the direction of the arrow until it stops.

# Reference Section

## Shooting Capacity in Rolls Using the AA Battery Pack

Temperature	Shooting Capacity (Rolls) (Without Flash)	
	AA-size alkaline-manganese batteries	AA-size Ni-Cd batteries
Normal temperature (+20°C)	100	75
Low temperature (-10°C)	5	50

- Test data based on Canon's Standard Test Method, using new batteries, a 35-80mm F4.5-5.6 III lens and 24 exposure film.
- Autofocus operation or taking shots without film will reduce the overall shooting capacity.



It is possible to remove the AA Battery Pack and use lithium batteries (CR123A/DL123A). If you use lithium batteries, please refer to page 16.



1. The AA Battery Pack is intended for use with LR6 AA-size alkaline-manganese batteries or R15/51 AA-size Ni-Cd batteries only. No other battery types should be used.
2. Do not use different battery types together in the AA Battery Pack (such as using alkaline-manganese and Ni-Cd batteries together).
3. When changing the batteries of the AA Battery Pack, change all four batteries at the same time.
4. Be sure that the positive and negative terminals are oriented correctly to prevent a short circuit.

Lens		EF 35-80mm F/4-5.6 III	EF 38-76mm F/4.5-5.6	EF 80-200mm F/4.5-5.6 II
Angle of view	Diagonal extent	63° - 30°	60° - 32°	30° - 12°
	Vertical extent	38° - 17°	34° - 18°	17° - 7°
	Horizontal extent	54° - 25°	50° - 27°	25° - 10°
Lens construction (elements/groups)		8/8	6/6	10/7
Min. aperture		f/22-f/32	f/22-f/27	f/22-f/27
Focusing distance range		0.4 m - infinity	0.58 m - infinity	1.5 m - infinity
Max. magnification (Wide/Tele)		0.11/0.23x	0.08/0.15x	0.65/0.16x
Filter size and attachable quantity		52mm, 1	52mm, 1	52mm, 1
Max. diameter × length		65 × 63.5 mm	65 × 63.8 mm	69 × 78.5 mm
Weight		175 g	155 g	250 g
Hood (Sold separately)		EW-54 II	EW-54	ET-54

\* All specifications have been obtained through Canon's Standard Test Methods.

\* Product specifications and physical appearance are subject to change without notice.

# Index

<b>A</b>	
Accessories .....	61
AE Lock .....	45
AF Modes and Film Advance Modes .....	57
AF-Assist Lamp .....	33
AI Focus AF .....	24
Aperture .....	58
<b>Av</b> Aperture-Priority AE .....	40
Autofocus failure (Switching to Manual Focus) .....	48
<b>A-DEP</b> Automatic Depth-of-Field AE .....	44
<b>B</b>	
Basic Zone .....	14
Batteries	
Installation .....	16
Level check .....	17
Battery Service Life .....	17
<b>bz</b> icon blinks .....	7
Beeper, silencing .....	49
BP-8 AA Battery Pack (optional) .....	66
Built-in flash, using .....	54
Built-in Flash Range .....	55
Bulb exposure .....	50
<b>C</b>	
Center-weighted averaged metering .....	34
<b>C</b> Close-up Mode .....	28
Command Dial .....	14
Continuous shooting .....	34
Creative Zone .....	14
<b>D</b>	
Date or Time	
Changing .....	33
Imprinting .....	32
Depth of field .....	59
<b>E</b>	
Evaluative metering .....	34
Exposure .....	58
Exposure compensation .....	46
Exposure Warnings (Blinking Displays) .....	56
External EOS-dedicated Speedlites .....	53
Eyepiece cover .....	31
<b>F</b>	
Feature Availability Table .....	34
Film	
Loading .....	20
Midroll rewind .....	21
Setting film speed .....	52
Speed .....	58
Unloading .....	20
Flash Sync Speeds and Flash Apertures .....	57
Focusing Off-Center Subjects .....	47
<b>Q</b> Full Auto Mode .....	24
Function Set Zone .....	14
<b>H</b>	
Holding the Camera .....	22
<b>L</b>	
<b>L</b> Landscape Mode .....	27
LCD panel .....	12
Lens	
Mounting and detaching .....	18
Specifications .....	69
<b>M</b>	
<b>M</b> Manual Exposure .....	42
Manual focusing .....	48
<b>M</b> Multiple Exposures .....	51
Nomenclature .....	10
<b>O</b>	
One-Shot AF .....	34
<b>P</b>	
<b>P</b> and <b>Q</b> , differences .....	37
Partial metering .....	34
* Partial Metering Using AE Lock .....	45
<b>P</b> Portrait Mode .....	26
<b>P</b> Program AE .....	36
Program shift .....	37
Programmed Image Control Modes .....	14
<b>Q</b>	
Quartz data battery replacement .....	33
<b>R</b>	
Red-eye reduction .....	55
<b>S</b>	
<b>S</b> Self-timer .....	30
Shutter button .....	19
Complete pressing .....	19
Halfway pressing .....	19
Shutter speed .....	58
<b>Tv</b> Shutter-Speed Priority AE .....	38
6-sec. camera ON .....	37
<b>S</b> Sports Mode .....	29
Strap, how to attach .....	15
<b>T</b>	
Taking a Portrait at Night with flash .....	41
Troubleshooting Guide .....	60
<b>V</b>	
Viewfinder information .....	13

This device complies with Part 15 of the FCC Rules. Operation is subject to the following two conditions: (1) This device may not cause harmful interference, and (2) this device must accept any interference received, including interference that may cause undesired operation.

Do not make any changes or modifications to the equipment unless otherwise specified in the instructions. If such changes or modifications should be made, you could be required to stop operation of the equipment.

This equipment has been tested and found to comply with the limits for a class B digital device, pursuant to part 15 of the FCC Rules. These limits are designed to provide reasonable protection against harmful interference in a residential installation. This equipment generates, uses and can radiate radio frequency energy and, if not installed and used in accordance with the instructions, may cause harmful interference to radio communications.

However, there is no guarantee that interference will not occur in a particular installation. If this equipment does cause harmful interference to radio or television reception, which can be determined by turning the equipment off and on, the user is encouraged to try to correct the interference by one or more of the following measures:

- Reorient or relocate the receiving antenna.
- Increase the separation between the equipment and receiver.
- Consult the dealer or an experienced radio/TV technician for help.

This digital apparatus does not exceed the Class B limits for radio noise emissions from digital apparatus as set out in the interference-causing equipment standard entitled "Digital Apparatus", ICES-003 of the Industry Canada.



The CE Mark is a Directive conformity mark of the European Community (EC)

# Canon

**CANON INC.** 30-2, Shimomaruko 3-chome, Ohta-ku, Tokyo 146-8501, Japan

**U.S.A.** **CANON U.S.A., INC.**

For all inquiries concerning this camera, call toll free in the U.S. 1-800-828-4040 or write to: Customer Relations, Canon U.S.A., Inc. One Canon Plaza, Lake Success, N.Y. 11042-1198

**CANADA**

**CANON CANADA INC. HEADQUARTERS**

6390 Dixie Road, Mississauga, Ontario L5T 1P7, Canada

**CANON CANADA INC. MONTREAL BRANCH**

5990, Côte-de-Liesse, Montréal Québec H4T 1V7, Canada

**CANON CANADA INC. CALGARY OFFICE**

2828, 16th Street, N.E. Calgary, Alberta T2E 7K7, Canada

For all inquiries concerning this camera, call toll free in Canada 1-800-828-4040

**EUROPE, AFRICA  
& MIDDLE EAST**

**CANON EUROPA N.V.**

Bovenkerkerweg 59-61, P.O. Box 2262, 1180 EG Amstelveen, The Netherlands

**CANON PHOTO VIDEO FRANCE S.A.**

102, avenue Charles de Gaulle 92250 La Garenne Colombes, France

**CANON UK LTD.**

Brent Trading Centre North Circular Road, London NW10 0JF, United Kingdom

**CANON EURO-PHOTO G.m.b.H**

Siemensring 90-92, D-47877 Willich, Germany

**CANON ITALIA S.p.A**

Palazzo L, Strada 6, 20089 Rozzano, Milanofiori, Milano, Italy

**CANON Benelux N.V./S.A.**

Bessenveldstraat 7, 1831 Diegem (Machelen), Belgium

**CANON Schweiz AG**

Geschäftsbereich Wiederverkauf, Industriestrasse 12, CH-8305 Dietlikon, Switzerland

**CANON G.m.b.H.**

Oberlaaerstrasse 233, 4th floor, 1100 Wien, Austria

**CENTRAL &  
SOUTH AMERICA**

**CANON LATIN AMERICA, INC. DEPTO DE VENTAS**

6505 Blue Lagoon Drive, Suite 325, Miami, FL33126 U.S.A.

**CANON LATIN AMERICA, INC. CENTRO DE SERVICIO Y REPARACION**

Apartado 2019, Zona Libre de Colón, República de Panamá

**ASIA**

**CANON SINGAPORE PTE. LTD.**

79 Anson Road #09-01/06 Singapore 079906

**OCEANIA**

**CANON AUSTRALIA PTY. LTD.**

1 Thomas Holt Drive, North Ryde, N S W. 2113, Australia

**CANON NEW ZEALAND LTD.**

Fred Thomas Drive, P.O. Box 33-336, Takapuna, Auckland, New Zealand

**JAPAN**

**CANON SALES CO., INC.**

12-15, Mita, 3-Chome, Minato-ku, Tokyo 108-8011, Japan

This Instructions booklet is dated January 1999. For information on the camera's compatibility with system accessories marketed after this date, contact your nearest Canon Service Center.



## Free Manuals Download Website

<http://myh66.com>

<http://usermanuals.us>

<http://www.somanuals.com>

<http://www.4manuals.cc>

<http://www.manual-lib.com>

<http://www.404manual.com>

<http://www.luxmanual.com>

<http://aubethermostatmanual.com>

Golf course search by state

<http://golfingnear.com>

Email search by domain

<http://emailbydomain.com>

Auto manuals search

<http://auto.somanuals.com>

TV manuals search

<http://tv.somanuals.com>