

# Canon

## Canon Customer Support

Canon Inc.  
30-2 Shimomaruko 3-chome, Ohta-ku, Tokyo  
146-8501, Japan

### NORTH AMERICA

Canon U.S.A., Inc.  
Canon Customer Care Center  
Phone (US): 1-800-828-4040  
(Available Mon. - Fri., 9 AM to 8 PM Eastern Time)

Canon Canada Inc.  
Phone (Canada): 1-800-OK-CANON (1-800-652-2666)  
(24 hours/day, 7 days/week)

### EUROPE

Europe, Africa & Middle East

Canon Europa N.V.  
PO Box 2262, 1180 EG Amstelveen, The Netherlands

Canon (UK) Ltd.  
Helpdesk  
Tel No.: 08705 143 723 (Calls may be recorded.)  
Fax No.: 08705 143 340

Canon France S.A.  
Hotline : 01.41.99.70.70  
Tél : 01.41.99.77.77 Télécopie : 01.41.99.79.51

Canon Photo Vidéo France S.A.  
Support Client: 01.41.30.15.18  
Fax: 01.41.30.15.98

Canon Euro-Photo GmbH  
Customer-Support: (02154) 495-482 or 483  
Telefax: (02154) 495-489

Canon Italia S.p.A.  
Pronto Canon : 02 8249 2000

Canon Belgium N.V. / S.A.  
Helpdesk: 0900-10627  
Tel.: (02) 722.04.11 Fax: (02) 721.32.74

Canon Luxembourg S.A.  
Tel.: (352) 48 47 961 Fax: (352) 48 47 96232

Canon Nederland N.V.  
Helpdesk: 023 - 5 681 681  
Tel.: 023 - 5 670 123 Fax: 023 - 5 670 124

Canon Danmark A/S  
Phone: +45 44882400  
e-mail: helpdesk@canon.dk

Canon España S.A.  
Help Desk: 906 301 255  
Fax: (91) 411 76 65  
E-mail: helpdesk1@btlink.net

Canon Norge as  
Tlf. 22 62 93 21 Faks: 22 62 06 15  
E-mail: helpdesk@canon.no

Finland

Canon OY  
Puhelin: 010 54420 Fax: 010 544 4571  
Help Desk: 0600 0 22606 (14,80 mk/min+pvm)  
Help Desk: 0600 0 22666 (enint. 40mk/puhelu+pvm)  
Sähköposti: helpdesk@canon.fi

Canon (Schweiz) AG  
Tel. 01-835-6161. Fax 01-835-6526  
Hotline 0900 57 55 20

Canon Svenska AB  
Stensåtravägen 13, S-127 88, Skårholmen, Sweden

Austria

Canon GmbH  
Oberlaaerstraße 233 A-1100 Vienna  
Tel: 01 680 88-0 Fax: 01 680 88-308

### OCEANIA

Canon Australia Pty. Ltd.  
Info-Line: (02) 9805 2864

Canon New Zealand Ltd.  
Info-Line: 0900-522666

### ASIA

Canon Singapore Pte. Ltd.  
79 Anson Road, #09-01 / 06, Singapore 079906  
Phone: (65) 532 4400 Fax: (65) 221 7577

Canon Hongkong Co., Ltd.  
9/F, The Hong Kong Club Building, 3A Chater Road,  
Central, Hong Kong  
Phone: 852-2739-0802 Fax: 852-2369-7701

Canon Marketing Services  
No.1 Jalan Kilang Timor, #09-00, Pacific Tech Centre,  
Singapore 159303  
Phone: (65) 799 8888 Fax: (65) 273 3317

Canon Marketing (Malaysia) Sdn. Bhd.  
Wisma General Lumber, Block D, Peremba Square,  
Saujana Resort, Section U2, 40150,  
Shah Alam, Selangor Darul Ehsan, Malaysia  
Phone: (60) 3 744 6000, (60) 3 745 0055  
Fax: (60) 3 745 0505

Canon Marketing (Thailand) Co., Ltd.  
10th Floor, Bangkok City Tower,  
179/34-45 South Sathorn Road,  
Bangkok 10120, Thailand  
Phone: (662) 344 9999 Fax: (662) 344 9910

Canon Marketing (Hongkong) Co., Ltd.  
10/F, Mirror Tower, 61 Mody Road, Tsimshatsui East  
Kowloon HongKong  
Phone: 852-2170-2828 Fax: 852-2723-9684

# Canon

Canon EOS D30

Camera User's Guide

# EOS D30

## Camera User's Guide



Please read this guide carefully before using the EOS D30.  
This guide should be kept in a safe place so that it can be used for  
future reference.

This Instructions booklet is current as of July 2000. For information on using the camera with system accessories introduced after this date, contact your nearest Canon Service Center.

# Digital Camera Operating Steps and Reference Guides

Your camera includes two manuals: the “EOS D30 Camera User’s Guide” and the “Software Starter Guide.”

## EOS D30 Camera User’s Guide (This Document)

- 1** Prepare your camera for use
- 2** Start taking pictures
- 3** Check your pictures

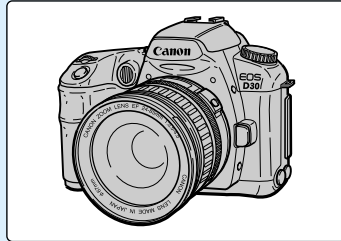

## Software Starter Guide

## Help

- 1** Install the software from the  Canon Digital Camera Solution Disk
- 2** Connect your camera to a computer
- 3** Load your images onto the computer
- 4** Process the images with the software

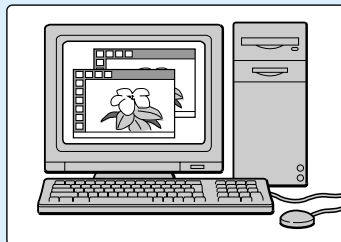
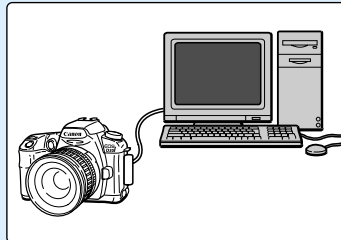

# Thank you for purchasing this Canon product

The Canon EOS D30 is a high-quality, high-precision, digital single-lens reflex camera with a CMOS sensor that has a total pixel count of 3.25 million pixels.

This camera provides a full range of imaging options and functions ideal for every photographic use, from easy, fully automatic shots for first-time users to applications for experienced photographers.

A CompactFlash card\* (CF card Type I , II) is used as the recording media.

Before you use your EOS D30, be sure to read this user's guide with your camera on hand. This will help you become more familiar with your camera, and learn how to operate it properly.

\* We strongly recommend that you use a Canon CF card.

## Test Shots and Warranty of Photographic Images

Before taking important pictures, we would strongly recommend that you first shoot several trial images to make sure you are operating the camera correctly. Please note that the manufacturer is not liable for any consequential damages arising from any malfunction of the EOS D30 camera or recording media (CF card) that results in the failure of an image to be recorded or transferred to a computer.

## Warning Against Copyright Infringement

Please note that your Canon EOS D30 camera is intended for personal use and should never be used in a way that infringes upon or contravenes international or domestic copyright laws and regulations. Please be advised that photographing performances, exhibitions, or commercial properties may contravene copyright or other legal rights, even if the photograph was taken for personal use.

- Canon and EOS are trademarks of Canon, Inc.
- Adobe and Photoshop are trademarks of Adobe Systems Incorporated.
- CompactFlash is a trademark of SanDisk Corporation.
- IBM PC/AT series computers are trademarks or registered trademarks of International Business Machines Corporation (IBM) in the U.S.A.
- Macintosh is a trademark of Apple Computers (U.S.A.), registered in the U.S.A. and other countries.
- Other corporate and product names used in this document are registered trademarks or trademarks of their respective corporations.

# Check Your Accessories

Before using your camera, make sure you have all the accessories shown on this and the following page. If any are missing, contact the store where you purchased your camera.

## ① EOS D30 Camera



## ② Strap (with eyepiece cover)

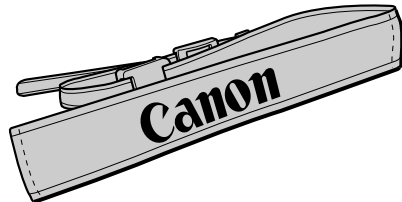

## ③ Battery Pack BP-511

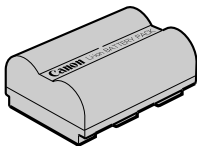

## ④ Compact Power Adapter CA-PS400

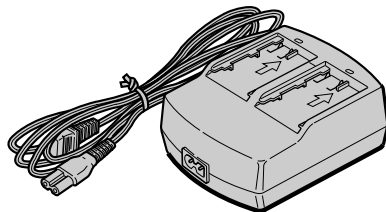

## ⑤ DC Coupler DR-400

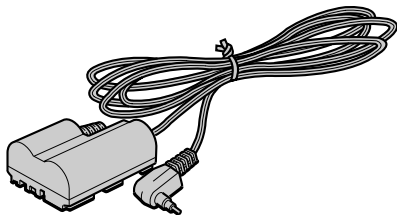

## ⑥ CompactFlash Card FC-16M



**⑦ Interface Cable  
IFC-200 PCU**

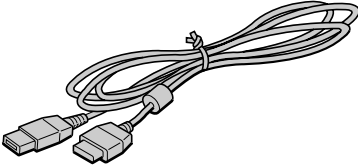

**⑧ Video Cable VC-100**

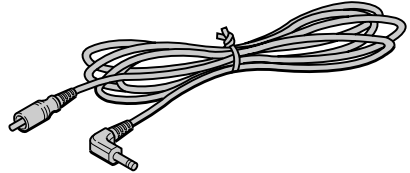

**⑨ Canon Digital Camera  
Solution Disk, Adobe  
Photoshop LE Disk**

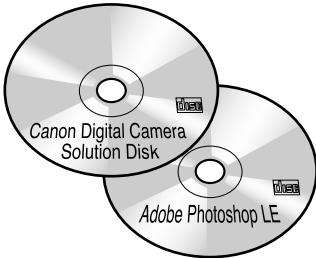

**⑩ EOS D30 Camera User's  
Guide (this document)**

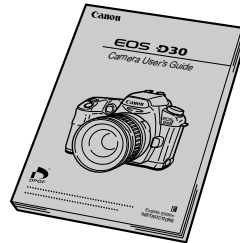

**⑪ Software Starter Guide**

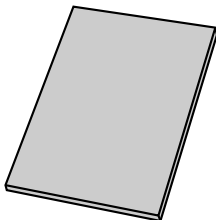

**⑫ Warranty**

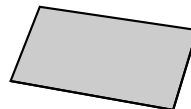

# Contents

## Introduction

Digital Camera Operating Steps and Reference Guides .....	2
Check Your Accessories .....	4
Precautions for Handling .....	12
Quick Guide .....	14
Nomenclature .....	16
Conventions Used in This Manual .....	22

## 1 Before You Begin .....23

Replacing the Backup Battery .....	24
Charging the Battery Pack .....	25
Inserting and Removing the Battery Pack .....	27
Inserting the Battery Pack .....	27
Removing the Battery Pack .....	28
Using a Household Power Supply .....	29
Mounting and Detaching a Lens .....	30
Mounting a Lens .....	30
Detaching a Lens .....	30
Inserting a CF Card .....	31
Removing a CF Card .....	31
<b>MENU</b> File Numbering System .....	32
Basic Operation .....	33
Main Switch .....	33
Shutter Button .....	33
Using the Electronic Dials .....	34
About the LCD Monitor .....	35
Menu Functions and Settings .....	36
<b>MENU</b> Setting the Date and Time .....	38
Dioptric Adjustment in the Viewfinder .....	40
Holding the Camera .....	40

## 2 Simple Picture Taking .....41

<b>□</b> Fully Automatic Picture Taking .....	42
Automatic Built-in Flash .....	43
AF-Assist Light .....	43
Check the Image Immediately .....	44
▶ Check the Image in PLAY Mode .....	44
<b>MENU</b> Checking the Image After it is Taken .....	45
<b>MENU</b> Time Images Are Displayed for Checking .....	46
<b>🗑️</b> Erasing a Recorded Image (Single Image Erase) .....	47
<b>👤</b> Portrait Mode .....	48
<b>🌄</b> Landscape Mode .....	49
<b>📷</b> Close-Up Mode .....	50

<b>🏆</b> Sports Mode .....	51
<b>🌃</b> Night Scene Mode .....	52

## 3 Advanced Operations .....53

<b>MENU</b> Quality Selection .....	54
<b>MENU</b> About ISO Speed .....	55
<b>MENU</b> Selecting Parameters .....	56
Parameters .....	57
<b>AF</b> AF Mode Selection .....	58
One-Shot AF for Still Subjects .....	59
AI Servo AF for Moving Subjects .....	60
AI Focus AF .....	60
<b>📄</b> Focusing Point Selection .....	61
Focusing On an Off-Center Subject .....	62
Problem Subjects for Autofocusing .....	63
<b>MF</b> Manual Focus .....	63
<b>INFO.</b> Checking Camera Settings .....	64
<b>📷</b> Selecting a Metering Mode .....	65
Metering Modes .....	66
Selecting a Drive Mode .....	67
<b>WB</b> Setting the White Balance .....	68
White Balance Settings .....	69
<b>MENU</b> Custom White Balance Setting .....	70
<b>P</b> Program AE .....	72
<b>Tv</b> Shutter Speed-Priority AE .....	74
<b>Av</b> Aperture-Priority AE .....	76
Checking the Depth of Field .....	77
<b>M</b> Manual Exposure .....	78
<b>A-DEP</b> Automatic Depth-of-Field AE .....	80
Setting Exposure Compensation .....	81
<b>MENU</b> Autoexposure Bracketing .....	82
<b>✳️</b> AE Lock .....	84
<b>⌚</b> Self-timer Operation .....	85
Using the Eyepiece Cover .....	86
Bulb Exposures .....	87
Mirror Lockup .....	88

## 4 Flash Photography .....89

Using the Built-in Flash .....	90
Using the Built-in Flash in the Easy Shooting Zone .....	90
Using the Built-in Flash in the Creative Zone .....	90
Built-in Flash Range .....	91
Flash Sync Shutter Speed and Aperture Settings .....	91
<b>MENU</b> Red-eye Reduction .....	93

FE Lock .....94  
 ⓧ Flash Exposure Compensation.....95  
 Flash Photography with the  
 EOS-Dedicated 550EX Speedlite .....96  
 Full Auto Flash .....97  
 Taking Flash Pictures in Each  
 Shooting Mode .....97  
 High-Speed Sync (FP Flash) .....98  
 FEB (Flash Exposure Bracketing).....98  
 FE Lock .....99  
 ⓧ Flash Exposure Compensation.....99  
 Modeling Flash.....99  
 Wireless Multi-Light/E-TTL  
 Autoflash Photography.....99  
 Using Non-Canon Flash Units .....100

AF Modes and Drive Modes .....134  
 Exposure Warnings .....135  
 AE Lock Effects for Combinations of  
 Focusing Point Selection and  
 Metering Method.....135  
 Program Line.....136  
 Shutter Speed and  
 Aperture Value Readouts .....137  
 Troubleshooting.....138  
 Major Accessories (Sold Separately) .....140  
 Major Specifications.....142  
 Message List.....145  
 System Map .....146  
 Index .....147

**5 Playing and Erasing Recorded Images ....101**

Viewing Recorded Images.....102  
 ▶ Viewing a Single Image.....102  
 ⓧ Viewing the Index .....102  
 ⓧ Viewing Enlarged Images.....103  
**JUMP** Jumping to Another Image.....103  
**INFO.** Turning the Information Display  
 On and Off .....104  
**MENU** Automated Playback of  
 Recorded Images (Auto playback) .....105  
**MENU** Rotating an Image.....106  
**MENU** Protecting an Image .....107  
 🗑 Erasing Images (All Image Erase) .....108  
**MENU** Formatting the CF Card.....109  
**MENU** Print Order .....110  
 Selecting Images for Printing.....111  
 Print Type .....113  
 Specifying Date Printing .....114  
 Specifying File Number Printing .....115  
 Connecting to a TV .....116  
**MENU** Cleaning the CMOS Imaging Element ..117

**6 Menu Function Settings .....119**

**MENU** List of Menu Functions .....120  
 Custom Function Settings.....124

**7 Reference .....130**

Basic Terminology for Digital Cameras  
 and Digital Photography .....130  
 Function Availability Table.....134



## EOS D30

This device complies with Part 15 of the FCC Rules. Operation is subject to the following two conditions: (1) This device may not cause harmful interference, and (2) this device must accept any interference received, including interference that may cause undesired operation.

Note: This equipment has been tested and found to comply with the limits for class B digital devices, pursuant to Part 15 of the FCC Rules. These limits are designed to provide reasonable protection against harmful interference in a residential installation. This equipment generates, uses and can radiate radio frequency energy and, if not installed and used in accordance with the instructions, may cause harmful interference to radio communications. However, there is no guarantee that interference will not occur in a particular installation. If this equipment does cause harmful interference to radio or television reception, which can be determined by turning the equipment off and on, the user is encouraged to try to correct the interference by one or more of the following measures:

- Reorient or relocate the receiving antenna.
- Increase the separation between the equipment and receiver.
- Connect the equipment into an outlet on a circuit different from that to which the receiver is connected.
- Consult the dealer or an experienced radio/TV technician for help.

Use of shielded cable is required to comply with class B limits in Subpart B of Part 15 of FCC Rules.

Do not make any changes or modifications to the equipment unless otherwise specified in the manual. If such changes or modifications should be made, you could be required to stop operation of the equipment.

Canon U.S.A. Inc.  
One Canon Plaza, Lake Success, NY 11042, U.S.A.  
Tel No. (516)328-5600

This digital apparatus does not exceed the Class B limits for radio noise emissions from digital apparatus as set out in the interference-causing equipment standard entitled "Digital Apparatus", ICES-003 of the Industry Canada.

Cet appareil numérique respecte les limites de bruits radioélectriques applicables aux appareils numériques de Classe B prescrites dans la norme sur le matériel brouilleur: "Appareils Numériques", NMB-003 édictée par l'Industrie Canada.



The **CE** Mark is a directive conformity mark of the European Community (EC).



This mark indicates that the product complies with Australia's EMC regulations.



**Bij dit produkt zijn batterijen geleverd. Wanneer deze leeg zijn, moet u ze niet weggooien maar inleveren als KCA**



## SAFETY PRECAUTIONS

- Before using the camera, please ensure that you have read and understood the safety precautions described below. Always ensure that the camera is operated correctly.
- The safety precautions noted on the following pages are intended to instruct you in the safe and correct operation of the camera and its accessories to prevent injuries or damage to yourself, other persons and equipment.
- In the next few pages, the term "equipment" refers primarily to the camera and its power supply accessories.

## WARNINGS

- Do not aim the camera directly into the sun or at other intense light sources that could injure your eyesight.
- Do not trigger the flash in close proximity to human or animal eyes. Exposure to the intense light produced by the flash may injure eyesight. In particular, remain at least one meter (39 inches) away from infants when using the flash.
- Store this equipment out of the reach of children and infants. Accidental damage to the camera or batteries by a child could result in serious injury. In addition, placement of the wrist strap around a child's neck could result in asphyxiation.
- Be particularly careful to keep the button batteries (CR2025 lithium) used in the camera out of the reach of children. Seek medical assistance immediately if a child swallows a battery.
- Do not attempt to disassemble or alter any part of the equipment that is not expressly described in this guide. Disassembly or alteration may result in high-voltage electrical shock. Internal inspections, alterations and repairs should be conducted by qualified service personnel authorized by your camera distributor or a Canon Customer Support Help Desk.
- To avoid the risk of high-voltage electrical shock, do not touch the flash portion of the camera if it has been damaged. Similarly, never touch internal portions of the equipment that become exposed as a result of damage. There is a risk of high-voltage electrical shock. Please take the first opportunity to consult your camera distributor or a Canon Customer Support Help Desk.
- Stop operating the equipment immediately if it should emit smoke or noxious fumes. Failure to do so may result in fire or electrical shock. Set the camera's main switch to the Off position and remove the camera battery or unplug the power cord from the electrical outlet immediately. Confirm that smoke or fume emissions cease. Please consult your camera distributor or the closest Canon Customer Support Help Desk.
- Stop operating the equipment if it is dropped or the casing is damaged. Failure to do so may result in fire or electrical shock. Set the camera's main switch to the Off position and remove the camera battery or unplug the power cord from the electrical outlet immediately. Please consult your camera distributor or the closest Canon Customer Support Help Desk.
- Prevent the equipment from contact with, or immersion in, water and other liquids. Do not allow liquids to enter the interior. The camera has not been waterproofed. If the exterior comes into contact with liquids or salt air, wipe it dry with a soft, absorbent cloth. In the event that water or other foreign substances enter the interior, immediately set the camera's main switch to the Off position and remove the camera battery or unplug the power cord from the electrical outlet immediately. Continued use of the equipment may result in fire or electrical shock. Please consult your camera distributor or the closest Canon Customer Support Help Desk.

- 
- Do not use substances containing alcohol, benzene, thinners or other flammable substances to clean or maintain the equipment. The use of these substances may lead to fire.
  - Do not cut, damage, alter or place heavy items on the power adapter cord. Any of these actions may cause an electrical short circuit, which may lead to fire or electrical shock. Replace a broken or damaged power adapter cord.
- 
- Do not handle the power cord if your hands are wet. Handling it with wet hands may lead to electrical shock. When unplugging the cord, ensure that you hold the rigid portion of the plug. Pulling the flexible portion of the cord may damage or expose the wire and insulation, creating the potential for fires or electrical shocks.
  - Use of power sources not expressly recommended for this equipment may lead to overheating, distortion of the equipment, fire, electrical shock or other hazards. Use only the recommended power accessories.
  - Power down the computer and unplug the power cord before attempting to connect the interface cable, to avoid the risk of electrical shock.
- 
- Do not place the batteries near a heat source or expose them to direct flame or heat. Neither should you immerse them in water. Such exposure may damage the batteries and lead to the leakage of corrosive liquids, fire, electrical shock, explosion or serious injury.
  - Do not attempt to disassemble, alter, or apply heat to the batteries. There is serious risk of injury due to an explosion. Immediately flush with water any area of the body, including the eyes and mouth, or clothing, that comes into contact with the inner contents of a battery. If the eyes or mouth contact these substances, immediately flush with water and seek medical assistance.
  - Avoid dropping or subjecting the batteries to severe impacts that could damage the casings. This could lead to leakage and injury.
  - Do not short-circuit the battery terminals with metallic objects, such as key holders. This could lead to overheating, burns and other injuries. Use the supplied battery case to transport or store the battery pack.
  - Before you discard a battery, cover the terminals with tape or other insulators to prevent direct contact with other objects. Contact with the metallic components of other materials in waste containers may lead to fire or explosions. Discard batteries in specialized waste facilities if available in your area.
  - Use of batteries not expressly recommended for this equipment may cause explosions or leaks, resulting in fire, injury and damage to the surroundings. Use only recommended batteries and accessories.
  - Use only the recommended compact power adapter to charge the Battery Pack BP-511 rechargeable batteries. Use of chargers not expressly recommended may result in overheating, distortion, fire or electrical shock.
  - Disconnect the compact power adapter from both the camera and electrical outlet after recharging and when the camera is not in use to avoid fires and other hazards.
  - The camera terminal of the compact power cord is designed for exclusive use with the EOS D30. Do not use it with other products or batteries. There is a risk of fire and other hazards.

## CAUTIONS

- Avoid using, placing or storing the equipment in places subject to strong sunlight or high temperatures, such as the dashboard or trunk (boot) of a car. Exposure to intense sunlight and heat may cause the batteries to leak, overheat or explode, resulting in fire, burns or other injuries. High temperatures may also cause deformation of the casing. Ensure that there is good ventilation when using the compact power adapter to charge the battery pack or power the camera.
- Do not store the equipment in humid or dusty areas. Storage in these areas could lead to fire, electrical shock or other damage.
- Be careful not to bang the camera or subject it to strong impacts or shocks that could lead to injury or damage the equipment when wearing or holding it by the wrist strap.
- Be careful not to cover the flash with your fingers when shooting. In addition, do not touch the surface of the flash after taking several pictures in rapid succession. Either action could result in burns.

## Preventing Malfunctions

### Avoid Strong Magnetic Fields

Never place the camera in close proximity to electric motors or other equipment generating strong electromagnetic fields. Exposure to strong magnetic fields may cause malfunctions or corrupt image data.

### Avoid Condensation Related Problems

Moving the equipment rapidly between hot and cold temperatures may cause condensation (water droplets) to form on its external and internal surfaces. You can avoid this by placing the equipment in an airtight, resealable plastic bag and letting it adjust to temperature changes slowly before removing it from the bag.

### If Condensation Forms Inside the Camera

Stop using the camera immediately if you detect condensation. Continued use may damage the equipment. Remove the CF card and battery or power cord (if connected) from the camera and wait until the moisture evaporates completely before resuming use.

### Extended Storage

When not using the camera for extended periods of time, remove the battery (except the CR2025 lithium button battery) and store the equipment in a safe place. Storing the camera for extended periods with a battery installed will run down the battery and may damage the camera.

## Important Safety Functions and Preventive Measures

- When the CF Card Access Lamp is blinking, do not remove the CF card from the camera. Since the card is reading and writing data when the lamp is blinking, removal of the CF card at this time will damage the card.
- Do not use any cable other than that supplied with the camera. Use the supplied interface cable to connect the camera to a computer. Use of any other cable may lead to a malfunction.

# Precautions for Handling

## The Camera

- (1) This camera is a precision instrument. Do not drop it or expose it to physical shock.
- (2) The camera is not waterproof and should not be used in wet conditions or underwater. If the camera gets wet, take it to your nearest Canon dealer as soon as possible. If small amounts of water splash onto the camera, wipe it with a clean dry cloth. If the camera is exposed to salty air, wipe it thoroughly with a slightly damp cloth.
- (3) Never leave the camera close to devices that generate strong magnetic fields, such as magnets or electric motors. Do not operate or leave the camera in areas where strong electromagnetic signals are generated, such as near electronic transmission towers. Exposing the camera to strong electromagnetic signals can cause it to malfunction and destroy recorded image data.
- (4) Do not leave the camera in hot locations, such as in a car sitting in direct sunlight. High temperatures can damage the camera.
- (5) The camera contains precision circuits. Never attempt to disassemble the camera or service it yourself.
- (6) Use a commercially available blower brush to remove any dust that accumulates on the camera lens, viewfinder, mirror, or focusing screen. Do not use cleaners that contain organic solvents to wipe off the camera body or lens. If the camera is very soiled, consult your nearest Canon dealer.
- (7) Do not touch the camera's electrical contacts with your hands. Doing so could corrode the contacts and interfere with the camera's normal operation.
- (8) If you take the camera quickly from a cold location into a warm one, condensation can form on the outside and inside of the camera. To prevent this, place the camera in an airtight, resealable plastic bag until it warms up to the ambient temperature.
- (9) Do not use the camera if condensation forms on it, or you could damage it. If this occurs, remove the CF card and battery from the camera, and wait until the condensation has evaporated before using the camera.
- (10) If the camera will not be used for an extended period, remove its battery and store the camera in a cool, dry, well-ventilated location. While the camera is in storage, operate its shutter periodically to make sure that it is working.
- (11) Avoid storing the camera in locations where potentially corrosive chemicals are used, such as in a laboratory.
- (12) If the camera has been in storage for an extended period, check its components before using it. If you have not used the camera for some time or are planning to take shots you will not want to lose (overseas vacation, etc.), have the camera checked by your Canon dealer beforehand, or check for yourself that the camera components are working properly.

## LCD Panel and LCD Monitor

- (1) LCD displays are manufactured using high-precision technology. Even so, very small black, red, or green dots can occasionally appear on a display. This is within the normal 99.98% range for valid picture elements (pixels), and does not indicate a fault. Such aberrations on the display also do not affect recorded images.
- (2) Do not press hard on an LCD display or subject it to impacts, as this can cause display flaws and damage.
- (3) If an LCD display becomes soiled, clean it with a commercially available blower brush, or wipe it with a soft cloth, taking care not to scratch the screen. If an LCD display becomes extremely soiled, consult your nearest Canon dealer.

- (4) By their nature, LCD displays react more slowly at low temperatures, and may appear dark at high temperatures. The display will return to normal at room temperature.

## Lithium Backup Battery

- (1) Store lithium batteries out of reach of small children. The chemicals in these batteries are very dangerous if the battery is accidentally swallowed. If this happens, seek medical attention at once.
- (2) Do not use metal instruments such as pliers to hold the battery, or you could cause a short circuit.
- (3) Do not disassemble or heat the battery, or you could rupture it.

## CF Card

- (1) The CF card is a precision device. Do not drop CF cards or expose them to vibrations. Doing so could lose the images recorded on them.
- (2) Do not store or use CF cards near objects that generate magnetic fields, such as TVs, speakers, or magnets, or in locations affected by static electricity. Doing so could lose the images recorded on the CF card.
- (3) Do not place CF cards in direct sunlight or close to heating appliances. Doing so can distort the cards and make them unusable.
- (4) Do not spill liquids onto CF cards.
- (5) Always store your CF cards in a case or cabinet to protect the data stored on them.
- (6) Use only CF cards specified by Canon. Otherwise, you may be unable to record or play back images.
- (7) Do not bend CF cards, or subject them to strong impacts.
- (8) Do not store CF cards in hot, dusty, or humid locations, or in locations exposed to static electricity or magnetic fields.

## Lens Electrical Contacts

After removing a lens from the EOS D30, set the lens with its mounting side facing up, and attach the dust cap to prevent damage to the electrical contacts and lens surface.

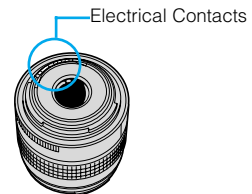

# Quick Guide

See the page indicated (→ ■) for more information.

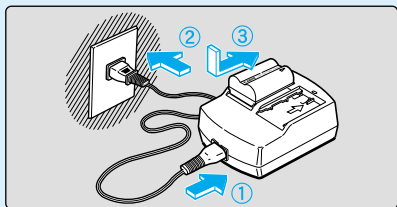

## 1 Charge the battery pack

Connect the power cord to the adapter, then attach the battery. When the charge lamp stops blinking and stays lit, the battery is completely charged. A full battery charge takes approximately 90 minutes. (→25)

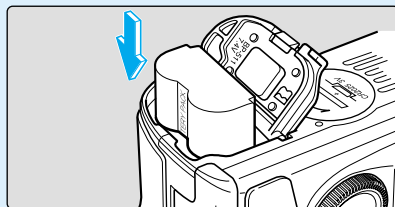

## 2 Insert the battery pack.

Open the battery chamber cover and slide the battery pack into position until it locks into place. Press the cover closed until it clicks shut. (→27)

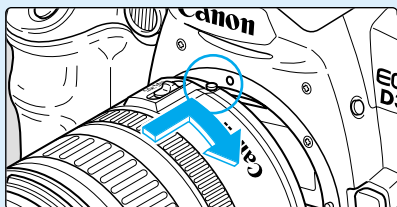

## 5 Mount the lens.

Align the red dots on the lens and camera and turn the lens in the direction shown by the arrow in the diagram until it clicks into place. (→30)

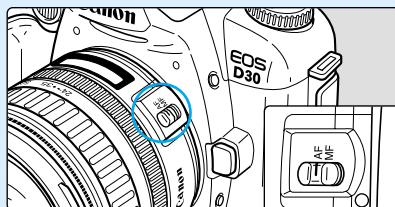

## 6 Set the focus mode switch on the lens to AF.

(→30)

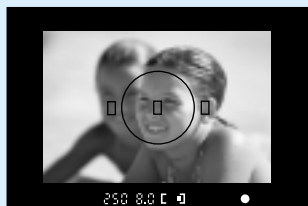

## 9 Focus on the subject.

Look through the viewfinder and place the AF frame over the subject. Then press the shutter button down halfway to focus. (→33)

- In low-light conditions or backlit daylight conditions, the built-in flash fires automatically. (→90)

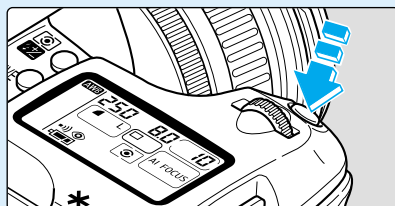

## 10 Take the shot.

Press the shutter button down fully. (→33)

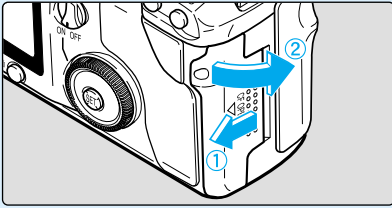

**3** **Open the CF card slot cover.**  
Slide the cover in the direction shown by the arrow, then open it. (→31)

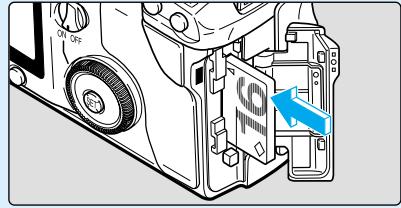

**4** **Insert the CF card.**  
Insert the CF card, then close the cover. (→31)

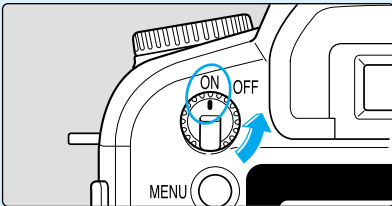

**7** **Set the Main Switch to <ON>.**  
(→33)

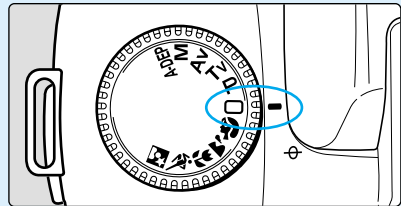

**8** **Set the Mode Dial to <□> (Full Auto).**  
(→42)



**11** **Check the image.**  
The image is displayed for approximately 2 seconds after the shot. (→44)



- To check other images you have taken, see “Check the Image Immediately” (→44) and “Viewing Recorded Images” (→102).
- To erase images you have taken, see “Erasing a Recorded Image (Single Image Erase)” (→47).

# Nomenclature

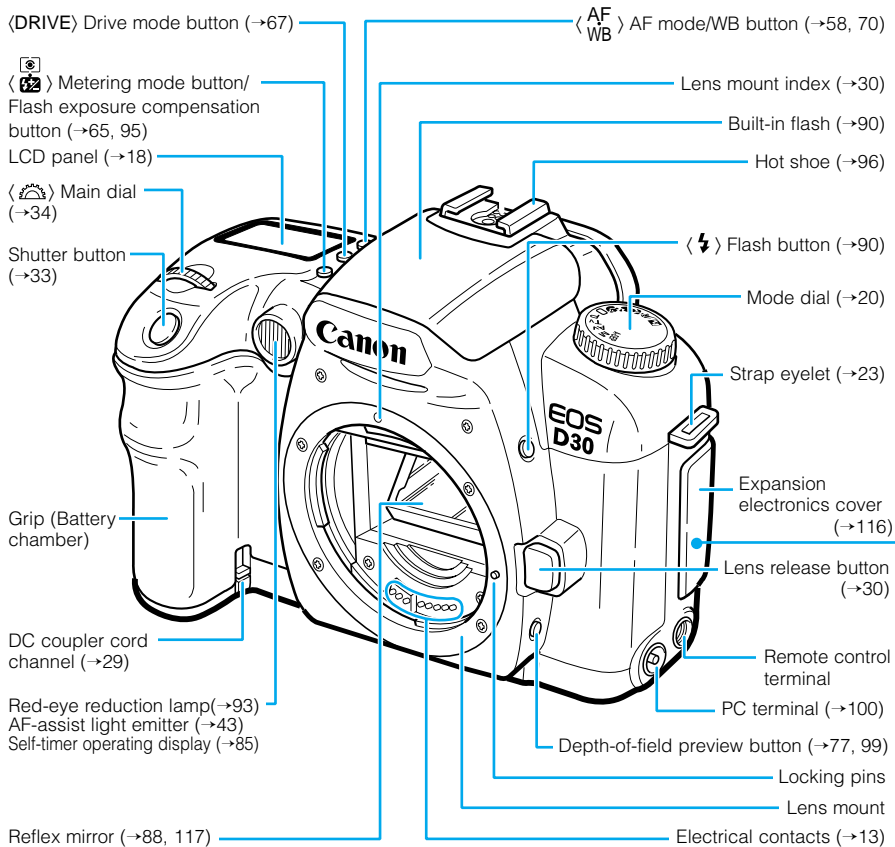

## Inside the expansion electronics cover

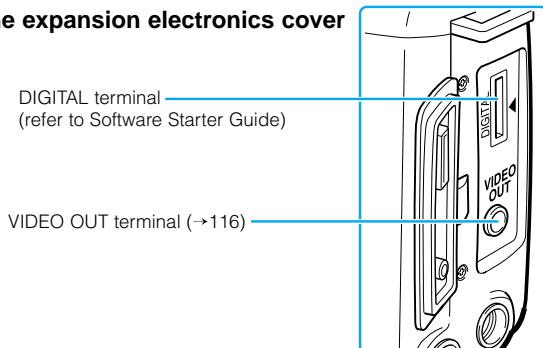

See the page indicated (->■) for more information.



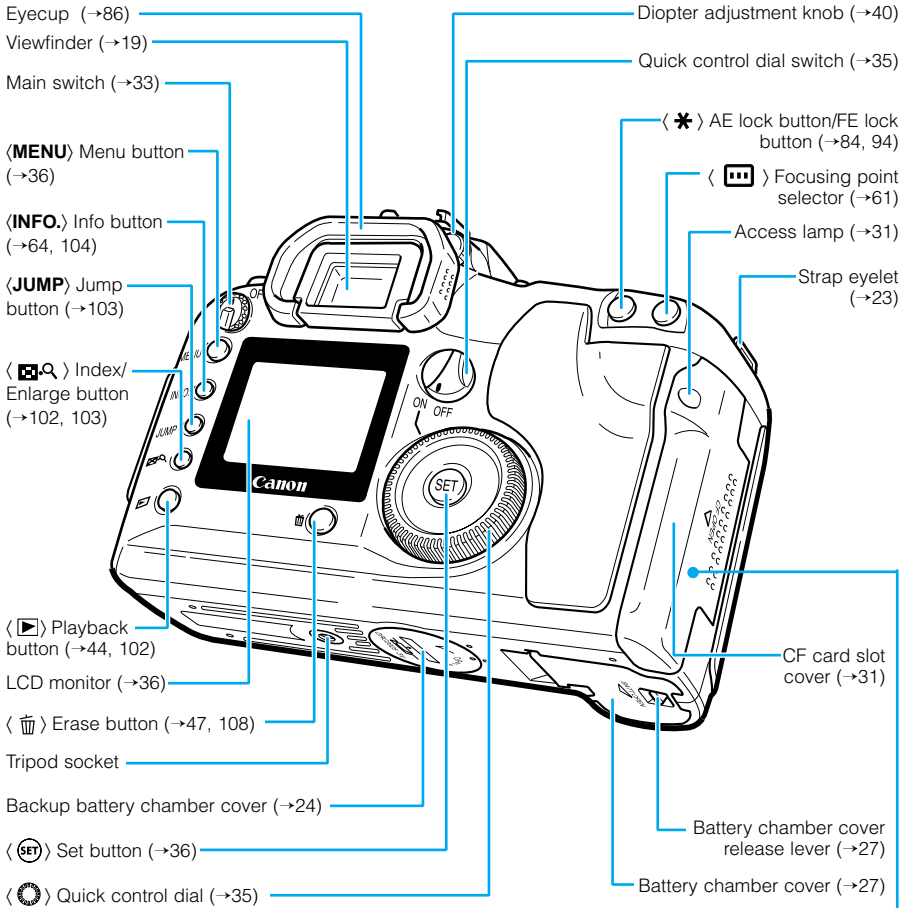

**Inside CF Card Slot Cover**

CF card slot (accepts card type I or II) (->31)

CF card eject button (->31)

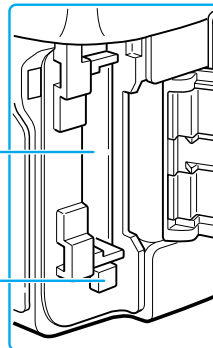

## LCD Panel

- Shutter speed ( 1/3000 - 30" , bulb )
- Data processing ( 6553 )
- Backup battery warning ( C B C )
- Cleaning warning ( R C )
- Parameters ( P R 1 ~ P R - 3 )
- ISO Speed ( 100 ~ 1600 )
- CF full warning ( F U L L C F )
- CF error warning ( E R R C F )
- Focusing point ( 0000 )
- Error code ( E R R 01 - 99 )
- Cleaning ( C L E A N )

- Quality
- L** Large/Fine
  - L** Large/Normal
  - S** Small/Fine
  - S** Small/Normal
  - RAW** RAW

- White balance mode
- AWB** Auto
  - ☀ Daylight
  - ☁ Cloudy
  - ☀ Tungsten
  - ⚡ Fluorescent
  - ⚡ Flash
  - 👤 Custom

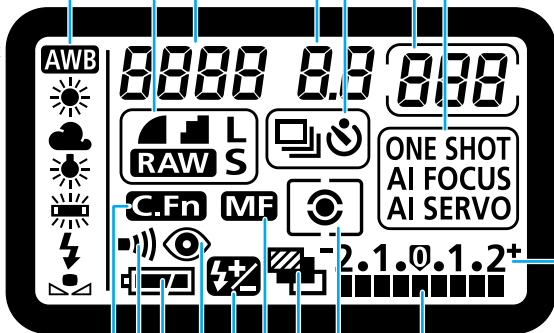

- Aperture value ( 00 - 9.1 )
- Drive mode
- ☐ One-shot
  - 📄 Continuous
  - 🕒 Self-timer

- Possible images that can still be taken ( 999 - 0 )
- Self-timer countdown ( 10 - 1 )
- Bulb exposure time ( 0 - 999 )
- ISO speed ( 100 )

- AF mode
- ONE SHOT AF
  - AI FOCUS AF
  - AI SERVO AF

Exposure step scale

- Exposure level
- Exposure compensation amount
  - AEB level
  - Flash adjustment correction level
  - CF card write access

- C.Fn** Custom function icon
- 🔊 Beep icon
- 🔋 Battery check icon
- 👁 Red-eye reduction icon
- ⚡ Flash exposure compensation icon

- Metering mode
- 👁 Evaluative metering
  - 📄 Partial metering
  - ☐ Center-weighted averaging metering

- AEB**
- MF** Manual focus icon

The above diagram shows the LCD panel with all icons and indicators displayed. In actual use, the items displayed differ according to the camera settings.

# Viewfinder Information

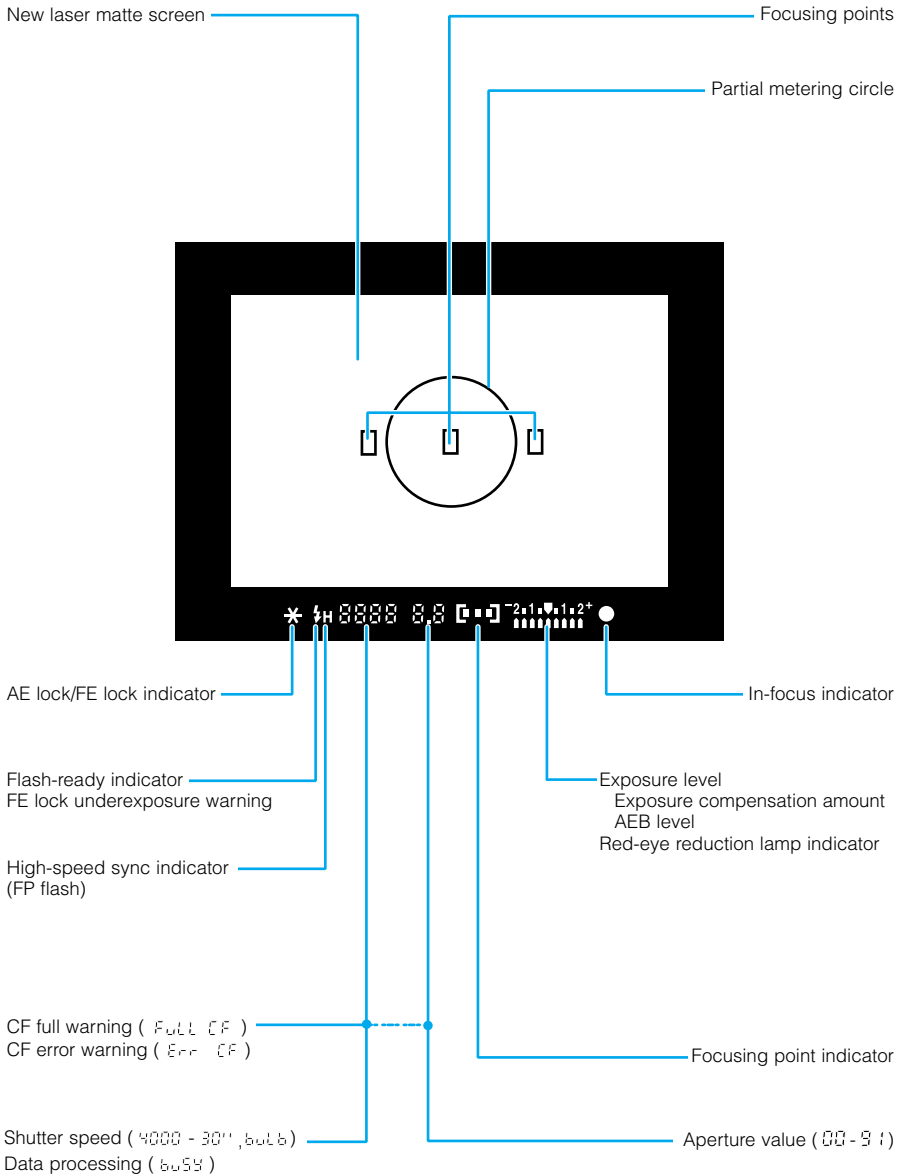

The above diagram shows the LCD panel with all icons and indicators displayed. In actual use, the items displayed differ according to the camera settings.

## Mode Dial

The Mode Dial is divided into two functional zones.

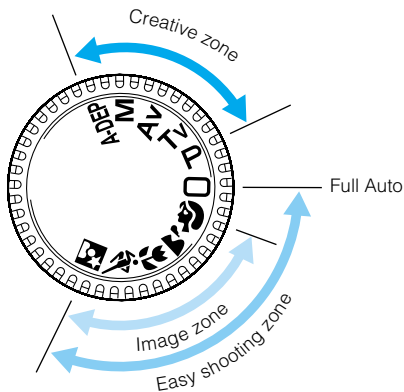

### ① Easy shooting zone

● All you do is press the shutter button.

□ : Full Auto (→42)

Lets you take fully automatic pictures—the camera makes all the settings.

### Image zone

Lets you take fully automatic pictures in specific situations.

-  : Portrait (→48)
-  : Landscape (→49)
-  : Close-up (→50)
-  : Sports (→51)
-  : Night Scene (→52)

### ② Creative zone

Lets you make a variety of settings.

**P** : Program AE (→72)

**Tv** : Shutter speed-priority AE (→74)

**Av** : Aperture-priority AE (→76)

**M** : Manual exposure (→78)

**A-DEP** : Auto depth-of-field priority AE (→80)

See the page indicated (→■) for more information.

# Compact Power Adapter CA-PS400

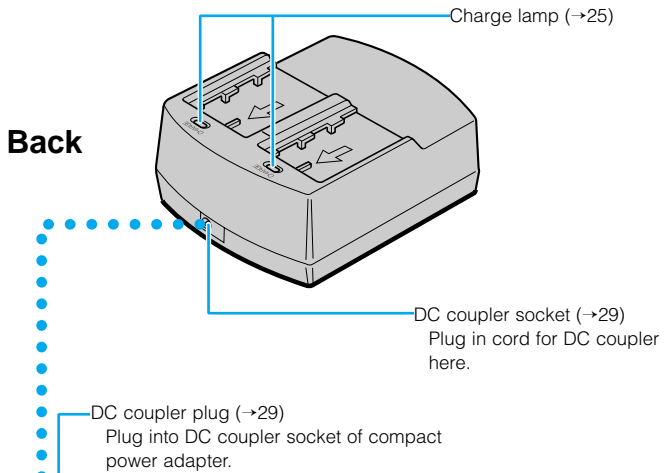
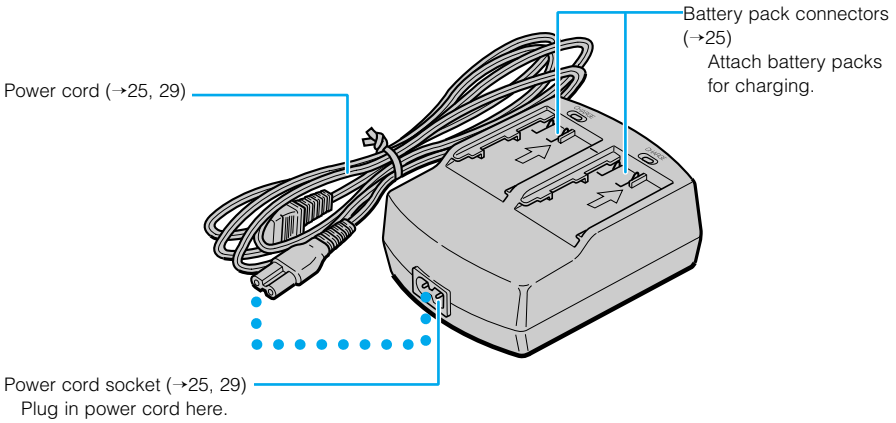

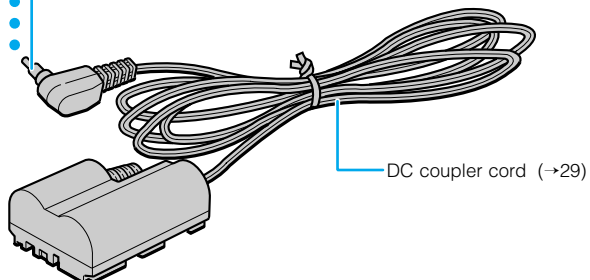

## DC Coupler DR-400

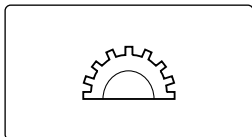

# Conventions Used in This Manual

- All descriptions in this manual assume that the Main Switch is already set to (ON). Set it to (ON) before proceeding with any operation.



- In this manual, the (  ) icon indicates the Main Dial.

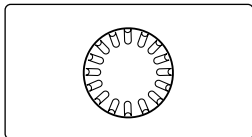



- In this manual the (  ) icon indicates the Quick Control Dial.



- In this manual the (  ) icon indicates the SET button, used to set menu functions and custom functions.



- In this manual, the [C.Fn] symbol indicates a brief explanation of the respective custom function. For details, refer to "Custom Function Settings" (→124).

- The camera control icons and markings in this booklet correspond to the icons and markings on the camera. See "Nomenclature" on page 16.
- Reference page numbers are shown in parentheses (→■).
- The procedures in this user's guide use a Canon EF 24-85mm F3.5-4.5 USM lens for reference.
- The descriptions also assume that the menu functions and custom functions are set to the default settings.
- The icons (  ), (  ), and (  ) indicate that the function operates on a timer, and remains in effect after the button is released. The icons represent 4, 6, or 16 seconds respectively.
- In general, the illustrations used for explaining procedures are taken with a single-lens reflex camera using 35 mm film.

## ■ This user's guide uses the following symbols as described:



: Indicates precautions about potential problems with photographing.



: Indicates additional information you may find helpful.



: Indicates useful pointers for better camera operation or better photographs.

# Before You Begin

# 1

This chapter describes preparations and settings you need to make before you begin shooting, as well as how the shutter button operates.

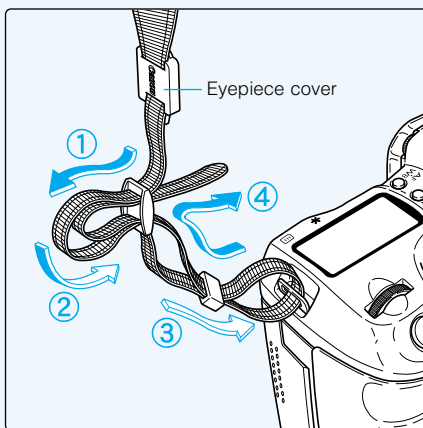

## Attaching the Strap

Pass the end of the strap through the strap eyelet from beneath, then back in and out of the strap clasp as shown. Pull the strap to make sure it does not slip out of the clasp.

- The eyepiece cover is attached to the strap. (→86)

# Replacing the Backup Battery

When the backup battery's power level runs low, the message "⏲ Ⓟ" appears on the camera's LCD panel. If this happens, you will need to purchase a replacement CR2025 battery and replace the backup battery in your camera as follows.

If you replace the backup battery while the camera is connected to a battery pack with power remaining or to a DC coupler, the date, time, and other menu functions will retain their settings.

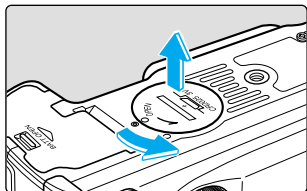

**1** Set the Main Switch to <OFF>.

**2** Open the backup battery chamber cover by turning it 45 degrees counterclockwise, as shown by the arrow in the diagram.

- Be careful not to rotate the cover more than 45 degrees.

**3** Remove the old backup battery.

- Turn the camera so the backup battery chamber faces down, and press the edge of the battery to remove it.

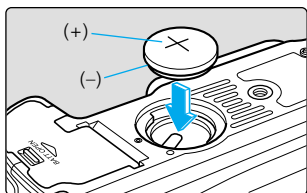

**4** Insert a fresh backup battery.

- Make sure the battery's positive (+) side faces up.

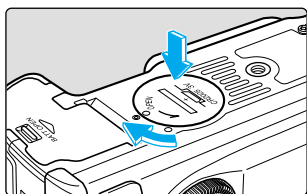

**5** Close the cover by turning it clockwise, as shown by the arrow in the diagram.

- If the date and time now displayed in the LCD panel are incorrect, you will need to set them. (→38)



The backup battery must be a CR2025 button-type lithium battery.



# Charging the Battery Pack

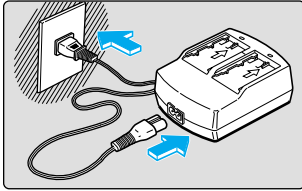

## 1 Connect the power cord.

- Connect the power cord to the compact power adapter.
- Insert the plug into a power outlet.

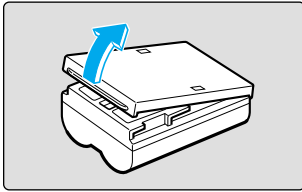

## 2 Remove the cover.

- Store the cover in a place where it will not be lost.
- If you remove the battery from the camera, be sure to reattach the cover to protect against shorting.

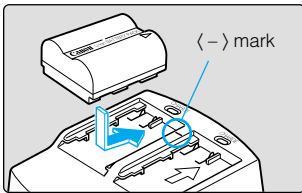

## 3 Place the battery in the adapter.

- Align the end of the battery with the <-> mark on the adapter, press down on the battery, and slide it into place.
- To remove the battery, use the reverse of the above.
- Batteries can be charged in either the left or right side of the adapter.

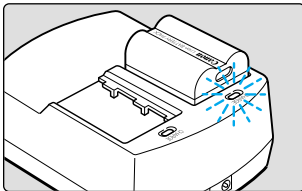

## 4 Charge the battery pack.

- ➔ As soon as you place the battery pack in the compact power adapter, the charge lamp starts blinking and charging begins.
- ➔ When charging is complete, the lamp stops blinking and stays on.
- ➔ **It can take up to 90 minutes to fully charge a battery pack.**
- You can check whether a battery is charged by seeing whether the charge lamp blinks or stays on.
- ➔ When charging is complete, the charge lamp stops blinking and stays on. You can continue charging the battery for approximately an hour to reach full charge capacity.
- When charging is complete, remove the battery and unplug the power cord from the outlet.

Battery charge	Charge lamp
0-50%	Blinks once per second
50-75%	Blinks twice per second
Over 75%	Blinks three times per second
100%	Stays on



- When the DC coupler is connected to the compact power adapter, the adapter cannot be used to charge battery packs.
- Do not charge any battery packs other than model BP-511.
- When the battery pack is in the camera, it discharges slightly over time even when the camera is not used. This reduces the battery pack's operating time. When not using the camera, remove the battery pack and store it with its protective cover attached. Always be sure to charge the battery pack before using it again.
- To protect battery packs and prevent loss of capacity, do not charge them continuously for more than 24 hours.
- If operating time is sharply reduced even after charging normally, the battery pack may have exceeded its useful life. Replace it with a new battery pack.



- The adapter can hold and charge two battery packs. Charging starts with the first battery pack attached. After that battery pack is charged, the charge lamp goes on and the adapter starts charging the second battery pack. After charging of both battery packs is completed (both charge lamps are on), leave both battery packs in the charger for two more hours (one hour per battery pack) to reach a full charge.
- Charging time depends on the ambient temperature, and the level to which the battery pack is already charged.
- When battery power is low, the  icon on the LCD panel blinks. Remove the battery pack from the camera and charge it.
- The battery pack can operate in temperatures from 0°C to 40°C (32°F to 104°F), however for full operating performance, use between 10°C (50°F) and 30°C (86°F) is recommended. In cold locations such as ski areas, battery performance is temporarily decreased and operating time may be reduced.

# Inserting and Removing the Battery Pack

## Inserting the Battery Pack

Load a fully charged BP-511 battery pack into the camera.

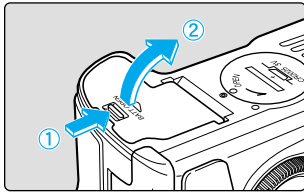

### 1 Open the battery chamber cover.

- Slide the lever in the direction shown by the arrow in the diagram, and open the cover as shown.

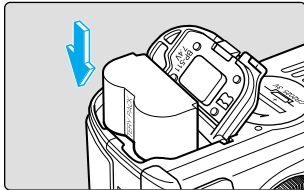

### 2 Load the battery into the camera.

- Make sure the battery pack is facing the right way, and insert it into the battery chamber.
- Insert the battery pack until it locks into place.

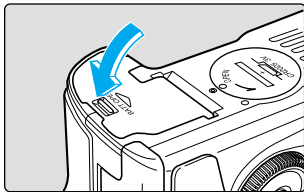





### 3 Close the cover.

- Press the cover closed until it clicks shut.

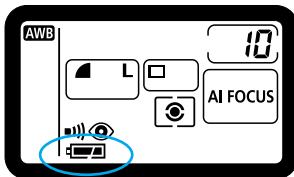
## Battery Charge Remaining Icons

The level of charge remaining is shown in three stages when the Main Switch is set to **( ON )**.  
(→33)



-  : Charge is sufficient.
-  : Charge is low.
-  : Battery pack must be charged.



If the level of charge remaining runs out when you are using the menu screen or playing back an image, a no battery warning appears on the LCD monitor. When this occurs, remove the battery and charge it.

## Number of Available Shots

Temperature	Shooting conditions	
	No flash use	50% flash use
Normal (20°C/68°F)	Approx. 680	Approx. 540
Low (0°C/32°F)	Approx. 480	Approx. 400

- The above figures were obtained under Canon test conditions (fully charged battery, EF 50mm F1.4 USM lens, Review function [On], Review Time [2 sec.], Quality [Large ■]).
- Playback on the LCD monitor is available for approximately 140 minutes at normal temperature (continuous auto playback).



- The number of available shots may be less than indicated in some cases, due to differences in operating conditions.
- The number of available shots is reduced by frequent use of the LCD monitor.
- Holding the shutter button halfway down for long periods to use the AF function without taking a shot can reduce the number of available shots.
- In low temperature conditions (0°C/32°F), the number of available shots may be less than indicated.
- For the number of available shots when using the Battery Grip BG-ED3, see the BG-ED3 User's Manual.

## Removing the Battery Pack

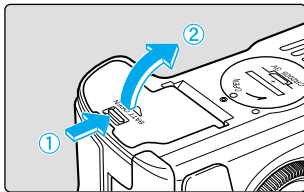

### 1 Open the battery cover.

- Slide the lever in the direction shown by the arrow in the diagram, and open the cover as shown.

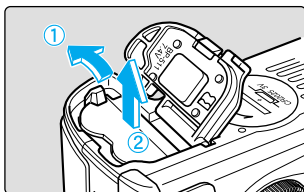

### 2 Remove the battery pack.

- Slide the battery lock lever in the direction shown by the arrow, and remove the battery.

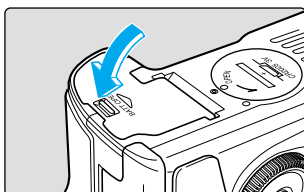

### 3 Close the battery cover.

- Press the cover closed until it clicks shut.

## Using a Household Power Supply

You can operate the EOS D30 from a household power outlet by using the DC coupler. This enables you to use the camera as long as you like without a battery.

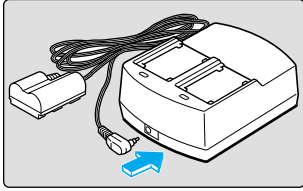

### 1 Connect the DC coupler.

- Plug the DC coupler into the compact power adapter.

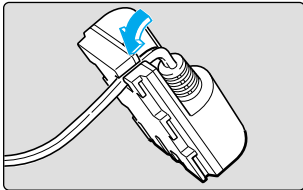

### 2 Place the cord in the groove.

- Carefully insert the cord into the groove.

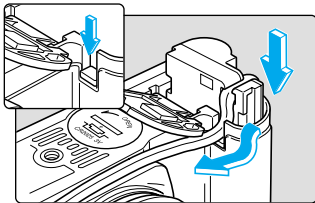

### 3 Insert the DC coupler into the camera.

- Open the cover (→27) and lower the covering on the cord channel.
- Insert the DC coupler and fit the cord into the cord channel.
- Check that the cord is placed tightly in the cord channel, and slide the DC coupler into the chamber until it locks into place.
- Close the cover so that it clicks into place.

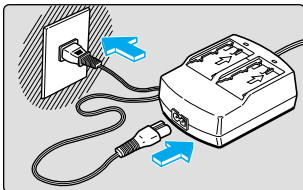

### 4 Connect the power cord.

- Connect the power cord to the compact power adapter.
- Plug the cord into a power outlet.
- When you are finished, remove the plug from the power outlet.



- Do not use any DC coupler other than the one provided with your EOS D30 camera.
- Do not use the DC coupler provided with your EOS D30 with any other camera.

# Mounting and Detaching a Lens

## Mounting a Lens

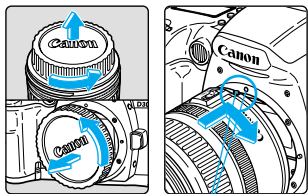

Lens mount index

### 1 Remove the caps.

- Remove the rear lens cap and the body cap by turning them as shown by the arrows in the diagram.

### 2 Attach the lens.

- Align the red dots on the lens and camera and turn the lens as shown by the arrow in the diagram until it clicks in place.

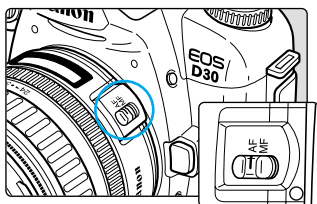

### 3 Set the focus mode switch on the lens to <AF>.

- If the focus mode switch is set to <MF> (or <M> on older lenses), the autofocus will not operate and <MF> will be displayed on the LCD panel.

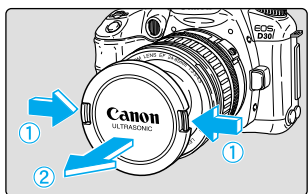

### 4 Remove the front lens cap.

## Detaching a Lens

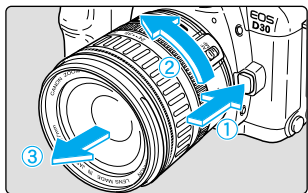

### Press and hold the lens release button, and turn the lens as shown by the arrow in the diagram.

- Turn the lens until the index mark is at the top, then remove it.



- Because the EOS D30 has a smaller sensor area than that of a 35mm-format camera, the angle of view of all EF lenses is changed. The effective focal length of all lenses is increased by a factor of 1.6, eg a 50mm lens has approximately the same angle of view as an 80mm lens.

- **AF** stands for autofocus.
- **MF** or **M** stands for manual focus.
- Be careful not to lose the lens caps or body cap.

EOS D30 image field  
(22.7 × 15.1 mm /  
0.89 × 0.59 in)

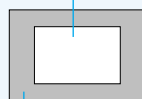

35 mm image field  
(36 × 24 mm / 1.42 × 0.94 in)

# Inserting a CF Card

The EOS D30 stores pictures on a CompactFlash (CF) card. The camera can use either Type I or Type II CF cards.

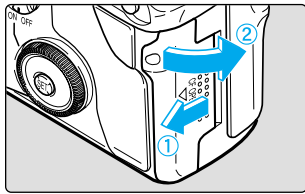

## 1 Open the cover.

- Slide the cover in the direction shown by the arrow, and open it as shown in the diagram.

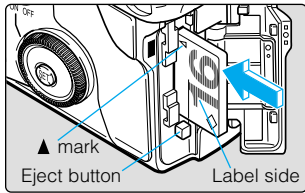

## 2 Insert the CF card.

- With the CF card label side (the side with the printed ▲ mark) facing toward the rear of the camera, slide the card in the direction of the ▲ mark, into the slot.
- ➔ The Eject button pops out.

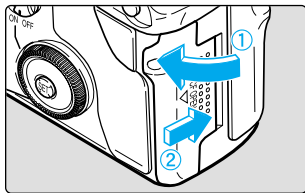

## 3 Close the cover.

- Close the cover and slide it in the direction shown by the arrow until it clicks shut.

## Removing a CF Card

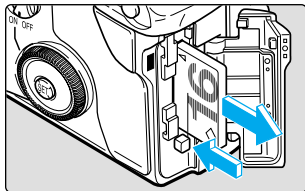

## 1 Open the cover.

- Set the Main Switch to (OFF).
- Check that the "busy" message is not shown on the LCD panel.
- Make sure the access lamp is off (→17), and open the cover.

## 2 Remove the CF card.

- Press the Eject button.
- ➔ The CF card is ejected.
- Close the cover.



- Never do any of the following while the access lamp is blinking (the "busy" and "Full CF" messages are shown on the LCD panel and in the viewfinder), or you risk destroying image data or even damaging the camera itself.
  - Never shake the camera or subject it to impact.
  - Never open the CF card slot cover.
  - Never remove the CF card.
  - Never open the battery cover.
  - Never remove the battery.
- You cannot use the menu function or playback images while image data is being written onto the CF card (the access lamp is blinking (→17)). If you press (MENU) or the (▶) button, the warning message of "Busy." (→137) will appear on the LCD panel.
- If you insert a CF card that is unformatted or contains corrupt data, the LCD panel will display the message "Err CF". If this happens, refer to "Formatting a CF Card" (→109) for instructions.

# MENU File Numbering System

The pictures you take are automatically assigned file numbers from 0001 to 9900 and stored in folders of 100 images each. Each folder on the CF card is numbered from 100 to 998. Automatic file numbering can be either by continuous numbering or auto reset numbering (the default setting is continuous numbering):

**(1) Continuous:** Numbering is continuous between cards, so that the first file number assigned on a new CF card is one more than the last file number assigned on the previous CF card.

**(2) Auto reset:** Each time you insert a new CF card, the file number resets to its default value (100-0001). If the card already contains files, the next available number is assigned.

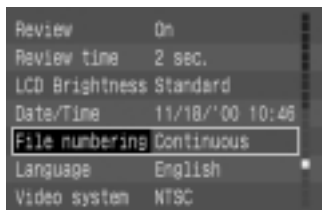
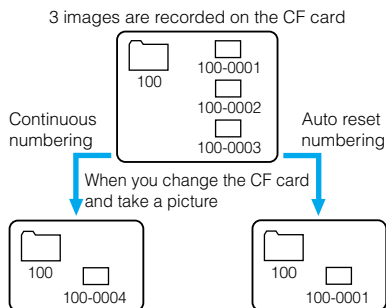

## 1 From the menu, select [File numbering].

- Press the **[MENU]** button.
- Turn the **[DIAL]** to select [File Numbering], then press the **[SET]** button.

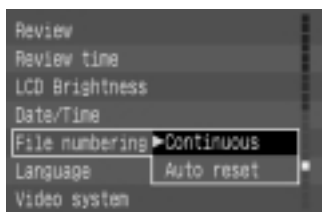

## 2 Select the setting you want.

- Turn the **[DIAL]** to select [Continuous] or [Auto reset], then press the **[SET]** button.
- ➔ The selection is entered, and the display returns to the menu.
- Press the **[MENU]** button to clear the screen and exit the menu.



- File numbers are used the same way as frame numbers in a film camera.
- For details about file numbers, see "Basic Terminology for Digital Cameras and Digital Photography" (→131).
- Because pictures taken using continuous shooting must be stored in the same folder, there may in some cases be more than 101 images in a folder.



Because continuous numbering avoids duplication of image file numbers, this setting is convenient for processing images on computers.



# Basic Operation

## Main Switch

The camera operates only after the Main Switch is set to **(ON)**.

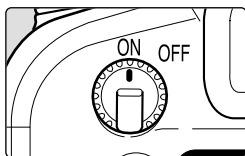

- (ON)**: Set to this position when the camera is in use.  
**(OFF)**: The camera does not operate.  
 Set to this position when not using the camera.



- To save battery power, the camera automatically turns off if you do not operate it for approximately one minute (Auto power off function). To use the camera again, press the shutter button down halfway, or set the Main Switch to **(OFF)** and then set it to **(ON)** again. You can use the Menu functions to set the Auto power off function to 1, 2, 4, 8, 15, or 30 minutes, or Off. (→121)
- If you set the Main Switch to **(OFF)** immediately you take a picture, the access lamp may blink for a few seconds so that the image is recorded onto the CF card. The access lamp will go off when the image has been recorded onto the CF card and the camera will turn off automatically.

## Shutter Button

The shutter button has two stages. You can press it down halfway or fully. The two levels of shutter button operation are as follows:

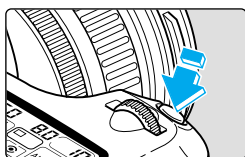

### (1) Half press (◉4)

Pressing the shutter button down halfway activates autofocus (AF) and focuses the camera, and also activates the automatic exposure mechanism and sets the shutter speed and aperture value.

The exposure (the combination of shutter speed and aperture value) appears on the LCD panel and in the viewfinder.

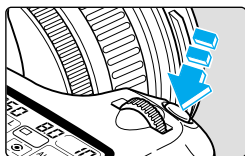

### (2) Full press

This releases the shutter and takes the picture.



- This camera has been designed so that taking pictures is given priority over other operations. Unless the internal memory is full, you will always be able to take pictures immediately by pressing the shutter button down.
- Regardless of the camera status (playback in progress, menu selection in progress, image recording in progress, etc.), you can return to shooting mode immediately by pressing the shutter button down halfway.

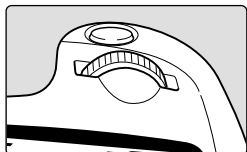

## Using the Electronic Dials



### Basic Operations with the Dial

The  dial is used to make settings only when taking pictures. It can be used in two ways.

#### (1) Press a button and turn the dial.

When you press a button, its function remains active while a timer () runs. During this time you can turn the  dial and view the settings on the LCD panel. When the timer runs out or you press the shutter button down halfway, the camera is ready to take a picture.

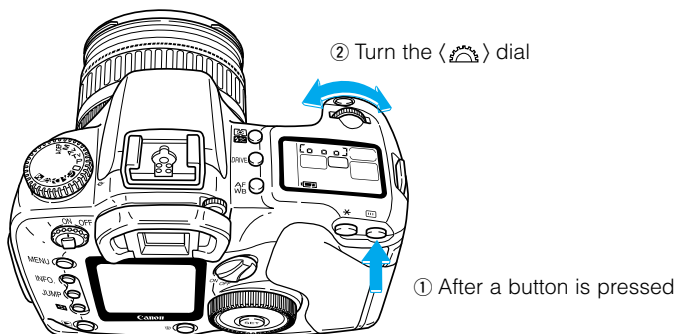

Use the dial this way to set the AF mode, focusing point, metering mode or drive mode.

#### (2) Just turn the dial.

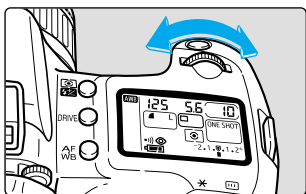

Turn the  dial while watching the LCD panel.



Use the dial this way to set the shutter speed and aperture value.

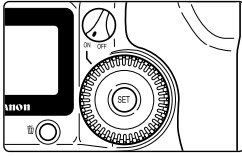



## Basic Operations with the dial.

You can only use the  dial when the Quick Control Dial switch is set to **(ON)**. Use the dial to select and set shooting mode operations and menu functions from the LCD monitor.

When using the  dial to carry out basic operations, you can use it in two ways.

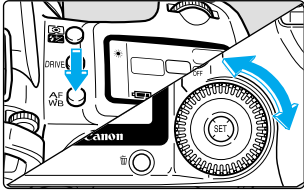
### (1) Press a button and turn the dial.



When you press a button, its function remains active while a timer () runs. During this time you can turn the  dial and view settings on the LCD panel.

The timer function and return to shooting mode are the same as for the  dial.



Use the dial this way to select and set the white balance, drive mode and flash exposure compensation.

### (2) Just turn the dial.

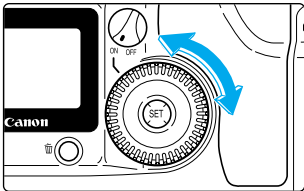

When you are taking pictures, turn the  dial while watching the viewfinder display or LCD panel. When you are making selections and settings from the LCD monitor, turn the dial while watching the LCD monitor.



- When you are taking pictures, use the dial to set the exposure compensation and manual aperture value.
- When using the LCD monitor, use the dial to review and select the recorded image and select menu functions.

## About the LCD Monitor

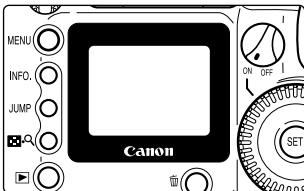

You can use the LCD monitor on the back of the camera to review and select images, as well as select and set menu functions.



You cannot use the LCD monitor as a viewfinder while taking pictures.



You can use the  dial when you are using the LCD monitor, regardless of whether the Quick Control Dial Switch is set to **(OFF)**.

# Menu Functions and Settings

The Canon EOS D30 uses menu functions to set functions such as the quality, the date and time, and Custom Function settings. To use the menu functions, look at the LCD monitor and use the **(MENU)** button, **(Q)** dial and **(SET)** button as shown below.

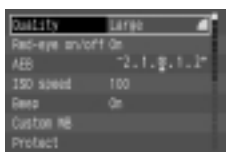
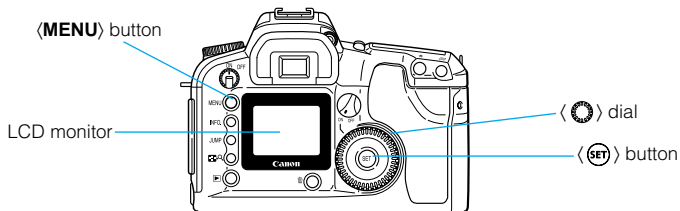

## 1. Display the menu.

Press the **(MENU)** button to display the menu. Press the button again to clear the screen.

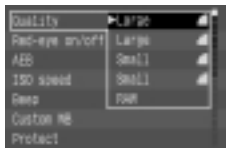

## 2. Select the menu item.

Turn the **(Q)** dial to select the desired item.

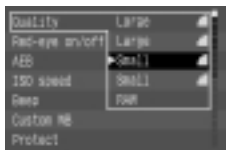
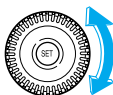

## 3. Display the options for the item and make your selection.

Press the **(SET)** button to display the options list, then turn the **(Q)** dial to select the desired option.

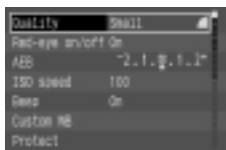

## 4. Make the setting.

Press the **(SET)** button.



## 5. Exit the menu.

Press the **(MENU)** button to exit the menu.



- When the menu is displayed, you can take pictures immediately by pressing the shutter button down.
- You can finish making a setting by pressing the shutter button down halfway.
- You can cycle through menu items and options lists.
- You can select the display language from three other languages besides English. (→122)
- If you press the **(JUMP)** button while the menu screen is displayed, you can move to the top item in the recording, playback and setup sub-menus in that order, each time you press this button.

## Menu Selections and Default Settings

On the Menu screen, items and settings are shown in different colors according to the functions they control. Selected items are enclosed in a frame.



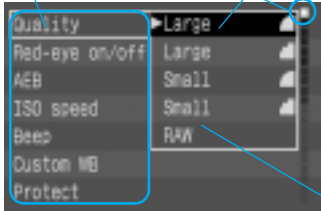



Menu item      Setting indicated by color



Color	Setting type	Description
Red	Recording	Menu items related to taking pictures.
Blue	Playback	Menu items related to playing back recorded images.
Yellow	Setup	Menu items related to basic camera functions.



Options list

 : Default setting

	Menu item	Available settings			Ref. page
Recording (Red)	Quality * <sup>2</sup>	Large 	Large 	Small 	54
		Small 	RAW		
	Red-eye on/off * <sup>3</sup>	On	Off		93
	AEB * <sup>2</sup>				82
	ISO speed	100	200	400	55
		800	1600		
Beep	On	Off		120	
Custom WB * <sup>2</sup>	Set custom white balance			70	
Playback (Blue)	Parameters * <sup>1</sup> * <sup>2</sup>	Standard	Set 1		56
		Set 2	Set 3		
	Protect	Protect recorded image			
	Rotate	Rotate recorded image			106
	Print order	Order print of recorded image			110
Auto playback	Automatic playback of recorded image			105	
Setup (Yellow)	Auto power off	1 min.	2 min.	4 min.	121
		8 min.	15 min.	30 min.	
		Off			
	Review	Off	On	On (Info)	45
	Review time	2 sec.	4 sec.		
		8 sec.	Hold		46
	LCD Brightness	Normal	Bright		122
	Date/Time	mm/dd/yy	dd/mm/yy	yy/mm/dd	38
	File numbering	Continuous	Auto reset		32
	Language	English	Deutsch		122
	Français	Japanese			
Video system	NTSC	PAL		123	
Format	Format CF card			109	
C.Fn * <sup>2</sup>	Custom Function settings			124	

\*1: Does not appear in the menu if it is not set or registered.

\*2: Does not appear in the menu when the Easy Shooting zone (→20) is selected.

\*3: Does not appear in the menu in (  ) and (  ) modes.

# MENU Setting the Date and Time

Set the date and time as shown. The date and time are recorded with the image data for each photographed image.

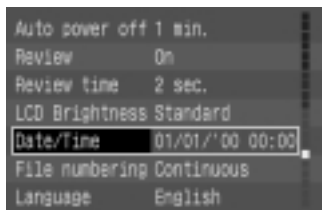

## 1 From the Menu, select [Date/Time].

- Press the **(MENU)** button.
- Turn the **(◂)** dial to select [Date/Time].



## 2 Press the **(SET)** button.

- ➔ The Date/Time setting screen appears.

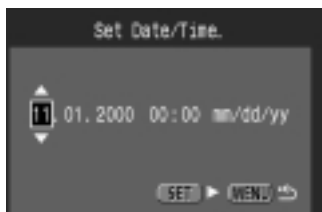

## 3 Set the date and time.

- Turn the **(◂)** dial to adjust the date and time values, then press the **(SET)** button.
- After entering the setting, go to the next item.



## 4 Select the order for the display.

- Use the **(◂)** dial to select the order, then press the **(SET)** button.
- Turn the **(◂)** dial to cycle through the selections in the order shown.

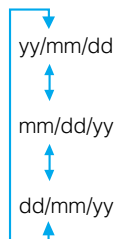

## 5 Press the button.

- ➔ The date and time are set, and the display returns to the menu.
- Press the **⟨MENU⟩** button to clear the screen and exit the menu.



- Each photographed image is recorded with the date and time it was taken. If the date and time are not set, they cannot be recorded correctly. Make sure you set the date and time correctly.
- The date and time are stored using the backup battery.

# Dioptric Adjustment in the Viewfinder

Use the dioptric adjustment in the viewfinder to best suit your vision. This adjustment can enable eyeglass wearers to see through the viewfinder clearly, even without their eyeglasses. The camera's adjustable dioptric range is  $-3$  to  $+1$  dpt.

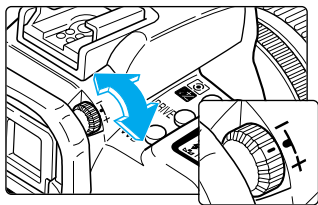

## Turn the Dioptric Adjustment Knob

- Turn the knob right or left until the focusing point or the center spot metering circle appears sharply defined in the viewfinder.
- The diagram shows the knob set at the standard diopter ( $-1$  dpt).



If the viewfinder image still does not look sharp after adjusting the diopter adjustment knob, try one of the E-series dioptric adjustment lenses (sold separately). (→140)

# Holding the Camera

To get sharp pictures, hold the camera as still as possible.

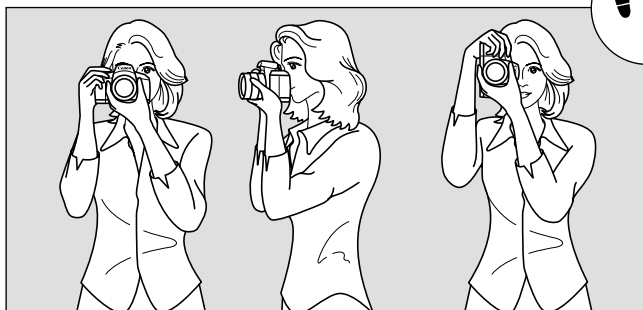

Landscape position

Portrait position

- Grasp the camera grip firmly with your right hand, and hold your right elbow lightly against your body.
- Hold the lens at the bottom with your left hand.
- Hold the camera to your face and look through the viewfinder.
- To maintain a stable stance, place one foot slightly in front of the other.



# Simple Picture Taking

# 2

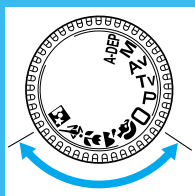

Easy Shooting zone

This chapter describes how to use the Mode Dial's Easy Shooting zone (□), (人), (山), (花), (人+相机), (相机+闪光灯) for simple picture taking. In this zone, anyone can take pictures easily by simply pressing the shutter button.

In addition, to help prevent mistakes caused by operating the camera improperly, the (⚙️) dial, and the (📷), (AF/WB), (📱), and (✖️) buttons do not operate so there is no need to worry about accidental errors.

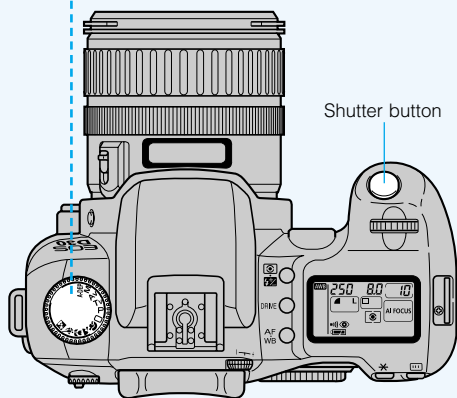

Shutter button

# □ Fully Automatic Picture Taking

You can easily and confidently take pictures of any subject, with no need to do anything but press the shutter button. The Canon EOS D30 can capture subjects at any of three focusing points, so that anybody can take great pictures easily.

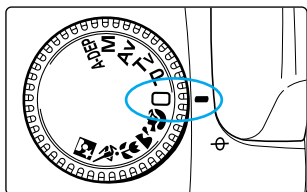

## 1 Set the Mode Dial to □.

- The AF mode is automatically set to (AI Focus) (→60), the metering mode is set to (☉) and the drive mode to (□) (Single shot).
- The Quality setting is automatically set to Large/Fine (2160 × 1440).

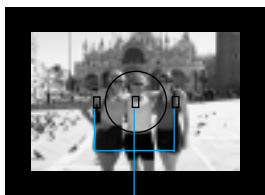

Focusing point

## 2 Place one of the focusing points on the subject.

- The camera determines the subject position and uses the most appropriate focusing point.
- To focus on a subject that is not at any of the three focusing points, see "Focusing On an Off-Center Subject" (→62).

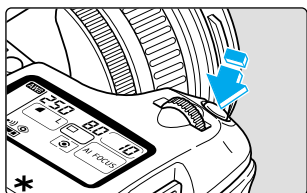

## 3 Set the focus.

- Press the shutter button down halfway to set the focus.
- The camera beeps when the shot is in focus, and the in-focus indicator (●) lights in the viewfinder at the focusing point the camera is using.



## 4 Check the display.

- The camera determines the shutter speed and aperture value automatically, and displays them in the viewfinder and on the LCD panel.

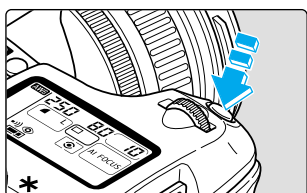

## 5 Take the picture.

- Compose the shot and press the shutter button down fully.
- The image is shown for approximately 2 seconds on the LCD monitor.





- If the CF card becomes full, the CF Full message “FULL CF” appears on the LCD panel and in the viewfinder, and the camera will not take any more pictures. Replace the CF card with another CF card that has capacity available.
- When the in-focus indicator (●) is blinking, the camera will not take pictures. (→63, 139)



- The focus and exposure are locked when AF focusing is complete.
- The camera automatically focuses on the focusing point that is on the subject closest to the camera.
- You can set the beep that indicates the subject is in focus or the beep that indicates the self-timer is operating to On or Off. (→37, 120)

## Automatic Built-in Flash

In the Easy Shooting zone (other than <img alt="Shooting mode icon: a camera with a lightning bolt." data-bbox="425 363 445 383"/> and <img alt="Shooting mode icon: a camera with a lightning bolt and a sun." data-bbox="425 363 445 383"/>)), the flash pops up automatically and fires in low-light conditions or backlit daylight conditions. Press the flash back down when you are finished using it.



- If anything blocks the flash so that it cannot pop up automatically, the error code “Err B3” (→137) appears on the LCD panel. When this occurs, set the Main Switch to <strong>OFF</strong> and then set it to <strong>ON</strong> again.
- For precautions and information about using the built-in flash, see “Flash Photography” (→90).



- To take pictures in an area where flash photography is prohibited or using indoor lighting, the <strong>P</strong> (Program) (→72) mode setting is recommended.
- When taking flash pictures of people at night or in dark interiors, we recommend using “Red-eye reduction” (→93).

## AF-Assist Light

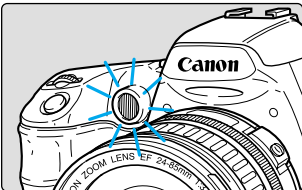

- In dark locations, pressing the shutter button down halfway causes the AF-assist light emitter to light. The AF-assist light helps the AF function focus the shot.



- The effective range of the AF-assist light in focusing is approximately 3.8 m/12.5 ft.
- When using an EX-series Speedlite for the EOS camera (sold separately), the AF-assist light built into the camera or the flash operates, depending on shooting conditions.

# Check the Image Immediately

You can view the images you take immediately, on the LCD monitor on the back of the camera.



## 1 Take the picture.

- ➔ After the picture is taken, the image as it was shot appears on the LCD monitor.
- The image is shown for approximately 2 seconds.



- You can turn the Review function on or off, as well as display the image information display. (→45)
- You can change the length of time the image is displayed. (→46)
- You can change the brightness of the LCD monitor. (→122)
- While a picture is being displayed, you can press the  $\langle \text{trash} \rangle$  button to delete that image. (→47)  
This will erase the image shown on the LCD monitor before it is written to the CF card.

## ▶ Check the Image in PLAY Mode

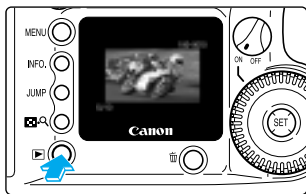

## 1 View the image.

- Press the  $\langle \text{play} \rangle$  button.
- ➔ The most recently recorded image appears.
- Press the  $\langle \text{play} \rangle$  button again to remove the image from the LCD monitor and exit PLAY mode.

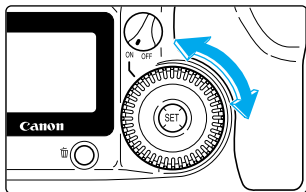

## 2 Change the displayed image.

- Turn the  $\langle \text{dial} \rangle$  dial counterclockwise to move back through the images you have taken, from newest to oldest.
- Turn the  $\langle \text{dial} \rangle$  dial clockwise to move through the images from oldest to newest.



You cannot use the menu function or playback images while image data is being written onto the CF card (the access lamp is blinking (→17)). If you press **⟨MENU⟩** or the  $\langle \text{play} \rangle$  button, the warning message of “Busy.” (→137) will appear on the LCD panel.



You can also view the images you have taken in index form (→102) or enlarged form (→103).

## MENU Checking the Image After it is Taken

You can set the camera to display each image on the LCD monitor as soon as it is taken. You can do this two ways: Select [On] to display the image by itself, or select [On (Info)](→104) to display the image with its recording information. Select [Off] if you do not want to display the image. The default setting is [On].

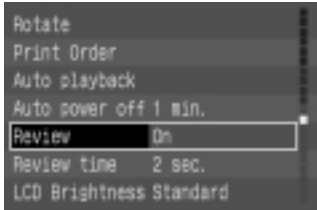

### 1 From the Menu, select [Review].

- Press the **<MENU>** button.
- Turn the **<DIAL>** to select [Review], then press the **<SET>** button.

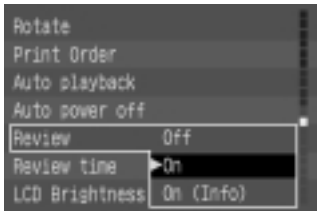

### 2 Select the Review setting.

- Turn the **<DIAL>** to select the desired option, then press the **<SET>** button.
- The setting is entered, and the display returns to the menu.
- Press the **<MENU>** button to clear the screen and exit the menu.

### 3 Take the picture.

- After the picture is taken, the image as it was shot appears on the LCD monitor.
- The time that image is displayed depends on the review time setting. (→46)
- The display differs depending on whether you selected [On] or [On (Info)].

[On] selected



[On (Info)] selected (→104)



You can change the review time setting. (→46)

## **MENU** Time Images Are Displayed for Checking

You can control how long images are displayed by setting the review time to [2 sec.], [4 sec.], [8 sec.], or [Hold] which keeps the image on the monitor screen. The default setting is [2 sec.].

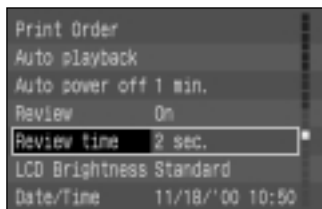

### 1 From the Menu, select [Review time].

- Press the **<MENU>** button.
- Turn the **<DIAL>** dial to select [Review time], then press the **<SET>** button.

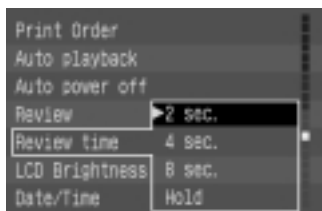

### 2 Set the review time.

- Turn the **<DIAL>** dial to select the review time you want, then press the **<SET>** button.
- ➔ The setting is entered, and the display returns to the menu.
- Press the **<MENU>** button to clear the screen and exit the menu.



- When this function is set to [Hold], the image is displayed until you press the shutter button down halfway. Note however that the camera power will turn off automatically when the Auto power off time setting is reached (→33, 121).
- The [Review time] setting is valid when the [Review] feature is set to [On] or [On (Info)].

# Erasing a Recorded Image (Single Image Erase)

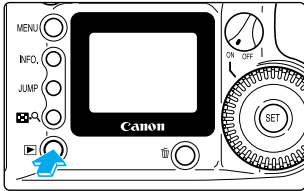

## 1 Set the camera to Play mode.

- Press the  $\langle \blacktriangle \rangle$  button to enter Play mode.
- The most recent image appears.

## 2 Select the image you want to erase.

- Turn the  $\langle \odot \rangle$  dial to select the image you want to erase.



## 3 Open the Erase menu.

- Press the  $\langle \text{trash} \rangle$  button.
- The Erase menu appears at the bottom of the LCD monitor.

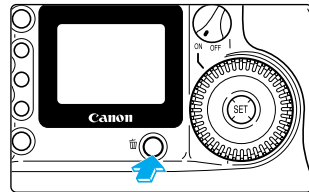

## 4 Erase the image.

- Turn the  $\langle \odot \rangle$  dial to select [Erase], then press the  $\langle \text{SET} \rangle$  button.
- The access lamp blinks and the image is erased.



You cannot recover an image once you have erased it. Make sure you no longer want an image before erasing it.



- You can protect images (→107) to prevent them from being erased accidentally.
- To erase all images recorded on the CF card, see “Erasing Images (All Image Erase)” (→108).





# Portrait Mode

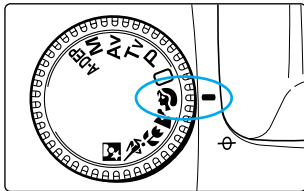

This mode blurs the background to make the subject stand out.



## Set the Mode Dial to .

- The way you take pictures is the same as in  (Full Auto) mode. (→42)
- The AF mode is automatically set to , the drive mode to , and the metering mode to .
- The Quality setting is automatically set to Large/Fine (2160 × 1440).



- Head-and-shoulder shots give the best background blur effect. Also, the farther the subject is from the background, the more blurred the background will appear.
- Use a telephoto lens to blur the background even more. If you use a zoom lens, its longest focal length is the most effective (for example, a 24-85mm lens set to 85 mm).







# Landscape Mode

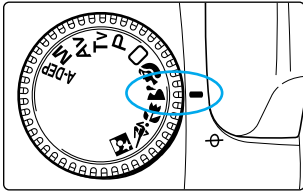

This mode is for sweeping scenery, sunsets, etc.



## Set the Mode Dial to .

- The way you take pictures is the same as in  (Full Auto) mode. (→42)
- ➔ The AF mode is automatically set to  (Single shot), the drive mode to  (Single shot), and the metering mode to .
- ➔ The Quality setting is automatically set to Large/Fine (2160 × 1440).



If the shutter speed indicator blinks, the shutter speed may be too slow to keep the picture from being blurred by camera shake. We recommend you use a tripod when taking landscape pictures. (The shutter speed indicator still blinks if you use a tripod, but camera shake will not be a problem.)



The built-in flash does not fire in Landscape mode, even if it is raised.



A wide-angle lens provides the greatest depth from foreground to background, as well as a wider image. If you use a zoom lens, its shortest focal length is the most effective (for example, a 24-85mm lens set to 24 mm).



# Close-Up Mode

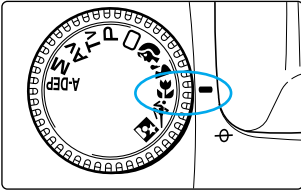

This mode is for taking close-up shots of flowers, insects, or other small subjects.



## Set the Mode Dial to .

- The way you take pictures is the same as in  (Full Auto) mode. (→42)
- The AF mode is automatically set to (ONE SHOT), the drive mode to  (Single shot), and the metering mode to .
- The Quality setting is automatically set to Large/Fine (2160 × 1440).



- Close-up mode is most effective when the subject is at the minimum focusing distance of the lens.
- If you use a zoom lens, use its longest focal length to get a higher magnification.
- For better close-ups, we recommend using an EOS-dedicated macro lens and the Macro Ring Lite MR-14EX.





# Sports Mode

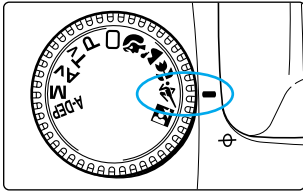

This mode is used for sports photography and capturing fast-moving subjects.



## Set the Mode Dial to .

- The way you take pictures is the same as in  (Full Auto) mode. (→42)
- ➔ The AF mode is automatically set to (AI Servo), the drive mode to , and the metering mode to .
- ➔ The Quality setting is automatically set to Large/Fine (2160 × 1440).



If the shutter speed indicator blinks, the shutter speed may be too slow to keep the picture from being blurred by camera shake. Be careful to hold the camera steady and press the shutter button smoothly, or use a tripod. (The shutter speed indicator still blinks if you use a tripod, but camera shake will not be a problem.)



The built-in flash does not fire in Sports mode, even if it is raised.





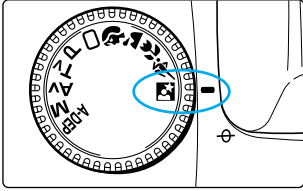

- For best results in Sports mode, use a film speed setting of ISO 400 or faster. (→55, 120)
- For sports photography we recommend using a telephoto lens of 200-300 mm.

# Night Scene Mode

This mode is for taking pictures of people at sunset or at night. It uses flash to illuminate the subject and a slow shutter speed to expose the background, resulting in a natural-looking exposure.







## Set the Mode Dial to .

- The way you take pictures is the same as in  (Full Auto) mode. (→42)
- The AF mode is automatically set to , the drive mode to , and the metering mode to .
- The Quality setting is automatically set to Large/Fine (2160 × 1440).



- To prevent camera shake, always use a tripod.
- When the shutter speed has been automatically set to 1-2 seconds, it will take one second from when the shutter button is pressed down fully until the picture is taken. Continue pressing the shutter button until the picture is taken.



- If you are taking images of scenery only (and not people), use Landscape  mode.
- Tell your subjects not to move for a few seconds after the flash fires.
- You can also use Night Scene  mode with an EX-series Speedlite.
- In daylight, Night Scene  mode operates the same as  (Full Auto) mode.



For best results in Night Scene mode, use a film speed setting of ISO 400 or faster. (→55, 120)



# Advanced Operations

# 3

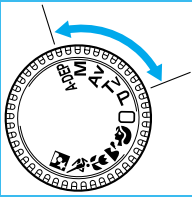
Creative zone



The Creative zone features shooting modes that let you select the shutter speed or aperture value and change the exposure yourself, providing you with more flexibility to set up the camera for a variety of shooting styles. This chapter describes how to make effective use of each of these functions.

- The  icon represents the Main Dial, and the  icon represents the Quick Control Dial.
- Press the shutter button down halfway and release, and a timer will show the exposure setting for approximately 4 seconds on the LCD panel and viewfinder.
- The AE lock, exposure compensation, AEB, bulb, and depth-of-field check functions operate only in Creative zone modes.
- The Menu function Quality, AEB, Custom WB, Parameters, and C.Fn settings are used only in the Creative zone.

# MENU Quality Selection

Use the Menu function to choose from five Quality settings:

Quality	Icon	Recording size	Recording method	Compression ratio	Size of one image	Recording capacity
Large/Fine		2160 × 1440	JPEG	Low	1.3 Mbyte	Approx. 10 shots
Large/Normal				High	0.7 Mbyte	Approx. 21 shots
Small/Fine		1440 × 960		Low	0.7 Mbyte	Approx. 22 shots
Small/Normal				High	0.4 Mbyte	Approx. 40 shots
RAW		2160 × 1440	RAW	–	3.4 Mbyte	Approx. 3 shots

- Based on Canon testing standards (ISO 100 setting).
- Recording capacity is the number of shots that can be stored on the CF card/FC-16M provided with the EOS D30 camera.
- The number of images that can be recorded depends on the subject and modes used.

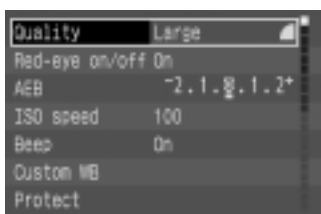

## 1 From the menu, select [Quality].

- Press the **[MENU]** button.
- Turn the **[Q]** dial to select [Quality], then press the **[SET]** button.

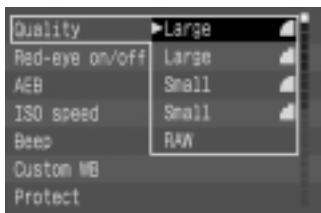

## 2 Set the quality.

- Turn the **[Q]** dial to select the Quality you want, then press the **[SET]** button.
- ➔ The selected Quality setting is entered, and the screen returns to the menu.
- Press the **[MENU]** button to clear the screen and exit the menu.



- You cannot adjust the Quality setting while in the Easy Shooting zone (→20).
- Opening images on a computer that have been recorded in RAW format require the dedicated computer driver provided with the camera. For details, refer to the Software Starter Guide.

### C.Fn

You can set the Quality by pressing the **[SET]** button and turning the **[Q]** or **[Q]** dial as you look at the LCD panel. (C.Fn-12-1 →128)

# MENU About ISO Speed

ISO speed is an index number representing the photosensitivity of silver-halide film. Digital cameras do not use film, but their photosensitivity is commonly described in terms of "ISO equivalent" speed settings. (→132)

The higher the number, the greater the sensitivity. Higher speeds are better for taking pictures of moving subjects or in dim light, but the pictures will also contain more noise and so will be less sharp. Conversely, lower speeds are less suited to moving subjects or dim conditions, but produce sharper, more detailed images.

The Canon EOS D30 provides ISO-equivalent speed settings from ISO 100 to ISO 1600, in one-step increments.

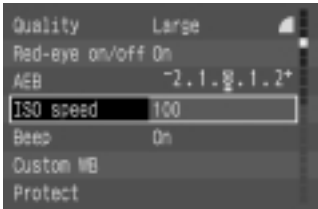

## 1 Select [ISO Speed].

- Press the **(MENU)** button.
- Turn the **(Q)** dial to select [ISO Speed], then press the **(SET)** button.

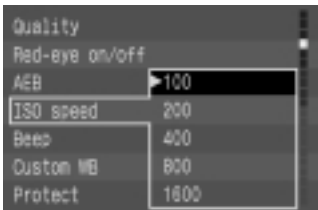

## 2 Set the ISO speed.

- Turn the **(Q)** dial to select the desired ISO speed, then press the **(SET)** button.
  - ➔ The selected ISO speed is entered, and the screen returns to the Menu.
- Press the **(MENU)** button to clear the screen and exit the Menu.

**C.Fn** You can set the ISO speed by pressing the **(SET)** button and turning the **(Q)** or **(Q)** dial as you look at the LCD panel. (C.Fn-12-2 →128)

# MENU Selecting Parameters

In addition to the standard parameters automatically applied by the camera for processing images recorded, you can register up to three sets of your own parameters. Parameter settings are made using a computer and the software supplied with your EOS D30 camera, and stored in the camera by connecting the computer and camera with the proper interface cable provided with the camera.

For instructions on setting parameters with the software supplied with the EOS D30, as well as registering parameters in the camera and on connecting your camera to a computer, see the Software Starter Guide.

**Note that if no custom parameters are set or stored using this function, this item will not appear on the menu.**

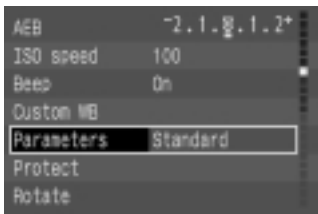

## 1 From the menu, select [Parameters].

- Press the **<MENU>** button.
  - Turn the **<Q>** dial to select [Parameters], then press the **<SET>** button.
- ➔ The LCD monitor displays the available parameters.

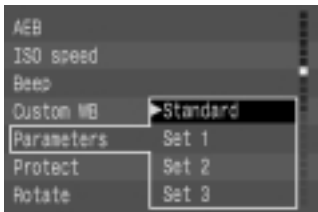

## 2 Set the parameters you want.

- Turn the **<Q>** dial to select the parameters, then press the **<SET>** button.
- ➔ The selected parameters are entered, and the screen returns to the menu.
- Press the **<MENU>** button to clear the screen and exit the menu.

**C.Fn** You can set the parameters by pressing the **<SET>** button and turning the **<W>** or **<Q>** dial as you look at the LCD panel. However if no parameters have been registered, the message “**PA-1**” is displayed on the LCD panel and you cannot set the parameters. (C.Fn-12-3 →128)



# Parameters

The camera can store up to three sets of parameters, each a combination of settings for Contrast, Sharpness, and Color Saturation. For details, see the Software Starter Guide.

Up to 3 sets of parameters can be stored.

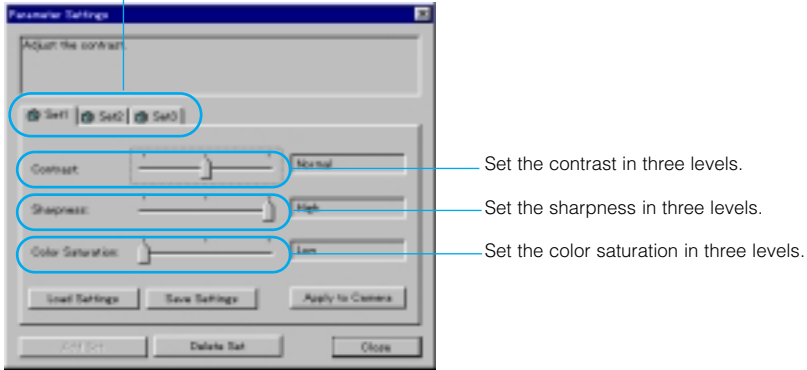

- Set the contrast in three levels.
- Set the sharpness in three levels.
- Set the color saturation in three levels.

Parameter	Setting	Level	Effect
Contrast	Adjusts the contrast	Low	Takes pictures with lower contrast.
		Normal	Takes pictures with normal contrast.
		High	Takes pictures with higher contrast.
Sharpness	Adjusts the sharpness	Low	Takes pictures with lower sharpness.
		Normal	Takes pictures with normal sharpness.
		High	Takes pictures with higher sharpness.
Color Saturation	Adjusts the color saturation	Low	Takes pictures with muted colors.
		Normal	Takes pictures with normal color saturation.
		High	Takes pictures with intense colors.

# AF AF Mode Selection

The AF mode setting controls how the autofocus functions operate. The camera has two AF modes: One-shot AF for still subjects, and AI Servo AF for moving subjects. AF mode selection is available in all Creative zone settings except for  $\langle A-DEP \rangle$ .

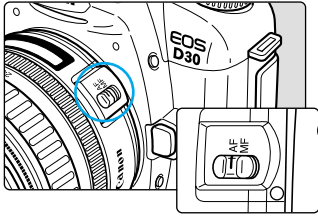

**1** Set the lens focus mode switch to  $\langle AF \rangle$ .

**2** Set the Mode Dial to a Creative zone setting other than  $\langle A-DEP \rangle$ .

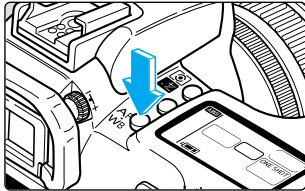

**3** Press the  $\langle AF/WB \rangle$  button. (06)

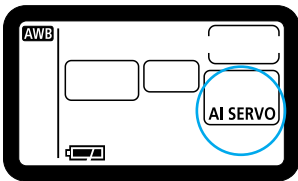

**4** Select the AF mode.

- Turn the  $\langle \text{Mode Dial} \rangle$  to make the selection.

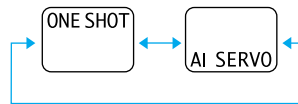

- Press the shutter button down halfway to return to ready-to-shoot status.



- In addition to the above two AF modes, the EOS D30 provides AI Focus AF, which automatically switches between One-shot and AI Servo AF modes according to the state of the subject. AI Focus AF is automatically selected when operating in  $\langle \square \rangle$  (Full Auto) mode.
- Turn the  $\langle \text{WB Dial} \rangle$  to select the white balance ( $\rightarrow$ 68).

## One-Shot AF for Still Subjects

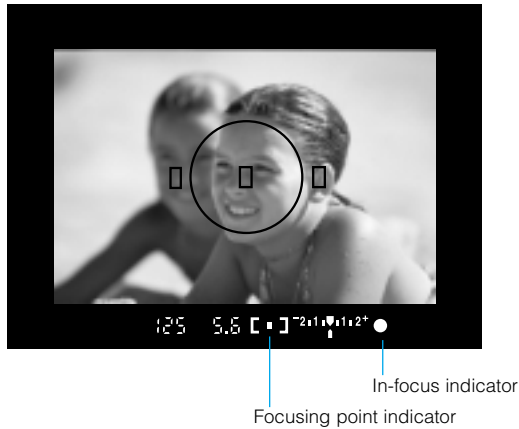

**ONE SHOT**

**Press the shutter button down halfway to activate AF operation and focus once.**

- ➔ When the camera has focused, the focusing point indicator and the in-focus indicator (●) in the viewfinder light at the same time.
- When using evaluative metering, the exposure setting is determined when focus is achieved. The exposure setting and focus remain locked as long as the shutter button is pressed down halfway. You can then recompose the shot while retaining the exposure setting and focus (→62).



If the camera cannot focus, the in-focus indicator (●) in the viewfinder blinks. If this happens, you will not be able to take a picture even if you press the shutter button down fully. Instead, reframe the shot and focus again. See also, "Manual Focus" (→63).

## AI Servo AF for Moving Subjects



**Press and hold the shutter button down halfway, and the camera focuses continuously.**

- This mode is suited for moving subjects when the focusing distance keeps changing.
- With its predictive AF function, the camera can also track a subject that is steadily approaching or retreating from the camera.
- The exposure settings are determined immediately before the picture is taken.



If the in-focus indicator (●) in the viewfinder blinks, the camera has not focused.



You can set the camera so that during AI Servo AF operation, you can press the **< \* >** button and the focus will momentarily lock as long as the button is held down. (C. Fn-2-2→124)

### About Predictive AF

When a subject is approaching or retreating from the camera at a constant rate, the focusing function can track the subject and predict the focusing distance immediately before the picture is taken so that the shot will be in focus at the moment of exposure.

- When the focusing point is selected automatically, the camera uses one of three focusing points to focus on the subject. Tracking and predictive focusing is carried out using the selected focusing point.
- When the focusing point is selected manually (→61), the selected focusing point tracks the subject.

### AI Focus AF

AI Focus AF is set automatically in **< □ >** (Full Auto) mode. At the time of the shot, the camera automatically selects One-shot AF and AI Servo AF according to the state of the subject.

If the subject is focused in One-shot AF and the subject then begins to move continuously, the camera detects the movement, automatically switches to AI Servo AF, and focuses continuously as it tracks the subject.



# Focusing Point Selection

The focusing point is the frame in which the subject is focused. The focusing point can be selected automatically or manually. In the Easy Shooting zone and in **<A-DEP>** mode, the selection is automatic, but in **<P>**, **<Tv>**, **<Av>**, and **<M>** modes you can switch between automatic and manual focusing point selection.

- Automatic selection AF: The camera selects the focusing point automatically according to conditions.
- Manual selection AF: You can select any of the three focusing points manually. This is best when you want to be sure to focus on a particular subject, or to use the speed of the AF focusing function to help you compose a particular shot quickly.

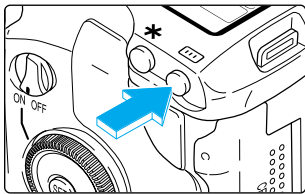

**1** Press the **< [ ] >** button. (06)

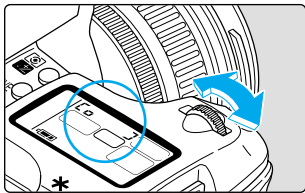

**2** Select the focusing point. → Look at the LCD panel or the viewfinder display as you turn the **< [ ] >** or **< [ ] >** dial.

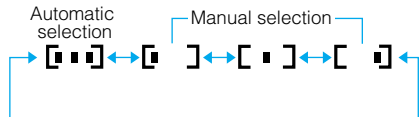

- Press the shutter button down halfway to return to ready-to-shoot mode.



# Focusing On an Off-Center Subject

To focus on a subject not covered by one of the three focusing points, follow the procedure below. This technique is called Focus Lock.

Focus lock is valid when the AF mode is set to One-shot AF.

## 1 Select a focusing point.

(→61)



## 2 Focus on the subject.

- Place the focusing point over the subject and press the shutter button down halfway.



## 3 Hold the shutter button down halfway and recompose the picture.

## 4 Take the picture.



You can also use the Focus lock function in the Easy Shooting zone (except for  mode), starting from step 2.



For best results, use the combination of One-shot AF with AE lock applied on the focusing point where focus is achieved, and evaluative metering.

# Problem Subjects for Autofocusing

The EOS D30 has a precision AF system that can focus on most subjects. However, it may not be able to focus on subjects (in-focus indicator (●) blinks) in particular conditions such as the following:

## Difficult-to-Focus Subjects

- Very low-contrast subjects, such as a blue sky or single-color wall
- Subjects in very dark locations
- Extremely backlit or reflective subjects, such as a shiny new car
- Overlapping nearby and distant objects, such as cage bars and the animal inside the cage

In such cases, use one of the following procedures:

- (1) Focus on an object that is at the same distance as the desired subject, apply Focus Lock, then recompose the picture.
- (2) Set the lens focus mode switch to MF (or M on older lenses), and focus manually.

## MF Manual Focus

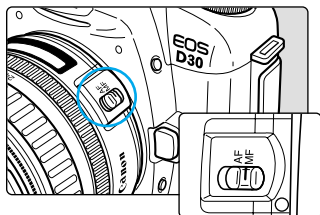

- 1 Set the lens focus mode switch to <MF> (or <M> on older lenses).**

→ The <MF> icon appears on the LCD panel.

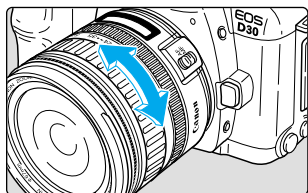

- 2 Focus on the subject.**

- Turn the manual focusing ring on the lens until the subject appears sharp in the viewfinder.



If you press and hold the shutter button down halfway as you focus manually, you will see the focusing point where the subject is focused, and the in-focus indicator (●) will light.

# INFO. Checking Camera Settings

When the camera is ready to shoot, press the **<INFO.>** button to view the current camera settings on the LCD monitor.

## Camera Setting Information

The following information is shown on the LCD monitor:

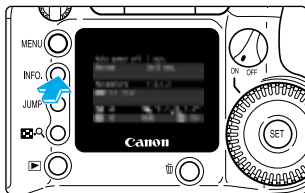
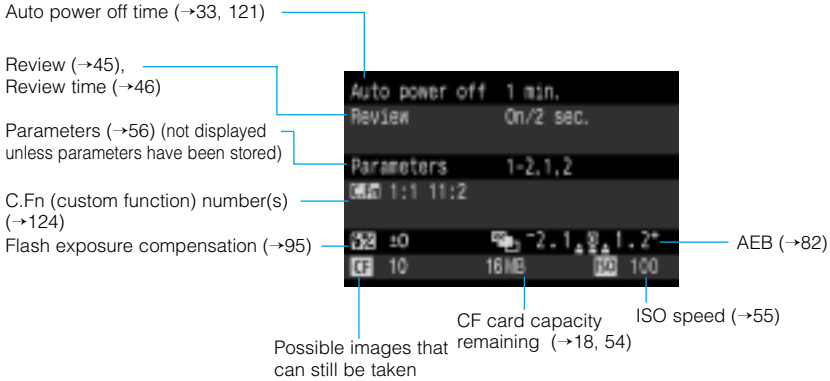

## 1 Display the camera settings.

- Press the **<INFO.>** button.
- ➔ The current camera settings appear on the LCD monitor.
- Press the **<INFO.>** button again to clear the LCD monitor.



- Parameters are shown only if settings have been entered.
- For viewing image information during playback, see "Turning the Information Display On and Off" (→104).



# Selecting a Metering Mode

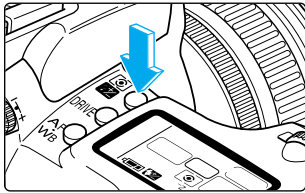

1 Press the  button. ( 06 )

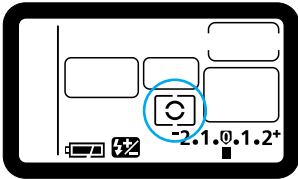

2 Select a metering mode.  
➔ Look at the LCD panel as you turn the  dial.

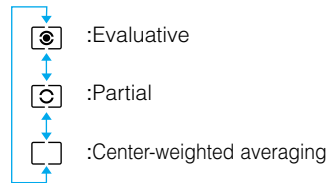

- Press the shutter button down halfway to return to ready-to-shoot mode.



Turn the  dial to set the flash exposure compensation for the built-in/optional flash (→95).

# Metering Modes

The EOS D30 uses three methods for metering: evaluative, partial, and center-weighted averaging.

The Easy Shooting zone uses evaluative metering. In the Creative zone, any of the three modes can be selected.

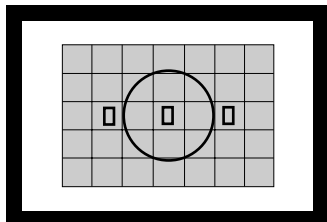

## Evaluative Metering

This is an all-around metering mode suited even for backlit subjects. The viewfinder field is divided into 35 metering zones to which the three focusing points are linked for evaluative metering. The camera determines the main subject's size, position, brightness, background, front and back lighting, etc., so that it can select the proper exposure for the subject at all times.

- When using manual focusing, evaluative metering is based on the center focusing point.

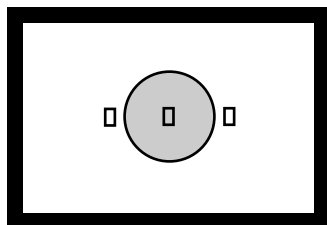

## Partial Metering

This is particularly effective when the background is much brighter than the subject due to backlighting, etc. This method uses a center area of approximately 9.5% of the screen.

- The area covered by partial metering is shown on the left.

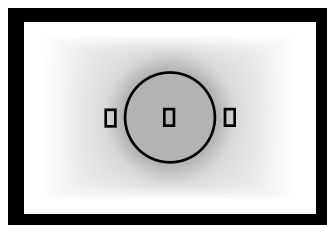

## Center-weighted Averaging Metering

This method meters the average exposure of the entire viewfinder screen, and gives extra weight to the center.

# Selecting a Drive Mode

You can set the EOS D30's drive mode to single-image shooting, continuous shooting or self-timer operation.

Single-image shooting (□): Press the shutter button to take one image.

Continuous shooting (☰): You can use the continuous shooting mode by pressing and holding the shutter button. The maximum number of images that can be taken for each quality setting is shown in the table below.

Self-timer operation: You can set the self-timer to take a picture after 10 seconds. (→85)

Size/Quality	Maximum number of images (Approx. images/sec.)		Maximum number of images (Approx. images)	
	ONE SHOT	AI SERVO	ONE SHOT	AI SERVO
L Large/Fine	3	2.5	8	
L Large/Normal			17	
S Small/Fine			17	
S Small/Normal			30	
RAW RAW			3	

- Based on Canon testing standards (shutter speed of 1/250 second or faster, at ISO 100).
- The number of frames that can be recorded depends on the subject and modes used.

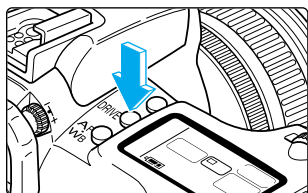

## 1 Press the <DRIVE> button. (Ⓞ6)

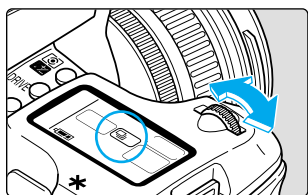

## 2 Select the drive mode.

- Look at the LCD panel as you turn the (☰) or (Ⓞ6) dial.

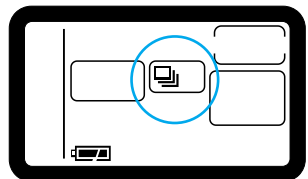
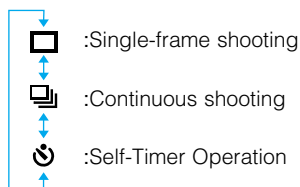

- Press the shutter button down halfway to return to ready-to-shoot mode.



- Images taken with continuous shooting are first stored in the camera's internal memory, then on the CF card. When the internal memory is full, the "Full" message appears on the LCD panel and in the viewfinder, and no more images can be taken. Once this happens, images are written onto the CF card until there is enough memory available for another image. The "Full" message then disappears, and the camera can take the next shot.
- If you press the shutter button down halfway before all of the images have been saved on the CF card (the access lamp is flashing), the saving process is canceled momentarily. The number of continuous frames at that moment depends on the capacity available on the CF card.
- When the "Full CF" message is displayed on the LCD panel and in the viewfinder, make sure that the access lamp has stopped blinking before you change the CF card.

## WB Setting the White Balance

The EOS D30 has seven white balance settings, Auto, Daylight, Cloudy, Tungsten, Fluorescent, Flash, and Custom. In the Easy Shooting zone the Auto setting is selected automatically, while in the Creative zone you can select any of the seven white balance settings.

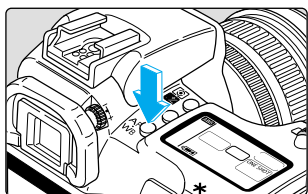

**1** Press the  $\langle \text{AF/WB} \rangle$  button. ( 06 )

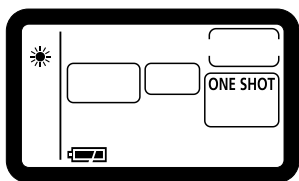

**2** Select the white balance setting.

- Set the Quick Control Dial switch to **(ON)**.
- Turn the  $\langle \text{Q}$  dial.
- Press the shutter button down halfway to return to ready-to-shoot mode.

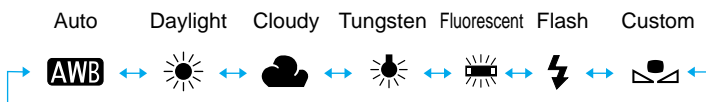







Turn the  $\langle \text{Q} \rangle$  dial to select the AF mode (→58).

# White Balance Settings

In light from any source, the proportion of the primary colors (red, green, blue) in the light varies according to the color temperature. Higher color temperatures contain a greater proportion of blue, and lower color temperatures contain a greater proportion of red. Moving from low to high, the progression is red → orange → yellow → white → blue-white. For example, a given subject will appear reddish if taken under tungsten (incandescent) lighting, or greenish if taken under fluorescent lighting.

The human eye automatically adapts to changes in light so that white subjects appear white even under different lighting conditions. Cameras that use film have to adjust for these differences by using color-correcting filters or switching to different film types. Digital cameras rely on software to correct the color temperature by determining white as the basis for the colors in the subject, then correcting the other colors to achieve a natural color range.

⟨ **AWB** ⟩ mode automatically selects the white balance according to the light source where you are shooting. If this does not produce pictures with satisfactory coloring, you can select a mode other than ⟨ **AWB** ⟩.

Icon	Conditions	Color temperature K (Kelvin)
	Camera selects the setting automatically.	approx. 3000 -7000
	For bright outdoor daylight.	approx. 5500
	For cloudy conditions at twilight or evening.	approx. 6000
	For indoor incandescent lighting.	approx. 3200
	For indoor white fluorescent lighting.	approx. 4000
	For flash pictures.	approx. 6000
	To photograph a white subject to use as a base color, then load that white balance data to set the ideal white balance for that shooting location (→70).	approx. 2000-10000

# MENU Custom White Balance Setting

Custom white balance lets you set the white balance yourself by photographing a white subject to use as the basis for the camera's white balance, and then selecting that picture for use as white balance data.

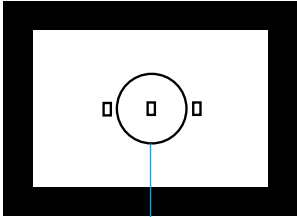

Partial metering zone

## 1 Photograph a white subject.

- Take a picture of a white subject, just as you would take a normal picture.
- Frame the shot so that the white subject fills the entire partial metering zone in the viewfinder.
- This picture can be taken using any mode (→20).

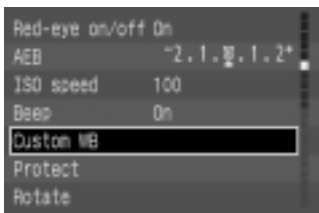

## 2 From the menu, select [Custom WB].

- Press the **<MENU>** button.
- Turn the **<Q>** dial to select [Custom WB], then press the **<SET>** button.



## 3 Select the image.

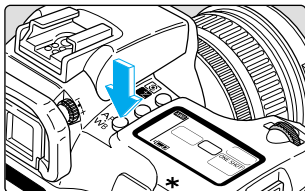

- Turn the **<Q>** dial to select the picture you took in step 1, then press the **<SET>** button.
- When the setting is entered, the screen returns to the menu.
- Press the **<MENU>** button to clear the screen and exit the menu.



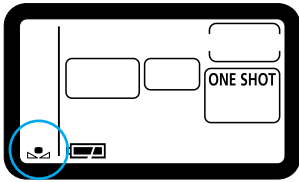

## 4 Press the **<AF/WB>** button. (06)

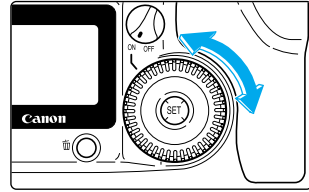

## 5 Select the white balance.

- Turn the  dial to select [  ].
- ➔ The custom white balance is entered.



- For best results, use subjects such as plain white paper for white balance basis.
- White balance data is loaded from the partial metering zone (→19).
- You can store white subjects photographed under various conditions on the CF card, then select these images as needed for the [Custom WB] function as an easy way of setting the ideal white balance for any lighting conditions.
- The default setting for  is the same as the default setting for .

# P Program AE



Like  $\langle \square \rangle$  (Full Auto) mode, this is a general-purpose picture-taking mode. The camera automatically sets the shutter speed and aperture value to suit the scene's brightness. This is called Program AE.

\* **P** stands for Program

\* **AE** stands for Auto Exposure

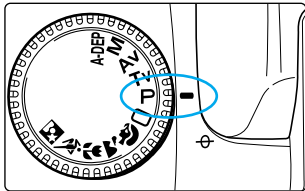

## 1 Set the Mode Dial to $\langle P \rangle$ .

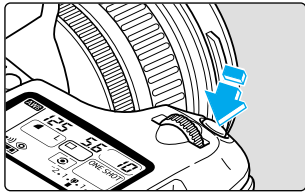

## 2 Focus on the subject.

- Press the shutter button down halfway.
- ➔ When the camera has focused, the focusing point indicator and the in-focus indicator in the viewfinder light at the same time.

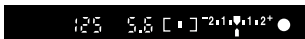

## 3 Check the display.

- ➔ The shutter speed and aperture value are determined automatically, and displayed in the viewfinder and on the LCD panel.
- If the shutter speed and aperture values are not blinking, the exposure is correct.
- If either is blinking, see "Exposure Warnings" (→ 134).

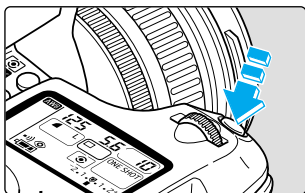

## 4 Take the picture.

- Compose the picture, then press the shutter button down fully.



## Differences Between Program AE Mode ⟨P⟩ and Full Auto Mode ⟨□⟩

- ⟨P⟩ (Program AE) and ⟨□⟩ (Full Auto) mode are alike in that both automatically determine the shutter speed and aperture values.
- The following functions can be used in ⟨P⟩ mode but not in ⟨□⟩ mode.
  - Manual focusing point selection
  - Metering mode selection
  - Drive mode selection
  - Program shift
  - AE lock with ⟨\*⟩ button
  - Exposure compensation
  - Autoexposure bracketing (AEB)
  - Custom functions
  - Built-in flash firing manually/firing prohibited
  - Flash exposure compensation
  - Special features with EX-series Speedlites
    - High-speed sync (FP Flash) with selected EX-series Speedlites
    - FE lock
    - Fill flash control
    - FEB
    - 2nd-curtain sync
    - Modeling flash
    - E-TTL wireless autoflash

## Shifting the Program

In Program AE mode, you can freely change the shutter speed and aperture value combination (program) set by the camera while maintaining the same exposure value. This is called shifting the program.

To do this, press the shutter button down halfway, then turn the ⟨⟩ dial until the shutter speed or aperture value you want is displayed.

- Once you take a picture with the shifted program, the shifted program is canceled automatically and the original program is restored.
- If you are using a flash, you cannot shift the program.

# Tv Shutter Speed-Priority AE

In this mode, you set the shutter speed, and the camera automatically sets the aperture value to suit the brightness of the subject. This is called Shutter Speed-Priority AE.

A fast shutter speed can freeze the motion of a fast-moving subject, and a slow shutter speed can blur the subject to give the impression of motion.

\*Tv stands for "time value."



Fast shutter speed



Slow shutter speed

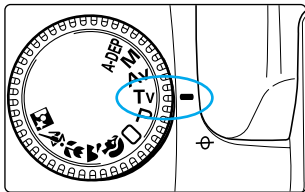

## 1 Set the Mode Dial to <Tv>.

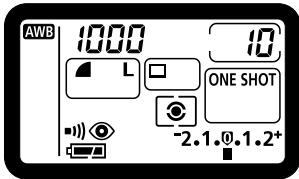

## 2 Set the shutter speed.

- Turn the <🌄> dial.

## 3 Focus on the subject.

- Press the shutter button down halfway.
- ➔ The aperture value is determined automatically.

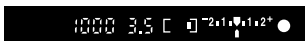

## 4 Check the display, then take the picture.

- If the aperture value is not blinking, the exposure is correct.
- Compose the picture, then press the shutter button down fully.



- At shutter speeds slower than one second, the release time lag (between the time the shutter button is pressed completely and the start of the exposure) is approximately 1 second. The release time will be a little longer when the drive mode is continuous shooting, even if the shutter speed is faster than one second. In this case, hold the shutter button down until the pictures have been taken.



- If the smallest aperture value (the maximum open aperture) for the lens you are using blinks, the scene is too dark. Turn the  $\langle \text{Aperture Dial} \rangle$  dial to a slower shutter speed until the aperture value stops blinking.
- If the largest aperture value (the minimum aperture) for the lens you are using blinks, the scene is too bright. Turn the  $\langle \text{Aperture Dial} \rangle$  dial to a faster shutter speed until the aperture value stops blinking.



### Shutter Speed Display

You can set the shutter speed in half-stop increments as shown below. The shutter speeds from 4000 to 4 indicate the denominator of the fractional shutter speed, so that—for example—125 is 1/125 second. For slow speeds, 0"7 is 0.7 seconds, and 15" is 15 seconds.

4000 3000 2000 1500 1000 750 500 350 250 180 125 90 60 45 30 20  
 15 10 8 6 4 0"3 0"5 0"7 1" 1"5 2" 3" 4" 6" 8" 10" 15" 20" 30"



The ideal shutter speed for capturing a clear image from a TV screen is 1/15 second. We recommend using a tripod.



You can also set the camera so that you can set the shutter speed in 1/3-stop increments. (C.Fn-4 →124)

# Av Aperture-Priority AE

In this mode, you set the aperture value, and the camera automatically sets the shutter speed to suit the brightness of the scene. This is called Aperture-Priority AE.

By setting a smaller aperture value (larger aperture), you can blur the background to make the subject stand out as in a portrait. Or, by setting a larger aperture value (smaller aperture), you can increase the depth of field to make both the foreground and background look sharp.

\* **Av** stands for “aperture value.”



Small aperture value



Large aperture value

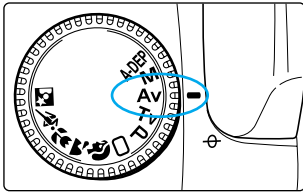

## 1 Set the Mode Dial to <Av>.

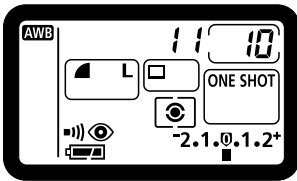

## 2 Select the aperture value.

- Turn the  dial.

## 3 Focus on the subject.

- Press the shutter button down halfway.
- ➔ The shutter speed is determined automatically.



## 4 Check the display, then take the picture.

- If the shutter speed is not blinking, the exposure is correct.
- Compose the picture, then press the shutter button down fully.



- If the 30" shutter speed blinks, the scene is too dark. Turn the  dial to reduce the aperture value (larger aperture).



- If the 4000 shutter speed blinks, the scene is too bright. Turn the  dial to increase the aperture value (smaller aperture).



### Aperture Value Display

You can set the aperture in half stops as shown below. The higher the aperture value, the smaller the aperture opening. The range of aperture settings displayed depends on the lens mounted on the camera.

1.0 1.2 1.4 1.8 2.0 2.5 2.8 3.5 4.0 4.5 5.6 6.7 8.0 9.5 11 13 16 19 22 27  
32 38 45 54 64 76 91

If no lens is mounted on the camera, the aperture setting is displayed as 00.



- You can also set the camera so that you can set the aperture value in 1/3-stop increments. (C.Fn-4 →124)
- You can fix the shutter speed at 1/200 second for shooting with a flash. (C.Fn-6-1 →126)

## Checking the Depth of Field

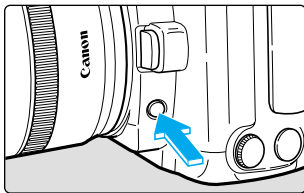

You can press the Depth-of-Field Preview button to close the aperture to the current aperture setting, and then verify the range of focus in the viewfinder.



- This feature can be used in the Creative zone.
- In **(A-DEP)** mode, this feature operates when the shutter button is pressed down halfway.
- The exposure is locked (AE lock) while the Depth-of-Field Preview button is pressed.

# M Manual Exposure



In this mode you set the shutter speed and aperture value yourself. The camera makes no settings automatically. You can determine the correct combination of shutter speed and aperture value by checking the exposure level displayed in the camera.

\* **M** stands for manual.

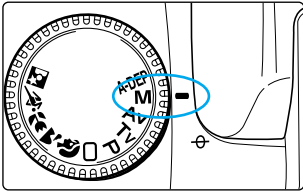

## 1 Set the Mode Dial to <M>.

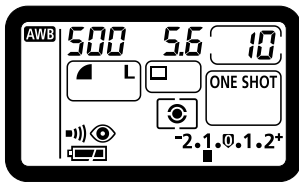

## 2 Set the shutter speed.

- Turn the  dial.

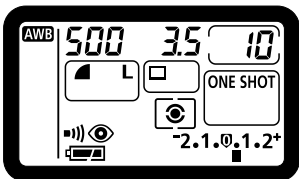

## 3 Set the aperture value.

- Set the Quick Control Dial switch to <ON>, then turn the  dial.

## 4 Focus on the subject.

- Press the shutter button down halfway. (ⓘ4)
- ➔ The exposure level indicator appears in the viewfinder and on the LCD panel.
- The exposure level icon  lets you see how far you are from the standard exposure level.

## 5 Determine the exposure.

- Set the shutter speed or aperture value manually.

Standard exposure	-2.1.0.1.2 <sup>+</sup>	: This is the standard reference point for a correct exposure.
Underexposure	-2.1.0.1.2 <sup>+</sup>	: Decrease the shutter speed or reduce the aperture value.
Overexposure	-2.1.0.1.2 <sup>+</sup>	: Increase the shutter speed or increase the aperture value.

- If the exposure level indicator (■) is flashing at the (2<sup>+</sup>) or (2<sup>-</sup>) position, the exposure is over- or under-exposed by more than two stops.

## 6 Take the picture.

- Compose the picture, then press the shutter button down fully.



You can set the camera so that you can set the shutter speed or aperture value in 1/3-stop increments. (C.Fn-4 →124)

# A-DEP Automatic Depth-of-Field AE

When taking pictures of large groups or landscapes, the EOS D30 can automatically achieve a sharp focus over a wide depth of field. All the subjects covered by the focusing points, from those close to the camera to those far away from the camera, can be taken clearly.

- In  $\langle$  A-DEP  $\rangle$  mode, the shutter speed and aperture value cannot be changed freely. If the camera selects a slow shutter speed, the use of a tripod is recommended.
- Automatic depth-of-field AE cannot be used if the lens' focus mode switch is set to  $\langle$ MF $\rangle$  (or  $\langle$ M $\rangle$  on older lenses). Set the switch to  $\langle$ AF $\rangle$ .

\* A-DEP stands for Auto-Depth of field.

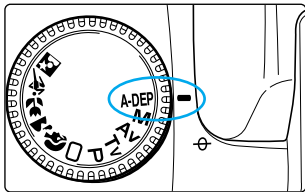

## 1 Set the Mode Dial to $\langle$ A-DEP $\rangle$ .



## 2 Focus the picture.

- Place a focusing point over the subject and press the shutter button down halfway. ( $\odot 4$ )
- The active focusing points are displayed. The range between the nearest subject covered by a focusing point and the farthest subject covered by another focusing point will be in sharp focus.
- You can check the depth of field beforehand while the exposure is displayed. ( $\rightarrow 77$ )
- In this example, the focus will be sharp from the distant subject covered by the left focusing point to the nearby subject covered by the right focusing point.



## 3 Check the display, then take the picture.

- If the aperture value is not blinking, the exposure level is correct.
- Press the shutter button down fully.



If the aperture value is blinking, the exposure level is correct but the desired depth of field cannot be achieved. Either use a wide-angle lens or move farther from the subject.



If you use a flash, the result will be the same as using  $\langle$  P  $\rangle$  (Program AE) mode with flash.



# Setting Exposure Compensation

Exposure compensation is used to alter the camera's standard exposure setting to make the picture brighter (overexposure) or darker (underexposure). Exposure compensation can be set up to  $\pm 2$  stops, in 1/2-stop increments.

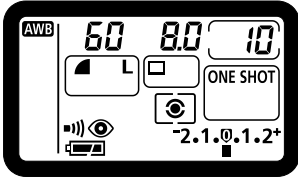

**1** Set the Quick Control Dial switch to **<ON>**.

**2** Focus on the subject, then check the exposure level.

- Press the shutter button down halfway and check the display. (  $\odot 4$  )

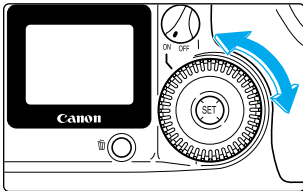

**3** Select the exposure.

- Turn the  $\langle \odot \rangle$  dial.
- Turn the  $\langle \odot \rangle$  dial while pressing the shutter button down halfway, or within (  $\odot 4$  ) seconds of pressing the shutter button down halfway.
- Positions on the [+ ] side indicate overexposure, and positions on the [- ] side indicate underexposure.

Underexposure  $-2.1.0.1.2^+$  Overexposure

A diagram of the exposure compensation dial with a central 0 mark. Blue arrows point left and right from the 0 mark, labeled 'Underexposure' and 'Overexposure' respectively.

- Once set, the exposure compensation remains in memory after the Main Switch is set to **<OFF>**.
- To cancel exposure compensation, return the compensation setting to the standard exposure position  $\langle \odot \rangle$ .

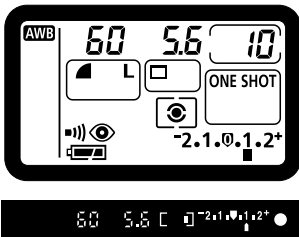

**4** Take the picture.



- To prevent the  $\langle \odot \rangle$  dial from turning inadvertently and changing the exposure compensation, enter the setting and then set the Quick Control Dial switch to **<OFF>**.
- In **<M>** (Manual) mode, because you determine the exposure (the combination of shutter speed and aperture) yourself, the exposure compensation function does not operate.

**C.Fn** You can set the camera so that you can set the exposure compensation amount in 1/3-stop increments. (C.Fn-4  $\rightarrow$  124)

# MENU Autoexposure Bracketing

When using autoexposure bracketing, the camera automatically changes the exposure level within the set range (up to  $\pm 2$  stops in 1/2-stop increments) for three successive frames. This is called AEB (Auto Exposure Bracketing). The three bracketed shots are exposed in the selected drive mode ( $\rightarrow 67$ ) in the following order: correct exposure, underexposure, and overexposure.



Correct exposure (0)



Underexposure (-1.0)



Overexposure (+1.0)

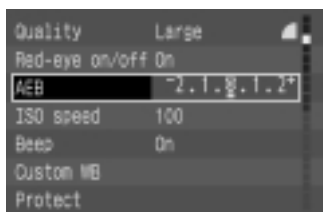

## 1 From the menu, select [AEB].

- Press the **[MENU]** button.
- Turn the **[DIAL]** to select [AEB], then press the **[SET]** button.

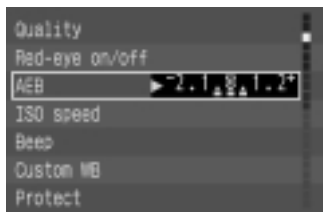

## 2 Set the AEB level.

- Turn the **[DIAL]** to set the AEB level you want, then press the **[SET]** button.
- The AEB setting is entered, and the display returns to the Menu.
- Press the **[MENU]** button to clear the screen and exit the menu.

-2.1.0.1.2+ :Correct exposure

-2.1.0.1.2+ :Underexposure

-2.1.0.1.2+ :Overexposure

## 3 Take the picture.

- When using continuous shooting, press and hold the shutter button down fully to take all three bracketed shots continuously, and then stop automatically.
- When using AEB with the self-timer, the camera takes the three bracketed shots in succession after the 10-second timer delay.

## Canceling AEB

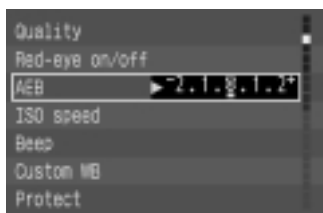

- Follow steps 1 and 2 to set the AEB level to **[0]**.
- AEB will be automatically cancelled when the Main Switch is set to **[OFF]**, the lens is changed, the flash is charged, the battery pack or the CF card is replaced.



- Neither flash nor bulb exposures can be used in AEB mode.
- If you set mirror lockup with C.Fn-3-1 and then use AEB, single-frame shooting takes effect even if the drive mode is set to continuous shooting.



- To indicate that AEB is in progress, the AEB icon on the LCD panel and the indicator in the viewfinder blink until all three bracketed shots have been taken.
- During continuous shooting, no viewfinder information is displayed.
- In manual exposure mode, AEB is applied by changing the shutter speed.
- You can use AEB in combination with exposure compensation. In this case, if exposure compensation causes the exposure to fall outside the indicated exposure level, the display looks as follows. In all cases the exposures are taken according to the settings.

**In  $\langle P \rangle$ ,  $\langle Tv \rangle$ ,  $\langle Av \rangle$  and  $\langle A-DEP \rangle$  modes**

: AEB set to  $\pm 1$  stop.

: With exposure compensation of  $-1$  stop

: With exposure compensation of  $-1.5$  stops

: With exposure compensation of  $-2$  stops

**In  $\langle M \rangle$  mode**

: Center exposure  $-2$  stops from correct exposure

: Center exposure more than  $-2$  stops from correct exposure

: Center exposure more than  $-2$  stops from correct exposure



- You can change the AEB settings in 1/3-stop increments. (C.Fn-4  $\rightarrow$  124)  
In this case, the AEB indicator on the LCD panel looks like this.

**AEB settings in 1/3-stop increments**

:  $-1/3$

:  $+1/3$

**AEB settings in 2/3-stop increments**

:  $-2/3$

:  $+2/3$

- You can change the sequence to underexposure, correct exposure, or overexposure. (C.Fn-7  $\rightarrow$  126)

# \* AE Lock

AE lock enables you to lock the exposure at a place other than the point of focus. After locking the exposure, you can recompose the shot while maintaining the exposure level. This feature is useful for backlit and spotlighted subjects.

- The effects of the AE lock depend on the focusing point and metering method selected. (→135)

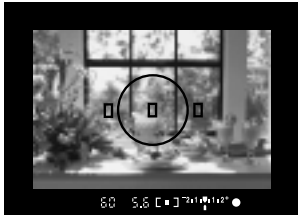
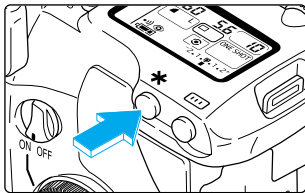
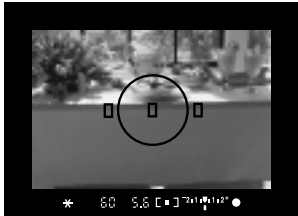

## 1 Focus on the point on which you want to lock the exposure reading.

- ➔ The exposure value is displayed in the viewfinder.

## 2 Press the (<\*)> button.

- The (<\*)> icon lights in the viewfinder to indicate that the exposure setting is locked. (◁4)
- Each time you press the (<\*)> button, the current exposure setting is locked.

## 3 Compose the shot and take the picture.



**C.Fn** You can apply AE lock by pressing the shutter button (instead of the (<\*)> button) down halfway, and focus with the (<\*)> button. (C.Fn-2-1 →124)

# Self-timer Operation

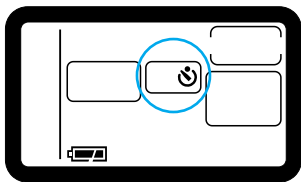
The self-timer is convenient for group photographs. You can use it in any Easy Shooting mode or Creative mode. We recommend using a tripod when you use the self-timer.



## 1 Select the self-timer.

- Press the **<DRIVE>** button (  ), and turn the **<MODE>** dial to select (  ).

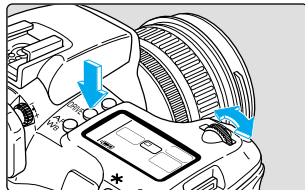

## 2 Focus on the subject.

- Make sure the in-focus indicator (  ) and the exposure setting are displayed.

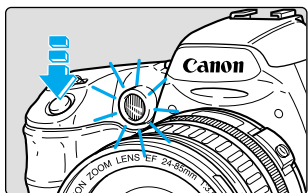

## 3 Take the picture.

- Press the shutter button down fully.
- The beep sounds as the red-eye reduction lamp operates, and the picture is taken after 10 seconds.

First 8 seconds:

Slow beeps and the lamp blinks slowly.

Last 2 seconds:

Faster beeps and the lamp stays on.

- While the self-timer is operating, the LCD panel shows the number of seconds remaining until the picture is taken.
- To cancel the self-timer, press the **<DRIVE>** button.



Do not stand in front of the camera when you press the shutter button to start the self-timer. Doing so prevents the camera from focusing on the subject.



- You can set the beep that indicates the subject is in focus and the beep that indicates the self-timer is operating to On or Off. (→120)
- When using the self-timer to photograph only yourself, lock the focus (→62) on an object at about the same distance as where you will be.
- You can use the Remote Switch RS-80N3 (sold separately) or Timer Remote Controller TC-80N3 (sold separately) to take a picture when you are away from the camera.

## Using the Eyepiece Cover

If you take a picture using the self-timer or remote switch (sold separately) without looking through the viewfinder, stray light can enter the eyepiece and affect the exposure. To prevent this, attach the eyepiece cover to the viewfinder eyepiece before taking the picture.

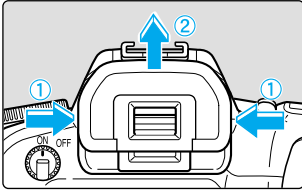

### 1 Remove the eyecup.

- Grasp both sides of the eyecup and lift it up and away from the camera.

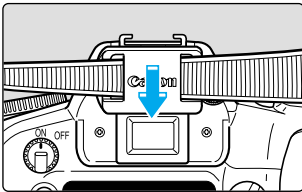

### 2 Slip the eyepiece cover over the eyepiece.

- The eyepiece cover is attached to the camera strap.

# Bulb Exposures

In a bulb exposure, the shutter remains open as long as you hold the shutter button down, and closes when you release it. Bulb exposures are useful for the long exposures required for night scenes, fireworks, etc.

## 1 Set the Mode Dial to $\langle M \rangle$ .

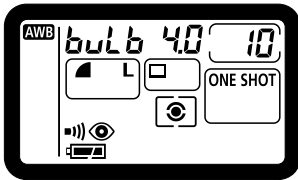

## 2 Set the shutter speed to [ bulb ].

- Look at the LCD panel and turn the  $\langle \text{bulb} \rangle$  dial to select [ bulb ].
- The next setting after [ 30'' ] is [ bulb ].

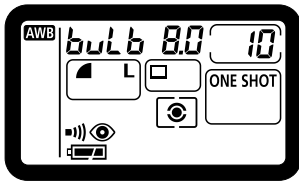
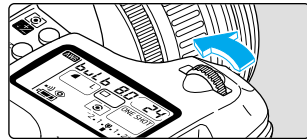

## 3 Set the aperture value.

- Turn the  $\langle \text{A} \rangle$  dial.

## 4 Take the picture.

- Press and hold the shutter button down fully.
  - ▶ During the bulb exposure, the elapsed exposure time is displayed on the LCD panel (1 to 999 seconds).
- Exposure continues as long as you hold down the shutter button.



- The elapsed exposure time displayed on the LCD panel is only counted up to 999 seconds. For accurate exposure time, check the information display for the exposed image. (→104)
- Long exposures exceeding 1 second result in increased noise introduced into the image, and reduce the quality of the image.



The Remote Switch RS-80N3 (sold separately), or Timer Remote Controller TC-80N3 (sold separately) can be used to eliminate the need to hold down the shutter button.



In long exposures, some degree of noise can enter the exposed image. You can use the Long exposure noise reduction function to reduce the noise. (C.Fn-1→124)

# Mirror Lockup

Mirror lock is enabled with C.Fn-3-1 (→124). This function raises the mirror and exposes the picture, in separate operations. It is useful for close-up shots or when using a super telephoto lens, where the mirror shock could affect the picture.

- When using mirror lockup, we recommend you use the Remote Switch RS-80N3 (sold separately).

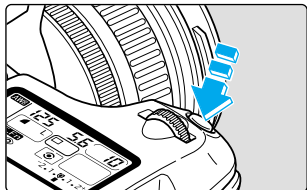

## 1 Press the shutter button down fully.

- ➔ The mirror is raised.
- The mirror automatically returns to the down position approximately 30 seconds after it is raised. Be sure to take the picture within 30 seconds.

## 2 Press the shutter button down fully again.

- The picture is taken, and the mirror goes back down.
- To take the picture again, repeat the procedure from step 1.



- During mirror lockup, do not point the camera at the sun. The sun's heat can scorch and damage the shutter curtains.
- If you use mirror lockup with the self-timer for a bulb exposure, there will be a shutter release sound when you release the shutter button during self-timer operation. This is not the sound of the shutter release.



- During mirror lockup, the drive mode (→67) is single-frame shooting regardless of the current setting.
- If you use mirror lockup with the self-timer, pressing the shutter button down fully the first time raises and locks the mirror, then releases the shutter 2 seconds later.



# Flash Photography

# 4

The EOS D30 can take easy, natural-looking flash pictures with correct subject illumination using E-TTL autoflash (preflash evaluative metering in memory) and either the camera's built-in flash or any EOS-dedicated EX-series Speedlite. The procedure is as easy as a normal AE shot.

This chapter describes how to take flash pictures with the built-in flash, with the EOS-dedicated 550EX Speedlite, or other types of external flash.

# Using the Built-in Flash

The built-in flash lets you take the following kinds of flash pictures with the ease of a normal AE shot.

## ● E-TTL autofocus

E-TTL autofocus (preflash evaluative metering in memory) supplies the correct level of flash for the subject in the focusing point selected by AF.



## ● FE (Flash Exposure) lock (→94)

FE (flash exposure) lock sets the correct flash exposure for a selected part of the subject. The FE lock functions as an AE lock with flash.

## ● Flash exposure compensation (→95)

This function corrects the flash level in much the same way as the Exposure compensation function. The level of compensation can be up to  $\pm 2$  stops in 1/2-stop increments.

## Using the Built-in Flash in the Easy Shooting Zone

In the Easy Shooting zone (except in  and  modes), the built-in flash pops up and fires automatically in low-light or backlit conditions.

## Using the Built-in Flash in the Creative Zone

In the Creative zone, you can take flash pictures by simply pressing the  button to pop up the built-in flash at any time, regardless of lighting conditions.

- P** : Select **<P>** mode for full autofocus.  
The shutter speed and aperture value are determined automatically, just as in **<□>** (Full Auto) mode.
- Tv** : Select **<Tv>** mode to manually set a shutter speed slower than 1/200 second. The camera then automatically sets the flash aperture value to provide the proper exposure for your shutter speed.
- Av** : Select **<Av>** mode to manually set the aperture value.  
In low-light conditions against a background such as a night sky, you can use automatic slow-sync settings to properly expose the main subject and the background. The main subject is captured by the flash, and the background is captured by time exposure using a slow shutter speed.
  - Because automatic slow-sync photography uses a slow shutter speed, always use a tripod.
- M** : Select **<M>** mode to set the shutter speed and the aperture value manually. The main subject is exposed properly by the flash. The background exposure varies according to the shutter speed and aperture settings.
- A-DEP** : The effect is the same as using flash in **<P>** mode.

## Built-in Flash Range

(using EF24-85mm F3.5-4.5 USM lens)

ISO Speed	Wide-angle: 24 mm	Telephoto: 85 mm
100	Approx. 1-3.4 m (3.3-11.2 ft)	Approx. 1-2.6 m (3.3-8.5 ft)
200	Approx. 1-4.8 m (3.3-15.7 ft)	Approx. 1-3.7 m (3.3-12.1 ft)
400	Approx. 1-6.8 m (3.3-22.3 ft)	Approx. 1-5.3 m (3.3-17.4 ft)
800	Approx. 1-9.6 m (3.3-31.5 ft)	Approx. 1-7.5 m (3.3-24.6 ft)
1600	Approx. 1-13.7 m (3.3-44.9 ft)	Approx. 1-10.6 m (3.3-34.8 ft)

## Flash Sync Shutter Speed and Aperture Settings

Mode	Sync shutter speed	Aperture Value
<b>P</b>	Automatically set from 1/200 to 1/60 second.	Automatically set by the E-TTL program.
<b>Tv</b>	Manually set to speeds slower than 1/200 second.	Automatically set for the metered brightness, according to the shutter speed setting.
<b>Av</b>	Automatically set (1/200 to 30 sec.) for the metered brightness, according to the aperture value.	Manually set as desired.
<b>M</b>	Manually set to speeds slower than 1/200 second.	



- When using an EX-series Speedlite (→96), press the built-in flash back into the camera before mounting the external flash.
- When using the built-in flash, keep at least 1 m/3.3 ft away from the subject. Otherwise the lens barrel may partially obstruct the flash and cause part of the photo to look dark.
- When using the built-in flash, detach any hood from the lens to keep it from obstructing flash coverage.
- Using the built-in flash with any of the following lenses can partially obstruct the flash coverage. Instead, use an EOS-dedicated external flash.  
Large-aperture lenses, including the EF17-35mm F2.8L USM, EF28-70mm F2.8L USM.  
Super-telephoto lenses, including the EF300mm F2.8L IS USM and EF600mm F4L IS USM.
- The built-in flash can cover the picture area for lenses with focal lengths as short as 18 mm. If you use a lens shorter than 18 mm, the photo will be dark around the edges.



- The 'E' in E-TTL stands for 'Evaluative.'
- To retract the built-in flash, press it back down into the camera.
- You cannot use the built-in flash to set high-speed sync (FP flash).
- In **(Tv)** or **(M)** mode, if you set the shutter speed faster than 1/200 second, the camera will automatically reset it to 1/200 unless the EX-series Speedlite has been set for high-speed sync.
- AF flash exposure is always based on the aperture value at the time the shot is taken, and controlled by E-TTL automatic flash compensation linked to the active focusing point and weighted for the main subject.
- The built-in flash and external flash cannot be used at the same time.
- For subjects that are difficult to focus, the AF-assist light (→43) automatically projects a beam of light at the subject.



**C.Fn** You can set the Shutter curtain sync to 2nd-curtain sync. (C.Fn-8-1→126)

## **MENU** Red-eye Reduction

When you use flash in low-light conditions, it can reflect off your subject's pupils and make their eyes look red in the photograph. This effect is called "red-eye," and is caused by the light of the flash reflecting off the retina of the eye. The Red-eye reduction function uses the camera's red-eye reduction lamp, which gently shines into the subject's eyes to constrict the pupils and thereby reduces the likelihood that red-eye will occur. You can use red-eye reduction in any picture-taking mode except  $\langle \text{M} \rangle$  and  $\langle \text{M} \rangle$  modes.

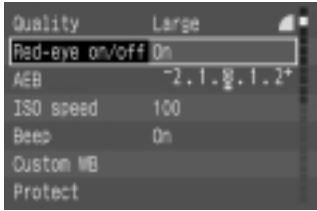

### 1 From the menu, select [Red-eye on/off].

- Press the  $\langle \text{MENU} \rangle$  button.
- Turn the  $\langle \text{DIAL} \rangle$  dial to select [Red-eye on/off], then press the  $\langle \text{SET} \rangle$  button.

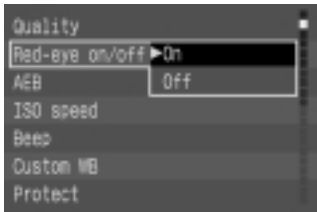

### 2 Set the Red-eye reduction function.

- Turn the  $\langle \text{DIAL} \rangle$  dial to select [On], then press the  $\langle \text{SET} \rangle$  button.
  - ➔ The red-eye reduction function is turned On, and the display returns to the Menu.
- Press the  $\langle \text{MENU} \rangle$  button to clear the screen and exit the menu.



- When you press the shutter button down halfway, the red-eye reduction lamp indicator appears in the viewfinder.
- Red-eye reduction is effective only when the subject is looking at the red-eye reduction lamp. Be sure to tell your subjects to look at the lamp.
- To increase the effectiveness of red-eye reduction, press the shutter button down fully approximately 1.5 seconds after the red-eye reduction lamp indicator goes off.
- You can take a picture anytime by pressing the shutter button down fully, even if the red-eye reduction lamp is on.
- Red-eye reduction also operates when you use an EOS-dedicated Speedlite.
- The effectiveness of red-eye reduction varies from subject to subject.

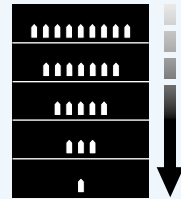

Red-eye reduction lamp indicator



Red-eye reduction is more effective in bright interior locations, with the camera close to the subject.

## FE Lock

FE (flash exposure) Lock obtains and locks the correct flash exposure reading for any part of a subject. FE Lock is a function in the Creative zone.

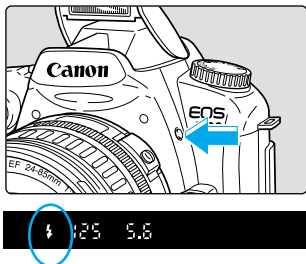

### 1 Make sure the $\langle \text{⚡} \rangle$ icon in the viewfinder is on.

- In the Creative zone, press the  $\langle \text{⚡} \rangle$  button to pop up the built-in flash.

### 2 Focus on the subject.

- Focus on the subject you want to lock the flash exposure on.

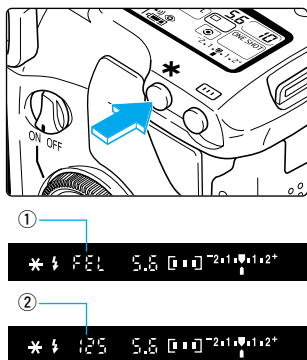

### 3 Place the center focusing point over the subject, and press the $\langle \text{✳} \rangle$ button. ( $\text{⓪16}$ )

- ➔ The  $\langle \text{✳} \rangle$  icon lights in the viewfinder.
- ➔ The Speedlite fires a preflash and records the required flash output for this subject in memory.
- ➔ In the viewfinder, the display appears as shown in ① for 0.5 seconds, then changes to ②.
- Each time you press the  $\langle \text{✳} \rangle$  button the preflash fires, and the FE lock is applied at the required exposure level.

### 4 Take the picture.

- Compose the shot and take the picture.



If the subject is far enough away to cause underexposure, the  $\langle \text{⚡} \rangle$  icon will blink in the viewfinder. Move closer to the subject and repeat steps 2 – 4.

## Flash Exposure Compensation

The EOS D30 camera can adjust the level of the built-in flash or any EX-series Speedlite. The compensation amount can be up to  $\pm 2$  stops in 1/2-stop increments. You cannot use flash exposure compensation in the Easy Shooting zone.

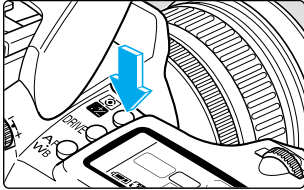

**1** Press the  button. (  6 )

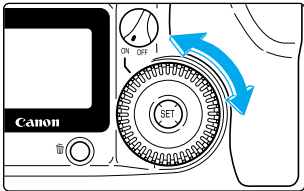

**2** Set the exposure compensation amount.

- Set the Quick Control Dial Switch to **(ON)**.
- Look at the LCD panel as you turn the  dial.
- The [+ ] side indicates positive compensation, and the [- ] side indicates negative compensation.

Negative compensation  $-2.1.0.1.2^+$  Positive compensation



- Once set, the exposure compensation amount remains in memory after the Main Switch is set to **(OFF)**.
- To cancel, set the compensation amount to the  position.

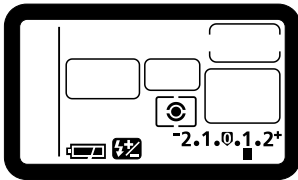

The flash Exposure compensation function also operates when you use an EX-series Speedlite. If the camera and EX-series Speedlite are both set for exposure compensation, the EX-series Speedlite setting has priority and the camera setting does not function.



- You can set the camera to adjust exposure compensation in 1/3-stop increments. (C.Fn-4  $\rightarrow$  124)
- You can also disable the Auto reduction of fill flash function. (C.Fn-10  $\rightarrow$  126)

# Flash Photography with the EOS-Dedicated 550EX Speedlite

The Canon 550EX Speedlite allows you to take high-quality flash pictures easily, in the same way as you would with a built-in flash.

## ● E-TTL Autoflash

E-TTL autoflash (preflash evaluative metering in memory) supplies the correct level of flash for the subject in the focusing point selected by AF. In dark locations, you can set the camera to aperture-priority AE for automatic slow-sync operation, for a natural-looking exposure balanced between the subject and background.

## ● High-Speed Sync (FP Flash) (→98)

High-speed sync (FP or focal-plane flash) enables flash synchronization at all shutter speeds from 30 sec. to 1/4000 sec.

## ● FE (Flash Exposure) Lock (→99)

FE lock obtains and locks the correct flash exposure for any part of the subject. This is the flash equivalent of AE lock.

## ● Flash Exposure Compensation (→99)

As with normal exposure compensation, you can use flash exposure compensation to adjust the flash output within a range of  $\pm 2$  stops, in 1/2-stop increments.

## ● FEB (Flash Exposure Bracketing) (→98)

The FEB function is like AEB (autoexposure bracketing) with flash. You can bracket flash exposures by up to  $\pm 3$  stops, in 1/2-stop increments.

## ● Modeling Flash (→99)

Modeling flash allows you to check shadows and the light balance produced by multi-light settings.

## ● Wireless Multi-Light E-TTL Autoflash (→99)

You can implement wireless multi-light E-TTL autoflash, using any or all of the features listed above. This provides the freedom to set up sophisticated lighting effects with no connection cords required.



Autoflash functions are not available with EZ, E, EG, ML, or TL-series Speedlites.



- You can also use the Canon 420EX and 220EX Speedlites. Refer to their respective user's guides for a list of functions that can be used with them.
- In difficult focusing conditions, the AF-assist light is emitted from the 550EX Speedlite, and automatically linked to the active focusing point.



## Full Auto Flash

This section describes how to use Full Auto E-TTL flash with **<P>** (Program AE) mode. For instructions for operating the 550EX Speedlite, see the 550EX User's Guide.

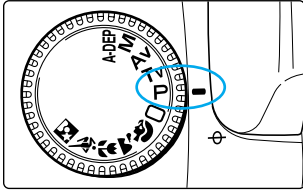

**1** Set the Mode Dial to **<P>**.

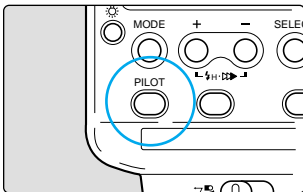

**2** Make sure the 550EX Speedlite's pilot lamp is on.

**3** Focus the subject, and take the picture.

- Make sure the flash-ready indicator (**<⚡>**) is on, and check the shutter speed and aperture value before taking the picture.



## Taking Flash Pictures in Each Shooting Mode

Even in **<Tv>**, **<Av>**, and **<M>** modes, E-TTL autoflash is as easy as normal picture-taking without flash.

(1) Press the shutter button down halfway to have the camera automatically set the shutter speed or aperture value, just as in normal picture-taking without flash.

Mode	Shutter speed setting	Aperture (flash aperture) setting
<b>Tv</b> (Shutter-priority AE)	Manual (30 to 1/200 sec.)	Auto
<b>Av</b> (Aperture-priority AE)	Auto (30 to 1/200 sec.)	Manual
<b>M</b> (Manual exposure)	Manual (30 to 1/200 sec.)	Manual

(2) Press the shutter button down fully for E-TTL autoflash, using preflash evaluative metering based on the aperture value set in (1).

(3) The background exposure is determined by the shutter speed and aperture value.



- Flash photography in **<A-DEP>** mode operates the same as in **<P>** mode.
- In the Easy Shooting zone (→20), the 550EX Speedlite operates in Full Auto mode, with the same functions as the built-in flash.



**C.Fn** You can set the camera to apply a fixed shutter speed of 1/200 for flash photography in aperture-priority AE mode. (C.Fn-6 →126)

## High-Speed Sync (FP Flash)

When the 550EX Speedlite is set to high-speed sync (<math>\langle \text{H} \rangle</math> mode), it can automatically synchronize at any shutter speed of 1/200 second or faster, thus providing high-speed sync (FP) flash operation. When high-speed sync is On, the (<math>\langle \text{H} \rangle</math>) icon appears in the viewfinder.

High-speed sync is effective for portrait photography in the following situations:

- (1) When you want to use daylight sync flash for a portrait, and widen the aperture (reduce the aperture value) to blur the background.
- (2) When you want to produce a catchlight in the subject's eyes.
- (3) When you want to use fill flash to eliminate shadows.

## FEB (Flash Exposure Bracketing)

With the 550EX Speedlite, FEB (flash exposure bracketing) automatically shoots three flash shots, bracketing the exposure by as much as  $\pm 3$  stops in 1/2-stop increments, without changing the background exposure.

- FEB is applied from the 550EX Speedlite. For details, see the User's Guide for your Speedlite.
- For best results use (<math>\langle \square \rangle</math>) (single-image shooting) drive mode. (→67)

**C.Fn** You can set the camera to change FEB settings in 1/3-stop increments. (C.Fn-4 → 124)

## FE Lock

Taking FE Lock pictures with the 550EX Speedlite is the same as described in "FE Lock" (→94) for the built-in flash. In step 1, be sure the 550EX Speedlite pilot lamp is on.

The flash mode may be either normal flash or high-speed sync. The FE lock operates with either mode.

## Flash Exposure Compensation

For flash pictures with flash exposure compensation, see "Flash Exposure Compensation" for the built-in flash. (→95)

## Modeling Flash

Modeling flash allows you to see shadows, light balance, and other effects produced by multi-light settings.

- 1 **Check that the camera and Speedlite are properly set for flash photography.**

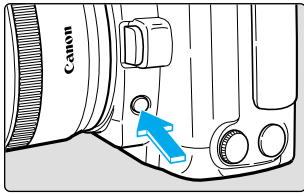

- 2 **Press the camera's depth-of-field preview button.**

- The Speedlite fires at 70Hz for approximately one second.

## Wireless Multi-Light/E-TTL Autoflash Photography

The 550EX Speedlite can be operated as a slave light from a master (550EX or ST-E2) for easy wireless multi-light/E-TTL autoflash photography. The slave 550EX is placed to supplement the master flash, which provides the primary flash for the subject.

- This is a Type-A camera. For details, refer to the user's guide for your Speedlite.

# Using Non-Canon Flash Units

## Sync Speed

The EOS D30 can synchronize with compact, non-Canon flash units at shutter speeds of 1/200 second or slower. With larger studio flash units, the flash speed is 1/60 second or slower. Be sure to test the flash you are using beforehand, to make sure it synchronizes properly with the camera.

## PC Terminal

We recommend you use a flash with sync cable connected to the PC contacts. The PC terminal has a locking thread to prevent accidental disconnection. Only the X-sync terminal is used for synchronization at 1/200 second or slower.



- If you use the EOS D30 with a flash unit or flash accessory built for another brand of camera, the EOS D30 may not operate properly.
- Some large studio flash units have a sync cord polarity that is the opposite of the EOS D30's PC terminal. Such flash units will not work with the EOS D30 unless you change the polarity of the sync cord. Consult the manufacturer of the flash unit, or purchase a commercially-available polarity conversion cord. The camera's PC terminal polarity is shown in the figure on the right.

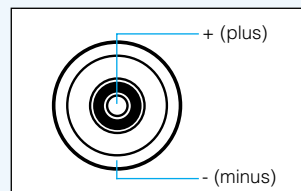

- You can use a flash unit attached to the camera's hot shoe and another flash unit connected to the PC terminal at the same time.
- We recommend Canon EX-series Speedlites for use with this camera.

# Playing and Erasing Recorded Images

# 5

This section explains how to view the images you have recorded with the EOS D30, how to erase images, and how to make settings for Digital Print Order Format (DPOF) digital printers or photo lab printing services. This section also describes how to connect the EOS D30 to a television and how to set the date and time.

## About Image Data Taken or Recorded by Other Devices

The EOS D30 may in some cases be unable to accurately display images taken with other cameras, or taken with the EOS D30 but subsequently had image data or file names modified by computer or other means.

## About DPOF

DPOF (Digital Print Order Format) is a standard used to record (on the CF card or other recording media) the image number, number of prints, etc. of images taken by digital camera.

- You can simply insert the CF card into a DPOF-compatible digital printer to make prints as specified.
- You will not need to fill out the desired numbers and quantities of prints when ordering prints from a photo printing job.

\* This camera is compatible with DPOF Version 1.00.



# Viewing Recorded Images

The EOS D30 can display recorded images on its LCD monitor. You can view these images in single-image format, index format, or enlarged format. Press the  button to switch formats.

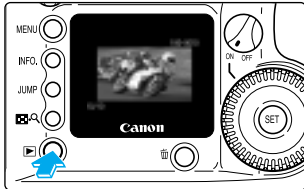
## Viewing a Single Image



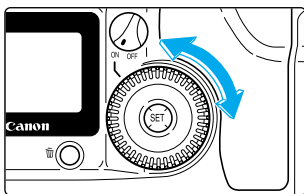

### 1 Check the image.

- Press the  button.
- ➔ The most recent single image taken by the camera appears.
- Press the  button again to clear the LCD monitor and exit PLAY.



### 2 Change the displayed image.

- Turn the  dial counterclockwise to view images in order from newest to oldest.
- Turn the  dial clockwise to view images in order from oldest to newest.

## Viewing the Index

This mode displays 9 images simultaneously on a single screen.

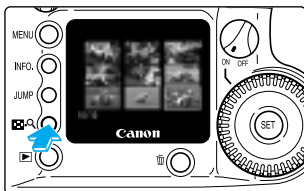

### 1 Press the button.



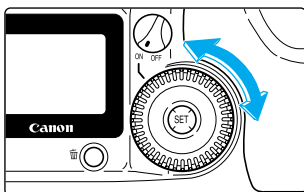

- ➔ The most recent single image taken by the camera appears.

### 2 Display the index.

- Press the  button.
- ➔ The images are displayed in index format.



### 3 Change the image selection.

- ➔ The selected image is surrounded by a green border.
- Turn the  dial counterclockwise to select images in order from newest to oldest.
- Turn the  dial clockwise to select images in order from oldest to newest.
- Press the  button to enlarge the selected image. To return to single-image display, press the  button again.
- When you finish viewing, press the  button.

## Viewing Enlarged Images

Recorded images can be enlarged approximately 3x.

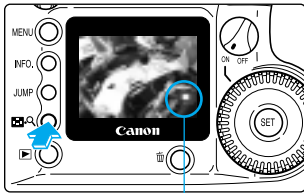

Part to be enlarged

**1** Select the image you want to enlarge from a single-image or index display. (→102)

**2** Enlarge the image.

- Press the  $\langle \text{MAGNIFY} \rangle$  button twice from a single-image display, or once from an index display.
- ➔ The selected image is enlarged approximately 3x.
- ➔ The central part of the image is displayed first.
- ➔ An icon in the lower right part of the image indicates which part of the picture is currently displayed.

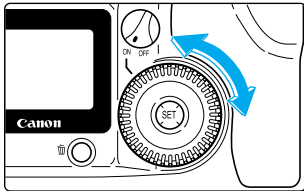

**3** Change the display area.

- Turn the  $\langle \text{SET} \rangle$  dial clockwise to change the displayed area of the picture from center to center right to lower left.
- Turn the  $\langle \text{SET} \rangle$  dial counterclockwise to change the displayed area of the picture from center to center left to top right.
- When you finish viewing, press the  $\langle \text{PLAY} \rangle$  button.

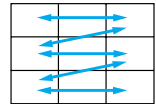

## JUMP Jumping to Another Image

The display can jump directly to another image.

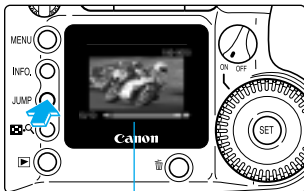

Jump bar

**1** Display a single image or index. (→102)

**2** Change to jump display.

- Press the  $\langle \text{JUMP} \rangle$  button.
- ➔ The Jump bar appears.

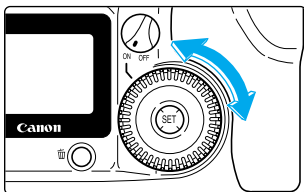

**3** Jump to another image.

- Turn the  $\langle \text{SET} \rangle$  dial.
- ➔ From a single-image display, turn the dial counterclockwise to go back 10 images, or clockwise to go forward 10 images.
- ➔ From an index display, turn the dial counterclockwise to go back 9 images, or clockwise to go forward 9 images.
- Press the  $\langle \text{JUMP} \rangle$  button to clear the Jump bar and exit JUMP.
- When you finish viewing, press the  $\langle \text{PLAY} \rangle$  button.



## INFO. Turning the Information Display On and Off

When an image is displayed on the LCD monitor, you can press the **<INFO.>** button to view information about that image. Image information is available only for single-image displays.

### Image Information Displayed During PLAY

The following information is displayed:

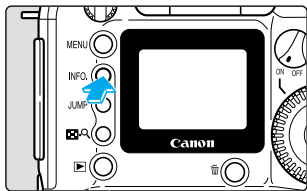
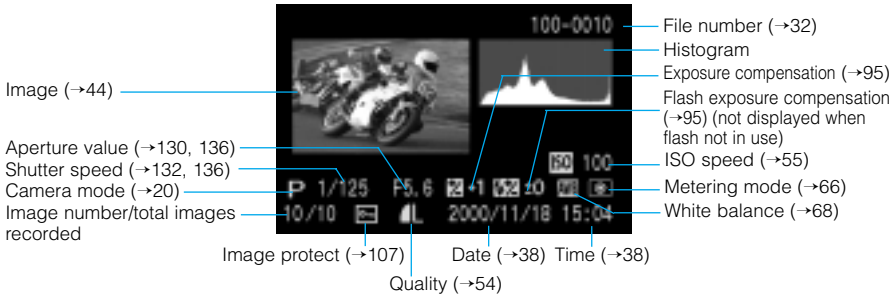

### Press the **<INFO.>** button

➔ Pressing the button repeatedly switches the LCD monitor information display On and Off.

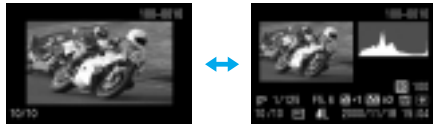

● You can change the displayed image using the **<DISP.>** dial, just as for a single-image display.



- For settings displayed while preparing to shoot, see "Checking Camera Settings" (→64).
- You can switch the information display On and Off by pressing the **<INFO.>** button, even during automated playback (Auto playback) (→105), or while rotating (→106), or protecting images (→107).

## Histograms

The histogram is a graph showing brightness levels on the horizontal axis, and the number of pixels at each level of brightness on the vertical axis. Darker pixels are towards the left side of the graph, and brighter pixels towards the right. By looking at a histogram you can determine the brightness of a picture after it is recorded.

If the histogram is higher towards the dark end, set the exposure compensation (→81) towards the plus end. If the histogram is higher towards the light end, set the exposure compensation towards the minus end, then take the picture again.

### Sample Histograms

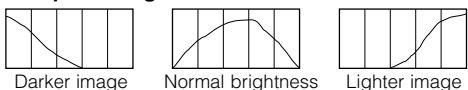

## High Brightness Warning

When exposure information is displayed for a picture that will be overexposed, the related settings will blink. For better results check the histogram and adjust the exposure compensation towards the minus end (→81), then take the picture again.



## **MENU** Automated Playback of Recorded Images (Auto playback)

This function automatically and continuously displays all images recorded on the CF card. Each image is displayed for approximately 3 seconds.

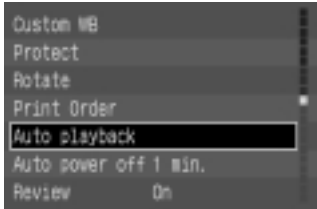

### 1 From the menu, select [Auto playback].

- Press the **<MENU>** button.
- Turn the **<DISP>** dial to select [Auto playback].

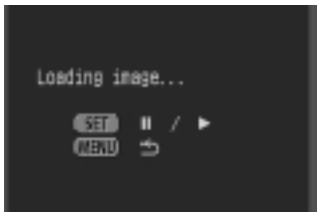

### 2 Start auto playback.

- Press the **<SET>** button.
- ➔ The camera loads the images, and after the "Loading image..." screen has been displayed for approximately 2 seconds, the auto playback starts.
- To pause auto playback, press the **<SET>** button. During the pause, the [||] indicator appears in the upper left part of the image. To resume, press the **<SET>** button again.
- To quit auto playback, press the **<MENU>** button.



- During auto playback, the Auto power off function (→33, 121) does not operate. After you have finished viewing, be sure to press the **<MENU>** button to stop the auto playback.
- Display time may vary depending on the image.



While auto playback is paused, you can turn the **<DISP>** dial to change the picture in the same way as for single-image display (→102).

## **MENU** Rotating an Image

The Rotate function can rotate a picture 90° clockwise or counterclockwise. This allows you to play images with the correct orientation.

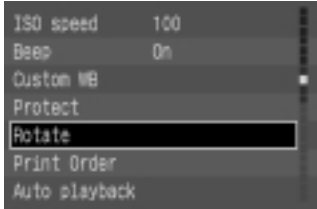

### 1 From the menu, select [Rotate].

- Press the **(MENU)** button.
- Turn the **(O)** dial to select [Rotate].

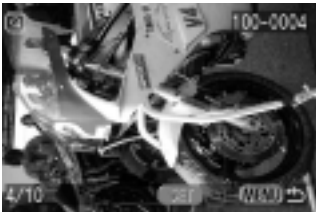

### 2 Go to Rotate mode.

- Press the **(SET)** button.
- ➔ The display goes to Rotate mode.

Rotate pictures taken with the camera grip on the bottom 90° clockwise



Rotate pictures taken with the camera grip on the top 90° counterclockwise



### 3 Rotate the image.

- Turn the **(O)** dial to display the image you want to rotate, then press the **(SET)** button.
- ➔ Press the **(SET)** button repeatedly to cycle through the rotation: 90° clockwise → 90° counterclockwise → 0°.
- If you have other images to be rotated, repeat the above steps.
- Press the **(MENU)** button to exit Rotate mode.



- Rotating images in the display has no effect on the recorded image data.
- Some software for loading images may not display a rotated image with the correct orientation on a computer screen.



Pictures taken with the camera grip on the bottom should be rotated 90° clockwise to be displayed correctly. Pictures taken with the camera grip on the top should be rotated 90° counterclockwise to be displayed correctly.

# MENU Protecting an Image

This function lets you protect an image file to keep it from being accidentally deleted from the CF card.

You can press the **[MENU]** button to switch between single-image and index display in order to protect individual pictures.

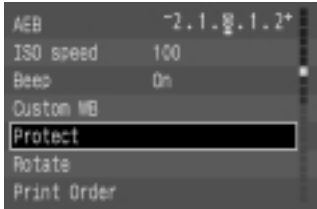

## 1 From the menu, select [Protect].

- Press the **[MENU]** button.
- Turn the **[DISP]** dial to select [Protect].



## 2 Open the Protect Settings screen.

- Press the **[SET]** button.
  - ➔ The display goes to the Protect Settings screen.
- Press the **[MENU]** button to show the Protect Settings screen on an index display, then press the **[MENU]** button again to show the Protect Settings screen on a single image display.



The **[PROT]** icon

## 3 Protect the image.

- Turn the **[DISP]** dial to select the image you want to protect, then press the **[SET]** button.
  - ➔ Protected images are identified with a **[PROT]** icon.
- Press the **[SET]** button again to cancel protection and delete the **[PROT]** icon.
- If you have other images to be protected, repeat the above steps.
- Press the **[MENU]** button to exit Protect mode.



Formatting a CF card will erase all information on the card, including protected images. Be sure to carefully review the contents of a CF card before formatting.



Once an image is protected, it cannot be removed by the camera's Erase function. To erase a protected image, you must first remove the protection.



If you protect the images you need and erase all the images at once (→108), all non-protected images will be erased. This is handy when you want to erase all the images you do not need at once.

# Erasing Images (All Image Erase)

You can erase images one image at a time, or you can erase all images on the CF card at once. This section describes how to erase all the images recorded on a CF card in one operation. To erase images one at a time, see “Erasing a Recorded Image (Single Image Erase)”. (→47)

## 1 Set the camera to **PLAY**. (→102)

- Press the  button.
- ➔ The latest picture taken will be displayed.



## 2 Press the button.

- ➔ The Erase menu appears.

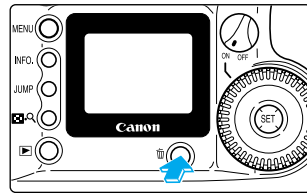

## 3 Turn the dial to select **[All...]**, then press the button.

- ➔ The Erase Confirmation message appears.



## 4 Turn the dial to select **[OK]**, then press the button.

- ➔ The camera erases all unprotected images.



- Once an image is protected, it cannot be removed by the camera's Erase function. To erase a protected image, you must first remove the protection.(→107).
- Once an image is erased, it cannot be recovered. Make sure you no longer need the image before erasing it.



If you protect the images you need (→107) and erase all the images at once, all non-protected images will be erased. This is handy when you want to erase all the images you do not need at once.

# MENU Formatting the CF Card

The CF card must be formatted before it is used in the EOS D30 camera. Also, if you see the message "Err CF" (CF card error) on the LCD panel when you load a CF card, the CF card may need to be formatted before it can be used.

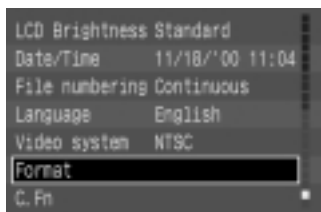

## 1 From the Menu, select [Format].

- Press the **<MENU>** button.
- Turn the **<Q>** dial to select [Format].



## 2 Press the **<SET>** button.

- ➔ A message will appear asking you to confirm that you want to format the CF card.

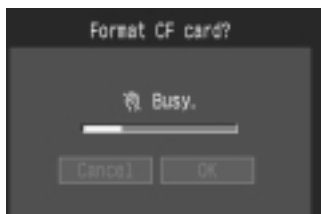

## 3 Turn the **<Q>** dial to select [OK], then press the **<SET>** button.

- ➔ The CF card will be formatted.



Formatting a CF card will erase all information on the card, including protected images. Be sure to carefully review the contents of a CF card before formatting.



- If a CF card from another manufacturer does not operate correctly, it may be usable after formatting.
- CF cards formatted on other cameras or computers or peripheral devices may not operate correctly with the EOS D30. In this case, format the card in your EOS D30 camera.

# MENU Print Order

You can mark the images on a CF card for printing, as well as specify the number of prints, print type, and the image data (date and file no.). The print specifications for the Canon EOS D30 camera conform to the Digital Print Order Format (DPOF) standard.

## DPOF

DPOF (Digital Print Order Format) is a standard used to record (on the CF card or other recording media) the image number, number of prints, etc. of images taken by digital cameras.

- You can simply insert the CF card into a DPOF-compatible digital printer to make prints as specified.
- You will not need to fill out the desired numbers and quantities of prints when ordering prints from a photo printing lab.

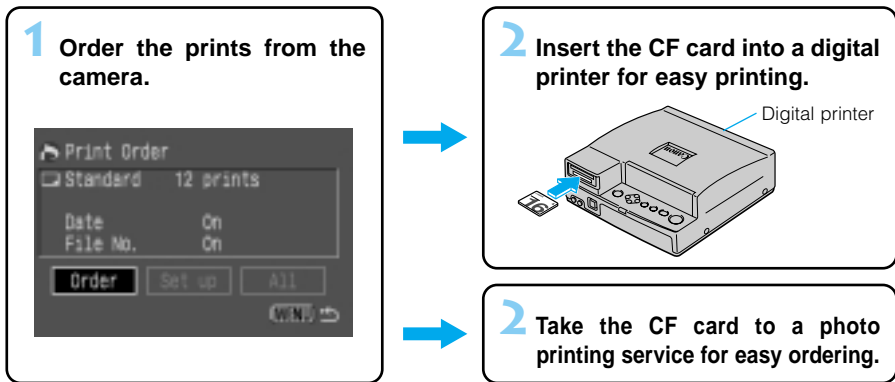

## Precautions for Printing from DPOF-compatible Devices

Please note the following when printing from a DPOF-compatible device.

- The EOS D30 cannot change print order information set by another DPOF-compatible device. Any such changes should be made by the device on which the print order was entered.
- If the CF card contains image data with print order information from another device, entering new print order information from the EOS D30 may erase the previous print order information.
- Some DPOF-compatible devices or photo printing services may not use all the recorded print order information. Check the user's guide for the device you are using, or with the photo printing service.

\* The print specifications while [  ] is appearing on the LCD panel will cancel all the former specifications.

# Selecting Images for Printing

There are two ways to select images for printing. You can select images one at a time, or select all images.

## Selecting a Single Image

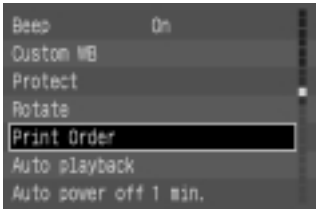

### 1 From the menu, select [Print Order].

- Press the **[MENU]** button.
- Turn the **[DIAL]** dial to select [Print Order].

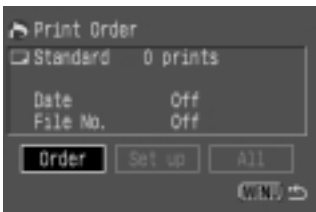

### 2 Press the **[SET]** button.

- ➔ The Print Order screen appears.
- ➔ [Order] is selected.



### 3 Press the **[SET]** button.

- ➔ The Select Image screen appears.
- If you press the **[Q]** button, 3 images are displayed on the "Select Image" screen. Press the **[Q]** button again to enlarge the "Select Image" screen.

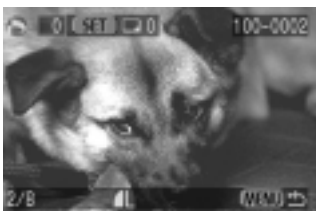

### 4 Select the images.

- Turn the **[DIAL]** dial to select an image, then press the **[SET]** button.
- ➔ If the Print Type (→113) selection is Standard or Both, the Print Quantity screen appears.
- ➔ If the Print Type (→113) selection is [Index], a check mark **[✓]** appears at the upper left.
- Images in RAW format cannot be marked for printing.
- If you selected [Index], you can press the **[SET]** button again to delete the **[✓]** mark and cancel the selection.

Number of prints of the selected image



## 5 Select the print quantity.

- If the Print Type (→113) is [Index], you do not need to specify the print quantity.
- Turn the  $\langle \text{DISP} \rangle$  dial to select the quantity, then press the  $\langle \text{SET} \rangle$  button.
- ➔ The quantity appears next to the  $\langle \text{DISP} \rangle$  icon.
- To cancel the selection, set the quantity to [0].
- To select another image, repeat steps 4 and 5.
- Press the  $\langle \text{MENU} \rangle$  button to return to the Select Image screen.

## Selecting All Images

You can select all images on a CF card at once, except those in RAW format.

## 1 Follow steps 1 and 2 of the Selecting a Single Image procedure (→111), to display the Print Order screen.

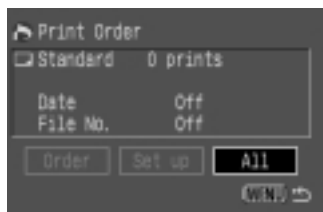

## 2 Turn the $\langle \text{DISP} \rangle$ dial to select [All], then press the $\langle \text{SET} \rangle$ button.

- ➔ The Select All Images menu appears.

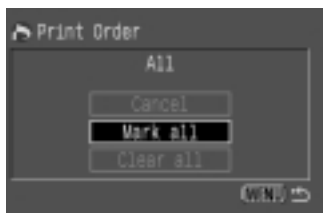

## 3 Select [Mark all].

- Turn the  $\langle \text{DISP} \rangle$  dial to select [Mark All], then press the  $\langle \text{SET} \rangle$  button.
- ➔ This orders all the images and the display then returns to the Print Order screen.
- At this point you can select [Clear all] to delete all images you have ordered.
- Select [Cancel] to return to the Print Order screen.



- Images are printed in order from oldest to newest.
- You can order up to 998 images.
- If you select images using the Mark All method, one copy of each will be printed. To specify quantities, use the Selecting a Single Image method. (→111)



# Print Type

You can specify the following print types.

**Standard:** Prints one image to each page.

**Index:** Prints an index of the images in reduced size, on one page.

**Both:** Prints the individual images and an index sheet.

- 1 Follow steps 1 and 2 of the **Selecting a Single Image** procedure (→111), to display the **Print Order** screen.

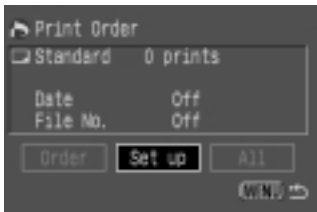

- 2 Turn the  $\langle \text{O} \rangle$  dial to select **[Set up]**, then press the  $\langle \text{SET} \rangle$  button.

→ The Print Order Setting screen appears.

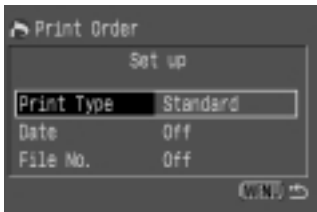

- 3 Turn the  $\langle \text{O} \rangle$  dial to select **[Print Type]**, then press the  $\langle \text{SET} \rangle$  button.

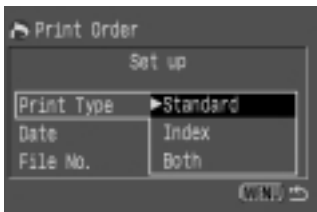

- 4 **Select the print type.**

- Turn the  $\langle \text{O} \rangle$  dial to select the print type, then press the  $\langle \text{SET} \rangle$  button.
- Press the  $\langle \text{MENU} \rangle$  button to return to the Print Order screen.

# Specifying Date Printing

You can specify printing of the date and time on each image.

- 1 Follow steps 1 and 2 of the **Selecting a Single Image** procedure (→111), to display the **Print Order** screen.

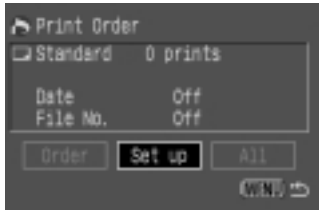

- 2 Turn the **<O>** dial to select **[Set up]**, then press the **<SET>** button.
  - The **Print Order Setting** screen appears.

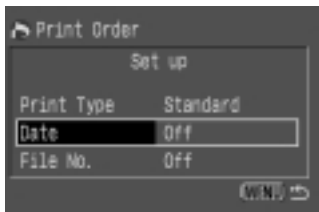

- 3 Turn the **<O>** dial to select **[Date]**, then press the **<SET>** button.

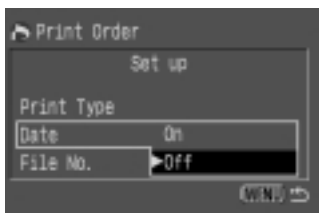

- 4 **Specify date printing.**
  - Turn the **<O>** dial to select **[On]** or **[Off]**, then press the **<SET>** button.
  - Press the **<MENU>** button to return to the **Print Order** screen.



- If the print type is **[Index]**, you cannot specify both date and file number. Specify one or the other.
- The date will be printed in the date style set from the menu in the **Date/Time** function. (→38)

# Specifying File Number Printing

You can specify printing of file number information on each image.

- 1 Follow steps 1 and 2 of the **Selecting a Single Image procedure** (→111), to display the **Print Order** screen.

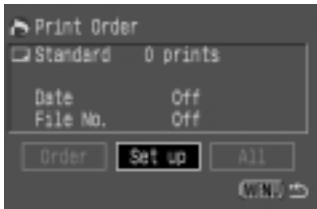

- 2 Turn the **<O>** dial to select **[Set up]**, then press the **<SET>** button.
  - The **Print Order Setting** screen appears.

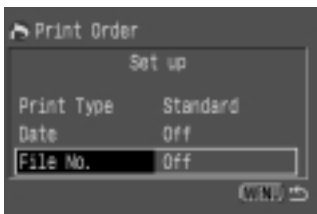

- 3 Turn the **<O>** dial to select **[File No.]**, then press the **<SET>** button.

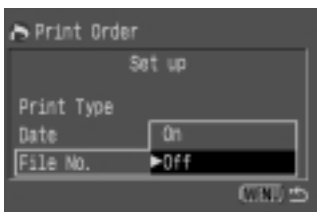

- 4 **Specify file number printing.**
  - Turn the **<O>** dial to select **[On]** or **[Off]**, then press the **<SET>** button.
  - Press the **<MENU>** button to return to the **Print Order** screen.



If the print type is [Index], you cannot specify both date and file number. Specify one or the other.

# Connecting to a TV

You can connect the EOS D30 to a television (using the video cable provided with your camera) to display your recorded images. Always turn off the camera and the television before connecting or disconnecting them.

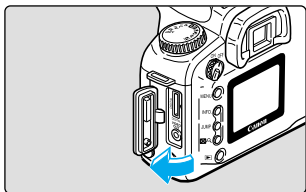

## 1 Open the cover.

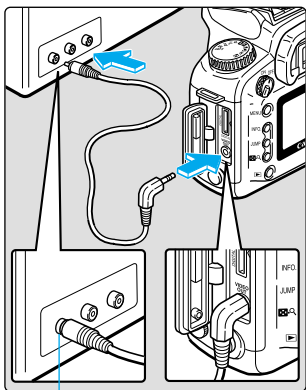

Video input terminal

## 2 Connect the cable.

- Connect the cable to the VIDEO OUT terminal on the camera and to the video input terminal on the TV.
- Insert the cable plug all the way, until it clicks into place.

## 3 Turn the TV on, and set the input switch to Video In.

## 4 Set the Main Switch to <ON>.

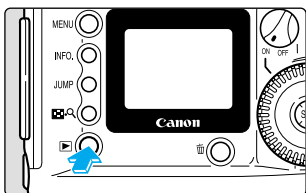

## 5 Press the <▶> button.

- ➔ The image appears on the TV screen.
- You can use the TV to view images or make menu settings just as you would with the LCD monitor.
- When you finish, set the Main Switch to <OFF>, turn the TV off, then disconnect the video cable.



- When using a TV screen display, we recommend that you connect the EOS D30 to a household power supply using the DC coupler. (→29)
- Images and menus do not appear on the LCD monitor while the video cable is connected to the camera.
- You can also switch the TV video signal to PAL (→123). The default setting is for the NTSC signal standard.

# **MENU** Cleaning the CMOS Imaging Element

The imaging element corresponds to the film in a film camera. If dirt or foreign matter gets on this imaging element, black spots may be recorded on the corresponding part of the image. If this happens, use the procedure below to clean the imaging element.

Because the imaging element is very sensitive, we strongly recommend that you have the cleaning done by Canon service representatives.

When cleaning the imaging element, always connect the EOS D30 camera to a household power outlet using the DC coupler. If you try to clean the imaging element while the battery pack is installed in the camera, the cleaning warning message “” will blink on the LCD panel and you will not be able to clean the imaging element.

Before you start cleaning, remove the lens (→30), attach the DC coupler (→29), and set the Main Switch to **⟨ON⟩**.

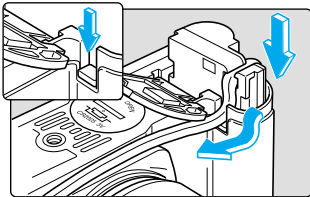

**1** Insert the DC coupler (→29) and set the Main Switch to **⟨ON⟩**. (→31)

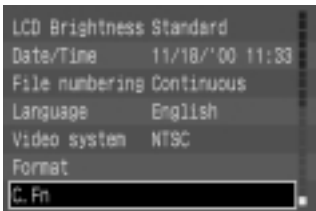

**2** From the menu, select **[C.Fn.]**.

- Press the **⟨MENU⟩** button.
- Turn the **⟨○⟩** dial to select [C.Fn].

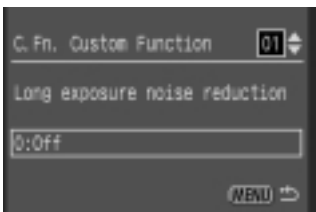

**3** Press the **⟨SET⟩** button.

→ The Custom Function Setting screen appears.

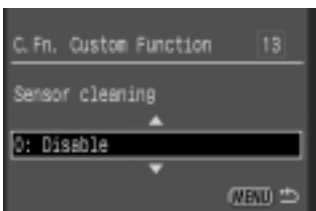

**4** Select **[C.Fn-13]**.

- Turn the **⟨○⟩** dial to select C.Fn-13 [Sensor cleaning], then press the **⟨SET⟩** button.

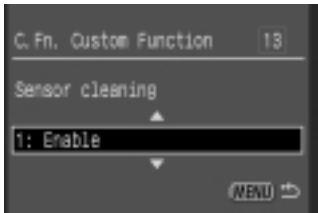

## 5 Select [1: Enable].

- Turn the dial to select [1: Enable], then press the button.
- ➔ The message " " appears on the LCD panel.
- If " " is blinking on the LCD panel, set the Main Switch to **<OFF>** and remove the battery pack. Then repeat the procedure from Step 1.

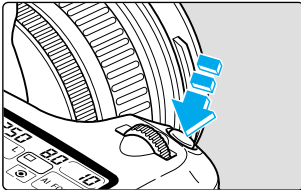

## 6 Press the shutter button down fully.

- The reflex mirror of the camera then flips up, and the shutter opens.

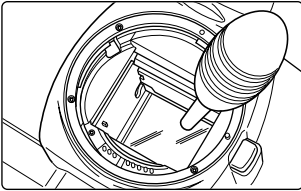

## 7 Clean the imaging element.

- Carefully blow any dust off the imaging element using a commercially available blower.

## 8 Finish cleaning.

- Set the Main Switch to **<OFF>**.
- ➔ The camera power turns off, the shutter closes and the mirror is lowered.
- Set the Main Switch to **<ON>** again, and the camera will be ready to shoot pictures normally.



- Never disconnect the camera power during cleaning. If the power is cut off, the shutter will close and possibly damage the shutter curtain.
- Use a blower without a brush attached. Using a brush to remove dust from the image element can damage the element.
- Do not insert a dust blower into the camera beyond the lens mount. If the power shuts off and the shutter closes, this may damage the shutter curtains.
- Never use cleaning sprays or blower sprays. The pressure and freezing action of the spray gas may damage the surface of the imaging element.

# Menu Function Settings

# 6

You can make a variety of settings from the EOS D30's menu. The menu includes special settings called Custom Functions that are related to camera operation. This booklet indicates these settings with the **C.Fn** mark, and provides basic descriptions.

This chapter lists the EOS D30's menu functions and describes the use of the Custom Function settings. For Menu operations and default settings, see "Menu Functions and Settings" (→36, 37).

# MENU List of Menu Functions

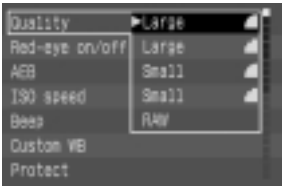
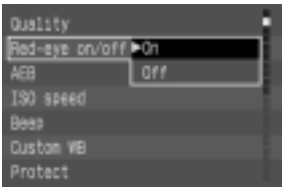
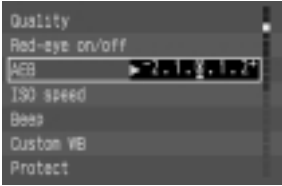
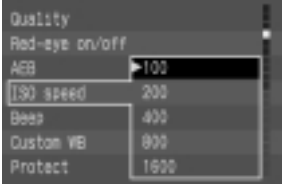
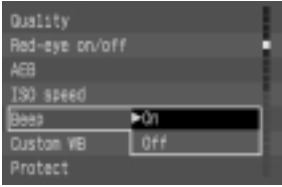
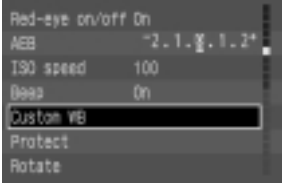
Item	Screen	Description	See page
Quality		Sets the size in pixels of the picture as recorded on the CF card, as well as the compression ratio. Select Large (L), Large (M), Small (S), Small (M), or RAW.	54
Red-eye reduction function		Turns on/off a function for reducing the "red-eye" look caused by using a flash to photograph people at night or in dark settings.	93
AEB to automatically change exposure level		Sets the increment steps for underexposure and overexposure in AEB shots.	82
ISO speed		Sets the ISO speed. Select ISO 100, 200, 400, 800, or 1600.	55
Beep		Turns on/off the electronic beep that sounds when the image is in focus. Can also be set to function as the beep that indicates the self timer is operating. Select On or Off.	43 85
Custom WB		Selects the image to use as the basis for custom white balance adjustments.	70



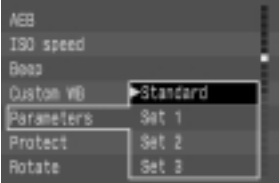
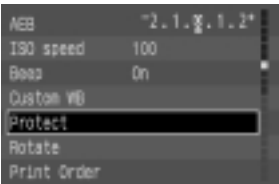
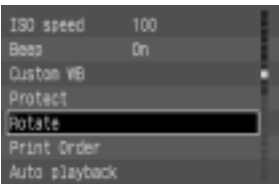
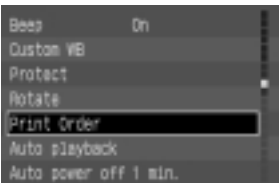
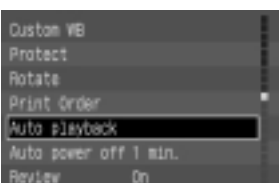
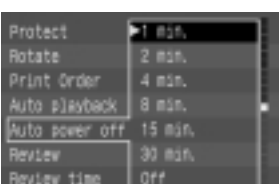

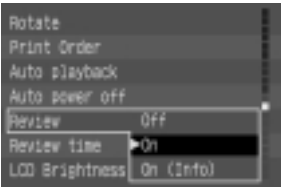
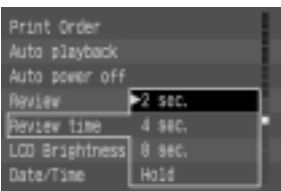
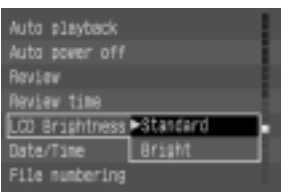
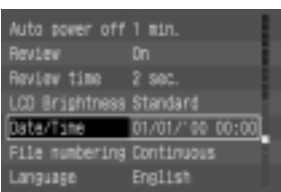
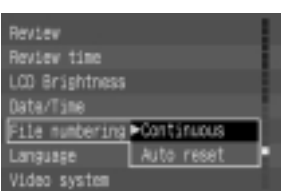
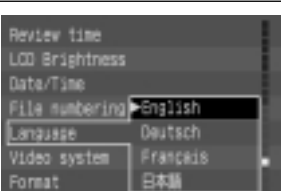

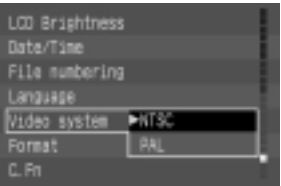
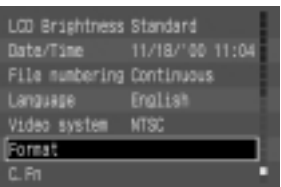
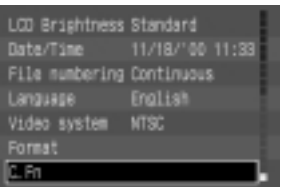
Item	Screen	Description	See page
Parameters		<p>Allows the user to set up to three sets of parameters with the included software for processing recorded images, in addition to the standard parameters automatically stored in the camera.</p>	56
Protect		<p>Allows the user to protect image files against accidental erasure.</p>	107
Rotate		<p>Rotates the image display 90° clockwise or counterclockwise.</p>	106
Print Order		<p>Lets you order prints of your photos for printing on DPOF-compatible devices.</p>	110
Auto playback		<p>Automatically plays images sequentially on the LCD monitor.</p>	105
Auto power off		<p>To conserve battery power, sets the Auto power off function that automatically switches off power if there is no operation for a given time. Select 1, 2, 4, 8, 15, or 30 minutes, or Off.</p>	33



Item	Screen	Description	See page
Review		<p>Determines whether images appear on the LCD monitor after they are taken. Select On, On (Info), or Off. The display time is set by the Review time setting (below).</p>	45
Review time		<p>When the Review function has been set to On or On (Info), this determines the time that images are displayed. Select 2, 4, or 8 seconds, or Hold.</p>	46
LCD brightness		<p>Sets the LCD brightness. Select normal or bright.</p>	-
Date/Time		<p>Sets the date and time, and the order of display for year, month, and day.</p>	38
File numbering		<p>Sets the pattern for automatically assigning file numbers to each image. Select continuous or auto reset.</p>	32
Language		<p>Sets the language used for the Menu screen. Select English, Deutsch, Français, or Japanese.</p>	-

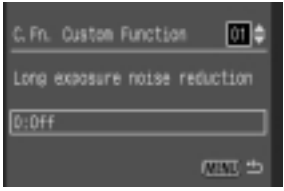

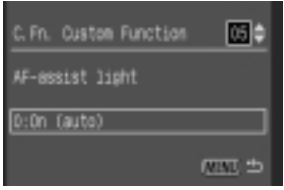

Item	Screen	Description	See page
Video system	 <p>The screenshot shows a camera menu with the following items: LCD Brightness, Date/Time, File numbering, Language, Video system (highlighted with a right arrow pointing to 'NTSC'), Format (with a right arrow pointing to 'PAL'), and C.Fn.</p>	Determines the video system format. Select NTSC or PAL.	116
Format CF card	 <p>The screenshot shows a camera menu with the following items: LCD Brightness Standard, Date/Time 11/18/'00 11:04, File numbering Continuous, Language English, Video system NTSC, Format (highlighted), and C.Fn.</p>	Formats the CF card in the camera.	109
Custom functions	 <p>The screenshot shows a camera menu with the following items: LCD Brightness Standard, Date/Time 11/18/'00 11:33, File numbering Continuous, Language English, Video system NTSC, Format (highlighted), and C.Fn.</p>	Sets custom functions that can adjust many of the camera functions to meet individual requirements.	124

# Custom Function Settings

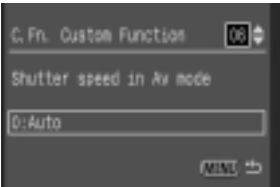

You can adjust many of the Canon EOS D30's functions to meet your particular requirements using the Custom Function settings. To change Custom Functions, select [C.Fn] from the menu.

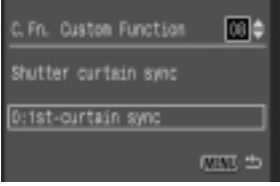
Func. No.	Item	Screen	Select no.	Setting or change
01	Long exposure noise reduction		0 1	Off On
02	Shutter button /AE lock button		0 1 2 3	Press the shutter button down halfway: AE, AF < * > button: AE lock < * > button: AE, AF Press the shutter button down halfway: AE lock Press the shutter button down halfway: AE, AF < * > button: AF lock (no AE lock) < * > button: AE, AF (no AE lock) Press the shutter button down halfway: AE
03	Mirror lockup		0 1	Disable (normal photography) Enable
04	Tv, Av, and exposure level		0 1	1/2-stop increments 1/3-stop increments
05	AF-assist light		0 1	On (auto) Off

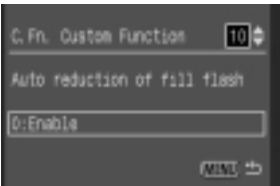
Effects, remarks	See Page
<p>Effective for reducing noise occurring in time exposure or bulb shots longer than one second.</p> <p>However, this requires processing time after the shot approximately equivalent to the exposure time. During processing, the message “ ” appears on the LCD panel and in the viewfinder, and no exposures can be made.</p>	87
<p>Effective for determining focus and exposure separately.</p> <p>In AI Servo AF mode, if an object passes between the camera and the subject, you can press the  button to pause AF operation and keep the camera from focusing on the obstruction. Exposure is determined when you take the picture. This is useful when photographing subjects that move and stop repeatedly. In AI Servo AF mode you can press the  button to start or stop AI Servo AF operation. Exposure is determined when you take the picture. The optimum focus and exposure are thus always ready for the decisive moment.</p>	84  60
<p>Effective for preventing the effects of camera vibration caused by mirror action in close-up and ultra-telephoto shots.</p>	88
<p>Effective in conditions that require more precise exposure settings. (The exposure indications may not change even if you change exposure settings. However, exposure control will be done according to your setting.)</p>	136
<p>Effective in conditions where the AF-assist light may not be desirable.</p>	43

Func. No.	Item	Screen	Select no.	Setting or change
06	Shutter speed in Av mode with flash		0 1	Automatic setting Fixed at 1/200 second (when using flash)
07	AEB sequence /auto cancellaton when Main Switch is Off		0 1 2 3	0 → - → +/Enabled 0 → - → +/Disabled - → 0 → +/Enabled - → 0 → +/Disabled
08	Shutter curtain sync		0 1	1st-curtain sync. Flash fires immediately after the shutter reaches full-open position.  2nd-curtain sync. Flash fires immediately before 2nd curtain closes.
09	Lens AF stop button Fn. Switch		0 1 2	Stop AF while button is pressed Operate AF while button is pressed Press button to start exposure timer and lock AE
10	Auto reduction of fill flash		0 1	Enable Disable

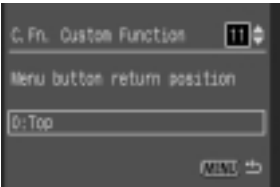
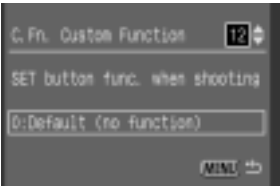
Effects, remarks	See Page
Effective for using flash at night or in dark locations.	77 97
<p>Effective when you continue to take AEB shots with the first frame set at the correct exposure.</p> <p>Lets you take AEB shots from the lowest exposure first.</p> <p>Effective when you continue to take AEB shots from the lowest exposure first.</p>	83  83 83
Effective at filling in shadows at slow shutter speeds.	92
<p>Camera AF does not operate while this button is pressed.</p> <p>Effective for determining focus and exposure separately.</p>	
<p>Produces natural daylight sync imaging.</p> <p>Prevents underexposure of people photographed against strong backlighting such as sunsets.</p>	95

Func. No.	Item	Screen	Select no.	Setting or change
11	Menu button return position		0 1 2	Always show first menu item. Show the most recently set menu item. (Set the Main Switch to Off to cancel, or On to show the first menu item.) Show the most recently set menu item. (Retain in memory when the main switch is Set to Off.)
12	SET button func. when shooting		0 1 2 3	Not assigned. Change quality. Change ISO speed. Select parameters.
13	Sensor cleaning		0 1	Disable Enable

\* Settings you set with C.Fn-11 will be effective even in the Easy shooting zone.



Effects, remarks	See Page
<p>Enables prompt menu selection for items that are frequently changed.</p> <p>Enables prompt menu selection for items that are frequently changed. Convenient when you want to retain function settings, regardless of whether the power is On or Off.</p>	
<p>Lets you change quality quickly when you are taking photographs.</p>	54
<p>Lets you change ISO speed quickly when you are taking photographs.</p>	55
<p>Lets you change parameters quickly when you are taking photographs.</p>	56
<p>Used when cleaning the imaging element. Effective when dust or small black spots appear on pictures.</p>	117

# REFERENCE

## Basic Terminology for Digital Cameras and Digital Photography

### AE

Auto Exposure is a function that calculates the exposure automatically. The camera has a built-in exposure meter that automatically determines the correct exposure (the combination of shutter speed and aperture value).

### AF

Auto Focus is a function that focuses the camera automatically.

### Aperture value

The lens aperture opens and closes to control the amount of light that reaches the imaging element. The aperture value (or f-number) is equal to the focal length divided by the aperture diameter. The aperture value is displayed on the camera's LCD panel and in the viewfinder, and ranges from 1.0 to 91, depending on the particular lens mounted on the camera.

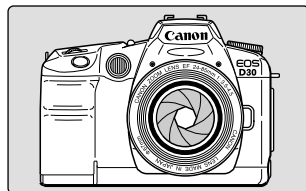

### CF (CompactFlash) Card

CompactFlash card is the storage media used to record photo images taken by the EOS D30.

### Depth of Field

When a subject is in focus, a distance in front of and behind the subject is also in focus. This is called the depth of field. The greater the aperture value (that is, the smaller the aperture), the broader the depth of the field. This is called a deeper depth of field. Conversely, the smaller the aperture value (larger aperture), the narrower the depth of field, called a shallower depth of field.

#### The depth of field is affected as described below:

- ① A smaller aperture (larger aperture value) increases the depth of field.  
Thus, reducing the aperture provides a deeper depth of field.
- ② At a given subject distance and aperture value, a lens with a shorter focal length increases the depth of field.  
Thus, a wide-angle lens gives a deeper depth of field than does a telephoto lens.
- ③ At a given aperture value, a greater distance between the camera and subject increases the depth of field.
- ④ When the optimum focus is on the subject, the depth of field behind the point of optimum focus is longer than the depth of field in front of the point of optimum focus. The depth of field is normally twice as deep behind the subject as before the subject (see illustration).

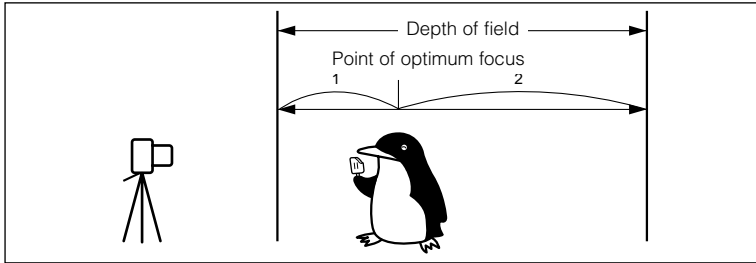

Aperture value set to f/22



Aperture value set to f/2

## DPOF

Digital Print Order Format is a standard format for ordering prints of digital camera images from photo lab printing services, as well as printing from household printers. The Canon EOS D30 is DPOF-compatible. You can specify printing from the camera itself and store the order information on the CF card. Photo printing services or household printers using the DPOF format can then produce prints easily using that information.

## Exposure

Exposure refers to the amount of light striking the imaging element to produce a photograph. The amount of light appropriate for the ISO speed is called the correct exposure. The correct exposure is adjusted by changing the combination of the shutter speed and aperture value.

## File Numbering and Folders

The pictures you take are automatically assigned file numbers from 0001-9900 and stored in folders of 100 images each. Each folder is numbered from 100 to 998 and recorded on the CF card.

Because pictures taken using continuous shooting must be stored in the same folder, there may in some cases be more than 101 images in a folder. Folders with 99 as their last two digits are not created.

Images stored in formats other than RAW format have the file name `Img_` and the extension `'jpg'`, and images stored in RAW format have the file name `CRW_` and the extension `'crw'`. Images with the extension `'thm'` are thumbnail images for index display.

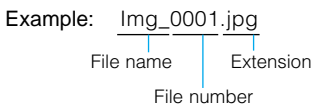
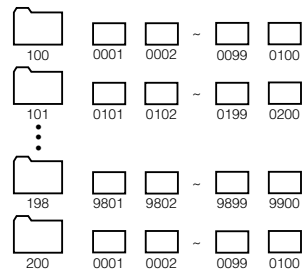

## Format

Formatting a CF card is the process of preparing the CF card to store image data. Be careful when formatting a CF card, because the formatting process erases all data stored on the card.

## ISO Speed

An index number representing the photosensitivity of silver-halide photo film. This sensitivity standard is determined by the International Standards Organization (ISO), and is normally written as "ISO 100", etc. The higher the ISO speed, the greater the sensitivity to light. Digital cameras use ISO speeds based on silver-halide photography.

## JPEG

Joint Photographic Experts Group is a file format for compressing and storing color images. The compression ratio can vary, but higher compression results in greater image degradation when the file is expanded (restored).

## Red-eye Phenomenon

In a relatively dark room, where subjects' pupils are dilated, the light from a camera flash passes through the pupil, is reflected by the retina, and causes the subjects' pupils to appear red. Red-eye is particularly prevalent when the flash is close to the optical axis of the lens. Use the following procedure to minimize red-eye:

- ① Shoot with the Red-eye reduction function turned on. (The red-eye reduction lamp lights before the picture is taken, causing the pupils to contract and thus minimizing red-eye.)
- ② Shoot with an EX-series Speedlite. (The light reflected from the flash will not be directed along the optical axis of the lens, thus minimizing red-eye.)
- ③ Shoot from as close as possible (same effect as ②).

## Shutter Speed

The camera's shutter opens for a variable length of time to control the amount of light that reaches the imaging element. This length of time is called the shutter speed.

# Function Availability Table

● : Automatic setting  
○ : Selection possible

Mode Dial	AF			Focusing point selection		Drive		Metering mode		
	ONE SHOT	AI SERVO	AI FOCUS	Auto	Manual	Single	Continuous	Evaluative	Partial	Center-weighted averaging
			●	●		●		●		
	●			●			●	●		
	●			●		●		●		
	●			●		●		●		
		●		●			●	●		
	●			●		●		●		
P	○	○		○	○	○	○	○	○	○
Tv	○	○		○	○	○	○	○	○	○
Av	○	○		○	○	○	○	○	○	○
M	○	○		○	○	○	○	○	○	○
A-DEP	●			●		○	○	○	○	○

Mode Dial	Built-in flash			White balance		Image size		Compression		
	Auto	Manual	Red-eye reduction	Auto	Manual	Large	Small	RAW		
	●		○	●		●			●	
	●		○	●		●			●	
				●		●			●	
	●		○	●		●			●	
				●		●			●	
	●		○	●		●			●	
P		○	○	○	○	○	○	○	○	○
Tv		○	○	○	○	○	○	○	○	○
Av		○	○	○	○	○	○	○	○	○
M		○	○	○	○	○	○	○	○	○
A-DEP		○	○	○	○	○	○	○	○	○

## AF Modes and Drive Modes

Drive mode	ONE SHOT AF	AI Servo AF	AI Focus AF
Single	Shutter cannot be released until focus is achieved. When focus is achieved, AF is locked. In evaluative metering mode, the exposure (set just before the picture is taken) is also locked.	Autofocus tracks the moving subject, and the exposure is set when the picture is taken.	Automatically switches between ONE SHOT AF and AI Servo AF according to the subject.
Continuous	The above conditions apply during continuous shooting. (in Large  format, approximately 3 images per second to a maximum of 8 images.)	The above conditions apply during continuous shooting. (in Large  format, approximately 2.5 images per second, up to a maximum of 8 images.)	

# Exposure Warnings

Mode	Blinking warning	Description	Remarks
P		Subject is too dark.	Use flash.
		Subject is too bright.	Use a neutral density filter.
Tv	500	Picture will be underexposed.	Turn the  dial to a slower shutter speed.
	60	Picture will be overexposed.	Turn the  dial to a faster shutter speed.
Av		Picture will be underexposed.	Turn the  dial to a smaller aperture value.
		Picture will be overexposed.	Turn the  dial to a larger aperture value.
A-DEP	60	The desired depth of field cannot be obtained.	1) Move farther from the subject and try again. 2) If using a zoom lens, use the shortest focal length.
		Subject is too dark.	Use a flash (the result will be the same as using Program AE ).
		Subject is too bright.	Use a neutral density filter.



The warnings shown are examples using a lens with a minimum aperture value of f/3.5, and a maximum aperture value of f/22. Actual maximum and minimum aperture values will depend on the particular lens you use.

# AE Lock Effects for Combinations of Focusing Point Selection and Metering Method

(when using a mode in the Creative zone)

Focusing point selection Metering method	Auto selection AF	Manual selection AF
Evaluative metering	AE lock applied to the metered value at the active focusing point.	AE lock applied to the metered value at the selected focusing point.
Partial metering	AE lock applied to the metered value at the center focusing point.	
Center-weighted averaging		

# Program Line

⟨P⟩ The following program line applies when the camera is in Program AE (⟨P⟩) mode.

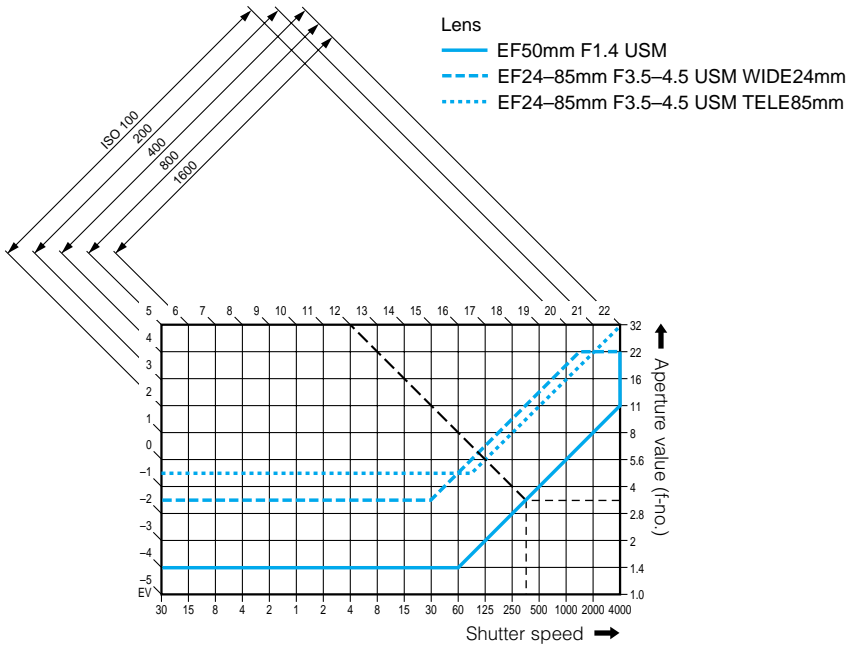

## Program Line Description

The lower horizontal axis represents the shutter speed, and the right-hand vertical axis represents the aperture value. The combinations of shutter speed and aperture value automatically determined by Program AE are shown as colored lines with respect to the subject brightness (Exposure Value) gradations on the left and top edges of the graph.

**Example:** Using an EF50 F1.4 USM lens with a subject brightness of EV12, the point where the diagonal line from EV12 (on the top edge) intersects the Program AE line represents the corresponding shutter speed (1/350 second) and aperture value (f/3.5) that the program sets automatically.

The diagonal arrowed lines at the upper left indicate the metering range for the indicated ISO speed.

# Shutter Speed and Aperture Value Readouts

## Shutter speed readout

The shutter speed is normally displayed in 1/2-stop increments. Numbers from 4000 to 4 denote the denominator of the shutter speed fraction: for example, 125 is 1/125 seconds. In addition, 0.3 is 0.3 seconds, and 15" is 15 seconds.

## Aperture value readout

The aperture value is normally displayed in 1/2-stop increments. The larger the number, the smaller the aperture opening. The range of aperture values (f-numbers) displayed depends on the lens used.

1/2-stop increments				1/3-stop increments			
Shutter speed		Aperture value		Shutter speed		Aperture value	
4000	2"	10	9.1	4000	10	10	20
3000	3"	12		3200	8	11	22
2000	4"	14		2500	6	12	25
1500	5"	16		2000	5	14	29
1000	8"	20		1600	4	16	32
750	10"	25		1250	0.3	18	36
500	15"	28		1000	0.4	20	40
350	20"	35		800	0.5	22	45
250	30"	40		640	0.6	25	51
180		45		500	0.8	28	57
125		5.6		400	1"	32	64
90		6.7		320	1.3	35	72
60		8.0		250	1.6	40	81
45		9.5		200	2"	45	91
30		11		160	2.5	5.0	
20		13		125	3.2	5.6	
15		16		100	4"	6.3	
10		19		80	5"	7.1	
8		22		60	6"	8.0	
6		27		50	8"	9.0	
4		32		40	10"	10	
0.3		38		30	13"	11	
0.5		45		25	15"	13	
0.7		54		20	20"	14	
1"		64		15	25"	16	
1.5		76		13	30"	18	

**C.Fn** The shutter speed and aperture value can be set in 1/3-stop increments. (C.Fn-4→124)



# Error Codes

When a camera error occurs, an error code (Err xx) appears on the LCD panel. When this happens, set the Main Switch to **(OFF)** and then set it to **(ON)** again.

If an error code is displayed frequently, this indicates that a malfunction has occurred. Make a note of the error code and contact your nearest Canon Service Center (see back cover).

If an error code is displayed after you take a picture, the picture may not have been recorded. Press the play button and review the image.

## Message List

The following messages are displayed on the LCD monitor.

<b>Busy.</b>	A picture is being stored on the CF card, or the camera is loading a recorded image.
<b>No CF card</b>	Attempted to take a picture or play an image with no CF card in the camera.
<b>CF card error.</b>	There is a problem with the CF card.
<b>CF card full.</b>	No more print orders can be stored.
<b>Naming error!</b>	A file already exists with the file name that the camera is attempting to create. Or the file numbers have already reached the maximum value and no new file numbers can be created. Transfer the necessary number of images to a computer, then use the computer to format the CF card. Note that formatting will erase all images and information on the CF card.
<b>No Image.</b>	No images are recorded on the CF card.
<b>Image too large.</b>	Attempted to play an image having a size larger than 3200 × 2400 pixels.
<b>Incompatible JPEG format.</b>	Attempted to play an image having a JPEG format that is not compatible with the camera.
<b>Corrupted data.</b>	Attempted to play an image containing corrupted data.
<b>Cannot rotate</b>	Attempted to rotate an image recorded by another camera or in another format, or processed by a computer.
<b>Unidentified Image</b>	Attempted to play an image taken in a special format (such as a format unique to a camera from another manufacturer).
<b>Protected!</b>	Attempted to erase a protected image.
<b>Too many marks.</b>	Attempted to enter a print order quantity that is too high. Enter a lower quantity.
<b>Cannot complete!</b>	Print order or slide show setting could not be stored.
<b>CCDRAW</b>	You attempted to replay a CCDRAW image.



# Troubleshooting

If you have a problem with your camera, first refer to this Troubleshooting Guide as you check the camera.

## Power

<p>Unable to charge battery pack.</p>	<p><b>An incorrect battery pack is being used.</b></p> <ul style="list-style-type: none"> <li>➔ Use a Canon BP-511 battery pack. (→4)</li> </ul> <p><b>Battery pack is not correctly attached to the compact power adapter.</b></p> <ul style="list-style-type: none"> <li>➔ Attach the battery pack correctly. (→25)</li> </ul> <p><b>The DC coupler is connected to the compact power adapter.</b></p> <ul style="list-style-type: none"> <li>➔ Remove the DC coupler plug from the compact power adapter. (→26)</li> </ul>
<p>Main switch does not turn the camera <b>&lt;ON&gt;</b>.</p>	<p><b>The battery pack is out of power.</b></p> <ul style="list-style-type: none"> <li>➔ Charge the battery pack. (→25)</li> </ul> <p><b>Battery pack is not inserted correctly.</b></p> <ul style="list-style-type: none"> <li>➔ Insert the battery pack correctly. (→27)</li> </ul> <p><b>Battery chamber cover is not closed.</b></p> <ul style="list-style-type: none"> <li>➔ Close the battery chamber cover tightly. (→27)</li> </ul> <p><b>CF card slot cover is not closed.</b></p> <ul style="list-style-type: none"> <li>➔ Insert the CF card firmly until the CF card eject button pops out, then close the CF card slot cover tightly. (→31)</li> </ul>
<p>Access lamp blinks even when the Main Switch is <b>&lt;OFF&gt;</b>.</p>	<p><b>If the Main Switch is set to <b>&lt;OFF&gt;</b> immediately after taking a picture, the access lamp continues flashing for a few seconds until the image is stored on the CF card.</b></p> <ul style="list-style-type: none"> <li>➔ After the image has been stored on the CF card the access lamp will go out and the camera will turn off automatically.</li> </ul>
<p>Battery loses power quickly</p>	<p><b>Battery pack is not sufficiently charged.</b></p> <ul style="list-style-type: none"> <li>➔ Charge the battery pack fully. (→25)</li> </ul> <p><b>Battery pack is beyond its useful life.</b></p> <ul style="list-style-type: none"> <li>➔ Obtain a new battery pack. (→140)</li> </ul>
<p>Camera switches off by itself</p>	<p><b>Auto power off function is operating.</b></p> <ul style="list-style-type: none"> <li>➔ Switch the camera on again with the main switch, or turn off the Auto power off function. (→121)</li> </ul>
<p>Only the <b>&lt;BATT&gt;</b> icon blinks on the LCD panel</p>	<p><b>Battery pack level is very low.</b></p> <ul style="list-style-type: none"> <li>➔ Charge the battery pack. (→25)</li> </ul> <p><b>Camera is not operating properly.</b></p> <ul style="list-style-type: none"> <li>➔ Press the shutter button down halfway to reset the camera to normal. (→33)</li> </ul> <p>* If the <b>&lt;BATT&gt;</b> icon still appears, the camera needs repair. Take it to a Canon Service Center. (→back cover)</p>

## Shooting

Unable to shoot or record images	<p><b>CF card is not loaded correctly.</b></p> <ul style="list-style-type: none"> <li>➔ Load the CF card correctly. (→31)</li> </ul> <p><b>CF card is full.</b></p> <ul style="list-style-type: none"> <li>➔ Change to a new CF card, or erase unwanted images. (→31, 47, 108)</li> </ul> <p><b>The battery pack is out of power.</b></p> <ul style="list-style-type: none"> <li>➔ Charge the battery pack. (→25)</li> </ul> <p><b>Image out of focus (In-focus light in the viewfinder blinks).</b></p> <ul style="list-style-type: none"> <li>➔ Press the shutter button down halfway to focus again. If this fails, focus manually. (→33, 63)</li> </ul>
LCD monitor displays and images are hard to see	<p><b>Dust or foreign matter on the monitor.</b></p> <ul style="list-style-type: none"> <li>➔ Clean the monitor with a soft eyeglass cloth.</li> </ul> <p><b>LCD monitor is worn out.</b></p> <ul style="list-style-type: none"> <li>➔ Consult the store where you bought your camera, or a Canon Service Center. (→12, back cover)</li> </ul>
Images are blurred	<p><b>Lens focusing mode switch set to &lt;MF&gt; (or &lt;M&gt;).</b></p> <ul style="list-style-type: none"> <li>➔ Set the focusing mode switch to &lt;AF&gt;. (→30)</li> </ul> <p><b>Hand movement when the shutter button is pressed.</b></p> <ul style="list-style-type: none"> <li>➔ Press the shutter button carefully so that the camera does not move. (→33, 40)</li> </ul>
Unable to use the CF card	<p><b>CF card data is corrupted.</b></p> <ul style="list-style-type: none"> <li>➔ Format the CF card. (→109)</li> <li>➔ Use the specified type of CF card. (→3, 141)</li> </ul>
The message “   ” appears on the LCD panel	<p><b>The backup battery is out of power.</b></p> <ul style="list-style-type: none"> <li>➔ Replace the backup battery. (→24)</li> </ul>

## Checking and Handling Images

Cannot erase images	<p><b>Images may be protected.</b></p> <ul style="list-style-type: none"> <li>➔ Remove image protection. (→107)</li> </ul>
Incorrect date and time displayed	<p><b>Date/Time setting may be incorrect.</b></p> <ul style="list-style-type: none"> <li>➔ Set date/time correctly. (→38)</li> </ul>
No image appears on the TV screen	<p><b>Video cable plugs are not inserted fully.</b></p> <ul style="list-style-type: none"> <li>➔ Insert the video cable plugs firmly all the way. (→116)</li> </ul>

## Major Accessories (Sold Separately)



### Battery Pack BP-511

This is a powerful lithium ion secondary battery pack. The rated voltage is 7.4V. You can use the Compact Power Adapter CA-PS400 to charge the BP-511 battery pack, and when fully charged it has enough power for you to take approximately 540 pictures (Normal, with 50% flash use). Charging takes about 90 minutes.



### Battery Grip BG-ED3

This is a battery grip that holds two BP-511 battery packs. It provides a shutter button, electronic dials, AE lock/FE lock button, and focusing point selection button for use in taking portrait (vertical) shots. (Can also use the DC coupler)



### E-series Dioptic Adjustment Lenses

One of ten E-series dioptic adjustment lenses (-4 to +3 diopters) with eyecup can be attached to the camera's eyepiece to further expand the dioptic correction range.



### EOS-Dedicated EX-Series Speedlites 550EX, 420EX, 220EX

Three EOS-dedicated E-TTL autoflash Speedlites are available: the high-output zoom flash 550EX, the affordable 420EX, and the compact 220EX.

The respective guide numbers of these (ISO 100 in meters) are 55, 42, and 22. All three Speedlites enable E-TTL autoflash, high-speed sync (FP flash), and FE lock. In addition, the 550EX can operate in an easy-to-use wireless, multi-Speedlite system.



### Macro Ring Lite MR-14EX

This is an EOS-dedicated macro ring flash featuring twin flash tubes, guide no. 14 (ISO 100 in meters), and E-TTL autoflash. You can fire one or both flash tubes and control the flash ratio to easily obtain sophisticated lighting effects with E-TTL autoflash. Features include high-speed sync (FP flash) and FE lock. The MR-14EX can operate in a wireless, multi-Speedlite system with a 550EX Speedlite as a slave to provide a variety of macro flash effects.



### Timer Remote Controller TC-80N3

The remote controller attaches with an 80-cm cord and includes built-in (1) self timer, (2) interval timer, (3) long-exposure timer, and (4) shutter release count-setting function. You can set the time from 1 second to 99 hours, 59 minutes, 59 seconds, in 1-second increments. Includes a one-touch locking plug for connecting to the EOS D30.



### Remote Switch RS-80N3

This is a remote switch with an 80-cm cord to prevent camera shake for super-telephoto shots, macrophotography, and bulb exposures. You can use the remote switch to press the shutter button down halfway or completely. Also includes shutter release lock and a one-touch locking plug for connecting to the EOS D30's remote control terminal.



### CF Card

Memory media for storing photo images.



### PC Card Adapter

This adapter allows you to use a CF card in a computer's PC card slot.

# System Map

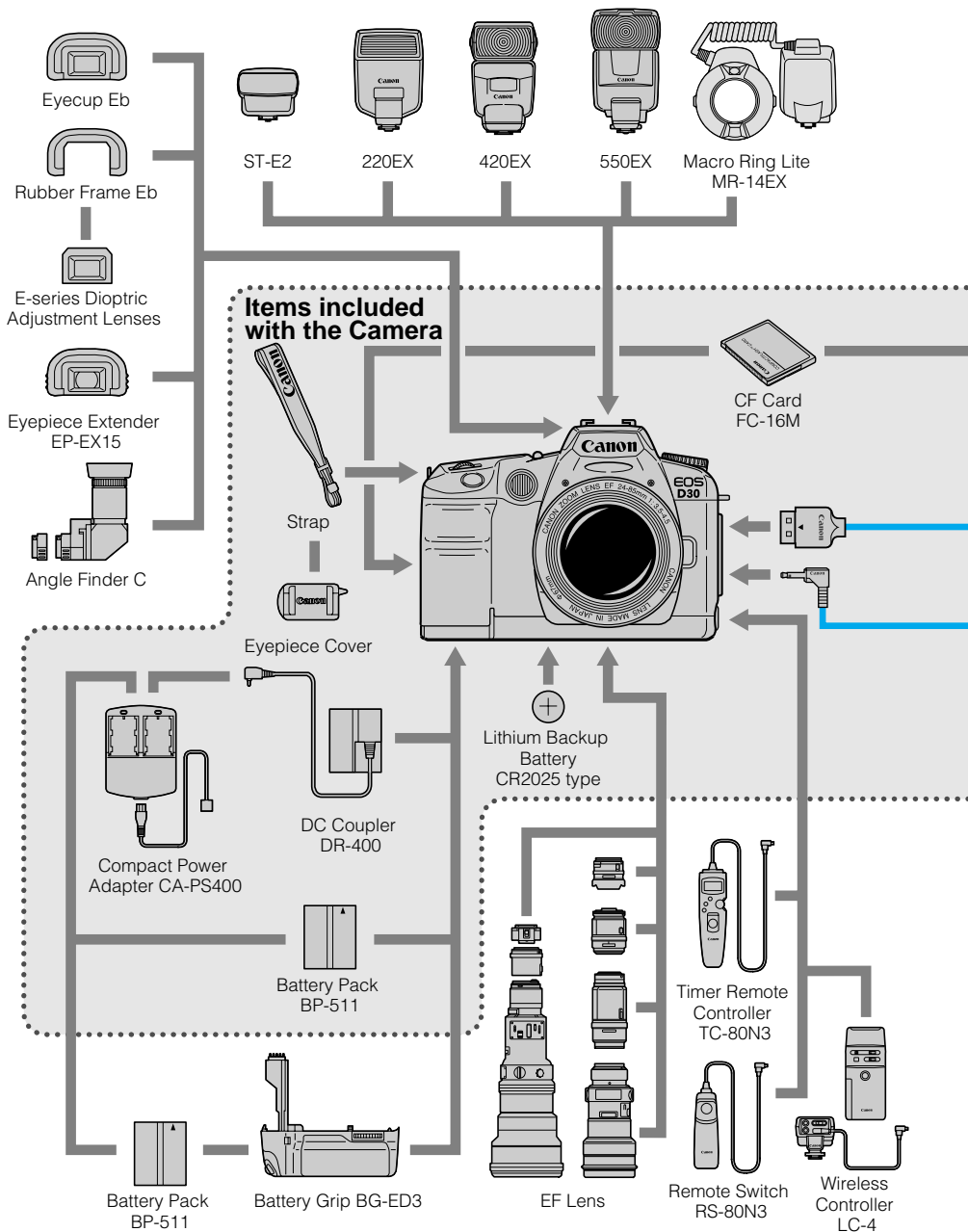

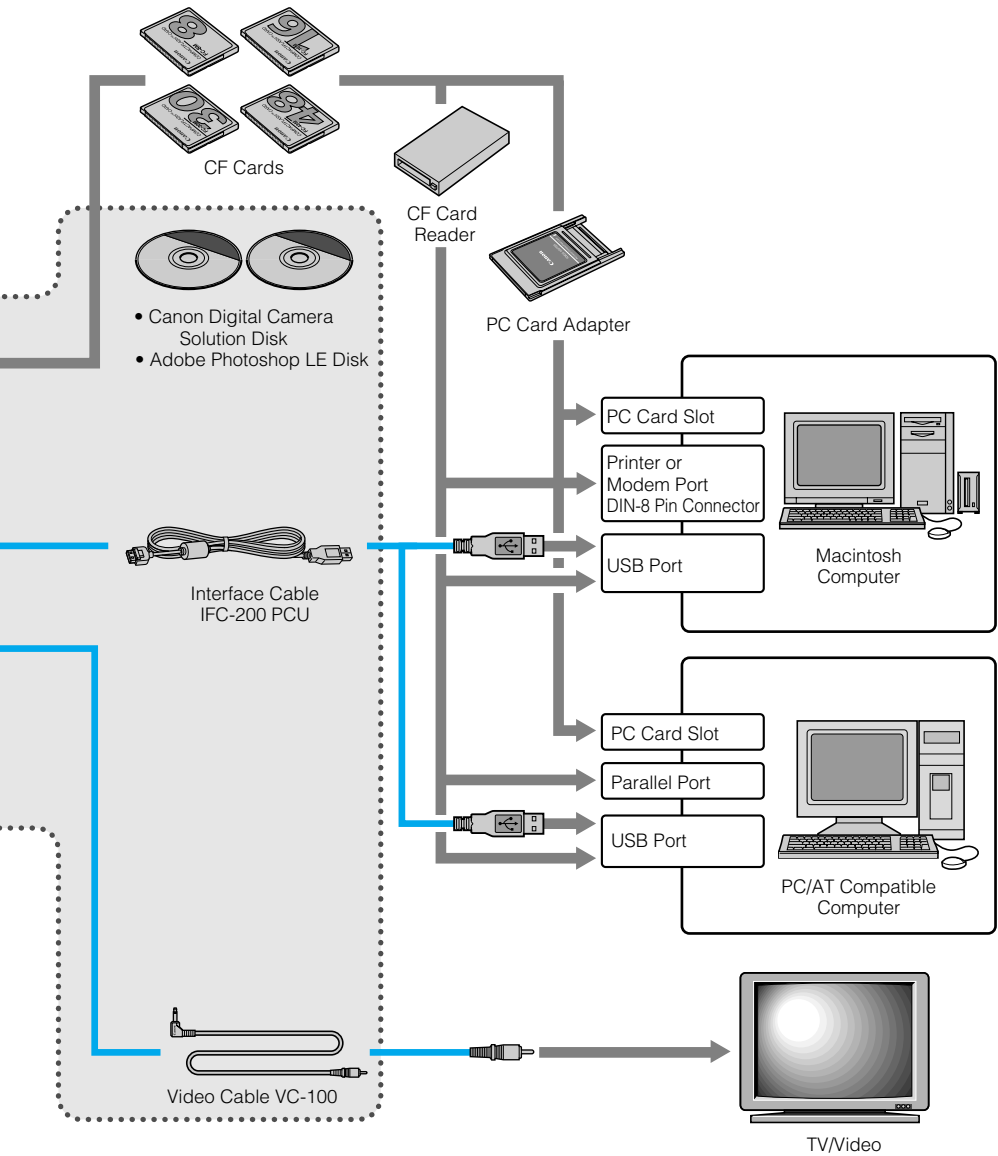

# Major Specifications

## Type

Type .....	Single-lens reflex AE-AF digital camera with built-in flash and focal plane shutter (vertical travel), 36-bit full color (RGB each 12-bit), single-shot CMOS direct imaging sensor
Picture size.....	22.7 × 15.1 mm (0.89 × 0.59 in)
Compatible lenses .....	Canon EF lens group
Lens mount .....	Canon EF mount
Lens focal length .....	Approx. 1.6× indicated lens focal length

## Imaging element

Type .....	High-sensitivity, high-resolution, large single-plate CMOS sensor.
Effective sensor size.....	22.7 × 15.1 mm (0.89 × 0.59 in) (Advanced Photo System C print type equivalent)
Pixel count .....	Total: approx. 3.25 million pixels (2226 × 1460) Effective: approx. 3.11 million pixels (2160 × 1440)
Aspect ratio.....	2 : 3
Color filter method .....	Primary color filter
Low-pass filter.....	Positioned on front surface of imaging element, non-removable

## LCD Monitor

Type .....	TFT-type color LCD monitor
Picture size.....	1.8-inch
Pixel count .....	Approx. 114,000 pixels
Brightness adjustment .....	2 levels: Standard or Bright (select by menu function)

## Recording Method

Recording media .....	CF card (Type I or II)
Recording format type.....	Design rule for Camera File System
Recording formats .....	JPEG, RAW
Recording capacity.....	① Large/Fine:10, ② Large/Normal:21, ③ Small/Fine:22, ④ Small/Normal:40, RAW:3 (with 16-Mbyte CF card)
Parameters.....	Standard parameters plus three types of custom parameters selected by the user.

## Auto Focus

AF Type .....	multi-BASIS TTL-CT-SIR type (TTL secondary image registration)
Focusing points .....	3-point (I + I)
AF working range.....	EV2 to EV18 (ISO 100)
Focusing point selection.....	① Automatic selection by camera, ② Manual 1-point selection



- Focusing modes .....① One-shot AF: AF locks when focus is achieved. Shutter can be released only when focus is achieved.  
 ② AI servo AF: Tracks subject movement until the actual start of metering; includes predictive function; shutter can be released anytime regardless of focus (predictive drive has priority in continuous shooting), indicator blinks at 8 Hz if focus fails.  
 ③ AI focus AF: Automatically switches between One-shot AF mode and AI Servo AF.  
 ④ Manual focus: When focusing mode switch on lens is set to MF (or M), manual focusing ring can be used.
- AF-assist light .....Lamp illumination type. Built-in AF-assist light emitted automatically according to conditions.  
 Effective distance: approx. 3.8 m (12.5 ft.) from center of viewfinder

### White Balance

- Type .....Automatic white balance using imaging element  
 Setting method.....① Automatic setting, ② Manual setting  
 Manual white balance.....Available (set from Menu function)

### Viewfinder

- Type .....Eye-level type with pentaprism  
 Standard diopter.....-1 dpt (eye relief 20 mm)  
 Diopter adjustment range...-3 to +1 dpt  
 Picture coverage.....95% vertically and horizontally  
 Magnification.....0.88x (at -1 dpt, 50mm lens, at infinity)  
 Viewfinder information .....Shutter speed, aperture value, FEL indicator, AE/FE lock, focusing point indicator, exposure level, AE exposure compensation amount, manual exposure level, AEB level, elapsed time of red-eye reduction lamp operation, flash ready, high-speed sync, AF/MF in-focus indicator  
 Mirror.....Quick-return half mirror (mirror blackout: none up to EF 600mm F4L IS USM lens)  
 Depth of field preview.....Press depth-of-field preview button

### Exposure Control

- Method.....35-zone SPC and TTL open metering  
 ① Evaluative metering,  
 ② Center partial metering (approx. 9.5% of viewfinder area),  
 ③ Center-weighted average value metering,  
 Exposure modes .....① Program AE (shiftable), ② Shutter speed-priority AE,  
 ③ Aperture-priority AE, ④ Auto depth-of-field priority AE,  
 ⑤ Full Auto mode, ⑥ Program AE Image Control modes (five types: Portrait/Landscape/Close-up/Sports/Night scene), ⑦ Manual,  
 ⑧ E-TTL autofocus program flash AE (High-speed sync, FE lock)  
 Metering range .....EV2 to EV20 (at room temperature with 50mm F1.4 lens at ISO 100)  
 ISO speed range .....Equivalent to 100, 200, 400, 800, 1600



**Camera Body**

Flash contacts.....	① Accessory shoe: X-sync contacts ② Sync terminal (with locking thread) on lower corner of camera body
External flash system compatibility.....	Compatible with E-TTL auto sync
Red-eye reduction function.....	Built-in flash illumination type
Interfaces .....	USB/CF card slot (Type I , II)/Video output (NTSC/PAL)
Remote jack.....	N3 type
Dimensions (W × H × D).....	149.5 × 106.5 × 75 mm (5.89 × 4.19 × 3.0 in)
Weight.....	780 g (1.72 lb) (excluding battery pack, CF card, backup battery)
Operating temperature range.....	0°C to +40°C (32°F to 104°F)
Operating humidity range.....	85% or lower

**CA-PS400 Compact Power Adapter**

Compatible battery .....	Battery pack BP-511
Compatible DC coupler .....	DR-400
Battery mounts.....	2 (Battery packs cannot be charged when the DC coupler is connected)
Power cord length.....	Approx. 1.8 m (5.9 ft)
Charging time .....	Approx. 90 minutes per battery pack
Rated input/frequency .....	100-240 V AC, 50/60 Hz
Rated output .....	Charging: 8.4 V DC When the coupler is connected: 8.1 V DC
Operating temperature .....	0°C to +40°C (32°F to 104°F)
Operating humidity range.....	Less than 85%
Dimensions (W × H × D).....	100 × 51 × 133 mm (3.94 × 2.0 × 5.24 in)
Weight.....	285 g (10.1 oz) (when the cord is not connected)

**DR-400 DC Coupler**

Compatible adapter.....	Compact power adapter CA-PS400
Compatible camera .....	EOS D30
Rated input voltage.....	6.3 to 10.5 V DC
Rated output voltage .....	6.3 to 10.5 V DC
Cord length .....	Approx. 1.8 m (5.9 ft)
Operating temperature .....	0°C to +40°C (32°F to 104°F)
Operating humidity range.....	Less than 85%
Dimensions (W × H × D).....	38.4 × 21 × 55.3 mm (1.51 × 0.83 × 2.18 in)
Weight.....	110 g (3.9 oz)

- All data is based on Canon standard testing conditions.
- All product specifications and external appearance are subject to change without notice.

# Index

4-second timer function .....	22
6-second timer function .....	22
16-second timer function .....	22

## A

Accessories .....	4, 140
AE .....	130
AEB (Autoexposure bracketing) .....	82
Canceling AEB .....	82
AE lock .....	84
AF .....	30, 130
Problem subjects .....	63
AF Assist-light .....	43
AF Mode .....	58
AI Focus AF .....	60
AI Servo AF for moving subjects .....	60
Aperture-Priority AE .....	76
Aperture value .....	131
Aperture value readout .....	137
Automatic Depth-of-Field AE .....	80
Auto power off function .....	33, 121
Auto reset .....	32

## B

Backup battery replacement .....	24
Basic terminology .....	130
Battery Grip .....	140
Battery pack .....	4, 25, 140
Battery charge .....	25
Charge checking .....	27
Charging .....	25
Charging time .....	25
Inserting .....	27
Beep .....	120
Built-in flash use .....	90
Creative zone shooting .....	90
Easy zone shooting .....	90
Flash Exposure compensation .....	95, 99
Flash range .....	91
Flash sync shutter speed, aperture value .....	91
Red-eye reduction .....	93
Bulb exposures .....	87

## C

Canon Service Centers .....	Back cover
CF (CompactFlash) card .....	3, 4, 13, 31, 130, 141
Formatting .....	109, 131
Inserting .....	31
Removing .....	31
Charge lamp .....	21, 25
Close-up mode .....	50
CMOS .....	3, 117
Color temperature .....	69
Compact power adapter .....	4, 21, 25
Compression ratio .....	54
Continuous numbering .....	32
Copyright .....	3
Creative zone .....	20, 90
Custom functions .....	123, 124
Custom White Balance .....	70

## D

Date printing specification .....	114
DC coupler .....	4, 21, 29
Depth of field .....	77, 132
Dioptic adjustment .....	40
Dioptic Correction Lens .....	140
DPOF (Digital Print Order Format) .....	101, 110, 130
Drive Mode .....	67

## E

Easy shooting zone .....	20, 31, 90
EOS D30 Camera User's Guide .....	2, 5
EOS-dedicated 550EX Speedlite flash photography .....	96
EOS-dedicated EX-Series Speedlites .....	96, 140
Erasing .....	47, 108
Exposure .....	133
Exposure compensation setting .....	81
Exposure warnings .....	135
Eye-piece cover .....	23, 86

**F**

FEB (Flash Exposure Bracketing).....	98
FE lock .....	94, 99
File numbers .....	115, 131
Flash exposure compensation.....	95, 99
Flash photography.....	43, 89
Automatic flash .....	43
Built-in flash .....	89, 90
EX-series Speedlite.....	89, 95
Flash shooting in each mode.....	97
Focusing point .....	61
AE lock effects for focusing and metering combinations.....	135
Focusing on an off-center subject.....	62
Selecting .....	61
Formatting .....	109, 131
FP flash (high-speed sync).....	98
Full auto flash.....	97
Fully automatic shooting .....	42
Fully press the shutter button .....	33
Function Availability Table.....	134

**H**

Half press the shutter button .....	33
Handling precautions.....	12
Camera .....	12
CF card .....	13
LCD panel and LCD monitor .....	12
Lens electrical contacts.....	13
Lithium backup battery .....	13
High-speed sync.....	98
Holding the camera .....	40
Household power supply.....	29

**I**

Image information .....	45, 104
Image zone .....	20
Imaging element.....	3, 117
Index printing .....	113
In-focus indicator .....	19
Interface cable.....	5
ISO speed.....	55, 120, 130

**J**

JPEG .....	54, 131
------------	---------

**L**

Landscape Mode .....	49
Landscape position .....	40
Language.....	122
LCD brightness .....	122
LCD panel.....	12, 18
Lens.....	30
Detaching.....	30
Effective field angle.....	30
Mounting .....	30

**M**

Macro Ring Lite.....	140
Main Dial .....	22, 34
Manual exposure .....	78
Manual focus.....	63
Main switch .....	22, 33
Message List.....	145
Menu functions.....	36, 120
Default settings .....	37
Functions.....	36
Items .....	37
Settings .....	36
Metering Modes .....	65
Types.....	66
MF (Manual Focus) .....	30, 63
Mirror lockup .....	88, 124
Mode dial .....	20
Modeling flash.....	99

**N**

Night Scene Mode .....	52
Non-Canon flash unit use .....	100
Number of available shots .....	28

**O**

One-shot AF .....	59
-------------------	----

## P

Parameter selection .....	56
Partial metering .....	66
PC Card Adapter .....	141
PC terminal.....	100
Portrait Mode.....	48
Portrait position .....	40, 106
Print order selection .....	110
Date printing .....	114
File number printing .....	115
Print type .....	113
Selecting all images.....	112
Selecting a single image .....	111
Program AE.....	72
Program line.....	136
Program shifting.....	73
Protection .....	107

## Q

Quick Control Dial .....	22, 35
Quick Control Dial Switch .....	35

## R

Recording capacity.....	54
Recording size .....	54
Red-eye phenomenon .....	131
Red-eye reduction .....	93
Remote Switch .....	141

## S

Self-timer .....	85
Service centers.....	Back cover
Settings checking .....	64
Shooting modes .....	20
Shutter button.....	33
Shutter speed.....	131
Shutter Speed-Priority AE .....	74
Shutter speed readout .....	137
Specifications.....	142
Software Starter Guide.....	5
Sports Mode.....	51
Standard.....	111
Strap.....	4, 23

Sync shutter speed.....	91, 100
System Map .....	146

## T

Television connection.....	116
Test shots .....	3
Timer Remote Controller .....	141
Trademarks .....	3

## V

Video cable .....	5, 116
Video system.....	123
Viewfinder.....	19
Viewing the image .....	44, 102
Auto playback.....	105
Enlarged image viewing .....	103
Erasing images	
Single.....	47
All.....	108
Jumping between images .....	103
Protecting images.....	107
Rotating images.....	106
Viewing a single image.....	102
Viewing the index.....	102

## W

Warranty .....	5
White balance .....	68, 69
Custom setting .....	70
Types.....	69
Wireless multi-light photography .....	99



## Free Manuals Download Website

<http://myh66.com>

<http://usermanuals.us>

<http://www.somanuals.com>

<http://www.4manuals.cc>

<http://www.manual-lib.com>

<http://www.404manual.com>

<http://www.luxmanual.com>

<http://aubethermostatmanual.com>

Golf course search by state

<http://golfingnear.com>

Email search by domain

<http://emailbydomain.com>

Auto manuals search

<http://auto.somanuals.com>

TV manuals search

<http://tv.somanuals.com>