

PowerShot SX700 HS

Camera User Guide

ENGLISH

- Make sure you read this guide, including the “Safety Precautions” (📖8) section, before using the camera.
- Reading this guide will help you learn to use the camera properly.
- Store this guide safely so that you can use it in the future.
- Click the buttons in the lower right to access other pages.
 - ▶: Next page
 - ◀: Previous page
 - 🔗: Page before you clicked a link
- To jump to the beginning of a chapter, click the chapter title at right.
From chapter title pages, you can access topics by clicking their titles.

Before Use

Basic Guide

Advanced Guide

Camera Basics

Auto Mode / Hybrid Auto Mode

Other Shooting Modes

P Mode

Tv, Av, and M Mode

Playback Mode

Wi-Fi Functions

Setting Menu

Accessories

Appendix

Index



Package Contents

Before use, make sure the following items are included in the package. If anything is missing, contact your camera retailer.



Camera



Battery Pack
NB-6LH

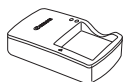

Battery Charger
CB-2LY/CB-2LYE



Wrist Strap

Printed Matter

- A memory card is not included (M2).

Compatible Memory Cards

The following memory cards (sold separately) can be used, regardless of capacity.

- SD memory cards*
- SDHC memory cards*
- SDXC memory cards*



* Cards conforming to SD standards. However, not all memory cards have been verified to work with the camera.

Preliminary Notes and Legal Information

- Take and review some test shots initially to make sure the images were recorded correctly. Please note that Canon Inc., its subsidiaries and affiliates, and its distributors are not liable for any consequential damages arising from any malfunction of a camera or accessory, including memory cards, that result in the failure of an image to be recorded or to be recorded in a way that is machine readable.
- Images recorded by the camera shall be for personal use. Refrain from unauthorized recording that infringes on copyright law, and note that even for personal use, photography may contravene copyright or other legal rights at some performances or exhibitions, or in some commercial settings.
- The camera warranty is valid only in the area of purchase. In case of camera problems while abroad, return to the area of purchase before contacting a Canon Customer Support Help Desk.
- Although the LCD monitor is produced under extremely high-precision manufacturing conditions and more than 99.99% of the pixels meet design specifications, in rare cases some pixels may be defective or may appear as red or black dots. This does not indicate camera damage or affect recorded images.
- The LCD monitor may be covered with a thin plastic film for protection against scratches during shipment. If covered, remove the film before using the camera.
- When the camera is used over an extended period, it may become warm. This does not indicate damage.

Before Use

Basic Guide

Advanced Guide

Camera Basics

Auto Mode / Hybrid
Auto Mode

Other Shooting
Modes

P Mode

Tv, Av, and M Mode

Playback Mode

Wi-Fi Functions

Setting Menu

Accessories

Appendix

Index



Part Names and Conventions in This Guide

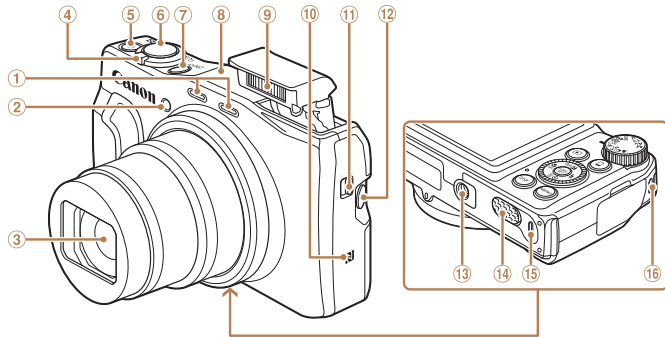

① Microphone

② Lamp

③ Lens

④ Zoom lever

Shooting: (telephoto) /
 (wide angle)>

Playback: (magnify)> /
 (index)>

⑤ Movie button

⑥ Shutter button

⑦ Power button

⑧ Wi-Fi antenna area

⑨ Flash

⑩ (N-Mark)*

⑪ (Flash up)> switch

⑫ (Framing Assist – Seek)>
 button

⑬ Tripod socket

⑭ DC coupler terminal cover

⑮ Memory card/battery cover

⑯ Strap mount

* Used with NFC features (119).

- Shooting modes and on-screen icons and text are indicated in brackets.
- : Important information you should know
- : Notes and tips for expert camera use
- xx: Pages with related information (in this example, “xx” represents a page number)
- Instructions in this guide apply to the camera under default settings.
- For convenience, all supported memory cards are simply referred to as the “memory card”.
- The tabs shown above titles indicate whether the function is used for still images, movies, or both.

Still Images : Indicates that the function is used when shooting or viewing still images.

Movies : Indicates that the function is used when shooting or viewing movies.

Before Use

Basic Guide

Advanced Guide

Camera Basics

Auto Mode / Hybrid
Auto Mode

Other Shooting
Modes

P Mode

Tv, Av, and M Mode

Playback Mode

Wi-Fi Functions

Setting Menu

Accessories

Appendix

Index



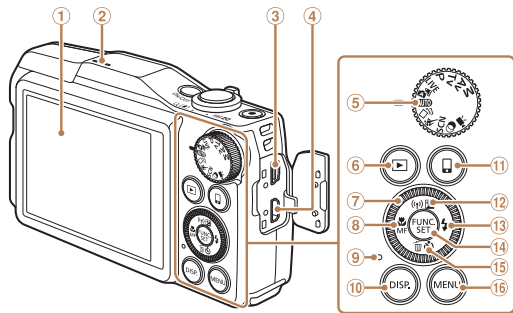

- ① Screen (LCD monitor)
- ② Speaker
- ③ AV OUT (Audio/video output) / DIGITAL terminal
- ④ HDMI™ terminal
- ⑤ Mode dial
- ⑥ <▶> (Playback)> button
- ⑦ Control dial
- ⑧ <M> (Macro)> / <MF (Manual focus)> / Left button
- ⑨ Indicator

- ⑩ <DISP. (Display)> button
- ⑪ <☐ (Mobile device connection)> button
- ⑫ <☒ (Exposure compensation)> / <(P) (Wi-Fi)> / Up button
- ⑬ <⚡ (Flash)> / Right button
- ⑭ FUNC./SET button
- ⑮ <⌚ (Self-timer)> / <🗑️ (Single-image erase)> / Down button
- ⑯ <MENU> button



- Turning the control dial is one way to choose setting items, switch images, and perform other operations. Most of these operations are also possible with the <▲><▼><◀><▶> buttons.

- In this guide, icons are used to represent the corresponding camera buttons and dials on which they appear or which they resemble.
- The following camera buttons and controls are represented by icons.
 - <▲> Up button ⑫ on back
 - <◀> Left button ⑧ on back
 - <▶> Right button ⑬ on back
 - <▼> Down button ⑮ on back
 - <⌚> Control dial ⑦ on back

Before Use

Basic Guide

Advanced Guide

Camera Basics

Auto Mode / Hybrid Auto Mode

Other Shooting Modes

P Mode

Tv, Av, and M Mode

Playback Mode

Wi-Fi Functions

Setting Menu

Accessories

Appendix

Index



Table of Contents

| | | | |
|--|-----------|---|-----------|
| Package Contents | 2 | Auto Mode / Hybrid Auto Mode | 27 |
| Compatible Memory Cards | 2 | Shooting with Camera-Determined Settings | 28 |
| Preliminary Notes and Legal Information | 2 | Common, Convenient Features | 34 |
| Part Names and Conventions in This Guide | 3 | Using Face ID | 40 |
| Table of Contents | 5 | Image Customization Features | 46 |
| Common Camera Operations | 7 | Helpful Shooting Features | 48 |
| Safety Precautions | 8 | Customizing Camera Operation | 50 |
| Basic Guide | 11 | Other Shooting Modes | 52 |
| Initial Preparations | 12 | Enjoying a Variety of Images from Each Shot (Creative Shot) | 53 |
| Trying the Camera Out | 16 | Brightness / Color Customization (Live View Control) | 54 |
| Advanced Guide | 20 | Moving Subjects (Sports) | 54 |
| Camera Basics | 20 | Specific Scenes | 55 |
| On/Off | 21 | Image Effects (Creative Filters) | 57 |
| Shutter Button | 22 | Shooting Various Movies | 65 |
| Shooting Modes | 22 | P Mode | 68 |
| Shooting Display Options | 23 | Shooting in Program AE ([P] Mode) | 69 |
| Using the FUNC. Menu | 23 | Image Brightness (Exposure) | 69 |
| Using Menus | 24 | Image Colors | 72 |
| On-Screen Keyboard | 25 | Shooting Range and Focusing | 74 |
| Indicator Display | 26 | Flash | 80 |
| Clock | 26 | Other Settings | 82 |

| | | | |
|--|------------|---|------------|
| Tv, Av, and M Mode | 84 | Connecting without an Access Point | 129 |
| Specific Shutter Speeds ([Tv] Mode) | 85 | Connecting to Another Camera | 132 |
| Specific Aperture Values ([Av] Mode) | 85 | Sending Images | 133 |
| Specific Shutter Speeds and Aperture Values ([M] Mode) | 86 | Saving Images to a Computer | 136 |
| Playback Mode | 88 | Using the < [] > Button | 137 |
| Viewing | 89 | Sending Images Automatically (Image Sync) | 139 |
| Browsing and Filtering Images | 93 | Geotagging Images on the Camera | 141 |
| Editing Face ID Information | 95 | Shooting Remotely | 141 |
| Image Viewing Options | 96 | Editing or Erasing Wi-Fi Settings | 142 |
| Protecting Images | 98 | Setting Menu | 145 |
| Erasing Images | 101 | Adjusting Basic Camera Functions | 146 |
| Rotating Images | 104 | Accessories | 154 |
| Tagging Images as Favorites | 105 | System Map | 155 |
| Editing Still Images | 106 | Optional Accessories | 156 |
| Editing Movies | 110 | Using Optional Accessories | 157 |
| Wi-Fi Functions | 113 | Using the Software | 160 |
| What You Can Do with Wi-Fi | 114 | Printing Images | 163 |
| Registering Web Services | 116 | | |
| Installing CameraWindow on a Smartphone | 119 | | |
| Preparing to Register a Computer | 120 | | |
| Accessing the Wi-Fi Menu | 123 | | |
| Connecting via an Access Point | 124 | | |

| |
|-------------------------------------|
| Before Use |
| Basic Guide |
| Advanced Guide |
| Camera Basics |
| Auto Mode / Hybrid Auto Mode |
| Other Shooting Modes |
| P Mode |
| Tv, Av, and M Mode |
| Playback Mode |
| Wi-Fi Functions |
| Setting Menu |
| Accessories |
| Appendix |
| Index |



| | |
|--|------------|
| Appendix | 171 |
| Troubleshooting | 172 |
| On-Screen Messages | 175 |
| On-Screen Information | 178 |
| Functions and Menu Tables | 180 |
| Handling Precautions..... | 188 |
| Specifications..... | 189 |
| Index | 192 |
| Wi-Fi (Wireless LAN) Precautions..... | 194 |

| |
|---------------------------------|
| Before Use |
| Basic Guide |
| Advanced Guide |
| Camera Basics |
| Auto Mode / Hybrid Auto Mode |
| Other Shooting Modes |
| P Mode |
| Tv, Av, and M Mode |
| Playback Mode |
| Wi-Fi Functions |
| Setting Menu |
| Accessories |
| Appendix |
| Index |



Common Camera Operations

Shoot

- Use camera-determined settings (Auto Mode, Hybrid Auto Mode) 28, 30
- See several effects applied to each shot, using camera-determined settings (Creative Shot Mode) 53

Shooting people well



Portraits
(55)



Against Snow
(56)

Matching specific scenes



Sports
(54)



Night Scenes
(56)



Low Light
(56)



Fireworks
(56)

Applying special effects



Vivid Colors
(57)



Poster Effect
(57)



Fish-Eye Effect
(58)



Miniature Effect
(58)



Toy Camera Effect
(59)



Soft Focus
(60)



Monochrome
(60)

- While adjusting image settings (Live View Control) 54
- Focus on faces 28, 55, 76
- Without using the flash (Flash Off) 29
- Include yourself in the shot (Self-Timer) 37, 63
- Add a date stamp 38
- Use Face ID 40, 92
- Movie clips and photos together (Movie Digest) 30

Before Use

Basic Guide

Advanced Guide

Camera Basics

Auto Mode / Hybrid Auto Mode

Other Shooting Modes

P Mode

Tv, Av, and M Mode

Playback Mode

Wi-Fi Functions

Setting Menu

Accessories

Appendix

Index



| | |
|--|-----|
|  View | |
| ● View images (Playback Mode)..... | 89 |
| ● Automatic playback (Slideshow) | 96 |
| ● On a TV..... | 157 |
| ● On a computer | 161 |
| ● Browse through images quickly | 93 |
| ● Erase images | 101 |

| | |
|---|--------|
|  Shoot/View Movies | |
| ● Shoot movies | 28, 65 |
| ● View movies (Playback Mode) | 89 |
| ● Fast-moving subjects, slow-motion playback..... | 66 |

| | |
|---|-----|
|  Print | |
| ● Print pictures | 163 |

| | |
|--|-----|
|  Save | |
| ● Save images to a computer via a cable | 161 |

| | |
|---|-----|
|  Use Wi-Fi Functions | |
| ● Send images to a smartphone | 115 |
| ● Share images online | 116 |
| ● Send images to a computer | 139 |

Safety Precautions

- Before using the product, ensure that you read the safety precautions described below. Always ensure that the product is used correctly.
- The safety precautions noted here are intended to prevent you and other persons from being injured or incurring property damage.
- Be sure to also check the guides included with any separately sold accessories you use.



Warning

Denotes the possibility of serious injury or death.

• **Do not trigger the flash in close proximity to people's eyes.**
Exposure to the intense light produced by the flash could damage eyesight. In particular, remain at least 1 meter (3.3 feet) away from infants when using the flash.

• **Store this equipment out of the reach of children and infants.**
A strap wound around a child's neck may result in asphyxiation. If your product uses a power cord, mistakenly winding the cord around a child's neck may result in asphyxiation.

- **Use only recommended power sources.**
- **Do not disassemble, alter, or apply heat to the product.**
- **Avoid dropping or subjecting the product to severe impacts.**
- **Do not touch the interior of the product if it is broken, such as when dropped.**
- **Stop using the product immediately if it emits smoke or a strange smell, or otherwise behaves abnormally.**
- **Do not use organic solvents such as alcohol, benzene, or thinner to clean the product.**
- **Avoid contact with liquid, and do not allow liquid or foreign objects inside.**

This could result in electrical shock or fire.
If the product gets wet, or if liquid or foreign objects get inside, remove the battery pack/batteries or unplug immediately.

Before Use

Basic Guide

Advanced Guide

Camera Basics

Auto Mode / Hybrid Auto Mode

Other Shooting Modes

P Mode

Tv, Av, and M Mode

Playback Mode

Wi-Fi Functions

Setting Menu

Accessories

Appendix

Index



- **Do not look through the viewfinder (if your model has one) at intense light sources, such as the sun on a clear day or an intense artificial light source.**

This could damage your eyesight.

- **Do not touch the product during thunderstorms if it is plugged in.**

This could result in electrical shock or fire. Immediately stop using the product and distance yourself from it.

- **Use only the recommended battery pack/batteries.**

- **Do not place the battery pack/batteries near or in direct flame.**

This may cause the battery pack/batteries to explode or leak, resulting in electrical shock, fire, or injuries. If leaking battery electrolyte comes into contact with eyes, mouth, skin, or clothing, immediately flush with water.

- **If the product uses a battery charger, note the following precautions.**

- **Remove the plug periodically and, using a dry cloth, wipe away any dust and dirt that has collected on the plug, the exterior of the power outlet, and the surrounding area.**

- **Do not insert or remove the plug with wet hands.**

- **Do not use the equipment in a manner that exceeds the rated capacity of the electrical outlet or wiring accessories. Do not use if the plug is damaged or not fully inserted in the outlet.**

- **Do not allow dust or metal objects (such as pins or keys) to contact the terminals or plug.**

- **Do not cut, damage, alter, or place heavy items on the power cord, if your product uses one.**

This could result in electrical shock or fire.

- **Turn the camera off in places where camera use is prohibited.**

The electromagnetic waves emitted by the camera may interfere with the operation of electronic instruments and other devices. Exercise adequate caution when using the product in places where use of electronic devices is restricted, such as inside airplanes and medical facilities.

- **Do not allow the camera to maintain contact with skin for extended periods.**

Even if the camera does not feel hot, this may cause low-temperature burns, manifested in redness of the skin or blistering. Use a tripod in hot places, or if you have poor circulation or insensitive skin.



Caution

Denotes the possibility of injury.

- **When carrying the product by the strap, be careful not to bang it, subject it to strong impacts or shocks, or let it get caught on other objects.**

- **Be careful not to bump or push strongly on the lens.**

This could lead to injury or damage the camera.

- **Be careful not to subject the screen to strong impacts.**

If the screen cracks, injury may result from the broken fragments.

- **When using the flash, be careful not to cover it with your fingers or clothing.**

This could result in burns or damage to the flash.

- **Avoid using, placing, or storing the product in the following places:**

- **Places subject to direct sunlight**

- **Places subject to temperatures above 40 °C (104 °F)**

- **Humid or dusty places**

These could cause leakage, overheating, or an explosion of the battery pack/batteries, resulting in electrical shock, fire, burns, or other injuries. Overheating and damage may result in electrical shock, fire, burns, or other injuries.

- **The slideshow transition effects may cause discomfort when viewed for prolonged periods.**

- **When using optional lenses, lens filters, or filter adapters (if applicable), be sure to attach these accessories firmly.**

If the lens accessory becomes loose and falls off, it may crack, and the shards of glass may lead to cuts.

Before Use

Basic Guide

Advanced Guide

Camera Basics

Auto Mode / Hybrid Auto Mode

Other Shooting Modes

P Mode

Tv, Av, and M Mode

Playback Mode

Wi-Fi Functions

Setting Menu

Accessories

Appendix

Index



- **On products that raise and lower the flash automatically, make sure to avoid pinching your fingers with the lowering flash.**

This could result in injury.

Caution

Denotes the possibility of property damage.

- **Do not aim the camera at intense light sources, such as the sun on a clear day or an intense artificial light source.**

Doing so may damage the image sensor or other internal components.

- **When using the camera on a sandy beach or at a windy location, be careful not to allow dust or sand to enter the camera.**
- **On products that raise and lower the flash automatically, do not push the flash down or pry it open.**

This may cause the product to malfunction.

- **Wipe off any dust, grime, or other foreign matter on the flash with a cotton swab or cloth.**

The heat emitted from the flash may cause foreign matter to smoke or the product to malfunction.

- **Remove and store the battery pack/batteries when you are not using the product.**

Any battery leakage that occurs may cause product damage.

- **Before you discard the battery pack/batteries, cover the terminals with tape or other insulators.**

Contacting other metal materials may lead to fire or explosions.

- **Unplug any battery charger used with the product when not in use. Do not cover with a cloth or other objects when in use.**

Leaving the unit plugged in for a long period of time may cause it to overheat and distort, resulting in fire.

- **Do not leave any dedicated battery packs near pets.**

Pets biting the battery pack could cause leakage, overheating, or explosion, resulting in product damage or fire.

- **If your product uses multiple batteries, do not use batteries that have different levels of charge together, and do not use old and new batteries together. Do not insert the batteries with the + and – terminals reversed.**

This may cause the product to malfunction.

- **Do not sit down with the camera in your pant pocket.**

Doing so may cause malfunctions or damage the screen.

- **When putting the camera in your bag, ensure that hard objects do not come into contact with the screen. Also close the screen (so that it faces the body), if your product's screen closes.**
 - **Do not attach any hard objects to the product.**
- Doing so may cause malfunctions or damage the screen.



Basic Guide

Basic information and instructions, from initial preparations to shooting and playback

| | | | |
|--|-----------|-----------------------------------|-----------|
| Initial Preparations..... | 12 | Trying the Camera Out..... | 16 |
| Attaching the Strap..... | 12 | Shooting (Smart Auto)..... | 16 |
| Holding the Camera | 12 | Viewing..... | 18 |
| Charging the Battery Pack | 12 | | |
| Inserting the Battery Pack and Memory Card | 13 | | |
| Setting the Date and Time..... | 14 | | |
| Display Language | 16 | | |

Before Use

Basic Guide

Advanced Guide

Camera Basics

Auto Mode / Hybrid
Auto Mode

Other Shooting
Modes

P Mode

Tv, Av, and M Mode

Playback Mode

Wi-Fi Functions

Setting Menu

Accessories

Appendix

Index



Initial Preparations

Prepare for shooting as follows.

Attaching the Strap

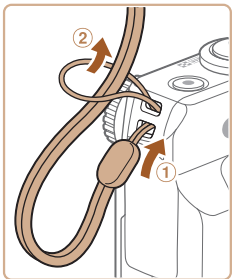

- Thread the end of the strap through the strap hole (①), and then pull the other end of the strap through the loop on the threaded end (②).

Holding the Camera



- Place the strap around your wrist.
- When shooting, keep your arms close to your body and hold the camera securely to prevent it from moving. If you have raised the flash, do not rest your fingers on it.

Charging the Battery Pack

Before use, charge the battery pack with the included charger. Be sure to charge the battery pack initially, because the camera is not sold with the battery pack charged.

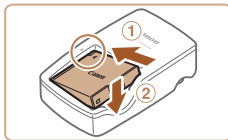

1 Insert the battery pack.

- After aligning the ▲ marks on the battery pack and charger, insert the battery pack by pushing it in (①) and down (②).

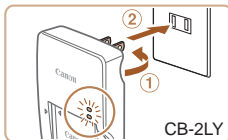

2 Charge the battery pack.

- **CB-2LY:** Flip out the plug (①) and plug the charger into a power outlet (②).
- **CB-2LYE:** Plug the power cord into the charger, then plug the other end into a power outlet.
- The charging lamp turns orange, and charging begins.
- When charging is finished, the lamp turns green.

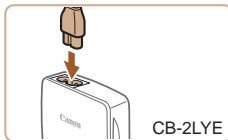

Before Use

Basic Guide

Advanced Guide

Camera Basics

Auto Mode / Hybrid Auto Mode

Other Shooting Modes

P Mode

Tv, Av, and M Mode

Playback Mode

Wi-Fi Functions

Setting Menu

Accessories

Appendix

Index



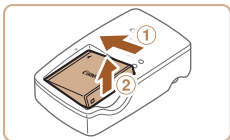

3 Remove the battery pack.

- After unplugging the battery charger, remove the battery pack by pushing it in (1) and up (2).



- To protect the battery pack and keep it in optimal condition, do not charge it continuously for more than 24 hours.
- For battery chargers that use a power cord, do not attach the charger or cord to other objects. Doing so could result in malfunction or damage to the product.



- For details on charging time and the number of shots and recording time possible with a fully charged battery pack, see "Number of Shots/Recording Time, Playback Time" (189).
- Charged battery packs gradually lose their charge, even when they are not used. Charge the battery pack on (or immediately before) the day of use.
- The charger can be used in areas with 100 – 240 V AC power (50/60 Hz). For power outlets in a different format, use a commercially available adapter for the plug. Never use an electrical transformer designed for traveling, which may damage the battery pack.



Inserting the Battery Pack and Memory Card

Insert the included battery pack and a memory card (sold separately). Note that before using a new memory card (or a memory card formatted in another device), you should format the memory card with this camera (149).

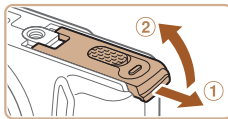

1 Open the cover.

- Slide the cover (1) and open it (2).

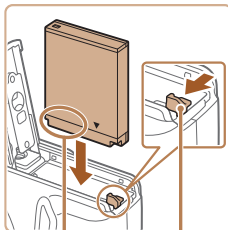

Terminals

Battery Lock

2 Insert the battery pack.

- While pressing the battery lock in the direction of the arrow, insert the battery pack as shown and push it in until it clicks into the locked position.
- If you insert the battery pack facing the wrong way, it cannot be locked into the correct position. Always confirm that the battery pack is facing the right way and locks when inserted.

Before Use

Basic Guide

Advanced Guide

Camera Basics

Auto Mode / Hybrid Auto Mode

Other Shooting Modes

P Mode

Tv, Av, and M Mode

Playback Mode

Wi-Fi Functions

Setting Menu

Accessories

Appendix

Index



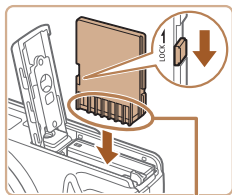

Terminals

3 Check the card's write-protect tab and insert the memory card.

- Recording is not possible on memory cards with a write-protect tab when the tab is in the locked position. Slide the tab to the unlocked position.
- Insert the memory card facing as shown until it clicks into the locked position.
- Make sure the memory card is facing the right way when you insert it. Inserting memory cards facing the wrong way may damage the camera.

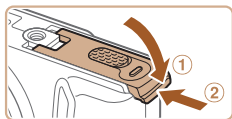

4 Close the cover.

- Lower the cover (①) and hold it down as you slide it, until it clicks into the closed position (②).



- For guidelines on how many shots or hours of recording can be saved on one memory card, see "Number of 4:3 Shots per Memory Card" (📖190).

■ Removing the Battery Pack and Memory Card

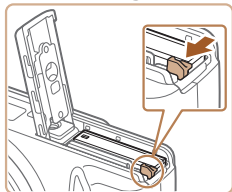

Remove the battery pack.

- Open the cover and press the battery lock in the direction of the arrow.
- The battery pack will pop up.

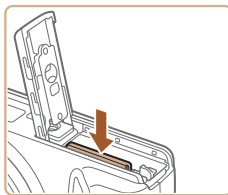

Remove the memory card.

- Push the memory card in until it clicks, and then slowly release it.
- The memory card will pop up.



Setting the Date and Time

Set the current date and time correctly as follows if the [Date/Time] screen is displayed when you turn the camera on. Information you specify this way is recorded in image properties when you shoot, and it is used when you manage images by shooting date or print images showing the date. You can also add a date stamp to shots, if you wish (📖38).

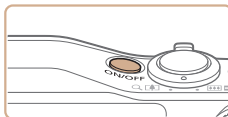

1 Turn the camera on.

- Press the power button.
- The [Date/Time] screen is displayed.

Before Use

Basic Guide

Advanced Guide

Camera Basics

Auto Mode / Hybrid Auto Mode

Other Shooting Modes

P Mode

Tv, Av, and M Mode

Playback Mode

Wi-Fi Functions

Setting Menu

Accessories

Appendix

Index



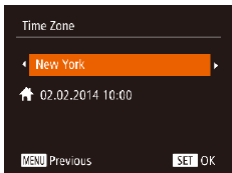
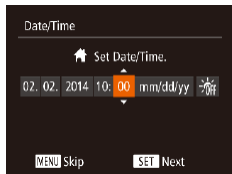

2 Set the date and time.

- Press the <<|>> buttons to choose an option.
- Press the <▲><▼> buttons or turn the <⊙> dial to specify the date and time.
- When finished, press the <FUNC SET> button.

3 Set the home time zone.

- Press the <<|>> buttons to choose your home time zone.

4 Finish the setup process.

- Press the <FUNC SET> button when finished. After a confirmation message, the setting screen is no longer displayed.
- To turn off the camera, press the power button.

⚠ Unless you set the date, time, and home time zone, the [Date/Time] screen will be displayed each time you turn the camera on. Specify the correct information.

✎ To set daylight saving time (1 hour ahead), choose [☀] in step 2 and then choose [🌙] by pressing the <▲><▼> buttons or turning the <⊙> dial.

Changing the Date and Time

Adjust the date and time as follows.

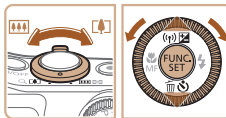
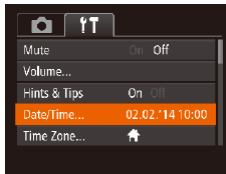
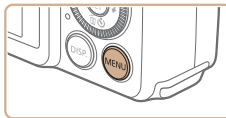

1 Access the camera menu.

- Press the <MENU> button.

2 Choose [Date/Time].

- Move the zoom lever to choose the [↑↑] tab.
- Press the <▲><▼> buttons or turn the <⊙> dial to choose [Date/Time], and then press the <FUNC SET> button.

3 Change the date and time.

- Follow step 2 in "Setting the Date and Time" (📖15) to adjust the settings.
- Press the <MENU> button to close the menu.

- ✎
- Date/time settings can be retained for about 3 weeks by the camera's built-in date/time battery (backup battery) after the battery pack is removed.
 - The date/time battery will be charged in about 4 hours once you insert a charged battery pack or connect the camera to an AC adapter kit (sold separately, 📖156), even if the camera is left off.
 - Once the date/time battery is depleted, the [Date/Time] screen will be displayed when you turn the camera on. Set the correct date and time as described in "Setting the Date and Time" (📖14).

Before Use

Basic Guide

Advanced Guide

Camera Basics

Auto Mode / Hybrid Auto Mode

Other Shooting Modes

P Mode

Tv, Av, and M Mode

Playback Mode

Wi-Fi Functions

Setting Menu

Accessories

Appendix

Index



Display Language

Change the display language as needed.



1 Enter Playback mode.

- Press the <▶> button.

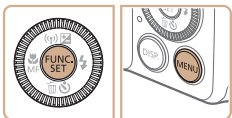

2 Access the setting screen.

- Press and hold the <FUNC. SET> button, and then immediately press the <MENU> button.



3 Set the display language.

- Press the <▲><▼><◀><▶> buttons or turn the <FUNC. SET> dial to choose a language, and then press the <FUNC. SET> button.
- Once the display language has been set, the setting screen is no longer displayed.



- The current time is displayed if you wait too long in step 2 after pressing the <FUNC. SET> button before you press the <MENU> button. In this case, press the <FUNC. SET> button to dismiss the time display and repeat step 2.
- You can also change the display language by pressing the <MENU> button and choosing [Language] on the [11] tab.

Still Images

Movies

Trying the Camera Out

Follow these instructions to turn the camera on, shoot still images or movies, and then view them.

Shooting (Smart Auto)

For fully automatic selection of the optimal settings for specific scenes, simply let the camera determine the subject and shooting conditions.

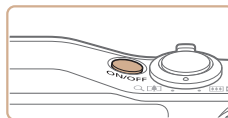

1 Turn the camera on.

- Press the power button.
- The startup screen is displayed.



2 Enter [AUTO] mode.

- Set the mode dial to [AUTO].
- Aim the camera at the subject. The camera will make a slight clicking noise as it determines the scene.
- Icons representing the scene and image stabilization mode are displayed in the upper left of the screen.
- Frames displayed around any detected subjects indicate that they are in focus.



Before Use

Basic Guide

Advanced Guide

Camera Basics

Auto Mode / Hybrid Auto Mode

Other Shooting Modes

P Mode

Tv, Av, and M Mode

Playback Mode

Wi-Fi Functions

Setting Menu

Accessories

Appendix

Index



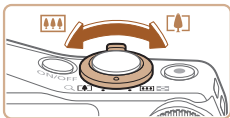

3 Compose the shot.

- To zoom in and enlarge the subject, move the zoom lever toward (telephoto), and to zoom away from the subject, move it toward (wide angle).

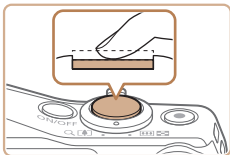

4 Shoot. Shooting Still Images

① Focus.

- Press the shutter button lightly, halfway down. The camera beeps twice after focusing, and AF frames are displayed to indicate image areas in focus.

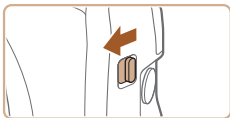
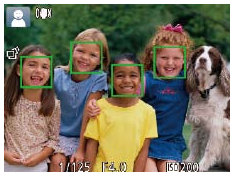

- If [Raise the flash] appears on the screen, move the switch to raise the flash. It will fire when shooting. If you prefer not to use the flash, push it down with your finger, into the camera.

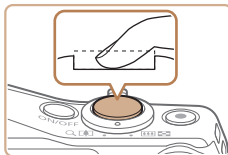

② Shoot.

- Press the shutter button all the way down.
- As the camera shoots, a shutter sound is played, and in low-light conditions when you have raised the flash, it fires automatically.
- Keep the camera still until the shutter sound ends.
- After displaying your shot, the camera will revert to the shooting screen.



Shooting Movies

① Start shooting.

- Press the movie button. The camera beeps once as recording begins, and is displayed with the elapsed time.
- Black bars are displayed on the top and bottom edges of the screen, and the subject is slightly enlarged. The black bars indicate image areas not recorded.
- Frames displayed around any detected faces indicate that they are in focus.
- Once recording begins, take your finger off the movie button.

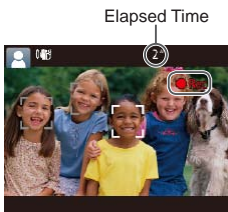

Before Use

Basic Guide

Advanced Guide

Camera Basics

Auto Mode / Hybrid Auto Mode

Other Shooting Modes

P Mode

Tv, Av, and M Mode

Playback Mode

Wi-Fi Functions

Setting Menu

Accessories

Appendix

Index



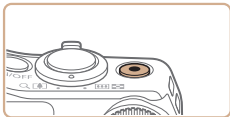

② Finish shooting.

- Press the movie button again to stop shooting. The camera beeps twice as recording stops.

Viewing

After shooting images or movies, you can view them on the screen as follows.



1 Enter Playback mode.

- Press the <▶> button.
- Your last shot is displayed.



2 Browse through your images.

- To view the previous image, press the <◀> button or turn the <⦿> dial counterclockwise. To view the next image, press the <▶> button or turn the <⦿> dial clockwise.
- Press and hold the <◀><▶> buttons to browse through images quickly.

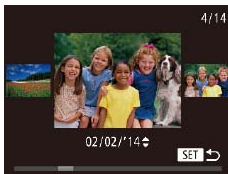

- To access Scroll Display mode, turn the <⦿> dial rapidly. In this mode, turn the <⦿> dial to browse through images.
- To return to single-image display, press the <FUNC. SET> button.

Before Use

Basic Guide

Advanced Guide

Camera Basics

Auto Mode / Hybrid Auto Mode

Other Shooting Modes

P Mode

Tv, Av, and M Mode

Playback Mode

Wi-Fi Functions

Setting Menu

Accessories

Appendix

Index





- Movies are identified by a [SET ▶] icon. To play movies, go to step 3.



3 Play movies.

- Press the <FUNC SET> button, choose [▶] (either press the <▲><▼> buttons or turn the <⊙> dial), and then press the <FUNC SET> button again.
- Playback now begins, and after the movie is finished, [SET ▶] is displayed.
- To adjust the volume, press the <▲><▼> buttons.



- To switch to Shooting mode from Playback mode, press the shutter button halfway.

Erasing Images

You can choose and erase unneeded images one by one. Be careful when erasing images, because they cannot be recovered.



1 Choose an image to erase.

- Press the <◀><▶> buttons or turn the <⊙> dial to choose an image.

2 Erase the image.

- Press the <▼> button.
- After [Erase?] is displayed, press the <◀><▶> buttons or turn the <⊙> dial to choose [Erase], and then press the <FUNC SET> button.
- The current image is now erased.
- To cancel erasure, press the <◀><▶> buttons or turn the <⊙> dial to choose [Cancel], and then press the <FUNC SET> button.



- You can also erase all images at once (📖102).

Before Use

Basic Guide

Advanced Guide

Camera Basics

Auto Mode / Hybrid Auto Mode

Other Shooting Modes

P Mode

Tv, Av, and M Mode

Playback Mode

Wi-Fi Functions

Setting Menu

Accessories

Appendix

Index



Camera Basics

Other basic operations and more ways to enjoy your camera, including shooting and playback options

| | | | |
|---|-----------|-----------------------------------|-----------|
| On/Off | 21 | Using the FUNC. Menu | 23 |
| Power-Saving Features (Auto Power Down) | 21 | Using Menus | 24 |
| Shutter Button | 22 | On-Screen Keyboard | 25 |
| Shooting Modes | 22 | Indicator Display | 26 |
| Shooting Display Options | 23 | Clock | 26 |

Before Use

Basic Guide

Advanced Guide

Camera Basics

Auto Mode / Hybrid
Auto Mode

Other Shooting
Modes

P Mode

Tv, Av, and M Mode

Playback Mode

Wi-Fi Functions

Setting Menu

Accessories

Appendix

Index



On/Off

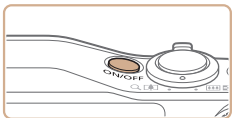



Shooting Mode

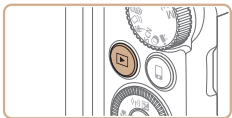

- Press the power button to turn the camera on and prepare for shooting.
- To turn the camera off, press the power button again.

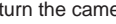

Playback Mode

- Press the  button to turn the camera on and view your shots.
- To turn the camera off, press the  button again.

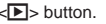

- To switch to Playback mode from Shooting mode, press the  button.
- To switch to Shooting mode from Playback mode, press the shutter button halfway ( 22).
- The lens will be retracted after about one minute once the camera is in Playback mode. You can turn the camera off when the lens is retracted by pressing the  button.

Power-Saving Features (Auto Power Down)

As a way to conserve battery power, the camera automatically deactivates the screen (Display Off) and then turns itself off after a specific period of inactivity.



Power Saving in Shooting Mode

The screen is automatically deactivated after about one minute of inactivity. In about two more minutes, the lens is retracted and the camera turns itself off. To activate the screen and prepare for shooting when the screen is off but the lens is still out, press the shutter button halfway ( 22).

Power Saving in Playback Mode

The camera turns itself off automatically after about five minutes of inactivity.



- You can deactivate Auto Power Down and adjust the timing of Display Off, if you prefer ( 148).
- Power saving is not active while the camera is connected to other devices via Wi-Fi ( 113), or when connected to a computer ( 161).

Before Use

Basic Guide

Advanced Guide

Camera Basics

Auto Mode / Hybrid Auto Mode

Other Shooting Modes

P Mode

Tv, Av, and M Mode

Playback Mode

Wi-Fi Functions

Setting Menu

Accessories

Appendix

Index



Shutter Button

To ensure your shots are in focus, always begin by holding the shutter button halfway down, and once the subject is in focus, press the button all the way down to shoot.

In this manual, shutter button operations are described as pressing the button *halfway* or *all the way down*.

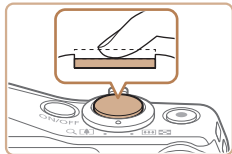

1 Press halfway. (Press lightly to focus.)

- Press the shutter button halfway. The camera beeps twice, and AF frames are displayed around image areas in focus.

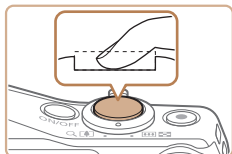

2 Press all the way down. (From the halfway position, press fully to shoot.)

- The camera shoots, as a shutter sound is played.
- Keep the camera still until the shutter sound ends.



- Images may be out of focus if you shoot without initially pressing the shutter button halfway.
- Length of shutter sound playback varies depending on the time required for the shot. It may take longer in some shooting scenes, and images will be blurry if you move the camera (or the subject moves) before the shutter sound ends.

Shooting Modes

Use the mode dial to access each shooting mode.

Live View Control Mode

Customize image brightness or colors when shooting (□□54).

P, Tv, Av, and M Modes

Take a variety of shots using your preferred settings (□□68, 84).

Auto Mode / Hybrid Auto Mode

Fully automatic shooting, with camera-determined settings (□□16, 28, 30).

Creative Shot Mode

You can capture multiple still images with effects using camera-determined settings (□□53).

Sports Mode

Shoot continuously as the camera focuses on moving subjects (□□54).

Movie Mode

For shooting movies (□□65). You can also shoot movies when the mode dial is not set to Movie mode, simply by pressing the movie button.

Creative Filters Mode

Add a variety of effects to images when shooting (□□57).

Scene Mode

Shoot with optimal settings for specific scenes (□□55).



Before Use

Basic Guide

Advanced Guide

Camera Basics

Auto Mode / Hybrid Auto Mode

Other Shooting Modes

P Mode

Tv, Av, and M Mode

Playback Mode

Wi-Fi Functions

Setting Menu

Accessories

Appendix

Index



Shooting Display Options

Press the <DISP.> button to view other information on the screen, or to hide the information. For details on the information displayed, see “On-Screen Information” (📖178).



Information is displayed



No information is displayed



- Screen brightness is automatically increased by the night view function when you are shooting under low light, making it easier to check how shots are composed. However, on-screen image brightness may not match the brightness of your shots. Note that any on-screen image distortion or jerky subject motion will not affect recorded images.
- For playback display options, see “Switching Display Modes” (📖90).

Using the FUNC. Menu

Configure commonly used functions through the FUNC. menu as follows. Note that menu items and options vary depending on the shooting mode (📖182 – 183) or playback mode (📖188).



Menu Items

1 Access the FUNC. menu.

- Press the <FUNC. SET.> button.

2 Choose a menu item.

- Press the <▲><▼> buttons or turn the <DISP.> dial to choose a menu item, and then press the <FUNC. SET.> or <▶> button.
- Depending on the menu item, functions can be specified simply by pressing the <FUNC. SET.> or <▶> button, or another screen is displayed for configuring the function.

Before Use

Basic Guide

Advanced Guide

Camera Basics

Auto Mode / Hybrid Auto Mode

Other Shooting Modes

P Mode

Tv, Av, and M Mode

Playback Mode

Wi-Fi Functions

Setting Menu

Accessories

Appendix

Index





3 Choose an option.

- Press the <▲><▼> buttons or turn the <FUNC. SET> dial to choose an option.
- Options labeled with a [DISP.] icon can be configured by pressing the <DISP.> button.
- To return to the menu items, press the <◀> button.



4 Finish the setup process.

- Press the <FUNC. SET> button.
- The screen before you pressed the <FUNC. SET> button in step 1 is displayed again, showing the option you configured.



- To undo any accidental setting changes, you can restore the camera's default settings (184 – 188).

Using Menus

Configure a variety of camera functions through other menus as follows. Menu items are grouped by purpose on tabs, such as shooting [CAMERA], playback [PLAYBACK], and so on. Note that available menu items vary depending on the selected shooting or playback mode (184 – 188).

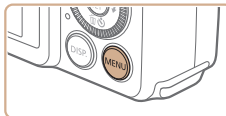

1 Access the menu.

- Press the <MENU> button.

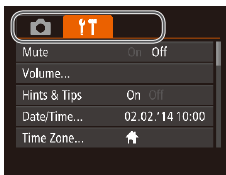

2 Choose a tab.

- Move the zoom lever to choose a tab.
- After you have pressed the <▲><▼> buttons or turned the <FUNC. SET> dial to choose a tab initially, you can switch between tabs by pressing the <◀><▶> buttons.

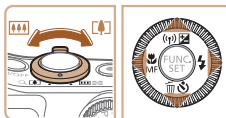

Before Use

Basic Guide

Advanced Guide

Camera Basics

Auto Mode / Hybrid Auto Mode

Other Shooting Modes

P Mode

Tv, Av, and M Mode

Playback Mode

Wi-Fi Functions

Setting Menu

Accessories

Appendix

Index



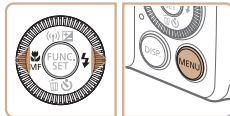
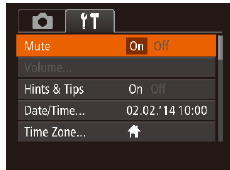
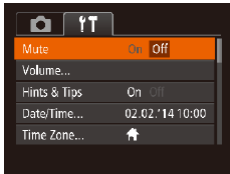

3 Choose a menu item.

- Press the <▲><▼> buttons or turn the <◉> dial to choose a menu item.
- For menu items with options not shown, first press the <FUNC. SET> or <▶> button to switch screens, and then either press the <▲><▼> buttons or turn the <◉> dial to select the menu item.
- To return to the previous screen, press the <MENU> button.

4 Choose an option.

- Press the <◀><▶> buttons to choose an option.

5 Finish the setup process.

- Press the <MENU> button to return to the screen displayed before you pressed the <MENU> button in step 1.



- To undo any accidental setting changes, you can restore the camera's default settings (152).

On-Screen Keyboard

Use the on-screen keyboard to enter information for Face ID (41), Wi-Fi connections (123), and so on. Note that the length and type of information you can enter varies depending on the function you are using.

Number of Available Characters

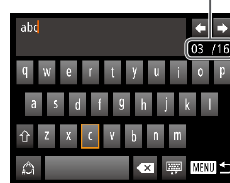

Entering Characters

- Press the <▲><▼><◀><▶> buttons or turn the <◉> dial to choose a character, and then press the <FUNC. SET> button to enter it.
- The amount of information you can enter varies depending on the function you are using.

Moving the Cursor

- Choose [◀] or [▶] and press the <FUNC. SET> button.

Entering Line Breaks

- Choose [↵] and press the <FUNC. SET> button.

Switching Input Modes

- To switch to numbers or symbols, choose [123] and press the <FUNC. SET> button.
- To switch between uppercase and lowercase letters, choose [↑] and press the <FUNC. SET> button.
- Available input modes vary depending on the function you are using.

Deleting Characters

- Choose [✖] and press the <FUNC. SET> button. The previous character will be deleted.

Confirming Input and Returning to the Previous Screen

- Press the <MENU> button.

Before Use

Basic Guide

Advanced Guide

Camera Basics

Auto Mode / Hybrid Auto Mode

Other Shooting Modes

P Mode

Tv, Av, and M Mode

Playback Mode

Wi-Fi Functions

Setting Menu

Accessories

Appendix

Index



Indicator Display

The indicator on the back of the camera (📖4) lights up or blinks depending on the camera status.

| Color | Indicator Status | Camera Status |
|-------|------------------|---|
| Green | On | Connected to a computer (📖161), or display off (📖21, 148, 148) |
| | Blinking | Starting up, recording/reading/transmitting images, shooting long exposures (📖85, 86), or connecting/transmitting via Wi-Fi |



- When the indicator blinks green, never turn the camera off, open the memory card/battery cover, or shake or jolt the camera, which may corrupt images or damage the camera or memory card.

Clock

You can check the current time.

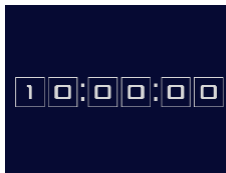

- When the camera is off, press and hold the <FUNC. SET> button, then press the power button to display the clock.

- Press and hold the <FUNC. SET> button.
- The current time appears.
- If you hold the camera vertically while using the clock function, it will switch to vertical display. Press the <<>> buttons or turn the <DIAL> dial to change the display color.
- Press the <FUNC. SET> button again to cancel the clock display.

Before Use

Basic Guide

Advanced Guide

Camera Basics

Auto Mode / Hybrid Auto Mode

Other Shooting Modes

P Mode

Tv, Av, and M Mode

Playback Mode

Wi-Fi Functions

Setting Menu

Accessories

Appendix

Index



Auto Mode / Hybrid Auto Mode

Convenient mode for easy shots with greater control over shooting

| | | | | | |
|--|-----------|--|-----------|---|-----------|
| Shooting with Camera-Determined Settings | 28 | Using Face ID | 40 | Customizing Camera Operation | 50 |
| Shooting (Smart Auto)..... | 28 | Registering Face ID Information | 40 | Deactivating the AF-Assist Beam..... | 50 |
| Shooting in Hybrid Auto Mode..... | 30 | Shooting | 42 | Deactivating the Red-Eye Reduction Lamp | 50 |
| Scene Icons | 32 | Checking and Editing Registered Information..... | 43 | Changing the Image Display Style after Shots..... | 51 |
| Image Stabilization Icons | 33 | Image Customization Features | 46 | | |
| On-Screen Frames..... | 34 | Changing the Aspect Ratio..... | 46 | | |
| Common, Convenient Features | 34 | Changing Image Resolution (Size) | 46 | | |
| Zooming In Closer on Subjects (Digital Zoom) | 34 | Red-Eye Correction..... | 47 | | |
| Reacquiring Subjects Lost after Zooming (Framing Assist – Seek)..... | 35 | Correcting Greenish Image Areas from Mercury Lamps | 47 | | |
| Constantly Displaying Faces at the Same Size | 35 | Changing Movie Image Quality | 48 | | |
| Using the Self-Timer..... | 37 | Helpful Shooting Features | 48 | | |
| Adding a Date Stamp..... | 38 | Displaying Grid Lines | 48 | | |
| Continuous Shooting..... | 39 | Magnifying the Area in Focus..... | 49 | | |
| | | Checking for Closed Eyes..... | 49 | | |

Before Use

Basic Guide

Advanced Guide

Camera Basics

Auto Mode / Hybrid Auto Mode

Other Shooting Modes

P Mode

Tv, Av, and M Mode

Playback Mode

Wi-Fi Functions

Setting Menu

Accessories

Appendix

Index



Shooting with Camera-Determined Settings

For fully automatic selection of the optimal settings for specific scenes, simply let the camera determine the subject and shooting conditions.

Still Images

Movies

Shooting (Smart Auto)

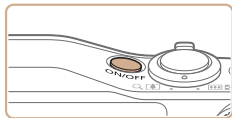

1 Turn the camera on.

- Press the power button.
- The startup screen is displayed.



2 Enter [AUTO] mode.

- Set the mode dial to [AUTO].
- Aim the camera at the subject. The camera will make a slight clicking noise as it determines the scene.
- Icons representing the scene and image stabilization mode are displayed in the upper left of the screen (32, 33).
- Frames displayed around any detected subjects indicate that they are in focus.



Zoom Bar



Focus Range (approx.)

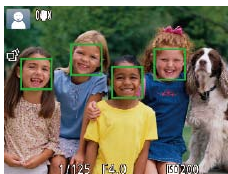
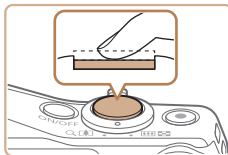

3 Compose the shot.

- To zoom in or out quickly, move the zoom lever all the way toward <[T]> (telephoto) or <[W]> (wide angle), and to zoom in or out slowly, move it just a little in the desired direction.

4 Shoot. Shooting Still Images

① Focus.

- Press the shutter button halfway. The camera beeps twice after focusing, and AF frames are displayed to indicate image areas in focus.
- Several AF frames are displayed when multiple areas are in focus.

Before Use

Basic Guide

Advanced Guide

Camera Basics

Auto Mode / Hybrid Auto Mode

Other Shooting Modes

P Mode

Tv, Av, and M Mode

Playback Mode

Wi-Fi Functions

Setting Menu

Accessories

Appendix

Index



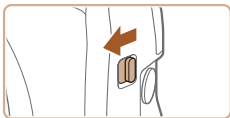

- If [Raise the flash] appears on the screen, move the $\left\langle \downarrow \uparrow \right\rangle$ switch to raise the flash. It will fire when shooting. If you prefer not to use the flash, push it down with your finger, into the camera.

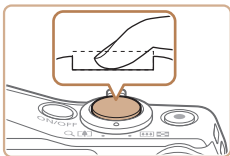

② Shoot.

- Press the shutter button all the way down.
- As the camera shoots, a shutter sound is played, and in low-light conditions when you have raised the flash, it fires automatically.
- Keep the camera still until the shutter sound ends.
- After displaying your shot, the camera will revert to the shooting screen.



Elapsed Time

Shooting Movies

① Start shooting.

- Press the movie button. The camera beeps once as recording begins, and [●Rec] is displayed with the elapsed time.
- Black bars are displayed on the top and bottom edges of the screen, and the subject is slightly enlarged. The black bars indicate image areas not recorded.
- Frames displayed around any detected faces indicate that they are in focus.
- Once recording begins, take your finger off the movie button.

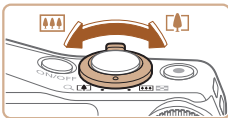

② Resize the subject and recompose the shot as needed.

- To resize the subject, repeat the operations in step 3 (📖28). However, note that the sound of camera operations will be recorded, and movies shot at zoom factors shown in blue will look grainy.
- When you recompose shots, the focus, brightness, and colors will be automatically adjusted.

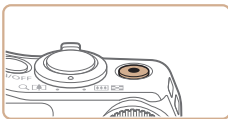

③ Finish shooting.

- Press the movie button again to stop shooting. The camera beeps twice as recording stops.
- Recording will stop automatically when the memory card becomes full.



- The flash firing during shots indicates that the camera has automatically attempted to ensure optimal colors in the main subject and background (Multi-area White Balance).

Before Use

Basic Guide

Advanced Guide

Camera Basics

Auto Mode / Hybrid Auto Mode

Other Shooting Modes

P Mode

Tv, Av, and M Mode

Playback Mode

Wi-Fi Functions

Setting Menu

Accessories

Appendix

Index



Shooting in Hybrid Auto Mode

You can make a short movie of the day just by shooting still images. The camera records 2 – 4-second clips of scenes before each shot, which are later combined in a digest movie.



1 Enter [Hybrid Auto] mode.

- Follow step 2 in “Shooting (Smart Auto)” (📖28) and choose [Hybrid Auto].

2 Compose the shot.

- Follow steps 3 – 4 in “Shooting (Smart Auto)” (📖28) to compose the shot and focus.
- For more impressive digest movies, aim the camera at subjects about four seconds before shooting still images.

3 Shoot.

- Follow step 4 in “Shooting (Smart Auto)” (📖28) to shoot a still image.
- The camera records both a still image and movie clip. The clip, which ends with the still image and a shutter sound, forms a single chapter in the digest movie.



- Battery life is shorter in this mode than in [AUTO] mode, because digest movies are recorded for each shot.
- A digest movie may not be recorded if you shoot a still image immediately after turning the camera on, choosing [Hybrid Auto] mode, or operating the camera in other ways.
- Sounds and vibrations from operating the camera will be recorded in digest movies.



- Digest movie quality is [60P] and cannot be changed.
- Sounds are not played when you press the shutter button halfway or trigger the self-timer (📖146).
- Digest movies are saved as separate movie files in the following cases even if they were recorded on the same day in [Hybrid Auto] mode.
 - The digest movie file size reaches approximately 4 GB, or the total recording time reaches approximately 13 minutes and 20 seconds.
 - The digest movie is protected (📖98).
 - Daylight saving time (📖15) or time zone (📖147) settings are changed.
 - A new folder is created (📖151).
- Recorded shutter sounds cannot be modified or erased.
- If you prefer to record digest movies without still images, adjust the setting in advance. Choose MENU (📖24) > [📷] tab > [Digest Type] > [No Stills].
- Individual chapters can be edited (📖112).

■ Digest Movie Playback

Display a still image shot in [Hybrid Auto] mode to play a digest movie, or specify the date of the digest movie to play (📖91).

Before Use

Basic Guide

Advanced Guide

Camera Basics

Auto Mode / Hybrid Auto Mode

Other Shooting Modes

P Mode

Tv, Av, and M Mode

Playback Mode

Wi-Fi Functions

Setting Menu

Accessories

Appendix

Index



Still Images/Movies

- If the camera is turned on while the <DISP.> button is held down, the camera will no longer sound. To activate sounds again, press the <MENU> button and choose [Mute] on the [Fn] tab, and then press the <Left><Right> buttons to choose [Off].

Still Images

- A blinking [B] icon warns that images are more likely to be blurred by camera shake. In this case, mount the camera on a tripod or take other measures to keep it still.
- If your shots are dark despite the flash firing, move closer to the subject. For details on the flash range, see “Flash Range” (190).
- The subject may be too close if the camera only beeps once when you press the shutter button halfway. For details on the focusing range (shooting range), see “Shooting Range” (190).
- To reduce red-eye and to assist in focusing, the lamp may be activated when shooting in low-light conditions.
- A blinking [F] icon displayed when you attempt to shoot indicates that shooting is not possible until the flash has finished recharging. Shooting can resume as soon as the flash is ready, so either press the shutter button all the way down and wait, or release it and press it again.
- The shutter sound will not be played when the Sleeping and Babies (Sleeping) icons (32) are displayed.
- Although you can shoot again before the shooting screen is displayed, your previous shot may determine the focus, brightness, and colors used.



- You can change how long images are displayed after shots (51).

Movies

- The camera may become warm when shooting movies repeatedly over an extended period. This does not indicate damage.

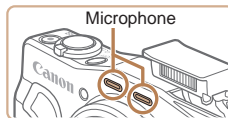

- Before shooting a movie, lower the flash with your finger. Be careful not to touch the microphone when shooting a movie. Leaving the flash raised, or blocking the microphone may prevent audio from being recorded or may cause the recording to sound muffled.
 - Avoid touching camera controls other than the movie button when shooting movies, because sounds made by the camera will be recorded.
 - Once movie recording begins, the image display area changes and subjects are enlarged to allow for correction of significant camera shake. To shoot subjects at the same size shown before shooting, adjust the image stabilization setting (83).
-
- Audio is recorded in stereo.
 - Distorted audio caused by recording when the wind is strong can be reduced. However, the recording may sound unnatural when this option is used when there is no wind. When the wind is not strong, choose MENU (24) > [Camera] tab > [Wind Filter] > [Off].

Before Use

Basic Guide

Advanced Guide

Camera Basics

Auto Mode / Hybrid Auto Mode

Other Shooting Modes

P Mode

Tv, Av, and M Mode

Playback Mode

Wi-Fi Functions

Setting Menu

Accessories

Appendix

Index



Scene Icons

In **[S]** and **[AUTO]** modes, shooting scenes determined by the camera are indicated by the icon displayed, and corresponding settings are automatically selected for optimal focusing, subject brightness, and color. Depending on the scene, continuous images may be shot (📖33).

| Subject | Background | Normal | Backlit | Dark* | Sunsets | Spotlights |
|-----------------------------|---------------|--------|---------|-------|---------|------------|
| | People | | | | | – |
| In Motion | | | | – | – | – |
| Shadows on Face | | – | – | – | – | – |
| Smiling | | | | – | – | – |
| Sleeping | | | | – | – | – |
| Babies | | | | – | – | – |
| Smiling | | | | – | – | – |
| Sleeping | | | | – | – | – |
| Children (In Motion) | | | | – | – | – |
| Other Subjects | AUTO | | | | | |
| In Motion | | | | – | – | – |
| At Close Range | | | | – | – | |

* Tripod Used

The background color of icons is light blue when the background is a blue sky, dark blue when the background is dark, and gray for all other backgrounds.

The background color of icons is light blue when the background is a blue sky, and gray for all other backgrounds.

- The background color of , , , , and is dark blue, and the background color of is orange.
- When shooting movies, only People, Other Subjects, and At Close Range icons will be displayed.
- When shooting in mode, only People, Shadows on Face, Other Subjects, and At Close Range icons will be displayed.
- When shooting with the self-timer, People (In Motion), Smiling, Sleeping, Babies (Smiling), Babies (Sleeping), Children, Other Subjects (In Motion) icons will not be displayed.
- The following icons are not displayed in drive modes other than **[A]** (📖33, 39), and when [Hg Lamp Corr.] is set to [On] and scenes are automatically corrected (📖47): Smiling, Sleeping, Babies (Smiling), Babies (Sleeping), and Children.
- If the flash is set to **[A]**, the Backlit icons for Smiling and Children will not be displayed.
- Babies, Babies (Smiling), Babies (Sleeping), and Children icons will be displayed when [Face ID] is set to [On], and the face of a registered baby (under two years old) or child (from two to twelve years old) is detected (📖40). Confirm beforehand that the date and time are correct (📖14).



- Try shooting in **[P]** mode (📖68) if the scene icon does not match actual shooting conditions, or if it is not possible to shoot with your expected effect, color, or brightness.

Before Use

Basic Guide

Advanced Guide

Camera Basics

Auto Mode / Hybrid Auto Mode

Other Shooting Modes

P Mode

Tv, Av, and M Mode

Playback Mode

Wi-Fi Functions

Setting Menu



Accessories



Appendix

Index



Continuous Shooting Scenes

If you shoot a still image when the following scene icons are displayed, the camera will shoot continuously. If you press the shutter button halfway when one of the icons in the table below is displayed, one of the following icons will be displayed to inform you that the camera will shoot continuous images: , , or .

| | |
|-----------------------------|---|
| Smiling (including Babies) |  : Consecutive images are captured, and the camera analyzes details such as facial expressions to save the image determined to be the best. |
| Sleeping (including Babies) |  : Beautiful shots of sleeping faces, created by combining consecutive shots to reduce camera shake and image noise. The AF-assist beam will not light up, the flash will not fire, and the shutter sound will not be played. |
| Children |  : So you don't miss a photo opportunity of children who move around, the camera will capture three consecutive images for each shot. |



- In some scenes, expected images may not be saved, and images may not look as expected.
- Focus, image brightness, and color are determined by the first shot.

















- When you want to shoot single images only, press the  button, choose  in the menu, and then select .



Image Stabilization Icons

Optimal image stabilization for the shooting conditions is automatically applied (Intelligent IS). Additionally, the following icons are displayed in  and  modes.

| | | | |
|--|---|--|---|
|  | Image stabilization for still images (Normal) |  | Image stabilization for movies, reducing strong camera shake, as when shooting while walking (Dynamic) |
|  | Image stabilization for still images when panning (Panning)* |  | Image stabilization for slow camera shake, such as when shooting movies at telephoto (Powered) |
|   | Image stabilization for macro shots (Hybrid IS) During movie recording,  is displayed, and image stabilization for macro movie recording is used. |   | No image stabilization, because the camera is mounted on a tripod or held still by other means. However, during movie recording,  is displayed, and image stabilization to counteract wind or other sources of vibration is used (Tripod IS). |

* Displayed when you pan, following moving subjects with the camera. When you follow subjects moving horizontally, image stabilization only counteracts vertical camera shake, and horizontal stabilization stops. Similarly, when you follow subjects moving vertically, image stabilization only counteracts horizontal camera shake.



- To cancel image stabilization, set [IS Mode] to [Off]  82. In this case, an IS icon is not displayed.
- In  mode, no  icon is displayed.



On-Screen Frames

In **[AUTO]** mode, a variety of frames are displayed once the camera detects subjects you are aiming the camera at.

- A white frame is displayed around the subject (or person's face) determined by the camera to be the main subject, and gray frames are displayed around other detected faces. Frames follow moving subjects within a certain range to keep them in focus.

However, if the camera detects subject movement, only the white frame will remain on the screen.

- When you are pressing the shutter button halfway and the camera detects subject movement, a blue frame is displayed, and the focus and image brightness are constantly adjusted (Servo AF).



- Try shooting in **[P]** mode (📖68) if no frames are displayed, if frames are not displayed around desired subjects, or if frames are displayed on the background or similar areas.

Common, Convenient Features

Zooming In Closer on Subjects (Digital Zoom)

When distant subjects are too far away to enlarge using the optical zoom, use digital zoom for up to about 120x enlargement.

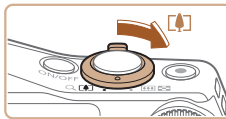

Zoom Factor



1 Move the zoom lever toward .

- Hold the lever until zooming stops.
- Zooming stops at the largest possible zoom factor (before the image becomes noticeably grainy), which is then indicated on the screen.

2 Move the zoom lever toward again.

- The camera zooms in even closer on the subject.



- Moving the zoom lever will display the zoom bar (which indicates the zoom position). The color of the zoom bar will change depending on the zoom range.
 - White range: optical zoom range where the image will not appear grainy.
 - Yellow range: digital zoom range where the image is not noticeably grainy (ZoomPlus).
 - Blue range: digital zoom range where the image will appear grainy. Because the blue range will not be available at some resolution settings (📖46), the maximum zoom factor can be achieved by following step 1.





- To deactivate digital zoom, choose MENU (📖24) > [📷] tab > [Digital Zoom] > [Off].

Still Images

Movies

Reacquiring Subjects Lost after Zooming (Framing Assist – Seek)

If you lose track of a subject while zooming in, you can find it more easily by temporarily zooming out.

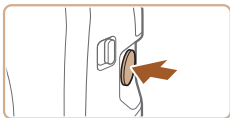

1 Look for the lost subject.

- Press and hold the <📷> button.
- The camera zooms out and displays a white frame around the area previously shown (before you pressed the <📷> button).



2 Reacquire the subject.

- Aim the camera so that the subject enters the white frame, and then release the <📷> button.
- The previous magnification is now restored, so that the area outlined in white fills the screen again.



- Some shooting information is not displayed while the camera is zoomed out.
- During movie shooting, the white frame is not displayed if you press the <📷> button. Also note that a changed zoom factor and camera operating sounds will be recorded.



- If you prefer to shoot at the zoom factor of the screen in step 1, press the shutter button all the way down.
- You can adjust the zoom factor that the camera will revert to after Zoom Framing Assist (when you release the <📷> button) by moving the zoom lever as you hold the <📷> button to resize the white frame.
- To adjust how much the camera zooms out when the <📷> button is pressed, access MENU (📖24) and choose one of the three levels in [📷] tab > [📷 Display Area].
- The zoom factor cannot be changed with the <📷> button after you press the shutter button all the way down in self-timer mode (📖37).

Still Images

Movies

Constantly Displaying Faces at the Same Size

When a person's face is detected (📖76), the camera will try to maintain a constant face size relative to the screen. If the person moves closer, the camera will automatically zoom out, and vice versa.

1 Determine the desired face size.

- Move the zoom lever as needed until the face is the desired size, relative to the screen.

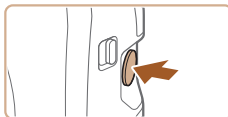

2 Enter [📷] Auto mode.

- Press and release the <📷> button quickly.
- [📷 Auto: On] is displayed.

Before Use

Basic Guide

Advanced Guide

Camera Basics

Auto Mode / Hybrid Auto Mode

Other Shooting Modes

P Mode

Tv, Av, and M Mode

Playback Mode

Wi-Fi Functions

Setting Menu

Accessories

Appendix

Index





3 Choose the face.

- Once faces are detected, [F] is displayed.
- If multiple faces are detected, press the <▲> button to switch to the desired subject.
- [F] is displayed around the face that the camera will continue to display at the same size.

4 Shoot.

- Even after you shoot, [F] remains around the face displayed at a constant size.
- To cancel constant face size display, press the <◀> button again. [F Auto: Off] is displayed.



- Faces may not be displayed at a constant size at some zoom factors, or if the subject's head is tilted or facing the camera indirectly.
- During movie recording, a changed zoom factor and camera operating sounds will be recorded.
- In [F] Auto mode, some shooting information is not displayed, and some shooting settings cannot be configured.



- If the person whose face is framed with [F] moves toward the edge of the screen, the camera zooms out to keep the person in view.
- In step 3, switching [F] to another face with the <▲> button is not possible during movie recording.
- The zoom factor will remain the same after you press the shutter button all the way down in self-timer mode ([37]), even if the relative face size changes.
- This feature is not activated even if you press the <◀> button when choosing MENU ([24]) > [CAM] tab > [F Auto] > [Off].

Easily Reacquiring Lost Subjects

If zooming in causes you to lose track of a subject, and you move the camera to look for them, the camera can automatically zoom out to help you find the subject.



1 Enter [F] Auto mode ([35]).

2 Look for the lost subject.

- When you move the camera to look for the subject, the camera zooms out to help you find them.

3 Reacquire the subject.

- Once you find the subject and stop moving the camera, the camera zooms in again.

4 Shoot.

- To cancel this mode, press the <◀> button again. [F Auto: Off] is displayed.



- Zooming is not possible while the shutter button is pressed halfway.

Still Images

Movies

Before Use

Basic Guide

Advanced Guide

Camera Basics

Auto Mode / Hybrid Auto Mode

Other Shooting Modes

P Mode

Tv, Av, and M Mode

Playback Mode

Wi-Fi Functions

Setting Menu

Accessories

Appendix

Index



Using the Self-Timer

With the self-timer, you can include yourself in group photos or other timed shots. The camera will shoot about 10 seconds after you press the shutter button.



1 Configure the setting.

- Press the <▼> button, choose [⌚] (either press the <◀><▶> buttons or turn the <⚙️> dial), and then press the <FUNC. SET> button.
- Once the setting is complete, [⌚] is displayed.

2 Shoot.

- For Still Images: Press the shutter button halfway to focus on the subject, and then press it all the way down.
- For Movies: Press the movie button.

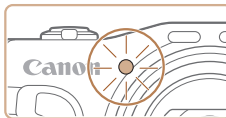

- Once you start the self-timer, the lamp will blink and the camera will play a self-timer sound.
- Two seconds before the shot, the blinking and sound will speed up. (The lamp will remain lit in case the flash fires.)
- To cancel shooting after you have triggered the self-timer, press the <MENU> button.
- To restore the original setting, choose [⌚] in step 1.

Using the Self-Timer to Avoid Camera Shake

This option delays shutter release until about two seconds after you have pressed the shutter button. If the camera is unsteady while you are pressing the shutter button, it will not affect your shot.



- Follow step 1 in “Using the Self-Timer” (📖37) and choose [⌚].
- Once the setting is complete, [⌚] is displayed.
- Follow step 2 in “Using the Self-Timer” (📖37) to shoot.



Customizing the Self-Timer

You can specify the delay (0 – 30 seconds) and number of shots (1 – 10).

1 Choose [C].

- Following step 1 in “Using the Self-Timer” (📖37), choose [C] and press the <MENU> button immediately.

2 Configure the setting.

- Press the <▲><▼> buttons to choose [Delay] or [Shots].
- Press the <◀><▶> buttons or turn the <DIAL> dial to choose a value, and then press the <FUNC.SET> button.
- Once the setting is complete, [C] is displayed.
- Follow step 2 in “Using the Self-Timer” (📖37) to shoot.



- For movies shot using the self-timer, [Delay] represents the delay before recording begins, but the [Shots] setting has no effect.

- When you specify multiple shots, image brightness and white balance are determined by the first shot. More time is required between shots when the flash fires or when you have specified to take many shots. Shooting will stop automatically when the memory card becomes full.
- When a delay longer than two seconds is specified, two seconds before the shot, the lamp blinking and self-timer sound will speed up. (The lamp will remain lit in case the flash fires.)

Adding a Date Stamp

The camera can add the shooting date to images, in the lower-right corner. However, note that date stamps cannot be edited or removed, so confirm beforehand that the date and time are correct (📖14).

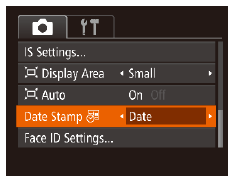
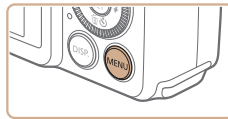

1 Configure the setting.

- Press the <MENU> button, choose [Date Stamp] on the [CAMERA] tab, and then choose the desired option (📖24).
- Once the setting is complete, [C] is displayed.

2 Shoot.

- As you take shots, the camera adds the shooting date or time to the lower-right corner of images.
- To restore the original setting, choose [Off] in step 1.

- Date stamps cannot be edited or removed.





- Shots taken without adding a date stamp can be printed with one as follows. However, adding a date stamp this way to images that already have one may cause it to be printed twice.
 - Print using printer functions (📖163)
 - Use camera DPOF print settings (📖167) to print
 - Use the software downloaded from the Canon website (📖160) to print

Still Images

Continuous Shooting

In [AUTO] mode, hold the shutter button all the way down to shoot continuously.

For details on the continuous shooting speed, see “Continuous Shooting Speed” (📖190).



1 Configure the setting.

- Press the <FUNC. SET> button, choose [A] in the menu, and then choose [] (📖23).
- Once the setting is complete, [] is displayed.



2 Shoot.

- Hold the shutter button all the way down to shoot continuously.



- During continuous shooting, focus and exposure are locked at the position/level determined when you pressed the shutter button halfway.
- Cannot be used with the self-timer (📖37).
- Shooting may stop momentarily or continuous shooting may slow down depending on shooting conditions, camera settings, and the zoom position.
- As more shots are taken, shooting may slow down.
- Shooting may slow down if the flash fires.
- Multi-area White Balance (📖29) is not available. Similarly, [Hg Lamp Corr.] (📖47) is set to [Off] and cannot be changed.

Before Use

Basic Guide

Advanced Guide

Camera Basics

Auto Mode / Hybrid Auto Mode

Other Shooting Modes

P Mode

Tv, Av, and M Mode

Playback Mode

Wi-Fi Functions

Setting Menu

Accessories

Appendix

Index



Using Face ID

If you register a person ahead of time, the camera will detect that person's face, and prioritize focus, brightness, and color for that person when shooting. In [AUTO] mode, the camera can detect babies and children based on registered birthdays and optimize settings for them when shooting. This function is also useful when searching for a specific registered person among a large number of images (📖93).

Personal Information

- Information such as images of a face (face info) registered with Face ID, and personal information (name, birthday) will be saved on the camera. Additionally, when registered people are detected, their names will be recorded in still images. When using the Face ID function, be careful when sharing the camera or images with others, and when posting images online where many others can view them.
- When disposing of a camera or transferring it to another person after using Face ID, be sure to erase all information (registered faces, names, and birthdays) from the camera (📖45).

Registering Face ID Information

You can register information (face info, names, birthdays) for up to 12 people to use with Face ID.

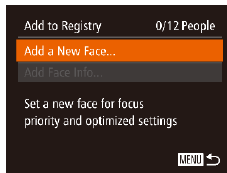
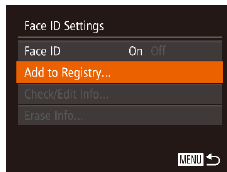
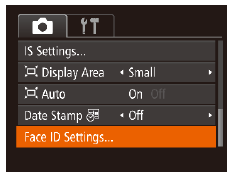

1 Access the setting screen.

- Press the <MENU> button, choose [Face ID Settings] on the [📷] tab, and then press the <FUNC SET> button (📖24).
- Press the <▲><▼> buttons or turn the <⚙> dial to choose [Add to Registry], and then press the <FUNC SET> button.
- Press the <▲><▼> buttons or turn the <⚙> dial to choose [Add a New Face], and then press the <FUNC SET> button.

Before Use

Basic Guide

Advanced Guide

Camera Basics

Auto Mode / Hybrid Auto Mode

Other Shooting Modes

P Mode

Tv, Av, and M Mode

Playback Mode

Wi-Fi Functions

Setting Menu

Accessories

Appendix

Index



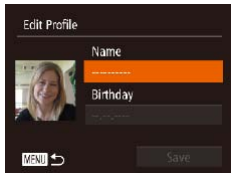

2 Register face information.

- Aim the camera so that the face of the person you want to register is inside the gray frame at the center of the screen.
- A white frame on the person's face indicates that the face is recognized. Make sure a white frame is displayed on the face, and then shoot.
- If the face is not recognized, you cannot register face information.
- After [Register?] is displayed, press the <◀><▶> buttons or turn the <⊙> dial to choose [OK], and then press the <FUNC SET> button.
- The [Edit Profile] screen is displayed.

3 Register the person's name and birthday.

- Press the <FUNC SET> button to access the keyboard, and then enter the name (📖25).

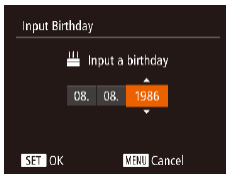

- To register a birthday, on the [Edit Profile] screen, choose [Birthday] (either press the <▲><▼> buttons or turn the <⊙> dial), and then press the <FUNC SET> button.
- Press the <◀><▶> buttons to choose an option.
- Press the <▲><▼> buttons or turn the <⊙> dial to specify the date.
- When finished, press the <FUNC SET> button.

Before Use

Basic Guide

Advanced Guide

Camera Basics

Auto Mode / Hybrid Auto Mode

Other Shooting Modes

P Mode

Tv, Av, and M Mode

Playback Mode

Wi-Fi Functions

Setting Menu

Accessories

Appendix

Index



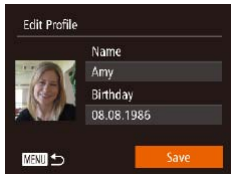

4 Save the settings.

- Press the <▲><▼> buttons or turn the <⊙> dial to choose [Save], and then press the <FUNC SET> button.
- After a message is displayed, press the <◀><▶> buttons or turn the <⊙> dial to choose [Yes], and then press the <FUNC SET> button.

5 Continue registering face information.

- To register up to 4 more points of face information (expressions or angles), repeat step 2.
- Registered faces are more easily recognized if you add a variety of face information. In addition to a head-on angle, add a slight side angle, a shot when smiling, and shots inside and outside.



- The flash will not fire when following step 2.
- If you do not register a birthday in step 3, Babies or Children icons (📖32) will not be displayed in [AUTO] mode.



- You can overwrite registered face info, and add face info later if you have not filled all 5 face info slots (📖44).



Shooting

If you register a person ahead of time, the camera will prioritize that person as the main subject, and optimize focus, brightness, and color for that person when shooting.



- When you point the camera toward a subject, the names of up to 3 registered people will be displayed when they are detected.
- Shoot.
- Displayed names will be recorded in still images. Even if people are detected, but their names are not displayed, the names (up to 5 people) will be recorded in the image.



- People other than those registered may be mistakenly detected as the registered person if they share similar facial features.

Before Use

Basic Guide

Advanced Guide

Camera Basics

Auto Mode / Hybrid Auto Mode

Other Shooting Modes

P Mode

Tv, Av, and M Mode

Playback Mode

Wi-Fi Functions

Setting Menu

Accessories

Appendix

Index





- Registered people may not be correctly detected if the captured image or scene differs drastically from the registered face information.
- If a registered face is not detected, or not easily detected, overwrite registered information with new face info. Registering face info right before shooting will allow for easier detection of registered faces.
- If a person is mistakenly detected as another person and you continue shooting, you can edit or erase the name recorded in the image during playback (📖95).
- Because faces of babies and children change quickly as they grow, you should update their face info regularly (📖44).
- When information display is set to off (📖23), names will not display, but will be recorded in the image.
- If you don't want names to be recorded in still images, choose [Face ID Settings] on the [📷] tab, choose [Face ID], and then choose [Off].
- You can check names recorded in images in the playback screen (simple information display) (📖90).
- In [📷] mode, names are not displayed on the shooting screen, but they will be recorded in still images.
- Names recorded in continuous shooting (📖39, 📖79) will continue to be recorded in the same position as for the first shot, even if subjects move.

Checking and Editing Registered Information

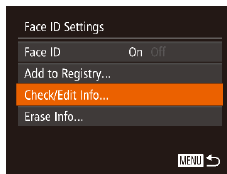

1 Access the [Check/Edit Info] screen.

- Following step 1 in "Registering Face ID Information" (📖40), choose [Check/Edit Info] and press the <FUNC SET> button.

2 Choose a person to check or edit.

- Press the <▲><▼><◀><▶> buttons or turn the <🔘> dial to choose the person to check or edit, and then press the <FUNC SET> button.

3 Check or edit the information as needed.

- To check a name or birthday, choose [Edit Profile] (either press the <▲><▼> buttons or turn the <🔘> dial), and then press the <FUNC SET> button. On the screen displayed, you can edit names or birthdays as described in step 3 of "Registering Face ID Information" (📖41).

Before Use

Basic Guide

Advanced Guide

Camera Basics

Auto Mode / Hybrid Auto Mode

Other Shooting Modes

P Mode

Tv, Av, and M Mode

Playback Mode

Wi-Fi Functions

Setting Menu

Accessories

Appendix

Index



- To check face information, choose [Face Info List] (either press the <▲><▼> buttons or turn the <⊙> dial), and then press the <FUNC SET> button. Press the <FUNC SET> button on the screen displayed, choose face information to erase by pressing the <▲><▼><◀><▶> buttons or turning the <⊙> dial, and then press the <FUNC SET> button. After [Erase?] is displayed, choose [OK] (either press the <◀><▶> buttons or turn the <⊙> dial), and then press the <FUNC SET> button.



- Even if you change names in [Edit Profile], the names recorded in previously shot images will remain the same.



- You can use the software (160) to edit registered names. Some characters entered with the software may not display on the camera, but will be correctly recorded in images.

Overwriting and Adding Face Information

You can overwrite existing face information with new face info. You should update face information regularly, especially with babies and children, as their faces change quickly as they grow.

You can also add face information when all 5 face info slots have not been filled.



1 Access the [Add Face Info] screen.

- Following step 1 in "Registering Face ID Information" (40), choose [Add Face Info] and press the <FUNC SET> button.

2 Choose the name of the person to overwrite.

- Press the <▲><▼><◀><▶> buttons or turn the <⊙> dial to choose the name of a person whose face info you want to overwrite, and then press the <FUNC SET> button.
- If five items of face info have already been registered, a message will be displayed. Choose [OK] (either press the <◀><▶> buttons or turn the <⊙> dial), and then press the <FUNC SET> button.
- If less than five items of face info are registered, go to step 4 to add face information.

Before Use

Basic Guide

Advanced Guide

Camera Basics

Auto Mode / Hybrid Auto Mode

Other Shooting Modes

P Mode

Tv, Av, and M Mode

Playback Mode

Wi-Fi Functions

Setting Menu

Accessories

Appendix

Index





3 Choose the face info to overwrite.

- Press the <▲><▼><◀><▶> buttons or turn the <⦿> dial to choose the face info to overwrite, and then press the <FUNC SET> button.



4 Register face information.

- Follow step 2 in “Registering Face ID Information” (📖41) to shoot, and then register the new face information.
- Registered faces are more easily recognized if you add a variety of face information. In addition to a head-on angle, add a slight side angle, a shot when smiling, and shots inside and outside.



- You cannot add face information if all 5 information slots are filled. Follow the steps above to overwrite face information.
- You can follow the above steps to register new face info when there is at least one slot open; however, you cannot overwrite any face information. Instead of overwriting face info, first erase unwanted existing info (📖43), and then register new face information (📖40) as needed.

Erasing Registered Information

You can erase information (face info, names, birthdays) registered to Face ID. However, names recorded in previously shot images will not be erased.

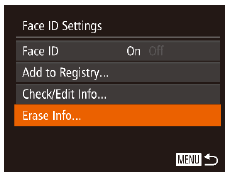

1 Access the [Erase Info] screen.

- Follow step 1 in “Registering Face ID Information” (📖40) and choose [Erase Info].

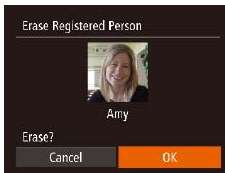

2 Choose the name of the person whose info you want to erase.

- Press the <▲><▼><◀><▶> buttons or turn the <⦿> dial to choose the name of a person to erase, and then press the <FUNC SET> button.
- After [Erase?] is displayed, press the <◀><▶> buttons or turn the <⦿> dial to choose [OK], and then press the <FUNC SET> button.



- If you erase a registered person's info, you will not be able to display their name (📖92), overwrite their info (📖95), or search images for them (📖93).



- You can also erase names in image information (📖95).

Before Use

Basic Guide

Advanced Guide

Camera Basics

Auto Mode / Hybrid Auto Mode

Other Shooting Modes

P Mode

Tv, Av, and M Mode

Playback Mode

Wi-Fi Functions

Setting Menu

Accessories

Appendix

Index



Image Customization Features

Still Images

Changing the Aspect Ratio

Change the image aspect ratio (ratio of width to height) as follows.



- Press the **<FUNC. SET>** button, choose **[4:3]** in the menu, and choose the desired option (📖23).
- Once the setting is complete, the screen aspect ratio will be updated.
- To restore the original setting, repeat this process but choose **[4:3]**.



| | |
|-------------|--|
| 16:9 | Used for display on widescreen HDTVs or similar display devices. |
| 3:2 | Same aspect ratio as 35mm film, used for printing images at 5 x 7-inch or postcard sizes. |
| 4:3 | Native aspect ratio of the camera screen, also used for display on standard-definition televisions or similar display devices, or for printing images at 3.5 x 5-inch or A-series sizes. |
| 1:1 | Square aspect ratio. |



- Not available in **[S]** mode.

Changing Image Resolution (Size)

Choose from 4 levels of image resolution, as follows. For guidelines on how many shots at each resolution setting can fit on a memory card, see “Number of 4:3 Shots per Memory Card” (📖190).



- Press the **<FUNC. SET>** button, choose **[L]** in the menu, and choose the desired option (📖23).
- The option you configured is now displayed.
- To restore the original setting, repeat this process but choose **[L]**.

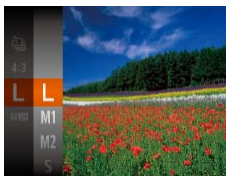

Guidelines for Choosing Resolution Based on Paper Size (for 4:3 Images)

| | |
|---|-----------|
| A2 (16.5 x 23.4 in.) | L |
| A3 – A5 (11.7 x 16.5 in.) – 5.8 x 8.3 in.) | M1 |
| 5 x 7 in. Postcard 3.5 x 5 in. | M2 |

- **[S]**: For e-mailing images.



- Not available in **[S]** mode.

Still Images

Before Use

Basic Guide

Advanced Guide

Camera Basics

Auto Mode / Hybrid Auto Mode

Other Shooting Modes

P Mode

Tv, Av, and M Mode

Playback Mode

Wi-Fi Functions

Setting Menu

Accessories

Appendix

Index



Red-Eye Correction

Red-eye that occurs in flash photography can be automatically corrected as follows.

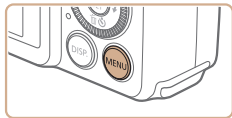

1 Access the [Flash Settings] screen.

- Press the <MENU> button, choose [Flash Settings] on the [CAMERA] tab, and then press the <DISP> button (📖24).

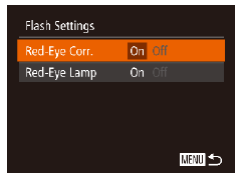
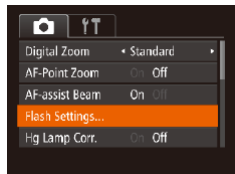

2 Configure the setting.

- Choose [Red-Eye Corr.], and then choose [On] (📖25).
- Once the setting is complete, [OK] is displayed.
- To restore the original setting, repeat this process but choose [Off].

- ⚠️ Red-eye correction may be applied to image areas other than eyes (if the camera misinterprets red eye makeup as red pupils, for example).

- ✎ You can also correct existing images (📖109).
- You can also access the screen in step 2 when the flash is up by pressing the <▶> button and immediately pressing the <MENU> button.

Correcting Greenish Image Areas from Mercury Lamps

In [AUTO] mode, subjects or background in shots of evening scenes illuminated by mercury lamps may appear to have a greenish tinge. This greenish tinge can be corrected automatically when shooting, using Multi-area White Balance.

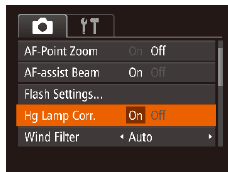
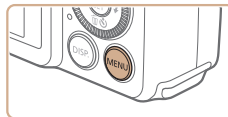

- Press the <MENU> button, choose [Hg Lamp Corr.] on the [CAMERA] tab, and then choose [On] (📖24).
- Once the setting is complete, [OK] is displayed.
- To restore the original setting, repeat this process but choose [Off].

- ⚠️ After you are finished shooting under mercury lamps, you should set [Hg Lamp Corr.] back to [Off]. Otherwise, green hues not caused by mercury lamps may be corrected by mistake.

- ✎ Try taking some test shots first to make sure you obtain the desired results.
- In continuous shooting (📖39), this setting is set to [Off] and cannot be changed.



Changing Movie Image Quality

4 image quality settings are available. For guidelines on the maximum movie length at each level of image quality that will fit on a memory card, see "Recording Time per Memory Card" (190).



- Press the **<FUNC. SET>** button, choose [**FHD 60P**] in the menu, and choose the desired option (23).
- The option you configured is now displayed.
- To restore the original setting, repeat this process but choose [**FHD 30P**].



| Image Quality | Resolution | Frame Rate | Details |
|----------------|-------------|------------|---|
| FHD 60P | 1920 x 1080 | 60 fps | For shooting in Full HD. [FHD 60P] enables movies with smoother motion |
| FHD 30P | 1920 x 1080 | 30 fps | |
| HD 30P | 1280 x 720 | 30 fps | For shooting in HD |
| VGA 30P | 640 x 480 | 30 fps | For shooting in standard definition |



- In [**FHD 60P**], [**FHD 30P**], and [**HD 30P**] modes, black bars displayed on the top and bottom edges of the screen indicate image areas not recorded.

Helpful Shooting Features

Displaying Grid Lines

Grid lines can be displayed on the screen for vertical and horizontal reference while shooting.

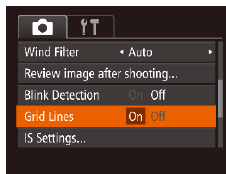
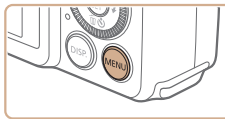

- Press the **<MENU>** button, choose [Grid Lines] on the [**Ⓛ**] tab, and then choose [On] (24).
- Once the setting is complete, grid lines are displayed on the screen.
- To restore the original setting, repeat this process but choose [Off].



- Grid lines are not recorded in your shots.



Magnifying the Area in Focus

You can check the focus by pressing the shutter button halfway, which will enlarge the portion of the image in focus in the AF frame.

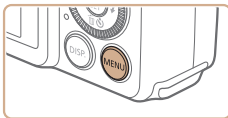

1 Configure the setting.

- Press the <MENU> button, choose [AF-Point Zoom] on the [CAMERA] tab, and then choose [On] (📖24).

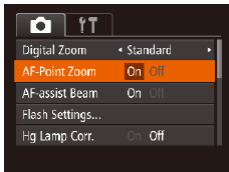

2 Check the focus.

- Press the shutter button halfway. The face detected as the main subject is now magnified.
- To restore the original setting, choose [Off] in step 1.



- The area in focus is not magnified in the following cases when the shutter button is pressed halfway.
 - If a face was not detected, if the person is too close to the camera and their face is too large for the screen, or if the camera detects subject movement
 - Digital zoom (📖34): Not magnified with this feature
 - Tracking AF (📖77): Not magnified with this feature
 - When using a TV as a display (📖157)
- Not available in [CAMERA] mode.

Checking for Closed Eyes

[👁] is displayed when the camera detects that people may have closed their eyes.

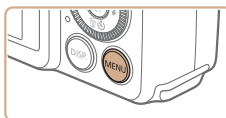

1 Configure the setting.

- Press the <MENU> button, choose [Blink Detection] on the [CAMERA] tab, and then choose [On] (📖24).

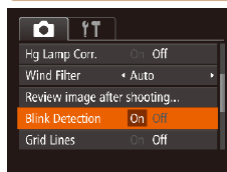

2 Shoot.

- [👁] flashes when the camera detects a person whose eyes are closed.
- To restore the original setting, choose [Off] in step 1.



- When you have specified multiple shots in [CAMERA] mode, this function is only available for the final shot.
- A frame is displayed around people whose eyes are closed when you have selected [2 sec.], [4 sec.], [8 sec.], or [Hold] in [Display Time] (📖51).
- This feature is not available during continuous shooting in [CAMERA] mode (📖33).
- This feature is not available in continuous shooting mode (📖39, 79).



Customizing Camera Operation

Customize shooting functions on the MENU [CAMERA] tab as follows. For instructions on menu functions, see “Using Menus” (24).

Deactivating the AF-Assist Beam

You can deactivate the lamp that normally lights up to help you focus when you press the shutter button halfway in low-light conditions.

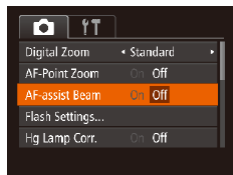

- Press the <MENU> button, choose [AF-assist Beam] on the [CAMERA] tab, and then choose [Off] (24).
- To restore the original setting, repeat this process but choose [On].

Still Images

Deactivating the Red-Eye Reduction Lamp

You can deactivate the red-eye reduction lamp that lights up to reduce red-eye when the flash is used in low-light shots.

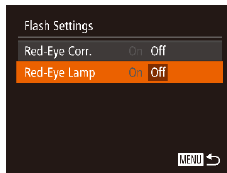

1 Access the [Flash Settings] screen.

- Press the <MENU> button, choose [Flash Settings] on the [CAMERA] tab, and then press the <FUNC/SET> button (24).

2 Configure the setting.

- Choose [Red-Eye Lamp], and then choose [Off] (25).
- To restore the original setting, repeat this process but choose [On].

Still Images

Before Use

Basic Guide

Advanced Guide

Camera Basics

Auto Mode / Hybrid Auto Mode

Other Shooting Modes

P Mode

Tv, Av, and M Mode

Playback Mode

Wi-Fi Functions

Setting Menu

Accessories

Appendix

Index



Changing the Image Display Style after Shots

You can change how long images are displayed and what information is displayed immediately after shooting.

Changing the Image Display Period after Shots

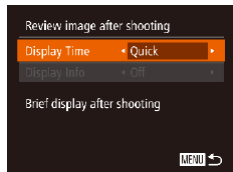

1 Access the [Review image after shooting] screen.

- Press the <MENU> button, choose [Review image after shooting] on the [CAMERA] tab, and then press the <FUNC SET> button (📖24).

2 Configure the setting.

- Press the <▲><▼> buttons or turn the <DISP> dial to choose [Display Time]. Press the <◀><▶> buttons to choose the desired option.
- To restore the original setting, repeat this process but choose [Quick].

| | |
|------------------------|---|
| Quick | Displays images only until you can shoot again. |
| 2 sec., 4 sec., 8 sec. | Displays images for the specified time. Even while the shot is displayed, you can take another shot by pressing the shutter button halfway again. |
| Hold | Displays images until you press the shutter button halfway. |
| Off | No image display after shots. |

Changing the Screen Displayed after Shots

Change the way images are displayed after shots as follows.

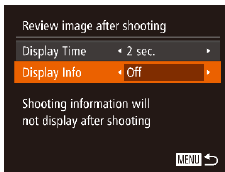

1 Set [Display Time] to [2 sec.], [4 sec.], [8 sec.], or [Hold] (📖51).

2 Configure the setting.

- Press the <▲><▼> buttons or turn the <DISP> dial to choose [Display Info]. Press the <◀><▶> buttons to choose the desired option.
- To restore the original setting, repeat this process but choose [Off].

| | |
|----------|-----------------------------------|
| Off | Displays only the image. |
| Detailed | Displays shooting details (📖179). |



- When [Display Time] (📖51) is set to [Off] or [Quick], [Display Info] is set to [Off] and cannot be changed.
- By pressing the <DISP> button while an image is displayed after shooting, you can switch the display information. Note that the settings of [Display Info] are not changed. By pressing the <FUNC SET> button, you can do the following operations.
 - Protect (📖98)
 - Favorites (📖105)
 - Erase (📖101)

Before Use

Basic Guide

Advanced Guide

Camera Basics

Auto Mode / Hybrid Auto Mode

Other Shooting Modes

P Mode

Tv, Av, and M Mode

Playback Mode

Wi-Fi Functions

Setting Menu

Accessories

Appendix

Index



Other Shooting Modes

Shoot more effectively in various scenes, and take shots enhanced with unique image effects or captured using special functions



| | |
|--|----|
| Enjoying a Variety of Images from Each Shot (Creative Shot)..... | 53 |
| Brightness / Color Customization (Live View Control) | 54 |
| Moving Subjects (Sports)..... | 54 |
| Specific Scenes..... | 55 |

| | |
|--|-----------|
| Image Effects (Creative Filters) | 57 |
| Shooting with a Fish-Eye Lens Effect (Fish-Eye Effect) | 58 |
| Shots Resembling Miniature Models (Miniature Effect) | 58 |
| Shooting with a Toy Camera Effect (Toy Camera Effect) | 59 |
| Shooting with a Soft Focus Effect | 60 |
| Shooting in Monochrome | 60 |
| Auto Shooting after Face Detection (Smart Shutter)..... | 61 |
| High-Speed Continuous Shooting (High-Speed Burst HQ) | 64 |

| | |
|---|-----------|
| Shooting Various Movies | 65 |
| Shooting Movies in [P] Mode | 65 |
| Shooting iFrame Movies | 66 |
| Shooting Super Slow Motion Movies | 66 |

Before Use

Basic Guide

Advanced Guide

Camera Basics

Auto Mode / Hybrid Auto Mode

Other Shooting Modes

P Mode

Tv, Av, and M Mode

Playback Mode

Wi-Fi Functions

Setting Menu

Accessories

Appendix

Index



Enjoying a Variety of Images from Each Shot (Creative Shot)

The camera determines the subject and shooting conditions, automatically applying special effects and recomposing the shot to emphasize the subject. Six still images are recorded for each shot. You can capture multiple still images with effects using camera-determined settings.



1 Enter [Creative Shot] mode.

- Set the mode dial to [Creative Shot].

2 Shoot.

- Press the shutter button all the way down. As you shoot, the shutter sound is played three times.
- After the six images are displayed in succession, they are displayed simultaneously for about two seconds.
- To keep the images displayed until you press the shutter button halfway, press the **[FUNC SET]** button. For full-screen display in this state, choose an image by pressing the **<▲>**, **<▼>**, **<◀>**, and **<▶>** buttons, and then press the **[FUNC SET]** button.
- To return to the original display, press the **<MENU>** button.



- Shooting will take some time when the flash fires, but hold the camera steady until the shutter sound is played three times.
- The six images are managed together as a group (p.55).
- Simultaneous display of the six images as shown in step 2 is only available immediately after you shoot.

Still Images

Choosing Effects

You can choose effects for images captured in [Creative Shot] mode.



- After choosing [Creative Shot] mode, press the **<DISP.>** button.
- Press the **<◀>** buttons or turn the **[MODE]** dial to choose the effect, and then press the **[FUNC SET]** button.

| | |
|------------|-----------------------------------|
| Auto | All effects |
| Retro | Images resemble old photos |
| Monochrome | Images are generated in one color |
| Special | Bold, distinctive-looking images |
| Natural | Subdued, natural-looking images |

Before Use

Basic Guide

Advanced Guide

Camera Basics

Auto Mode / Hybrid Auto Mode

Other Shooting Modes

P Mode

Tv, Av, and M Mode

Playback Mode

Wi-Fi Functions

Setting Menu

Accessories

Appendix

Index



Brightness / Color Customization (Live View Control)

Image brightness or colors when shooting can be easily customized as follows.



1 Enter [LIVE] mode.

- Set the mode dial to [LIVE].

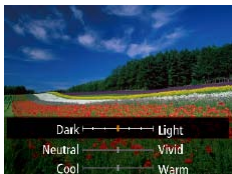

2 Configure the setting.

- Press the $\langle \text{FUNC SET} \rangle$ button to access the setting screen. Press the $\langle \blacktriangle \rangle \langle \blacktriangledown \rangle$ buttons to choose a setting item, and then press the $\langle \blacktriangle \rangle \langle \blacktriangledown \rangle$ buttons or turn the $\langle \text{DIAL} \rangle$ dial to adjust the value as you watch the screen.
- Press the $\langle \text{FUNC SET} \rangle$ button.

3 Shoot.

| | |
|------------|--|
| Brightness | For brighter images, adjust the level to the right, and for darker images, adjust it to the left. |
| Color | For more vivid images, adjust the level to the right, and for more subdued images, adjust it to the left. |
| Tone | For a warm, reddish tone, adjust the level to the right, and for a cool, bluish tone, adjust it to the left. |

Moving Subjects (Sports)

Shoot continuously as the camera focuses on moving subjects.

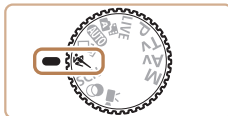

1 Enter [S&L] mode.

- Set the mode dial to [S&L].



2 Focus.

- While you are pressing the shutter button halfway, the camera will continue to adjust focus and image brightness where the blue frame is displayed.

3 Shoot.

- Hold the shutter button all the way down to shoot continuously.
- Shooting stops when you release the shutter button or reach the maximum number of shots, after which [Busy] is displayed and the shots are shown in the order you took them.



- Continuous shooting is not available in Auto mode (35).





- In [S] mode, shots may look grainy because the ISO speed (171) is increased to suit the shooting conditions.
- For details on the shooting range in [S] mode, see “Shooting Range” (190).
- There may be a delay after continuous shooting before you can shoot again. Note that some types of memory cards may delay your next shot even longer. SD Speed Class 6 or higher memory cards are recommended.
- Shooting may slow down depending on shooting conditions, camera settings, and the zoom position.

Image Display during Playback

Each set of images shot continuously is managed as a single group, and only the first image in that group will be displayed. To indicate that the image is part of a group, [SET] is displayed in the upper left of the screen.



- If you erase a grouped image (101), all images in the group are also erased. Be careful when erasing images.



- Grouped images can be played back individually (94) and ungrouped (94).
- Protecting (98) a grouped image will protect all images in the group.
- Grouped images can be viewed individually when played back using Image Search (93) or Smart Shuffle (97). In this case, images are temporarily ungrouped.
- The following actions are not available for grouped images: editing Face ID information (95), magnifying (96), rotating (104), tagging as favorites (105), editing (106 – 110), printing (163), adding to the print list (167), or adding to a photobook (169). To do these things, either view grouped images individually (94) or cancel grouping (94) first.

Specific Scenes

Choose a mode matching the shooting scene, and the camera will automatically configure the settings for optimal shots.

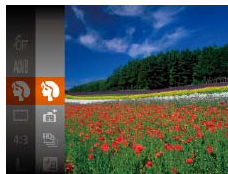

1 Enter [SCN] mode.

- Set the mode dial to [SCN].

2 Choose a shooting mode.

- Press the <FUNC/SET> button, choose [S] in the menu, and then choose a shooting mode (23).

3 Shoot.

Still Images

Movies

Shoot portraits (Portrait)

- Take shots of people with a softening effect.

Before Use

Basic Guide

Advanced Guide

Camera Basics

Auto Mode / Hybrid Auto Mode

Other Shooting Modes

P Mode

Tv, Av, and M Mode

Playback Mode

Wi-Fi Functions

Setting Menu

Accessories

Appendix

Index



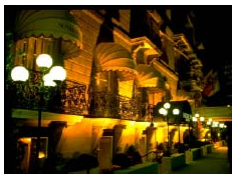

Still Images

Shoot evening scenes without using a tripod (Handheld NightScene)

- Beautiful shots of evening scenes or portraits with evening scenery in the background, without the need to hold the camera very still (as with a tripod).
- A single image is created by combining consecutive shots, reducing camera shake and image noise.



Still Images

Shoot under low light (Low Light)

- Shoot with minimal camera and subject shake even in low-light conditions.



Still Images

Movies

Shoot with snowy backgrounds (Snow)

- Bright, natural-colored shots of people against snowy backgrounds.









Still Images

Movies





Shoot fireworks (Fireworks)

- Vivid shots of fireworks.



- Subjects appear larger in  mode compared to other modes.
- In  mode, shots may look grainy because the ISO speed ( 71) is increased to suit the shooting conditions.
- Because the camera will shoot continuously in  mode, hold it steady while shooting.
- In  mode, excessive motion blur or certain shooting conditions may prevent you from obtaining the desired results.
- In  mode, mount the camera on a tripod or take other measures to keep it still and prevent camera shake. Additionally, you should set [IS Mode] to [Off] when using a tripod or other means to secure the camera ( 82).



- When you use a tripod for evening scenes, shooting in [AUTO] mode instead of  mode will give better results ( 28).
-  mode resolution is [M] (2304 x 1728) and cannot be changed.
- In  mode, although no frames are displayed when you press the shutter button halfway, optimal focus is still determined.

Before Use

Basic Guide

Advanced Guide

Camera Basics

Auto Mode / Hybrid Auto Mode

Other Shooting Modes

P Mode

Tv, Av, and M Mode

Playback Mode

Wi-Fi Functions

Setting Menu

Accessories

Appendix

Index



Image Effects (Creative Filters)

Add a variety of effects to images when shooting.



1 Enter [Creative Filter] mode.

- Set the mode dial to [Creative Filter].



2 Choose a shooting mode.

- Press the <FUNC/SET> button, choose [Creative Filter] in the menu, and then choose a shooting mode (see 23).

3 Shoot.



Still Images

Movies

Shoot in vivid colors (Super Vivid)

- Shots in rich, vivid colors.



Still Images

Movies

Posterized shots (Poster Effect)

- Shots that resemble an old poster or illustration.



- In [Creative Filter] and [Poster Effect] modes, try taking some test shots first, to make sure you obtain the desired results.

Before Use

Basic Guide

Advanced Guide

Camera Basics

Auto Mode / Hybrid Auto Mode

Other Shooting Modes

P Mode

Tv, Av, and M Mode

Playback Mode

Wi-Fi Functions

Setting Menu

Accessories

Appendix

Index



Shooting with a Fish-Eye Lens Effect (Fish-Eye Effect)

Shoot with the distorting effect of a fish-eye lens.

1 Choose [📷].

- Follow steps 1 – 2 in “Image Effects (Creative Filters)” (📖57) and choose [📷].

2 Choose an effect level.

- Press the <DISP.> button, choose an effect level (either press the <◀><▶> buttons or turn the <🔘> dial), and then press the <DISP.> button again.
- A preview is shown of how your shot will look with the effect applied.

3 Shoot.



- ! Try taking some test shots first, to make sure you obtain the desired results.

Shots Resembling Miniature Models (Miniature Effect)

Creates the effect of a miniature model, by blurring image areas above and below your selected area.

You can also make movies that look like scenes in miniature models by choosing the playback speed before the movie is recorded. People and objects in the scene will move quickly during playback. Note that sound is not recorded.

1 Choose [📷].

- Follow steps 1 – 2 in “Image Effects (Creative Filters)” (📖57) and choose [📷].
- A white frame is displayed, indicating the image area that will not be blurred.

2 Choose the area to keep in focus.

- Press the <DISP.> button.
- Move the zoom lever to resize the frame, and press the <▲><▼> buttons to move it.



3 For movies, choose the movie playback speed.

- Press the <MENU> button, and then choose the speed by pressing the <◀><▶> buttons or turning the <🔘> dial.



4 Return to the shooting screen and shoot.

- Press the <MENU> button to return to the shooting screen, and then shoot.

Playback Speed and Estimated Playback Time (for One-Minute Clips)

| Speed | Playback Time |
|-------|-----------------|
| 5x | Approx. 12 sec. |
| 10x | Approx. 6 sec. |
| 20x | Approx. 3 sec. |



- The zoom is not available when shooting movies. Be sure to set the zoom before shooting.
- Try taking some test shots first, to make sure you obtain the desired results.



- To switch the orientation of the frame (from horizontal to vertical or vice-versa), press the <⌂> button in step 2. You can move the frame in vertical orientation by pressing the <◀>> buttons.
- Holding the camera vertically will change the orientation of the frame.
- Movie image quality is [EVC] at an aspect ratio of [4:3] and [EHD] at an aspect ratio of [16:9] (46). These quality settings cannot be changed.
- The zoom factor cannot be changed with the <ZOOM> button on the screens in steps 2 and 3, or while shooting movies.

Shooting with a Toy Camera Effect (Toy Camera Effect)

This effect makes images resemble shots from a toy camera by vignetting (darker, blurred image corners) and changing the overall color.



1 Choose [☒].

- Follow steps 1 – 2 in “Image Effects (Creative Filters)” (57) and choose [☒].

2 Choose a color tone.

- Press the <DISP.> button, choose a color tone (either press the <◀>> buttons or turn the <⦿> dial), and then press the <DISP.> button again.
- A preview is shown of how your shot will look with the effect applied.

3 Shoot.

| | |
|----------|---|
| Standard | Shots resemble toy camera images. |
| Warm | Images have a warmer tone than with [Standard]. |
| Cool | Images have a cooler tone than with [Standard]. |



- Try taking some test shots first, to make sure you obtain the desired results.



Shooting with a Soft Focus Effect

This function allows you to shoot images as if a soft focus filter were attached to the camera. You can adjust the effect level as desired.

1 Choose [👤].

- Follow steps 1 – 2 in “Image Effects (Creative Filters)” (📖57) and choose [👤].

2 Choose an effect level.

- Press the <DISP.> button, choose an effect level (either press the <<>> buttons or turn the <⊙> dial), and then press the <DISP.> button again.
- A preview is shown of how your shot will look with the effect applied.

3 Shoot.



- Try taking some test shots first, to make sure you obtain the desired results.

Shooting in Monochrome

Shoot images in black and white, sepia, or blue and white.

1 Choose [📷].

- Follow steps 1 – 2 in “Image Effects (Creative Filters)” (📖57) and choose [📷].

2 Choose a color tone.

- Press the <DISP.> button, choose a color tone (either press the <<>> buttons or turn the <⊙> dial), and then press the <DISP.> button again.
- A preview is shown of how your shot will look with the effect applied.

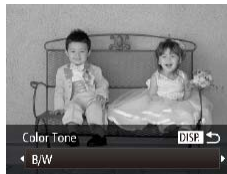

3 Shoot.

| | |
|-------|------------------------|
| B/W | Black and white shots. |
| Sepia | Sepia tone shots. |
| Blue | Blue and white shots. |



Auto Shooting after Face Detection (Smart Shutter)

Auto Shooting after Smile Detection

The camera shoots automatically after detecting a smile, even without you pressing the shutter button.



1 Choose [Smile].

- Follow steps 1 – 2 in “Specific Scenes” (p.55) and choose [Smile], and then press the <DISP.> button.
- Press the <Left><Right> buttons or turn the <Dial> dial to choose [Smile], and then press the <DISP.> button.
- The camera now enters shooting standby mode, and [Smile Detection on] is displayed.

2 Aim the camera at a person.

- Each time the camera detects a smile, it will shoot after the lamp lights up.
- To pause smile detection, press the <Down> button. Press the <Down> button again to resume detection.



- Switch to another mode when you finish shooting, or the camera will continue shooting each time a smile is detected.



- You can also shoot as usual by pressing the shutter button.
- The camera can detect smiles more easily when subjects face the camera and open their mouth wide enough so that teeth are visible.
- To change the number of shots, press the <Up><Down> buttons after choosing [Smile] in step 1. [Blink Detection] (p.49) is only available for the final shot.
- Automatic shooting is not available while you are holding down the <Right> button.

Before Use

Basic Guide

Advanced Guide

Camera Basics

Auto Mode / Hybrid Auto Mode

Other Shooting Modes

P Mode

Tv, Av, and M Mode

Playback Mode

Wi-Fi Functions

Setting Menu

Accessories

Appendix

Index



Using the Wink Self-Timer

Aim the camera at a person and press the shutter button all the way down. The camera will shoot about two seconds after a wink is detected.



1 Choose [WINK].

- Follow steps 1 – 2 in “Specific Scenes” (M55) and choose [WINK], and then press the <DISP.> button.
- Press the <<|>> buttons or turn the <DISP.> dial to choose [WINK], and then press the <DISP.> button.

2 Compose the shot and press the shutter button halfway.

- Make sure a green frame is displayed around the face of the person who will wink.

3 Press the shutter button all the way down.

- The camera now enters shooting standby mode, and [Wink to take picture] is displayed.
- The lamp blinks and the self-timer sound is played.



4 Face the camera and wink.

- The camera will shoot about two seconds after detecting a wink by the person whose face is inside the frame.
- To cancel shooting after you have triggered the self-timer, press the <MENU> button.



- If the wink is not detected, wink again slowly and deliberately.
- Winking may not be detected if eyes are obscured by hair, a hat, or glasses.
- Closing and opening both eyes at once will also be detected as a wink.
- If winking is not detected, the camera will shoot about 15 seconds later.
- To change the number of shots, press the <▲><▼> buttons after choosing [WINK] in step 1. [Blink Detection] (M49) is only available for the final shot.
- If no one is in the shooting area when the shutter button is pressed all the way down, the camera will shoot after a person enters the shooting area and winks.
- The zoom factor cannot be changed with the <ZOOM> button after you press the shutter button all the way down.

Before Use

Basic Guide

Advanced Guide

Camera Basics

Auto Mode / Hybrid Auto Mode

Other Shooting Modes

P Mode

Tv, Av, and M Mode

Playback Mode

Wi-Fi Functions

Setting Menu

Accessories

Appendix

Index





Using the Face Self-Timer

The camera will shoot about two seconds after detecting that the face of another person (such as the photographer) has entered the shooting area (📖76). This is useful when including yourself in group photos or similar shots.



1 Choose [👤].

- Follow steps 1 – 2 in “Specific Scenes” (📖55) and choose [👤], and then press the <DISP.> button.
- Press the <<>> buttons or turn the <⚙️> dial to choose [👤], and then press the <DISP.> button.

2 Compose the shot and press the shutter button halfway.

- Make sure a green frame is displayed around the face you focus on and white frames around other faces.

3 Press the shutter button all the way down.

- The camera now enters shooting standby mode, and [Look straight at camera to start count down] is displayed.
- The lamp blinks and the self-timer sound is played.

4 Join the subjects in the shooting area and look at the camera.

- After the camera detects a new face, the lamp blinking and self-timer sound will speed up. (When the flash fires, the lamp will remain lit.) About two seconds later, the camera will shoot.
- To cancel shooting after you have triggered the self-timer, press the <MENU> button.



- Even if your face is not detected after you join the others in the shooting area, the camera will shoot about 15 seconds later.
- To change the number of shots, press the <▲><▼> buttons after choosing [👤] in step 1. [Blink Detection] (📖49) is only available for the final shot.
- The zoom factor cannot be changed with the <□> button after you press the shutter button all the way down.

Before Use

Basic Guide

Advanced Guide

Camera Basics

Auto Mode / Hybrid Auto Mode

Other Shooting Modes

P Mode

Tv, Av, and M Mode

Playback Mode

Wi-Fi Functions

Setting Menu

Accessories

Appendix

Index



High-Speed Continuous Shooting (High-Speed Burst HQ)

You can shoot a series of shots in rapid succession by holding the shutter button all the way down. For details on the continuous shooting speed, see “Continuous Shooting Speed” (📖190).



1 Choose [HQ].

- Follow steps 1 – 2 in “Specific Scenes” (📖55) and choose [HQ].

2 Shoot.

- Hold the shutter button all the way down to shoot continuously.
- Shooting stops when you release the shutter button or reach the maximum number of shots, after which [Busy] is displayed and the shots are shown in the order you took them.
- Each set of images shot continuously is managed as a single group, and only the first image in that group will be displayed (📖55).



- The drive mode is [📷] in 📷 Auto mode (📖35) and cannot be changed.



- HQ: High Quality
- Focus, image brightness, and color are determined by the first shot.
- The screen is blank while you are shooting.
- There may be a delay after continuous shooting before you can shoot again. Note that some types of memory cards may delay your next shot even longer. SD Speed Class 6 or higher memory cards are recommended.
- Shooting may slow down depending on shooting conditions, camera settings, and the zoom position.

Before Use

Basic Guide

Advanced Guide

Camera Basics

Auto Mode / Hybrid Auto Mode

Other Shooting Modes

P Mode

Tv, Av, and M Mode

Playback Mode

Wi-Fi Functions

Setting Menu

Accessories

Appendix

Index



Shooting Various Movies

Shooting Movies in [M] Mode



1 Enter [M] mode.

- Set the mode dial to [M].
- Black bars are displayed on the top and bottom edges of the screen, and the subject is slightly enlarged. The black bars indicate image areas not recorded.

2 Configure the settings to suit the movie (📖180 – 183).

3 Shoot.

- Press the movie button.
- To stop movie recording, press the movie button again.

Locking or Changing Image Brightness before Shooting

Before shooting, you can lock the exposure or change it in 1/3-stop increments within a range of -2 to +2.



1 Lock the exposure.

- Press the <▲> button to lock the exposure. The exposure shift bar is displayed.
- To unlock the exposure, press the <▲> button again.

2 Adjust the exposure.

- Turn the <⦿> dial to adjust the exposure, as you watch the screen.

3 Shoot (📖65).



Shooting iFrame Movies

Shoot movies that can be edited with iFrame-compatible software or devices. You can quickly edit, save, and manage your iFrame movies using the software (📖160).

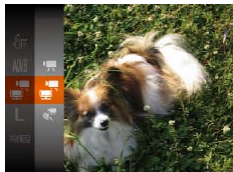

1 Choose [📷].

- Set the mode dial to <📷>.
- Press the <FUNC/SET> button, choose [📷] in the menu, and then choose [📷] (📖23).
- Black bars displayed on the top and bottom edges of the screen indicate image areas not recorded.

2 Shoot (📖65).



- The resolution is [4K UHD 30P] (📖48) and cannot be changed.
- iFrame is a video format developed by Apple Inc.

Shooting Super Slow Motion Movies

You can shoot fast-moving subjects for playback later in slow motion. Note that sound is not recorded.

1 Choose [📷].

- Set the mode dial to [📷].
- Press the <FUNC/SET> button, choose [📷] in the menu, and then choose [📷] (📖23).

2 Choose a frame rate.

- Press the <FUNC/SET> button, choose [1080 240P] in the menu, and choose the desired frame rate (📖23).
- The option you configured is now displayed.

3 Shoot (📖65).

- A bar showing the elapsed time is displayed. Maximum clip length is approx. 30 sec.



| Frame Rate | Image Quality | Playback Time (For a 30-sec. Clip) |
|---------------------|-------------------------|---------------------------------------|
| 240P 240 fps | QVGA (320 x 240) | Approx. 4 min. |
| 120P 120 fps | VGA (640 x 480) | Approx. 2 min. |



- Zooming is not available during recording, even if you move the zoom lever.
- Focus, exposure, and color are determined when you press the movie button.



- When you play the movie (📖89), it will be played back in slow motion.
- You can change the playback speed of movies by using the software (📖160).

Before Use

Basic Guide

Advanced Guide

Camera Basics

Auto Mode / Hybrid
Auto Mode

Other Shooting
Modes

P Mode

Tv, Av, and M Mode

Playback Mode

Wi-Fi Functions

Setting Menu

Accessories

Appendix

Index



P Mode

More discerning shots, in your preferred shooting style



- Instructions in this chapter apply to the camera with the mode dial set to **[P]** mode.
- **[P]**: Program AE; AE: Auto Exposure
- Before using a function introduced in this chapter in modes other than **[P]**, make sure the function is available in that mode (📖180 – 183).

| | | | | | |
|--|-----------|---|-----------|-------------------------------------|-----------|
| Shooting in Program AE ([P] Mode) | 69 | Shooting Range and Focusing | 74 | Other Settings | 82 |
| Image Brightness (Exposure) | 69 | Shooting Close-Ups (Macro)..... | 74 | Changing the Compression Ratio | |
| Adjusting Image Brightness | | Shooting in Manual Focus Mode..... | 74 | (Image Quality)..... | 82 |
| (Exposure Compensation) | 69 | Digital Tele-Converter..... | 75 | Changing the IS Mode Settings | 82 |
| Locking Image Brightness / | | Changing the AF Frame Mode..... | 76 | | |
| Exposure (AE Lock) | 70 | Changing the Focus Setting..... | 78 | | |
| Changing the Metering Method..... | 70 | Shooting with the AF Lock..... | 79 | | |
| Changing the ISO Speed | 71 | Shooting Continuously as the Camera Keeps | | | |
| Correcting Image Brightness (i-Contrast)..... | 71 | the Subject in Focus..... | 79 | | |
| Image Colors | 72 | Flash..... | 80 | | |
| Adjusting White Balance | 72 | Changing the Flash Mode | 80 | | |
| Changing Image Color Tones (My Colors) | 73 | Adjusting the Flash Exposure Compensation | 81 | | |
| | | Shooting with the FE Lock | 81 | | |

| |
|------------------------------|
| Before Use |
| Basic Guide |
| Advanced Guide |
| Camera Basics |
| Auto Mode / Hybrid Auto Mode |
| Other Shooting Modes |
| P Mode |
| Tv, Av, and M Mode |
| Playback Mode |
| Wi-Fi Functions |
| Setting Menu |
| Accessories |
| Appendix |
| Index |



Shooting in Program AE ([P] Mode)

You can customize many function settings to suit your preferred shooting style.



1 Enter [P] mode.

- Set the mode dial to [P].

2 Customize the settings as desired (📖 69 – 83), and then shoot.



- If adequate exposure cannot be obtained when you press the shutter button halfway, shutter speeds and aperture values are displayed in orange. In this case, try adjusting the ISO speed (📖 71) or activating the flash (if subjects are dark, 📖 80), which may enable adequate exposure.
- Movies can be recorded in [P] mode as well, by pressing the movie button. However, some FUNC. (📖 23) and MENU (📖 24) settings may be automatically adjusted for movie recording.
- For details on the shooting range in [P] mode, see “Shooting Range” (📖 190).

Image Brightness (Exposure)

Adjusting Image Brightness (Exposure Compensation)

The standard exposure set by the camera can be adjusted in 1/3-stop increments, in a range of -2 to +2.



- Press the <▲> button. As you watch the screen, turn the <⊙> dial to adjust brightness, and then press the <▲> button again when finished.
- The correction level you specified is now displayed.

Before Use

Basic Guide

Advanced Guide

Camera Basics

Auto Mode / Hybrid Auto Mode

Other Shooting Modes

P Mode

Tv, Av, and M Mode

Playback Mode

Wi-Fi Functions

Setting Menu

Accessories

Appendix

Index



Locking Image Brightness / Exposure (AE Lock)

Before shooting, you can lock the exposure, or you can specify focus and exposure separately.



1 Lock the exposure.

- Aim the camera at the subject to shoot with the exposure locked. With the shutter button pressed halfway, press the <▲> button.
- [✳] is displayed, and the exposure is locked.
- To unlock AE, release the shutter button and press the <▲> button again. In this case, [✳] is no longer displayed.

2 Compose the shot and shoot.

- After one shot, AE is unlocked and [✳] is no longer displayed.



- AE: Auto Exposure
- After the exposure is locked, you can adjust the combination of shutter speed and aperture value by turning the <⦿> dial (Program Shift).

Changing the Metering Method

Adjust the metering method (how brightness is measured) to suit shooting conditions as follows.



- Press the <P/ABC SET> button, choose [⦿] in the menu, and choose the desired option (23).
- The option you configured is now displayed.

| | |
|----------------------|---|
| Evaluative | For typical shooting conditions, including backlit shots. Automatically adjusts exposure to match the shooting conditions. |
| Center Weighted Avg. | Determines the average brightness of light across the entire image area, calculated by treating brightness in the central area as more important. |
| Spot | Metering restricted to within the [] (Spot AE Point frame), displayed in the center of the screen. |



Changing the ISO Speed

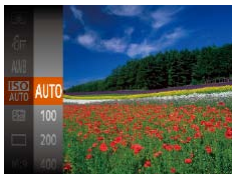

- Press the button, choose [ISO] in the menu, and choose the desired option (23).
- The option you configured is now displayed.

| | | |
|------------|---|--|
| AUTO | Automatically adjusts the ISO speed to suit the shooting mode and conditions. | |
| 100, 200 | Low | For shooting outdoors in fair weather. |
| 400, 800 | ↑ ↓ | For shooting in cloudy conditions, or at twilight. |
| 1600, 3200 | High | For shooting night scenes, or in dark rooms. |



- To view the automatically determined ISO speed when you have set the ISO speed to [AUTO], press the shutter button halfway.
- Although choosing a lower ISO speed may reduce image graininess, there may be a greater risk of subject and camera shake in some shooting conditions.
- Choosing a higher ISO speed will increase shutter speed, which may reduce subject and camera shake and increase the flash range. However, shots may look grainy.

Correcting Image Brightness (i-Contrast)

Before shooting, excessively bright or dark image areas (such as faces or backgrounds) can be detected and automatically adjusted to the optimal brightness. Insufficient overall image contrast can also be automatically corrected before shooting to make subjects stand out better.



- Press the <MENU> button, choose [i-Contrast] on the tab, and then choose [Auto] (24).
- Once the setting is complete, is displayed.



- Under some shooting conditions, correction may be inaccurate or may cause images to appear grainy.



- You can also correct existing images (109).



Adjusting White Balance

By adjusting white balance (WB), you can make image colors look more natural for the scene you are shooting.

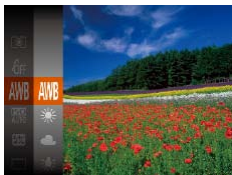

- Press the **<FUNC/SET>** button, choose **[AWB]** in the menu, and choose the desired option (📖23).
- The option you configured is now displayed.

| | | |
|--|---------------|--|
| | Auto | Automatically sets the optimal white balance for the shooting conditions. |
| | Day Light | For shooting outdoors in fair weather. |
| | Cloudy | For shooting in cloudy conditions, in the shade, or at twilight. |
| | Tungsten | For shooting under ordinary incandescent (tungsten) lighting and similarly colored fluorescent lighting. |
| | Fluorescent | For shooting under warm-white (or similarly colored) or cool-white fluorescent lighting. |
| | Fluorescent H | For shooting under daylight fluorescent and similarly colored fluorescent lighting. |
| | Custom | For manually setting a custom white balance (📖72). |

Custom White Balance

For image colors that look natural under the light in your shot, adjust white balance to suit the light source where you are shooting. Set the white balance under the same light source that will illuminate your shot.



- Follow the steps in “Adjusting White Balance” (📖72) to choose **[CUSTOM]**.
- Aim the camera at a plain white subject, so that the entire screen is white. Press the **<DISP.>** button.
- The tint of the screen changes once the white balance data has been recorded.

- ⚠️
- Colors may look unnatural if you change camera settings after recording white balance data.



Changing Image Color Tones (My Colors)

Change image color tones as desired, such as converting images to sepia or black and white.



- Press the button, choose in the menu, and choose the desired option (23).
- The option you configured is now displayed.

| | |
|-------------------|--|
| My Colors Off | — |
| Vivid | Emphasizes contrast and color saturation, making images sharper. |
| Neutral | Tones down contrast and color saturation for subdued images. |
| Sepia | Creates sepia tone images. |
| B/W | Creates black and white images. |
| Positive Film | Combines the effects of Vivid Blue, Vivid Green, and Vivid Red to produce intense yet natural-looking colors resembling images on positive film. |
| Lighter Skin Tone | Lightens skin tones. |
| Darker Skin Tone | Darkens skin tones. |
| Vivid Blue | Emphasizes blues in images. Makes the sky, ocean, and other blue subjects more vivid. |
| Vivid Green | Emphasizes greens in images. Makes mountains, foliage, and other green subjects more vivid. |
| Vivid Red | Emphasizes reds in images. Makes red subjects more vivid. |

Custom Color

Adjust contrast, sharpness, color saturation, and other qualities as desired (73).



- White balance (72) cannot be set in or modes.
- With and modes, colors other than people's skin tone may change. These settings may not produce the expected results with some skin tones.

Custom Color

Choose the desired level of image contrast, sharpness, color saturation, red, green, blue, and skin tones in a range of 1 – 5.



1 Access the setting screen.

- Follow the steps in “Changing Image Color Tones (My Colors)” (73) to choose , and then press the button.

2 Configure the setting.

- Press the < buttons to choose an option, and then specify the value by pressing the < buttons or turning the dial.
- For stronger/more intense effects (or darker skin tones), adjust the value to the right, and for weaker/lighter effects (or lighter skin tones), adjust the value to the left.
- Press the button to complete the setting.



Shooting Range and Focusing

Still Images

Shooting Close-Ups (Macro)

To restrict the focus to subjects at close range, set the camera to [MF]. For details on the focusing range, see "Shooting Range" (190).

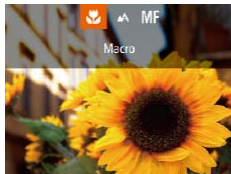

- Press the <◀▶> button, choose [MF] (either press the <◀▶> buttons or turn the <⚙> dial), and then press the <FUNC SET> button.
- Once the setting is complete, [MF] is displayed.



- If the flash fires, vignetting may occur.
- In the yellow bar display area below the zoom bar, [MF] will turn gray and the camera will not focus.



- To prevent camera shake, try mounting the camera on a tripod and shooting with the camera set to [MF] (37).

Shooting in Manual Focus Mode

Still Images

Movies

When focusing is not possible in AF mode, use manual focus. You can specify the general focal position and then press the shutter button halfway to have the camera determine the optimal focal position near the position you specified. For details on the focusing range, see "Shooting Range" (190).



MF Indicator

1 Choose [MF].

- Press the <◀▶> button, choose [MF] (either press the <◀▶> buttons or turn the <⚙> dial), and then press the <FUNC SET> button.
- [MF] and the MF indicator are displayed.

2 Specify the general focal position.

- Referring to the on-screen MF indicator bar (which shows the distance and focal position) and the magnified display area, press the <▲><▼> buttons or turn the <⚙> dial to specify the general focal position, and then press the <FUNC SET> button.
- To adjust the magnification, press the <▶> button.

3 Fine-tune the focus.

- Press the shutter button halfway to have the camera fine-tune the focal position (Safety MF).

Before Use

Basic Guide

Advanced Guide

Camera Basics

Auto Mode / Hybrid Auto Mode

Other Shooting Modes

P Mode

Tv, Av, and M Mode

Playback Mode

Wi-Fi Functions

Setting Menu

Accessories

Appendix

Index





- When you focus manually, the AF frame mode (📖76) is [Center] and AF frame size (📖76) is [Normal], and these settings cannot be changed.
- Focusing is possible when using the digital zoom (📖34) or digital tele-converter (📖75), or when using a TV as a display (📖159), but the magnified display will not appear.



- To focus more accurately, try attaching the camera to a tripod to stabilize it.
- To hide the magnified display area, choose MENU (📖24) > [📷] tab > [MF-Point Zoom] > [Off].
- To deactivate automatic focus fine-tuning when the shutter button is pressed halfway, choose MENU (📖24) > [📷] tab > [Safety MF] > [Off].

Still Images

Easily Identifying the Focus Area (MF Peaking)

Edges of subjects in focus are displayed in color to make manual focusing easier. You can adjust the colors and the sensitivity (level) of edge detection as needed.

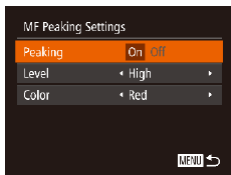

1 Access the setting screen.

- Press the <MENU> button, choose [MF Peaking Settings] on the [📷] tab, and then choose [On] (📖24).

2 Configure the setting.

- Choose a menu item to configure, and then choose the desired option (📖25).



- Colors displayed for MF peaking are not recorded in your shots.

Still Images

Movies

Digital Tele-Converter

The focal length of the lens can be increased by approximately 1.6x or 2.0x. This can reduce camera shake because the shutter speed is faster than it would be if you zoomed (including using digital zoom) in to the same zoom factor.

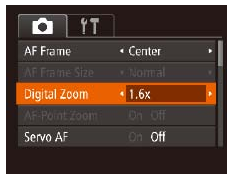

- Press the <MENU> button, choose [Digital Zoom] on the [📷] tab, and then choose the desired option (📖24).
- The view is enlarged and the zoom factor is displayed on the screen.



- The digital tele-converter cannot be used with digital zoom (📖34) or AF-point zoom (📖49).



- The shutter speed may be equivalent when you move the zoom lever all the way toward <[T]> for maximum telephoto, and when you zoom in to enlarge the subject to the same size following step 2 in “Zooming In Closer on Subjects (Digital Zoom)” (📖34).

Before Use

Basic Guide

Advanced Guide

Camera Basics

Auto Mode / Hybrid Auto Mode

Other Shooting Modes

P Mode

Tv, Av, and M Mode

Playback Mode

Wi-Fi Functions

Setting Menu

Accessories

Appendix

Index



Changing the AF Frame Mode

Change the AF (auto focus) frame mode to suit the shooting conditions as follows.

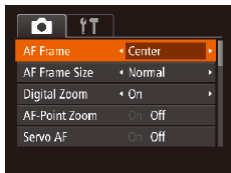

- Press the <MENU> button, choose [AF Frame] on the [CAMERA] tab, and then choose the desired option (📖24).

Center

One AF frame is displayed in the center. Effective for reliable focusing.



- A yellow AF frame is displayed with [!] if the camera cannot focus when you press the shutter button halfway.



- To reduce the AF frame size, press the <MENU> button and set [AF Frame Size] on the [CAMERA] tab to [Small] (📖24).
- The AF frame size is set to [Normal] when you use the digital zoom (📖34) or digital tele-converter (📖75), and in manual focus mode (📖74).
- To compose shots so that subjects are positioned at the edge or in a corner, first aim the camera to capture the subject in an AF frame, and then hold the shutter button halfway down. As you continue to hold the shutter button halfway, recompose the shot as desired, and then press the shutter button all the way down (Focus Lock).
- The AF frame position is enlarged when you press the shutter button halfway and [AF-Point Zoom] (📖49) is set to [On].

Face AiAF

- Detects people's faces, and then sets the focus, exposure (evaluative metering only), and white balance ([RAW] only).
- After you aim the camera at the subject, a white frame is displayed around the person's face determined by the camera to be the main subject, and up to two gray frames are displayed around other detected faces.
- When the camera detects subject movement, frames will follow moving subjects, within a certain range.
- After you press the shutter button halfway, up to nine green frames are displayed around faces in focus.



- If faces are not detected, or when only gray frames are displayed (without a white frame), up to nine green frames are displayed in the areas in focus when you press the shutter button halfway.
- If faces are not detected when Servo AF (📖78) is set to [On], the AF frame is displayed in the center of the screen when you press the shutter button halfway.
- Examples of faces that cannot be detected:
 - Subjects that are distant or extremely close
 - Subjects that are dark or light
 - Faces in profile, at an angle, or partly hidden
- The camera may misinterpret non-human subjects as faces.
- No AF frames are displayed if the camera cannot focus when you press the shutter button halfway.



Choosing Subjects to Focus On (Tracking AF)

Shoot after choosing a subject to focus on as follows.

1 Choose [Tracking AF].

- Follow the steps in “Changing the AF Frame Mode” (📖76) to choose [Tracking AF].
- [☐] is displayed in the center of the screen.



2 Choose a subject to focus on.

- Aim the camera so that [☐] is on the desired subject, and then press the <◀▶> button.
- When the subject is detected, the camera beeps and [☐] is displayed. Even if the subject moves, the camera will continue to track the subject within a certain range.
- If no subject is detected, [☐] is displayed.
- To cancel tracking, press the <◀▶> button again.



3 Shoot.

- Press the shutter button halfway. [☐] changes to a blue [☐], which follows the subject as the camera continues to adjust the focus and exposure (Servo AF) (📖78).
- Press the shutter button all the way down to shoot.
- Even after your shot, [☐] is still displayed and the camera continues to track the subject.



- [Servo AF] (📖78) is set to [On] and cannot be changed.
- Tracking may not be possible when subjects are too small or move too rapidly, or when subject color or brightness matches that of the background too closely.
- [AF-Point Zoom] on the [📷] tab is not available.
- [👤] is not available.



- The camera can detect subjects even if you press the shutter button halfway without pressing the <◀▶> button. After your shot, [☐] is displayed in the center of the screen.
- When shooting in [MF] mode (📖74), press and hold the <◀▶> button for at least one second.
- If [Face ID] is set to [On], names will not display when registered people are detected, but the names will be recorded in the still images (📖40). However, a name will display if the subject chosen to focus on is the same as a person detected with Face ID.

Before Use

Basic Guide

Advanced Guide

Camera Basics

Auto Mode / Hybrid Auto Mode

Other Shooting Modes

P Mode

Tv, Av, and M Mode

Playback Mode

Wi-Fi Functions

Setting Menu

Accessories

Appendix

Index



Shooting with Servo AF

This mode helps avoid missing shots of subjects in motion, because the camera continues to focus on the subject and adjust the exposure as long as you press the shutter button halfway.



1 Configure the setting.

- Press the <MENU> button, choose [Servo AF] on the [CAMERA] tab, and then choose [On] (📖24).

2 Focus.

- The focus and exposure are maintained where the blue AF frame is displayed while you are pressing the shutter button halfway.



- Focusing may not be possible in some shooting conditions.
- In low-light conditions, Servo AF may not be activated (AF frames may not turn blue) when you press the shutter button halfway. In this case, the focus and exposure are set according to the specified AF frame mode.
- If adequate exposure cannot be obtained, shutter speeds and aperture values are displayed in orange. Release the shutter button, and then press it halfway again.
- AF lock shooting is not available.
- [AF-Point Zoom] on the [CAMERA] tab (📖24) is not available.
- Not available when using the self-timer (📖37).

Changing the Focus Setting

You can change default camera operation of constantly focusing on subjects it is aimed at, even when the shutter button is not pressed. Instead, you can limit camera focusing to the moment you press the shutter button halfway.



- Press the <MENU> button, choose [Continuous AF] on the [CAMERA] tab, and then choose [Off] (📖24).

| | |
|-----|---|
| On | Helps avoid missing sudden photo opportunities, because the camera constantly focuses on subjects until you press the shutter button halfway. |
| Off | Conserves battery power, because the camera does not focus constantly. |



Shooting with the AF Lock

The focus can be locked. After you lock the focus, the focal position will not change even when you release your finger from the shutter button.

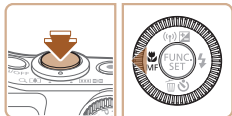

1 Lock the focus.

- With the shutter button pressed halfway, press the <L> button.
- The focus is now locked, and [MF] and the MF indicator are displayed.
- To unlock the focus, after you release the shutter button, press the <L> button again and choose [A] (either press the <L><R> buttons or turn the <DIAL> dial).

2 Compose the shot and shoot.

Shooting Continuously as the Camera Keeps the Subject in Focus

Shoot continuously as the camera keeps the subject in focus. For details on the continuous shooting speed, see “Continuous Shooting Speed” (190).



1 Configure the setting.

- Press the <FUNC SET> button, choose [] in the menu, and then choose [AF-ON] (23).
- Once the setting is complete, [AF-ON] is displayed.

2 Shoot.

- Hold the shutter button all the way down to shoot continuously.



- In [] mode (56), manual focus mode (74), or when AF is locked (79), [AF-ON] is changed to [AF-ON].
- Cannot be used with the self-timer (37).
- Shooting may stop momentarily or continuous shooting may slow down depending on shooting conditions, camera settings, and the zoom position.
- As more shots are taken, shooting may slow down.
- Shooting may slow down if the flash fires.
- [AF-ON] is not available in [] Auto mode (35).



Changing the Flash Mode

You can change the flash mode to match the shooting scene. For details on the flash range, see “Flash Range” (p.190).



1 Raise the flash.

- Move the switch.

2 Configure the setting.

- Press the button, choose a flash mode (either press the buttons or turn the dial), and then press the button.
- The option you configured is now displayed.

- ! • The setting screen cannot be accessed by pressing the button when the flash is lowered. Move the switch to raise the flash, then configure the setting.

 Auto

Fires automatically in low-light conditions.

 On

Fires for each shot.

 Slow Synchro

Fires to illuminate the main subject (such as people) while shooting at a slower shutter speed to illuminate backgrounds out of flash range.

- ! • In mode, mount the camera on a tripod or take other measures to keep it still and prevent camera shake. Additionally, you should set [IS Mode] to [Off] when using a tripod or other means to secure the camera (p.82).
- In mode, even after the flash fires, ensure that the main subject does not move until the shutter sound is finished playing.

 Off

For shooting without the flash.

- ! • If a blinking icon is displayed when you press the shutter button halfway in camera-shake inducing, low-light conditions, mount the camera on a tripod or take other measures to keep it still.



Adjusting the Flash Exposure Compensation

Just as with regular exposure compensation (📖69), you can adjust the flash exposure from -2 to +2 stops, in 1/3-stop increments.



- Press the <FUNC SET> button, choose [F2] in the menu, and adjust the setting by either pressing the <▲><▼> buttons or turning the <◂> dial (📖23).
- The correction level you specified is now displayed.



- When there is a risk of overexposure, the camera automatically adjusts the shutter speed or aperture value during the flash shots to reduce washed-out highlights and shoot at optimal exposure. However, you can deactivate automatic adjustment of the shutter speed and aperture value by accessing MENU (📖24) and choosing [📷] tab > [Flash Settings] > [Safety FE] > [Off].
- You can also configure the flash exposure compensation by accessing MENU (📖24) and choosing [📷] tab > [Flash Settings] > [Flash Exp. Comp].
- You can also access the [Flash Settings] MENU screen (📖24) when the flash is up by pressing the <▶> button and immediately pressing the <MENU> button.

Shooting with the FE Lock

Just as with the AE lock (📖70), you can lock the exposure for the flash shots.

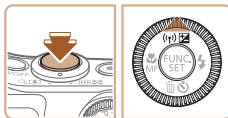

1 Raise the flash and set it to [⚡] (📖80).

2 Lock the flash exposure.

- Aim the camera at the subject to shoot with the exposure locked. With the shutter button pressed halfway, press the <▲> button.
- The flash fires, and when [✳] is displayed, the flash output level is retained.
- To unlock FE, release the shutter button and press the <▲> button again. In this case, [✳] is no longer displayed.

3 Compose the shot and shoot.

- After one shot, FE is unlocked and [✳] is no longer displayed.



- FE: Flash Exposure



Other Settings

Still Images

Changing the Compression Ratio (Image Quality)

Choose from two compression ratios, [S] (Super Fine) and [L] (Fine), as follows. For guidelines on how many shots at each compression ratio can fit on a memory card, see “Number of 4:3 Shots per Memory Card” (190).



- Press the <FUNC SET> button, choose [L] in the menu, and choose the desired option (23).

Changing the IS Mode Settings

Still Images

Movies

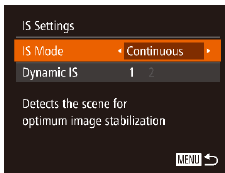

1 Access the setting screen.

- Press the <MENU> button, choose [IS Settings] on the [CAMERA] tab, and then press the <FUNC SET> button (24).

2 Configure the setting.

- Choose [IS Mode], and then choose the desired option (25).

| | |
|-------------|---|
| Continuous | Optimal image stabilization for the shooting conditions is automatically applied (Intelligent IS) (33). |
| Shoot Only* | Image stabilization is active only at the moment of shooting. |
| Off | Deactivates image stabilization. |

* The setting is changed to [Continuous] for movie recording.

- ⚠ If image stabilization cannot prevent camera shake, mount the camera on a tripod or take other measures to hold it still. In this case, set [IS Mode] to [Off].

Before Use

Basic Guide

Advanced Guide

Camera Basics

Auto Mode / Hybrid Auto Mode

Other Shooting Modes

P Mode

Tv, Av, and M Mode

Playback Mode

Wi-Fi Functions

Setting Menu

Accessories

Appendix

Index



Shooting Movies with Subjects at the Same Size Shown before Shooting

Normally, once movie recording begins, the image display area changes and subjects are enlarged to allow for correction of significant camera shake. To shoot subjects at the same size shown before shooting, you can choose not to reduce significant camera shake.

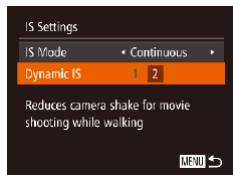

- Follow the steps in “Changing the IS Mode Settings” (82) to access the [IS Settings] screen.
- Choose [Dynamic IS], and then choose [2] (24).



- You can also set [IS Mode] to [Off], so that subjects are recorded at the same size shown before shooting.

Before Use

Basic Guide

Advanced Guide

Camera Basics

Auto Mode / Hybrid Auto Mode

Other Shooting Modes

P Mode

Tv, Av, and M Mode

Playback Mode

Wi-Fi Functions

Setting Menu

Accessories

Appendix

Index



Tv, Av, and M Mode

Take smarter, more sophisticated shots

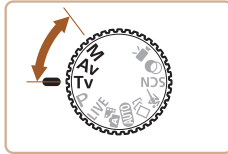

- Instructions in this chapter apply to the camera as set to the respective mode.

| | |
|--|-----------|
| Specific Shutter Speeds ([Tv] Mode)..... | 85 |
| Specific Aperture Values ([Av] Mode) | 85 |
| Specific Shutter Speeds and Aperture Values ([M] Mode)..... | 86 |
| Adjusting the Flash Output..... | 87 |

Before Use

Basic Guide

Advanced Guide

Camera Basics

Auto Mode / Hybrid Auto Mode

Other Shooting Modes

P Mode

Tv, Av, and M Mode

Playback Mode

Wi-Fi Functions

Setting Menu

Accessories

Appendix

Index



Specific Shutter Speeds ([Tv] Mode)

Set your preferred shutter speed before shooting as follows. The camera automatically adjusts the aperture value to suit your shutter speed.

For details on available shutter speeds, see "Shutter Speed" (📖191).



1 Enter [Tv] mode.

- Set the mode dial to [Tv].

2 Set the shutter speed.

- Turn the <⊙> dial to set the shutter speed.



- In shooting conditions requiring slower shutter speeds, there will be a delay before you can shoot again, as the camera processes images to reduce noise.
- When shooting at low shutter speeds on a tripod, you should set [IS Mode] to [Off] (📖82).
- Maximum shutter speed with the flash is 1/2000 second. If you specify a faster speed, the camera will automatically reset the speed to 1/2000 second before shooting.
- Orange display of aperture values when you press the shutter button halfway indicates that the settings deviate from standard exposure. Adjust the shutter speed until the aperture value is displayed in white, or use safety shift (📖85).



- [Tv]: Time value

Specific Aperture Values ([Av] Mode)

Set your preferred aperture value before shooting as follows. The camera automatically adjusts the shutter speed to suit your aperture value.

For details on available aperture values, see "Aperture" (📖191).



1 Enter [Av] mode.

- Set the mode dial to [Av].

2 Set the aperture value.

- Turn the <⊙> dial to set the aperture value.



- Orange display of shutter speeds when you press the shutter button halfway indicates that the settings deviate from standard exposure. Adjust the aperture value until the shutter speed is displayed in white, or use safety shift (see below).



- [Av]: Aperture value (size of the opening made by the iris in the lens)
- To avoid exposure problems in [Tv] and [Av] modes, you can have the camera automatically adjust the shutter speed or aperture value, even when standard exposure cannot otherwise be obtained. Press the <MENU> button and set [Safety Shift] on the [📷] tab to [On] (📖24). However, safety shift is disabled when the flash fires.



Specific Shutter Speeds and Aperture Values ([M] Mode)

Follow these steps before shooting to set your preferred shutter speed and aperture value to obtain the desired exposure.

For details on available shutter speeds and aperture values, see “Shutter Speed” (📖191) and “Aperture” (📖191).

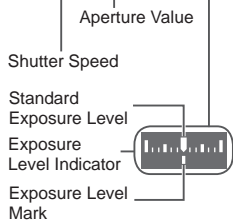

1 Enter [M] mode.

- Set the mode dial to [M].

2 Configure the setting.

- Press the <▲> button, choose adjustment of shutter speed or aperture value, and turn the <⊙> dial to specify a value.
- An exposure level mark based on your specified value is shown on the exposure level indicator for comparison to the standard exposure level.
- The exposure level mark is shown in orange when the difference from standard exposure exceeds 2 stops.



- After you set the shutter speed or aperture value, the exposure level may change if you adjust the zoom or recompose the shot.
- Screen brightness may change depending on your specified shutter speed or aperture value. However, screen brightness remains the same when the flash is up and the mode is set to [⚡].
- To have the setting you did not configure in step 2 (whether shutter speed or aperture value) automatically adjusted to obtain standard exposure, hold the shutter button halfway and press the <▲> button. Note that standard exposure may not be possible with some settings.
- With shutter speeds of 1.3 seconds or slower, ISO speed is [100] and cannot be changed.



- [M]: Manual
- Calculation of standard exposure is based on the specified metering method (📖70).

Before Use

Basic Guide

Advanced Guide

Camera Basics

Auto Mode / Hybrid Auto Mode

Other Shooting Modes

P Mode

Tv, Av, and M Mode

Playback Mode

Wi-Fi Functions

Setting Menu

Accessories

Appendix

Index



Adjusting the Flash Output

Choose from the three flash levels in **[M]** mode.



1 Enter **[M]** mode.

- Set the mode dial to **[M]**.

2 Configure the setting.

- Press the **<FUNC/SET>** button, choose **[FZ]** in the menu, and adjust the setting by either pressing the **<▲>**/**<▼>** buttons or turning the **<DISP>** dial (📖23).
- Once the setting is complete, the flash output level is displayed.
[FZ.00]: low, **[FZ.01]**: medium, **[FZ.01]**: high



- You can also set the flash level by accessing MENU (📖24) and choosing **[📷]** tab > [Flash Settings] > [Flash Output].
- You can set the flash level in **[Tv]** or **[Av]** mode by accessing MENU (📖24) and choosing **[📷]** tab > [Flash Settings] > [Flash Mode] > [Manual].
- You can also access the [Flash Settings] MENU screen when the flash is up by pressing the **<▶>** button and immediately pressing the **<MENU>** button.

Before Use

Basic Guide

Advanced Guide

Camera Basics

Auto Mode / Hybrid Auto Mode

Other Shooting Modes

P Mode

Tv, Av, and M Mode

Playback Mode

Wi-Fi Functions

Setting Menu

Accessories

Appendix

Index



Playback Mode

Have fun reviewing your shots, and browse or edit them in many ways

- To prepare the camera for these operations, press the <▶> button to enter Playback mode.



- It may not be possible to play back or edit images that were renamed or already edited on a computer, or images from other cameras.

| | | | | | |
|---|-----------|--|------------|---|------------|
| Viewing | 89 | Protecting Images | 98 | Editing Still Images | 106 |
| Switching Display Modes | 90 | Using the Menu | 99 | Resizing Images..... | 106 |
| Viewing Short Movies Created When Shooting | 91 | Choosing Images Individually | 99 | Cropping..... | 107 |
| Still Images (Digest Movies)..... | 91 | Selecting a Range..... | 100 | Changing Image Color Tones (My Colors)..... | 108 |
| Checking People Detected in Face ID | 92 | Specifying All Images at Once | 101 | Correcting Image Brightness (i-Contrast)..... | 109 |
| Browsing and Filtering Images | 93 | Erasing Images | 101 | Correcting Red-Eye..... | 109 |
| Navigating through Images in an Index..... | 93 | Erasing Multiple Images at Once | 102 | Editing Movies | 110 |
| Finding Images Matching Specified Conditions | 93 | Rotating Images | 104 | Reducing File Sizes | 112 |
| Viewing Individual Images in a Group..... | 94 | Using the Menu | 104 | Editing Digest Movies..... | 112 |
| Editing Face ID Information | 95 | Deactivating Auto Rotation..... | 105 | | |
| Image Viewing Options | 96 | Tagging Images as Favorites | 105 | | |
| Magnifying Images | 96 | | | | |
| Viewing Slideshows | 96 | | | | |
| Auto Playback of Related Images (Smart Shuffle)..... | 97 | | | | |

Before Use

Basic Guide

Advanced Guide

Camera Basics

Auto Mode / Hybrid
Auto Mode

Other Shooting
Modes

P Mode

Tv, Av, and M Mode

Playback Mode

Wi-Fi Functions

Setting Menu

Accessories

Appendix

Index



Viewing

After shooting images or movies, you can view them on the screen as follows.



1 Enter Playback mode.

- Press the button.
- Your last shot is displayed.



2 Browse through your images.

- To view the previous image, press the button or turn the dial counterclockwise. To view the next image, press the button or turn the dial clockwise.
- Press and hold the buttons to browse through images quickly.

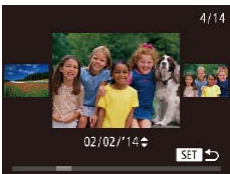

- To access Scroll Display mode, turn the dial rapidly. In this mode, turn the dial to browse through images.
- To return to single-image display, press the button.
- To browse images grouped by shooting date, press the buttons in Scroll Display mode.



Volume Indicator

- Movies are identified by a icon. To play movies, go to step 3.

3 Play movies.

- To start playback, press the button, choose (either press the buttons or turn the dial), and then press the button again.

4 Adjust the volume.

- Press the buttons to adjust the volume.
- To adjust the volume when the volume indicator is no longer displayed, press the buttons.

5 Pause playback.

- To pause or resume playback, press the button.
- After the movie is finished, is displayed.

Before Use

Basic Guide

Advanced Guide

Camera Basics

Auto Mode / Hybrid Auto Mode

Other Shooting Modes

P Mode

Tv, Av, and M Mode

Playback Mode

Wi-Fi Functions

Setting Menu

Accessories

Appendix

Index





- To switch to Shooting mode from Playback mode, press the shutter button halfway.
- To deactivate Scroll Display, choose MENU (📖24) > [▶] tab > [Scroll Display] > [Off].
- To have the most recent shot displayed when you enter Playback mode, choose MENU (📖24) > [▶] tab > [Resume] > [Last shot].
- To change the transition shown between images, access MENU (📖24) and choose your desired effect in [▶] tab > [Transition Effect].

Still Images

Movies

Switching Display Modes

Press the <DISP.> button to view other information on the screen, or to hide the information. For details on the information displayed, see “Playback (Detailed Information Display)” (📖179).



No Information Display



Simple Information Display



Detailed Information Display



GPS Information Display



Still Images

Movies

Overexposure Warning (for Image Highlights)

Washed-out highlights in the image flash on the screen in detailed information display (📖90).

Still Images

Movies

Histogram

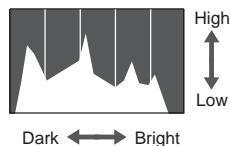

- The graph in detailed information display (📖90) is a histogram showing the distribution of brightness in the image. The horizontal axis represents the degree of brightness, and the vertical axis, how much of the image is at each level of brightness. Viewing the histogram is a way to check exposure.

Before Use

Basic Guide

Advanced Guide

Camera Basics

Auto Mode / Hybrid Auto Mode

Other Shooting Modes

P Mode

Tv, Av, and M Mode

Playback Mode

Wi-Fi Functions

Setting Menu

Accessories

Appendix

Index



GPS Information Display



GPS Display

- Using a smartphone connected to the camera via Wi-Fi, you can geotag images on the camera, adding information such as latitude, longitude, and elevation (📖141). You can review this information in the GPS information display.
- Latitude, longitude, elevation, and UTC (shooting date and time) are listed from top to bottom.



- GPS information display is not available for images that lack this information.
- [--] is shown instead of numerical values for items not available on your smartphone or items not recorded correctly.



- UTC: Coordinated Universal Time, essentially the same as Greenwich Mean Time

Viewing Short Movies Created When Shooting Still Images (Digest Movies)

View digest movies recorded automatically in [📷] mode (📖30) on a day of still image shooting as follows.



1 Choose an image.

- Still images shot in [📷] mode are labeled with an [SET] icon.

2 Play the movie.

- Press the <FUNC/SET> button, and then choose [📷] in the menu (📖23).
- The movie recorded automatically on the day of still image shooting is played back, from the beginning.



- After a moment, [SET] will no longer be displayed when you are using the camera with information display deactivated (📖90).



Viewing by Date

Digest movies can be viewed by date.

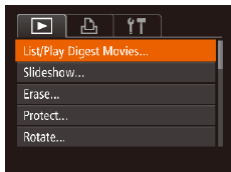

1 Choose a movie.

- Press the <MENU> button, choose [List/Play Digest Movies] on the [▶] tab, and then choose a date (📖24).

2 Play the movie.

- Press the <PUSH SET> button to start playback.

Checking People Detected in Face ID

If you switch the camera to simple information display mode (📖90), the names of up to five detected people registered in Face ID (📖40) will be displayed.



- Press the <DISP.> button several times until simple information display is activated, and then press the <◀><▶> buttons to choose an image.
- Names will be displayed on detected people.



- If you prefer not to have names displayed on images shot using Face ID, choose MENU (📖24) > [▶] tab > [Face ID Info] > [Name Display] > [Off].

Before Use

Basic Guide

Advanced Guide

Camera Basics

Auto Mode / Hybrid Auto Mode

Other Shooting Modes

P Mode

Tv, Av, and M Mode

Playback Mode

Wi-Fi Functions

Setting Menu

Accessories

Appendix

Index



Browsing and Filtering Images

Still Images

Movies

Navigating through Images in an Index

By displaying multiple images in an index, you can quickly find the images you are looking for.

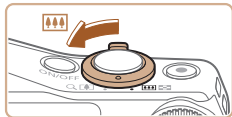

1 Display images in an index.

- Move the zoom lever toward $\langle \text{playback} \rangle$ to display images in an index. Moving the lever again will increase the number of images shown.
- To display fewer images, move the zoom lever toward $\langle \text{Q} \rangle$. Fewer images are shown each time you move the lever.

2 Choose an image.

- Turn the $\langle \text{playback} \rangle$ dial to scroll through the images.
- Press the $\langle \blacktriangle \rangle \langle \blacktriangledown \rangle \langle \blacktriangleleft \rangle \langle \blacktriangleright \rangle$ buttons to choose an image.
- An orange frame is displayed around the selected image.
- Press the $\langle \text{FUNC SET} \rangle$ button to view the selected image in single-image display.



- To deactivate the 3D display effect (shown if you hold down the $\langle \blacktriangle \rangle \langle \blacktriangledown \rangle$ buttons or turn the $\langle \text{playback} \rangle$ dial rapidly), choose MENU (M24) > [I] tab > [Index Effect] > [Off].

Still Images

Movies

Finding Images Matching Specified Conditions

Find desired images quickly on a memory card full of images by filtering image display according to your specified conditions. You can also protect (M98) or delete (M101) these images all at once.

| | |
|-------------------|--|
| Name | Displays images of a registered person (M40). |
| People | Displays images with detected faces. |
| Shot Date | Displays the images shot on a specific date. |
| Favorites | Displays images tagged as favorites (M105). |
| Still image/Movie | Displays only still images or movies. Displays still images, movies, or movies shot in [M] mode (M30). |

1 Choose a search condition.

- Press the $\langle \text{FUNC SET} \rangle$ button, choose [M] in the menu, and choose a condition (M23).
- When you have selected [], [], or [], choose the condition by pressing the $\langle \blacktriangle \rangle \langle \blacktriangledown \rangle \langle \blacktriangleleft \rangle \langle \blacktriangleright \rangle$ buttons on the screen displayed, and then press the $\langle \text{FUNC SET} \rangle$ button.

2 View the filtered images.

- Images matching your conditions are displayed in yellow frames. To view only these images, press the $\langle \blacktriangleleft \rangle \langle \blacktriangleright \rangle$ buttons.
- To cancel filtered display, choose [M] in step 1.



- When the camera has found no corresponding images for some conditions, those conditions will not be available.

Before Use

Basic Guide

Advanced Guide

Camera Basics

Auto Mode / Hybrid Auto Mode

Other Shooting Modes

P Mode

Tv, Av, and M Mode

Playback Mode

Wi-Fi Functions

Setting Menu

Accessories

Appendix

Index





- To show or hide information, press the <DISP.> button in step 2.
- Options for viewing the images found (in step 2) include “Navigating through Images in an Index” (📖93), “Magnifying Images” (📖96), and “Viewing Slideshows” (📖96). You can protect, erase, or print all images found or add them to a photobook by choosing [Select All Images in Search] in “Protecting Images” (📖98), “Erasing Multiple Images at Once” (📖102), “Adding Images to the Print List (DPOF)” (📖167), or “Adding Images to a Photobook” (📖169).
- If you edit images and save them as new images (📖106 – 112), a message is displayed, and the images that were found are no longer shown.

Still Images

Viewing Individual Images in a Group

Images shot in [📷], [📷], or [📷] mode (📖54, 53, 64) are grouped for display, and these grouped images can be viewed one at a time.



1 Choose a grouped image.

- Press the <<|>> buttons or turn the <🔍> dial to choose an image labeled with [SET].



2 Choose [📷].

- Press the <FUNC/SET> button, and then choose [📷] in the menu (📖23).



3 View images in the group individually.

- Pressing the <<|>> buttons or turning the <🔍> dial will display only images in the group.
- To cancel group playback, press the <FUNC/SET> button, choose [📷] in the menu, and press the <FUNC/SET> button again (📖23).



- During group playback (step 3), you can browse through images quickly “Navigating through Images in an Index” (📖93) and magnify them “Magnifying Images” (📖96). By choosing [All Images in Group] for “Protecting Images” (📖98), “Erasing Multiple Images at Once” (📖102), “Adding Images to the Print List (DPOF)” (📖167), or “Adding Images to a Photobook” (📖169), all images in the group can be manipulated at once.
- To ungroup images so that they are displayed only as single still images, choose MENU (📖24) > [📷] tab > [Group Images] > [Off] (📖24). However, grouped images cannot be ungrouped during individual playback.
- Simultaneous display in [📷] mode as described in step 2 of “Enjoying a Variety of Images from Each Shot (Creative Shot)” (📖53) is only shown immediately after you shoot.

Before Use

Basic Guide

Advanced Guide

Camera Basics

Auto Mode / Hybrid Auto Mode

Other Shooting Modes

P Mode

Tv, Av, and M Mode

Playback Mode

Wi-Fi Functions

Setting Menu

Accessories

Appendix

Index



Editing Face ID Information

If you notice that a name is incorrect during playback, you can change it or erase it.

However, you cannot add names for people who are not detected by Face ID (names are not displayed), and for people whose names have been erased.

Changing Names

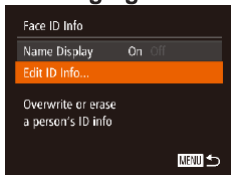

1 Access the setting screen.

- Press the <MENU> button and choose [Face ID Info] on the [▶] tab (📖24).
- Press the <▲><▼> buttons or turn the <⦿> dial to choose [Edit ID Info], and then press the <FUNC SET> button.

2 Choose an image.

- Following the procedure in “Checking People Detected in Face ID” (📖92), choose an image and press the <FUNC SET> button.
- An orange frame is displayed around the selected face. When multiple names are displayed in an image, press the <◀><▶> buttons or turn the <⦿> dial to choose the name to change, and then press the <FUNC SET> button.



3 Choose the editing option.

- Press the <▲><▼><◀><▶> buttons or turn the <⦿> dial to choose [Overwrite], and then press the <FUNC SET> button.

4 Choose the name of the person to overwrite with.

- Follow step 2 in “Overwriting and Adding Face Information” (📖44) to choose the name of the person you want to overwrite with.

Erasing Names

- Following step 3 in “Changing Names” (📖95), choose [Erase] and press the <FUNC SET> button.
- After [Erase?] is displayed, press the <◀><▶> buttons or turn the <⦿> dial to choose [OK], and then press the <FUNC SET> button.

Before Use

Basic Guide

Advanced Guide

Camera Basics

Auto Mode / Hybrid Auto Mode

Other Shooting Modes

P Mode

Tv, Av, and M Mode

Playback Mode

Wi-Fi Functions

Setting Menu

Accessories

Appendix

Index



Magnifying Images

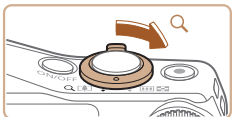

Approximate Position of Displayed Area

1 Magnify an image.

- Moving the zoom lever toward <Q> will zoom in and magnify the image. You can magnify images up to about 10x by continuing to hold the zoom lever.
- To zoom out, move the zoom lever toward <Q>. You can return to single-image display by continuing to hold it.

2 Move the display position and switch images as needed.

- To move the display position, press the <▲><▼><◀><▶> buttons.
- To switch to other images while zoomed, turn the <Q> dial.



- You can return to single-image display from magnified display by pressing the <MENU> button.

Viewing Slideshows

Automatically play back images from a memory card as follows. Each image is displayed for about three seconds.

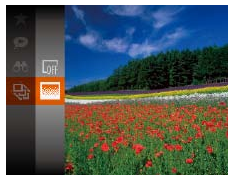

- Press the <FUNC/SET> button, choose [⇄] in the menu, and choose the desired option (📖23).
- The slideshow will start after [Loading image] is displayed for a few seconds.
- Press the <MENU> button to stop the slideshow.



- The camera's power-saving functions (📖21) are deactivated during slideshows.



- To pause or resume slideshows, press the <FUNC/SET> button.
- You can switch to other images during playback by pressing the <◀><▶> buttons or turning the <Q> dial. For fast-forward or fast-rewind, hold the <◀><▶> buttons down.
- In image search mode (📖93), only images matching search conditions are played.



Changing Slideshow Settings

You can set up slideshows to repeat, and you can change the transitions between images and the display duration of each image.

1 Access the setting screen.

- Press the <MENU> button, and then choose [Slideshow] on the [▶] tab (📖24).

2 Configure the settings.

- Choose a menu item to configure, and then choose the desired option (📖25).
- To start the slideshow with your settings, choose [Start] and press the <FUNC/SET> button.
- To return to the menu screen, press the <MENU> button.

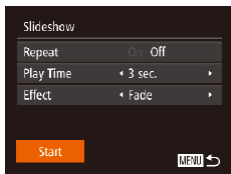

- ! • [Play Time] cannot be modified when [Bubble] is chosen in [Effect].

Auto Playback of Related Images (Smart Shuffle)

Based on the current image, the camera offers four images that you may wish to view. After you choose to view one of those images, the camera offers four more images. This is an enjoyable way to play back images in an unexpected order. Try this feature after you have taken many shots, in many kinds of scenes.

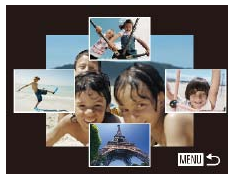

1 Choose Smart Shuffle.

- Press the <FUNC/SET> button, and then choose [▶] in the menu (📖23).
- Four candidate images are displayed.

2 Choose an image.

- Press the <▲><▼><◀><▶> buttons to choose the image you want to view next.
- Your chosen image is displayed in the center, surrounded by the next four candidate images.
- For full-screen display of the center image, press the <FUNC/SET> button. To restore the original display, press the <FUNC/SET> button again.
- Press the <MENU> button to restore single-image display.

Before Use

Basic Guide

Advanced Guide

Camera Basics

Auto Mode / Hybrid Auto Mode

Other Shooting Modes

P Mode

Tv, Av, and M Mode

Playback Mode

Wi-Fi Functions

Setting Menu

Accessories

Appendix

Index





- Only still images shot with this camera are played back using Smart Shuffle.
- Smart Shuffle is not available in the following cases:
 - There are less than 50 shots taken with this camera
 - An unsupported image is currently displayed
 - Images are shown in filtered display (📖93)
 - During group playback (📖94)

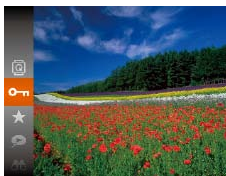

- Protected images on a memory card will be erased if you format the card (📖149, 150).



- Protected images cannot be erased using the camera's erasure function. To erase them this way, first cancel protection.

Protecting Images

Protect important images to prevent accidental erasure by the camera (📖101).

- Press the <FUNC SET> button, and then choose [LOCK] in the menu (📖23). [Protected] is displayed.
- To cancel protection, repeat this process and choose [LOCK] again, and then press the <FUNC SET> button.

Still Images

Movies

Before Use

Basic Guide

Advanced Guide

Camera Basics

Auto Mode / Hybrid Auto Mode

Other Shooting Modes

P Mode

Tv, Av, and M Mode

Playback Mode

Wi-Fi Functions

Setting Menu

Accessories

Appendix

Index



Using the Menu

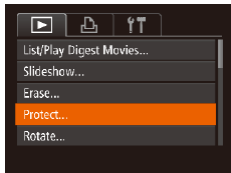

1 Access the setting screen.

- Press the <MENU> button and choose [Protect] on the [MENU] tab (📖24).

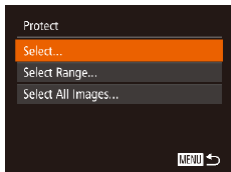

2 Choose a selection method.

- Choose a menu item and an option as desired (📖25).
- To return to the menu screen, press the <MENU> button.

Choosing Images Individually

1 Choose [Select].

- Following step 2 in “Using the Menu” (📖99), choose [Select] and press the <FUNC/SET> button.

2 Choose an image.

- Press the <◀>>>> buttons or turn the <⦿> dial to choose an image, and then press the <FUNC/SET> button. [On] is displayed.
- To cancel selection, press the <FUNC/SET> button again. [On] is no longer displayed.
- Repeat this process to specify other images.



3 Protect the image.

- Press the <MENU> button. A confirmation message is displayed.
- Press the <◀>>>> buttons or turn the <⦿> dial to choose [OK], and then press the <FUNC/SET> button.



- Images will not be protected if you switch to Shooting mode or turn the camera off before finishing the setup process in step 3.



Before Use

Basic Guide

Advanced Guide

Camera Basics

Auto Mode / Hybrid Auto Mode

Other Shooting Modes

P Mode

Tv, Av, and M Mode

Playback Mode

Wi-Fi Functions

Setting Menu

Accessories

Appendix

Index







Selecting a Range

1 Choose [Select Range].



- Following step 2 in “Using the Menu” (p. 99), choose [Select Range] and press the  button.

2 Choose a starting image.



- Press the  button.

- Press the  buttons or turn the  dial to choose an image, and then press the  button.

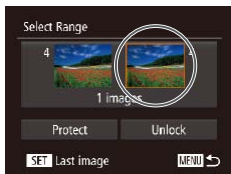
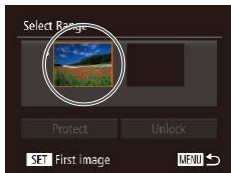

3 Choose an ending image.

- Press the  button to choose [Last image], and then press the  button.



- Press the  buttons or turn the  dial to choose an image, and then press the  button.
- Images before the first image cannot be selected as the last image.

4 Protect the images.

- Press the  button to choose [Protect], and then press the  button.



- You can also choose the first or last image by turning the  dial when the top screen in steps 2 and 3 is displayed.

Before Use

Basic Guide

Advanced Guide

Camera Basics

Auto Mode / Hybrid Auto Mode

Other Shooting Modes

P Mode

Tv, Av, and M Mode

Playback Mode

Wi-Fi Functions

Setting Menu

Accessories

Appendix

Index







Specifying All Images at Once

1 Choose [Select All Images].

- Following step 2 in “Using the Menu” (📖99), choose [Select All Images] and press the  button.

2 Protect the images.

- Press the   buttons or turn the  dial to choose [Protect], and then press the  button.



- To cancel protection for groups of images, choose [Unlock] in step 4 of “Selecting a Range” or in step 2 of “Specifying All Images at Once”.



Erasing Images

Still Images









Movies

You can choose and erase unneeded images one by one. Be careful when erasing images, because they cannot be recovered. However, protected images (📖98) cannot be erased.

1 Choose an image to erase.

- Press the   buttons or turn the  dial to choose an image.

2 Erase the image.

- Press the  button.
- After [Erase?] is displayed, press the   buttons or turn the  dial to choose [Erase], and then press the  button.
- The current image is now erased.
- To cancel erasure, press the   buttons or turn the  dial to choose [Cancel], and then press the  button.



Before Use

Basic Guide

Advanced Guide

Camera Basics

Auto Mode / Hybrid Auto Mode

Other Shooting Modes

P Mode

Tv, Av, and M Mode

Playback Mode

Wi-Fi Functions

Setting Menu

Accessories

Appendix

Index



Erasing Multiple Images at Once

You can choose multiple images to erase at once. Be careful when erasing images, because they cannot be recovered. However, protected images (📖98) cannot be erased.

Choosing a Selection Method

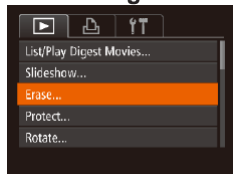

1 Access the setting screen.

- Press the <MENU> button, and then choose [Erase] on the [▶] tab (📖24).

2 Choose a selection method.

- Press the <▲><▼> buttons or turn the <⦿> dial to choose a selection method, and then press the <FUNC SET> button.
- To return to the menu screen, press the <MENU> button.

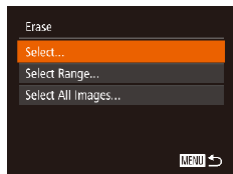

Choosing Images Individually

1 Choose [Select].

- Following step 2 in "Choosing a Selection Method" (📖102), choose [Select] and press the <FUNC SET> button.



2 Choose an image.

- Once you choose an image following step 2 in "Choosing Images Individually" (📖99), [✓] is displayed.
- To cancel selection, press the <FUNC SET> button again. [✓] is no longer displayed.
- Repeat this process to specify other images.

3 Erase the image.

- Press the <MENU> button. A confirmation message is displayed.
- Press the <◀><▶> buttons or turn the <⦿> dial to choose [OK], and then press the <FUNC SET> button.



Before Use

Basic Guide

Advanced Guide

Camera Basics

Auto Mode / Hybrid Auto Mode

Other Shooting Modes

P Mode

Tv, Av, and M Mode

Playback Mode

Wi-Fi Functions

Setting Menu

Accessories

Appendix

Index



Selecting a Range



1 Choose [Select Range].

- Following step 2 in “Choosing a Selection Method” (📖102), choose [Select Range] and press the  button.

2 Choose images.

- Follow steps 2 – 3 in “Selecting a Range” (📖100) to specify images.

3 Erase the images.

- Press the  button to choose [Erase], and then press the  button.

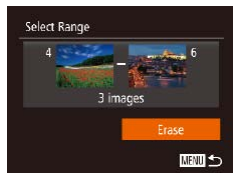



Specifying All Images at Once

1 Choose [Select All Images].

- Following step 2 in “Choosing a Selection Method” (📖102), choose [Select All Images] and press the  button.

2 Erase the images.

- Press the  buttons or turn the  dial to choose [OK], and then press the  button.

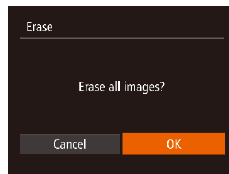

Before Use

Basic Guide

Advanced Guide

Camera Basics

Auto Mode / Hybrid Auto Mode

Other Shooting Modes

P Mode

Tv, Av, and M Mode

Playback Mode

Wi-Fi Functions

Setting Menu

Accessories

Appendix

Index



Rotating Images

Change the orientation of images and save them as follows.



1 Choose [Rotate].

- Press the button, and then choose [Rotate] in the menu (📖23).



2 Rotate the image.

- Press the or button, depending on the desired direction. Each time you press the button, the image is rotated 90°. Press the button to complete the setting.

Using the Menu

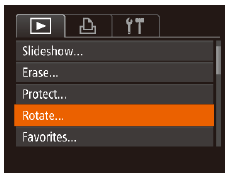

1 Choose [Rotate].

- Press the button and choose [Rotate] on the tab (📖24).

2 Rotate the image.

- Press the or buttons or turn the dial to choose an image.
- The image is rotated 90° each time you press the button.
- To return to the menu screen, press the button.

- Rotation is not possible when [Auto Rotate] is set to [Off] (📖105).

Before Use

Basic Guide

Advanced Guide

Camera Basics

Auto Mode / Hybrid
Auto ModeOther Shooting
Modes

P Mode

Tv, Av, and M Mode

Playback Mode

Wi-Fi Functions

Setting Menu

Accessories

Appendix

Index



Deactivating Auto Rotation

Follow these steps to deactivate automatic image rotation, which rotates images based on the current camera orientation.

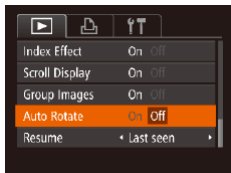

- Press the <MENU> button, choose [Auto Rotate] on the [] tab, and then choose [Off] (24).



- Images cannot be rotated (104) when you set [Auto Rotate] to [Off]. Additionally, images already rotated will be displayed in the original orientation.
- In Smart Shuffle (97) mode, even if [Auto Rotate] is set to [Off], images shot vertically will be displayed vertically, and rotated images will be displayed in the rotated orientation.

Tagging Images as Favorites

You can organize images by tagging them as favorites. By choosing a category in filtered playback, you can restrict the following operations to all of those images.

- Viewing (89), Viewing Slideshows (96), Protecting Images (98), Erasing Images (101), Adding Images to the Print List (DPOF) (167), Adding Images to a Photobook (169)

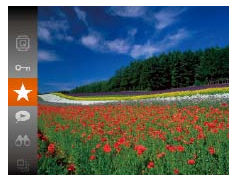

- Press the <FUNC SET> button, and then choose [★] in the menu (23).
- [Tagged as Favorite] is displayed.
- To untag the image, repeat this process and choose [★] again, and then press the <FUNC SET> button.

Before Use

Basic Guide

Advanced Guide

Camera Basics

Auto Mode / Hybrid Auto Mode

Other Shooting Modes

P Mode

Tv, Av, and M Mode

Playback Mode

Wi-Fi Functions

Setting Menu

Accessories

Appendix

Index



Using the Menu

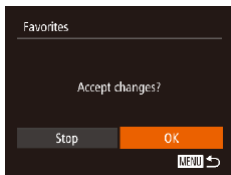
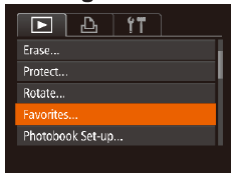

1 Choose [Favorites].

- Press the <MENU> button and choose [Favorites] on the [] tab (24).

2 Choose an image.

- Press the <◀>>> buttons or turn the <◉> dial to choose an image, and then press the <FUNC SET> button. [★] is displayed.
- To untag the image, press the <◉> button again. [★] is no longer displayed.
- Repeat this process to choose additional images.

3 Finish the setup process.

- Press the <MENU> button. A confirmation message is displayed.
- Press the <◀>>> buttons or turn the <◉> dial to choose [OK], and then press the <FUNC SET> button.



- Images will not be tagged as favorites if you switch to Shooting mode or turn the camera off before finishing the setup process in step 3.



- Favorite images will have a three-star rating (★★★★☆) when transferred to computers running Windows 8, Windows 7, or Windows Vista. (Does not apply to movies.)

Editing Still Images



- Image editing (106 – 110) is only available when the memory card has sufficient free space.

Resizing Images

Save a copy of images at a lower resolution.

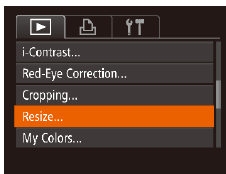

1 Choose [Resize].

- Press the <MENU> button and choose [Resize] on the [] tab (24).

2 Choose an image.

- Press the <◀>>> buttons or turn the <◉> dial to choose an image, and then press the <FUNC SET> button.

3 Choose an image size.

- Press the <◀>>> buttons or turn the <◉> dial to choose the size, and then press the <FUNC SET> button.
- [Save new image?] is displayed.

Still Images

Before Use

Basic Guide

Advanced Guide

Camera Basics

Auto Mode / Hybrid Auto Mode

Other Shooting Modes

P Mode

Tv, Av, and M Mode

Playback Mode

Wi-Fi Functions

Setting Menu

Accessories

Appendix

Index



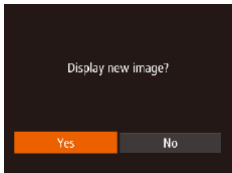
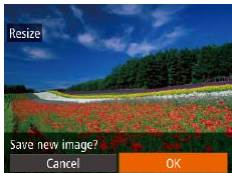

4 Save the new image.

- Press the <◀>> buttons or turn the <ⓘ> dial to choose [OK], and then press the <FUNC SET> button.
- The image is now saved as a new file.

5 Review the new image.

- Press the <MENU> button. [Display new image?] is displayed.
- Press the <◀>> buttons or turn the <ⓘ> dial to choose [Yes], and then press the <FUNC SET> button.
- The saved image is now displayed.

- ! • Editing is not possible for images shot at a resolution of [S] (46) or saved as [S] in step 3.

- ✏ • Images cannot be resized to a higher resolution.

Cropping

You can specify a portion of an image to save as a separate image file.

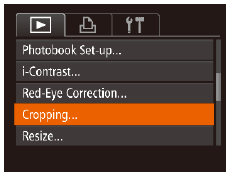

1 Choose [Cropping].

- Press the <MENU> button, and then choose [Cropping] on the [▶] tab (24).

2 Choose an image.

- Press the <◀>> buttons or turn the <ⓘ> dial to choose an image, and then press the <FUNC SET> button.



Cropping Area



Preview of Image After Cropping

Resolution After Cropping



3 Adjust the cropping area.

- A frame is displayed around the portion of the image to be cropped.
- The original image is shown in the upper left, and a preview of the image as cropped is shown in the lower right.
- To resize the frame, move the zoom lever.
- To move the frame, press the <▲><▼><◀><▶> buttons.
- To change the frame orientation, press the <DISP.> button.
- Faces detected in the image are enclosed in gray frames in the upper-left image. To crop the image based on this frame, turn the <◉> dial to switch to the other frame.
- Press the <FUNC/SET> button.

4 Save as a new image and review.

- Follow steps 4 – 5 in “Resizing Images” (107).



- Editing is not possible for images shot at a resolution of [S] (46) or resized to [S] (106).



- Images supported for cropping will have the same aspect ratio after cropping.
- Cropped images will have a lower resolution than uncropped images.
- If you crop still images shot using Face ID (40), only the names of the people left in the cropped image will remain.

Changing Image Color Tones (My Colors)

You can adjust image colors and then save the edited image as a separate file. For details on each option, see “Changing Image Color Tones (My Colors)” (73).

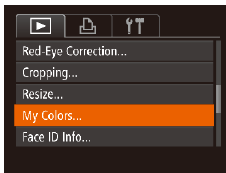

1 Choose [My Colors].

- Press the <MENU> button, and then choose [My Colors] on the [▶] tab (24).

2 Choose an image.

- Press the <◀><▶> buttons or turn the <◉> dial to choose an image, and then press the <FUNC/SET> button.

3 Choose an option.

- Press the <◀><▶> buttons or turn the <◉> dial to choose an option, and then press the <FUNC/SET> button.

4 Save as a new image and review.

- Follow steps 4 – 5 in “Resizing Images” (107).



- Image quality of pictures you repeatedly edit this way will be a little lower each time, and you may not be able to obtain the desired color.



- The color of images edited using this function may vary slightly from the color of images shot using My Colors (73).



Correcting Image Brightness (i-Contrast)

Excessively dark image areas (such as faces or backgrounds) can be detected and automatically adjusted to the optimal brightness. Insufficient overall image contrast is also automatically corrected, to make subjects stand out better. Choose from four correction levels, and then save the image as a separate file.

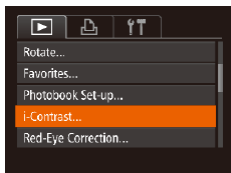

1 Choose [i-Contrast].

- Press the <MENU> button, and then choose [i-Contrast] on the [▶] tab (📖24).

2 Choose an image.

- Press the <◀>>> buttons or turn the <⚙> dial to choose an image, and then press the <FUNC/SET> button.

3 Choose an option.

- Press the <◀>>> buttons or turn the <⚙> dial to choose an option, and then press the <FUNC/SET> button.

4 Save as a new image and review.

- Follow steps 4 – 5 in “Resizing Images” (📖107).



- For some images, correction may be inaccurate or may cause images to appear grainy.
- Images may look grainy after repeated editing using this function.



- If [Auto] does not produce the expected results, try correcting images using [Low], [Medium], or [High].

Correcting Red-Eye

Automatically corrects images affected by red-eye. You can save the corrected image as a separate file.

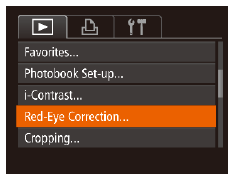

1 Choose [Red-Eye Correction].

- Press the <MENU> button, and then choose [Red-Eye Correction] on the [▶] tab (📖24).

2 Choose an image.

- Press the <◀>>> buttons or turn the <⚙> dial to choose an image.



Editing Movies

You can cut movies to remove unneeded portions at the beginning or end.

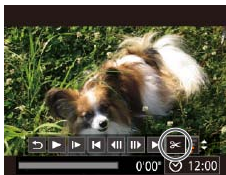

Movie Editing Panel



Movie Editing Bar

3 Correct the image.

- Press the button.
- Red-eye detected by the camera is now corrected, and frames are displayed around corrected image areas.
- Enlarge or reduce images as needed. Follow the steps in “Magnifying Images” (96).

4 Save as a new image and review.

- Press the > < < > buttons or turn the dial to choose [New File], and then press the button.
- The image is now saved as a new file.
- Follow step 5 in “Resizing Images” (107).

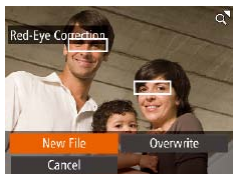

- Some images may not be corrected accurately.
- To overwrite the original image with the corrected image, choose [Overwrite] in step 4. In this case, the original image will be erased.
- Protected images cannot be overwritten.

1 Choose .

- Following steps 1 – 5 in “Viewing” (89), choose and press the button.
- The movie editing panel and editing bar are now displayed.

2 Specify portions to cut.

- Press the > buttons to choose [] or [].
- To view the portions you can cut (identified by [] on the screen), press the < > buttons or turn the dial to move []. Cut the beginning of the movie (from []) by choosing [], and cut the end of the movie by choosing [].
- If you move [] to a position other than a [] mark, in [] the portion before the nearest [] mark on the left will be cut, while in [] the portion after the nearest [] mark on the right will be cut.



| |
|------------------------------|
| Before Use |
| Basic Guide |
| Advanced Guide |
| Camera Basics |
| Auto Mode / Hybrid Auto Mode |
| Other Shooting Modes |
| P Mode |
| Tv, Av, and M Mode |
| Playback Mode |
| Wi-Fi Functions |
| Setting Menu |
| Accessories |
| Appendix |
| Index |

3 Review the edited movie.

- Press the <▲><▼> buttons to choose [▶], and then press the <FUNC SET> button. The edited movie is now played.
- To edit the movie again, repeat step 2.
- To cancel editing, press the <▲><▼> buttons to choose [↵]. Press the <FUNC SET> button, choose [OK] (either press the <◀><▶> buttons or turn the <DISP> dial), and then press the <FUNC SET> button again.

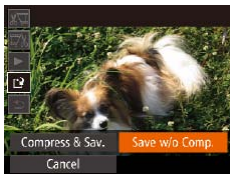
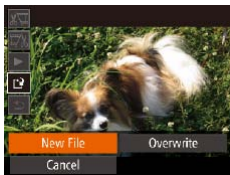

4 Save the edited movie.

- Press the <▲><▼> buttons to choose [▶], and then press the <FUNC SET> button.
- Press the <▲><▼><◀><▶> buttons or turn the <DISP> dial to choose [New File], and then press the <FUNC SET> button.
- The movie is now saved as a new file.
- Choose [Save w/o Comp.], and then press the <FUNC SET> button.



- To overwrite the original movie with the cut one, choose [Overwrite] in step 4. In this case, the original movie will be erased.
- If the memory card lacks sufficient space, only [Overwrite] will be available.
- Movies may not be saved if the battery pack runs out while saving is in progress.
- When editing movies, you should use a fully charged battery pack or an AC adapter kit (sold separately, [156](#)).



Reducing File Sizes

Movie file sizes can be reduced by compressing movies as follows.



- On the screen in step 2 of “Editing Movies”, choose [**⏏**]. Choose [New File], and then press the <FUNC/SET> button.
- Choose [Compress & Sav.], and then press the <FUNC/SET> button.



- Compressed movies are saved in [HD BQP] format.
- [VGA BQP] movies cannot be compressed.
- Edited movies cannot be saved in compressed format when you choose [Overwrite].
- However, you can compress and save edited movies as new files by choosing [Compress & Sav.].

Editing Digest Movies

Individual chapters (clips) (30) recorded in [M] mode can be erased, as needed. Be careful when erasing clips, because they cannot be recovered.



1 Select the clip to erase.

- Follow steps 1 – 2 in “Viewing Short Movies Created When Shooting Still Images (Digest Movies)” (91) to play a movie created in [M] mode, and then press the <FUNC/SET> button to access the movie control panel.
- Press the <◀▶>>>> buttons or turn the <⦿> dial to choose [◀] or [▶], and then press the <FUNC/SET> button.

2 Choose [⏏].

- Press the <◀▶>>>> buttons or turn the <⦿> dial to choose [⏏], and then press the <FUNC/SET> button.
- The selected clip is played back repeatedly.

3 Confirm erasure.

- Press the <◀▶>>>> buttons or turn the <⦿> dial to choose [OK], and then press the <FUNC/SET> button.
- The clip is erased, and the short movie is overwritten.

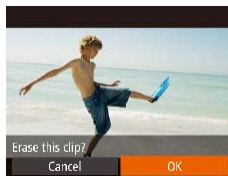

- [⏏] is not displayed if you select a clip when the camera is connected to a printer.



Wi-Fi Functions

Send images wirelessly from the camera to a variety of compatible devices, and use the camera with Web services

| | | | | | |
|---|------------|--|------------|--|------------|
| What You Can Do with Wi-Fi | 114 | Accessing the Wi-Fi Menu | 123 | Using the < [] > Button | 137 |
| Uploading Images to Web Services | 114 | Initial Connection via Wi-Fi..... | 123 | Registering a Smartphone to the < [] > Button ... | 137 |
| Sending Images to a Smartphone..... | 115 | After the Initial Wi-Fi Connection..... | 123 | Registering Image Sync to the < [] > Button..... | 138 |
| Sending Images to a Computer | 115 | Connecting via an Access Point | 124 | Clearing Registered Destinations..... | 139 |
| Printing Images Wirelessly | 116 | Confirming Access Point Compatibility..... | 124 | Sending Images Automatically (Image Sync) | 139 |
| Sending Images to Another Camera | 116 | Connecting to WPS-Compatible Access Points | 125 | Initial Preparations | 139 |
| Registering Web Services | 116 | Connecting to Access Points in the List | 128 | Sending Images | 140 |
| Registering CANON IMAGE GATEWAY | 117 | Connecting without an Access Point | 129 | Geotagging Images on the Camera | 141 |
| Registering Other Web Services..... | 119 | Previous Access Points..... | 132 | Shooting Remotely | 141 |
| Installing CameraWindow on a Smartphone | 119 | Connecting to Another Camera | 132 | Editing or Erasing Wi-Fi Settings | 142 |
| Preparing to Register a Computer | 120 | Sending Images | 133 | Editing Connection Information | 142 |
| Checking Your Computer Environment | 120 | Sending Images Individually | 133 | Returning the Wi-Fi Settings to Default..... | 144 |
| Installing the Software..... | 121 | Sending Multiple Images..... | 135 | | |
| Configuring the Computer for a Wi-Fi Connection (Windows Only)..... | 122 | Adding Comments..... | 136 | | |
| | | Saving Images to a Computer | 136 | | |

Before Use

Basic Guide

Advanced Guide

Camera Basics

Auto Mode / Hybrid Auto Mode

Other Shooting Modes

P Mode

Tv, Av, and M Mode

Playback Mode

Wi-Fi Functions

Setting Menu

Accessories

Appendix

Index



What You Can Do with Wi-Fi

This camera is an approved Wi-Fi® product. You can wirelessly connect to and send images to the following devices and services.

Note that, in this chapter, wireless LAN functions other than Wi-Fi may be referred to as Wi-Fi.

Sending images via Wi-Fi requires some initial preparation on the camera and target devices. Preparations and methods of sending images vary depending on the destination.

Note that before using Wi-Fi (📖123), you will need to register a camera nickname on the camera.



- Before using Wi-Fi, be sure to read "Wi-Fi (Wireless LAN) Precautions" (📖194) and "Security Precautions" (📖195).



- Wi-Fi is a brand name that indicates interoperability certification of wireless LAN devices.

Uploading Images to Web Services

Images can be sent to social network services and other Web services via CANON iMAGE GATEWAY*. Unsent images on the camera can also be sent automatically to a computer or Web service via CANON iMAGE GATEWAY.

* CANON iMAGE GATEWAY is an online photo service available to those who have purchased this product.

Steps in sending images

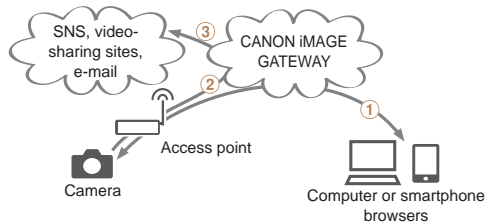

- ① Register Web services (📖116)
- ② Connect via an access point (📖124)
- ③ Send images (📖133)*

* You can send images to a computer or Web service.

Before Use

Basic Guide

Advanced Guide

Camera Basics

Auto Mode / Hybrid Auto Mode

Other Shooting Modes

P Mode

Tv, Av, and M Mode

Playback Mode

Wi-Fi Functions

Setting Menu

Accessories

Appendix

Index



Sending Images to a Smartphone

Send images to smartphones and tablet computers that have Wi-Fi functions. You can also shoot remotely and geotag your shots from a smartphone or tablet.

For convenience in this manual, smartphones, tablets, and other compatible devices are collectively referred to as “smartphones”.

Steps in sending images

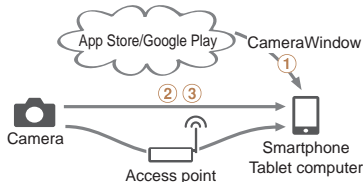

- 1 Install CameraWindow on a smartphone (📖119)
- 2 Connect directly (📖129) or via an access point (📖124)
- 3 Send images (📖133)

Sending Images to a Computer

Use the software to wirelessly send images from the camera to a computer.

Steps in sending images

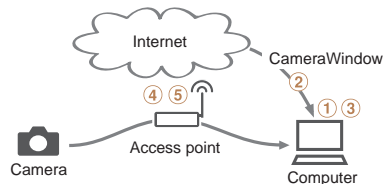

- 1 Check your computer environment (📖120)
- 2 Download and install the software (📖121)
- 3 Configure the computer for a Wi-Fi connection (Windows only, 📖122)
- 4 Connect via an access point (📖124)
- 5 Save images to the computer (📖136)

Before Use

Basic Guide

Advanced Guide

Camera Basics

Auto Mode / Hybrid
Auto Mode

Other Shooting
Modes

P Mode

Tv, Av, and M Mode

Playback Mode

Wi-Fi Functions

Setting Menu

Accessories

Appendix

Index



Printing Images Wirelessly

Send images wirelessly to a PictBridge-compatible printer (supporting DPS over IP) to print them.

Steps in sending images

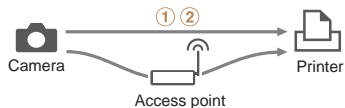

- ① Connect directly (📖129) or via an access point (📖124)
- ② Print images (📖163)

Sending Images to Another Camera

Use the Wi-Fi function to send images between Canon-brand cameras.

Steps in sending images



- ① Connect to another camera (📖132)
- ② Send images (📖133)

Registering Web Services

Use a smartphone or computer to add to the camera Web services that you want to use.

- A smartphone or computer with a browser and Internet connection is required to complete camera settings for CANON iMAGE GATEWAY and other Web services.
- Check the CANON iMAGE GATEWAY website for details on browser (Microsoft Internet Explorer, etc.) requirements, including settings and version information.
- For information on countries and regions where CANON iMAGE GATEWAY is available, visit the Canon website (<http://www.canon.com/cig/>).
- You must have an account with Web services other than CANON iMAGE GATEWAY if you desire to use them. For further details, check the websites for each Web service you want to register.
- Separate ISP connection and access point fees may be applicable.

Before Use

Basic Guide

Advanced Guide

Camera Basics

Auto Mode / Hybrid Auto Mode

Other Shooting Modes

P Mode

Tv, Av, and M Mode

Playback Mode

Wi-Fi Functions

Setting Menu

Accessories

Appendix

Index



Registering CANON iMAGE GATEWAY

After linking the camera and CANON iMAGE GATEWAY, add CANON iMAGE GATEWAY as a destination Web service on the camera.



1 Log in to CANON iMAGE GATEWAY and access the camera settings page.

- From a computer or smartphone, access <http://www.canon.com/cig/> and visit the CANON iMAGE GATEWAY site for your region.
- Once the login screen is displayed, enter your user name and password to log in. If you do not have a CANON iMAGE GATEWAY account, follow the instructions to complete member registration (free of charge).
- Access the camera settings page.



2 Choose your camera model.

- On this camera model, [☁️] is displayed in the Wi-Fi menu.
- Once you choose the model, a page is displayed for entering the authentication code. On this page in step 9, you will enter the authentication code displayed on the camera after steps 3 – 8.

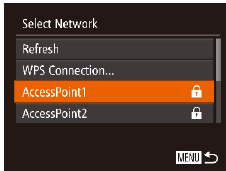
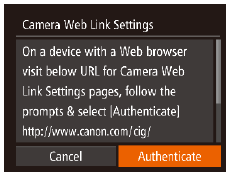
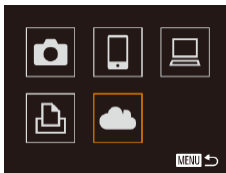

3 Access the Wi-Fi menu.

- On the camera, access the Wi-Fi menu (📖 123).

4 Choose [☁️].

- Press the <▲><▼><◀><▶> buttons or turn the <⦿> dial to choose [☁️], and then press the <FUNC SET> button.

5 Establish a connection with an access point.

- Press the <◀><▶> buttons or turn the <⦿> dial to choose [Authenticate], and then press the <FUNC SET> button.

6 Choose an access point.

- Press the <▲><▼> buttons or turn the <⦿> dial to choose a network (access point), and then press the <FUNC SET> button.

Before Use

Basic Guide

Advanced Guide

Camera Basics

Auto Mode / Hybrid Auto Mode

Other Shooting Modes

P Mode

Tv, Av, and M Mode

Playback Mode

Wi-Fi Functions

Setting Menu

Accessories

Appendix

Index



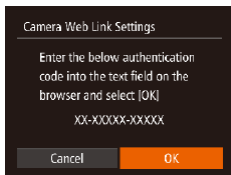
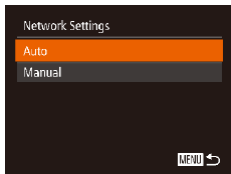

7 Enter the access point password.

- Press the button to access the keyboard, and then enter the password ([124](#)).
- Press the buttons or turn the dial to choose [Next], and then press the button.

8 Choose [Auto] and establish the connection.

- Press the buttons or turn the dial to choose [Auto], and then press the button.
- Once the camera is connected to CANON iMAGE GATEWAY via the access point, an authentication code is displayed.

9 Enter the authentication code.

- On the smartphone or computer, enter the authentication code displayed on the camera and go to the next step.
- A six-digit confirmation number is displayed.

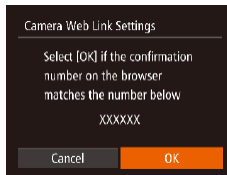

10 Check the confirmation numbers and complete the setup process.

- Make sure the confirmation number on the camera matches the number on the smartphone or computer.
- Press the buttons or turn the dial to choose [OK], and then press the button.
- Complete the setup process on the smartphone or computer.
- ([139](#)) and CANON iMAGE GATEWAY are now added as destinations, and the icon changes to .
- A message is displayed on the smartphone or computer to indicate that this process is finished. To add other Web services, follow the procedure in "Registering Other Web Services" from step 2 ([119](#)).



- You can connect to WPS-compatible access points by choosing [WPS Connection] in step 6. For details, see steps 5 – 7 in "Connecting to WPS-Compatible Access Points" ([125 – 126](#)).

Before Use

Basic Guide

Advanced Guide

Camera Basics

Auto Mode / Hybrid Auto Mode

Other Shooting Modes

P Mode

Tv, Av, and M Mode

Playback Mode

Wi-Fi Functions

Setting Menu

Accessories

Appendix

Index



Registering Other Web Services

You can also add Web services besides CANON iMAGE GATEWAY to the camera. Note that CANON iMAGE GATEWAY must be registered on the camera first (📖117).



1 Access the Web service settings screen.

- Follow step 1 in “Registering CANON iMAGE GATEWAY” (📖117) to log in to CANON iMAGE GATEWAY, and then access the Web service settings screen.



2 Configure the Web service you want to use.

- Follow the instructions displayed on the smartphone or computer to set up the Web service.

3 Choose [📶].

- Access the Wi-Fi menu (📖123), choose [📶] (either press the <▲><▼><◀><▶> buttons or turn the <⦿> dial), and then press the <📶> button.
- The Web service settings are now updated.



- If any configured settings change, follow these steps again to update the camera settings.

Installing CameraWindow on a Smartphone

Before connecting your camera to a smartphone, first install the free dedicated application, CameraWindow, on your smartphone.



1 Connect the smartphone to a network.

2 Install CameraWindow.

- For an NFC-compatible Android smartphone (OS version 4.0 or later), activating NFC and touching the smartphone against the camera's N-Mark (N) will start Google Play on the smartphone. Once the CameraWindow download page is displayed, download and install the app.
- For other Android smartphones, find CameraWindow in Google Play and download and install the app.
- For an iPhone, iPad, or iPod touch, find CameraWindow in the App Store and download and install the app.
- After installation, use the camera to establish a connection with the smartphone (📖124, 129).

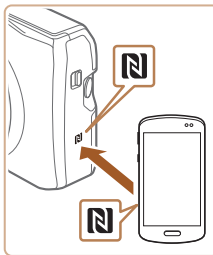

Before Use

Basic Guide

Advanced Guide

Camera Basics

Auto Mode / Hybrid Auto Mode

Other Shooting Modes

P Mode

Tv, Av, and M Mode

Playback Mode

Wi-Fi Functions

Setting Menu

Accessories

Appendix

Index





- When using NFC, keep the following points in mind.
 - Avoid strong impact between the camera and smartphone. This may damage the devices.
 - Depending on the smartphone, the devices may not recognize each other immediately. In this case, try holding the devices together in slightly different positions.
 - Do not place other objects between the camera and smartphone. Also, note that camera or smartphone covers or similar accessories may block communication.



- For details on this application (supported smartphones and included functions), refer to the Canon website.
- Not all NFC-compatible smartphones have an N-Mark (N). For details, refer to the smartphone user manual.



Preparing to Register a Computer

Prepare to register a computer. To save images to the computer wirelessly, you must install CameraWindow.



Checking Your Computer Environment

The camera can connect via Wi-Fi to computers running the following operating systems. For detailed system requirements and compatibility information, including support in new operating systems, visit the Canon website.

| | Windows | Mac OS |
|------------------|--------------------------------|--|
| Operating System | Windows 8/8.1 Windows 7 SP1 | Mac OS X 10.9 Mac OS X 10.8.2 or later Mac OS X 10.7 |



- Windows 7 Starter and Home Basic editions are not supported.
- Windows 7 N (European version) and KN (South Korean version) require a separate download and installation of Windows Media Feature Pack.

For details, check the following website.

<http://go.microsoft.com/fwlink/?LinkId=159730>

Before Use

Basic Guide

Advanced Guide

Camera Basics

Auto Mode / Hybrid Auto Mode

Other Shooting Modes

P Mode

Tv, Av, and M Mode

Playback Mode

Wi-Fi Functions

Setting Menu

Accessories

Appendix

Index



Installing the Software

Windows 7 and Mac OS X 10.8 are used here for the sake of illustration.

What you will need:

- Computer
 - USB cable (camera end: Mini-B)*
- * A USB cable is not included. Although you can install the software without using a cable, some features will not be added.

1 Download the software.

- With a computer connected to the Internet, access <http://www.canon.com/icpd/>.
- Access the site for your country or region.
- Download the software.

2 Begin the installation.

- Click [Easy Installation] and follow the on-screen instructions to complete the installation process.

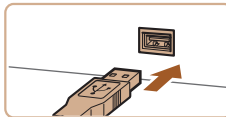
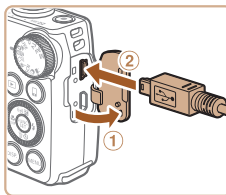

3 When a message is displayed prompting you to connect the camera, choose whether to connect or not.

When Connecting the Camera to the Computer

- With the camera turned off, open the cover (1). With the smaller plug of the USB cable in the orientation shown, insert the plug fully into the camera terminal (2).
- Insert the larger plug of the USB cable in the computer's USB port. For details about USB connections on the computer, refer to the computer user manual.
- Turn the camera on, and follow the on-screen instructions to complete the installation process.

Without Connecting the Camera

- Select [Install without connecting the device] and follow the on-screen instructions to complete the installation process.

Before Use

Basic Guide

Advanced Guide

Camera Basics

Auto Mode / Hybrid Auto Mode

Other Shooting Modes

P Mode

Tv, Av, and M Mode

Playback Mode

Wi-Fi Functions

Setting Menu

Accessories

Appendix

Index



4 Install the files.

- Installation may take some time, depending on computer performance and the Internet connection.
- Click [Finish] or [Restart] on the screen after installation.
- After installation when the camera is connected to the computer, turn the camera off before disconnecting the cable.



- Because the content and functions of software vary according to the camera model, if you have several cameras, you must use each camera to update to its latest version of the software.

Configuring the Computer for a Wi-Fi Connection (Windows Only)

On a computer running Windows, configure the following settings before connecting the camera to the computer wirelessly.



1 Confirm that the computer is connected to an access point.

- For instructions on checking your network connection, refer to the computer user manual.

2 Configure the setting.

- Click in the following order: [Start] menu ► [All Programs] ► [Canon Utilities] ► [CameraWindow] ► [Wi-Fi connection setup].
- In the application that opens, follow the on-screen instructions and configure the setting.



- The following Windows settings are configured when you run the utility in step 2.
 - Turn on media streaming.
This will enable the camera to see (find) the computer to access via Wi-Fi.
 - Turn on network discovery.
This will enable the computer to see (find) the camera.
 - Turn on ICMP (Internet Control Message Protocol).
This allows you to check the network connection status.
 - Enable Universal Plug & Play (UPnP).
This will enable network devices to detect each other automatically.
- Some security software may prevent you from completing the settings as described here. Check the settings of your security software.



Accessing the Wi-Fi Menu

Initial Connection via Wi-Fi

To start with, register a camera nickname.

This nickname will be displayed on the screen of target devices when connecting to other devices via Wi-Fi.



1 Access the Wi-Fi menu.

- Press the <▶> button to turn the camera on.
- Press the <▲> button.

2 Enter a nickname.

- Press the <FUNC SET> button to access the keyboard, and then enter a nickname (125).
- Up to 16 characters can be used.
- Press the <▲><▼> buttons or turn the <ZOOM> dial to choose [OK], and then press the <FUNC SET> button.
- The Wi-Fi menu is displayed.

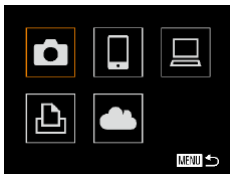
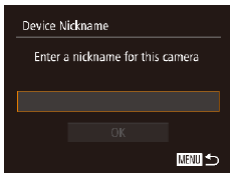

- When connecting wirelessly to any device other than a computer, a memory card must be inserted in the camera. Additionally, the memory card must contain images before you can access Web services or connect to a printer wirelessly.
- To change the camera's nickname, choose MENU (124) > [↑] tab > [Wi-Fi Settings] > [Change Device Nickname].
- If the Wi-Fi menu is not displayed but only the information changes when you press the <▲> button, first press the <▼> button to switch from detailed information display (190).
- A message will be displayed if the nickname you attempt to enter in step 2 begins with a symbol or space. Press the <FUNC SET> button and enter a different nickname.

After the Initial Wi-Fi Connection

- Once you have connected to devices via Wi-Fi, recent destinations will be listed first when you access the Wi-Fi menu by pressing the <▲> button. You can easily connect again by pressing the <▲><▼> buttons to choose the device name and then pressing the <FUNC SET> button.
- To add a new device, display the device selection screen by pressing the <◀><▶> buttons, and then configure the setting.



- If you prefer not to display recent target devices, choose MENU (124) > [↑] tab > [Wi-Fi Settings] > [Target History] > [Off].

Before Use

Basic Guide

Advanced Guide

Camera Basics

Auto Mode / Hybrid Auto Mode

Other Shooting Modes

P Mode

Tv, Av, and M Mode

Playback Mode

Wi-Fi Functions

Setting Menu

Accessories

Appendix

Index



Connecting via an Access Point

Connect to your access point via Wi-Fi as follows.
Also refer to the access point user manual.

Confirming Access Point Compatibility

Confirm that the Wi-Fi router or base station conforms to the Wi-Fi standards in "Wi-Fi" (189).

If you are already using Wi-Fi, confirm the following items. For instructions on checking network settings, refer to the access point user manual.



- If system administrator status is needed to adjust network settings, contact the system administrator for details.
- These settings are very important for network security. Exercise adequate caution when changing these settings.

Check sheet

| | |
|--|---|
| Network name (SSID/ESSID) The SSID or ESSID for the access point you use. Also called the "access point name" or "network name". | |
| Network authentication / data encryption (encryption method / encryption mode) The method for encrypting data during wireless transmission. | <ul style="list-style-type: none">○ None○ WEP (open system authentication)○ WPA-PSK (TKIP)○ WPA-PSK (AES)○ WPA2-PSK (TKIP)○ WPA2-PSK (AES) |
| Password (encryption key / network key) The key used when encrypting data during wireless transmission. Also called the "encryption key" or "network key". | |
| Key index (transmit key) The key set when WEP is used for network authentication / data encryption. | <ul style="list-style-type: none">○ 1 |

Connection methods vary depending on whether the access point supports Wi-Fi Protected Setup (WPS) or not. Refer to the user manual provided with your access point to check if it supports WPS.



- A router is a device that creates a network (LAN) structure for connecting multiple computers. A router that contains an internal Wi-Fi function is called a "Wi-Fi router".
- This guide refers to all Wi-Fi routers and base stations as "access points".
- If you use MAC address filtering on your Wi-Fi network, be sure to add the camera's MAC address to your access point. You can check your camera's MAC address by choosing MENU (24) > [f] tab > [Wi-Fi Settings] > [Check MAC Address].

Before Use

Basic Guide

Advanced Guide

Camera Basics

Auto Mode / Hybrid Auto Mode

Other Shooting Modes

P Mode

Tv, Av, and M Mode

Playback Mode

Wi-Fi Functions

Setting Menu

Accessories

Appendix

Index



Connecting to WPS-Compatible Access Points

WPS makes it easy to complete settings when connecting devices over Wi-Fi. You can use either Push Button Configuration Method or PIN Method for settings on a WPS supported device.

1 Confirm that the target device is connected to the access point.

- This step is not required when connecting to Web services.
- For instructions on checking the connection, refer to the device and access point user manuals.

2 Access the Wi-Fi menu (📖123).

3 Choose the target device.

- Choose the target device (either press the <▲><▼><◀><▶> buttons or turn the <🌀> dial), and then press the <FUNC SET> button.
- To connect to a smartphone, choose [📱].
- To connect to a computer, choose [💻].
- To connect to a printer, choose [🖨️].

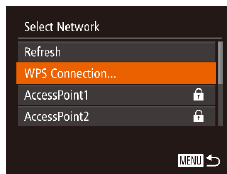
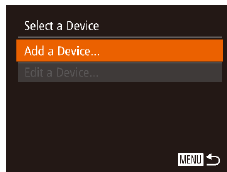
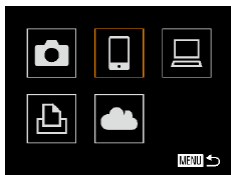

- To connect to a Web service, choose the service icon. If multiple recipients or sharing options are used with a Web service, choose the desired item on the [Select Recipient] screen (either press the <▲><▼> buttons or turn the <🌀> dial), and then press the <FUNC SET> button.

4 Choose [Add a Device].

- Press the <▲><▼> buttons or turn the <🌀> dial to choose [Add a Device], and then press the <FUNC SET> button.
- To connect to a smartphone or printer, when the [Waiting to connect] screen (📖130) is displayed, choose [Switch Network] (either press the <◀><▶> buttons or turn the <🌀> dial), and then press the <FUNC SET> button.
- A list of detected access points will be displayed.

5 Choose [WPS Connection].

- Press the <▲><▼> buttons or turn the <🌀> dial to choose [WPS Connection], and then press the <FUNC SET> button.

Before Use

Basic Guide

Advanced Guide

Camera Basics

Auto Mode / Hybrid Auto Mode

Other Shooting Modes

P Mode

Tv, Av, and M Mode

Playback Mode

Wi-Fi Functions

Setting Menu

Accessories

Appendix

Index



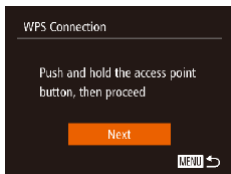
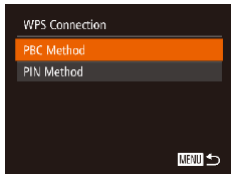

6 Choose [PBC Method].

- Press the <▲><▼> buttons or turn the <⦿> dial to choose [PBC Method], and then press the <FUNC SET> button.



8 For a smartphone connection: Start CameraWindow.

- For an NFC-compatible Android smartphone (OS version 4.0 or later), activating NFC and touching the smartphone against the camera's N-Mark (N, 119) will start CameraWindow on the smartphone.
- For other smartphones, start CameraWindow on the smartphone.
- The first time CameraWindow is opened, register a smartphone nickname to be displayed on the camera.
- Once the smartphone is recognized on the camera, the device connection screen will be displayed on the camera.

7 Establish the connection.

- On the access point, hold down the WPS connection button for a few seconds.
- On the camera, press the <FUNC SET> button to go to the next step.
- The camera will connect to the access point.
- If you have selected [📱], [📺], or [📺] in step 3, devices connected to the access point are listed on the [Select a Device] screen displayed next.
- If you have selected a Web service in step 3, go to step 12.

Before Use

Basic Guide

Advanced Guide

Camera Basics

Auto Mode / Hybrid Auto Mode

Other Shooting Modes

P Mode

Tv, Av, and M Mode

Playback Mode

Wi-Fi Functions

Setting Menu

Accessories

Appendix

Index



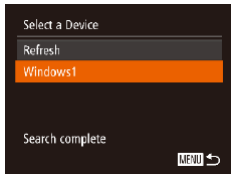

9 To connect to a smartphone, printer, or computer: Choose the target device.

- Choose the target device name (either press the <▲><▼> buttons or turn the <⊙> dial), and then press the <FUNC SET> button.
- If you have selected a smartphone, go to step 11.
- If you have selected a printer or Macintosh computer, go to step 12.

10 If you have selected a computer running Windows in step 9 for the first time: Install a driver.

- When the screen at left is displayed on the camera, click the Start menu on the computer, click [Control Panel], and then click [Add a device].
- Double-click the connected camera icon.
- Driver installation will begin.
- After driver installation is complete, and the camera and computer connection is enabled, the AutoPlay screen will be displayed. Nothing will be displayed on the camera screen.

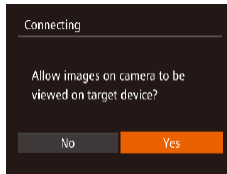
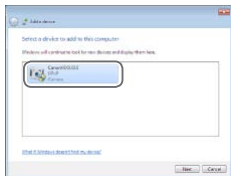
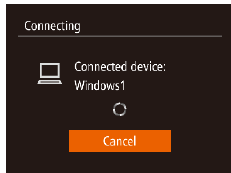

11 For a smartphone connection: Adjust the privacy setting.

- Press the <◀><▶> buttons or turn the <⊙> dial to choose [Yes], and then press the <FUNC SET> button.
- You can now use the smartphone to browse, import, or geotag (📖141) images on the camera or shoot remotely (📖141).

12 Send or print the images.

- The screen displayed when the devices are connected varies depending on the target device.
- When the camera is connected to a smartphone or Web service, an image transfer screen is displayed.
- For instructions on sending images, see "Sending Images" (📖133).
- When the camera is connected to a computer, the camera screen is blank. Follow the steps in "Saving Images to a Computer" (📖136) to save images to the computer.
- When the camera is connected to a printer, you can print by following the same steps as for printing via USB. For details, see "Printing Images" (📖163).

Before Use

Basic Guide

Advanced Guide

Camera Basics

Auto Mode / Hybrid Auto Mode

Other Shooting Modes

P Mode

Tv, Av, and M Mode

Playback Mode

Wi-Fi Functions

Setting Menu

Accessories

Appendix

Index





- All images in the camera can be viewed from the connected smartphone when you choose [Yes] in step 11. To keep camera images private, so that they cannot be viewed from the smartphone, choose [No] in step 11.
- To change privacy settings for smartphones added to the list, choose the smartphone whose settings you want to change from [Edit a Device] in step 4, and then choose [View Settings].



- If you chose [PIN Method] in step 6, a PIN code will be displayed on the screen. Be sure to set this code in the access point. Choose a device in the [Select a Device] screen. For further details, refer to the user manual included with your access point.
- To add multiple destinations, repeat this procedure from the first step.

Previous Access Points

You can reconnect to any previous access points automatically by following step 4 in “Connecting to WPS-Compatible Access Points” (125).

- To reconnect to the access point, confirm that the target device is already connected to it, and then follow the procedure from step 9. Note that this step is not required when connecting to Web services.
- To switch access points, choose [Switch Network] on the screen displayed when you establish a connection, and then follow the procedure from step 5.



Connecting to Access Points in the List

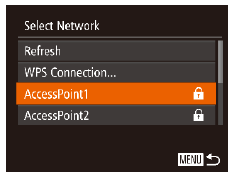

1 View the listed access points.

- View the listed networks (access points) as described in steps 1 – 4 of “Connecting to WPS-Compatible Access Points” (125).

2 Choose an access point.

- Press the <▲><▼> buttons or turn the <FUNC SET> dial to choose a network (access point), and then press the <FUNC SET> button.

3 Enter the access point password.

- Press the <FUNC SET> button to access the keyboard, and then enter the password (124).
- Press the <▲><▼> buttons or turn the <FUNC SET> dial to choose [Next], and then press the <FUNC SET> button.

Before Use

Basic Guide

Advanced Guide

Camera Basics

Auto Mode / Hybrid Auto Mode

Other Shooting Modes

P Mode

Tv, Av, and M Mode

Playback Mode

Wi-Fi Functions

Setting Menu

Accessories

Appendix

Index



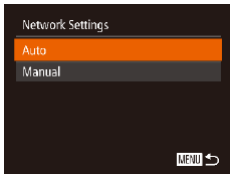

4 Choose [Auto].

- Press the <▲><▼> buttons or turn the <⊙> dial to choose [Auto], and then press the <FUNC SET> button.
- If you selected [📱], [🖨️], or [💻] as the target device, see “Connecting to WPS-Compatible Access Points”, starting with step 9 (📖127).
- If you selected a Web service as the destination, see “Connecting to WPS-Compatible Access Points”, starting with step 12 (📖127).



- To determine the access point password, check on the access point itself or refer to the user manual.
- Up to 16 access points will be displayed. If no access points are detected, choose [Manual Settings] in step 2 to manually set an access point. Follow on-screen instructions and enter an SSID, security settings, and a password.
- When you use an access point that you have already connected to for connecting to another device, [*] is displayed for the password in step 3. To use the same password, choose [Next] (either press the <▲><▼> buttons or turn the <⊙> dial) and press the <FUNC SET> button.

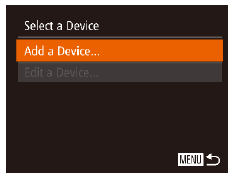

Connecting without an Access Point

When connecting to a smartphone or printer via Wi-Fi, you can use the camera as an access point (Camera Access Point mode) instead of using another access point.

Similarly, no access point is used in camera-to-camera connections (📖132).

1 Access the Wi-Fi menu (📖123).

2 Choose the target device.

- Choose the target device (either press the <▲><▼><◀><▶> buttons or turn the <⊙> dial), and then press the <FUNC SET> button.
- To connect to a smartphone, choose [📱].
- To connect to a printer, choose [🖨️].

3 Choose [Add a Device].

- Press the <▲><▼> buttons or turn the <⊙> dial to choose [Add a Device], and then press the <FUNC SET> button.

Before Use

Basic Guide

Advanced Guide

Camera Basics

Auto Mode / Hybrid Auto Mode

Other Shooting Modes

P Mode

Tv, Av, and M Mode

Playback Mode

Wi-Fi Functions

Setting Menu

Accessories

Appendix

Index



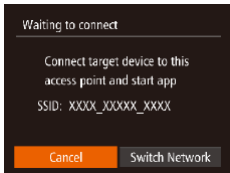

- The camera's SSID is displayed.



4 Connect the target device to the network.

- In the smartphone or printer's Wi-Fi setting menu, choose the SSID (network name) displayed on the camera to connect to it.

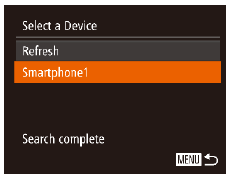

5 For a smartphone connection: Start CameraWindow.

- For an NFC-compatible Android smartphone (OS version 4.0 or later), activating NFC and touching the smartphone against the camera's N-Mark (N, 119) will start CameraWindow on the smartphone.
- For other smartphones, start CameraWindow on the smartphone.
- The first time CameraWindow is opened, register a smartphone nickname to be displayed on the camera.
- Once the smartphone is recognized on the camera, the device connection screen will be displayed on the camera.

6 Choose the target device.

- Choose the target device name (either press the <▲><▼> buttons or turn the <⊙> dial), and then press the <FUNC/SET> button.

Before Use

Basic Guide

Advanced Guide

Camera Basics

Auto Mode / Hybrid Auto Mode

Other Shooting Modes

P Mode

Tv, Av, and M Mode

Playback Mode

Wi-Fi Functions

Setting Menu

Accessories

Appendix

Index



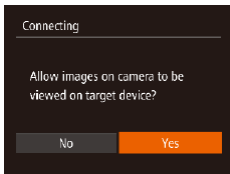

7 For a smartphone connection: Adjust the privacy setting.

- Press the <<|>> buttons or turn the dial to choose [Yes], and then press the button.
- You can now use the smartphone to browse, import, or geotag (📖141) images on the camera or shoot remotely (📖141).

8 Send or print the images.

- The screen displayed when the devices are connected varies depending on the target device.
- When the camera is connected to a smartphone, an image transfer screen is displayed.
- For instructions on sending images, see “Sending Images” (📖133).
- When the camera is connected to a printer, you can print by following the same steps as for printing via USB. For details, see “Printing Images” (📖163).



- ! All images in the camera can be viewed from the connected smartphone when you choose [Yes] in step 7. To keep camera images private, so that they cannot be viewed from the smartphone, choose [No] in step 7.
- To change privacy settings for smartphones added to the list, choose the smartphone whose settings you want to change from [Edit a Device] in step 3, and then choose [View Settings].



- To add multiple devices, repeat this procedure from the first step.
- For better security, you can require password input on the screen in step 3 by accessing MENU (📖24) and choosing [↑↑] tab > [Wi-Fi Settings] > [Password] > [On]. In this case, in the password field on the device in step 4, enter the password displayed on the camera.

Before Use

Basic Guide

Advanced Guide

Camera Basics

Auto Mode / Hybrid Auto Mode

Other Shooting Modes

P Mode

Tv, Av, and M Mode

Playback Mode

Wi-Fi Functions

Setting Menu

Accessories

Appendix

Index



Previous Access Points

You can reconnect to any previous access points automatically by following step 3 in “Connecting without an Access Point” (📖129).

- To use the camera as an access point, choose [Switch Network] on the screen displayed when you establish a connection, and then choose [Camera Access Point Mode].
- When reconnecting via a previous access point, connect the target device to the access point in step 4.
- To switch access points, choose [Switch Network] on the screen displayed when you establish a connection, and then follow the procedure in “Connecting to WPS-Compatible Access Points” from step 5 (📖125).

Connecting to Another Camera

Connect two cameras via Wi-Fi and send images between them as follows.



- Only Canon-brand cameras equipped with a Wi-Fi function can be connected to wirelessly. Even Canon-brand cameras that support Eye-Fi cards cannot be connected to if they do not have a Wi-Fi function. You cannot connect to PowerShot SD430 DIGITAL ELPH WIRELESS/DIGITAL IXUS WIRELESS cameras with this camera.

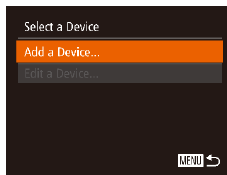
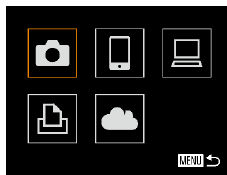

1 Access the Wi-Fi menu (📖123).

2 Choose camera.

- Press the <▲><▼><◀><▶> buttons or turn the <⦿> dial to choose [📷], and then press the <FUNC/SET> button.

3 Choose [Add a Device].

- Press the <▲><▼> buttons or turn the <⦿> dial to choose [Add a Device], and then press the <FUNC/SET> button.
- Follow steps 1 – 3 on the target camera too.
- Camera connection information will be added when [Start connection on target camera] is displayed on both camera screens.

Before Use

Basic Guide

Advanced Guide

Camera Basics

Auto Mode / Hybrid Auto Mode

Other Shooting Modes

P Mode

Tv, Av, and M Mode

Playback Mode

Wi-Fi Functions

Setting Menu

Accessories

Appendix

Index





- When the target camera has been added successfully, the image transfer screen will be displayed. Proceed to “Sending Images” (📖133).



- To add multiple cameras, repeat this procedure from the first step.
- Once a camera is added, the camera name will be displayed on the screen in step 3. To connect to a camera again, simply choose the camera name from the list.

Sending Images

Send images wirelessly to destinations registered on the camera as follows. Note that when images are sent to a computer, the computer is used instead of the camera (📖136).

Sending Images Individually



1 Choose an image.

- Turn the <⊙> dial to choose an image to send.

Before Use

Basic Guide

Advanced Guide

Camera Basics

Auto Mode / Hybrid Auto Mode

Other Shooting Modes

P Mode

Tv, Av, and M Mode

Playback Mode

Wi-Fi Functions

Setting Menu

Accessories

Appendix

Index



2 Send the image.

- Press the <◀><▶> buttons to choose [Send this image], and then press the <FUNC SET> button.
- When uploading to YouTube, read the terms of service, choose [I Agree], and press the <FUNC SET> button.
- Image transfer will begin. The screen darkens during image transfer.
- After images are uploaded to a Web service, [OK] is displayed. Press the <FUNC SET> button to return to the playback screen.
- After sending images to a camera or smartphone, [Transfer completed] will be displayed, and the display will return to the image transfer screen.



- For movies that you do not compress (112), a separate, compressed file is sent instead of the original file. Note that this may delay transmission, and the file cannot be sent unless there is enough space for it on the memory card.



- Keep your fingers or other objects off the Wi-Fi antenna area (113). Covering this may decrease the speed of your image transfers.
- Depending on the condition of the network you are using, it may take a long time to send movies. Be sure to keep an eye on the camera battery level.
- When sending movies to smartphones, note that the supported image quality varies depending on the smartphone. For details, refer to the smartphone user manual.
- To disconnect from the camera, press the <MENU> button, choose [OK] on the confirmation screen (either press the <◀><▶> buttons or turn the <DISP> dial), and then press the <FUNC SET> button. You can also use the smartphone to end the connection.
- On the screen, wireless signal strength is indicated by the following icons. [Full] high, [3/4] medium, [2/4] low, [1/4] weak
- Sending images to Web services will take less time when resending images you have already sent that are still on the CANON iMAGE GATEWAY server.



Choosing the Image Resolution (Size)

On the image transfer screen, choose [S] by pressing the <▲><▼> buttons, and then press the <FUNC SET> button. On the next screen, choose the resolution by pressing the <▲><▼> buttons, and then press the <FUNC SET> button.

- To send images at original size, select [No] as the resizing option.
- Choosing [M2] or [S] will resize images that are larger than the selected size before sending.



- Movies cannot be resized.

Before Use

Basic Guide

Advanced Guide

Camera Basics

Auto Mode / Hybrid Auto Mode

Other Shooting Modes

P Mode

Tv, Av, and M Mode

Playback Mode

Wi-Fi Functions

Setting Menu

Accessories

Appendix

Index



Sending Multiple Images



1 Choose [Select and send].

- Press the <◀><▶> buttons to choose [Select and send], and then press the <FUNC SET> button.



2 Choose images.

- Press the <▲><▼><◀><▶> buttons to choose an image to send, and then press the <FUNC SET> button. [✓] is displayed.
- To cancel selection, press the <FUNC SET> button again. [✓] is no longer displayed.
- Repeat this process to choose additional images.
- After you finish choosing images, press the <MENU> button.

3 Send the images.

- Press the <◀><▶> buttons or turn the <Q> dial to choose [Send], and then press the <FUNC SET> button.



- Up to 50 images can be sent together at once. One movie up to five minutes (or one digest movie up to 13 minutes) can be sent. However, Web services may limit the number of images or length of movies you can send. For details, refer to the Web service you are using.
- You can also choose images in step 2 by moving the zoom lever twice toward <Q> to access single-image display and then pressing the <◀><▶> buttons or turning the <Q> dial.
- In step 3, you can choose the desired resolution (size) of your images before sending (46).

Before Use

Basic Guide

Advanced Guide

Camera Basics

Auto Mode / Hybrid Auto Mode

Other Shooting Modes

P Mode

Tv, Av, and M Mode

Playback Mode

Wi-Fi Functions

Setting Menu

Accessories

Appendix

Index



Adding Comments

Using the camera, you can add comments to images that you send to e-mail addresses, social networking services, etc. The number of characters and symbols that can be entered may differ depending on the Web service.

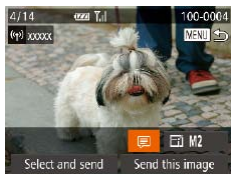

1 Access the screen for adding comments.

- Press the <▲><▼><◀><▶> buttons to choose [M], and then press the <FUNC/SET> button.

2 Add a comment (📖25).

3 Send the image.

- Follow the steps in “Sending Images Individually” (📖133) to send the image.



- When a comment is not entered, the comment set in CANON IMAGE GATEWAY is automatically sent.

Saving Images to a Computer

When sending images to a computer, use the computer instead of the camera.

Windows 7 and Mac OS X 10.8 are used here for the sake of illustration.

For other functions, refer to the help system of the relevant software (some software excluded).

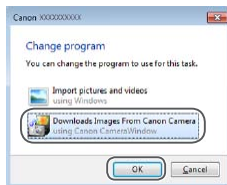

1 Display CameraWindow.

- Windows: Access CameraWindow by clicking [Downloads Images From Canon Camera].
- Mac OS: CameraWindow is automatically displayed when a Wi-Fi connection is established between the camera and computer.

2 Import images.

- Click [Import Images from Camera], and then click [Import Untransferred Images].
- Images are now saved to the Pictures folder on the computer, in separate folders named by date.
- Click [OK] in the screen that is displayed after image import is complete. For instructions on viewing images on a computer, refer to “Software Instruction Manual” (📖160).

Before Use

Basic Guide

Advanced Guide

Camera Basics

Auto Mode / Hybrid Auto Mode

Other Shooting Modes

P Mode

Tv, Av, and M Mode

Playback Mode

Wi-Fi Functions

Setting Menu

Accessories

Appendix

Index





- Movies will take longer to import since the file size is larger than still images.
- To disconnect from the camera, turn off the camera.
- You can also specify to save all images or only selected images to the computer, and you can change the destination folder. Refer to “Software Instruction Manual” (📖 160) for details.
- Windows 7: If the screen in step 2 is not displayed, click the [📱] icon in the taskbar.
- Mac OS: If CameraWindow is not displayed, click the [CameraWindow] icon in the Dock.
- Although you can save images to a computer simply by connecting your camera to the computer without using the software, the following limitations apply.
 - It may take a few minutes after you connect the camera to the computer until camera images are accessible.
 - Images shot in vertical orientation may be saved in horizontal orientation.
 - Image protection settings may be cleared from images saved to a computer.
 - Some problems may occur when saving images or image information, depending on the operating system version, the software in use, or image file sizes.
- Some functions provided by the software may not be available, such as movie editing.

Using the <📱> Button

Once you have registered a smartphone or Image Sync (📖 139) to the <📱> button, you can connect to the registered destination simply by pressing the <📱> button.

Registering a Smartphone to the <📱> Button

Once you have connected to a smartphone initially via Wi-Fi by pressing the <📱> button, you can simply press the <📱> button after that to connect again for viewing and saving camera images on connected devices.



1 Press the <📱> button.

2 Choose the destination.

- Press the <◀▶>> buttons or turn the <⚙️> dial to choose [📱], and then press the <🔘> button.

Before Use

Basic Guide

Advanced Guide

Camera Basics

Auto Mode / Hybrid Auto Mode

Other Shooting Modes

P Mode

Tv, Av, and M Mode

Playback Mode

Wi-Fi Functions

Setting Menu

Accessories

Appendix

Index



3 Establish the connection.

- Connect to the smartphone as described in steps 5 – 9 in “Connecting to WPS- Compatible Access Points” (📖125 – 127) or steps 4 – 6 in “Connecting without an Access Point” (📖130).
- After a connection is established with the smartphone, the smartphone nickname is displayed on the camera. (This screen will close in about one minute.)
- You can now use the smartphone to import images from the camera. (The camera cannot be used to send images to the smartphone.)
- Use the smartphone to end the connection; the camera will automatically turn off.
- From now on, you can simply press the <📱> button to connect to the registered smartphone.



- When you are in the vicinity of an access point that you have previously connected to, the camera will automatically connect to it in step 2. To change access points, select [Switch Network] from the screen that will be displayed when the connection is being established, and follow steps 5 – 9 in “Connecting to WPS- Compatible Access Points” (📖125 – 127).
- All images in the camera can be viewed from the connected smartphone. Note that if you have assigned the <📱> button, [View Settings] (📖143) is not available.



- One smartphone can be registered to the <📱> button. If you wish to register a different smartphone, clear the one currently registered (📖139) first.

Registering Image Sync to the <📱> Button

By registering Image Sync to the <📱> button, you can simply press the <📱> button to send any unsent images on the memory card to a computer via CANON IMAGE GATEWAY. For details on Image Sync, see “Sending Images Automatically (Image Sync)” (📖139).



1 Prepare the camera.

- Register [📱] as the destination (📖117 – 119).
- Install the software on the destination computer, and configure the camera settings (📖121).

2 Press the <📱> button.

3 Choose the destination.

- Press the <◀▶>> buttons or turn the <🔧> dial to choose [📱], and then press the <🔘> button.
- The camera will automatically reconnect to any previous access points and send the images. (📖139)
- From now on, you can simply press the <📱> button to send images.

Before Use

Basic Guide

Advanced Guide

Camera Basics

Auto Mode / Hybrid Auto Mode

Other Shooting Modes

P Mode

Tv, Av, and M Mode

Playback Mode

Wi-Fi Functions

Setting Menu

Accessories

Appendix

Index



Clearing Registered Destinations

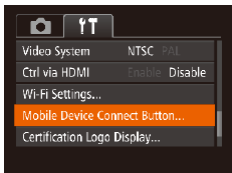

- Press the <MENU> button, and then choose [Mobile Device Connect Button] on the [Fn] tab (144).
- Press the <<>> buttons or turn the <OK> dial to choose [OK], and then press the <Fn SET> button.
- After a confirmation message is displayed, press the <Fn SET> button.



- Registered destinations are also cleared when you reset Wi-Fi settings (144).

Sending Images Automatically (Image Sync)

Images on the memory card that have not been transferred already can be sent to a computer or Web services via CANON iMAGE GATEWAY. Note that images cannot be sent only to Web services.

Initial Preparations

Install and configure the software on the destination computer.



1 Install the software.

- Install the software on a computer connected to the Internet (121).

2 Register the camera.

- Windows: In the taskbar, right-click [], and then click [Add new camera].
- Mac OS: In the menu bar, click [], and then click [Add new camera].
- A list of cameras linked to CANON iMAGE GATEWAY (117) is displayed. Choose the camera from which images are to be sent.
- Once the camera is registered and the computer is ready to receive images, the icon changes to [].

Before Use

Basic Guide

Advanced Guide

Camera Basics

Auto Mode / Hybrid Auto Mode

Other Shooting Modes

P Mode

Tv, Av, and M Mode

Playback Mode

Wi-Fi Functions

Setting Menu

Accessories

Appendix

Index



3 Choose the type of images to send (only when sending movies with images).

- Press the <MENU> button, and then choose [Wi-Fi Settings] on the [↑↓] tab (📖24).
- Press the <▲><▼> buttons to choose [Image Sync], and then press the <◀><▶> buttons to choose [Stills/Movies].



- To choose a Web service as the destination, follow the steps in "Registering Other Web Services" (📖119) to update the camera settings.



Sending Images

Images sent from the camera are automatically saved to the computer. If the computer that you intend to send images to is turned off, the images will be stored temporarily on the CANON iIMAGE GATEWAY server. Stored images are regularly erased, so make sure to turn on the computer and save the images.

- Follow the steps in "Connecting to WPS-Compatible Access Points" (📖125) to choose [📶].
- Once the connection is established, the images are sent.
- When the images have been sent successfully to the CANON iIMAGE GATEWAY server, [📶] is displayed on the screen.
- Images are automatically saved to the computer when you turn it on.
- Images are automatically sent to Web services from the CANON iIMAGE GATEWAY server, even if the computer is off.



- When sending images, you should use a fully charged battery pack or an AC adapter kit (sold separately, 📖156).



- Even if images were imported to the computer through a different method, any images not sent to the computer via CANON iIMAGE GATEWAY will be sent to the computer.
- Sending is faster when the destination is a computer on the same network as the camera, because images are sent via the access point instead of CANON iIMAGE GATEWAY. Note that images stored on the computer are sent to CANON iIMAGE GATEWAY, so the computer must be connected to the Internet.



Geotagging Images on the Camera

GPS data recorded on a smartphone using the dedicated CameraWindow application (📖119) can be added to images on the camera. Images are tagged with information including the latitude, longitude, and elevation.



- Before shooting, make sure the date and time and your home time zone are set correctly. (See “Setting the Date and Time” (📖14).) Additionally, in [Time Zone] (📖147), specify any shooting destinations that are in other time zones.
- The smartphone you will use for geotagging must be authorized to view the images on the camera (📖127, 131).
- Others may be able to locate or identify you by using location data in your geotagged still images or movies. Be careful when sharing these images with others, as when posting images online where many others can view them.

Shooting Remotely

As you check a shooting screen on your smartphone, you can use it to shoot remotely.

1 Secure the camera.

- Once remote shooting begins, the camera lens will come out. Lens motion from zooming may also move the camera out of position. Keep the camera still by mounting it on a tripod or taking other measures.

2 Connect the camera and smartphone (📖115).

- In the privacy settings (📖127, 131), choose [Yes].

3 Choose remote shooting.

- In CameraWindow (📖119) on the smartphone, choose remote shooting.
- The camera lens will come out. Do not press near the lens, and make sure no objects will obstruct it.
- Once the camera is ready for remote shooting, a live image from the camera will be displayed on the smartphone.
- At this time, a message is displayed on the camera, and all operations except pressing the power button are disabled.

Before Use

Basic Guide

Advanced Guide

Camera Basics

Auto Mode / Hybrid Auto Mode

Other Shooting Modes

P Mode

Tv, Av, and M Mode

Playback Mode

Wi-Fi Functions

Setting Menu

Accessories

Appendix

Index



4 Shoot.

- Use the smartphone to shoot.



- The camera works in [P] mode during remote shooting. However, some FUNC. and MENU settings you have configured in advance may be changed automatically.
- Movie shooting is not available.
- In camera settings, the smartphone must be allowed to view camera images (127, 131).



- Any jerky subject motion shown on the smartphone due to the connection environment will not affect recorded images.
- No AF frames are displayed. Capture a test image to check the focus.
- Captured images are not transferred to the smartphone. Use the smartphone to browse and import images from the camera.
- Remote control is also possible from the smartphone assigned to the <[Smartphone Icon]> button (137).

Editing or Erasing Wi-Fi Settings

Edit or erase Wi-Fi settings as follows.

Editing Connection Information

1 Access the Wi-Fi menu (123).

2 Choose a device to edit.

- Press the <▲><▼><◀><▶> buttons or turn the <[Gear Icon]> dial to choose the icon of the device to edit, and then press the <[FUNC SET]> button.

3 Choose [Edit a Device].

- Press the <▲><▼> buttons or turn the <[Gear Icon]> dial to choose [Edit a Device], and then press the <[FUNC SET]> button.

4 Choose a device to edit.

- Press the <▲><▼> buttons or turn the <[Gear Icon]> dial to choose the device to edit, and then press the <[FUNC SET]> button.

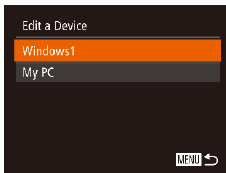
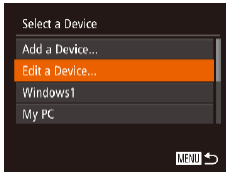
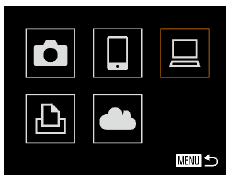

Before Use

Basic Guide

Advanced Guide

Camera Basics

Auto Mode / Hybrid Auto Mode

Other Shooting Modes

P Mode

Tv, Av, and M Mode

Playback Mode

Wi-Fi Functions

Setting Menu

Accessories





Appendix

Index



5 Choose an item to edit.

- Press the <▲><▼> buttons or turn the <⦿> dial to choose an item to edit, and then press the <FUNC SET> button.
- The items you can change depend on what device or service the camera will access.

| Configurable Items | Connection | | | | |
|---------------------------------|---|---|---|---|--------------|
| |  |  |  |  | Web Services |
| [Change Device Nickname] (📖143) | <input type="radio"/> | <input type="radio"/> | <input type="radio"/> | <input type="radio"/> | – |
| [View Settings] (📖127, 131) | – | <input type="radio"/> | – | – | – |
| [Erase Connection Info] (📖143) | <input type="radio"/> | <input type="radio"/> | <input type="radio"/> | <input type="radio"/> | – |

O : Configurable – : Not configurable

Changing a Device Nickname

You can change the device nickname (display name) that is displayed on the camera.

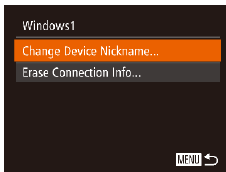

- Following step 5 in “Editing Connection Information” (📖143), choose [Change Device Nickname] and press the <FUNC SET> button.
- Select the input field and press the <FUNC SET> button. Use the keyboard displayed to enter a new nickname (📖25).

Erasing Connection Information

Erase connection information (information about devices that you have connected to) as follows.

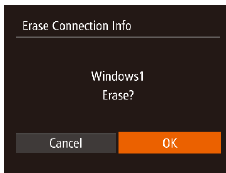

- Following step 5 in “Editing Connection Information” (📖143), choose [Erase Connection Info] and press the <FUNC SET> button.
- After [Erase?] is displayed, press the <◀><▶> buttons or turn the <⦿> dial to choose [OK], and then press the <FUNC SET> button.
- The connection information will be erased.

Before Use

Basic Guide

Advanced Guide

Camera Basics

Auto Mode / Hybrid Auto Mode

Other Shooting Modes

P Mode

Tv, Av, and M Mode

Playback Mode

Wi-Fi Functions

Setting Menu

Accessories

Appendix

Index



Returning the Wi-Fi Settings to Default

Return the Wi-Fi settings to default if you transfer ownership of the camera to another person, or dispose of it.

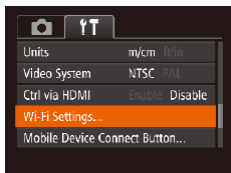

1 Choose [Wi-Fi Settings].

- Press the <MENU> button, and then choose [Wi-Fi Settings] on the [fT] tab (📖24).

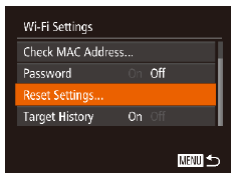

2 Choose [Reset Settings].

- Press the <▲><▼> buttons or turn the <⦿> dial to choose [Reset Settings], and then press the <FUNC SET> button.

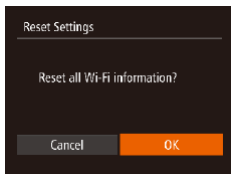

3 Restore the default settings.

- Press the <◀><▶> buttons or turn the <⦿> dial to choose [OK], and then press the <FUNC SET> button.
- The Wi-Fi settings are now reset.



- Resetting the Wi-Fi settings will also clear all Web service settings. Be sure that you want to reset all Wi-Fi settings before using this option.
- To reset other settings (aside from Wi-Fi) to defaults, choose [Reset All] in the [fT] tab (📖152).

Before Use

Basic Guide

Advanced Guide

Camera Basics

Auto Mode / Hybrid Auto Mode

Other Shooting Modes

P Mode

Tv, Av, and M Mode

Playback Mode

Wi-Fi Functions

Setting Menu

Accessories

Appendix

Index



Setting Menu

Customize or adjust basic camera functions for greater convenience

| | | | |
|--|------------|------------------------------------|-----|
| Adjusting Basic Camera Functions..... | 146 | Formatting Memory Cards | 149 |
| Silencing Camera Operations | 146 | File Numbering | 151 |
| Adjusting the Volume | 146 | Date-Based Image Storage..... | 151 |
| Hiding Hints and Tips | 146 | Metric / Non-Metric Display | 151 |
| Date and Time..... | 147 | Checking Certification Logos | 152 |
| World Clock..... | 147 | Display Language | 152 |
| Lens Retraction Timing | 147 | Adjusting Other Settings | 152 |
| Using Eco Mode..... | 148 | Restoring Defaults..... | 152 |
| Power-Saving Adjustment | 148 | | |
| Screen Brightness..... | 149 | | |
| Hiding the Start-Up Screen | 149 | | |

Before Use

Basic Guide

Advanced Guide

Camera Basics

Auto Mode / Hybrid
Auto Mode

Other Shooting
Modes

P Mode

Tv, Av, and M Mode

Playback Mode

Wi-Fi Functions

Setting Menu

Accessories

Appendix

Index



Adjusting Basic Camera Functions

MENU (📖24) functions on the (📷) tab can be configured. Customize commonly used functions as desired, for greater convenience.

Silencing Camera Operations

Silence camera sounds and movies as follows.

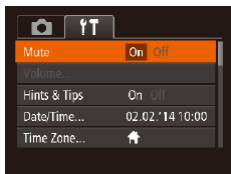

- Choose [Mute], and then choose [On].



- Operation can also be silenced by holding down the <DISP.> button as you turn the camera on.
- Sound is not played during movies (📖89) if you mute camera sounds. To restore sound during movies, press the <▲> button. Adjust volume with the <▲><▼> buttons, as needed.

Adjusting the Volume

Adjust the volume of individual camera sounds as follows.

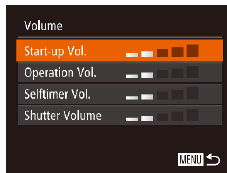

- Choose [Volume], and then press the <FUNC/SET> button.
- Choose an item, and then press the <◀><▶> buttons to adjust the volume.

Hiding Hints and Tips

Hints and tips are normally shown when you choose FUNC. (📖23) or MENU (📖24) items. If you prefer, you can deactivate this information.

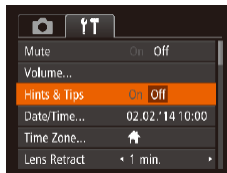

- Choose [Hints & Tips], and then choose [Off].

Before Use

Basic Guide

Advanced Guide

Camera Basics

Auto Mode / Hybrid Auto Mode

Other Shooting Modes

P Mode

Tv, Av, and M Mode

Playback Mode

Wi-Fi Functions

Setting Menu

Accessories

Appendix

Index



Date and Time

Adjust the date and time as follows.

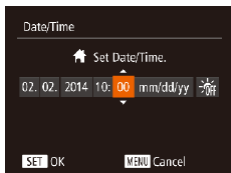

- Choose [Date/Time], and then press the button.
- Press the buttons to choose an option, and then adjust the setting, either by pressing the buttons or turning the dial.

World Clock

To ensure that your shots will have the correct local date and time when you travel abroad, simply register the destination in advance and switch to that time zone. This convenient feature eliminates the need to change the Date/Time setting manually. Before using the world clock, be sure to set the date and time and your home time zone, as described in “Setting the Date and Time” (14).

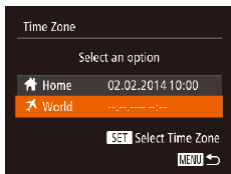

1 Specify your destination.

- Choose [Time Zone], and then press the button.
- Press the buttons or turn the dial to choose [World], and then press the button.
- Press the buttons to choose the destination.
- To set daylight saving time (1 hour ahead), choose [DST] by pressing the buttons or turning the dial, and then choose [DST] by pressing the buttons.
- Press the button.

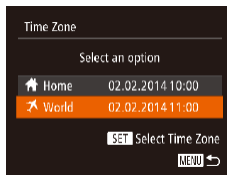

2 Switch to the destination time zone.

- Press the buttons or turn the dial to choose [World], and then press the button.
- [World] is now shown on the shooting screen (178).



- Adjusting the date or time while in [World] mode (15) will automatically update your [Home] time and date.

Lens Retraction Timing

The lens is normally retracted for safety about one minute after you press the button in Shooting mode (21). To have the lens retracted immediately after you press the button, set the retraction timing to [0 sec.].



- Choose [Lens Retract], and then choose [0 sec.].

Before Use

Basic Guide

Advanced Guide

Camera Basics

Auto Mode / Hybrid Auto Mode

Other Shooting Modes

P Mode

Tv, Av, and M Mode

Playback Mode

Wi-Fi Functions

Setting Menu

Accessories

Appendix

Index



Using Eco Mode

This function allows you to conserve battery power in Shooting mode. When the camera is not in use, the screen quickly darkens to reduce battery consumption.

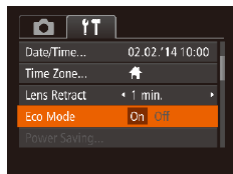

1 Configure the setting.

- Choose [Eco Mode], and then choose [On].
- [ECO] is now shown on the shooting screen (📖178).
- The screen darkens when the camera is not used for approximately two seconds; approximately ten seconds after darkening, the screen turns off. The camera turns off after approximately three minutes of inactivity.

2 Shoot.

- To activate the screen and prepare for shooting when the screen is off but the lens is still out, press the shutter button halfway.

Power-Saving Adjustment

Adjust the timing of automatic camera and screen deactivation (Auto Power Down and Display Off, respectively) as needed (📖21).

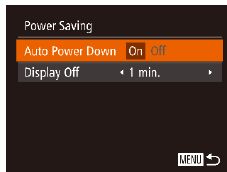

- Choose [Power Saving], and then press the <FUNC/SET> button.
- After choosing an item, press the <◀▶> buttons to adjust it as needed.



- To conserve battery power, you should normally choose [On] for [Auto Power Down] and [1 min.] or less for [Display Off].



- The [Display Off] setting is applied even if you set [Auto Power Down] to [Off].
- These power-saving functions are not available when you have set Eco mode (📖148) to [On].

Before Use

Basic Guide

Advanced Guide

Camera Basics

Auto Mode / Hybrid Auto Mode

Other Shooting Modes

P Mode

Tv, Av, and M Mode

Playback Mode

Wi-Fi Functions

Setting Menu

Accessories

Appendix

Index



Screen Brightness

Adjust screen brightness as follows.

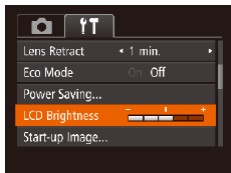

- Choose [LCD Brightness], and then press the <◀><▶> buttons to adjust the brightness.



- For maximum brightness, press and hold the <DISP.> button for at least two seconds when the shooting screen is displayed or when in single-image display. (This will override the [LCD Brightness] setting on the [fT] tab.) To restore the original brightness, press and hold the <DISP.> button again for at least two seconds or restart the camera.

Hiding the Start-Up Screen

If you prefer, you can deactivate display of the start-up screen normally shown when you turn the camera on.



- Choose [Start-up Image], and then choose [Off].

Formatting Memory Cards

Before using a new memory card or a card formatted in another device, you should format the card with this camera.

Formatting erases all data on a memory card. Before formatting, copy images on the memory card to a computer, or take other steps to back them up.

1 Access the [Format] screen.

- Choose [Format], and then press the <FUNC/SET> button.

2 Choose [OK].

- Press the <▲><▼> buttons to choose [Cancel], choose [OK] (either press the <◀><▶> buttons or turn the <◉> dial), and then press the <FUNC/SET> button.

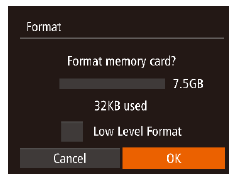

Before Use

Basic Guide

Advanced Guide

Camera Basics

Auto Mode / Hybrid Auto Mode

Other Shooting Modes

P Mode

Tv, Av, and M Mode

Playback Mode

Wi-Fi Functions

Setting Menu

Accessories

Appendix

Index



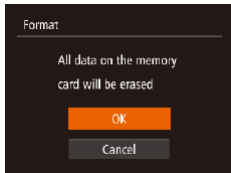

3 Format the memory card.

- To begin the formatting process, press the <▲><▼> buttons or turn the <⊙> dial to choose [OK], and then press the <FUNC SET> button.
- When formatting is finished, [Memory card formatting complete] is displayed. Press the <FUNC SET> button.



- Formatting or erasing data on a memory card only changes file management information on the card and does not erase the data completely. When transferring or disposing of memory cards, take steps to protect personal information if necessary, as by physically destroying cards.



- The total card capacity indicated on the formatting screen may be less than the advertised capacity.

■ Low-Level Formatting

Perform low-level formatting in the following cases: [Memory card error] is displayed, the camera is not working correctly, card image reading/writing is slower, continuous shooting is slower, or movie recording suddenly stops. Low-level formatting erases all data on a memory card. Before low-level formatting, copy images on the memory card to a computer, or take other steps to back them up.

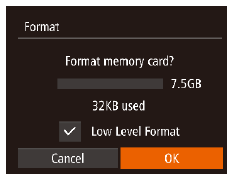

- On the screen in step 1 of “Formatting Memory Cards” (📖149), press the <▲><▼> buttons or turn the <⊙> dial to choose [Low Level Format], and then press the <◀><▶> buttons to select this option. A [✓] icon is displayed.
- Follow steps 2 – 3 in “Formatting Memory Cards” (📖149) to continue with the formatting process.



- Low-level formatting takes longer than “Formatting Memory Cards” (📖149), because data is erased from all storage regions of the memory card.
- You can cancel low-level formatting in progress by choosing [Stop]. In this case, all data will be erased, but the memory card can be used normally.

Before Use

Basic Guide

Advanced Guide

Camera Basics

Auto Mode / Hybrid Auto Mode

Other Shooting Modes

P Mode

Tv, Av, and M Mode

Playback Mode

Wi-Fi Functions

Setting Menu

Accessories

Appendix

Index



File Numbering

Your shots are automatically numbered in sequential order (0001 – 9999) and saved in folders that store up to 2,000 images each. You can change how the camera assigns file numbers.

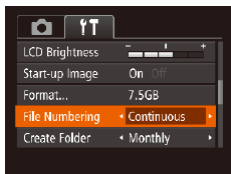

- Choose [File Numbering], and then choose an option.

| | |
|------------|---|
| Continuous | Images are numbered consecutively (until the 9999th shot is taken/saved) even if you switch memory cards. |
| Auto Reset | Image numbering is reset to 0001 if you switch memory cards, or when a new folder is created. |



- Regardless of the option selected in this setting, shots may be numbered consecutively after the last number of existing images on newly inserted memory cards. To start saving shots from 0001, use an empty (or formatted (📖149)) memory card.
- Refer to "Software Instruction Manual" (📖160) for information on the card folder structure and image formats.

Date-Based Image Storage

Instead of saving images in folders created each month, you can have the camera create folders each day you shoot to store shots taken that day.

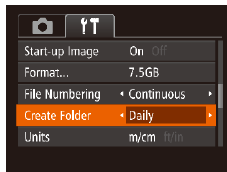

- Choose [Create Folder], and then choose [Daily].
- Images will now be saved in folders created on the shooting date.

Metric / Non-Metric Display

Change the unit of measurement shown in GPS elevation information (📖141), the zoom bar (📖28), the MF indicator (📖74), and elsewhere from m/cm to ft/in as needed.

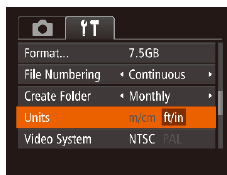

- Choose [Units], and then choose [ft/in].

Before Use

Basic Guide

Advanced Guide

Camera Basics

Auto Mode / Hybrid Auto Mode

Other Shooting Modes

P Mode

Tv, Av, and M Mode

Playback Mode

Wi-Fi Functions

Setting Menu

Accessories

Appendix

Index



Checking Certification Logos

Some logos for certification requirements met by the camera can be viewed on the screen. Other certification logos are printed in this guide, on the camera packaging, or on the camera body.

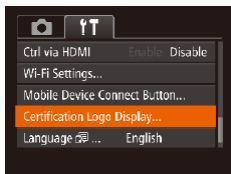

- Choose [Certification Logo Display], and then press the button.

Display Language

Change the display language as needed.



- Choose [Language], and then press the button.
- Press the buttons or turn the dial to choose a language, and then press the button.



- You can also access the [Language] screen in Playback mode by pressing and holding the button and immediately pressing the button.

Adjusting Other Settings

The following settings can also be adjusted on the tab.

- [Video System] (159)
- [Ctrl via HDMI] (158)
- [Wi-Fi Settings] (113)
- [Mobile Device Connect Button] (139)

Restoring Defaults

If you accidentally change a setting, you can restore default camera settings.

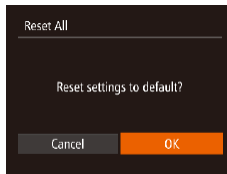

1 Access the [Reset All] screen.

- Choose [Reset All], and then press the button.

2 Restore default settings.

- Press the buttons or turn the dial to choose [OK], and then press the button.
- Default settings are now restored.

Before Use

Basic Guide

Advanced Guide

Camera Basics

Auto Mode / Hybrid Auto Mode

Other Shooting Modes

P Mode

Tv, Av, and M Mode

Playback Mode

Wi-Fi Functions

Setting Menu

Accessories

Appendix

Index





- The following functions are not restored to default settings.
 - Information registered using Face ID (📖40)
 - [📅] tab settings [Date/Time] (📖147), [Time Zone] (📖147), [Language] (📖152), and [Video System] (📖159)
 - Custom white balance data you have recorded (📖72)
 - Shooting mode chosen in [SCN] (📖55) or [📷] (📖57) mode
 - Movie mode (📖65)
 - Wi-Fi settings (📖113)

Before Use

Basic Guide

Advanced Guide

Camera Basics

Auto Mode / Hybrid
Auto Mode

Other Shooting
Modes

P Mode

Tv, Av, and M Mode

Playback Mode

Wi-Fi Functions

Setting Menu

Accessories

Appendix

Index



Accessories

Enjoy the camera in more ways with optional Canon accessories and other compatible accessories sold separately

| | | | |
|---|------------|---|------------|
| System Map | 155 | Using the Software | 160 |
| Optional Accessories | 156 | Software | 160 |
| Power Supplies | 156 | Computer Connections via a Cable | 161 |
| Other Accessories | 156 | Saving Images to a Computer..... | 161 |
| Printers..... | 156 | Printing Images | 163 |
| Using Optional Accessories | 157 | Easy Print..... | 163 |
| Playback on a TV | 157 | Configuring Print Settings | 164 |
| Powering the Camera with Household Power..... | 159 | Printing Movie Scenes | 166 |
| | | Adding Images to the Print List (DPOF)..... | 167 |
| | | Adding Images to a Photobook..... | 169 |

Before Use

Basic Guide

Advanced Guide

Camera Basics

Auto Mode / Hybrid Auto Mode

Other Shooting Modes

P Mode

Tv, Av, and M Mode

Playback Mode

Wi-Fi Functions

Setting Menu

Accessories

Appendix

Index



System Map

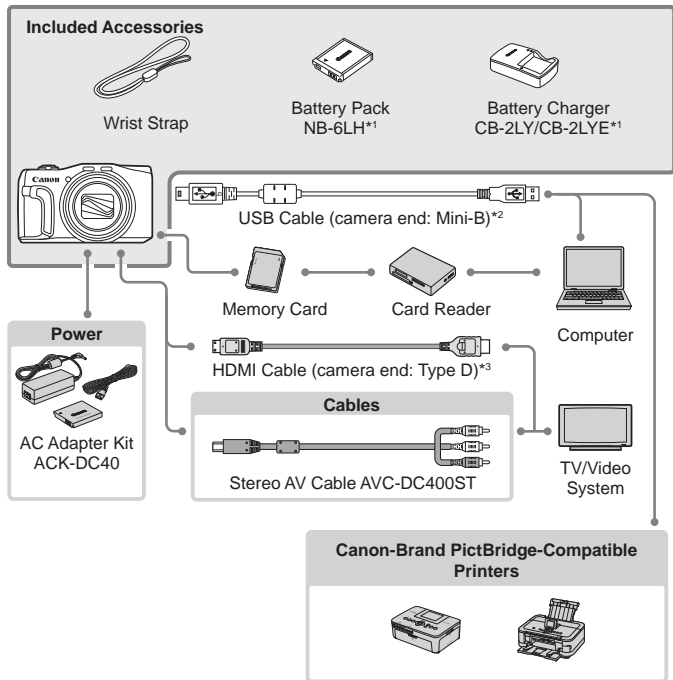

*1 Also available for purchase separately.

*2 A genuine Canon accessory is also available (Interface Cable IFC-400PCU).

*3 Use a commercially available cable no longer than 2.5 m.

Use of genuine Canon accessories is recommended.

This product is designed to achieve excellent performance when used with genuine Canon accessories.

Canon shall not be liable for any damage to this product and/or accidents such as fire, etc., caused by the malfunction of non-genuine Canon accessories (e.g., a leakage and/or explosion of a battery pack). Please note that this warranty does not apply to repairs arising out of the malfunction of non-genuine Canon accessories, although you may request such repairs on a chargeable basis.

Note that availability varies by area, and some accessories may no longer be available.

Before Use

Basic Guide

Advanced Guide

Camera Basics

Auto Mode / Hybrid Auto Mode

Other Shooting Modes

P Mode

Tv, Av, and M Mode

Playback Mode

Wi-Fi Functions

Setting Menu

Accessories

Appendix

Index



Optional Accessories

The following camera accessories are sold separately. Note that availability varies by area, and some accessories may no longer be available.

Power Supplies

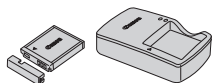

Battery Pack NB-6LH

- Rechargeable lithium-ion battery

Battery Charger CB-2LY/CB-2LYE

- Charger for Battery Pack NB-6LH



- The battery pack includes a convenient cover which you can attach to know the charging status at a glance. Attach the cover so that ▲ is visible on a charged battery pack, and attach it so that ▲ is not visible on an uncharged battery pack.
- Battery Pack NB-6L is also supported.

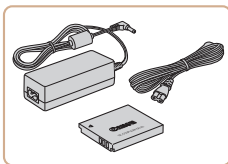

AC Adapter Kit ACK-DC40

- For powering the camera using household power. Recommended when using the camera over extended periods, or when connecting the camera to a printer or computer. Cannot be used to charge the battery pack in the camera.



- The battery charger and AC adapter kit can be used in areas with 100 – 240 V AC power (50/60 Hz).
- For power outlets in a different format, use a commercially available adapter for the plug. Never use an electrical transformer designed for traveling, which may damage the battery pack.

Other Accessories

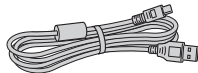

Interface Cable IFC-400PCU

- For connecting the camera to a computer or printer.

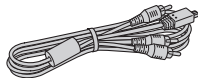

Stereo AV Cable AVC-DC400ST

- Connect the camera to a TV to enjoy playback on the larger TV screen.

Printers

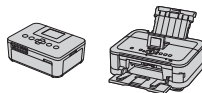

Canon-Brand PictBridge-Compatible Printers

- Printing images without a computer is possible by connecting the camera to a Canon-brand PictBridge-compatible printer. For details, visit your nearest Canon retailer.

Before Use

Basic Guide

Advanced Guide

Camera Basics

Auto Mode / Hybrid Auto Mode

Other Shooting Modes

P Mode

Tv, Av, and M Mode

Playback Mode

Wi-Fi Functions

Setting Menu

Accessories

Appendix

Index



Using Optional Accessories

Playback on a TV

By connecting the camera to a TV, you can view your shots on the larger screen of the TV.

For details on connection or how to switch inputs, refer to the TV manual.



- Some information may not be displayed on the TV (179).

Playback on a High-Definition TV

You can view your shots on a TV by connecting the camera to an HDTV with a commercially available HDMI cable (not exceeding 2.5 m, with a Type D terminal on the camera end). Movies shot at a resolution of [FHD 60P], [FHD 30P] or [FHD 30P] can be viewed in high definition.

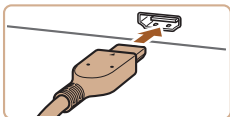

1 Make sure the camera and TV are off.

2 Connect the camera to the TV.

- On the TV, insert the cable plug fully into the HDMI input as shown.

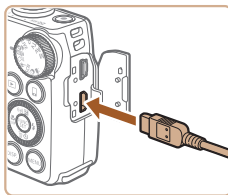

- Camera operating sounds are not played while the camera is connected to an HDTV.

- On the camera, open the terminal cover and insert the cable plug fully into the camera terminal.

3 Turn the TV on and switch to video input.

- Switch the TV input to the video input you connected the cable to in step 2.

4 Turn the camera on.

- Press the <▶> button to turn the camera on.
- Images from the camera are now displayed on the TV. (Nothing is displayed on the camera screen.)
- When finished, turn off the camera and TV before disconnecting the cable.



Controlling the Camera with a TV Remote

Connecting the camera to an HDMI CEC-compatible TV enables playback (including slideshow playback) using the TV remote control.

Depending on the TV, you may need to adjust some TV settings. For details, refer to the TV manual.

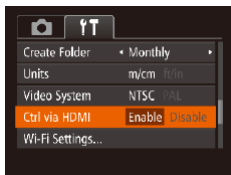

1 Configure the setting.

- Press the <MENU> button, choose [Ctrl via HDMI] on the [fT] tab, and then choose [Enable] (📖24).

2 Connect the camera to the TV.

- Follow steps 1 – 2 in “Playback on a High-Definition TV” (📖157) to connect the camera to the TV.







3 Display images.

- Turn on the TV. On the camera, press the <▶> button.
- Images from the camera are now displayed on the TV. (Nothing is displayed on the camera screen.)

4 Control the camera with the TV remote.

- Press the <◀><▶> buttons on the remote to browse images.
- To display the camera control panel, press the OK/Select button. Select control panel options by pressing the <◀><▶> buttons to choose an option, and then pressing the OK/Select button again.

Camera Control Panel Options Shown on the TV

| | | |
|---|----------------|---|
|  | Return | Closes the menu. |
|  | Group Playback | Displays sets of images shot in [📷] (📖54), [📷]] (📖53), or [📷]] (📖64) mode. (Only displayed when a grouped image is selected.) |
|  | Play Movie | Starts movie playback. (Only displayed when a movie is selected.) |
|  | Slideshow | Starts slideshow playback. To switch images during playback, press the <◀><▶> buttons on the remote control. |
|  | Index Playback | Displays multiple images in an index. |
|  | Change Display | Switches display modes (📖90). |



- Pressing buttons, such as the <MENU> button, on the camera will switch control to the camera itself, which will prevent remote control until you return to single-image display.
- Moving the zoom lever on the camera will switch control to the camera itself, which will prevent remote control until you return to single-image display.
- The camera may not always respond correctly even if the remote is for an HDMI CEC-compatible TV.



Playback on a Standard-Definition TV

Connecting the camera to a TV with the Stereo AV Cable AVC-DC400ST (sold separately) enables you to view your shots on the larger screen of the TV as you control the camera.

1 Make sure the camera and TV are off.

2 Connect the camera to the TV.

- On the TV, insert the cable plugs fully into the video inputs as shown.

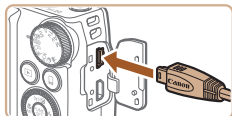
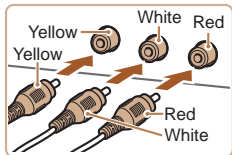

- On the camera, open the terminal cover and insert the cable plug fully into the camera terminal.

3 Display images.

- Follow steps 3 – 4 in “Playback on a High-Definition TV” (📖157) to display images.



- Correct display is not possible unless the camera video output format (NTSC or PAL) matches the TV format. To change the video output format, press the <MENU> button and choose [Video System] on the [↑] tab.



- When the camera and TV are connected, you can also shoot while previewing shots on the larger screen of the TV. To shoot, follow the same steps as when using the camera screen. However, AF-Point Zoom (📖49), MF-Point Zoom (📖75) and MF Peaking (📖75) are not available.

Powering the Camera with Household Power

Powering the camera with AC Adapter Kit ACK-DC40 (sold separately) eliminates the need to monitor the remaining battery level.

1 Make sure the camera is off.

2 Insert the coupler.

- Follow step 1 in “Inserting the Battery Pack and Memory Card” (📖13) to open the cover.
- Insert the coupler facing the direction shown, just as you would a battery pack (following step 2 in “Inserting the Battery Pack and Memory Card” (📖13)).
- Follow step 4 in “Inserting the Battery Pack and Memory Card” (📖13) to close the cover.

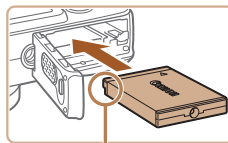

Terminals

3 Connect the adapter to the coupler.

- Open the cover and insert the adapter plug fully into the coupler.

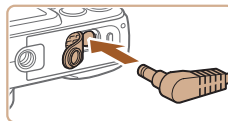

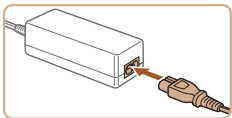

4 Connect the power cord.

- Insert one end of the power cord into the compact power adapter, and then plug the other end into a power outlet.
- Turn the camera on and use it as desired.
- When finished, turn the camera off and unplug the power cord from the outlet.



- Do not disconnect the adapter or unplug the power cord while the camera is still on. This may erase your shots or damage the camera.
- Do not attach the adapter or adapter cord to other objects. Doing so could result in malfunction or damage to the product.

Using the Software

The software available for download from the Canon website is introduced below, with instructions for installation and saving images to a computer.

Software

After downloading the software from the Canon website and installing it, you can do the following things on your computer.

CameraWindow

- Import images and change camera settings

ImageBrowser EX

- Manage images: view, search, and organize
- Print and edit images



- Internet access is required, and any ISP account charges and access fees must be paid separately.

Software Instruction Manual

Refer to the instruction manual when using the software. The manual can be accessed from the help system of software (some software excluded).

Before Use

Basic Guide

Advanced Guide

Camera Basics

Auto Mode / Hybrid
Auto Mode

Other Shooting
Modes

P Mode

Tv, Av, and M Mode

Playback Mode

Wi-Fi Functions

Setting Menu

Accessories

Appendix

Index



Computer Connections via a Cable

Checking Your Computer Environment

The software can be used on the following computers. For detailed system requirements and compatibility information, including support in new operating systems, visit the Canon website.

| | Windows | Mac OS |
|-------------------|---|---|
| Operating System* | Windows 8/8.1 Windows 7 SP1 Windows Vista SP2 Windows XP SP3 | Mac OS X 10.9 Mac OS X 10.8 Mac OS X 10.7 |

* When sending images to a computer via Wi-Fi, check the system requirements in "Checking Your Computer Environment" (120).



- Check the Canon website for the latest system requirements, including supported OS versions.

Installing the Software

For software installation instructions, see "Installing the Software" (121).

Saving Images to a Computer

Windows 7 and Mac OS X 10.8 are used here for the sake of illustration. For other functions, refer to the help system of the relevant software (some software excluded).

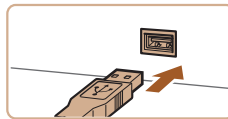
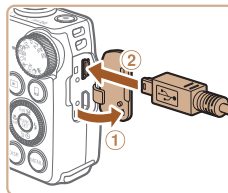

1 Connect the camera to the computer.

- With the camera turned off, open the cover (1). With the smaller plug of the USB cable in the orientation shown, insert the plug fully into the camera terminal (2).

- Insert the larger plug of the USB cable in the computer's USB port. For details about USB connections on the computer, refer to the computer user manual.

2 Turn the camera on to access CameraWindow.

- Press the <▶> button to turn the camera on.
- Mac OS: CameraWindow is displayed when a connection is established between the camera and computer.
- Windows: Follow the steps introduced below.
- In the screen that displays, click the [] link to modify the program.

Before Use

Basic Guide

Advanced Guide

Camera Basics

Auto Mode / Hybrid Auto Mode

Other Shooting Modes

P Mode

Tv, Av, and M Mode

Playback Mode

Wi-Fi Functions

Setting Menu

Accessories

Appendix

Index



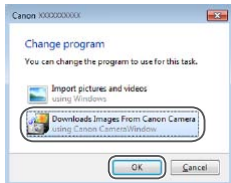



CameraWindow



- Choose [Downloads Images From Canon Camera] and then click [OK].

- Double-click .

3 Save the images to the computer.

- Click [Import Images from Camera], and then click [Import Untransferred Images].
- Images are now saved to the Pictures folder on the computer, in separate folders named by date.
- After images are saved, close CameraWindow, press the  button to turn the camera off, and unplug the cable.
- For instructions on viewing images on a computer, refer to “Software Instruction Manual” ( 160).



- Windows 7: If the screen in step 2 is not displayed, click the  icon in the taskbar.
- Windows Vista or XP: To start CameraWindow, click [Downloads Images From Canon Camera] on the screen displayed when you turn the camera on in step 2. If CameraWindow is not displayed, click the [Start] menu and choose [All Programs] ► [Canon Utilities] ► [CameraWindow] ► [CameraWindow].
- Mac OS: If CameraWindow is not displayed after step 2, click the [CameraWindow] icon in the Dock.
- Although you can save images to a computer simply by connecting your camera to the computer without using the software, the following limitations apply.
 - It may take a few minutes after you connect the camera to the computer until camera images are accessible.
 - Images shot in vertical orientation may be saved in horizontal orientation.
 - Image protection settings may be cleared from images saved to a computer.
 - Some problems may occur when saving images or image information, depending on the operating system version, the software in use, or image file sizes.
 - Some functions provided by the software may not be available, such as movie editing.

Before Use

Basic Guide

Advanced Guide

Camera Basics

Auto Mode / Hybrid Auto Mode

Other Shooting Modes

P Mode

Tv, Av, and M Mode

Playback Mode

Wi-Fi Functions

Setting Menu

Accessories

Appendix

Index



Printing Images

Your shots can easily be printed by connecting the camera to a printer. On the camera, you can specify images to set up batch printing, prepare orders for photo development services, and prepare orders or print images for photobooks.

A Canon SELPHY CP series compact photo printer is used here for the sake of illustration. Screens displayed and available functions vary by printer. Also refer to the printer manual for additional information.



Easy Print

Still Images

Easily print your shots by connecting the camera to a PictBridge-compatible printer (sold separately) with the USB cable.

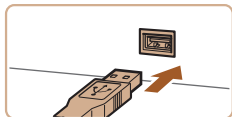
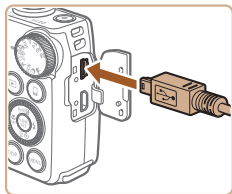

- 1 Make sure the camera and printer are off.**
- 2 Connect the camera to the printer.**
 - Open the cover. Holding the smaller cable plug in the orientation shown, insert the plug fully into the camera terminal.
 - Connect the larger cable plug to the printer. For other connection details, refer to the printer manual.

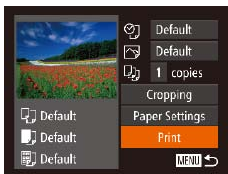
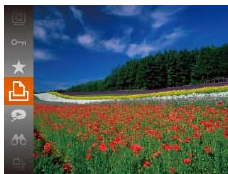

3 Turn the printer on.

4 Turn the camera on.

- Press the button to turn the camera on.

5 Choose an image.

- Press the buttons or turn the dial to choose an image.

6 Access the printing screen.

- Press the button, choose , and press the button again.

7 Print the image.

- Press the buttons or turn the dial to choose [Print], and then press the button.
- Printing now begins.
- To print other images, repeat the above procedures starting from step 5 after printing is finished.
- When you are finished printing, turn the camera and printer off and disconnect the cable.



- For Canon-brand PictBridge-compatible printers (sold separately), see "Printers" (156).

Before Use

Basic Guide

Advanced Guide

Camera Basics

Auto Mode / Hybrid Auto Mode

Other Shooting Modes

P Mode

Tv, Av, and M Mode

Playback Mode

Wi-Fi Functions

Setting Menu

Accessories

Appendix

Index



Configuring Print Settings

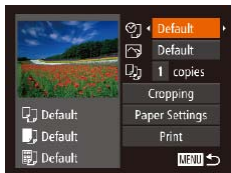

1 Access the printing screen.

- Follow steps 1 – 6 in “Easy Print” (📖163) to access the screen at left.

2 Configure the settings.

- Press the <▲><▼> buttons or turn the <⦿> dial to choose an item, and then choose an option by pressing the <◀><▶> buttons.

| | | |
|-----------------------|---------------|---|
| 📷 | Default | Matches current printer settings. |
| | Date | Prints images with the date added. |
| | File No. | Prints images with the file number added. |
| | Both | Prints images with both the date and file number added. |
| | Off | – |
| 📄 | Default | Matches current printer settings. |
| | Off | – |
| | On | Uses information from the time of shooting to print under optimal settings. |
| | Red-Eye 1 | Corrects red-eye. |
| 📄 | No. of Copies | Choose the number of copies to print. |
| Cropping | – | Specify a desired image area to print (📖164). |
| Paper Settings | – | Specify the paper size, layout, and other details (📖165). |

Cropping Images before Printing

By cropping images before printing, you can print a desired image area instead of the entire image.

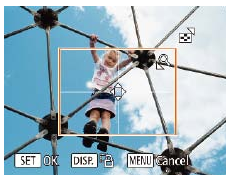
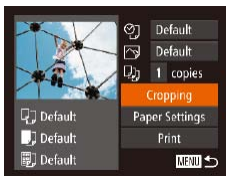

1 Choose [Cropping].

- After following step 1 in “Configuring Print Settings” (📖164) to access the printing screen, choose [Cropping] and press the <FUNC SET> button.
- A cropping frame is now displayed, indicating the image area to print.

2 Adjust the cropping frame as needed.

- To resize the frame, move the zoom lever or turn the <⦿> dial.
- To move the frame, press the <▲><▼><◀><▶> buttons.
- To rotate the frame, press the <DISP.> button.
- When finished, press the <FUNC SET> button.

3 Print the image.

- Follow step 7 in “Easy Print” (📖163) to print.



- Cropping may not be possible at small image sizes, or at some aspect ratios.
- Dates may not be printed correctly if you crop images shot with [Date Stamp 📷] selected.



Choosing Paper Size and Layout before Printing

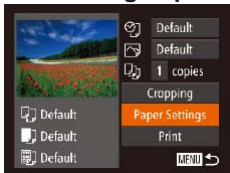

1 Choose [Paper Settings].

- After following step 1 in “Configuring Print Settings” (164) to access the printing screen, choose [Paper Settings] and press the button.

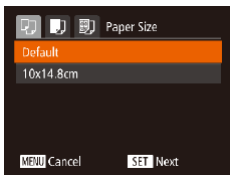

2 Choose a paper size.

- Press the or turn the to choose an option, and then press the .

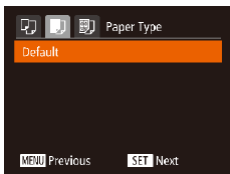

3 Choose a type of paper.

- Press the or turn the to choose an option, and then press the .

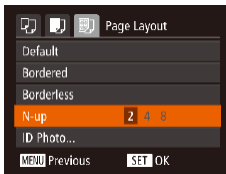

4 Choose a layout.

- Press the or turn the to choose an option.
- When choosing [N-up], press the to specify the number of images per sheet.
- Press the .

5 Print the image.

Available Layout Options

| | |
|------------|---|
| Default | Matches current printer settings. |
| Bordered | Prints with blank space around the image. |
| Borderless | Borderless, edge-to-edge printing. |
| N-up | Choose how many images to print per sheet. |
| ID Photo | Prints images for identification purposes. Only available for images with a resolution of L and an aspect ratio of 4:3. |
| Fixed Size | Choose the print size. Choose from 3.5 x 5 in., postcard, or wide-format prints. |

Printing ID Photos

1 Choose [ID Photo].

- Following steps 1 – 4 in “Choosing Paper Size and Layout before Printing” (165 – 165), choose [ID Photo] and press the .

Before Use

Basic Guide

Advanced Guide

Camera Basics

Auto Mode / Hybrid Auto Mode

Other Shooting Modes

P Mode

Tv, Av, and M Mode

Playback Mode

Wi-Fi Functions

Setting Menu

Accessories

Appendix

Index

Still Images



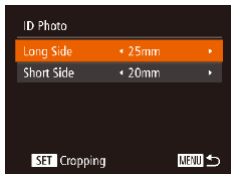

2 Choose the long and short side length.

- Press the <▲><▼> buttons or turn the <⦿> dial to choose an item. Choose the length by pressing the <◀><▶> buttons, and then press the <FUNC SET> button.

3 Choose the printing area.

- Follow step 2 in “Cropping Images before Printing” (164) to choose the printing area.

4 Print the image.

Printing Movie Scenes

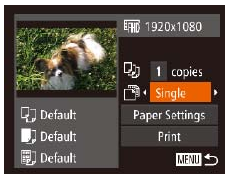

1 Access the printing screen.

- Follow steps 1 – 6 in “Easy Print” (163) to choose a movie. The screen at left is displayed.

2 Choose a printing method.

- Press the <▲><▼> buttons or turn the <⦿> dial to choose [Print], and then press the <◀><▶> buttons to choose the printing method.

3 Print the image.

Movie Printing Options

| | |
|----------|--|
| Single | Prints the current scene as a still image. |
| Sequence | Prints a series of scenes, a certain interval apart, on a single sheet of paper. You can also print the folder number, file number, and elapsed time for the frame by setting [Caption] to [On]. |



- To cancel printing in progress, press the <FUNC SET> button.
- [ID Photo] and [Sequence] cannot be chosen on Canon-brand PictBridge-compatible printers from CP720/CP730 and earlier models.

Before Use

Basic Guide

Advanced Guide

Camera Basics

Auto Mode / Hybrid Auto Mode

Other Shooting Modes

P Mode

Tv, Av, and M Mode

Playback Mode

Wi-Fi Functions

Setting Menu

Accessories

Appendix

Index



Adding Images to the Print List (DPOF)

Batch printing (📖169) and ordering prints from a photo development service can be set up on the camera. Choose up to 998 images on a memory card and configure relevant settings, such as the number of copies, as follows. The printing information you prepare this way will conform to DPOF (Digital Print Order Format) standards.

Configuring Print Settings

Specify the printing format, whether to add the date or file number, and other settings as follows. These settings apply to all images in the print list.

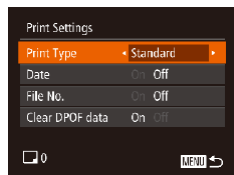

- Press the <MENU> button, and then choose [Print Settings] on the [🖨️] tab. Choose and configure items as desired (📖24).

| | | |
|-----------------|----------|--|
| Print Type | Standard | One image is printed per sheet. |
| | Index | Smaller versions of multiple images are printed per sheet. |
| | Both | Both standard and index formats are printed. |
| Date | On | Images are printed with the shooting date. |
| | Off | – |
| File No. | On | Images are printed with the file number. |
| | Off | – |
| Clear DPOF data | On | All image print list settings are cleared after printing. |
| | Off | – |



- Not all of your DPOF settings may be applied in printing by the printer or photo development service, in some cases.
- [!] may be displayed on the camera to warn you that the memory card has print settings that were configured on another camera. Changing the print settings using this camera may overwrite all previous settings.
- Setting [Date] to [On] may cause some printers to print the date twice.



- Specifying [Index] will prevent you from choosing [On] for both [Date] and [File No.] at the same time.
- Index printing is not available on some Canon-brand PictBridge-compatible printers (sold separately).
- The date is printed in a format matching setting details in [Date/Time] on the [🕒] tab (📖14).

Setting Up Printing for Individual Images

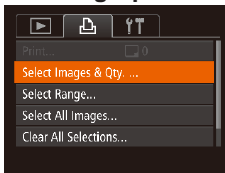

1 Choose [Select Images & Qty.].

- Press the <MENU> button, choose [Select Images & Qty.] on the [🖨️] tab, and then press the <FUNC.> button.



2 Choose an image.

- Press the <◀><▶> buttons or turn the <⊙> dial to choose an image, and then press the <FUNC SET> button.
- You can now specify the number of copies.
- If you specify index printing for the image, it is labeled with a [✓] icon. To cancel index printing for the image, press the <FUNC SET> button again. [✓] is no longer displayed.



3 Specify the number of prints.

- Press the <▲><▼> buttons or turn the <⊙> dial to specify the number of prints (up to 99).
- To set up printing for other images and specify the number of prints, repeat steps 2 – 3.
- Printing quantity cannot be specified for index prints. You can only choose which images to print, by following step 2.
- When finished, press the <MENU> button to return to the menu screen.

Still Images

Setting Up Printing for a Range of Images



- Following step 1 in “Setting Up Printing for Individual Images” (167), choose [Select Range] and press the <FUNC SET> button.
- Follow steps 2 – 3 in “Selecting a Range” (100) to specify images.
- Press the <▲><▼> buttons to choose [Order], and then press the <FUNC SET> button.

Download from Www.Somanuals.com. All Manuals Search And Download.

Setting Up Printing for All Images

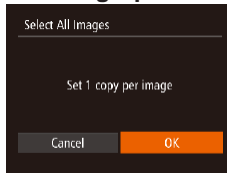

- Following step 1 in “Setting Up Printing for Individual Images” (167), choose [Select All Images] and press the <FUNC SET> button.
- Press the <◀><▶> buttons or turn the <⊙> dial to choose [OK], and then press the <FUNC SET> button.

Still Images

Clearing All Images from the Print List

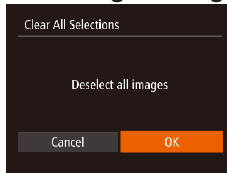

- Following step 1 in “Setting Up Printing for Individual Images” (167), choose [Clear All Selections] and press the <FUNC SET> button.
- Press the <◀><▶> buttons or turn the <⊙> dial to choose [OK], and then press the <FUNC SET> button.

Still Images

Before Use

Basic Guide

Advanced Guide

Camera Basics

Auto Mode / Hybrid Auto Mode

Other Shooting Modes

P Mode

Tv, Av, and M Mode

Playback Mode

Wi-Fi Functions

Setting Menu

Accessories

Appendix

Index



Printing Images Added to the Print List (DPOF)



- When images have been added to the print list (📖 167 – 168), the screen at left is displayed after you connect the camera to a PictBridge-compatible printer. Press the <▲><▼> buttons to choose [Print now], and then simply press the <P/SET> button to print the images in the print list.
- Any DPOF print job that you temporarily stop will be resumed from the next image.

Adding Images to a Photobook

Photobooks can be set up on the camera by choosing up to 998 images on a memory card and importing them into the software on your computer, where they are stored in their own folder. This is convenient when ordering printed photobooks online or printing photobooks with your own printer.

Choosing a Selection Method

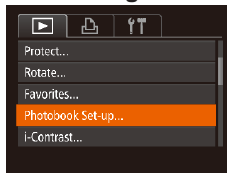

- Press the <MENU> button, choose [Photobook Set-up] on the [D] tab, and then choose how you will select images.

- ⚠️ [!] may be displayed on the camera to warn you that the memory card has print settings that were configured on another camera. Changing the print settings using this camera may overwrite all previous settings.

- ✎ After importing images to your computer, also refer to "Software Instruction Manual" (📖 160) and the printer manual for further information.



Adding Images Individually

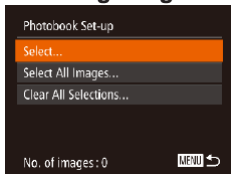

1 Choose [Select].

- Following the procedure in “Choosing a Selection Method” (169), choose [Select] and press the button.

2 Choose an image.

- Press the or turn the dial to choose an image, and then press the button.
- [✓] is displayed.
- To remove the image from the photobook, press the button again. [✓] is no longer displayed.
- Repeat this process to specify other images.
- When finished, press the button to return to the menu screen.



Adding All Images to a Photobook

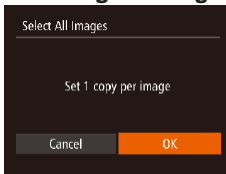

- Following the procedure in “Choosing a Selection Method” (169), choose [Select All Images] and press the button.
- Press the or turn the dial to choose [OK], and then press the button.

Removing All Images from a Photobook

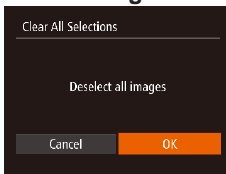

- Following the procedure in “Choosing a Selection Method” (169), choose [Clear All Selections] and press the button.
- Press the or turn the dial to choose [OK], and then press the button.



Appendix

Helpful information when using the camera

| | | | | | |
|---|------------|---|------------|-----------------------------------|------------|
| Troubleshooting | 172 | Functions and Menu Tables | 180 | Handling Precautions | 188 |
| On-Screen Messages | 175 | Functions Available in Each Shooting Mode | 180 | Specifications | 189 |
| On-Screen Information | 178 | FUNC. Menu | 182 | | |
| Shooting (Information Display) | 178 | 📷 Shooting Tab Menu | 184 | | |
| Playback (Detailed Information Display) | 179 | ⏪ Set Up Tab Menu | 187 | | |
| | | ▶ Playback Tab Menu | 187 | | |
| | | 🖨️ Print Tab Menu | 187 | | |
| | | Playback Mode FUNC. Menu | 188 | | |

| |
|------------------------------|
| Before Use |
| Basic Guide |
| Advanced Guide |
| Camera Basics |
| Auto Mode / Hybrid Auto Mode |
| Other Shooting Modes |
| P Mode |
| Tv, Av, and M Mode |
| Playback Mode |
| Wi-Fi Functions |
| Setting Menu |
| Accessories |
| Appendix |
| Index |



Troubleshooting

If you think there is a problem with the camera, first check the following. If the items below do not solve your problem, contact a Canon Customer Support Help Desk.

Power

Nothing happens when the power button is pressed.

- Confirm that the battery pack is charged (📖12).
- Confirm that the battery pack is inserted facing the correct way (📖13).
- Confirm that the memory card/battery cover is fully closed (📖14).
- Dirty battery terminals reduce battery performance. Try cleaning the terminals with a cotton swab and reinserting the battery pack a few times.

The battery pack runs out of power quickly.

- Battery performance decreases at low temperatures. Try warming the battery pack a little by putting it in your pocket, for example, ensuring that the terminals do not touch any metal objects.
- If these measures do not help and the battery pack still runs out of power soon after charging, it has reached the end of its life. Purchase a new battery pack.
- Dirty battery terminals reduce battery performance. Try cleaning the terminals with a cotton swab and reinserting the battery pack a few times.

The lens is not retracted.

- Do not open the memory card/battery cover while the camera is on. Close the cover, turn the camera on, and then turn it off again (📖14).

The battery pack is swollen.

- Battery swelling is normal and does not pose any safety concerns. However, if battery swelling prevents the battery pack from fitting in the camera, contact a Canon Customer Support Help Desk.

Display on a TV

Camera images look distorted or not displayed on a TV (📖159).

Shooting

Cannot shoot.

- In Playback mode (📖88), press the shutter button halfway (📖22).

Strange display on the screen under low light (📖23).

Strange display on the screen when shooting.

Note that the following display problems are not recorded in still images but are recorded in movies.

- The screen may flicker and horizontal banding may appear under fluorescent or LED lighting.

No date stamp is added to images.

- Configure the [Date Stamp ] setting (📖14). Note that date stamps are not added to images automatically, merely because you have configured the [Date/Time] setting (📖38).
- Date stamps are not added in shooting modes (📖186) in which this setting cannot be configured (📖38).

[📷] flashes on the screen when the shutter button is pressed, and shooting is not possible (📖31).

[📷] is displayed when the shutter button is pressed halfway (📖31).

- Set [IS Mode] to [Continuous] (📖82).
- Raise the flash and set the flash mode to [📷] (📖80).
- Increase the ISO speed (📖71).
- Mount the camera on a tripod or take other measures to keep it still. In this case, you should set [IS Mode] to [Off] (📖82).

Shots are out of focus.

- Press the shutter button halfway to focus on subjects before pressing it all the way down to shoot (📖22).
- Make sure subjects are within focusing range (📖190).
- Set [AF-assist Beam] to [On] (📖50).
- Confirm that unneeded functions such as macro are deactivated.
- Try shooting with focus lock or AF lock (📖76, 79).

Before Use

Basic Guide

Advanced Guide

Camera Basics

Auto Mode / Hybrid Auto Mode

Other Shooting Modes

P Mode

Tv, Av, and M Mode

Playback Mode

Wi-Fi Functions

Setting Menu

Accessories

Appendix

Index



No AF frames are displayed and the camera does not focus when the shutter button is pressed halfway.

- To have AF frames displayed and the camera focus correctly, try composing the shot with higher-contrast subject areas centered before you press the shutter button halfway. Otherwise, try pressing the shutter button halfway repeatedly.

Subjects in shots look too dark.

- Raise the flash and set the flash mode to [F] (📖80).
- Adjust brightness by using exposure compensation (📖69).
- Adjust contrast by using i-Contrast (📖71, 109).
- Use AE lock or spot metering (📖70).

Subjects look too bright, highlights are washed-out.

- Lower the flash and set the flash mode to [G] (📖29).
- Adjust brightness by using exposure compensation (📖69).
- Use AE lock or spot metering (📖70).
- Reduce the lighting on subjects.

Shots look too dark despite the flash firing (📖31).

- Shoot within flash range (📖190).
- Adjust brightness by using flash exposure compensation or changing the flash output level (📖81, 87).
- Increase the ISO speed (📖71).

Subjects in flash shots look too bright, highlights are washed-out.

- Shoot within flash range (📖190).
- Lower the flash and set the flash mode to [G] (📖29).
- Adjust brightness by using flash exposure compensation or changing the flash output level (📖81, 87).

White dots or similar image artifacts appear in flash shots.

- This is caused by light from the flash reflecting off dust or airborne particles.

Shots look grainy.

- Lower the ISO speed (📖71).
- High ISO speeds in some shooting modes may cause grainy images (📖56).

Subjects are affected by red-eye (📖47).

- Set [Red-Eye Lamp] to [On] (📖50). The red-eye reduction lamp (📖3) will be activated in flash shots. For best results, have subjects look at the red-eye reduction lamp. Also try increasing the lighting in indoor scenes and shooting at closer range.
- Edit images using red-eye correction (📖109).

Recording to the memory card takes too long, or continuous shooting is slower.

- Use the camera to perform low-level formatting of the memory card (📖150).

Shooting settings or FUNC. menu settings are not available.

- Available setting items vary by shooting mode. Refer to “Functions Available in Each Shooting Mode”, “FUNC. Menu”, and “Shooting Tab Menu” (📖180 – 186).

The Babies or Children icon does not display.

- The Babies and Children icons will not display if the birthday is not set in face information (📖40). If the icons still do not display even when you set the birthday, re-register face information (📖40), or make sure that the date/time are set correctly (📖147).

Shooting Movies

The elapsed time shown is incorrect, or recording is interrupted.

- Use the camera to format the memory card, or switch to a card that supports high-speed recording. Note that even if the elapsed time display is incorrect, the length of movies on the memory card corresponds to the actual recording time (📖149, 190).

[🔴] is displayed and shooting stops automatically.

The camera’s internal memory buffer filled up as the camera could not record to the memory card quickly enough. Try one of the following measures.

- Use the camera to perform low-level formatting of the memory card (📖150).
- Lower the image quality (📖48).
- Switch to a memory card that supports high-speed recording (📖190).

Zooming is not possible.

- Zooming is not possible when shooting movies in [📷] (📖58) and [📹] (📖66) modes.

Before Use

Basic Guide

Advanced Guide

Camera Basics

Auto Mode / Hybrid Auto Mode

Other Shooting Modes

P Mode

Tv, Av, and M Mode

Playback Mode

Wi-Fi Functions

Setting Menu

Accessories

Appendix

Index



Subjects look distorted.

- Subjects that pass in front of the camera quickly may look distorted. This is not a malfunction.

Playback

Playback is not possible.

- Image or movie playback may not be possible if a computer is used to rename files or alter the folder structure. Refer to "Software Instruction Manual" (📖160) for details on folder structure and file names.

Playback stops, or audio skips.

- Switch to a memory card that you have performed low-level formatting on with the camera (📖150).
- There may be brief interruptions when playing movies copied to memory cards that have slow read speeds.
- When movies are played on a computer, frames may be dropped and audio may skip if computer performance is inadequate.

Sound is not played during movies.

- Adjust the volume (📖89) if you have activated [Mute] (📖146) or the sound in the movie is faint.
- No sound is played for movies shot in [📷] (📖58) or [📹] (📖66) mode because audio is not recorded in these modes.

Memory Card

The memory card is not recognized.

- Restart the camera, with the memory card in it (📖21).

Computer

Cannot transfer images to a computer.

When attempting to transfer images to the computer via a cable, try reducing the transfer speed as follows.

- Press the <▶> button to enter Playback mode. Hold the <MENU> button down as you press the <▲> and <⊙> buttons at the same time. On the next screen, press the <◀><▶> buttons to choose [B], and then press the <⊙> button.

Wi-Fi

Cannot access the Wi-Fi menu by pressing the <▲> button.

- The Wi-Fi menu is not available in Shooting mode. Switch to Playback mode and try again.
- In Playback mode, the Wi-Fi menu cannot be accessed during magnified display or index display. Switch to single-image display and try again. Similarly, the Wi-Fi menu cannot be accessed during group playback or filtered image display according to specified conditions. Cancel group or filtered image playback.
- The Wi-Fi menu cannot be accessed while the camera is connected to a printer, computer, or TV via a cable. Disconnect the cable.

Cannot add a device/destination.

- A total of 20 items of connection information can be added to the camera. Erase unneeded connection information from the camera first, and then add new devices/destinations (📖142).
- Use a computer or smartphone to register Web services (📖116).
- To add a smartphone, first install the dedicated application CameraWindow on your smartphone (📖119).
- To add a computer, first install the software CameraWindow on your computer. Also check your computer and Wi-Fi environment and settings (📖120, 124).
- Do not use the camera near sources of Wi-Fi signal interference, such as microwave ovens, Bluetooth devices, or other equipment operating on the 2.4 GHz band.
- Bring the camera closer to the other device you are trying to connect to (such as the access point), and make sure there are no objects between the devices.

Cannot connect to the access point.

- Confirm that the access point channel is set to a channel supported by the camera (📖189). Note that instead of auto channel assignment, it is advisable to specify a supported channel manually.

Before Use

Basic Guide

Advanced Guide

Camera Basics

Auto Mode / Hybrid Auto Mode

Other Shooting Modes

P Mode

Tv, Av, and M Mode

Playback Mode

Wi-Fi Functions

Setting Menu

Accessories

Appendix

Index



Cannot send images.

- The destination device has insufficient storage space. Increase the storage space on the destination device and resend the images.
- The write-protect tab of the memory card in the destination camera is set to the locked position. Slide the write-protect tab to the unlocked position.
- Images are not sent to CANON iIMAGE GATEWAY or other Web services if you move or rename image files or folders on the computer that received images sent using Image Sync via an access point (📖139). Before moving or renaming these image files or folders on the computer, make sure the images have already been sent to CANON iIMAGE GATEWAY or other Web services.

Cannot resize images for sending.

- Images cannot be resized to be bigger than the resolution setting of their original size.
- Movies cannot be resized.

Images take a long time to send./The wireless connection is disrupted.

- Multiple images may take a long time to send. Try resizing the image to [M2] or [S] to reduce sending time (📖134).
- Movies may take a long time to send.
- Do not use the camera near sources of Wi-Fi signal interference, such as microwave ovens, Bluetooth devices, or other equipment operating on the 2.4 GHz band. Note that images may take a long time to send even when [Yi] is displayed.
- Bring the camera closer to the other device you are trying to connect to (such as the access point), and make sure there are no objects between the devices.

Want to erase Wi-Fi connection information before disposing of the camera or giving it to someone else.

- Reset the Wi-Fi settings (📖144).

On-Screen Messages

If an error message is displayed, respond as follows.

No memory card

- The memory card may be inserted facing the wrong way. Reinsert the memory card facing the correct way (📖14, 13).

Memory card locked

- The write-protect tab of the memory card is set to the locked position. Switch the write-protect tab to the unlocked position (📖14).

Cannot record!

- Shooting was attempted without a memory card in the camera. To shoot, insert a memory card facing the correct way (📖14).

Memory card error (📖150)

- If the same error message is displayed even after you have formatted a supported memory card (📖2) and have inserted it facing the correct way (📖14), contact a Canon Customer Support Help Desk.

Insufficient space on card

- There is not enough free space on the memory card to shoot (📖28, 52, 68, 84) or edit images (📖106 – 110). Either erase unneeded images (📖101) or insert a memory card with enough free space (📖13).

Charge the battery (📖12)

No Image.

- The memory card does not contain any images that can be displayed.

Protected! (📖98)

Unidentified Image/Incompatible JPEG/Image too large./Cannot play back MOV/Cannot play back MP4

- Unsupported or corrupt images cannot be displayed.
- It may not be possible to display images that were edited or renamed on a computer, or images shot with another camera.

Before Use

Basic Guide

Advanced Guide

Camera Basics

Auto Mode / Hybrid Auto Mode

Other Shooting Modes

P Mode

Tv, Av, and M Mode

Playback Mode

Wi-Fi Functions

Setting Menu

Accessories

Appendix

Index



Cannot magnify!/Cannot play back this content in Smart Shuffle/ Cannot rotate/Cannot modify image/Cannot modify/Cannot assign to category/Unselectable image./No identification information

- The following functions may be unavailable for images that were renamed or already edited on a computer, or images shot with another camera. Note that starred (*) functions are not available for movies.

Edit ID Info* (📖95), Magnify* (📖96), Smart Shuffle* (📖97), Rotate* (📖104), Favorites (📖105), Edit* (📖106 – 110), Print List* (📖167), and Photobook Set-up* (📖169).

- Grouped images cannot be processed (📖55, 53, 64).

Invalid selection range

- When specifying a range for image selection (📖100, 103, 168), you attempted to choose an initial image that was after the final image, or vice-versa.

Exceeded selection limit

- More than 998 images were selected for Print List (📖167) or Photobook Set-up (📖169). Choose 998 images or less.
- Print List (📖167) or Photobook Set-up (📖169) settings could not be saved correctly. Reduce the number of selected images and try again.
- You attempted to choose more than 500 images in Protect (📖98), Erase (📖101), Favorites (📖105), Print List (📖167), or Photobook Set-up (📖169).

Naming error!

- The folder could not be created or images could not be recorded, because the highest supported folder number (999) for storing images on the card has been reached and the highest supported image number (9999) for images in folders has been reached. On the [📁] tab, change [File Numbering] to [Auto Reset] (📖151), or format the memory card (📖149).

Lens Error

- This error may occur if the lens is held while it is moving, or when the camera is used in dusty or sandy locations.
- Frequent display of this error message may indicate camera damage. In this case, contact a Canon Customer Support Help Desk.

A camera error was detected (error number)

- If this error message is displayed immediately after a shot, the image may not have been saved. Switch to Playback mode to check for the image.
- Frequent display of this error message may indicate camera damage. In this case, write down the error number (Exx) and contact a Canon Customer Support Help Desk.

File Error

- Correct printing (📖163) may not be possible for photos from other cameras or images that have been altered using computer software, even if the camera is connected to the printer.

Print error

- Check the paper size setting (📖165). If this error message is displayed when the setting is correct, restart the printer and complete the setting on the camera again.

Ink absorber full

- Contact a Canon Customer Support Help Desk to request assistance with ink absorber replacement.

Before Use

Basic Guide

Advanced Guide

Camera Basics

Auto Mode / Hybrid
Auto Mode

Other Shooting
Modes

P Mode

Tv, Av, and M Mode

Playback Mode

Wi-Fi Functions

Setting Menu

Accessories

Appendix

Index



Wi-Fi

Connection failed

- No access points were recognized. Check the access point settings (📖124).
- A device could not be found. Turn the camera off and on again, and retry the connection.
- Check the device you want to connect to and make sure it is ready for connection.

Cannot determine access point

- The WPS buttons on numerous access points were pressed simultaneously. Try reconnecting again.

No access points found

- Check to make sure that the access point is turned on.
- When connecting to an access point manually, make sure that you entered the correct SSID.

Incorrect password/Incorrect Wi-Fi security settings

- Check the access point security settings (📖124).

IP address conflict

- Reset the IP address so that it does not conflict with another.

Disconnected/Receiving failed/Sending failed

- You may be in an environment where Wi-Fi signals are obstructed.
- Avoid using the camera's Wi-Fi function around microwave ovens, Bluetooth devices, and other devices that operate on the 2.4 GHz band.
- Bring the camera closer to the other device you are trying to connect to (such as the access point), and make sure there are no objects between the devices.
- Check the connected device to make sure it is not experiencing errors.

Sending failed

Memory card error

- If the same error message is displayed even when you have inserted a formatted memory card facing the correct way, contact a Canon Customer Support Help Desk.

Receiving failed

Insufficient space on card

- There is not enough free space on the memory card in the target camera to receive images. Erase images to create space on the memory card, or insert a memory card with sufficient space.

Receiving failed

Memory card locked

- The write-protect tab of the memory card in the camera to receive the images is set to the locked position. Slide the write-protect tab to the unlocked position.

Receiving failed

Naming error!

- When the highest folder number (999), and the highest image number (9999) have been reached on the receiving camera, images cannot be received.

Insufficient space on server

- Delete unnecessary images uploaded to CANON iMAGE GATEWAY to create space.
- Save the images sent via Image Sync (📖139) to your computer.

Check network settings

- Check to make sure your computer can connect to the Internet with the current network settings.

Before Use

Basic Guide

Advanced Guide

Camera Basics

Auto Mode / Hybrid Auto Mode

Other Shooting Modes

P Mode

Tv, Av, and M Mode

Playback Mode

Wi-Fi Functions

Setting Menu

Accessories

Appendix

Index



On-Screen Information

Shooting (Information Display)

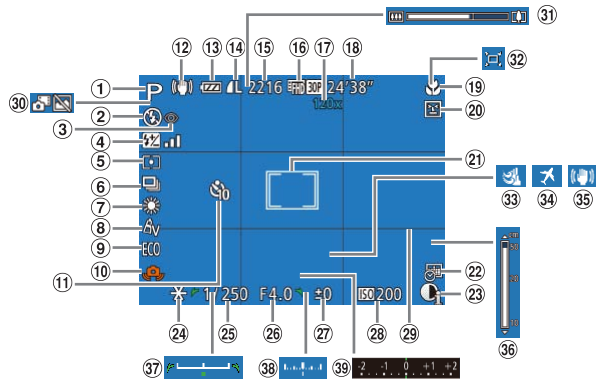

- ① Shooting mode (180), Scene icon (32)
- ② Flash mode (80)
- ③ Red-eye correction (47)
- ④ Flash exposure compensation / Flash output level (81, 87)
- ⑤ Metering method (70)
- ⑥ Drive mode (39, 79)
- ⑦ Mercury lamp correction (47), White balance (72)
- ⑧ My Colors (73)
- ⑨ Eco mode (148)
- ⑩ Camera shake warning (31)
- ⑪ Self-timer (37)
- ⑫ IS mode icon (33)
- ⑬ Battery level (178)
- ⑭ Still image compression (82), Resolution (46)
- ⑮ Recordable shots* (190)
- ⑯ Movie quality (48)
- ⑰ Digital zoom magnification (34), Digital tele-converter (37)

- ⑱ Remaining time (190)
- ⑲ Focusing range (74), AF lock (79)
- ⑳ Blink detection (49)
- ㉑ AF frame (76), Spot AE point frame (70)
- ㉒ Date stamp (38)
- ㉓ i-Contrast (71)
- ㉔ AE lock (70), FE lock (81)
- ㉕ Shutter speed (85, 86)
- ㉖ Aperture value (85, 86)
- ㉗ Exposure compensation level (69)
- ㉘ ISO speed (71)
- ㉙ Grid lines (48)
- ㉚ Hybrid Auto mode (30)
- ㉛ Zoom bar (28)
- ㉜ Auto (35)
- ㉝ Wind filter (31)
- ㉞ Time zone (147)
- ㉟ Image stabilization (82)
- ㊱ MF indicator (74)
- ㊲ Exposure shift bar (65)
- ㊳ Exposure level (86)
- ㊴ Exposure compensation bar (69)

* In [∞] mode, indicates the number of shots available.

Battery Level

An on-screen icon or message indicates the battery charge level.

| Display | Details |
|----------------------|--|
| | Sufficient charge |
| | Slightly depleted, but sufficient |
| (Blinking red) | Nearly depleted—charge the battery pack soon |
| [Charge the battery] | Depleted—charge the battery pack immediately |

Before Use

Basic Guide

Advanced Guide

Camera Basics

Auto Mode / Hybrid Auto Mode

Other Shooting Modes

P Mode

Tv, Av, and M Mode

Playback Mode

Wi-Fi Functions

Setting Menu

Accessories

Appendix

Index



Playback (Detailed Information Display)

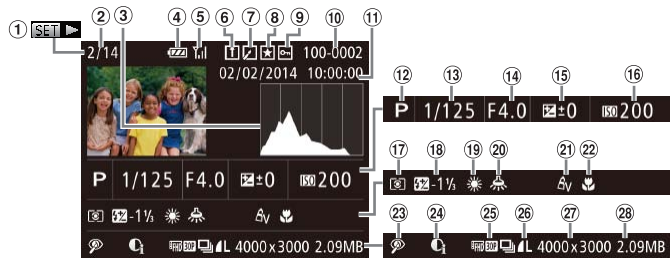

- | | | |
|--|---|--|
| ① Movies (89), High-speed burst HQ (64) | ⑩ Folder number - File number (151) | ⑲ White balance (72) |
| ② Current image no. / Total no. of images | ⑪ Shooting date/time (14) | ⑳ Mercury lamp correction (47) |
| ③ Histogram (90) | ⑫ Shooting mode (180) | ㉑ My Colors (73, 108), Creative Shot effect (53) |
| ④ Battery level (178) | ⑬ Shutter speed (85, 86) | ㉒ Focusing range (74) |
| ⑤ Wi-Fi signal strength (134) | ⑭ Aperture value (85, 86) | ㉓ Red-eye correction (47, 109) |
| ⑥ Image Sync (139) | ⑮ Exposure compensation level (69), Exposure shift level (65) | ㉔ i-Contrast (71, 109) |
| ⑦ Image editing (106 – 110), Movie compression (112) | ⑯ ISO speed (71) | ㉕ Digest movies, Group playback, Image quality (movies) |
| ⑧ Favorites (105) | ⑰ Metering method (70) | ㉖ Compression (image quality) / Resolution, MP4 (movies) |
| ⑨ Protection (98) | ⑱ Flash (80), Flash exposure compensation (81) | |

- ⑳ File size
- ㉗ Still images:
Resolution (190)
Movies: Playback time (190)

• Some information may not be displayed when viewing images on a TV (157).

Summary of Movie Control Panel in "Viewing" (89)

| | |
|--|--|
| | Exit |
| | Play |
| | Slow Motion (To adjust the playback speed, press the <<>> buttons or turn the <G> dial. No sound is played.) |
| | Skip Backward* or Previous Clip (112) (To continue skipping backward, keep holding down the <PREV> button.) |
| | Previous Frame (For fast-rewind, keep holding down the <PREV> button.) |
| | Next Frame (For fast-forward, keep holding down the <NEXT> button.) |
| | Skip Forward* or Next Clip (112) (To continue skipping forward, keep holding down the <NEXT> button.) |
| | Edit (110) |
| | Erase Clip (displayed when a digest movie is selected (112)) |
| | Shown when the camera is connected to a PictBridge-compatible printer (163). |

* Displays the frame approx. 4 sec. before or after the current frame.

• During movie playback, you can skip back or forward (or to the previous or next clip) by pressing the <<>> buttons.

Before Use

Basic Guide

Advanced Guide

Camera Basics

Auto Mode / Hybrid Auto Mode

Other Shooting Modes

P Mode

Tv, Av, and M Mode

Playback Mode

Wi-Fi Functions

Setting Menu

Accessories

Appendix

Index



Functions and Menu Tables

Functions Available in Each Shooting Mode

| Function | Shooting Mode | | | | | | | | | | SCN | | | | | | | | | | Other Modes | | | | | | | | | |
|--------------------------------------|---------------|----|----|---|------|----|------|---|---|---|-----|---|---|---|----|---|---|---|---|---|-------------|---|---|---|---|---|---|---|---|---|
| | M | Av | Tv | P | LIVE | AF | AUTO | □ | ⏏ | ⏏ | ⏏ | ⏏ | ⏏ | ⏏ | ⏏ | ⏏ | ⏏ | ⏏ | ⏏ | ⏏ | ⏏ | ⏏ | ⏏ | ⏏ | ⏏ | ⏏ | ⏏ | ⏏ | ⏏ | ⏏ |
| Exposure Compensation (📖69) | - | ○ | ○ | ○ | ○ | - | - | - | ○ | ○ | ○ | ○ | ○ | ○ | ○ | ○ | ○ | ○ | ○ | ○ | ○ | ○ | ○ | ○ | ○ | ○ | ○ | ○ | ○ | ○ |
| Self-Timer (📖37) | | | | | | | | | | | | | | | | | | | | | | | | | | | | | | |
| | ○ | ○ | ○ | ○ | ○ | ○ | ○ | ○ | ○ | ○ | ○ | ○ | ○ | ○ | ○ | ○ | ○ | ○ | ○ | ○ | ○ | ○ | ○ | ○ | ○ | ○ | ○ | ○ | ○ | ○ |
| | ○ | ○ | ○ | ○ | ○ | ○ | ○ | ○ | - | ○ | - | - | - | - | ○ | ○ | ○ | ○ | ○ | ○ | ○ | ○ | ○ | ○ | ○ | ○ | ○ | ○ | ○ | ○ |
| Self-Timer Settings (📖38) | | | | | | | | | | | | | | | | | | | | | | | | | | | | | | |
| Delay*1 | ○ | ○ | ○ | ○ | ○ | ○ | ○ | ○ | - | ○ | - | - | - | - | ○ | ○ | ○ | ○ | ○ | ○ | ○ | ○ | ○ | ○ | ○ | ○ | ○ | ○ | ○ | ○ |
| Shots*2 | ○ | ○ | ○ | ○ | ○ | - | ○ | - | - | ○ | - | - | - | - | ○ | ○ | ○ | ○ | ○ | ○ | ○ | ○ | ○ | ○ | ○ | ○ | ○ | ○ | ○ | ○ |
| Flash (📖80) | | | | | | | | | | | | | | | | | | | | | | | | | | | | | | |
| | - | - | - | ○ | ○ | ○ | ○ | ○ | - | ○ | ○ | ○ | ○ | ○ | - | ○ | ○ | ○ | ○ | ○ | ○ | ○ | ○ | ○ | ○ | ○ | ○ | ○ | ○ | ○ |
| | ○ | ○ | ○ | ○ | ○ | - | - | - | - | ○ | ○ | ○ | ○ | ○ | - | ○ | ○ | ○ | ○ | ○ | ○ | ○ | ○ | ○ | ○ | ○ | ○ | ○ | ○ | ○ |
| | - | ○ | - | ○ | ○ | *3 | *3 | - | - | - | - | - | - | - | *3 | - | - | - | - | - | - | - | - | - | - | - | - | - | - | |
| | ○ | ○ | ○ | ○ | ○ | ○ | ○ | ○ | ○ | ○ | ○ | ○ | ○ | ○ | ○ | ○ | ○ | ○ | ○ | ○ | ○ | ○ | ○ | ○ | ○ | ○ | ○ | ○ | ○ | ○ |
| Aperture Value (📖85, 86) | ○ | ○ | - | - | - | - | - | - | - | - | - | - | - | - | - | - | - | - | - | - | - | - | - | - | - | - | - | - | - | |
| Shutter Speed (📖85, 86) | ○ | - | ○ | - | - | - | - | - | - | - | - | - | - | - | - | - | - | - | - | - | - | - | - | - | - | - | - | - | - | |
| Program Shift (📖70) | - | ○ | ○ | ○ | - | - | - | - | - | - | - | - | - | - | - | - | - | - | - | - | - | - | - | - | - | - | - | - | - | |
| AE Lock/FE Lock (📖70, 81)*4 | - | ○ | ○ | ○ | - | - | - | - | - | - | - | - | - | - | - | - | - | - | - | - | - | - | - | - | - | - | - | - | - | |
| AE Lock (Movie)/Exposure Shift (📖65) | - | - | - | - | - | - | - | - | - | - | - | - | - | - | - | - | - | - | - | - | - | - | - | - | - | - | - | ○ | ○ | |

*1 Cannot be set to 0 seconds in modes without selection of the number of shots.

*2 One shot (cannot be modified) in modes without selection of the number of shots.

*3 Not available, but switches to in some cases.

*4 FE lock not available in flash mode.

○ Available or set automatically. - Not available.

Before Use

Basic Guide

Advanced Guide

Camera Basics

Auto Mode / Hybrid Auto Mode

Other Shooting Modes

P Mode

Tv, Av, and M Mode

Playback Mode

Wi-Fi Functions

Setting Menu

Accessories

Appendix

Index



| Function | Shooting Mode | | | | | | | | | | SCN | | | | | | | | | | Other Modes | | | | | | | | | | | | | | | | | | | |
|--------------------------------|------------------|----|----|---|------|---|------|---|---|---|-----|---|---|---|---|---|---|---|---|---|-------------|---|---|---|---|---|---|---|---|---|---|---|---|---|---|---|---|---|---|---|
| | M | Av | Tv | P | LIVE | Ⓜ | AUTO | 📷 | 📷 | 📷 | 📷 | 📷 | 📷 | 📷 | 📷 | 📷 | 📷 | 📷 | 📷 | 📷 | 📷 | 📷 | 📷 | 📷 | 📷 | 📷 | 📷 | 📷 | 📷 | 📷 | 📷 | 📷 | 📷 | 📷 | 📷 | 📷 | 📷 | 📷 | 📷 | 📷 |
| Still Image Aspect Ratio (📖46) | 16:9 3:2 4:3 1:1 | | | | | | | | | | | | | | | | | | | | | | | | | | | | | | | | | | | | | | | |
| Resolution (📖46) | | | | | | | | | | | | | | | | | | | | | | | | | | | | | | | | | | | | | | | | |
| L | ○ | ○ | ○ | ○ | ○ | ○ | ○ | ○ | ○ | ○ | ○ | ○ | ○ | ○ | ○ | ○ | ○ | ○ | ○ | ○ | ○ | ○ | ○ | ○ | ○ | ○ | ○ | ○ | ○ | ○ | ○ | ○ | ○ | ○ | ○ | ○ | ○ | ○ | ○ | |
| M1 M2 | ○ | ○ | ○ | ○ | - | - | ○ | - | ○ | ○ | ○ | ○ | ○ | ○ | ○ | ○ | ○ | ○ | ○ | ○ | ○ | ○ | ○ | ○ | ○ | ○ | ○ | ○ | ○ | ○ | ○ | ○ | ○ | ○ | ○ | ○ | ○ | ○ | ○ | |
| M | - | - | - | - | - | - | - | - | - | - | - | - | - | - | - | - | ○ | - | - | - | - | - | - | - | - | - | - | - | - | - | - | - | - | - | - | - | - | - | | |
| S | ○ | ○ | ○ | ○ | - | - | ○ | - | ○ | ○ | ○ | ○ | ○ | ○ | ○ | ○ | ○ | ○ | ○ | ○ | ○ | ○ | ○ | ○ | ○ | ○ | ○ | ○ | ○ | ○ | ○ | ○ | ○ | ○ | ○ | ○ | ○ | ○ | ○ | |
| Compression (📖82) | | | | | | | | | | | | | | | | | | | | | | | | | | | | | | | | | | | | | | | | |
| 📷 | ○ | ○ | ○ | ○ | - | - | - | - | - | - | - | - | - | - | - | - | - | - | - | - | - | - | - | - | - | - | - | - | - | - | - | - | - | - | - | - | - | - | | |
| 📷 | ○ | ○ | ○ | ○ | ○ | ○ | ○ | ○ | ○ | ○ | ○ | ○ | ○ | ○ | ○ | ○ | ○ | ○ | ○ | ○ | ○ | ○ | ○ | ○ | ○ | ○ | ○ | ○ | ○ | ○ | ○ | ○ | ○ | ○ | ○ | ○ | ○ | ○ | ○ | |
| Movie Quality (📖46, 48, 67) | | | | | | | | | | | | | | | | | | | | | | | | | | | | | | | | | | | | | | | | |
| 📷 FHD 60P | ○ | ○ | ○ | ○ | - | ○ | ○ | ○ | ○ | ○ | ○ | ○ | ○ | ○ | ○ | ○ | ○ | ○ | ○ | ○ | ○ | ○ | ○ | ○ | ○ | ○ | ○ | ○ | ○ | ○ | ○ | ○ | ○ | ○ | ○ | ○ | ○ | ○ | ○ | |
| 📷 FHD 30P | ○ | ○ | ○ | ○ | ○ | ○ | ○ | ○ | ○ | ○ | ○ | ○ | ○ | ○ | ○ | ○ | ○ | ○ | ○ | ○ | ○ | ○ | ○ | ○ | ○ | ○ | ○ | ○ | ○ | ○ | ○ | ○ | ○ | ○ | ○ | ○ | ○ | ○ | ○ | ○ |
| 📷 HD 30P 📷 VGA 30P | ○ | ○ | ○ | ○ | - | ○ | ○ | ○ | ○ | ○ | ○ | ○ | ○ | ○ | ○ | ○ | ○ | ○ | ○ | ○ | ○ | ○ | ○ | ○ | ○ | ○ | ○ | ○ | ○ | ○ | ○ | ○ | ○ | ○ | ○ | ○ | ○ | ○ | ○ | ○ |
| 📷 VGA 240P 📷 VGA 120P | - | - | - | - | - | - | - | - | - | - | - | - | - | - | - | - | - | - | - | - | - | - | - | - | - | - | - | - | - | - | - | - | - | - | - | - | - | - | ○ | |

*1 Only [4:3] and [16:9] are available.

○ Available or set automatically. – Not available.

*2 Synchronizes with the aspect ratio setting and is automatically set (📖59).

Before Use

Basic Guide

Advanced Guide

Camera Basics

Auto Mode / Hybrid Auto Mode

Other Shooting Modes

P Mode

Tv, Av, and M Mode

Playback Mode

Wi-Fi Functions

Setting Menu

Accessories

Appendix

Index



Shooting Tab Menu

| Function | Shooting Mode | | | | | | | | SCN | | | | | | | | | | | | | | | | | | | | | |
|---|---------------|----|----|---|------|---|--------------|---|-----|---|---|---|---|---|---|---|---|---|---|---|---|---|---|---|---|---|---|---|---|---|
| | M | Av | Tv | P | LIVE | | AUTO | | | | | | | | | | | | | | | | | | | | | | | |
| AF Frame (76) | | | | | | | | | | | | | | | | | | | | | | | | | | | | | | |
| Face AiAF*1 | O | O | O | O | O | O | O | O | - | O | O | O | O | O | O | O | O | - | - | - | O | O | O | O | O | O | | | | |
| Tracking AF | O | O | O | O | O | - | - | - | O | O | - | - | - | O | - | O | O | - | - | - | - | - | O | O | O | - | - | | | |
| Center | O | O | O | O | O | - | - | - | O | O | - | - | - | O | - | O | O | O | O | - | O | O | O | O | O | O | O | | | |
| AF Frame Size (76)*2 | | | | | | | | | | | | | | | | | | | | | | | | | | | | | | |
| Normal | O | O | O | O | O | - | - | - | - | O | - | - | - | O | - | O | O | - | O | - | O | O | O | O | O | O | O | | | |
| Small | O | O | O | O | O | - | - | - | - | O | - | - | - | O | - | O | O | - | - | - | - | O | O | O | O | O | O | | | |
| Digital Zoom (34) | | | | | | | | | | | | | | | | | | | | | | | | | | | | | | |
| Standard | O | O | O | O | O | O | O | - | O | O | O | O | O | - | - | - | O | O | - | - | - | - | - | - | - | O | O | - | | |
| Off | O | O | O | O | O | O | O | O | O | O | O | O | O | O | O | O | O | O | O | O | O | O | O | O | O | O | O | O | | |
| 1.6x/2.0x | O | O | O | O | O | - | - | - | - | - | - | - | - | - | - | - | - | - | - | - | - | - | - | - | - | - | - | | | |
| AF-Point Zoom (49) | | | | | | | | | | | | | | | | | | | | | | | | | | | | | | |
| On | O | O | O | O | O | - | O | O | - | O | O | O | O | O | - | O | O | - | - | - | - | - | O | O | O | - | - | - | | |
| Off | O | O | O | O | O | O | O | O | O | O | O | O | O | O | O | O | O | O | O | O | O | O | O | O | O | O | O | O | | |
| Servo AF (78) | | | | | | | | | | | | | | | | | | | | | | | | | | | | | | |
| On | O | O | O | O | O | - | - | - | O | O | - | - | - | - | - | O | O | - | - | - | - | - | O | O | O | - | - | - | | |
| Off | O | O | O | O | O | O | ³ | | - | O | O | O | O | O | O | O | O | O | O | O | O | O | O | O | O | O | O | O | | |
| Continuous AF (78) | | | | | | | | | | | | | | | | | | | | | | | | | | | | | | |
| On | O | O | O | O | O | O | O | O | O | O | O | O | O | - | O | - | O | O | O | O | O | O | O | O | O | O | O | O | | |
| Off | O | O | O | O | O | - | - | - | - | O | - | - | - | - | O | O | O | O | O | O | O | O | O | O | O | O | O | - | - | - |
| AF-assist Beam (50) | | | | | | | | | | | | | | | | | | | | | | | | | | | | | | |
| On | O | O | O | O | O | O | O | O | - | O | O | O | O | O | O | O | O | - | O | O | O | O | O | O | O | O | O | O | | |
| Off | O | O | O | O | O | O | O | O | O | O | - | O | O | O | O | O | O | O | O | O | O | O | O | O | O | O | O | O | O | |
| MF-Point Zoom (75) | | | | | | | | | | | | | | | | | | | | | | | | | | | | | | |
| Off | O | O | O | O | O | O | O | O | O | O | O | O | O | O | O | O | O | O | O | O | O | O | O | O | O | O | O | O | O | |
| 2x/4x | O | O | O | O | O | - | - | - | - | O | - | - | - | O | - | O | O | - | - | - | - | - | O | O | O | - | - | - | | |

*1 Operation when no faces are detected varies by shooting mode.

O Available or set automatically. - Not available.

*2 Available when the AF frame is set to [Center].

*3 [On] when subject movement is detected in [AUTO] mode.

- Before Use
- Basic Guide
- Advanced Guide
- Camera Basics
- Auto Mode / Hybrid Auto Mode
- Other Shooting Modes
- P Mode
- Tv, Av, and M Mode
- Playback Mode
- Wi-Fi Functions
- Setting Menu
- Accessories
- Appendix
- Index



Set Up Tab Menu

| Item | Ref. Page | Item | Ref. Page |
|----------------|-----------|--|-----------|
| Mute | 146 | File Numbering | 151 |
| Volume | 146 | Create Folder | 151 |
| Hints & Tips | 146 | Units | 151 |
| Date/Time | 14 | Video System | 159 |
| Time Zone | 147 | Ctrl via HDMI | 158 |
| Lens Retract | 147 | Wi-Fi Settings | 113 |
| Eco Mode | 148 | Mobile Device Connect Button | 139 |
| Power Saving | 21, 148 | Certification Logo Display | 152 |
| LCD Brightness | 149 | Language  | 16 |
| Start-up Image | 149 | Reset All | 152 |
| Format | 149, 150 | | |

Playback Tab Menu

| Item | Ref. Page | Item | Ref. Page |
|-------------------------|-----------|-------------------|-----------|
| List/Play Digest Movies | 92 | Resize | 106 |
| Slideshow | 96 | My Colors | 108 |
| Erase | 101 | Face ID Info | 92 |
| Protect | 98 | Transition Effect | 90 |
| Rotate | 104 | Index Effect | 93 |
| Favorites | 105 | Scroll Display | 90 |
| Photobook Set-up | 169 | Group Images | 94 |
| i-Contrast | 109 | Auto Rotate | 105 |
| Red-Eye Correction | 109 | Resume | 90 |
| Cropping | 107 | | |

Print Tab Menu

| Item | Ref. Page | Item | Ref. Page |
|----------------------|-----------|----------------------|-----------|
| Print | - | Select All Images | 168 |
| Select Images & Qty. | 167 | Clear All Selections | 168 |
| Select Range | 168 | Print Settings | 167 |

Before Use

Basic Guide

Advanced Guide

Camera Basics

Auto Mode / Hybrid Auto Mode

Other Shooting Modes

P Mode

Tv, Av, and M Mode

Playback Mode

Wi-Fi Functions

Setting Menu

Accessories

Appendix

Index



Playback Mode FUNC. Menu

| Item | Ref. Page | Item | Ref. Page |
|----------------|-----------|--------------------------|-----------|
| Rotate | 104 | Play Movie | 89 |
| Protect | 98 | Play Linked Digest Movie | 91, 92 |
| Favorites | 105 | Smart Shuffle | 97 |
| Print | 163 | Image Search | 93 |
| Group Playback | 94 | Slideshow | 96 |

Handling Precautions

- The camera is a high-precision electronic device. Avoid dropping it or subjecting it to strong impact.
- Never bring the camera near magnets, motors, or other devices that generate strong electromagnetic fields, which may cause malfunction or erase image data.
- If water droplets or dirt adheres to the camera or screen, wipe with a dry soft cloth, such as an eyeglass cloth. Do not rub hard or apply force.
- Never use cleaners containing organic solvents to clean the camera or screen.
- Use a blower brush to remove dust from the lens. If cleaning is difficult, contact a Canon Customer Support Help Desk.
- To prevent condensation from forming on the camera after sudden temperature changes (when the camera is transferred from cold to warm environments), put the camera in an airtight, resealable plastic bag and let it gradually adjust to the temperature before removing it from the bag.
- If condensation does form on the camera, stop using it immediately. Continuing to use the camera in this state may damage it. Remove the battery pack and memory card, and wait until the moisture has evaporated before resuming use.
- Before long-term battery storage, use up the battery pack's remaining charge, remove it from the camera, and store it in a plastic bag or similar container. Storing a partially charged battery pack over extended periods (about a year) may shorten its life or affect performance.

Before Use

Basic Guide

Advanced Guide

Camera Basics

Auto Mode / Hybrid Auto Mode

Other Shooting Modes

P Mode

Tv, Av, and M Mode

Playback Mode

Wi-Fi Functions

Setting Menu

Accessories

Appendix

Index



Specifications

| | |
|--|--|
| Camera Effective Pixels (Max.) | Approx. 16.1 million pixels |
| Lens Focal Length | 30x zoom: 4.5 (W) – 135.0 (T) mm (35mm film equivalent: 25 (W) – 750 (T) mm) |
| LCD Monitor | 3.0-type color TFT LCD Effective Pixels: Approx. 922,000 dots |
| File Format | Design rule for Camera File system, DPOF (version 1.1) compliant |
| Data Type | Still Images: Exif 2.3 (JPEG) Movies: MP4 (Video: MPEG-4 AVC/H.264; Audio: MPEG-4 AAC-LC (stereo)) |
| Interface | Hi-speed USB HDMI output Analog audio output (stereo) Analog video output (NTSC/PAL) |
| Power Source | Battery Pack NB-6LH AC Adapter Kit ACK-DC40 |
| Dimensions (Based on CIPA Guidelines) | 112.7 x 65.8 x 34.8 mm (4.44 x 2.59 x 1.37 in.) |
| Weight (Based on CIPA Guidelines) | Approx. 269 g (approx. 9.49 oz.; including the battery pack and memory card) Approx. 245 g (approx. 8.64 oz.; camera body only) |

Wi-Fi

| | |
|-----------------------------|--|
| Standards | IEEE 802.11b/g/n* * 2.4 GHz band only |
| Transmission Methods | OFDM modulation (IEEE 802.11g/n) DSSS modulation (IEEE 802.11b) |
| Communication Modes | Infrastructure mode*1, Ad hoc mode*2 *1 Supports Wi-Fi Protected Setup *2 Wi-Fi Certified IBSS |

| | |
|---------------------------|--|
| Supported Channels | 1 – 11 (PC2091/PC2093) or 1 – 13 (PC2047) Model numbers indicated in parentheses (📖194) |
| Security | WEP, WPA-PSK (AES/TKIP), WPA2-PSK (AES/TKIP) |

Digital Zoom Focal Length (35mm equivalent)

| | |
|------------------------------------|---|
| Digital Zoom [Standard] | 25 – 3000 mm (Represents the combined focal length of optical and digital zoom.) |
| Digital Tele-Converter 1.6x | 40.0 – 1200.0 mm |
| Digital Tele-Converter 2.0x | 50.0 – 1500.0 mm |

Number of Shots/Recording Time, Playback Time

| | | |
|-------------------------------|------------------------------|----------------------------|
| Number of Shots | | Approx. 250 |
| | Eco Mode On | Approx. 360 |
| Movie Recording Time*1 | | Approx. 40 minutes |
| | Continuous Shooting*2 | Approx. 1 hour, 10 minutes |
| Playback Time | | Approx. 4 hours |

*1 Time under default camera settings, when normal operations are performed, such as shooting, pausing, turning the camera on and off, and zooming.

*2 Time available when shooting the maximum movie length (until recording stops automatically) repeatedly.

- The number of shots that can be taken is based on measurement guidelines of the Camera & Imaging Products Association (CIPA).
- Under some shooting conditions, the number of shots and recording time may be less than mentioned above.
- Number of shots/time with a fully charged battery pack.

Before Use

Basic Guide

Advanced Guide

Camera Basics

Auto Mode / Hybrid Auto Mode

Other Shooting Modes

P Mode

Tv, Av, and M Mode

Playback Mode

Wi-Fi Functions

Setting Menu

Accessories

Appendix

Index



Number of 4:3 Shots per Memory Card

| Recording Pixels | Compression Ratio | Number of Shots per Memory Card (Approx. shots) | |
|--------------------------------------|-------------------|---|--------|
| | | 8 GB | 32 GB |
| L (Large) 16M/4608x3456 | | 1058 | 4272 |
| | | 1705 | 6883 |
| M1 (Medium 1) 8M/3264x2448 | | 1996 | 8059 |
| | | 3069 | 12391 |
| M2 (Medium 2) 3M/2048x1536 | | 4723 | 19064 |
| | | 8469 | 34184 |
| S (Small) 0.3M/640x480 | | 27291 | 110150 |
| | | 40937 | 165225 |

- The values in the table are based on Canon measurement conditions and may change depending on the subject, memory card and camera settings.
- The values in the table are based on 4:3 aspect ratio. The number of shots available varies by aspect ratio (46).

Recording Time per Memory Card

| Image Quality | Recording Time per Memory Card | |
|---------------|--------------------------------|-------------------------|
| | 8 GB | 32 GB |
| | 30 min. 03 sec. | 2 hr. 01 min. 27 sec. |
| | 43 min. 29 sec.*1 | 2 hr. 55 min. 43 sec.*2 |
| | 2 hr. 03 min. 55 sec. | 8 hr. 20 min. 32 sec. |
| | 5 hr. 14 min. 34 sec. | 21 hr. 10 min. 38 sec. |

*1 26 min. 22 sec. for iFrame movies (66).

*2 1 hr. 46 min. 33 sec. for iFrame movies (66).

- The values in the table are based on Canon measurement conditions and may

change depending on the subject, memory card and camera settings.

- Recording will automatically stop when the clip file size reaches 4 GB, or when the recording time reaches approximately 29 minutes and 59 seconds when shooting in [], [] or [], or approximately 1 hour when shooting in [].
- Recording may stop even if the maximum clip length has not been reached on some memory cards. SD Speed Class 6 or higher memory cards are recommended.

Flash Range

| | |
|----------------------|------------------------------|
| Maximum wide angle (| 50 cm – 3.5 m (1.6 – 11 ft.) |
| Maximum telephoto (| 1.0 – 2.0 m (3.3 – 6.6 ft.) |

Shooting Range

| Shooting Mode | Focusing Range | Maximum Wide Angle (| Maximum Telephoto (|
|---------------|----------------|-------------------------------|----------------------------|
| AUTO | – | 1 cm (0.4 in.) – infinity | 1.4 m (4.6 ft.) – infinity |
| | – | 1 m (3.3 ft.) – infinity | 8 m (26 ft.) – infinity |
| Other modes | | 5 cm (2.0 in.) – infinity | 1.4 m (4.6 ft.) – infinity |
| | | 1 – 50 cm (0.4 in. – 1.6 ft.) | – |
| | MF* | 1 cm (0.4 in.) – infinity | 1.4 m (4.6 ft.) – infinity |

* Not available in some shooting modes.

Continuous Shooting Speed

| Shooting Mode | Speed |
|---------------|------------------------|
| AUTO P | Approx. 3.1 shots/sec. |
| | Approx. 8.5 shots/sec. |

* Up to four shots at once during continuous shooting

Before Use

Basic Guide

Advanced Guide

Camera Basics

Auto Mode / Hybrid Auto Mode

Other Shooting Modes

P Mode

Tv, Av, and M Mode

Playback Mode

Wi-Fi Functions

Setting Menu

Accessories

Appendix

Index



Shutter Speed

| | |
|---|---|
| [AUTO] mode, automatically set range | 1 – 1/3200 sec. |
| Available values in [Tv] mode (sec.) | 15, 13, 10, 8, 6, 5, 4, 3.2, 2.5, 2, 1.6, 1.3, 1, 0.8, 0.6, 0.5, 0.4, 0.3, 1/4, 1/5, 1/6, 1/8, 1/10, 1/13, 1/15, 1/20, 1/25, 1/30, 1/40, 1/50, 1/60, 1/80, 1/100, 1/125, 1/160, 1/200, 1/250, 1/320, 1/400, 1/500, 1/640, 1/800, 1/1000, 1/1250, 1/1600, 1/2000, 1/2500, 1/3200 |

Aperture

| | |
|---|--|
| f/number | f/3.2 – f/8.0 (W), f/6.9 – f/8.0 (T) |
| Available values in [Av] mode* | f/3.2, f/3.5, f/4.0, f/4.5, f/5.0, f/5.6, f/6.3, f/6.9, f/7.1, f/8.0 |

* Depending on the zoom position, some aperture values may not be available.

Battery Pack NB-6LH

| | |
|-------------------------|---|
| Type: | Rechargeable lithium-ion battery |
| Nominal Voltage: | 3.7 V DC |
| Nominal Capacity: | 1060 mAh |
| Charging Cycles: | Approx. 300 times |
| Operating Temperatures: | 0 – 40 °C (32 – 104 °F) |
| Dimensions: | 34.4 x 41.8 x 6.9 mm (1.35 x 1.65 x 0.27 in.) |
| Weight: | Approx. 22 g (approx. 0.78 oz.) |

Battery Charger CB-2LY/CB-2LYE

| | |
|-------------------------|---|
| Rated Input: | 100 – 240 V AC (50/60 Hz), 0.085 A (100 V) – 0.05 A (240 V) |
| Rated Output: | 4.2 V DC, 0.7 A |
| Charging Time: | Approx. 2 hr. (when using NB-6LH) |
| Charge Indicator: | Charging: orange / Fully charged: green (two-indicator system) |
| Operating Temperatures: | 0 – 40 °C (32 – 104 °F) |

Before Use

Basic Guide

Advanced Guide

Camera Basics

Auto Mode / Hybrid Auto Mode

Other Shooting Modes

P Mode

Tv, Av, and M Mode

Playback Mode

Wi-Fi Functions

Setting Menu

Accessories

Appendix

Index



| | |
|--|----------|
| A | |
| AC adapter kit..... | 156, 159 |
| Accessories..... | 156 |
| AE lock..... | 70 |
| AF frames..... | 76 |
| AF lock..... | 79 |
| Aspect ratio..... | 46 |
| AUTO mode (shooting mode)..... | 16, 28 |
| AV cable..... | 159 |
| Av (shooting mode)..... | 85 |
| B | |
| Batteries → Date/time (date/time battery) Power saving..... | 21 |
| Battery charger..... | 2, 156 |
| Battery pack | |
| Charging..... | 12 |
| Eco mode..... | 148 |
| Level..... | 178 |
| Power saving..... | 21 |
| Black and white images..... | 73 |
| Blink detection..... | 49 |
| C | |
| Camera | |
| Reset all..... | 152 |
| Camera access point mode..... | 129 |
| CameraWindow (computer)..... | 121, 160 |
| CameraWindow (smartphone)..... | 119 |
| CANON iMAGE GATEWAY..... | 114, 116 |

| | |
|---|----------|
| Center (AF frame mode)..... | 76 |
| Clock..... | 26 |
| Color (white balance)..... | 72 |
| Compression ratio (image quality)..... | 82 |
| Connecting via an access point..... | 124 |
| Connecting without an access point.. | 129 |
| Continuous shooting..... | 79 |
| High-speed burst HQ (shooting mode)..... | 64 |
| Creative filters (shooting mode)..... | 57 |
| Creative Shot (shooting mode)..... | 53 |
| Cropping..... | 107, 164 |
| Custom white balance..... | 72 |

| | |
|-----------------------------|-----|
| D | |
| Date/time | |
| Adding date stamps..... | 38 |
| Changing..... | 15 |
| Date/time battery..... | 15 |
| Settings..... | 14 |
| World clock..... | 147 |
| DC coupler..... | 159 |
| Defaults → Reset all | |
| Digital tele-converter..... | 75 |
| Digital zoom..... | 34 |
| Display language..... | 16 |
| DPOF..... | 167 |
| Drive mode..... | 79 |

| | |
|---------------|-----|
| E | |
| Eco mode..... | 148 |

| | |
|---|-----|
| Editing | |
| Cropping..... | 107 |
| i-Contrast..... | 109 |
| My Colors..... | 108 |
| Red-eye correction..... | 109 |
| Resizing images..... | 106 |
| Editing or erasing connection information..... | 142 |
| Erasing..... | 101 |
| Error messages..... | 175 |
| Exposure | |
| AE lock..... | 70 |
| Compensation..... | 69 |
| FE lock..... | 81 |
| Eye-Fi cards..... | 2 |

| | |
|--------------------------------------|-----|
| F | |
| Face AiAF (AF frame mode)..... | 76 |
| Face ID..... | 40 |
| Face self-timer (shooting mode)..... | 63 |
| Favorites..... | 105 |
| FE lock..... | 81 |
| File numbering..... | 151 |
| Fireworks (shooting mode)..... | 56 |
| Fish-eye effect (shooting mode)..... | 58 |
| Flash | |
| Deactivating flash..... | 80 |
| Flash exposure compensation..... | 81 |
| On..... | 80 |
| Slow synchro..... | 80 |

| | |
|--------------------|----|
| Focusing | |
| AF frames..... | 76 |
| AF lock..... | 79 |
| AF-point zoom..... | 49 |
| MF peaking..... | 75 |

| | |
|-----------------------|----------|
| Servo AF..... | 78 |
| Focusing range | |
| Macro..... | 74 |
| Manual focus..... | 74 |
| Focus lock..... | 76 |
| FUNC. menu | |
| Basic operations..... | 23 |
| Table..... | 182, 188 |

| | |
|------------------------------|----|
| G | |
| GPS..... | 91 |
| GPS information display..... | 91 |
| Grid lines..... | 48 |

| | |
|---|-----|
| H | |
| Handheld nightscene (shooting mode)..... | 56 |
| HDMI cable..... | 157 |
| High-speed burst HQ (shooting mode)..... | 64 |
| Household power..... | 159 |
| Hybrid Auto (shooting mode)..... | 30 |

| | |
|-------------------------------------|---------|
| I | |
| i-Contrast..... | 71, 109 |
| iFrame movies (movie mode)..... | 66 |
| Image quality | |
| → Compression ratio (image quality) | |
| Images | |
| Display period..... | 51 |
| Erasing..... | 101 |
| Playback → Viewing | |
| Protecting..... | 98 |
| Image stabilization..... | 82 |

| |
|---------------------------------|
| Before Use |
| Basic Guide |
| Advanced Guide |
| Camera Basics |
| Auto Mode / Hybrid Auto Mode |
| Other Shooting Modes |
| P Mode |
| Tv, Av, and M Mode |
| Playback Mode |
| Wi-Fi Functions |
| Setting Menu |
| Accessories |
| Appendix |
| Index |



| | |
|-----------------|-----|
| Image Sync..... | 139 |
| Indicator..... | 26 |
| ISO speed..... | 71 |

L

| | |
|--|----|
| Lamp..... | 50 |
| Live View Control (shooting mode)..... | 54 |
| Low light (shooting mode) | 56 |

M

| | |
|-------------------------------------|-----|
| Macro (focusing range)..... | 74 |
| Magnified display..... | 96 |
| Manual focus (focusing range) | 74 |
| Memory cards..... | 2 |
| Recording time | 190 |

Menu

| | |
|---------------------------------------|-----|
| Basic operations..... | 24 |
| Table..... | 180 |
| Mercury lamp correction..... | 47 |
| Metering method..... | 70 |
| Miniature effect (shooting mode)..... | 58 |
| Mobile device connection button | 137 |
| Monochrome (shooting mode)..... | 60 |

Movies

| | |
|--|------------|
| Editing | 110 |
| Image quality (resolution/ frame rate)..... | 46, 48, 67 |
| Recording time | 190 |

| | |
|--------------------------------|---------|
| M (shooting mode)..... | 86 |
| Multi-area White Balance | 47 |
| My Colors | 73, 108 |

P

| | |
|-------------------------------------|----------|
| Package contents..... | 2 |
| Photobook set-up | 169 |
| PictBridge | 156, 163 |
| Playback → Viewing | |
| Portrait (shooting mode)..... | 55 |
| Poster effect (shooting mode) | 57 |
| Power | 156 |
| → AC adapter kit | |
| → Battery pack | |
| Power saving..... | 21 |
| Printing | 163 |
| Program AE | 69 |
| Protecting | 98 |
| P (shooting mode) | 69 |

R

| | |
|-------------------------------|---------|
| Red-eye correction | 47, 109 |
| Remote shooting | 141 |
| Reset all..... | 152 |
| Resizing images | 106 |
| Resolution (image size) | 46 |
| Rotating..... | 104 |

S

| | |
|---------------------------------|----------|
| Saving images to a computer.... | 136, 161 |
| Screen | |
| Display language..... | 16 |
| Icons..... | 178, 179 |
| Menu → FUNC. menu, Menu | |
| SD/SDHC/SDXC memory cards | |
| → Memory cards | |
| Searching | 93 |

| | |
|--|---------------|
| Self-timer | 37 |
| 2-second self-timer..... | 37 |
| Customizing the self-timer..... | 38 |
| Face self-timer (shooting mode) ... | 63 |
| Wink self-timer (shooting mode) ... | 62 |
| Sending images..... | 133 |
| Sending images to a computer..... | 115 |
| Sending images to another camera.... | 116 |
| Sending images to a printer..... | 116 |
| Sending images to a smartphone..... | 115 |
| Sending images to Web services | 114 |
| Sepia tone images..... | 73 |
| Servo AF..... | 78 |
| Shooting | |
| Shooting date/time → Date/time | |
| Shooting information | 178 |
| Slideshow | 96 |
| Smart Shuffle..... | 97 |
| Smart Shutter (shooting mode) | 61 |
| Smile (shooting mode)..... | 61 |
| Snow (shooting mode)..... | 56 |
| Soft focus (shooting mode)..... | 60 |
| Software | |
| Installation | 121 |
| Saving images to a computer | 136, 161 |
| Sounds | 146 |
| Stereo AV cable..... | 156, 157, 159 |
| Strap..... | 2, 12 |
| Super slow motion movie (movie mode)..... | 66 |
| Super vivid (shooting mode)..... | 57 |

T

| | |
|---|---------------|
| Terminal..... | 157, 159, 163 |
| Toy camera effect (shooting mode) | 59 |
| Tracking AF | 77 |
| Traveling with the camera | 147 |
| Troubleshooting..... | 172 |
| TV display..... | 157 |
| Tv (shooting mode)..... | 85 |

V

| | |
|----------------------------|-----|
| Viewing | 18 |
| Image search | 93 |
| Index display | 93 |
| Magnified display | 96 |
| Single-image display | 18 |
| Slideshow..... | 96 |
| Smart Shuffle | 97 |
| TV display | 157 |

W

| | |
|--------------------------------------|-----|
| White balance (color)..... | 72 |
| Widescreen (resolution)..... | 46 |
| Wi-Fi functions..... | 113 |
| Wi-Fi menu | 123 |
| Wink self-timer (shooting mode)..... | 62 |
| World clock..... | 147 |
| Wrist strap → Strap | |

Z

| | |
|--------------------------|------------|
| Zoom | 17, 28, 34 |
| Zoom framing assist..... | 35 |

Before Use

Basic Guide

Advanced Guide

Camera Basics

Auto Mode / Hybrid
Auto Mode

Other Shooting
Modes

P Mode

Tv, Av, and M Mode

Playback Mode

Wi-Fi Functions

Setting Menu

Accessories

Appendix

Index



Wi-Fi (Wireless LAN) Precautions

- The camera's model number is PC2091/PC2093/PC2047. To identify your model, check the label on the bottom of the camera for a number beginning with PC. The built-in WLAN module model is written below.

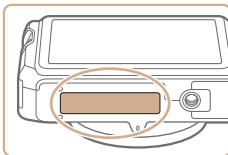

| Country/Region of Purchase | WLAN Module Model |
|----------------------------|-------------------|
| U.S.A., Canada | WM224 |
| Other | WM223 |

- Countries and Regions Permitting WLAN Use
 - Use of WLAN is restricted in some countries and regions, and illegal use may be punishable under national or local regulations. To avoid violating WLAN regulations, visit the Canon website to check where use is allowed.
Note that Canon cannot be held liable for any problems arising from WLAN use in other countries and regions.
- Doing any of the following may incur legal penalties:
 - Altering or modifying the product
 - Removing the certification labels from the product
- According to foreign exchange and foreign trade law regulations, export permission (or service transaction permission) from the Japanese government is necessary to export strategic resources or services (including this product) outside Japan.
- Because this product includes American encryption software, it falls under U.S. Export Administration Regulations, and cannot be exported to or brought into a country under U.S. trade embargo.

- Be sure to make notes of the wireless LAN settings you use.
The wireless LAN settings saved to this product may change or be erased due to incorrect operation of the product, the effects of radio waves or static electricity, or accident or malfunction. Be sure to make notes of wireless LAN settings as a precaution. Please note that Canon accepts no responsibility for direct or indirect damages or loss of earnings resulting from a degradation or disappearance of content.
- When transferring this product to another person, disposing of it, or sending it for repair, be sure to note the wireless LAN settings and reset the product to its default settings (erase settings) if necessary.
- Canon will not make compensation for damages resulting from loss or theft of the product.
Canon accepts no responsibility for damages or loss resulting from unauthorized access or use of target devices registered on this product due to loss or theft of the product.
- Be sure to use the product as directed in this guide.
Be sure to use the wireless LAN function of this product within the guidelines noted in this guide. Canon accepts no responsibility for damages or loss if the function and product are used in ways other than as described in this guide.
- Do not use the wireless LAN function of this product near medical equipment or other electronic equipment.
Use of the wireless LAN function near medical equipment or other electronic equipment may affect operation of those devices.

Before Use

Basic Guide

Advanced Guide

Camera Basics

Auto Mode / Hybrid Auto Mode

Other Shooting Modes

P Mode

Tv, Av, and M Mode

Playback Mode

Wi-Fi Functions

Setting Menu

Accessories

Appendix

Index



Radio Wave Interference Precautions

- This product may receive interference from other devices that emit radio waves. To avoid interference, be sure to use this product as far away as possible from such devices, or avoid using the devices at the same time as this product.

Complies with
IDA Standards
DB00671

This product is installed with the WLAN Module which is certified to standards set by IDA Singapore.

Security Precautions

Because Wi-Fi uses radio waves to transmit signals, security precautions more stringent than when using a LAN cable are required. Keep the following points in mind when using Wi-Fi.

- Only use networks you are authorized to use.

This product searches for Wi-Fi networks in the vicinity and displays the results on the screen. Networks you are not authorized to use (unknown networks) may also be displayed. However, attempting to connect to or using such networks could be regarded as unauthorized access. Be sure to use only networks you are authorized to use, and do not attempt to connect to other unknown networks.

If security settings have not been properly set, the following problems may occur.

- Transmission monitoring

Third parties with malicious intent may monitor Wi-Fi transmissions and attempt to acquire the data you are sending.

- Unauthorized network access

Third parties with malicious intent may gain unauthorized access to the network you are using to steal, modify, or destroy information. Additionally, you could fall victim to other types of unauthorized access such as impersonation (where someone assumes an identity to gain access to unauthorized information) or springboard attacks (where someone gains unauthorized access to your network as a springboard to cover their tracks when infiltrating other systems).

To prevent these types of problems from occurring, be sure to thoroughly secure your Wi-Fi network.

Only use this camera's Wi-Fi function with a proper understanding of Wi-Fi security, and balance risk and convenience when adjusting security settings.



The camera can print to PictBridge-compatible printers via Wi-Fi. PictBridge technical standards make it easy to connect digital cameras, printers, and other devices directly. Additionally, a new standard called DPS over IP enables PictBridge connections in network environments, and the camera is also compatible with this standard.

CAUTION

RISK OF EXPLOSION IF BATTERY IS REPLACED BY AN INCORRECT TYPE.
DISPOSE OF USED BATTERIES ACCORDING TO LOCAL REGULATION.

Before Use

Basic Guide

Advanced Guide

Camera Basics

Auto Mode / Hybrid
Auto Mode

Other Shooting
Modes

P Mode

Tv, Av, and M Mode

Playback Mode

Wi-Fi Functions

Setting Menu

Accessories

Appendix

Index



Battery Charger CB-2LY

IMPORTANT SAFETY INSTRUCTIONS- SAVE THESE INSTRUCTIONS. DANGER-TO REDUCE THE RISK OF FIRE OR ELECTRIC SHOCK, CAREFULLY FOLLOW THESE INSTRUCTIONS.

For connection to a supply not in the U.S.A., use an attachment plug adapter of the proper configuration for the power outlet, if needed.



USA and Canada only:

The Lithium ion/polymer battery that powers the product is recyclable.

Please call 1-800-8-BATTERY for information on how to recycle this battery.

FCC/IC Notice

Model: PC2091 (including WLAN Module Model WM224, FCC ID: AZD224)

The available scientific evidence does not show that any health problems are associated with using low power wireless devices. There is no proof, however, that these low power wireless devices are absolutely safe. Low power Wireless devices emit low levels of radio frequency energy (RF) in the microwave range while being used. Whereas high levels of RF can produce health effects (by heating tissue), exposure to low-level RF that does not produce heating effects causes no known adverse health effects. Many studies of low-level RF exposures have not found any biological effects. Some studies have suggested that some biological effects might occur, but such findings have not been confirmed by additional research. This model has been tested and found to comply with FCC/IC radiation exposure limits set forth for an uncontrolled equipment and meets the FCC radio frequency (RF) Exposure Guidelines in Supplement C to OET65 and RSS-102 of the IC radio frequency (RF) Exposure rules.

This device complies with Part 15 of FCC Rules and Industry Canada licence-exempt RSS standard(s). Operation is subject to the following two conditions: (1) this device may not cause interference, and (2) this device must accept any interference, including interference that may cause undesired operation of this device.

This transmitter must not be co-located or operated in conjunction with any other antenna or transmitter.

Before Use

Basic Guide

Advanced Guide

Camera Basics

Auto Mode / Hybrid
Auto Mode

Other Shooting
Modes

P Mode

Tv, Av, and M Mode

Playback Mode

Wi-Fi Functions

Setting Menu

Accessories

Appendix

Index



FCC Notice

(Digital Camera, Model PC2091 systems)

This device complies with Part 15 of the FCC Rules. Operation is subject to the following two conditions;

- (1) this device may not cause harmful interference, and
- (2) this device must accept any interference received, including interference that may cause undesired operation.

Note: This equipment has been tested and found to comply with the limits for Class B digital devices, pursuant to Part 15 of the FCC rules. These limits are designed to provide reasonable protection against harmful interference in a residential installation.

This equipment generates, uses and can radiate radio frequency energy and, if not installed and used in accordance with the instructions, may cause harmful interference to radio communications. However, there is no guarantee that interference will not occur in a particular installation. If this equipment does cause harmful interference to radio or television reception, which can be determined by turning the equipment off and on, the user is encouraged to try to correct the interference by one or more of the following measures:

- Reorient or relocate the receiving antenna.
- Increase the separation between the equipment and receiver.
- Connect the equipment into an outlet on a circuit different from that to which the receiver is connected.
- Consult the dealer or an experienced radio/TV technician for help.

The cable with the ferrite core provided with the digital camera must be used with this equipment in order to comply with Class B limits in Subpart B of Part 15 of the FCC rules.

Do not make any changes or modifications to the equipment unless otherwise specified in the manual. If such changes or modifications should be made, you could be required to stop operation of the equipment.

Canon U.S.A., Inc.

One Canon Park, Melville, New York 11747, U.S.A.

Tel No. 1-800-OK-CANON (1-800-652-2666)

Canadian Radio Interference Regulations

CAN ICES-3 (B)/NMB-3 (B)

To ensure proper operation of this product, use of genuine Canon accessories is recommended.

For CA, USA only

Included lithium battery contains Perchlorate Material - special handling may apply. See www.dtsc.ca.gov/hazardouswaste/perchlorate/ for details.

Trademarks and Licensing

- Microsoft and Windows are trademarks or registered trademarks of Microsoft Corporation in the United States and/or other countries.
- Macintosh and Mac OS are trademarks of Apple Inc., registered in the U.S. and other countries.
- App Store, iPhone, and iPad are trademarks of Apple Inc.
- The SDXC logo is a trademark of SD-3C, LLC.
- HDMI, the HDMI logo and High-Definition Multimedia Interface are trademarks or registered trademarks of HDMI Licensing, LLC.
- The iFrame logo and the iFrame symbol are trademarks of Apple Inc.
- Wi-Fi®, Wi-Fi Alliance®, WPA™, WPA2™ and Wi-Fi Protected Setup™ are trademarks or registered trademarks of the Wi-Fi Alliance.
- All other trademarks are the property of their respective owners.
- This device incorporates exFAT technology licensed from Microsoft.
- This product is licensed under AT&T patents for the MPEG-4 standard and may be used for encoding MPEG-4 compliant video and/or decoding MPEG-4 compliant video that was encoded only (1) for a personal and non-commercial purpose or (2) by a video provider licensed under the AT&T patents to provide MPEG-4 compliant video. No license is granted or implied for any other use for MPEG-4 standard.

Before Use

Basic Guide

Advanced Guide

Camera Basics

Auto Mode / Hybrid Auto Mode

Other Shooting Modes

P Mode

Tv, Av, and M Mode

Playback Mode

Wi-Fi Functions

Setting Menu

Accessories

Appendix

Index



Disclaimer

- Unauthorized reproduction of this guide is prohibited.
- All measurements based on Canon testing standards.
- Information subject to change without notice, as are product specifications and appearance.
- Illustrations and screenshots in this guide may differ slightly from the actual equipment.
- The above items notwithstanding, Canon cannot be held liable for any loss arising from the use of this product.

Before Use

Basic Guide

Advanced Guide

Camera Basics

Auto Mode / Hybrid
Auto Mode

Other Shooting
Modes

P Mode

Tv, Av, and M Mode

Playback Mode

Wi-Fi Functions

Setting Menu

Accessories

Appendix

Index



Free Manuals Download Website

<http://myh66.com>

<http://usermanuals.us>

<http://www.somanuals.com>

<http://www.4manuals.cc>

<http://www.manual-lib.com>

<http://www.404manual.com>

<http://www.luxmanual.com>

<http://aubethermostatmanual.com>

Golf course search by state

<http://golfingnear.com>

Email search by domain

<http://emailbydomain.com>

Auto manuals search

<http://auto.somanuals.com>

TV manuals search

<http://tv.somanuals.com>