

Canon

IXUS Z65

ELPH LT270



E

C

K

M

S

E Instructions

K 설명서

S Instrucciones

C 説明書

M Arahan

P Instruções



Handling Precautions

1. This camera is not resistant to water, and should not be used outdoors if it is raining or snowing. If it is accidentally dropped in water, contact an authorized Canon service facility. Keep the camera out of salt spray and excessive humidity. *If used at the beach, clean it thoroughly afterward with a dry cloth.*
2. Store the camera in a cool, dry, dust-free place. Be sure to keep the camera out of direct sunlight, and away from "hot spots" such as the trunk or rear window shelf of a car. Avoid places where mothballs are used, and use a desiccant in excessive humidity.
3. Do not attempt to disassemble the camera yourself, since there is high-voltage circuitry inside.
4. The battery may explode or cause burns if disassembled, recharged, shorted, exposed to high temperatures, or disposed of in a fire.
5. Use a blower brush to remove dust and sand from the lens and inside the camera. Do not apply any fluids to the lens or body. Take the camera to an authorized Canon service facility for a more thorough cleaning if necessary.
6. Film passing through X-ray examinations at an airport may be exposed and ruined even when loaded in the camera. Request a different method of inspection to avoid damage.
7. Color reproduction may be adversely affected if the film is left in the camera for a long time. Always develop exposed film promptly.

This device complies with Part 15 of the FCC Rules. Operation is subject to the following two conditions: (1) This device may not cause harmful interference, and (2) this device must accept any interference received, including interference that may cause undesired operation.

Do not make any changes or modifications to the equipment unless otherwise specified in the instructions. If such changes or modifications should be made, you could be required to stop operation of the equipment.

This equipment has been tested and found to comply with the limits for a class B digital device, pursuant to part 15 of the FCC Rules. These limits are designed to provide reasonable protection against harmful interference in a residential installation. This equipment generates, uses and can radiate radio frequency energy and, if not installed and used in accordance with the instructions, may cause harmful interference to radio communications.

However, there is no guarantee that interference will not occur in a particular installation. If this equipment does cause harmful interference to radio or television reception, which can be determined by turning the equipment off and on, the user is encouraged to try to correct the interference by one or more of the following measures:

- Reorient or relocate the receiving antenna.
- Increase the separation between the equipment and receiver.
- Consult the dealer or an experienced radio/TV technician for help.

This digital apparatus does not exceed the Class B limits for radio noise emissions from digital apparatus as set out in the interference-causing equipment standard entitled "Digital Apparatus", ICES-003 of the Industry Canada.

Cet appareil numérique respecte les limites de bruits radioélectriques applicables aux appareils numériques de Classe B prescrites dans la norme sur le matériel brouilleur: "Appareils Numériques", NMB-003 édictée par l'Industrie Canada.



The CE Mark is a Directive conformity mark of the European Community (EC)

Thank you for purchasing this Canon product.
Before taking pictures, please read these instructions carefully for a thorough understanding of how the camera operates.

Table of Contents

These instructions are divided into four sections: Introduction, Basic Operations, Advanced Operations, and Additional Information. When first using the camera, be sure to read the instructions from the Introduction.

Convention

The following convention is used in these instructions:



Warnings you should observe when using the camera.



Additional information on using the camera.

(→ ■) is shorthand for "See page ■".

1	Introduction	
	Handling Precautions	2
	Table of Contents	4
	Advanced Photo System Quick Reference	6
	Quick Reference.....	8
	Nomenclature	10
	Attaching and Using the Strap	13
	Holding the Camera	14
2	Basic Operations	
	① Loading the Battery	15
	② Loading the Film Cartridge	16
	About the Film Cartridges	17
	③ Turning the Power On	18
	④ Checking the Battery Power	18
	⑤ Choosing the Print Type	19
	⑥ Using the Zoom	20

7	Taking Pictures in Auto Flash Mode	21
	Green/Orange Indicators	22
	Taking Pictures through a Window	23
	Close-up Photography	24
8	Removing the Film Cartridge	25
	Film Cartridge Processing.....	26
	Handling Film Cartridges After Exposure	26

E

3 **Advanced Operations**

	Changing the Flash Mode	27
	Auto Flash	28
	Auto Flash with Red-eye Reduction	29
	Red-eye Reduction Function	30
	Flash ON (Forced Flash) Mode	31
	Flash OFF (Suppressed Flash) Mode	32
	Slow-synchro (Nighttime Portrait) Mode.....	33
	Using Focus Lock.....	34
	Using the Self-timer	35
DATE	Imprinting the Date and Time	36
	Selecting the Date Format	37
	Setting the Date and Time.....	38
	Imprinting Titles.....	40
	Selecting the Title Language	40
	Selecting the Title	41
	Specifying the Print Quantity	42
	Setting the Custom Functions	44
	Realtime Release Photography	46

1

2

4 **Additional Information**

	Troubleshooting	47
	Questions and Answers	49
	Major Specifications	50

3

Advanced Photo System Quick Reference

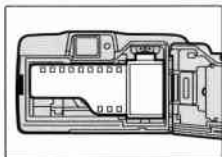

Previous film

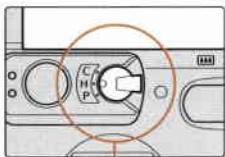
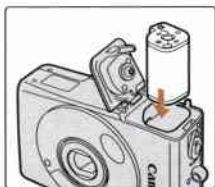

Print type selection lever



C print



H print



P print

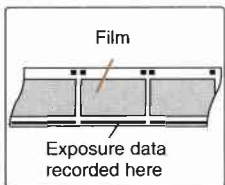

Data recorded on film
(example)

- Date and title
- Print type
- Print quantity
- Flash ON/OFF
- Brightness value
- Etc.

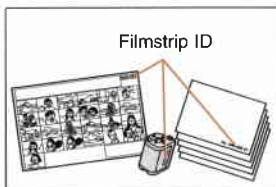

1 Simple film cartridge loading. (→ 16)

- Unlike previous 135 (35mm) film, there is no need to open the back cover and pull the film leader across.

2 A choice of print types (→ 19)

- You can choose from three print types.
- C print: Classic print
 - H print: Wide-angle print
 - P print: Panorama print

3 A variety of data (IX information) is recorded magnetically on the film surface.

- All the information described at left can be recorded on the film.
- The exposure information is used in the printing process to produce better quality prints.

1

4 Exposed film cartridges can be processed for printing at Advanced Photo System certified shops. (→ 26)

- After developing, the shop will return your pictures, along with an index print, and the film cartridge with the film inside.
- When ordering reprints from a certified shop, just match the ID on the back of the print or on the index print sheet with the ID on the film cartridge, and specify which prints you want.

Quick Reference

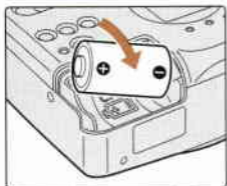

1 Load the battery. (→ 15)

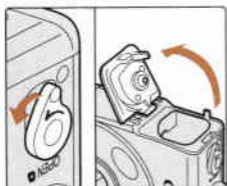

2 Open the film cartridge compartment cover. (→ 16)

- Turn the crank until the compartment cover opens.
- Check that the visual exposure indicator on the film cartridge shows ○ (unexposed).

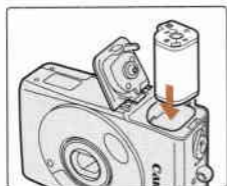

3 Drop in the film cartridge and close the cover. (→ 16)

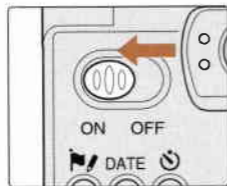

4 Switch the camera on. (→ 18)

- ➔ The lens cover opens and the lens and flash are set for shooting.

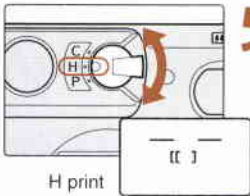

- 5** Choose the print type.
(→ 19)
→ The viewfinder screen changes.

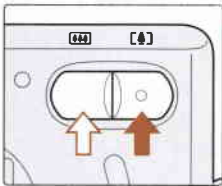

- 6** Press the zoom button to set the subject size.
(→ 20)

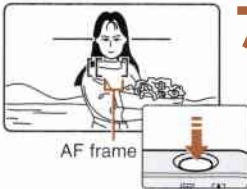

- 7** Position the AF frame over the subject and take the picture. (→ 21)
→ The flash fires automatically in low-light conditions.

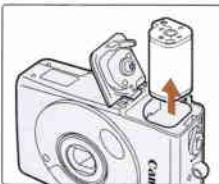

- 8** When you have finished the film and it has rewound, remove the film cartridge. (→ 25)

- Check that frame counter has returned to "0" and the  icon is blinking before you open the film cartridge compartment cover.
- Remove the film cartridge and close the film cartridge compartment cover.

Nomenclature

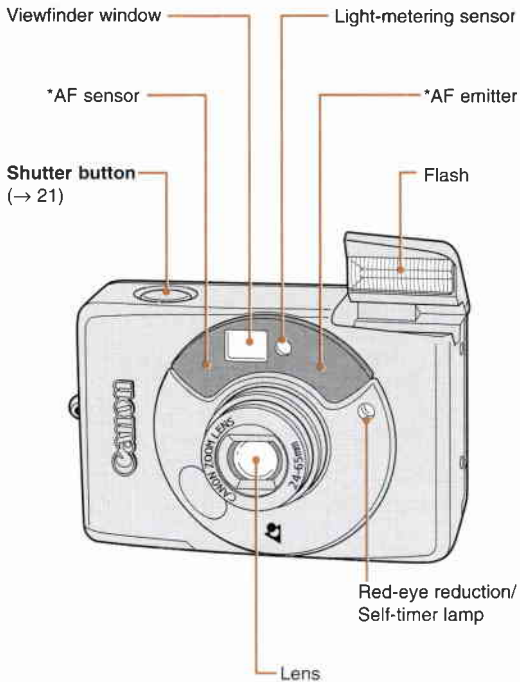

For further details, refer to the page indicated.

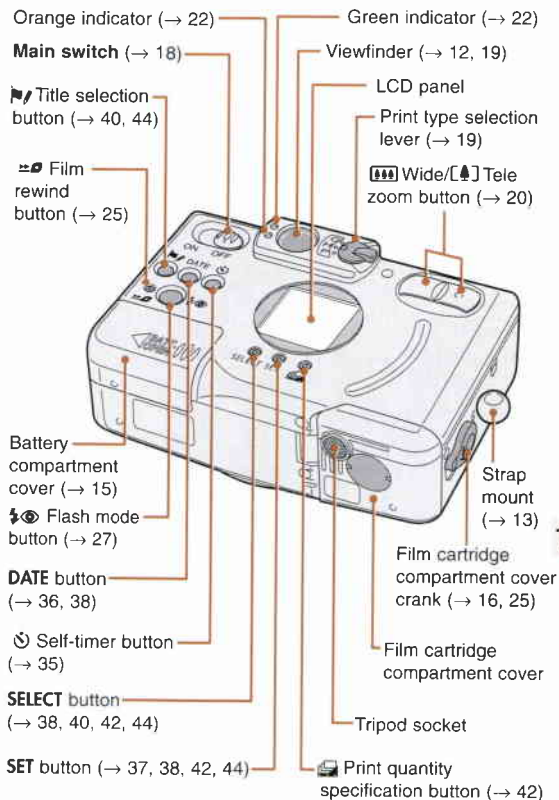

*AF is an abbreviation for Auto Focus.

LCD Panel (normally displays only the required information)

Two-sided date
imprinting indicator

Date/Title no./Print quantity/
Custom function no. indicator

Red-eye reduction
indicator

Title imprinting indicator
Self-timer indicator

Flash OFF
(suppressed flash)
indicator



Frame counter

Flash ON
(forced flash) indicator

Film cartridge
indicator

Slow-synchro
(nighttime portrait) indicator

Battery level indicator



(on)

The battery is fully charged.



(on)

Prepare a new battery.



(blinking)

Install the new battery. (→ 15)

Viewfinder Frames

Close-up Frame

When taking pictures at distances between 0.45 and 1.0 m (1.5 and 3.3 ft.), compose your picture below this frame. The area above this frame will not appear in the picture. (→ 24)

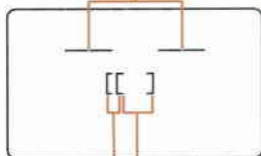

Picture Frame

Compose your picture
within this frame (H print).
(→ 19)

AF Frame

Position this frame over the subject.
(→ 21, 34, 46)

Close-up AF Frame

Use this frame for close-up subjects (0.45 to 1.0 m/1.5 to 3.3 ft. from the camera). (→ 24)

Print Type Selection Lever (→ 19)

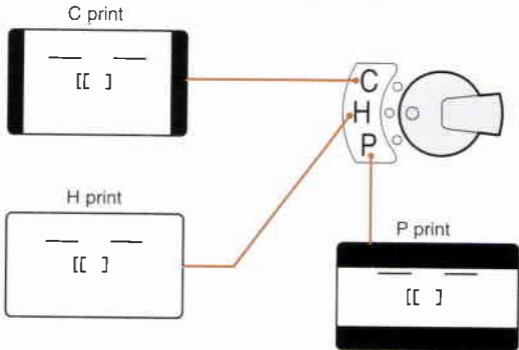

Attaching and Using the Strap



Attaching the strap.

- To ensure that you do not drop your camera, attach the strap provided.
- Thread the strap through the strap mount as shown in steps ① and ②.

1

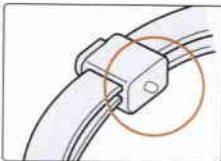

Using the button-push projection.

- Use the button-push projection to push the **SELECT** button (→ 38, 40, 42, 44), the **SET** button (→ 37, 38, 42, 44), the **▶▶** button (→ 25) and the **📄** button (→ 42).

Holding the Camera

To avoid obscuring the image with your fingers and to ensure a clear sharp image, take care to keep your hands, hair and the camera strap away from the areas marked with a • below.

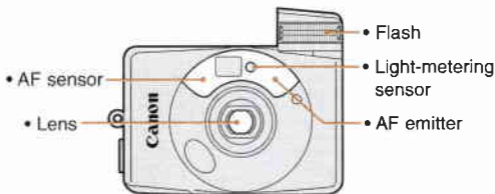

Hold the camera as shown below when taking pictures.

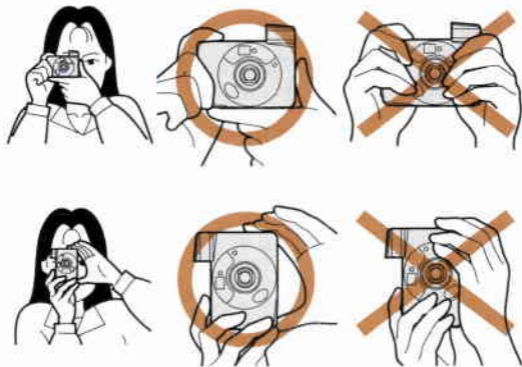

Dust or soiling on the AF emitter/sensor or lens causes focusing difficulties. Wipe soiled areas clean before taking pictures.

1 Loading the Battery

Applicable Battery: One CR2 lithium battery



- 1 Open the battery cover.**
- Press down on the  and slide the cover off.

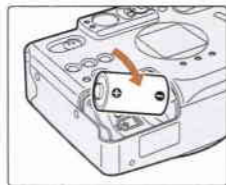

- 2 Load the new battery.**
- Ensure that the + and – terminals are positioned correctly.
 - ➔ The  icon appears on the LCD panel.

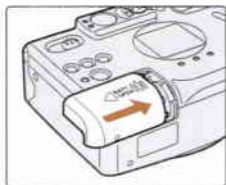

- 3 Reattach the cover.**
- Slide the cover back into place.
 - ➔ The date/time display on the LCD panel shows “-- --” blinking. Set the date and time. (→ 38)

1

2

2 Loading the Film Cartridge

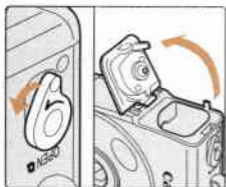

1 Open the film cartridge compartment cover.

- Turn the crank until the compartment cover opens.

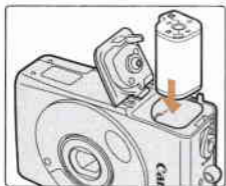

2 Load the film cartridge.

- Check that the visual exposure indicator on the film cartridge shows  (unexposed).
- Load the cartridge with the visual exposure indicator facing upwards.

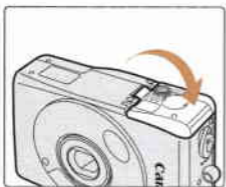

3 Close the film cartridge compartment cover.

- Press the film cartridge compartment cover closed until it clicks into place.
- ➔ The  icon appears on the LCD panel and the film is automatically wound on.

Frame counter

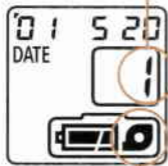

Film cartridge indicator

4 "1" appears on the frame counter.

- If "1" is not shown, try again, checking that the film cartridge is loaded correctly.

About the Film Cartridges

- Use IX240 cartridge film.
- You cannot use conventional 135 (35mm) film in this camera.
- Use film cartridges that show the ○ (unexposed) visual exposure indicator.

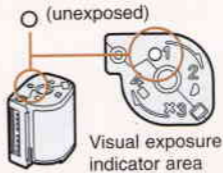

Checking the Film Data

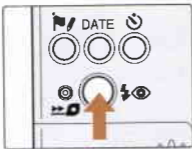

- Slide the main switch to OFF.
- Press the button.
- ➔ The information shown below appears on the LCD panel.

Film sensitivity (ISO speed)



Maximum number of available shots.

Film type

- Cn: Color negative film
- Cr: Color reversal film
- bL: Black and white film
- -: Other film



If you load a film cartridge showing the (exposed), (processed) or (partially exposed) indicator, "0" appears on the frame counter and the icon blinks. Replace the film cartridge with one that shows the ○ (unexposed) indicator.

3 Turning the Power On

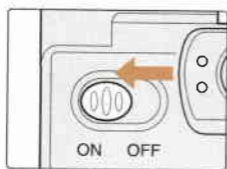

Slide the main switch to ON.

- ➔ The lens cover opens and the lens and flash are set for shooting.
- If you slide the switch to OFF, the lens and flash both retract, the lens cover closes and the camera switches off.







Take care not to obstruct the lens or flash with your fingers.



When you switch the camera off, the display on the LCD panel does not disappear.

4 Checking the Battery Power

Check that the battery icon  appears on the LCD panel when you switch the camera on.

-  (on) The battery is fully charged.
-  (on) Prepare a new battery.
-  (blinking) Install the new battery. (→ 15)

A new battery generally has sufficient capacity for eight 25-exposure film cartridges (based on Canon's Standard Test Method with normal temperatures and with the flash used for 50% of shots). At low temperatures ($-10^{\circ}\text{C}/14^{\circ}\text{F}$), the battery capacity is approximately one third of normal capacity.



- Use one CR2 lithium battery.
- Always check the battery capacity before using the camera.
- If you are traveling or intend to take many pictures, take a supply of spare batteries. The batteries may be difficult to obtain at your destination.
- If you take a number of consecutive shots using the flash, the battery power may drop off temporarily and prevent the LCD panel from displaying data correctly. If this occurs, switch the camera off and wait a few minutes before switching it on again.

5 Choosing the Print Type

With this camera, you can choose any of 3 print formats to suit your subject: C print, H print or P print.

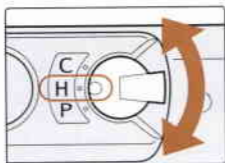

Turn the print type selection lever.

- ➔ The viewfinder screen changes as shown below when you select a print type.
- You can select a different print type for each shot.
- ➔ The black areas in the viewfinder do not appear on the print.

Viewfinder

Printed photo

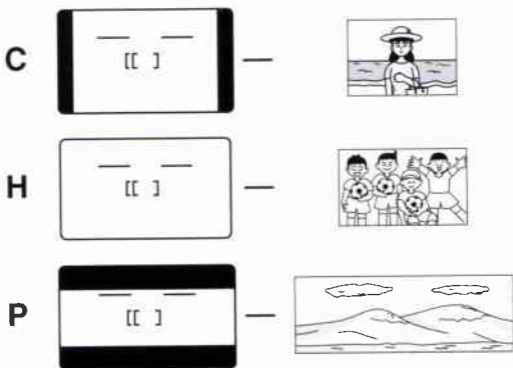



2



- When you take pictures at distances between 0.45 and 1.0 m (1.5 and 3.3 ft.), the area above the close-up frame is not photographed. (→ 12, 24)
- For P prints, because of the large variation between the area visible in the viewfinder and the area actually photographed, shots should be taken from distances of at least 2 m (6.6 ft.).

6 Using the Zoom

You can use the  Wide/[] Tele zoom button to change the size of your subject.



Wide-angle (24 mm)

Use this setting for large-scale images such as scenery and group pictures.





[] Telephoto (65 mm)

Use this setting for pictures where you want to zoom in on your subject, such as portraits.



Press the  Wide/ [] Tele zoom button.

- Pressing [] zooms in on your subject while pressing  zooms out for a wide-angle shot.

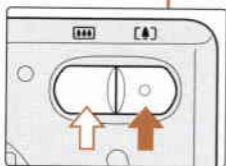

Take care not to obstruct the lens with your hands.



- When you switch the camera on, the lens is initially set to wide-angle (24 mm).
- If the camera is left unused for approximately 4 minutes with the lens extended to the telephoto position, the lens automatically retracts to the wide-angle position as a protective measure.

7 Taking Pictures in Auto Flash Mode

E

The shutter button has a two-step action. The first step sets the focus and exposure, while the second step releases the shutter. In low-light conditions, the flash fires automatically.

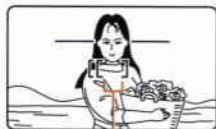

AF frame

1 Set the focus.

- Position the AF frame over the subject and press the shutter button down halfway.
- ➔ The green indicator lights when the subject is in focus.
- ➔ The orange indicator lights when the flash is set to fire automatically. (→ 11)
- Keep the shutter button pressed down halfway.

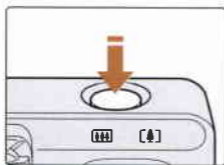

2 Compose the shot and take the picture.

- Press the shutter button down fully.
- Press the button down gently and smoothly.
- ➔ The shutter is released.

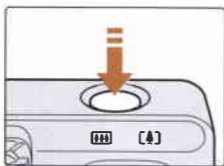

There is a very short delay between the shutter button being pressed and the shutter releasing. In general, you should continue to hold the camera still until you hear the sound of the film winding on, which indicates that the shot has been taken.



- Pressing the flash down sets the flash mode to Flash OFF. (→ 32)
- You can use the CF1 custom function setting to set the camera to Realtime Release mode, in which the shutter is released instantly. (→ 44, 46)

2



Green/Orange Indicators

When you press the shutter button down halfway, the indicators light or blink to show whether the camera is ready to shoot.



Green indicator

Lit: Camera ready to shoot (subject in focus).

Blinks: Proximity warning

Orange indicator

Lit: Flash fully charged.

Blinks: Camera shake warning (in  flash mode)



- When the green indicator blinks, move away from the subject until the indicator stops blinking and then press the shutter button again.

The table below shows the proximity warning range.

Print Type	Warning Range
C/H	25 to 45 cm (0.8 to 1.5 ft.)
P	25 cm to 2 m (0.8 to 6.6 ft.)

- The green indicator may light even at distances of less than 25 cm (0.8 ft.). Take care not to get too close to the subject.
- When the orange indicator blinks (camera shake warning), use a tripod or other means to hold the camera steady.

• Taking Pictures through a Window

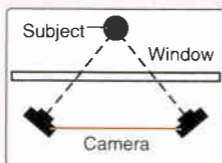

When you are taking pictures through a window, hold the camera 20 to 40 cm (0.7 to 1.3 ft.) from the glass and shoot at an angle to the glass.

If you are too far from the window or shoot directly at the glass, the camera may focus on the surface of the glass rather than on the subject.

Close-up Photography

When you are shooting at distances of 45 cm to 1 m (1.5 to 3.3 ft.), the area visible through the viewfinder does not match the area actually included in the shot. The area above the close-up frame will not be included in the photograph.

For taking pictures at distances of 45 cm to 1 m (1.5 to 3.3 ft.), follow the steps below, using the close-up AF frame.

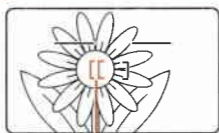

Close-up AF frame

1 Set the focus.

- Position the close-up AF frame over the subject and press the shutter button down halfway.
 - ➔ The green indicator lights when the subject is in focus.
- Keep the shutter button pressed down halfway.

2 Compose the shot and take the picture.

- Compose the shot so that the subject is below the close-up frame and take the picture.
- Do not change the distance between the camera and the subject.

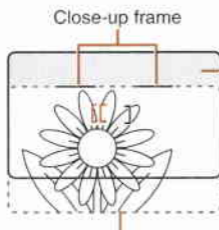

Area actually photographed (inside dotted line)



For P prints, because of the large variation between the area visible in the viewfinder and the area actually photographed, shots should be taken from distances of at least 2 m (6.6 ft.).



8 Removing the Film Cartridge

The film rewinds automatically when it reaches the end. The frame counter counts down as the film rewinds. When the film is fully rewound, the frame counter shows "0" and the  icon blinks.

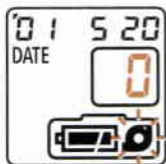
- You can use the CF3 custom function setting to prevent the camera from automatically rewinding when it reaches the end of the film. (→ 44)



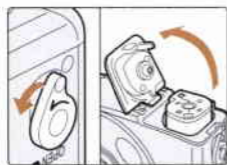

1 Check that the icon is blinking.

- If the  icon is not blinking, press the  button. (→ 11)





2 Open the film cartridge compartment cover.

- Turn the crank to open the cover and take out the film cartridge.
 - The  icon on the LCD panel disappears.
 - The visual exposure indicator on the film cartridge has changed to  (exposed).

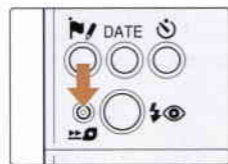
To remove the film cartridge in mid-roll



- Press the  button. (→ 11)
- When you remove the film cartridge, the visual exposure indicator on the cartridge changes to  (exposed).



Film Cartridge Processing

- Exposed film cartridges can be processed for printing at Advanced Photo System certified shops.
- All certified shops do the following:
 - ① Return your cartridge with the film inside.
 - ② Process all three types of prints.
 - ③ Make an index print sheet.
 - ④ Use the print quality data for better quality prints.
 - ⑤ Imprint the date and title on the back of the print.

Handling Film Cartridges After Exposure

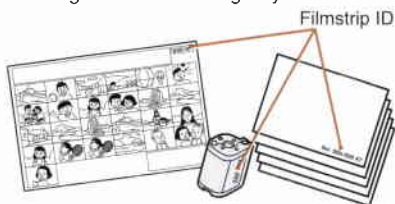
- When ordering reprints at a certified shop, be sure to match the ID number from the back of the print you want or from the index print with the ID on the film cartridge before handing in your film cartridge.



- Handle and store index prints and returned film cartridges carefully.
- The visual exposure indicator is set to  (exposed) for film cartridges that have been fully exposed, and to  (processed) for film cartridges that have been developed.
- Do not place cameras or film cartridges near televisions, speakers, or other sources of strong magnetic fields.

⚡👁 Changing the Flash Mode

E

You can switch the flash off or set it to fire each time you take a picture. Select the mode that best suits your subject and your surroundings.

- The (⚡) and 👁(⚡) settings can be stored in the camera's memory. Initially, the camera is set so that the flash mode is (⚡) when you switch the camera on. However, if you switch the camera off while the flash mode is set to 👁(⚡), that setting is stored in the camera's memory and the flash mode will begin from 👁(⚡) when you switch the camera back on.
- You can use the CF2 custom function setting to specify that whichever flash mode is active when you switch off the camera should be stored in the camera's memory. (→ 44)



Select the flash mode.

- Each time you press the ⚡👁 button, the flash mode changes to the next setting in the cycle shown below.

⚡👁 Flash mode button

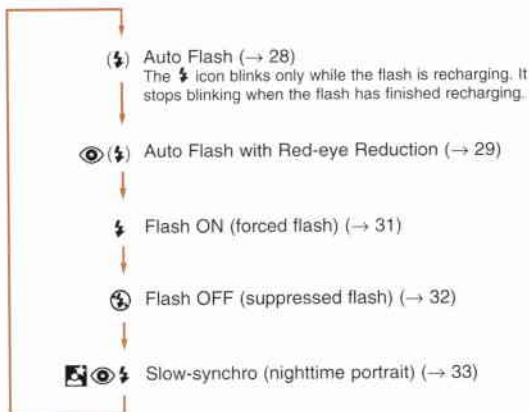

2

3

Auto Flash

Use this mode to take pictures of subjects other than people, or to photograph people without using the red-eye reduction function.

In low-light conditions, the flash fires automatically when you press the shutter button.

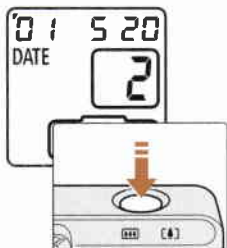





Set the flash mode to .

- ➔ When you switch the camera on, the camera is set to  Auto Flash mode.
- ➔ If the flash is going to fire automatically, the orange indicator lights when you press the shutter button down halfway. (→ 11)
- Take the picture.

Effective Flash Range (using negative color film)

Film speed	Wide-angle	Telephoto
ISO 100	0.45 to 3.7 m (1.5 to 12.1 ft.)	0.45 to 2.1 m (1.5 to 6.9 ft.)
ISO 200	0.45 to 5.2 m (1.5 to 17.1 ft.)	0.45 to 2.9 m (1.5 to 9.5 ft.)
ISO 400	0.45 to 7.4 m (1.5 to 24.3 ft.)	0.45 to 4.2 m (1.5 to 13.8 ft.)



- Pressing the flash down sets the flash mode to Flash OFF. (→ 32)
- If the , ,  or  icon is displayed on the LCD panel, press the  button until none of the flash mode icons are displayed.

Auto Flash with Red-eye Reduction

Use this mode to reduce the red-eye effect when you are taking pictures of people in low-light conditions. When you press the shutter button, the red-eye reduction lamp lights and then the flash fires.



1 Set the flash mode to



- Press the  button until the  icon appears on the LCD panel.

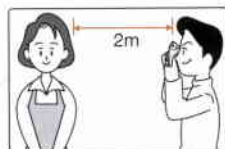

2 Move to within 2 m (6.6 ft.) of your subject.

- The effective range of the red-eye reduction lamp is 2 m (6.6 ft.).

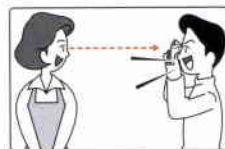

3 Get your subject to look at the camera.

- The red-eye reduction function is only effective if the subject is looking directly at the camera.

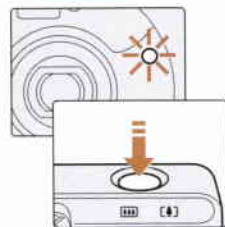



4 Take the picture.



- Slowly press the shutter button down fully.
- ➔ Shutter release is delayed for about a second while the red-eye reduction lamp lights.
- Keep the shutter button pressed down until you hear the film advance to the next frame.

Red-eye Reduction Function

When you use the flash to take photos of people in low-light conditions, their eyes sometimes glow red in the photograph. This is referred to as the red-eye effect and is caused by the light of the flash reflecting off the retina of the eye.

In  and  modes, the red-eye reduction lamp lights for approximately 1 second before the flash fires. This causes the subject's pupils to contract and thereby minimizes the risk of red-eye.



When the red-eye reduction lamp lights, shutter operation is delayed for approximately 1 second to heighten the effectiveness of the lamp. To make the shutter operate immediately, use the  button to select () mode (→ 28) and then take the picture.



Important guidelines for using the red-eye reduction function

1. Because this function is not effective unless the subject is looking directly at the lamp, attract the subject's attention so that he or she looks at the camera.
2. Take the picture from within 2 m (6.6 ft.) of your subject.
3. The effectiveness of the red-eye reduction function varies from person to person.
4. Take the picture with the lens set to the wide-angle setting. (→ 20)
5. Raise the ambient light level as much as possible.

⚡ Flash ON (Forced Flash) Mode

In this mode, the flash fires regardless of the light conditions when the picture is taken. Use this setting for fill-in flash in daylight or to soften the outline of the subject.

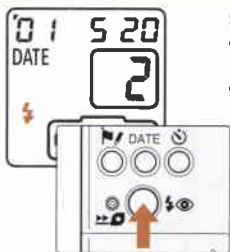
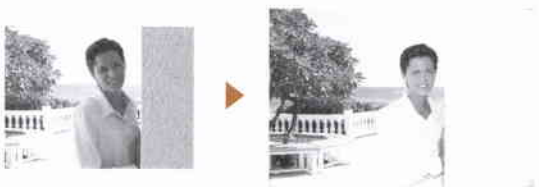

Set the flash mode to ⚡.

- Press the ⚡👁 button until the ⚡ icon appears on the LCD panel.
- Take the picture.



Flash OFF (Suppressed Flash) Mode

In this mode, the flash does not fire regardless of how dark conditions are when the picture is taken.

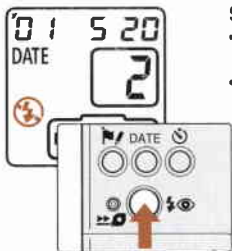
Use this mode for sunset shots, for places where flash use is prohibited, or for available-light photography.



Set the flash mode to .

- Press the  button until the  icon appears on the LCD panel.
- Take the picture.





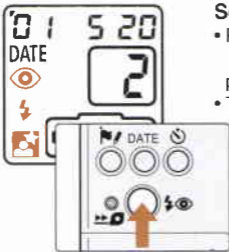

- Because a slow shutter speed is used (up to 2 seconds) when the flash is set to  mode in low-light conditions, take care to avoid camera shake.
- When the orange indicator blinks (camera shake warning), use a tripod or other means to hold the camera steady.

Slow-synchro Mode



This function is useful when you are taking pictures of people against a sunset or nighttime background. The combination of slow shutter speed and flash illuminates the subject while still capturing the background.













Set the flash mode to   .

- Press the   button until the    icons appear on the LCD panel.
- Take the picture.



Because a slow shutter speed (up to 2 seconds) is used in    mode, always use a tripod to prevent camera shake. Take care also to ensure that the subject does not move immediately after the flash fires.



- The red-eye reduction function operates when the mode is set to   . (→ 30)
- In some conditions,   mode (→ 29) may give better results. For this reason, it is best to take the shot in both    mode and   mode.

Using Focus Lock

Lock the focus when you want the subject of your shot to be off to one side of the frame.

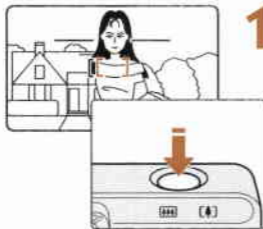

1 Set the focus.

- Position the AF frame over the subject and press the shutter button down halfway.
- ➔ The green indicator lights when the subject is in focus.
- Keep the shutter button pressed down halfway.

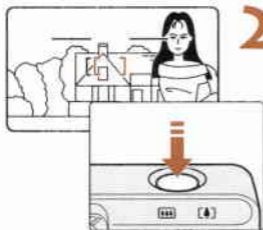

2 Compose the shot and take the picture.

- Compose your shot.
- Press the shutter button down fully.
- Press the button down gently and smoothly.
- ➔ The shutter is released.



Take care that the distance from the camera to the subject does not change. If the distance does change, lock the focus again.

Using the Self-timer

The self-timer function allows you to take a picture when you are some distance from the camera.

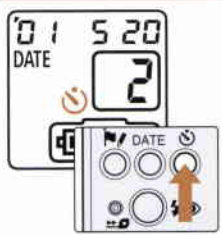

1 Set the mode to Self-timer.

- ➔ Press the button.
- ➔ The icon appears on the LCD panel.
- If you press the button again, the disappears and Self-timer mode is cancelled.

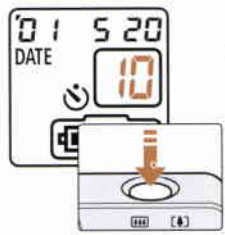

2 Compose the picture and press the shutter button.

- ➔ The red-eye reduction lamp blinks once a second and a countdown of the number of seconds remaining before the photo is taken is displayed on the LCD panel.
- ➔ The picture is taken after approximately 10 seconds.
- To cancel the self-timer, press the button.

Do not stand directly in front of the camera when you press the shutter button as this will result in the picture being out of focus.

- Approximately 2 seconds before the shutter is released, the lamp begins to flash more rapidly. If the red-eye reduction function and the flash are both used, the lamp stays lit for the last 2 seconds.
- Self-timer shots can be taken for the 4 minutes that the icon is displayed.
- Set the camera on a stable surface or use a tripod to hold the camera steady.
- The Focus Lock function can be used in the same way as in normal photography.

DATE Imprinting the Date and Time

The date and time can be imprinted on the back or on both sides of your photograph.

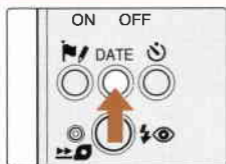

Select the date/time combination.

- The date/time combination changes each time you press the **DATE** button.
- Take the picture with the desired date/time combination selected.

	Date only (imprinted on both sides)
	Date + time ★ (imprinted on both sides)
	Date + time ★ (imprinted on back)

★: Only the day, hour and minute (20 14:25) are displayed on the LCD panel, but the imprinted data will show a combination of hours, minutes, and the date in the selected date format (Year-Month-Day, Month-Day-Year, or Day-Month-Year). (Ex. " '01 05 20 14:25".)

Also, the "01" in the year display indicates the last two digits in the year 2001.



- **Note that the character size, shape, color, position, and the availability of both-side imprinting may vary according to the individual photo shop.**
- The date, time and title do not appear on the film negative but are imprinted when the prints are made, using the data magnetically recorded on the film by the camera (IX data).
- In addition to the date and time, the data imprinted on the back of each photo includes the film cartridge ID number and the frame number.

Selecting the Date Format

- Always use the push-button projection on the strap buckle to push the **SET** button. (→ 13)

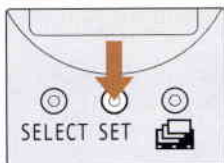

Select the date format.

- Press the **DATE** button so that only the date is displayed.
- The date format changes each time you press the **SET** button.

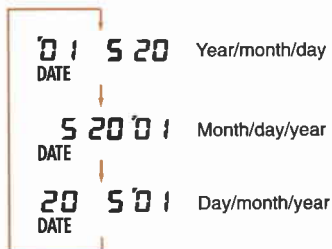

The selected date format is retained when you replace the battery.

Setting the Date and Time

When you replace the battery or travel abroad, use the procedure below to set or adjust the date and time settings.

- Always use the push-button projection on the strap buckle to push the **SELECT** and **SET** buttons. (→ 13)

Setting the Date

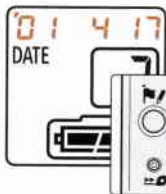

1 Display the date only.

- Press the **DATE** button to display the date only. (→ 36)
- Refer to the next page to set the time.

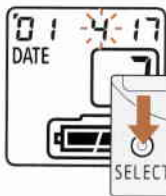

2 Select a date setting.

- Press the **SELECT** button to select the number you want to change.
- ➔ The selected setting (blinking numbers) changes sequentially from year to month to day.

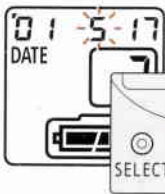

3 Set the date.

- Press the **SET** button to set the date.
- Repeat steps 2 and 3 to set all the date settings.
- If you press the **SELECT** button and none of the date settings blink, date setting is complete.

Setting the Time

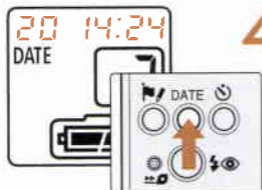

4 Display the date and time.

- Press the **DATE** button to display the date and time. (→ 36)
- Refer to the previous page to set the date.

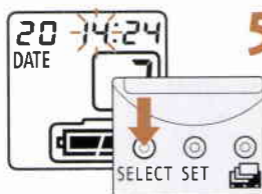

5 Select the time setting.

- Press the **SELECT** button to select the setting.
- ➔ The selected setting (blinking numbers) changes sequentially from hour to minute to second (colon " : ").

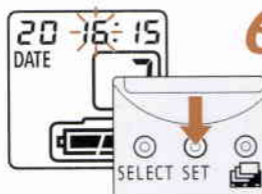

6 Set the time.

- Press the **SET** button to set the time.
- Repeat steps 5 and 6 to set all the time settings.
- If you press the **SELECT** button and the colon " : " does not blink, time setting is complete.





- If you replace the battery, the date and time display on the LCD panel reverts to three blinking dashes ("-- -- --") (no date or time imprinting). When this occurs, perform steps 2, 3, 5 and 6 to set the date and time.
- Holding the button down for 2 seconds or more causes the setting to change continuously.
- If you press the **SET** button when the colon " : " is blinking, the seconds display is set to zero.

Imprinting Titles

You can imprint titles on the back of the print.

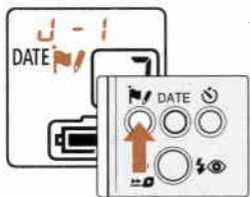
Selecting the Title Language



- 1 Press the  button.**
→ The symbol  is displayed on the LCD panel.

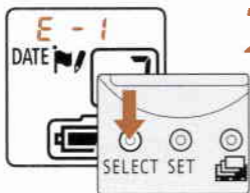



- 2 Press the SELECT button to select the language.**
 - The language changes every time you press in this order: Japanese, English, French, German, Spanish, Italian.

Canceling Title Imprinting

- Press the **DATE** button until the symbol  disappears from the LCD panel.



- The title imprinting function automatically returns to a date/time setting after one frame is exposed. To continuously imprint the same title, hold down the  button for two seconds or longer (until the  blinks on the LCD panel).
- **Note that the character size, shape, color, position, and language may vary according to the individual photo shop.**
- The date and time as set by the Date function are also printed with the title.
- If you want information imprinted on the front of your prints, be sure to check with the photo shop, that they provide this service, before the film is processed.

Selecting the Title

Once you have selected the language for your title, you can select the title.

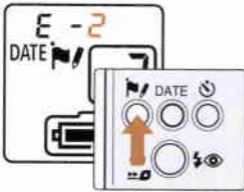

Press the button.

- ➔ The title number changes every time you press.
- Select the title you want to use, then take the picture.

Button Sequence

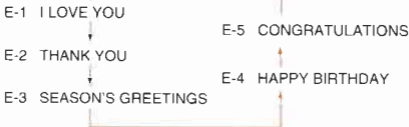

Japanese Titles

- J-1 オメデトウ
- J-2 カンゲキ!
- J-3 カワイイデショ!
- J-4 ヨロシク!
- J-5 ウレシイナ

French Titles

- F-1 JE T'AIME
- F-2 MERCI
- F-3 MEILLEURS VOEUX
- F-4 JOYEUX ANNIVERSAIRE
- F-5 FÉLICITATIONS

Italian Titles

- I-1 TI AMO
- I-2 GRAZIE
- I-3 BUONE FESTE
- I-4 BUON COMPLEANNO
- I-5 CONGRATULAZIONI

German Titles

- D-1 ICH LIEBE DICH
- D-2 DANKE SCHÖN
- D-3 HERZLICHE GLÜCKWÜNSCHE
- D-4 FRÖHLICHE WEIHNACHTEN
- D-5 FROHES NEUES JAHR

Spanish Titles

- ES-1 TE QUIERO
- ES-2 GRACIAS
- ES-3 FELICES PASCUAS
- ES-4 FELIZ CUMPLEAÑOS
- ES-5 FELICIDADES

Specifying the Print Quantity

This feature allows you to specify the number of prints (0 to nine) of a frame to be produced at one time. This is useful as it saves the trouble of having additional prints made and can be used to avoid getting prints of unsuccessful shots.

Note that you can only set or change the print quantity for the frame about to be shot (next frame) or the frame just shot (previous frame).

- When you load negative film, the print quantity is automatically set to 1 (P-1).
- When you load reversal film, the print quantity is automatically set to 0 (P-0).
- Always use the push-button projection on the strap buckle to push the SELECT, SET and  buttons. (→ 13)

Setting the Print Quantity For the Next Frame

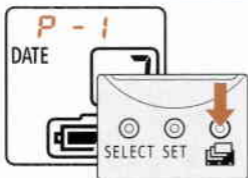

1 Set the print quantity.

- Press the  button.
→ Each time you press the button, the setting changes sequentially from P-1, to P-2, through to P-9 and then back to P-0, P-1, etc. (This cycle begins at P-0 when reversal film is used.)
- Hold the button down for 2 seconds or more to cycle continuously through the settings.

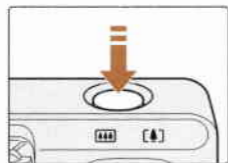

2 Take the picture.

- After you shoot a frame, the print quantity specification reverts to the default setting of 1 print (0 prints for reversal film).

Changing the Print Quantity After Taking a Shot

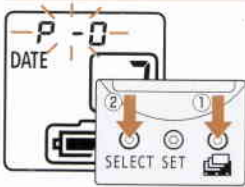

1 Select the mode for specifying the print quantity for the previous frame.

- Press the  button ① and then press the **SELECT** button ② for at least 2 seconds.
- ➔ "P-0" (no prints) blinks on the LCD panel.

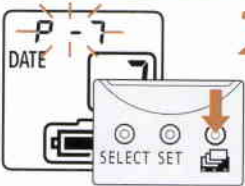

2 Set the print quantity.

- Press the  button.
- ➔ Each time you press the button, the setting changes sequentially from P-1, to P-2, through to P-9 and then back to P-0, P-1, etc.
- Hold the button down for 2 seconds or more to cycle continuously through the settings.

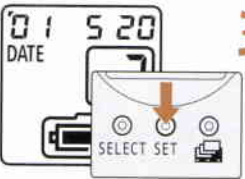

3 Complete the setting.

- Press the **SET** button.
- ➔ The film rewinds 1 frame and the print quantity specification for the previous frame is replaced.
- The date/time display reappears.



- If you switch the camera off before completing the setting, the setting reverts to its previous value.
- If you replace the battery, the date and time display on the LCD panel reverts to three blinking dashes ("-- -- --") and you cannot specify the print quantity. When this occurs, set the date and time before specifying the print quantity. (→ 38)
- Some photo shops may not support the print quantity specification function. Check with the photo shop beforehand.

Setting the Custom Functions

Custom Function No.		Setting	
Realtime Release	CF 1	0	Off
		1	On
Flash Mode Memory	CF 2	0	Off
		1	On
Automatic Film Rewind	CF 3	0	On
		1	Off

- Always use the push-button projection on the strap buckle to push the **SELECT** and **SET** buttons. (→ 13)

Custom Function No. Setting display (Initially set to 0)

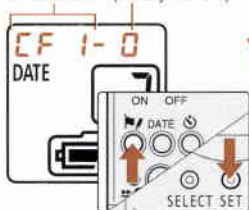

1 Select custom function setting.

- Slide the main switch to OFF.
- Hold down the  button and press the **SET** button.
- ➔ "CF 1-0" appears on the LCD panel.

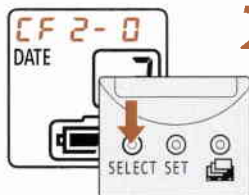

2 Select a function.

- The selected function changes sequentially from CF1 to CF2 to CF3, and back to CF1, each time you press the **SELECT** button.

Effects with the Function Set to 1

Releases the shutter immediately when you press the shutter button down halfway and then press it down fully. Useful for situations where you need an instant camera response. (→ 46)

Stores the flash mode in memory immediately before the camera is switched off. Useful when you always want to set the flash to a **particular** mode.

Useful for situations where you do not want the sudden sound of the film rewinding. Press the  button to start film rewinding.

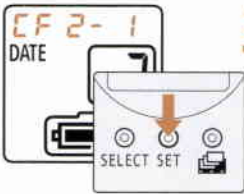

3 Set the function.

- Press the **SET** button to change the setting display to 1 (function enabled). Press the **SET** button again to change the setting to 0 (function disabled).
- Pressing the **DATE** button or setting the main switch to ON completes the settings.



The custom function settings are retained even when you switch the camera off and on, replace the film cartridge, or replace the battery.

Realtime Release Photography

- To use this mode, set the custom function CF1 to 1. (→ 44)



1 Set the focus.



- Position the AF frame over the subject and press the shutter button down halfway.
 - ➔ The camera makes a brief whirring sound.
 - ➔ The green indicator lights when the subject is in focus.
- Keep the shutter button pressed down halfway.



2 Take the picture.



- When the photo opportunity arrives, press the shutter button down fully.
 - ➔ The shutter is released immediately.





- If you press the shutter button all the way down in a single movement, realtime release does not operate.
- Take care that the distance from the camera to the subject does not change. If the distance does change, start again from step 1.
- Take care not to touch the lens as this may result in the picture being out of focus.
- The  and  modes use red-eye reduction and should not be used, as the shutter cannot be released immediately.
- The Focus Lock function can be used in the same way as for normal photography.

Troubleshooting

In case of trouble check the table below before taking your camera to be repaired.

Problem	Cause	Remedy	Page
The  icon blinks on the LCD panel.	<ul style="list-style-type: none"> •The battery has expired. 	<ul style="list-style-type: none"> •Replace the battery. 	15
The  icon is not displayed on the LCD panel.	<ul style="list-style-type: none"> •No battery is loaded. 	<ul style="list-style-type: none"> •Load a battery. 	15
	<ul style="list-style-type: none"> •The battery is inserted with the wrong polarities. 	<ul style="list-style-type: none"> •Reinsert the battery correctly. 	15
	<ul style="list-style-type: none"> •The battery has completely expired. 	<ul style="list-style-type: none"> •Replace the battery. 	15
The shutter does not release.	<ul style="list-style-type: none"> •The power is turned off. 	<ul style="list-style-type: none"> •Turn the power on. 	18
	<ul style="list-style-type: none"> •The battery has expired. 	<ul style="list-style-type: none"> •Replace the battery. 	15
	<ul style="list-style-type: none"> •An exposed or processed film cartridge has been loaded in the camera. 	<ul style="list-style-type: none"> •Remove the film cartridge and load a new one. 	25, 16
	<ul style="list-style-type: none"> •The shutter will be released only after the red-eye reduction lamp is lit for about 1 second. 	<ul style="list-style-type: none"> •Hold the shutter button down until the shutter releases. •Change the flash mode to AUTO. 	29 27
The camera makes a zooming sound when you press the shutter button down halfway.	<ul style="list-style-type: none"> •Custom function CF1 is set to 1. 	<ul style="list-style-type: none"> •Set custom function CF1 to 0. 	44
The camera is not automatically set to Auto flash mode.	<ul style="list-style-type: none"> •Custom function CF2 is set to 1. 	<ul style="list-style-type: none"> •Set custom function CF2 to 0. 	44
The film does not automatically rewind.	<ul style="list-style-type: none"> •Custom function CF3 is set to 1. 	<ul style="list-style-type: none"> •Set custom function CF3 to 0. 	44

Problem	Cause	Remedy	Page
The photographs are blurred.	<ul style="list-style-type: none"> •When the shutter was released, the AF emitter/sensor were blocked. 	<ul style="list-style-type: none"> •Ensure that the AF emitter/sensor are not blocked by hair, fingers, etc. 	14
	<ul style="list-style-type: none"> •In  mode, you were standing directly in front of the camera when you pressed the shutter button. 	<ul style="list-style-type: none"> •Make sure you do not stand immediately in front of the camera when pressing the shutter button. 	35
	<ul style="list-style-type: none"> •The camera moved when the shutter button was pressed (camera shake). •The AF emitter/sensor or lens is dirty. 	<ul style="list-style-type: none"> •Press the shutter button slowly and gently. •Wipe them clean. 	21 14
"H" appears blinking on the LCD panel.	<ul style="list-style-type: none"> •The self-diagnosis function detected an error. 	<ul style="list-style-type: none"> •Switch the camera off and then on again. •Remove the battery from the camera. When "H" disappears from the LCD panel, load the battery again. 	18 15
The film cartridge compartment cover will not open, even when the film counter reads 0.	<ul style="list-style-type: none"> •Rewinding was not fully completed. 	<ul style="list-style-type: none"> •Press the  button. 	25

Questions and Answers

E

Q1 Can conventional 135 (35mm) film be used?

A1 No it cannot be used. Use IX240 film cartridges. (→ 17)

Q2 Can slide (reversal) film be used with this camera?

A2 Yes it can.

Q3 What is ISO?

A3 The ISO number indicates the film's sensitivity to light in numerical terms. The higher the number, the more sensitive the film is to light.

Q4 The picture was taken with date imprinting, but it doesn't appear on the index print. Why is this?

A4 The date and time are recorded on the film surface magnetically. This data is read electronically and imprinted during the printing process. This is why the date and time data may not appear on the index print sheets.

Q5 When converted to a 35mm camera, what is this camera's 24–65 mm focusing distance equivalent to?

A5 Approximately 30–81 mm (for H prints).

Major Specifications

Type: IX240 fully-automatic lens-shutter AF camera with built-in zoom lens and magnetic IX functions

Image Size: 16.7 × 30.2 mm

Lens: Canon 24–65 mm f/4.5–8.0 lens

Focusing: Active autofocus

Shooting distance: 0.45 m to ∞ (1.5 ft. to ∞)

Shutter: Combination aperture and program electromagnetically driven shutter

Viewfinder: Real-image zoom viewfinder

Coverage: Approx. 86%

Viewfinder Information: Picture frame, AF frame, Close-up frame, Close-up AF frame

Viewfinder Eyepiece Indicators:

Green indicator Combination camera-ready indicator and proximity warning

Orange indicator Combination flash-ready indicator and camera shake warning

Film Cartridge Loading: Automatic

Film Advance: Automatic with mid-roll rewind

Frame Counter: Counts up during film advance and counts down during film rewinding

Self-Timer: 10 sec. delayed shutter release with operation display

Metering Range:

Flash AUTO and Flash ON modes:

Wide-angle: 1/500 sec. at f/16 to 1/50 sec. at f/4.5

Telephoto: 1/500 sec. at f/32 to 1/130 sec. at f/8.0

Flash OFF and Slow-Synchro modes:

Wide-angle: 1/500 sec. at f/16 to 2 sec. at f/4.5

Telephoto: 1/500 sec. at f/32 to 2 sec. at f/8.0

Film Speed: ISO 25-10000, set automatically in 1/3-step increments

Built-in Flash: Built-in flash fires automatically in low-light conditions

Flash Range:

ISO 100	Wide-angle: 0.45 to 3.7 m (1.5 to 12.1 ft.); Telephoto: 0.45 to 2.1 m (1.5 to 6.9 ft.)
ISO 200	Wide-angle: 0.45 to 5.2 m (1.5 to 17.1 ft.); Telephoto: 0.45 to 2.9 m (1.5 to 9.5 ft.) (using negative color film)

Flash Recycling Time: Approx. 6.5 seconds (with new battery)

Flash Mode Selection: Using flash mode button

Auto Flash: Fires automatically in low-light conditions.

Auto Flash with Red-eye Reduction: Fires automatically in low-light conditions.

Flash ON: Fires for all shots (forced flash)

Flash OFF: Never fires (suppressed flash)

Slow-synchro: Fires for all shots (with red-eye reduction)

Date & Time/Title Imprinting:

Imprinted Data: Date & time or title (5 selections in 6 languages)

Clock function: Built-in automatic calendar up to 2049.

Character types: Dependent on processing lab specifications

Imprinting color: Dependent on processing lab specifications

Custom Functions: ① Realtime Release setting
② Flash mode memory setting
③ Automatic film rewind setting

Power Supply: One lithium battery (CR2, 3V)

Number of Shots: Approx. 8 cartridges of 25-exposure film
(normal temperature with 50% flash use)

Dimensions (W × H × D): 95 × 64 × 34.5 mm (3.7 × 2.5 × 1.4 in)

Weight: 180 g (6.3 oz.) (excluding battery)

- All data are based on Canon's Standard Test Method.
- Subject to change without notice

© 中國語

MEMO

A series of horizontal dashed lines for writing.

Canon

CANON INC. 30-2, Shimomaruko 3-chome, Ohta-ku, Tokyo 146-8501, Japan

U.S.A. ——— CANON U.S.A. INC.

For all inquiries concerning this camera, call toll free in the U.S.
1-800-828-4040 or write to: Customer Relations, Canon U.S.A., Inc.
One Canon Plaza, Lake Success, N.Y. 11042-1198

CANADA ——— CANON CANADA INC. HEADQUARTERS

6390 Dixie Road, Mississauga, Ontario L5T 1P7, Canada

CANON CANADA INC. MONTREAL BRANCH

5990, Côte-de-Liesse, Montréal Québec H4T 1V7, Canada

CANON CANADA INC. CALGARY OFFICE

2828, 16th Street, N.E. Calgary, Alberta T2E 7K7, Canada

For all inquiries concerning this camera, call toll free in Canada
1-800-828-4040

EUROPE, ——— CANON EUROPA N.V.

AFRICA &
MIDDLE EAST
Bovenkerkerweg 59-61, P.O. Box 2262, 1180 EG Amstelveen,
The Netherlands

CANON PHOTO VIDEO FRANCE S.A. Service Center

102, Avenue du Général de Gaulle 92257 La Garenne-Colombes Cedex, France

CANON UK LTD.

Woodhatch Reigate Surrey RH2 8BF, United Kingdom

CANON EURO-PHOTO G. m. b. H.

Siemensring 90-92, D-47877 Willich, Germany

CANON ITALIA S.p.A.

Palazzo L, Strada 6, 20089 Rozzano, Milanofiori, Milano, Italy

CANON Benelux N.V./S.A.

Bessenveldstraat 7, 1831 Diegem (Machelen), Belgium

CANON Schweiz AG

Geschäftsbereich Wiederverkauf, Industriestrasse 12, CH-8305 Dietlikon
Switzerland

CANON G. m. b. H.

Oberlaaerstrasse 233, 4th floor, 1100 Wien, Austria

CANON España, S. A.

C/Joaquín Costa, 41, 28002 Madrid, Spain

SEQUE Soc. Nac. de Equip., Lda.,

Praça da Alegria, 58, 2º, 1269-149 Lisboa, Portugal

CENTRAL & ——— CANON LATIN AMERICA, INC. DEPTO DE VENTAS

SOUTH AMERICA 6505 Blue Lagoon Drive, Suite 325, Miami, FL33126 U.S.A.

**CANON LATIN AMERICA, INC. CENTRO DE SERVICIO Y
REPARACION**

Apartado 2019, Zona Libre de Colón, República de Panamá

ASIA ——— CANON HONGKONG CO., LTD.

9/F, The Hong Kong Club Building, 3A Chater Road, Central, Hong Kong

OCEANIA ——— CANON AUSTRALIA PTY. LTD.

1 Thomas Holt Drive, North Ryde, N.S.W. 2113, Australia

CANON NEW ZEALAND LTD.

Fred Thomas Drive, P.O. Box 33-336, Takapuna, Auckland, New Zealand

JAPAN ——— CANON SALES CO., INC.

12-15 Mita, 3-Chome, Minato-ku, Tokyo 108-8011, Japan

Free Manuals Download Website

<http://myh66.com>

<http://usermanuals.us>

<http://www.somanuals.com>

<http://www.4manuals.cc>

<http://www.manual-lib.com>

<http://www.404manual.com>

<http://www.luxmanual.com>

<http://aubethermostatmanual.com>

Golf course search by state

<http://golfingnear.com>

Email search by domain

<http://emailbydomain.com>

Auto manuals search

<http://auto.somanuals.com>

TV manuals search

<http://tv.somanuals.com>